

BSC

Design Calculation or Analysis Cover Sheet

1. QA: QA

2. Page 1

Complete only applicable items.

3. System Monitored Geologic Repository				4. Document Identifier 060-PSA-CR00-00200-000-00A			
5. Title Canister Receipt and Closure Facility Reliability and Event Sequence Categorization Analysis							
6. Group Preclosure Safety Analyses							
7. Document Status Designation <input type="checkbox"/> Preliminary <input checked="" type="checkbox"/> Committed <input type="checkbox"/> Confirmed <input type="checkbox"/> Cancelled/Superseded							
8. Notes/Comments See Page 2 for list of authors.							
Attachments							Total Number of Pages
Attachment A. Event Trees							185
Attachment B. System/Pivotal Event Analysis – Fault Trees							423
Attachment C. Active Component Reliability Data Analysis							51
Attachment D. Passive Equipment Failure Analysis							93
Attachment E. Human Reliability Analysis							231
Attachment F. Fire Analysis							177
Attachment G. Event Sequence Quantification Summary Tables							2
Attachment H. SAPHIRE Model and Supporting Files							2 + CD
RECORD OF REVISIONS							
9. No.	10. Reason For Revision	11. Total # of Pgs.	12. Last Pg. #	13. Originator (Print/Sign/Date)	14. Checker (Print/Sign/Date)	15. EGS (Print/Sign/Date)	16. Approved/Accepted (Print/Sign/Date)
00A	Initial issue	1463	H-2	Jeffrey Marr See Page 2	See Page 3	Michael Frank <i>[Signature]</i> 3/11/08	Mark Wisenbarg <i>[Signature]</i> 3/11/2008

DISCLAIMER





The analysis contained in this document was developed by Bechtel SAIC Company, LLC (BSC) and is intended solely for the use of BSC in its work for the Yucca Mountain Project.



Section	Section Name	Originator	Signature/Date
1	Purpose	Jeffrey Marr	<i>J. Marr</i> 3/10/08
2	References	Jeffrey Marr	<i>J. Marr</i> 3/10/08
3	Assumptions	Jeffrey Marr	<i>J. Marr</i> 3/10/08
4	Methodology	Jeffrey Marr	<i>J. Marr</i> 3/10/08
4.1	Quality Assurance	Jeffrey Marr	<i>J. Marr</i> 3/10/08
4.2	Use of Software	Jeffrey Marr	<i>J. Marr</i> 3/10/08
4.3	Description of Analysis Methods	Doug Orvis Erin Collins Pierre Macheret Dan Christman David Bradley Paul Amico Mary Presley Joe Minarick	<i>D. Orvis</i> 3/10/08 <i>E. Collins</i> 3/10/08 <i>P. Macheret</i> 03/10/08 <i>D. Christman</i> 3/10/08 <i>D. Bradley</i> 3/10/08 <i>P. Amico</i> 3/10/08 <i>M. Presley</i> 3/10/08 <i>J. Minarick</i> 3/10/08
5	List of Attachments	Doug Orvis	<i>D. Orvis</i> 3/10/08
6	Body of Calculation	NA	
6.0	Initiating Event Screening	Doug Orvis Jeffrey Marr	<i>D. Orvis</i> 3/10/08 <i>J. Marr</i> 3/10/08
6.1	Event Tree Analysis	Jeff Marr	<i>J. Marr</i> 3/10/08
6.2	Initiating and Pivotal Event Analysis	Jeff Marr	<i>J. Marr</i> 3/10/08
6.3	Data Utilization	Jeff Marr Dan Christman (6.3.2.1, 6.3.3.3) David Bradley (6.3.2.2)	<i>J. Marr</i> 3/10/08 <i>D. Christman</i> 3/10/08 <i>D. Bradley</i> 3/10/08
6.4	Human Reliability Analysis	Paul Amico Mary Presley Erin Collins Doug Orvis	<i>P. Amico</i> 3/10/08 <i>M. Presley</i> 3/10/08 <i>E. Collins</i> 3/10/08 <i>D. Orvis</i> 3/10/08
6.5	Fire Analysis	Paul Amico Jeff Marr	<i>P. Amico</i> 3/10/08 <i>J. Marr</i> 3/10/08
6.6	(Not used)		
6.7	Event Sequence Quantification	Jeff Marr	<i>J. Marr</i> 3/10/08
6.8	Event Sequence Grouping And Categorization	Doug Orvis Jeff Marr	<i>D. Orvis</i> 3/10/08 <i>J. Marr</i> 3/10/08
6.9	Defined Its Sscs and Procedural Safety Controls Requirements	Doug Orvis Jeff Marr	<i>D. Orvis</i> 3/10/08 <i>J. Marr</i> 3/10/08
7	Results and Conclusions	Doug Orvis	<i>D. Orvis</i> 3/10/08
Att A	Event Trees	Jeff Marr	<i>J. Marr</i> 3/10/08
Att B	System/Pivotal Event Analysis – Fault Trees	Daryl Kepler Bill Schwinkendorf Dan Gallagher	<i>D. Kepler</i> 3/10/08 <i>B. Schwinkendorf</i> 3/10/08 <i>D. Gallagher</i> 3/10/08

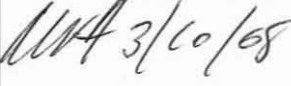
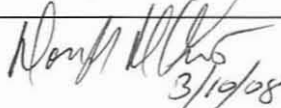



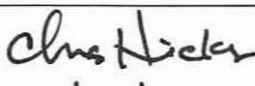

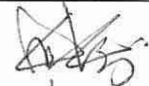
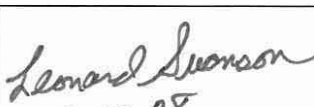
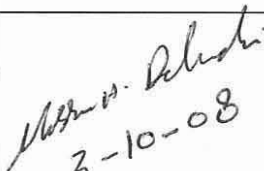
Section	Section Name	Originator	Signature/Date
Att C	Active Component Reliability Data Analysis	Erin Collins	<i>[Signature]</i> 3/6/08
Att D	Passive Equipment Failure Analysis	Dan Christman (D1 & D3) David Bradley (D2)	<i>[Signature]</i> 3/10/08 <i>[Signature]</i> 3/10/08
Att E	Human Reliability Analysis	Paul Amico Mary Presley Erin Collins Doug Orvis	<i>[Signature]</i> 3/10/08 <i>[Signature]</i> 3/10/08 <i>[Signature]</i> 3/10/08 <i>[Signature]</i> 3/10/08
Att F	Fire Analysis	Paul Amico Laura Plumb (under supervision of Paul Amico)	<i>[Signature]</i> 3/10/08 <i>[Signature]</i> 3/10/08
Att G	Event Sequence Grouping and Categorization	Jeff Marr	<i>[Signature]</i> 3/10/08
Att H	Sapphire Event Sequence Analysis (CD)	Jeff Marr	<i>[Signature]</i> 3/10/08

Kathy Ashley coordinated the issuance of the Check Copy (00Aa) and filled out the Originator's Checklist.

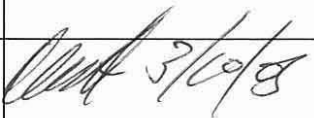
Checker	Signature/Date	Section	Type of Check	Detailed Scope of Check
Andrew Burningham	<i>[Signature]</i> 3/10/08	Section 1-7, Attachments	Administrative	Perform checks on the Calculations and Analyses – Checklist (Attachment 6 to EG-PRO-3DP-G04B-00037 that are administrative in nature (e.g. format, procedural compliance, links in InfoWorks, DIRS, reference format, document numbering, confirmation of SAPHIRE validation, tracking number, etc)
Amy Primmer	<i>[Signature]</i> 3/10/08	Attachments A, B, C, D, E, F, G, H		
Alex Deng	<i>[Signature]</i> 03/10/08	Sections 1, 3, 4, and 7 and 6 <i>[Signature]</i>	Overall Approach and Methodology	Check that the standard approach and methodology includes changes to the methodology resulting from input from Industry reviewers.
Phuoc Le Dan Gallagher	<i>[Signature]</i> 03/10/08 <i>[Signature]</i> 03/10/08	Section 6.0 through 6.8 and Attachments A through H	Cut Set Check	Cut Set Check - Section 6.0 - 6.8 and Attachments A - H
Kathy Ashley	<i>[Signature]</i> 3/10/08	Section 6.9	Specialty Check	Check the correct ESD and values for Table 6.9-1.

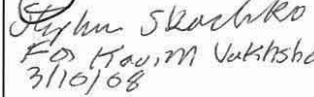
Checker	Signature/Date	Section	Type of Check	Detailed Scope of Check
Dan Christman	 3/10/08	Section 6.5 and Attachment F	Specialty Check: Fire Initiating Events	Fire Initiating Events - Section 6.5 and Attachment F
Doug Orvis	 3/19/08	Section 6.0	Specialty Check: Section 6.0	Initiating Event Screening - Section 6.0
Laura Plumb	 3/19/08	Section 6.3.3 Miscellaneous Data	Specialty Check: Section 6.3.3 and Supporting Reference and Cross-references to other sections	Section 6.3.3 Miscellaneous Data
Mary Jane Rubano for Ekachai Danupatampa	 3/10/08	Attachment B-3 System Pivotal Events Analyses - Fault Tree Analysis - Loading/Unloading Room Shield Door/Slide Gate	Design Concurrence	Check fault tree description. Is design accurately described and do all basic events have basis in latest issued for LA information? Are success criteria accurate? Are basic events clearly phrased? Are the references to Engineering documents correct and up to date.
Steffhan Sherman	 3/10/08	Attachment B-2 System Pivotal Events Analyses - Fault Tree Analysis - Cask Transfer Trolley	Design Concurrence	Check fault tree description. Is design accurately described and do all basic events have basis in latest issued for LA information? Are success criteria accurate? Are basic events clearly phrased? Are the references to Engineering documents correct and up to date
Chris Hicks for Freddie Guerrero	 3/10/08	Attachment B-4 System Pivotal Events Analyses - Fault Tree Analysis - CTM System	Design Concurrence	Check fault tree description. Is design accurately described and do all basic events have basis in latest issued for LA information? Are success criteria accurate? Are basic events clearly phrased? Are the references to Engineering documents correct and up to date

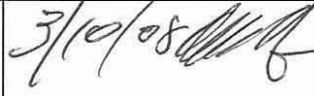
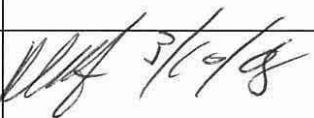
Checker	Signature/Date	Section	Type of Check	Detailed Scope of Check
Ching Chan for Narci Encarnacion	 Narci Encarnacion 3/10/2008.	Attachment B-5 System Pivotal Events Analyses - Fault Tree Analysis - Waste Package Transfer Trolley	Design Concurrence	Check fault tree description. Is design accurately described and do all basic events have basis in latest issued for LA information? Are success criteria accurate? Are basic events clearly phrased? Are the references to Engineering documents correct and up to date
Leonard Swanson	 Leonard Swanson 3-10-08	Attachment B-6 System Pivotal Event Fault Tree Analysis - Site Transporter	Design Concurrence	Check fault tree description. Is design accurately described and do all basic events have basis in latest issued for LA information? Are success criteria accurate? Are basic events clearly phrased? Are the references to Engineering documents correct and up to date
Nasser Dehkordi for Ajit Hiranadani	 Nasser Dehkordi 3-10-08	Attachment B-7 Heating, Ventilation, and Air Conditioning	Design Concurrence	Check fault tree description. Is design accurately described and do all basic events have basis in latest issued for LA information? Are success criteria accurate? Are basic events clearly phrased? Are the references to Engineering documents correct and up to date
Nohemi Brewer	 Nohemi Brewer 3-11-08	Attachment B-8- AC Power	Design Concurrence	Check fault tree description. Is design accurately described and do all basic events have basis in latest issued for LA information? Are success criteria accurate? Are basic events clearly phrased? Are the references to Engineering documents correct and up to date
Ching Chan	 Ching Chan 3/10/2008	Attachment B-1 System Pivotal Events Analyses - Fault Tree Analysis - Prime Mover	Design Concurrence	Check fault tree description. Is design accurately described and do all basic events have basis in latest issued for LA information? Are success criteria accurate? Are basic events clearly phrased? Are the

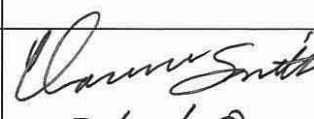
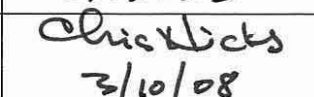
Checker	Signature/Date	Section	Type of Check	Detailed Scope of Check
				references to Engineering documents correct and up to date
Dan Christman	 3/10/08	Attachment C	Specialty Check	Check Attachment C including the MathCad file for Bayesian update of reliability values and Section 6.3
Doug Smith Stephen Skochko for Karim Vakhshoori	 3-10-08  For Karim Vakhshoori 3/10/08	Attachment C - Inputs	Detailed References and numerical Inputs	This check traced data back to references for Attachment C.
Stephen Skochko	 3/10/08			
Dan Christman	 3/10/08	Attachment D -	Specialty Check	Check section D 2 on PFAs for thermal challenge to shielding and associated text in 6.3.2.2
David Bradley	 3/10/08	Attachment D	Specialty Check	Check sections D 1 and D 3 on PFA's related to loss of shielding and associated text in Section 6.3.3.3, and the structural PFAs and associated text in section 6.3.2.1
Phuoc Le	 03/10/08	Attachment E - Human Reliability Analysis	Specialty Check	Section 6.4 and Attachment E
Clarence Smith	 3/10/08	Attachment E - Human Reliability Analysis	Design Concurrence	Check that the Basic Scenarios in Attachment E are consistent with the concept of operations.
Chris Hicks for Freddie Guerrero	 3/10/08	Attachment F Fire Analysis	Design Concurrence	Check dimensions of rooms and area computation

Checker	Signature/Date	Section	Type of Check	Detailed Scope of Check
Mary Jane Rubano for Nasser Dehkordi	<i>Mary Jane Rubano</i> 3/10/08	Attachment F - Fire Analysis	Detailed References and numerical Inputs	Check tabulation of equipment contained in each room
Sandra Castro	<i>Sandra Castro</i> 3/10/08	Section 2 of Main Body	Detailed References and numerical Inputs	Check that all references to engineering document are correct and up to date.
Mary Jane Rubano	<i>Mary Jane Rubano</i> 3/10/08	Main Body and Attachments E and F.	Detailed References and numerical Inputs	Reference Check: Check that all references in the body of the analysis are references to the appropriate document.
Leo Gatchalian Nasser Dehkordi	<i>Leo Gatchalian</i> 3/10/08	All sections and Attachments	Detailed References and numerical Inputs	Check that data in body of analysis has been accurately copied from the sources in attachments
Phouc Le	<i>Phouc Le</i> 05/10/08	Attachment H - Sapphire Model and Supporting Files (CD)	Detailed References and numerical Inputs	Check CD has correct files on disc in required format.
Dale Dexheimer	<i>Dale Dexheimer</i> 3/10/08	Section 6.8	Specialty Check	Check consistency with Preclosure Consequence Analysis

CONTENTS

	Page
ACRONYMS AND ABBREVIATIONS	12
1. PURPOSE	15
2. REFERENCES	19
2.1 PROCEDURES/DIRECTIVES	19
2.2 DESIGN INPUTS	19
2.3 DESIGN CONSTRAINTS	27
2.4 DESIGN OUTPUTS	27
2.5 ATTACHMENT REFERENCES	28
3. ASSUMPTIONS	29
3.1 ASSUMPTIONS REQUIRING VERIFICATION	29
3.2 ASSUMPTIONS NOT REQUIRING VERIFICATION	29
4. METHODOLOGY	30
4.1 QUALITY ASSURANCE	30
4.2 USE OF SOFTWARE	31
4.3 DESCRIPTION OF ANALYSIS METHODS	33
5. LIST OF ATTACHMENTS	91
6. BODY OF ANALYSIS	92
6.0 INITIATING EVENT SCREENING	92
6.1 EVENT TREE ANALYSIS	106
6.2 ANALYSIS OF INITIATING AND PIVOTAL EVENTS	114
6.3 DATA UTILIZATION	141
6.4 HUMAN RELIABILITY ANALYSIS	212
6.5 FIRE INITIATING EVENTS	223
6.6 NOT USED	245
6.7 EVENT SEQUENCE FREQUENCY RESULTS	245
6.8 EVENT SEQUENCE GROUPING AND CATEGORIZATION	247
6.9 IMPORTANT TO SAFETY STRUCTURES, SYSTEMS, AND COMPONENTS AND PROCEDURAL SAFETY CONTROL REQUIREMENTS	269
7. RESULTS AND CONCLUSIONS	295
ATTACHMENT A EVENT TREE ANALYSIS	A-1
ATTACHMENT B SYSTEM/PIVOTAL EVENT ANALYSIS–FAULT TREES	B-1
ATTACHMENT C ACTIVE COMPONENT RELIABILITY DATA ANALYSIS	C-1
ATTACHMENT D PASSIVE EQUIPMENT FAILURE ANALYSIS	D-1
ATTACHMENT E HUMAN RELIABILITY ANALYSIS	E-1
ATTACHMENT F FIRE ANALYSIS	F-1
ATTACHMENT G EVENT SEQUENCE QUANTIFICATION SUMMARY TABLE	G-1
ATTACHMENT H SAPHIRE MODEL AND SUPPOPRTING FILES	H-1

FIGURES

	Page
4.3-1. Event Sequence Analysis Process.....	33
4.3-2. PCSA Process	38
4.3-3. Portion of a Simplified Process Flow Diagram for a Typical Waste-Handling Facility	39
4.3-4. ESD, Event Tree Relationship	40
4.3-5. Example Fault Tree.....	44
4.3-6. Concept of Uncertainty in Load and Resistance.....	47
4.3-7. Point Estimate Load Approximation Used in PCSA	49
4.3-8. Component Failure Rate “Bathtub Curve” Model.....	55
4.3-9. Incorporation of Human Reliability Analysis within the PCSA.....	65
4.3-10. Transfer from Event Tree to Fault Tree	76
6.3-1. Likelihood Functions from Data Sources (Dashed Lines) and Population-Variability Probability Density Function (Solid Line)	145
6.4-1. CRCF Operations.....	213

TABLES

	Page
4.3-1. Criticality Control Parameter Summary	86
6.0-1. Retention Decisions from External Events Screening Analysis	96
6.0-2. Bases for Screening Internal Initiating Events.....	100
6.1-1. Waste Form Throughputs for the CRCF Over the Preclosure Period	109
6.1-2. Figure Locations for Initiating Event Trees and Response Trees.....	110
6.2-1. Summary of Top Event Quantification for the SPM	118
6.2-2. Summary of Top Event Quantification for the CTT.....	121
6.2-3. Summary of Top Event Quantification for the Shield Doors and Slide Gate.....	123
6.2-4. Summary of Top Event Quantification for the CTM.....	127
6.2-5. Summary of Top Event Quantification for the WPTT	130
6.2-6. Summary of Top Event Quantification for the Site Transporter	133
6.2-7. Probability of Spurious Sprinkler Actuation.....	138
6.3-1. Active Component Reliability Data Summary	148
6.3-2. Failure Probabilities Due to Drops and Other Impacts.....	166
6.3-3. Failure Probabilities Due to Miscellaneous Events	167
6.3-4. Failure Probabilities for Collision Events and Two-Blocking.....	169
6.3-5. Summary of Canister Failure Probabilities in Fire	171
6.3-6. Probabilities of Degradation or Loss of Shielding.....	175
6.3-7. Summary of Passive Event Failure Probabilities.....	176
6.3-8. Passive Failure Basic Events used in CRCF Event Sequence Analysis	177
6.3-9. Fire Analysis for Wastes Types in Specific Configuration	186
6.3-10. Split Fractions for Waste Types in Various Configurations.....	189
6.3-11. Miscellaneous Data Used In the Reliability Analysis.....	192
6.5-1. Room Areas and Total Ignition Frequency.....	223
6.5-2. Ignition Source Category and Room-by-Room Population.....	225
6.5-3. Residence Fractions	227
6.5-4. Results from Monte Carlo Simulation of Initiating Event Frequency Distributions.....	229
6.5-5. Basic Events Data Associated with Fire Analysis	234
6.8-1. Bounding Category 2 Event Sequences.....	248

TABLES (Continued)

	Page
6.8-2. Category 1 Final Event Sequences Summary	254
6.8-3. Category 2 Final Event Sequences Summary	255
6.9-1 Preclosure Nuclear Safety Design Bases for the CRCF ITS SSCs.....	270
6.9-2. Summary of Procedural Safety Controls for the CRCF.....	292
7-1. Key to Results	295
7-2. Summary of Category 2 Event Sequences.....	297

ACRONYMS AND ABBREVIATIONS

Acronyms

ASME	American Society of Mechanical Engineers
ATHEANA	a technique for human event analysis
BSC	Bechtel SAIC Company, LLC
CCF	common-cause failure
CREAM	Cognitive Reliability and Error Analysis Method
CRCF	Canister Receipt and Closure Facility
CTM	canister transfer machine
CTT	cask transfer trolley
DHLW	defense high-level radioactive waste
DOE	U.S. Department of Energy
DPC	dual-purpose canister
EDGB	Emergency Diesel Generator Building
EFC	error forcing context
EOC	errors of commission
EOO	errors of omission
EPRI	Electric Power Research Institute
ESD	event sequence diagram
ETF	expended toughness fraction
FEA	finite element analysis
FEM	finite element modeling
FFTF	Fast Flux Test Facility
FTA	fault tree analysis
GROA	geologic repository operations area
HAZOP	hazard and operability study/analysis
HCLPF	high confidence of low mean frequency of failure
HEART	Human Error Assessment and Reduction Technique
HEP	human error probability
HEPA	high-efficiency particulate air filter
HFE	human failure event
HLW	high-level radioactive waste
HRA	human reliability analysis
HVAC	heating, ventilation, and air conditioning
IET	initiator event tree
IHF	Initial Handling Facility
ISFSI	independent spent fuel storage installation

ACRONYMS AND ABBREVIATIONS (CONTINUED)

ITC	important to criticality
ITS	important to safety
LLNL	Lawrence Livermore National Laboratory
LOSP	loss of offsite power
LOS	loss of shielding
LS-DYNA	Livermore Software–Dynamic Finite Element Program
MAP	mobile access platform
MCC	motor control centers
MCO	multicanister overpack
MLD	master logic diagram
MPC	multipurpose canister
N/A	not applicable
NARA	Nuclear Action Reliability Assessment
NFPA	National Fire Protection Association
NNP	normal network protection
NPP	nuclear power plant
NRC	U.S. Nuclear Regulatory Commission
NUREG	Nuclear Regulation (U.S. Nuclear Regulatory Commission)
PCSA	preclosure safety analysis
PDF	probability density function
PEFA	passive equipment failure analysis
PFD	process flow diagram
PIF	performance influencing factor
PLC	programmable logic controller
PRA	probabilistic risk assessment
PSC	procedural safety controls
PSF	performance shaping factor
QA	quality assurance
RF	Receipt Facility
SFTM	spent fuel transfer machine
SLS	steel/lead/steel
SNF	spent nuclear fuel
SPM	site prime mover
SPMRC	site prime mover railcars
SPMTT	site prime mover truck trailers
SRET	system response event tree
SSC	structure, system, or component
SSCs	structures, systems, and components

ACRONYMS AND ABBREVIATIONS (CONTINUED)

TAD	transportation, aging, and disposal
TEV	transport and emplacement vehicle
THERP	Technique for Human Error Rate Prediction
TRIGA	Training, Research, Isotopes, General Atomics
TYP-FM	type and failure mode
WHF	Wet Handling Facility
WPTT	waste package transfer trolley
YMP	Yucca Mountain Project

Abbreviations

AC	alternating current
°C	degrees Celsius
DC	direct current
ft	foot, feet
gpm	gallons per minute
hp	horsepower
hr, hrs	hour, hours
K	Kelvin
kV	kilovolt
min	minute, minutes
mph	miles per hour
V	volt
yr, yrs	year, years

1. PURPOSE

This document on the Canister Receipt and Closure Facility (CRCF) along with its companion document entitled *Canister Receipt and Closure Facility Event Sequence Development Analysis* (Ref. 2.2.33) constitutes a portion of the preclosure safety analysis (PCSA) that is described in its entirety in the safety analysis report that is being submitted to the U.S. Nuclear Regulatory Commission (NRC) as part of the Yucca Mountain Project (YMP) license application. These documents are part of a collection of analysis reports that encompass all waste handling activities and facilities of the geologic repository operations area (GROA) from the beginning of operations to the end of the preclosure period. The *Canister Receipt and Closure Facility Event Sequence Development Analysis* (Ref. 2.2.33) describes the identification of initiating events and the development of potential event sequences that emanate from them. This analysis uses the resulting event sequences developed in this analysis to perform a quantitative analysis of the event sequences for the purpose of categorization per the definition provided by 10 CFR 63.2 (Ref. 2.3.2).

The PCSA uses probabilistic risk assessment (PRA) technology derived from both nuclear power plant and aerospace methods and applications in order to perform analyses to comply with the risk informed aspects of 10 CFR 63.111 and 63.112 and to be responsive to the acceptance criteria articulated in the *Yucca Mountain Review Plan, Final Report* (Ref. 2.2.73). The PCSA, however, limits the use of PRA technology to identification and development of event sequences that might lead to direct exposure of workers or onsite members of the public; radiological releases that may affect the workers or public (onsite and offsite), and criticality.

The radiological consequence assessment relies on bounding inputs with deterministic methods to obtain bounding dose estimates. These were developed using broad categories of scenarios that might cause a radiological release or direct exposure to workers and the public, both onsite and offsite. These broad categories of scenarios were characterized by conservative meteorology and dispersion parameters, conservative estimates of material at risk, conservative source terms, conservative leak-path factors, and filtration of releases via facility high-efficiency particulate air (HEPA) filters when applicable. After completion of the event sequence development and categorization in this analysis, each Category 1 and Category 2 event sequence was conservatively matched with one of the categories of dose estimates. The event sequence analyses also serve as input to the PCSA criticality analyses by identifying the event sequences and end states where conditions leading to criticality are in Category 1 or 2.

An event sequence is defined in 10 CFR 63.2 (Ref. 2.3.2) as:

“A series of actions and/or occurrences within the natural and engineered components of a geologic repository operations area that could potentially lead to exposure of individuals to radiation. An event sequence includes one or more initiating events and associated combinations of repository system component failures, including those produced by the action or inaction of operating personnel. Those event sequences that are expected to occur one or more times before permanent closure of the geologic repository operations area are referred to as Category 1 event sequences. Other event sequences that have at least one

chance in 10,000 of occurring before permanent closure are referred to as Category 2 event sequences.”

As an extrapolation of the definition of Category 2 event sequences, sequences that have less than one chance in 10,000 of occurring before permanent closure are identified as beyond Category 2. Consequence analyses are not required for those event sequences.

10 CFR 63.112, Paragraph (e) and Subparagraph (e)(6) (Ref. 2.3.2) require analyses to identify the controls that are relied upon to limit or prevent potential event sequences or mitigate their consequences. Subparagraph (e)(6) specifically notes that the analyses include consideration of “means to prevent and control criticality.” The PCSA criticality analyses employ specialized deterministic methods that are beyond the scope of the present analysis. However, the event sequence analyses serve as an input to the PCSA criticality analyses by identifying the event sequences and end states where conditions leading to criticality are in Category 1 or 2. Some event sequence end states include the phrase “important to criticality.” This indicates that the event sequence has a potential for reactivity increase that is analyzed to determine if reactivity can exceed the upper subcriticality limit.

In order to determine the criticality potential for each waste form and associated facility and handling operations, criticality sensitivity calculations are performed. These calculations evaluate the impact on system reactivity to variations in each of the parameters important to criticality during the preclosure period. The parameters are waste form characteristics, reflection, interaction, neutron absorbers (fixed and soluble), geometry, and moderation. The criticality sensitivity calculations determine the sensitivity of the effective neutron multiplication factor (k_{eff}) to variations in any of these parameters as a function of the other parameters. The PCSA criticality analyses determined the parameters that this event sequence analysis includes. The presence of a moderator in association with a path to exposed fuel was required to be explicitly modeled in the event sequence analysis because such events could not be deterministically found to be incapable of exceeding the upper subcriticality limit. Other situations treated in the event sequence analysis for similar reasons are multiple U.S. Department of Energy (DOE) spent nuclear fuel (SNF) canisters in the CRCF in the same general location and presence of sufficient soluble boron in the pool in the Wet Handling Facility (WHF).

The initiating events considered in the PCSA define what could occur within the GROA and are limited to those events that constitute a hazard to a waste form while it is present in the GROA. Initiating events include internal events occurring during waste handling operations conducted within the GROA and external events (e.g., seismic, wind energy, or flood water events) that impose a potential hazard to a waste form, waste handling systems, or personnel within the GROA. Such initiating events are included when developing event sequences for the PCSA. However, initiating events that are associated with conditions introduced in structures, systems, and components (SSCs) before they reach the site are not within the scope of the PCSA. The excluded from consideration offsite conditions include drops of casks, canisters, or fuel assemblies during loading at a reactor site; improper drying, closing, or inerting at the reactor site; rail or road accidents during transport; tornado or missile strikes on a transportation cask; or nonconformances introduced during cask or canister manufacture that result in a reduction of containment strength. Such potential precursors are subject to deterministic regulations such as 10 CFR Part 50 (Ref. 2.3.1), 10 CFR Part 71 (Ref. 2.3.3), and 10 CFR 72 (Ref. 2.3.4) and

associated quality assurance (QA) programs. As a result of compliance to such regulations, the SSCs are deemed to pose no undue risk to health and safety. Although the analyses do not address quantitative probabilities to the aforementioned excluded precursors, it is clear that the use of conservative design criteria and the implementation of QA controls result in unlikely exposures to radiation.

Other boundary conditions used in the PCSA include:

- Plant operational state. The initial state of the facility is normal with each system operating within its vendor-prescribed operating conditions.
- No other simultaneous initiating events. It is standard practice to not consider the occurrence of other initiating events (human-induced or naturally occurring) during the time span of an event sequence because: (a) the probability of two simultaneous initiating events within the time window is small and, (b) each initiating event will cause operations in the waste handling facility to be terminated, which further reduces the conditional probability of the occurrence of a second initiating event, given that the first has occurred.
- Component failure mode. The failure mode of a structure, system, or component (SSC) corresponds to that required to make the initiating or pivotal event occur.
- Fundamental to the basis for the use of industry-wide reliability parameters within the PCSA, such as failure rates, is the use of SSCs within the GROA that conform to NRC accepted consensus codes and standards, and other regulatory guidance.
- Intentional malevolent acts, such as sabotage and other security threats, are not addressed in this analysis.

As stated, the scope of the preclosure safety analysis is limited to internal initiating events originating within the GROA boundary and external initiating events that have their origin outside the GROA boundary, but can affect buildings and/or equipment within the GROA. External event analyses are documented in *External Events Hazards Screening Analysis* (Ref. 2.2.34) and *Frequency Analysis of Aircraft Hazards for License Application* (Ref. 2.2.22). Internal event identification (using a master logic diagram (MLD) and hazard and operability (HAZOP) evaluation), event sequence development and grouping, and related facility details are provided in the *Canister Receipt and Closure Facility Event Sequence Development Analysis* (Ref. 2.2.33), which also documents the methodology and process employed and initiates the analysis that is completed here.

This document uses event trees from the *Canister Receipt and Closure Facility Event Sequence Development Analysis* (Ref. 2.2.33) to quantify the event sequences for each waste form. Quantification refers to the process of obtaining the mean frequency of each event sequence for the purpose of categorization. This document shows the categorization of each event sequence based on:

- Mean frequency associated with the event sequence frequency distribution

- Uncertainty associated with the event sequence frequency distribution
- Material at risk for each Category 1 and 2 event sequence for purposes of dose calculations
- Important to safety (ITS) SSCs
- Compliance with the nuclear safety design bases
- Procedural safety controls required for operations

Other PCSA documents which are not referenced here cover the reliability and categorization of external events and summarize procedural safety controls and nuclear safety design bases. The main documents that will emanate from Volume I (Ref. 2.2.33) and the current analyses are:

- *ITS SSC/Non-ITS SSC Interactions Analysis* (Ref. 2.4.1)
- *Preclosure Nuclear Safety Design Bases* (Ref. 2.4.2)
- *Preclosure Procedural Safety Controls* (Ref. 2.4.3)
- *Seismic Event Sequence Quantification and Categorization* (Ref. 2.4.4).

2. REFERENCES

2.1 PROCEDURES/DIRECTIVES

- 2.1.1 EG-PRO-3DP-G04B-00037, Rev. 10. *Calculations and Analyses*. Las Vegas, Nevada: Bechtel SAIC Company. ACC: ENG.20071018.0001.
- 2.1.2 EG-PRO-3DP-G04B-00046, Rev. 10. *Engineering Drawings*. Las Vegas, Nevada. Bechtel SAIC Company. ACC: ENG.2080115.0014.
- 2.1.3 IT-PRO-0011, Rev. 7. *Software Management*. Las Vegas, Nevada: Bechtel SAIC Company. ACC: DOC.20070905.0007.
- 2.1.4 LS-PRO-0201, Rev. 5. *Preclosure Safety Analysis Process*. Las Vegas, Nevada: Bechtel SAIC Company. ACC: ENG.20071010.0021.

2.2 DESIGN INPUTS

The PCSA is based on a snapshot of the design. The reference design documents are appropriately documented as design inputs in this section. Since the safety analysis is based on a snapshot of the design, referencing subsequent revisions to the design documents (as described in EG-PRO-3DP-G04B-00037, *Calculations and Analyses* (Ref. 2.1.1, Section 3.2.2.F)) that implement PCSA requirements flowing from the safety analysis would not be appropriate for the purpose of the PCSA.

Design Inputs for the main report are listed in this section and the Design Inputs for Attachments B through F are listed in Section 2.5.

The inputs in this Section noted with an asterisk (*) indicate that they fall into one of the designated categories described in Section 4.1, relative to suitability for intended use.

- 2.2.1 *Ahrens, M. 2000. *Fires in or at Industrial Chemical, Hazardous Chemical, and Plastic Manufacturing Facilities, 1988 – 1997 Unallocated Annual Averages and Narratives*. Quincy, Massachusetts: National Fire Protection Association. TIC: 259997
- 2.2.2 *Ahrens, M. 2007. *Structure Fires in Radioactive Material Working Facilities and Nuclear Energy Plants of Non-Combustible Construction*. Quincy, Massachusetts: National Fire Protection Association. TIC: 259983.
- 2.2.3 Not Used
- 2.2.4 ANSI/AISC (American National Standards Institute/American Institute of Steel Construction) N690-1994. 1994. American National Standard Specification for the Design, Fabrication, and Erection of Steel Safety-Related Structures for Nuclear Facilities. Chicago, Illinois: American Institute of Steel Construction. TIC: 252734.

- 2.2.5 ANSI/ANS (American National Standards Institute/American Nuclear Society)-58.23-2007. 2007. *Fire PRA Methodology*. La Grange Park, Illinois. American Nuclear Society. TIC:259894.
- 2.2.6. *Apostolakis, G. and Kaplan, S. 1981. "Pitfalls in Risk Calculations." *Reliability Engineering*, 2, 135-145. Barking, England: Applied Science Publishers. TIC: 253648.
- 2.2.7 ASCE/SEI (American Society of Civil Engineers/Structural Engineering Institute) 7-05. 2006. *Minimum Design Loads for Buildings and Other Structures*. Including Supplement No. 1. Reston, Virginia: American Society of Civil Engineers. TIC: 258057. ISBN: 0-7844-0809-2.
- 2.2.8 ASME (American Society of Mechanical Engineers) RA-S-2002. *Standard for Probabilistic Risk Assessment for Nuclear Power Plant Applications*. New York, New York: American Society of Mechanical Engineers. TIC: 255508. ISBN: 0-7918-2745-3.
- 2.2.9 ASME 2004. *2004 ASME Boiler and Pressure Vessel Code*. 2004 Edition. New York, New York: American Society of Mechanical Engineers. TIC: 256479. ISBN: 0-7918-2899-9.
- 2.2.10 ASME NOG-1-2004. 2005. *Rules for Construction of Overhead and Gantry Cranes (Top Running Bridge, Multiple Girder)*. New York, New York: American Society of Mechanical Engineers. TIC: 257672. ISBN: 0-7918-2939-1.
- 2.2.11 Not Used
- 2.2.12 *Atwood, C.L.; LaChance, J.L.; Martz, H.F.; Anderson, D.J.; Englehardt, M.; Whitehead, D.; and Wheeler, T. 2003. *Handbook of Parameter Estimation for Probabilistic Risk Assessment*. NUREG/CR-6823. Washington, D.C.: U.S. Nuclear Regulatory Commission. ACC: MOL.20060126.0121.
- 2.2.13 *Benhardt, H.C.; Eide, S.A.; Held, J.E.; Olsen, L.M.; and Vail, R.E. 1994. *Savannah River Site Human Error Data Base Development for Nonreactor Nuclear Facilities (U)*. WSRC-TR-93-581. Aiken, South Carolina: Westinghouse Savannah River Company, Savannah River Site. ACC: MOL.20061201.0160.
- 2.2.14 *Brereton, S.J.; Alesso, H.P.; Altenbach, T.J.; Bennett, C.T.; and Ma, C. 1998. *AVLIS Criticality Risk Assessment*. UCRL-JC-130693. Livermore, California: Lawrence Livermore National Laboratory. ACC: MOL.20080102.0002.
- 2.2.15 *BSC (Bechtel SAIC Company) 2004. *BSC Engineering Study, Waste Package Closure Welding Process Characteristics*. 000-30R-HW00-00300-000-000. Las Vegas, Nevada: Bechtel SAIC Company. ACC: ENG.20041119.0001.
- 2.2.16 BSC 2005. *Thermal Performance of Spent Nuclear Fuel During Dry Air Transfer-Initial Calculations*. 000-00C-DSU0-03900-000-00B. Las Vegas, Nevada: Bechtel SAIC Company. ACC: ENG.20050110.0003.

- 2.2.17 BSC 2008. *Basis of Design for the TAD Canister-Based Repository Design Concept*. 000-3DR-MGR0-00300-000-001. Las Vegas, Nevada: Bechtel SAIC Company. ACC: ENG.20071108.0002.
- 2.2.18. BSC 2007. *Canister Receipt & Closure Facility #1 ITS Train "A" Electrical Room Equipment Layout*. 060-E40-EEE0-00101-000 REV 00A. Las Vegas, Nevada. BSC Inc. ACC: ENG.20070821.0003.
- 2.2.19 *BSC 2007. *Canister Receipt and Closure Facility 1 Fire Hazard Analysis*. 060-M0A-FP00-00100-000-00B. Las Vegas, Nevada: Bechtel SAIC Company. ACC: ENG.20071129.0032.
- 2.2.20 BSC 2007. *CRCF-1 and IHF WP Transfer Trolley Mechanical Equipment Envelope Plan & Elevations-Sh 1 of 2*. 000-MJ0-HL00-00101-000 REV 00B. Las Vegas, Nevada: Bechtel SAIC Company. ACC: ENG.20071027.0015.
- 2.2.21 BSC 2007. *Emplacement and Retrieval Transport and Emplacement Vehicle Mechanical Equipment Envelope*. 800-MJ0-HE00-00101-000 REV 00B. Las Vegas, Nevada: Bechtel SAIC Company. ACC: ENG.20070918.0041.
- 2.2.22 BSC 2007. *Frequency Analysis of Aircraft Hazards for License Application*. 000-00C-WHS0-00200-000-00F. Las Vegas, Nevada: Bechtel SAIC Company. ACC: ENG.20070925.0012.
- 2.2.23 *BSC 2007. *Liquid Low-Level Waste Collection Calculation (C2 and C3 Contamination Zones)* 000-M0C-MWL0-00100-000-00A. ACC. ENG.20071101.0013.
- 2.2.24 BSC 2007. *Mechanical Handling Design Report for Cask Transfer Trolley*. 000-30R-HM00-00200-000-001. Las Vegas, Nevada: Bechtel SAIC Company. ACC: ENG.20071219.0001.
- 2.2.25 BSC 2007. *GROA External Dose Calculation*. 000-PSA-MGR0-01300-000-00A. Las Vegas, Nevada: Bechtel SAIC Company. ACC: ENG.20071023.0003.
- 2.2.26 BSC 2007. *Mechanical Handling Design Report - Waste Package Transfer Trolley*. 000-30R-WHS0-01200-000 REV 000. Las Vegas, Nevada: Bechtel SAIC Company. ACC: ENG.20071006.0001.
- 2.2.27 BSC 2007. *Naval Long Waste Package Vertical Impact on Emplacement Pallet and Invert*. 000-00C-DNF0-00100-000-00C. Las Vegas, Nevada: Bechtel SAIC Company. ACC: ENG.20071017.0001.
- 2.2.28 BSC 2008. *Preclosure Criticality Analysis Process Report*. TDR-DS0-NU-000001 REV 02. Las Vegas, Nevada: Bechtel SAIC Company. ACC: DOC.20080220.0001.
- 2.2.29 BSC 2007. *Receipt Facility Fire Hazard Analysis*. 200-M0A-FP00-00100-000-00A. Las Vegas, Nevada: Bechtel SAIC Company. ACC: ENG.20070823.0001.

- 2.2.30. BSC 2007. *Straight Wind Hazard Curve Analysis*. 000-00A-MGR0-00100-000-00A. Las Vegas, Nevada: Bechtel SAIC Company. ACC: ENG.20071023.0002.
- 2.2.31 BSC 2007. *Waste Form Throughputs for Preclosure Safety Analysis*. 000-PSA-MGR0-01800-000-00A. Las Vegas, Nevada: Bechtel SAIC Company. ACC: ENG.20071106.0001.
- 2.2.32 BSC 2008. *Canister Receipt and Closure Facility 1 General Arrangement Ground Floor Plan*. 060-P10-CR00-00102-000-00C. Las Vegas, Nevada. Bechtel SAIC Company. ACC: ENG.20080122.0013.
- 2.2.33 BSC 2008. *Canister Receipt and Closure Facility Event Sequence Development Analysis*. 060-PSA-CR00-00100-000-00A. Las Vegas, Nevada: Bechtel SAIC Company. ACC: ENG.20080221.0008.
- 2.2.34 BSC 2008. *External Events Hazards Screening Analysis*. 000-00C-MGR0-00500-000-00C. Las Vegas, Nevada: Bechtel SAIC Company. ACC: ENG.20080219.0001.
- 2.2.35 *BSC 2008. *Initial Handling Facility Fire Hazard Analysis*. 51A-M0A-FP00-00100-000-00C. Las Vegas, Nevada: Bechtel SAIC Company. ACC: ENG.20080212.0007.
- 2.2.36 Not Used
- 2.2.37 BSC 2008. *Nuclear Facilities Slide Gate Process and Instrumentation Diagram*. 000-M60-H000-00201-000 REV 00E. Las Vegas, Nevada: Bechtel SAIC Company. ACC: ENG.20080123.0025.
- 2.2.38 BSC 2008. *Preclosure Consequence Analyses*. 000-00C-MGR0-00900-000-00D. Las Vegas, Nevada: Bechtel SAIC Company. ACC: ENG.20080129.0006.
- 2.2.39 BSC 2008. *Preclosure Criticality Safety Analysis*. TDR-MGR-NU-000002 REV 01. Las Vegas, Nevada: Bechtel SAIC Company. ACC: ENG.20080307.0007.
- 2.2.40 BSC 2008. *Seismic and Structural Container Analyses for the PCSA*. 000-PSA-MGR0-02100-000-00A. Las Vegas, Nevada: Bechtel SAIC Company. ACC: ENG.20080220.0003.
- 2.2.41 *BSC 2008. *Wet Handling Facility Fire Hazard Analysis*. 050-M0A-FP00-00100-000-00C. Las Vegas, Nevada: Bechtel SAIC Company. ACC: ENG.20080213.0001.
- 2.2.42 *CRA (Corporate Risk Associates) 2006. *A User Manual for the Nuclear Action Reliability Assessment (NARA) Human Error Quantification Technique*. CRA-BEGL-POW-J032. Report No. 2, Issue 5. Leatherhead, England: Corporate Risk Associates. TIC: 259873.
- 2.2.43 *Denson, W.; Chandler, G.; Crowell, W.; Clark, A; and Jaworski, P. 1994. *Nonelectronic Parts Reliability Data 1995*. NPRD-95. Rome, New York: Reliability Analysis Center. TIC: 259757.

- 2.2.44 DOE (U.S. Department of Energy) 2007. *Software Independent Verification and Validation Change in Operating System Version Report for: SAPHIRE v7.26*. Document ID: 10325-COER-7.26-01. Las Vegas, Nevada: U.S. Department of Energy, Office of Repository Development. ACC: MOL.20070607.0263. (DIRS 184933)
- 2.2.45 DOE 2007. *Transportation, Aging and Disposal Canister System Performance Specification*. WMO-TADCS-000001, Rev. 0. Washington, D.C.: U.S. Department of Energy, Office of Civilian Radioactive Waste Management. ACC: DOC.20070614.0007. (DIRS 181403)
- 2.2.46 *Eide, S.A.; Gentillon, C.D.; Wierman, T.E.; and Rasmuson, D.M. 2005. *Analysis of Loss of Offsite Power Events: 1986-2004*. Volume 1 of *Reevaluation of Station Blackout Risk at Nuclear Power Plants*. NUREG/CR-6890. Washington, D.C.: U.S. Nuclear Regulatory Commission. ACC: MOL.20071114.0164.
- 2.2.47 *Eide, S.A.; Wierman, T.E.; Gentillon, C.D.; and Rasmuson, D.M. 2007. *Industry-Average Performance for Components and Initiating Events at U.S. Commercial Nuclear Power Plants*. NUREG/CR-6928. Washington, D.C.: U.S. Nuclear Regulatory Commission. ACC: MOL.20071211.0229.
- 2.2.48 *Ellingwood, B.; Galambos, T.V.; MacGregor, J.G.; and Cornell, C.A. 1980. *Development of a Probability Based Load Criterion for American National Standard A58, Building Code Requirements for Minimum Design Loads in Buildings and Other Structures*. SP 577. Washington, D.C.: National Bureau of Standards, Department of Commerce. ACC: MOL.20061115.0081.
- 2.2.49 EPRI (Electric Power Research Institute) and NRC (U.S. Nuclear Regulatory Commission) 2005. *Detailed Methodology*. Volume 2 of *EPRI/NRC-RES Fire PRA Methodology for Nuclear Power Facilities*. EPRI TR-1011989 and NUREG/CR-6850. Palo Alto, California: Electric Power Research Institute. ACC: MOL.20070323.0062.
- 2.2.50 EPRI and NRC 2005. *Summary & Overview*. Volume 1 of *EPRI/NRC-RES Fire PRA Methodology for Nuclear Power Facilities*. EPRI-1011989 and NUREG/CR-6850. Palo Alto, California: Electric Power Research Institute. ACC: MOL.20070323.0061.
- 2.2.51 *Fischer, L.E.; Chou, C.K.; Gerhard, M.A.; Kimura, C.Y.; Martin, R.W.; Mensing, R.W.; Mount, M.E.; and Witte, M.C. 1987. *Shipping Container Response to Severe Highway and Railway Accident Conditions*. NUREG/CR-4829. Two volumes. Washington, D.C.: U.S. Nuclear Regulatory Commission. ACC: NNA.19900827.0230; NNA.19900827.0231.
- 2.2.52 *Fleming, K.N. 1975. *A Reliability Model for Common Mode Failure in Redundant Safety Systems*. GA-A13284. San Diego, California: General Atomic Company. ACC: MOL.20071219.0221.
- 2.2.53 Not Used

- 2.2.54 *Fragola, J.R. and McFadden, R.H. 1995. “External Maintenance Rate Prediction and Design Concepts for High Reliability and Availability on Space Station Freedom.: *Reliability Engineering and System Safety*, 47, 255-273. New York, New York: Elsevier. TIC: 259675.
- 2.2.55 *Gertman, D.I.; Gilbert, B.G.; Gilmore, W.E.; and Galyean, W.J. 1989. *Nuclear Computerized Library for Assessing Reactor Reliability (NUCLARR): Data Manual, Part 4: Summary Aggregations*. NUREG/CR-4639, Vol. 5, Part 4, Rev. 2. Washington, D.C.: U.S. Nuclear Regulatory Commission. TIC: 252112.
- 2.2.56 *Hollnagel, E. 1998. *Cognitive Reliability and Error Analysis Method, CREAM*. 1st Edition. New York, New York: Elsevier. TIC: 258889. ISBN: 0-08-0428487.
- 2.2.57 *Lloyd, R.L. 2003. *A Survey of Crane Operating Experience at U.S. Nuclear Power Plants from 1968 through 2002*. NUREG-1774. Washington, D.C.: U.S. Nuclear Regulatory Commission. ACC: MOL.20050802.0185.
- 2.2.58 *Lopez Droguett, E.; Groen, F.; and Mosleh, A. 2004. “The Combined Use of Data and Expert Estimates in Population Variability Analysis.” *Reliability Engineering and System Safety*, 83, 311–321. New York, New York. Elsevier. TIC: 259380.
- 2.2.59 *Marshall, F.M.; Rasmuson, D.M.; and Mosleh, A. 1998. *Common-Cause Failure Parameter Estimations*. NUREG/CR-5497. Washington, D.C.: U.S. Nuclear Regulatory Commission. ACC: MOL.20040220.0105.
- 2.2.60 *Martz, H.F. and Waller, R.A. 1991. *Bayesian Reliability Analysis*. Malabar, Florida: Krieger Publishing Company. TIC: 252996. ISBN: 0-89464-395-9.
- 2.2.61 *Mosleh, A.; Fleming, K.N.; Parry, G.W.; Paula, H.M.; Worledge, D.H.; and Rasmuson, D.M. 1988. *Analytical Background and Techniques*. Volume 2 of *Procedures for Treating Common Cause Failures in Safety and Reliability Studies*. NUREG/CR-4780. Washington, D.C.: U.S. Nuclear Regulatory Commission. TIC: 221775.
- 2.2.62 *Mosleh, A. 1993. *Procedure for Analysis of Common-Cause Failures in Probabilistic Safety Analysis*. NUREG/CR-5801. Washington, D.C.: U.S. Nuclear Regulatory Commission. TIC: 245473.
- 2.2.63 *Mosleh, A.; Rasmuson, D.M.; and Marshall, F.M. 1998. *Guidelines on Modeling Common-Cause Failures in Probabilistic Risk Assessment*. NUREG/CR-5485. Washington, D.C.: U.S. Nuclear Regulatory Commission. ACC: MOL.20040220.0106.
- 2.2.64 NFPA 13. 2006. *Standard for the Installation of Sprinkler Systems*. 2007 Edition. Quincy, Massachusetts: National Fire Protection Association. TIC: 258713.

- 2.2.65 *Nowlen, S.P. 1986. *Heat and Mass Release for Some Transient Fuel Source Fires: A Test Report*. NUREG/CR-4680. Washington, D.C.: U.S. Nuclear Regulatory Commission. ACC: MOL.20071113.0099.
- 2.2.66 *Nowlen, S.P. 1987. *Quantitative Data on the Fire Behavior of Combustible Materials Found in Nuclear Power Plants: A Literature Review*. NUREG/CR-4679. Washington, D.C.: U.S. Nuclear Regulatory Commission. ACC: MOL.20071113.0100.
- 2.2.67 NRC (U.S. Nuclear Regulatory Commission) 1980. *Control of Heavy Loads at Nuclear Power Plants*. NUREG-0612. Washington, D.C.: U.S. Nuclear Regulatory Commission. TIC: 209017.
- 2.2.68 *NRC 1983. *PRA Procedures Guide, A Guide to the Performance of Probabilistic Risk Assessments for Nuclear Power Plants*. NUREG/CR-2300. Two volumes. Washington, D.C.: U.S. Nuclear Regulatory Commission. TIC: 205084.
- 2.2.69 NRC 1987. *Standard Review Plan for the Review of Safety Analysis Reports for Nuclear Power Plants*. NUREG-0800. LWR Edition. Washington, D.C.: U.S. Nuclear Regulatory Commission. TIC: 203894.
- 2.2.70 NRC 1997. *Standard Review Plan for Dry Cask Storage Systems*. NUREG-1536. Washington, D.C.: U.S. Nuclear Regulatory Commission. ACC: MOL.20010724.0307.
- 2.2.71 NRC 2000. *Standard Review Plan for Transportation Packages for Spent Nuclear Fuel*. NUREG-1617. Washington, D.C.: U.S. Nuclear Regulatory Commission. TIC: 249470.
- 2.2.72 NRC 2000. *Technical Basis and Implementation Guidelines for a Technique for Human Event Analysis (ATHEANA)*. NUREG-1624, Rev 1. Washington, D.C.: U.S. Nuclear Regulatory Commission. TIC: 252116.
- 2.2.73 NRC 2003. *Yucca Mountain Review Plan, Final Report*. NUREG-1804, Rev. 2. Washington, D.C.: U.S. Nuclear Regulatory Commission, Office of Nuclear Material Safety and Safeguards. TIC: 254568.
- 2.2.74 NRC 2007. *Interim Staff Guidance HLWRS-ISG-02, Preclosure Safety Analysis - Level of Information and Reliability Estimation*. HLWRS-ISG-02. Washington, D.C.: U.S. Nuclear Regulatory Commission. ACC: MOL.20071018.0240.
- 2.2.75 NRC 2007. *Preclosure Safety Analysis - Human Reliability Analysis*. HLWRS-ISG-04. Washington, DC. U.S. Nuclear Regulatory Commission. ACC: MOL.20071211.0230.
- 2.2.76 *Owen, A.B. 1992. "A Central Limit Theorem for Latin Hypercube Sampling." *Journal of the Royal Statistical Society: Series B, Statistical Methodology*, 54 (2), 541-551. London, England: Royal Statistical Society. TIC: 253131.

- 2.2.77 Regulatory Guide 1.174, Rev. 1. 2002. An Approach for Using Probabilistic Risk Assessment in Risk-Informed Decisions on Plant-Specific Changes to the Licensing Basis. Washington, D.C.: U.S. Nuclear Regulatory Commission. ACC: MOL.20080215.0049.
- 2.2.78 Not Used
- 2.2.79 SAIC (Science Applications International Corporation) 2002. *Chemical Agent Disposal Facility Fire Hazard Assessment Methodology.*, SAIC-01/2650. Abingdon, Maryland: Science Applications International Corporation. ACC: MOL.20080115.0138
- 2.2.80 SAPHIRE V. 7.26. 2007. VMware/WINDOWS XP. STN: 10325-7.26-01. (DIRS 183846)
- 2.2.81 SFPE (Society of Fire Protection Engineers) 2002. *SFPE Handbook of Fire Protection Engineering.* 3rd Edition. Quincy, Massachusetts: National Fire Protection Association. TIC: 255463. ISBN: 087765-451-4.
- 2.2.82 *Siu, N.O. and Kelly, D.L. 1998. "Bayesian Parameter Estimation in Probabilistic Risk Assessment." *Reliability Engineering and System Safety*, 62, 89-116. New York, New York: Elsevier. TIC: 258633.
- 2.2.83 *Smith, C. 2007. *Master Logic Diagram.* Bethesda, Maryland: Futron Corporation. ACC: MOL.20071105.0153; MOL.20071105.0154.
- 2.2.84 *Snow, S.D. 2007. Structural Analysis Results of the DOE SNF Canisters Subjected to the 23-Foot Vertical Repository Drop Event to Support Probabilistic Risk Evaluations, EDF-NSNF-085. Rev. 0 Idaho Falls, Idaho: Idaho National Laboratory. ACC: MOL.20080206.0062.
- 2.2.85 *Snow, S.D. and Morton, D.K. 2007. *Qualitative Analysis of the Standardized DOE SNF Canister for Specific Canister-on-Canister Drop Events at the Repository.* EDF-NSNF-087, Rev. 0. Idaho Falls, Idaho: Idaho National Laboratory. ACC: MOL.20080206.0063.
- 2.2.86 *Sprung, J.L.; Ammerman, D.J.; Breivik, N.L.; Dukart, R.J.; Kanipe, F.L.; Koski, J.A.; Mills, G.S.; Neuhauser, K.S.; Radloff, H.D.; Weiner, R.F.; and Yoshimura, H.R. 2000. *Reexamination of Spent Fuel Shipment Risk Estimates.* NUREG/CR-6672. Two volumes. Washington, D.C.: U.S. Nuclear Regulatory Commission. ACC: MOL.20001010.0217.
- 2.2.87 *Swain, A.D. and Guttman, H.E. 1983. *Handbook of Human Reliability Analysis with Emphasis on Nuclear Power Plant Applications Final Report.* NUREG/CR-1278. Washington, D.C.: U.S. Nuclear Regulatory Commission. TIC: 246563.

- 2.2.88 *Tillander, K. 2004. *Utilisation of Statistics to Assess Fire Risks in Buildings.*, Ph.D. dissertation. Espoo, Finland: VTT Technical Research Centre of Finland. TIC: 259928. ISBN: 951-38-6392-1.
- 2.2.89 Not Used
- 2.2.90 *Vesely, W.E.; Goldberg, F.F.; Roberts, N.H.; and Haasl, D.F. 1981. *Fault Tree Handbook*. NUREG-0492. Washington, D.C.: U.S. Nuclear Regulatory Commission. TIC: 208328.
- 2.2.91 *Williams, J.C. 1986. "HEART - A Proposed Method for Assessing and Reducing Human Error." *9th Advances in Reliability Technology Symposium - 1986*. Bradford, England: University of Bradford. TIC: 259862.
- 2.2.92 BSC 2008. *Waste Package Transfer Trolley Calculation*. 000-M0C-HL00-00100-000-00A. Las Vegas, Nevada: Bechtel SAIC Company. ACC: ENG.20080207.0002.

2.3 DESIGN CONSTRAINTS

- 2.3.1 10 CFR 50. 2007. Energy: Domestic Licensing of Production and Utilization Facilities. U.S. Nuclear Regulatory Commission.
- 2.3.2 10 CFR 63. 2007. Energy: Disposal of High-Level Radioactive Wastes in a Geologic Repository at Yucca Mountain, Nevada. U.S. Nuclear Regulatory Commission.
- 2.3.3 10 CFR 71. 2007. Energy: Packaging and Transportation of Radioactive Material. U.S. Nuclear Regulatory Commission. ACC: MOL.20070829.0114.
- 2.3.4 10 CFR 72. 2007. Energy: Licensing Requirements for the Independent Storage of Spent Nuclear Fuel, High-Level Radioactive Waste, and Reactor-Related Greater than Class C Waste. U.S. Nuclear Regulatory Commission.

2.4 DESIGN OUTPUTS

- 2.4.1 BSC 2008. *ITS SSC/Non-ITS SSC Interactions Analysis*. 000-PSA-MGR0-02300-000-00A. Las Vegas, Nevada: Bechtel SAIC Company.
- 2.4.2 BSC 2008. *Preclosure Nuclear Safety Design Bases*. 000-30R-MGR0-03500-000-000. Las Vegas, Nevada: Bechtel SAIC Company.
- 2.4.3 BSC 2008. *Preclosure Procedural Safety Controls*. 000-30R-MGR0-03600-000-000 REV 00. Las Vegas, Nevada: Bechtel SAIC Company.
- 2.4.4 BSC 2008. *Seismic Event Sequence Quantification and Categorization*. 000-PSA-MGR0-01100-000-00A. Las Vegas, Nevada: Bechtel SAIC Company.

2.5 ATTACHMENT REFERENCES

- 2.5.1 Attachment A: Design Input references are listed in Section 2.2 of the main report.
- 2.5.2 Attachment B: Design Input references are listed in Sections B1.1; B2.1; B3.1; B4.1; B5.1, B6.1, B7.1, B8.1.
- 2.5.3 Attachment C: Design Input references are listed in Section C5.
- 2.5.4 Attachment D: Design Input references are listed in Section D4.1.
- 2.5.5 Attachment E: Design Input references are listed in Section E8.1.
- 2.5.6 Attachment F: Design Input references are listed in Section F2.
- 2.5.7 Attachment G: This attachment does not contain Design Input references.
- 2.5.8 Attachment H: This attachment does not contain Design Input references.

3. ASSUMPTIONS

3.1 ASSUMPTIONS REQUIRING VERIFICATION

There are no assumptions requiring verification.

3.2 ASSUMPTIONS NOT REQUIRING VERIFICATION

3.2.1 General Analysis Assumptions

Assumption—Equipment and SSCs designed and purchased for the Yucca Mountain repository are of the population of equipment and SSCs represented in United States industry-wide reliability information sources. Furthermore, the uncertainty in reliability is represented by the variability of reliabilities across this population.

Rationale—Although the repository features some unique pieces of equipment at the system level (such as the waste package transfer trolley (WPTT) and the cask transfer trolley (CTT)), at the component level, the repository relies on proven and established technologies. The industry-wide information sources include historical reliability information at the component level. Such experience is relevant to the repository because the repository relies on components that are similar to the ones represented in the information sources. In some cases, system-level information, such as crane load-drop rates, from the industry-wide information sources are used. It is appropriate to use such information because it represents similar pieces of equipment at the system level. In addition, drawing from a wide spectrum of sources takes advantage of many observations, which yield better statistical information regarding the uncertainty associated with the resulting reliability estimates.

4. METHODOLOGY

4.1 QUALITY ASSURANCE

This analysis has been prepared in accordance with *Calculations and Analyses* (Ref. 2.1.1) and *Preclosure Safety Analysis Process* (Ref. 2.1.4). Therefore, the approved version is designated as “QA: QA.”

In general, input designated “QA: QA” is used. However, some of the inputs that are cited, are designated “QA: N/A.” The suitability of these inputs for the intended use is justified as follows:

Documentation of suitability for intended use of “QA: N/A” drawings: Engineering drawings are prepared using the “QA: QA” procedure *Engineering Drawings* (Ref. 2.1.2). They are checked by an independent checker and reviewed for constructability and coordination before review and approval by the engineering group supervisor and the discipline engineering manager (Ref. 2.1.2, Section 3.2.2 and Attachments 3 and 5). The check, review, and approval process provides assurance that these drawings accurately document the design and operational philosophy of the facility. For this reason, they are suitable for their intended use as sources of input to this analysis.

Documentation of suitability for intended use of “QA: N/A” engineering calculations or analyses: Engineering calculations and analyses are prepared using the “QA: QA” procedure *Calculations and Analyses* (Ref. 2.1.1). They are checked by an independent checker and reviewed for coordination before review and approval by the engineering group supervisor and the discipline engineering manager. The check, review, and approval process provides assurance that these calculations and analyses accurately document the design and operation of the facility. For this reason, they are suitable for their intended use as sources of input to this analysis.

Documentation of suitability for intended use of engineering studies (which are “QA: N/A”): In a few instances, studies are used as inputs to this analysis. The use of inputs from studies is made clear by the context of the discussion at the point of use. The use of studies is acceptable for committed analyses, such as the present analysis, provided that the results are not used for procurement, fabrication, or construction purposes. Because the present analysis is not used for procurement, fabrication, or construction purposes, the use of studies is acceptable. Therefore, the studies that are used as inputs are suitable for their intended uses.

Documentation of suitability for intended use of BSC design guides (which are “QA: N/A”): The use of inputs from design guides is made clear by the context of the discussion at the point of use. Design guides are used as inputs only when specific design documents, such as drawings, calculations, and design reports are not available at the present level of design development. Therefore, the design guides that are used as inputs are suitable for their intended uses.

Documentation of suitability for intended use of BSC engineering standards (which are “QA: N/A”): Engineering standards are used in this analysis as the basis for the numbering system for basic events. The use of inputs from BSC engineering standards is made clear by the context of the discussion at the point of use. Therefore, the design guides that are used as inputs are suitable for their intended uses.

Documentation of suitability for intended use of BSC Interoffice memorandum: Due to the early nature of the design of some systems, the only available sources for the information used are interoffice memorandum. The information used from these sources is conservative estimates and appropriate for their intended use.

Documentation of suitability for intended use of inputs from outside sources: The use of inputs from outside sources is made clear by the context of the discussion at the point of use. These uses fall into the following categories and are justified as follows (in addition to the justifications provided at the point of use).

1. Some inputs are cited as sources of the methods used in the analysis. These inputs are suitable for their intended uses because they represent commonly accepted methods of analysis among safety analysis practitioners or, more generally, among scientific and engineering professionals.
2. Some inputs are cited as examples of applications of methods of analysis by others. These inputs are suitable for their intended uses because they illustrate applicable methods of analysis.
3. Some inputs are cited as sources of historical safety-related data. These inputs are suitable for their intended uses because they represent historical data that is commonly accepted among safety analysis practitioners.
4. Some inputs are cited as sources of accepted practices as recommended by codes, standards, or review plans. These inputs are suitable for their intended uses because they represent codes, standards, or review plans that are commonly accepted by practitioners of the affected professional disciplines.
5. Some inputs provide information specific to the Yucca Mountain repository that was produced by organizations other than BSC. These inputs are suitable for their intended uses because they provide information that was developed for the Yucca Mountain repository under procedures that apply to the organization that produced the information.

4.2 USE OF SOFTWARE

4.2.1 Level 1 Software

This section addresses software used in this analysis as Level 1 software, as defined in *Software Management* (Ref. 2.1.3, Attachment 12). SAPHIRE Version 7.26 STN 10325-7.26-01 (Ref. 2.2.80) is used in this analysis for probabilistic risk assessment (PRA) simulation and analyses. The SAPHIRE software is used on a personal computer running Windows XP inside a

VMware virtual machine; it is also listed in the current *Qualified and Controlled Software Report*, and was obtained from Software Configuration Management. The SAPHIRE software is specifically designed for PRA simulation and analyses, and has been verified to show that this software produces precise solutions for encoded mathematical models within the defined limits, for each parameter employed (Ref. 2.2.44). Therefore, SAPHIRE Version 7.26 is suitable for use in this analysis.

The SAPHIRE project files for this analysis are listed in Attachment H. They are contained on a compact disc, which is included as part of Attachment H. SAPHIRE project files contain all of the inputs that SAPHIRE requires to produce the outputs that are documented in this analysis.

4.2.2 Level 2 Software

This section addresses software used in this analysis that is classified as Level 2 software, as defined in *Software Management* (Ref. 2.1.3, Attachment 12). The software is used on personal computers running either Windows XP Professional or Windows 2000 operating systems.

- Word 2003, a component of Microsoft Office Professional 2003, and Visio Professional 2003 are listed in the current *Level 2 Usage Controlled Software Report*. Visio 2003 and Word 2003 are used in this analysis for the generation of graphics and text. The accuracy of the resulting graphics and text is verified by visual inspection. The precise means of verification is left to the discretion of the checker in compliance with applicable procedures.
- Excel 2003, a component of Microsoft Office Professional 2003, and Mathcad version 13.0 and 14.0 are listed in the current *Level 2 Usage Controlled Software Report*. Crystal Ball version 7.3.1 (a commercial, off-the-shelf, Excel-based risk-analysis tool) is listed on the *Controlled Software Report* and is registered for Level 2 usage. Excel 2003, Mathcad 13.0 and 14.0, and Crystal Ball 7.3.1 are used in this analysis to calculate probability distributions for selected SAPHIRE inputs and to graphically display information. Graphical representations are verified by visual inspection. The calculations are documented in sufficient detail to allow an independent replication of the computations. The user defined formulas and inputs are verified by visual inspection. The results are in some cases verified by independent replication of the computations. However, in some cases, for example, for some Excel calculations and Mathcad 13.0 and 14.0 calculations, the results are verified by visual inspection. The precise means of verification is left to the discretion of the checker in compliance with applicable procedures.
- WinZip 9.0, a file compression utility for Windows, is listed in the current *Level 2 Usage Controlled Software Report*. WinZip 9.0 is used in this analysis to compress files for presentation on compact disc in Attachment H.

4.3 DESCRIPTION OF ANALYSIS METHODS

This section presents the PCSA approach and analysis methods in the context of overall repository operations. As such, it includes a discussion of operations that may not apply to the CRCF. Specific features of the CRCF and its operations are not discussed until Section 6, where the methods described here are applied to the CRCF. The PCSA uses the technology of PRA as described in references such as *Standard for Probabilistic Risk Assessment for Nuclear Power Plant Applications* (Ref. 2.2.8). The PRA answers three questions:

1. What can go wrong?
2. What are the consequences?
3. How likely is it?

PRA may be thought of as an investigation into the responses of a system to perturbations or deviations from its normal operation or environment. The PCSA is a simulation of how a system acts when something goes wrong. Relationships between the methodological components of the PCSA are depicted in Figure 4.3-1. Phrases in *bold italics* in this section indicate methods and ideas depicted in Figure 4.3-1. Phrases in *normal italics* indicate key concepts.

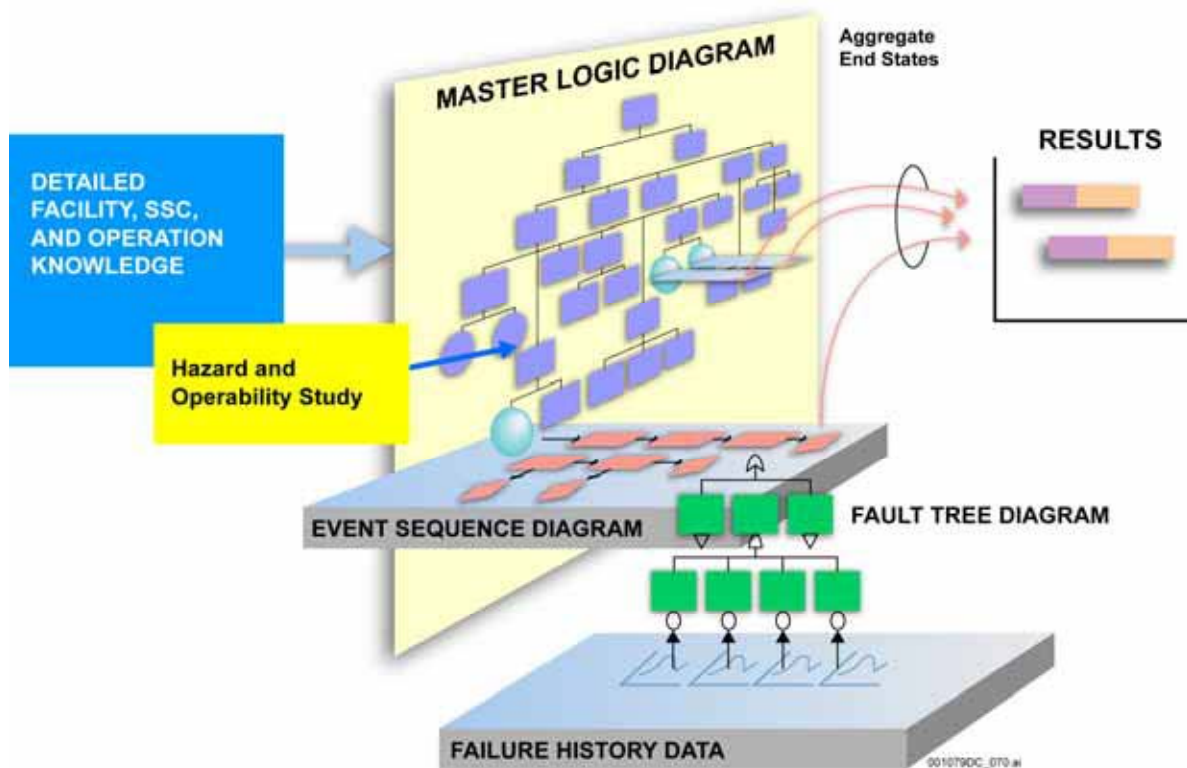

Source: Ref. 2.2. 83 and Figure 1 of Ref. 2.2.33.

Figure 4.3-1. Event Sequence Analysis Process

The PCSA starts with analysts obtaining sufficient knowledge of the designs and operations of facility equipment and SSC to understand how the Yucca Mountain Project (YMP) waste handling is conducted. This is largely performed and documented in the *Canister Receipt and Closure Facility Event Sequence Development Analysis* (Ref. 2.2.33). An understanding of how a facility operates is a prerequisite for developing event sequences that depict how it would fail. *Success criterion* is important additional set inputs to the PCSA. A success criterion states the minimum functionality that constitutes acceptable, safe performance. For example, a success criterion for a crane is to pick-up, transport, and put-down a cask without dropping it. The complementary statement of a success criterion is a failure mode (e.g., crane drops cask).

The basis of the PCSA is the development of *event sequences*. An event sequence may be thought of as a string of events beginning with an *initiating event* and eventually leading to potential consequences (*end states*). Between initiating events and end states within a scenario, are *pivotal events* that determine whether and how an initiating event propagates to an end state. An event sequence answers the question “What can go wrong?” and is defined by one or more initiating events, one or more pivotal events, and one end state. Initiating events are identified by *MLD* development, cross-checked with an evaluation based on applied *HAZOP* evaluation techniques. Event sequences unfold as a combination of failures and successes of pivotal events. An end state, the termination point for an event sequence, identifies the type of radiation exposure or potential criticality, if any, that results. In this analysis, eight mutually exclusive end states are of interest:

1. “OK”—Indicates the absence of the other end states and potential for criticality.
2. Direct Exposure, Degraded Shielding—Applies to event sequences where a SSC providing shielding is not breached, but its shielding function is jeopardized. An example is a lead-shielded transportation cask that is dropped from a height great enough for the lead to slump toward the bottom of the cask at impact, leaving a partially shielded path for radiation to stream. Excludes radionuclide release from containment and an indication of a reactivity increase.
3. Direct Exposure, Loss of Shielding—Applies to event sequences where a SSC providing shielding fails, leaving a direct path for radiation to stream. For example, this end state applies to a breached transportation cask, with the dual-purpose canister (DPC) or transportation, aging, and disposal (TAD) canister inside maintaining its containment function. In another example, this end state applies to shield doors inadvertently opened. Excludes radionuclide release from containment and an indication of a reactivity increase.
4. Radionuclide Release, Filtered—Indicates a release of radioactive material from its containment, through a filtered path, to the environment. The release is filtered when it is confined and filtered through the successful operation of the heating, ventilation, and air conditioning (HVAC) system over its mission time. Excludes nuclear reactivity increases.

5. Radionuclide Release, Unfiltered—Indicates a release of radioactive material from its confinement, through the pool of the WHF or through an unfiltered path, to the environment. Excludes nuclear reactivity increases.
6. Radionuclide Release, Filtered, Also Important to Criticality—This end state refers to a situation in which a filtered radionuclide release occurs and (unless the associated event sequence is beyond Category 2) for which a criticality investigation is indicated.
7. Radionuclide Release, Unfiltered, Also Important to Criticality—This end state refers to a situation in which an unfiltered radionuclide release occurs and (unless the associated event sequence is beyond Category 2) a criticality investigation is indicated.
8. Important to Criticality—This end state refers to a situation in which there has been no radionuclide release and (unless the associated event sequence is beyond Category 2) a criticality investigation is indicated.

The answer to the second question, “What are the consequences?” requires consideration of radiation exposure and the potential for criticality for Category 1 and Category 2 event sequences. Consideration of the consequences of event sequences that are beyond Category 2 is not required by 10 CFR Part 63 (Ref. 2.3.2). Radiation doses to individuals from direct exposure and radionuclide release are addressed in a companion consequence analysis by modeling the effects of bounding event sequences related to the various waste forms and the facilities that handle them.

The radiological consequence analysis develops a set of bounding consequences. Each bounding consequence represents a group of like event sequences. The group (or bin) is based on such factors as characteristics of the waste form involved, availability of HEPA filtration, location of occurrence (in water or air), and characteristics of the surrounding material (such as transportation cask or waste package). Each event sequence is mapped to one of the bounding consequences, for which conservative doses have been calculated.

Criticality analyses are performed to ensure that any Category 1 and Category 2 event sequences that terminate in end states that are important to criticality would not result in a criticality. In order to determine the criticality potential for each waste form and associated facility and handling operations, criticality sensitivity calculations are performed. These calculations evaluate the impact on system reactivity of variations in each of the parameters important to criticality during the preclosure period. The parameters are: waste form characteristics, reflection, interaction, neutron absorbers (fixed and soluble), geometry, and moderation. The criticality sensitivity calculations determine the sensitivity of the effective neutron multiplication factor to variations in any of these parameters as a function of the other parameters. The deterministic sensitivity analysis covers all reasonably achievable repository configurations that are important to criticality. Refer to Section 4.3.9 for detailed discussion of the treatment of criticality in event sequences.

The third question, “How likely is it?” is answered by the estimation of event sequence frequencies. The PCSA uses *failure history* records (for example, *Nonelectronic Parts Reliability Data* (Ref. 2.2.43) and *Nuclear Computerized Library for Assessing Reactor Reliability* NUREG/CR-4639 (Ref. 2.2.55), structural reliability analysis, thermal stress analysis, and engineering and scientific knowledge about the design as the basis for estimation of probabilities and frequencies. These sources coupled with the techniques of probability and statistics, for example, *Handbook of Parameter Estimation for Probabilistic Risk Assessment* (Ref. 2.2.12), are used to estimate frequencies of initiating events and event sequences and the conditional probabilities of pivotal events.

The PCSA uses *event sequence diagrams (ESDs)*, *event trees*, and *fault trees* to develop and quantify event sequences. The ESDs and event trees are described and developed in the event sequence development analyses. The present analysis uses fault trees to disaggregate a SSC or item of equipment to a level of detail that is supported by available reliability information from failure history records. Various techniques of probability and statistics are employed to estimate failure frequencies of mechanical, electrical, electro-mechanical, and electronic equipment. Such frequencies, or *active-component* unreliabilities, provide inputs to the fault tree models of items of equipment. Fault trees are used in some instances to model initiating events and in other instances to model pivotal events.

Some pivotal events are related to structural failures of containment (e.g., canisters) and others are related to shielding (e.g., transportation casks). In these cases, probabilistic structural reliability analysis methods are employed to calculate the mean conditional probability of containment or shielding failure given the initiating event (e.g., a drop from a crane). Other pivotal events require knowledge of response to fires. Calculation of failure probabilities given a fire is accomplished by the appropriate analysis using applicable material properties and traditional methods of heat transfer analysis, structural analysis, and fire dynamics. The probabilities so derived are called *passive-equipment* failure probabilities.

All pivotal events in the PCSA are characterized by *conditional probabilities* because their values rely on the conditions set by previous events in an event sequence. For example, the failure of electrical or electronic equipment depends on the operating temperature. Therefore, if a previous event in a scenario is a failure of a cooling system, then the probability of the electronic equipment failure would depend on the operation (or not) of the cooling system.

The frequency of occurrence of an event sequence is the product of the frequency of its initiating event and the conditional probabilities of its pivotal events. This is true whether or not the frequency and probabilities are expressed as single points or probability distributions. To group together event sequences for the purpose of categorization, the frequencies of event sequences within the same ESD that result in the same end state, are summed. The concept of *aggregating event sequences* to obtain aggregated end state results is depicted in Figure 4.3-1.

The PCSA is described above as a system simulation. This is important in that any simulation or model is an approximate representation of reality. Approximations may lead to uncertainties regarding the frequencies of event sequences. The event sequence quantification presented in this document propagates input uncertainties to the calculated frequencies of event sequences using Monte Carlo techniques. Figure 4.3-1 illustrates the *results* as horizontal bars to depict the uncertainties that give rise to potential ranges of results.

As required by the performance objectives for the GROA through permanent closure in 10 CFR 63.111 (Ref. 2.3.2), each aggregated event sequence is categorized based on its frequency. Therefore, the focus of the analysis in this document is to:

1. Quantify the frequency of each initiating event that is identified in the *Canister Receipt and Closure Facility Event Sequence Development Analysis* (Ref. 2.2.33).
2. Quantify the conditional probability of the pivotal events in each event sequence.
3. Calculate the frequency of each event sequence (i.e., calculate the product of the initiating event frequency and pivotal event conditional probabilities).
4. Calculate the frequencies of the aggregated event sequences.
5. Categorize the aggregated event sequences for further analysis.

The activities required to accomplish these objectives are illustrated in Figure 4.3-2 and described below.

The cross-hatched boxes in Figure 4.3-2 serve as a review of the analysis performed for the *Canister Receipt and Closure Facility Event Sequence Development Analysis* (Ref. 2.2.33). The interface between the event sequence development analysis and the present categorization analysis is the set of event trees, as represented by the darkly shaded box. The event trees from the event sequence development analysis are passed as input into the present analysis. The unshaded boxes represent the analysis performed in this study, the methods of which are described later in Section 4.

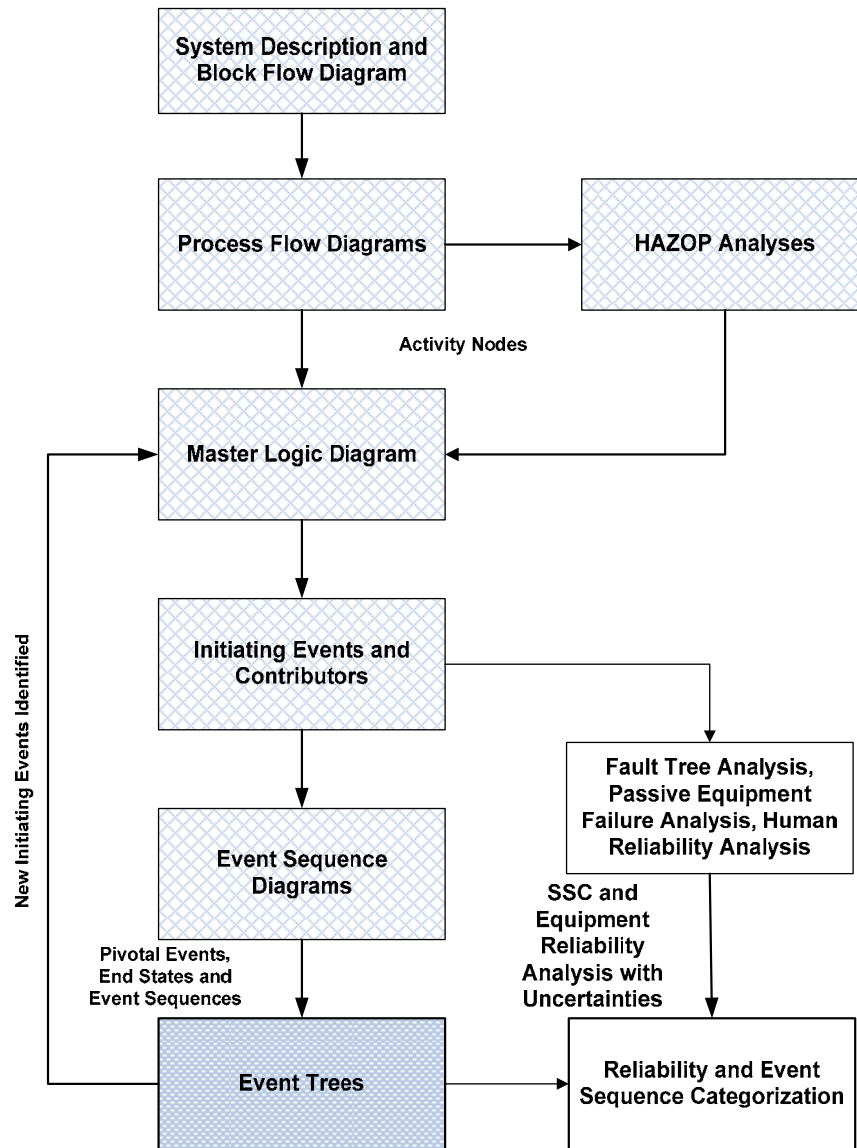

NOTE: HAZOP = hazard and operability; SSC = structure, system, or component

Source: Modified from Ref. 2.2.33.

Figure 4.3-2. PCSA Process

The event sequences that are categorized in the present analysis can be more fully understood by consulting the event sequence development analysis (Ref. 2.2.33). The remainder of this subsection presents a refresher of the event sequence development process.

A simplified process flow diagram (PFD) is developed to clearly delineate the process and sequence of operations to be considered within the analysis of the facility. An excerpt from an example PFD is shown in Figure 4.3-3. The PFD guides development of the MLD and the conduct of the HAZOP evaluation. The PFD is broken down into nodes to identify specific processes and operations that are evaluated with both a MLD and HAZOP evaluation to identify potential initiators.

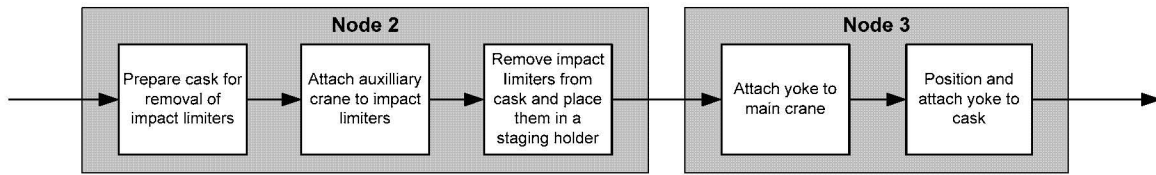

NOTE: This diagram illustrates a small portion of the overall handling operations for a typical waste handling facility.

Source: Original

Figure 4.3-3. Portion of a Simplified Process Flow Diagram for a Typical Waste-Handling Facility

Development of the MLD is accomplished by deriving specific failures from a generalized statement of the undesired state. As a “top-down” analysis, the MLD starts with a top event, which represents a generalized undesired state. The top event includes direct exposure to radiation and exposure as a result of a release of radioactive material. The basic question answered by the MLD is “How can the top event occur?” Each successively lower level in the MLD hierarchy divides the identified ways in which the top event can occur with the aim of eventually identifying specific initiating events that may cause the top event. In the MLD, the initiating events are shown at the next-to-lowest level. The lowest level provides an example of contributors to the initiating event. This process for the PCSA is detailed in the *Canister Receipt and Closure Facility Event Sequence Development Analysis* (Ref. 2.2.33, Section 4.3.1.2).

The HAZOP evaluation focuses on identifying potential initiators that are depicted in the lower levels of the MLD. It is a “bottom-up” approach that supplements the “top-down” approach of the MLD. The HAZOP evaluation is also a systematic analysis of repository operations during the preclosure phase. As an early step in the performance of the HAZOP evaluation, the intended function, or intention, of each node in the PFD is defined. The intention is a statement of what the node is supposed to accomplish as part of the overall operation. The HAZOP analysts work their way through the PFD, node by node, and postulate deviations from normal operations. A “deviation” is any out-of-tolerance variation from the normal values of parameters specified for the intention. Although the repository is in some ways to be the first of its kind, the operations are based on established technologies: for example, transportation cask movement by truck and rail, crane transfers of casks and canisters, rail-based trolleys, air-based conveyances, robotic welding, and SNF pool operations. The team assembled for the HAZOP evaluation (and available on call as questions arose) had experience with such technologies and was well equipped to perform the evaluation.

The MLD and HAZOP evaluation are strongly interrelated. The MLD is cross-checked to the HAZOP evaluation. That is, the MLD is modified to include any initiators and contributors that are identified in the HAZOP evaluation but not already included in the MLD. The entire process is iterative in nature (Figure 4.3-2 (does not show iteration)) with insights from succeeding steps often feeding back to predecessors. The top-down MLD and the bottom-up HAZOP evaluation provide a diversity of viewpoints that add confidence that no important initiating events have been omitted. Details on implementation of the HAZOP evaluation are presented in the *Canister Receipt and Closure Facility Event Sequence Development Analysis* (Ref. 2.2.33, Section 4.3.1.3).

The initiating events that are represented in the MLD are transferred to events depicted as “little bubbles” (Figure 4.3-4, 1,2,3) in the ESDs. One or more initiating events identified on the MLD may be included in a single little bubble, but all of the initiating events included in the little bubble must have the same pivotal events (i.e., human and SSC responses) and the same conditional probability for each pivotal event. Initiating events represented by little bubbles may be aggregated further into “big bubbles” as depicted in Figure 4.3-4. The big bubble represents the failures associated with a major function in a specific location depicted in the PFD and establishes the level of aggregation for the categorization of the event sequence (as Category 1, Category 2, or beyond Category 2).

For example, all initiating events that challenge the containment function of a canister would include pivotal events that question the containment integrity of the canister and the availability of HVAC confinement. The knowledge to develop such ESDs and appropriately group the initiating events comes from a detailed knowledge of the SSCs and operations derived from developing the PFD, MLD, and HAZOP evaluation. The pivotal event conditional probabilities are the same for all initiating events in a little bubble. All initiating events represented by the big bubble have the same human and SSC responses and, therefore, may be represented by the same event sequences. However, the conditional probability for each pivotal event is not necessarily the same for each little bubble.

4.3.1 Event Tree Analysis and Categorization

Also illustrated in Figure 4.3-4, is the relationship of the YMP ESDs to their equivalent event trees. Event trees contain the same information as ESDs but in a form suitable to be used by software such as SAPHIRE (Ref. 2.2.44) which ultimately stores event trees, fault trees, and reliability data, and it quantifies the event sequences. Event tree depiction of ESDs provides little new information. In an event tree, each event sequence has its separate line so that the connections between initiating events and end states is more explicit than in ESDs (Ref. 2.2.68, Section 3.4.4.2). Any path from left to right that begins with the initiating event and terminates with an end state is an event sequence. Every path must be associated with an end state. As illustrated in the event tree portion of Figure 4.3-4, each intersection of a horizontal and vertical line is referred to as a node (or branch point). Each node is associated with a conditional probability of following the vertical downward branch. By convention, the description of each branch is stated as a success, and the downward branch indicates a failure. The complement is the probability of taking the vertical upward branch, that is, the probability of success. To quantify the event sequence, the initiating event frequency (or expected number of occurrences) is multiplied by the conditional probability of each subsequent pivotal event node in the event sequence until an end state is reached.

The YMP PCSA uses the concept of linked event trees (Ref. 2.2.68). Each facility has its own set of event trees. The first event tree simply represents the little bubbles, one horizontal line per little bubble. This is called the initiator event tree (IET). The second event tree contains the pivotal events and end states. This is called the system response event tree (SRET). An event sequence would start with each of the horizontal lines as if it were the initiating event on the SRET, as indicated in Figure 4.3-4. Each set of IET and SRET is quantified for each waste container type (e.g., dual-purpose canisters (DPC), transportation, aging, and disposal (TAD) canisters, U.S. Department of Energy (DOE) spent nuclear fuel (SNF)) that is handled in a facility. The event in the IET labeled “# of occurrences” represents the number of handlings (i.e., demands) for that initiating event. For example, each lift of a vertical transportation cask provides an opportunity for a drop. An event sequence quantification includes the frequency (or number of occurrences) of each end state (e.g., radionuclide release), associated with a single lift, and multiplies it by the number of lifts to obtain the expected number of drops over the preclosure period. This approach is consistent with a binomial model of reliability.

Categorization of event sequences is based on the aggregated “big bubble” initiating event. Each line on the IET coupled with the SRET is quantified separately. Using Figure 4.3-4, this would mean three quantifications, corresponding to the three initiating event frequencies and three corresponding sets of pivotal event probabilities. (By SAPHIRE convention, the top line is a dummy initiating event.) Each event sequence, therefore, would have three values. In order to obtain the total frequency of an event sequence for purposes of categorization, per 10 CFR 63.111 (Ref. 2.3.2), the three frequencies are probabilistically summed. Doing this summation is equivalent to basing categorization on the big bubble. If an event sequence has only one little bubble, then only the SRET needs to be used with the initiating event in the place so denoted, in the second event tree. In this case, summation of event sequences is not necessary and not performed.

Because each event sequence is associated with a mean number of occurrences over the preclosure period, categorization is straightforward. Those event sequences that are expected to occur one or more times before permanent closure of the GROA are Category 1 event sequences. Other event sequences that have at least one chance in 10,000 of occurring but less than one occurrence before permanent closure are Category 2 event sequences. Sequences that have less than one chance in 10,000 of occurring before permanent closure are identified as beyond Category 2. As described in Section 4.3.6, event sequence quantification considers uncertainties and categorization is performed on the basis of an event sequence mean value of the underlying probability distribution. The preclosure period lasts 100 years but actual emplacement operations occupy 50% of this time (Ref. 2.2.17, Section 2.2.2.7).

An initiating event for an event sequence may have the potential to affect several waste form types (for instance, a high-level radioactive waste (HLW) canister and a DOE standardized canister, or a TAD canister and a DPC). For example, the seismically-induced event sequence leading to a collapse of a surface facility could cause the breach of all the waste forms inside that facility. Similarly, a large fire affecting an entire facility also affects all the waste forms inside the facility. The number of occurrences over the preclosure period of an event sequence that affects more than one type of waste form is equal to the number of occurrences of the event sequence, evaluated for one of the waste form types, multiplied by the probability that the other waste form types are present at the time the initiating event occurs. Because a probability is less

than or equal to one, the resulting product is not greater than the number of occurrences of the event sequence before multiplication by the probability. The number of occurrences of an event sequence is calculated for a given waste form type, without adjustment for the probability of presence of other waste form types. The results of the event sequence categorization (reported in Section 6.8.3) show that the event sequences that have the potential to cause personnel exposure to radiation from more than one type of waste form are either Category 2 event sequences resulting in a direct exposure, or beyond Category 2 event sequences resulting in a radionuclide release. In the first case, doses from direct radiation after a Category 2 event sequence have no effect on the public because of the great distances from the locations of offsite receptors. In the second case, beyond Category 2 event sequences do not require a consequence calculation. Thus, the demonstration that the performance objectives of 10 CFR 63.111 (Ref. 2.3.2) are met is not dependent on the waste form at risk in the event sequences that may involve more than one type of waste form. It is appropriate, therefore, to evaluate event sequences separately for each relevant type of waste form.

4.3.2 Initiating and Pivotal Event Analysis

The purpose of this analysis is to develop the frequency (i.e., expected number of occurrences over the 50-year operating lifetime of the facility) of each event sequence in order to categorize event sequences in accordance with 10 CFR 63.2 (Ref. 2.3.2). (In this document, the term frequency is used interchangeably with the expected number when discussing event sequence quantification). This involves developing the frequency of each initiating event and conditional probability of each pivotal event. Some pivotal events in this analysis are associated with structural or thermal events. In these cases, passive equipment failure analyses (PEFAs) are performed. The PEFAs include probabilistic structural or thermal analyses as summarized later in this section to develop mean conditional probabilities of failure directly associated with pivotal events. Often, however, the events depicted in ESDs or event trees cannot easily be mapped to such a calculation or to reliability data (e.g., failure history records). This is because large aggregates of components (e.g., systems or complicated pieces of equipment such as the waste package transfer trolley (WPTT)) may be unique to the YMP facility with little or no prior operating history. The components, however, of which it is composed, have usually been used before and there is an adequate set of reliability data for these components. The PCSA used fault trees for this mapping. As a result, the PCSA disaggregates or breaks down the initiating events and pivotal events, when needed, into a collection of simpler components. An initiating event uses fault trees and the pivotal event associated with confinement is analyzed via a fault tree of the HVAC system. In effect, the use of fault trees creates a mapping between ESD or event tree events and the available reliability data.

4.3.2.1 Fault Tree Analysis

Construction of a fault tree is a deductive reasoning process that answers the question “What are all combinations of events that can cause the top event to occur?” Figure 4.3-5 demonstrates this:

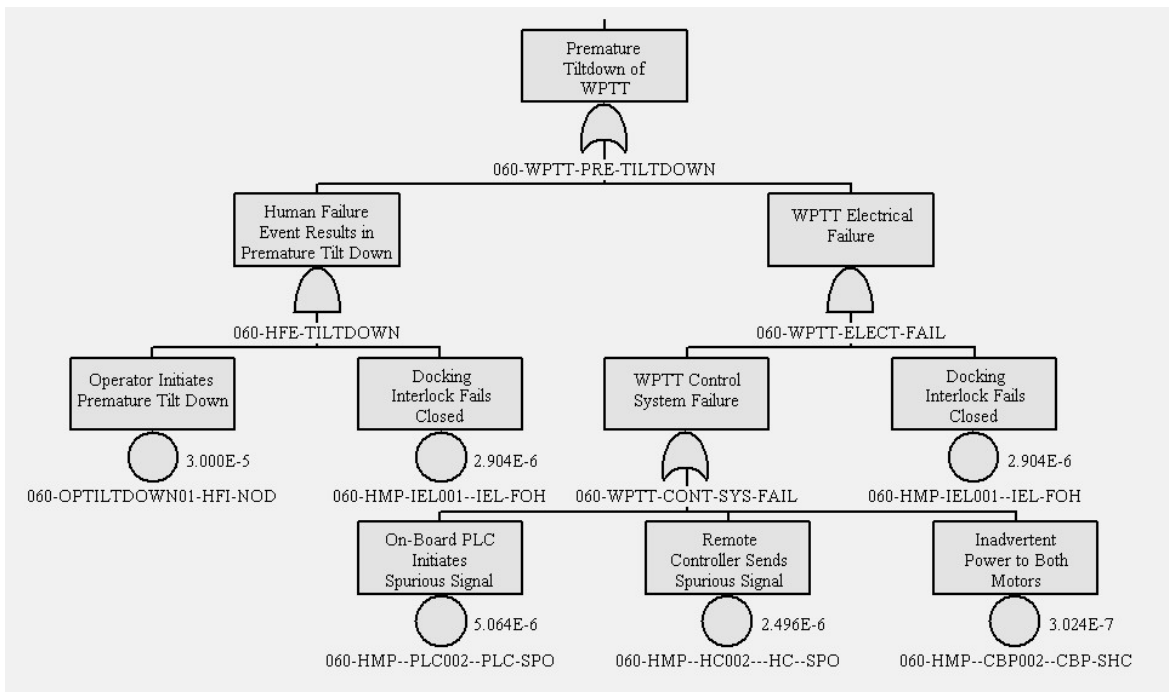

NOTE: This fault tree is presented for illustrative purposes only and is not intended to represent results of the present analysis.

PLC = programmable logic controller; WPTT = waste package transfer trolley.

Source: Original

Figure 4.3-5. Example Fault Tree

This top-down analytical development defines the combinations of causes for the initiating or pivotal events, into an event sequence, in a way that allows the probability of the events to be estimated.

As the name implies, fault tree events are usually failures or faults. Fault trees use logic or Boolean gates. Figure 4.3-5 shows two types of gates: the AND gate (mound shaped symbols with flat bottoms) and the OR gate (mound shaped symbols with concave bottoms). An AND gate passes an output up the tree if all events immediately attached to it occur. An OR gate passes an output up the tree if one or more events immediately attached to it take place. An AND gate often implies components or system features that back up each other, so that if one fails, the other continues to adequately perform the function. The success criterion of the SSC or equipment being analyzed is important in determining the appropriate use of gates.

The bottom level of the fault tree contains events with circles beneath them indicating a *basic event*. Basic events are associated with frequencies from industry-wide active equipment reliability information, passive equipment failure analysis, or human reliability analysis.

Fault trees are Boolean reduced to “minterm” form, which expresses the top event in terms of the union of minimal cut sets. Minimal cut sets, which are groups of basic events that must all occur to cause the top event in the fault tree, result from applying the Boolean Idempotency and Absorption laws. Fault tree analysis, as used in the PCSA, is well described in the *Fault Tree Handbook*. NUREG-0492 (Ref. 2.2.90). Each minimal cut set represents a single basic event or a combination of two or more basic events (e.g., a logical intersection of basic events) that could result in the occurrence of the event sequence. Minimal cut sets are minimal in the sense that they contain no redundant basic events (i.e., if any basic event were removed from a minimal set, the remaining basic events together would not be sufficient to cause the top event). Section 4.3.6 continues the discussion about utilization of minimal cut sets in the quantification of event sequences.

As illustrated in Figure 4.3-5, the organization of the fault trees in the PCSA is developed to emphasize two primary elements, which together result in the occurrence of the top event: 1) human failure events, and 2) equipment failures. The human failure events include postulated unintended crew actions and omissions of crew actions. Identification and quantification of human failure events (HFEs) are performed in phases. Initial identification of HFEs led to design changes to either eliminate them or reduce the probability that they would cause the fault tree top event. For example, Figure 4.3-5 shows an HFE logically intersected with an electro-mechanical interlock such that both a crew error of commission and failure of the interlock must occur for premature WPTT tiltdown to occur.

Event trees and fault trees are complementary techniques. Often used together, they map the system response from initiating events through damage levels. Together, they delineate the necessary and sufficient conditions for the occurrence of each event sequence (and end state). Because of the complementary nature of using both inductive and deductive reasoning processes, combining event trees and fault trees allow more comprehensive, concise, and clearer event sequences to be developed and documented than using either one exclusively. The selection of and division of labor among each type of diagram depends on the analyst’s opinion. In the PCSA, the choice was made to develop event trees along the lines of major functions such as crane lifts, waste container containment, HVAC and building confinement, and introduction of moderator. Fault trees disaggregate these functions into equipment and component failure modes for which unreliabilities or unavailabilities were obtained.

4.3.2.2 Passive Equipment Failure Analysis

Passive equipment (e.g., transportation casks, storage canisters, waste packages) may fail from manufacturing defects, material variability, defects introduced by handling, long-term effects such as corrosion, and normal and abnormal use. Industry codes, such as *Minimum Design Loads for Buildings and Other Structures* (Ref. 2.2.7), and *2004 ASME Boiler and Pressure Vessel Code* (Ref.2.2.9) establish design load combinations for passive structures (such as building supports) and components (such as canisters). These codes specify design basis load combinations and provide the method to establish allowable stresses. Typical load combinations

for buildings involve snow load, dead (mass) load, live occupancy load, wind load, and earthquake load. Typical load combinations for canisters and casks are found in *2004 ASME Boiler and Pressure Vessel Code* (Ref. 2.2.9) and would include, for example, preloads or prestresses, internal pressurization and drop loads, which are specified in terms of acceleration. Design basis load combinations are purposefully specified to conservatively encompass anticipated normal operational conditions as well as uncertainties in material properties and analysis. Therefore, passive components, when designed to codes and standards and in the absence of significant aging, generally fail because of load combinations or individual loads that are much more severe than those anticipated by the codes. Fortunately, the conservative nature of establishing the design basis coupled with the low probability of multiple design basis loads occurring concurrently, often means a significant margin or factor of safety exists between the design point and actual failure. The approach used in the PCSA takes advantage of the design margins (or factor of safety).

The development of code requirements for minimum design loads in buildings and other structures in the late 1970's considered multiple loads. A probabilistic basis for structural reliability was developed as part of the development of *Development of a Probability Based Load Criterion for American National Standard A58, Building Code Requirements for Minimum Design Loads in Buildings and Other Structures* (Ref. 2.2.48). This document refers to classic structural reliability theory. In this theory, each structure has a limit state (e.g., yield or ultimate), such that, loads and resistances are characterized by Equation 1:

$$g(x_1, x_2, \dots, x_i, \dots, x_n) = 0 \quad (\text{Eq. 1})$$

In Equation 1, g is termed the limit-state variable where failure is defined as $g < 0$ and the x_i are resistance (sometimes called capacity or fragility) variables or load (sometimes called stress or demand) variables. The probability of failure of a structure is given, in general, by Equation 2:

$$P_f = \int \dots \int f_x(x_1, x_2, \dots, x_i, \dots, x_n) dx_1 dx_2 \dots dx_n \quad (\text{Eq. 2})$$

Where f_x is the joint probability density function of x_i and the integral is over the region in which $g < 0$. The fact that these variables are represented by probability distributions implies that absolutely precise values are not known. In other words, the variable values are uncertain. This concept is illustrated in Figure 4.3-6. Codes and standards such as *Minimum Design Loads for Buildings and Other Structures* (Ref. 2.2.7), guide the process of designing structures such that there is a margin, often called a factor of safety, between the load and capacity. The factor of safety is established in recognition that quantities, methods used to evaluate them, and tests used to ascertain material strength give rise to uncertainty. A heuristic measure of the factor of safety is the distance between the mean values of the two curves.

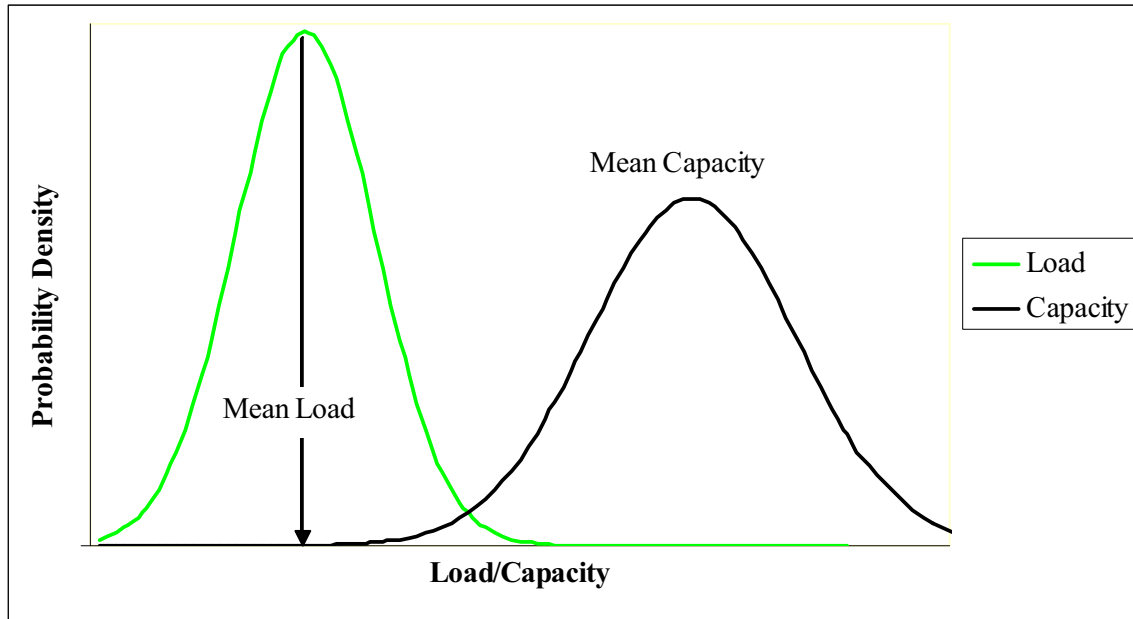

Source: Original

Figure 4.3-6. Concept of Uncertainty in Load and Resistance

In the case in which Equations 1 and 2 are approximated by one variable representing capacity and the other representing load, each of which is a function of the same independent variable y , the more familiar load-capacity interference integral results as shown in Equation 3.

$$P_f = \int F(y)h(y)dy \quad (\text{Eq. 3})$$

P_f is the mean probability of failure and is appropriate for use when comparing to a probability criterion such as one in a million. In Equation 3, $F(y)$ represents the cumulative density function (CDF) of structural capacity and $h(y)$ represents the probability density function (PDF) of the load. The former is sometimes called the fragility function and the later is sometimes called the hazard function.

To analyze the probability of breach of a dropped canister, y is typically in units of strain, F is typically a fragility function, which provides the conditional probability of breach given a strain; and h is the probability density function of the strain that would emerge from the drop. For seismic risk analysis, h represents the seismic motion input, y is in units of peak ground acceleration, and F is the seismic fragility. The seismic analysis of the YMP structures is documented separately in *Seismic Event Sequence Quantification and Categorization* (Ref. 2.4.4). Degradation of shielding owing to impact loads uses a strain to failure criterion within the simplified approach of Equation 4, described below. For analysis of the conditional probability of breach owing to fires, y is temperature, F is developed from fire data for non-combustible structures, and h is developed using probabilistic heat transfer calculations. Analysis for heating up casks, canisters, and waste packages associated with loss of building forced convection cooling was similarly accomplished, but Equation 4 was used.

If load and capacity are known, then Equations 2 and 3 provide a single valued result, which is the mean probability of failure. Each function in Figure 4.3-6 is characterized by a mean value, \bar{L} and \bar{R} , and a measure of the uncertainty, generally the standard deviation, usually denoted by σ_L and σ_R for L and R, respectively. The spread of the functions may be expressed, alternatively, by the corresponding coefficient of variation (V) given by the ratio of standard deviation to mean, or $V_L = \sigma_L/\bar{L}$ and $V_R = \sigma_R/\bar{R}$ for load and resistance, respectively. The coefficient of variation may be thought of as a measure of dispersion expressed in terms of the number of means.

In the PCSA, the capacity curve for developing the fragility of casks and canisters against drops was constructed by a statistical fit to tensile elongation to failure tests (Ref. 2.2.40). The load curve may be constructed by varying drop height. A cumulative distribution function may be fit to a locus of points each of which is the product of drop height frequency and strain given drop height.

Impact Events Associated with Containment Breach

A simplification of Equation 3, consistent with *Interim Staff Guidance HLWRS-ISG-02, Preclosure Safety Analysis – Level of Information and Reliability Estimation* (Ref. 2.2.74), and shown in Equation 4 is used in the PCSA. It is illustrated in Figure 4.3-7.

$$P_f = \int_0^h F(y)dy \quad (\text{Eq. 4})$$

In Equation 4, h is a single value conservative load.

The load is a single value estimated by performing a calculation for a condition more severe than the mean. For example, if the normal lift height of the bottom of a canister is 23 feet, a drop height of 32.5 feet is more severe and may be conservatively applied to all drop heights equal to or below this height. The conditional probability of breach is an increasing function of drop height. Strain resulting from drops is calculated by dynamic finite element analysis using LS-DYNA for canisters and transportation cask drops (Ref. 2.2.40). Therefore, use of a higher than mean drop height for the load for all drop heights, results in a conservative estimate of breach probability. As an additional conservatism, a lower limit of breach probability of 1E-05 was placed on drops of casks, canisters, and waste packages. To perform the analyses, representative canisters and casks were selected from the variety of available designs in current use which were relatively thin walled on the sides and bottom. This added another conservative element.

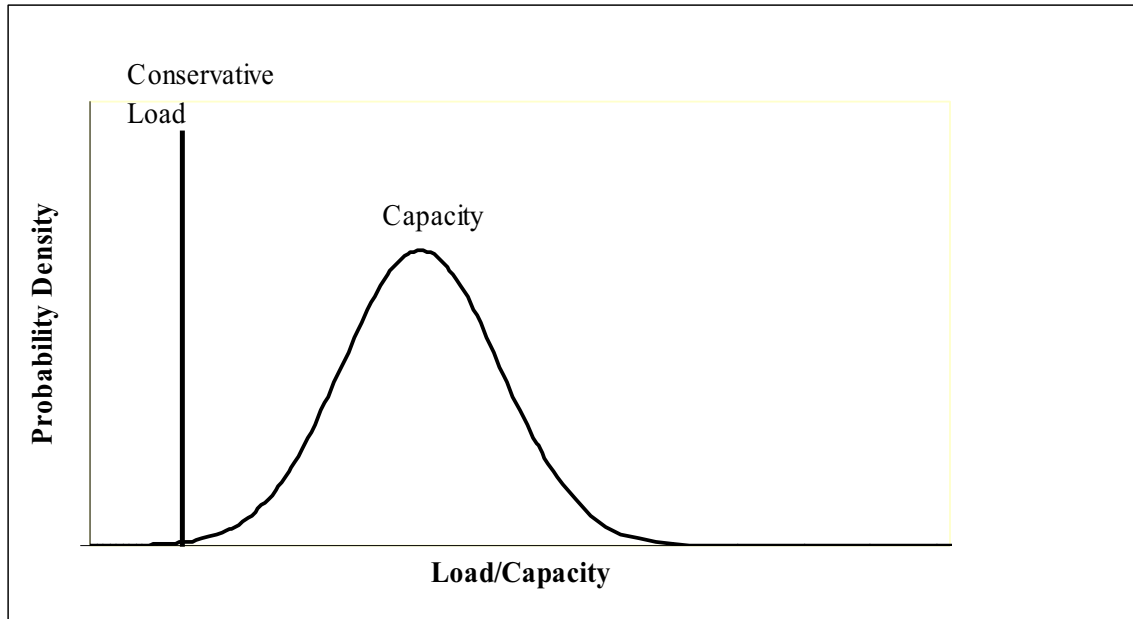

Source: Original

Figure 4.3-7. Point Estimate Load Approximation Used in PCSA

The PCSA applies point estimate load approximations (PELA) to a wide variety of event sequences including those associated with:

- Canister drops
- Canister collisions with other objects and structures
- Other objects dropped on canisters
- Transportation cask drops and subsequent sladdowns (analyzed without impact limiters)
- Conveyance derailments and collisions when carrying transportation casks and canisters (conveyances would be trucks, railcars, cask transfer trolley (CTT), and site transporters)
- Other objects dropped on transportation casks
- Waste package drops
- Waste package collision with other waste packages

- Transport and emplacement vehicle (TEV) collisions with structures and another TEV when carrying a waste package
- Objects dropped on waste packages
- Objects dropped on TEV.

Many of these, such as collisions, derailments, and objects dropped onto casks/canisters, involve far lower energy loads than drop events. For impact loads that are far less energetic than drops, the drop probability is ratioed by impact energy to estimate the less energetic situation.

Shielding Degradation Events

Impact loads (such as drops) may not be severe enough to breach a transportation cask, but might lead to degradation of shielding such that onsite nearby personnel are exposed.

The shielding degradation analysis is based primarily on results of finite-element modeling (FEM) performed for, four generic transportation casks types for transportation accidents as reported in *Reexamination of Spent Fuel Shipment Risk Estimates*. NUREG/CR-6672 (Ref. 2.2.86). The results of the FEM analysis were used to estimate threshold drop heights and thermal conditions at which loss of shielding (LOS) may occur in repository event sequences. The four cask types include one steel monolith rail cask, one steel/depleted uranium truck cask, one steel/lead/steel (SLS) truck cask and one SLS rail cask. The study performed structural and thermal analyses for both failure of containment boundaries and loss of shielding for accident scenarios involving rail cask and truck cask impacting unyielding targets at various impact speeds from 30 mph to greater than 120 mph. Impact orientations included side, corner, and end. The study also correlated the damage to impacts on real targets, including soil and concrete.

Reexamination of Spent Fuel Shipment Risk Estimates. NUREG/CR-6672 (Ref. 2.2.86) addresses two modes of shielding degradation in accident scenarios: Deformations of lid and closure geometry that permit direct streaming of radiation; and/or reductions in cask wall thickness, or relocation of the depleted uranium or lead shielding. The shielding degradation due to lid/closure distortion can be accompanied by air-borne releases if the inner shell of the cask is also breached.

The structural analyses do not credit the energy absorption capability of impact limiters. Therefore, the results are deemed applicable to approximate the structural response of transportation and similar casks in drop scenarios for the CRCF.

Principal insights reported in Ref. 2.2.86 are the following:

- Monolithic steel rail casks do not exhibit any shielding degradation, but there may be some radiation streaming through gaps in closures in any of the impact scenarios.

- Steel/depleted uranium/steel truck cask exhibited no shielding degradation, explained by modeling that included no gaps between forged depleted uranium segments so that no displacement of depleted uranium could occur.
- The SLS rail and truck casks exhibit shielding degradation due to lead slumping. Lead slump occurs mostly on end-on impact, with a lesser amount in corner orientation. For side-on orientation, there is no significant reduction in shielding.

Therefore, this analysis focuses on SLS casks to estimate the drop or collision conditions that could result in shielding degradation from lead slumping. Since it is not possible to predict at this time the fraction of casks to be delivered during the preclosure period that are of the steel-lead-steel type, all transportation casks are analyzed as described below.

The *Shipping Container Response to Severe Highway and Railway Accident Conditions*. NUREG/CR-4829 (Ref. 2.2.51) defines three levels of cask response, characterized by the maximum effective plastic strain within the inner shell of a transport cask. Of these, level S3 has strain levels between 2.0% and 30% which produces large distortions, seal leakage likely and lead slump likely. The minimum strain level associated with S3 was applied to the strain versus impact speed results from the FEM (Ref. 2.2.86) to establish a median threshold impact speed for the onset of shielding degradation. The threshold speeds are translated into equivalent drop heights, using calculated bottom corner drops for impact loads onto real concrete targets, not idealized rigid targets. Use of a conservative coefficient of variation coupled with the median, allowed a lognormal fragility curve as a function of drop height (or equivalently impact speed), to be developed. Each event sequence may be characterized by a conservative impact speed. For example, the maximum speed of onsite vehicles is 2.5 mph by design (with exception of 9 mph for the site prime mover) and a cask drop height of 15 feet is unlikely, by design, to be exceeded. Using Equation 4, the fragility curve was combined with the maximum or a conservative estimate of impact speed (or equivalent drop height).

Fire Events Associated with Possible Containment Breach

Fire initiated events are included in the PCSA, which probabilistically analyzes the full range of possible fires that can occur, as well as variations in the dynamics of the heat transfer and uncertainties in the failure temperature of the target. This analysis focuses on fires that might directly impact the integrity of cask, canister, and waste package containment. Equation 3 is used for this purpose. The fragility analysis includes the uncertainty in the temperature that containment is breached, and the uncertainty in the thermal response of the canister to the fire. In calculating the thermal response of the canister, variations in the intensity and duration of the fire are considered along with conditions that control the rate of heat transfer to the container, e.g., convective heat transfer coefficients, view factors, emissivities, etc. In calculating the failure temperature of the canister, variations in the material properties of the canister are considered, along with, variations in the loads that lead to failure. The load or demand is associated with uncertainty in the fire severity.

Fire severity is characterized by the fire temperature and duration, since these factors control the amount of energy that the fire could transfer to a cask, canister, or waste package. (In this analysis, these are referred to as targets.) The duration of the fire is taken to be the amount of

time a particular container is exposed to the fire, and not necessarily the amount of time a fire burns. Probability distributions of the fire temperature and fire duration are based on the unavailability of manual or automatic suppression, which leads to an assessment that significantly overstates the risk of fires.

4.3.2.2.1 Uncertainty in Fire Duration

An uncertainty distribution for the fire duration is developed by considering test data and analytical results reported in several different sources; some specific to the YMP facilities and some providing more generic information. In general, the fire durations are found to depend upon the amount, type, and configuration of the available combustible material.

Based on a review of the available information, it is determined that two separate uncertainty distributions would be needed: one for conditions without automatic suppression and one for conditions with automatic suppression. The derivation of these two distributions is discussed below.

Uncertainty in fire duration was developed from:

- *Utilisation of Statistics to Assess Fire Risks in Buildings* (Ref. 2.2.88)
- *Heat and Mass Release for Some Transient Fuel Source Fires: A Test Report*. NUREG/CR-4680 (Ref. 2.2.65)
- *Quantitative Data on the Fire Behavior of Combustible Material in Nuclear Power Plants: A Literature Review*. NUREG/CR-4679 (Ref. 2.2.66).

The derivation of the distribution of fire duration is described in Attachment D, Sections D2.1.1.2 and D2.1.1.3.

The fire temperature used in this calculation is the effective blackbody temperature of the fire. This temperature implicitly accounts for the effective emissivity of the fire, which for large fires approaches a value of 1.0 (Ref. 2.2.81, p. 2-56). Fires within a YMP facility may involve both combustible solid and liquid materials. A probability distribution for the fire temperature was derived by combining fire severity information for compartment fires discussed in *SFPE Handbook of Fire Protection Engineering* (Ref. 2.2.81, Section 2, Chapter 2) with information about liquid hydrocarbon pool fires. The derivation of this distribution is described in Attachment D, Section D2.1.2. The fire temperature is normally distributed with a mean of 1,072 K (799°C) and a standard deviation of 172 K. The mean of this distribution is approximately equal to the transportation cask design basis fire temperature of 800°C specified in 10 CFR 71.73 (c)(4) (Ref. 2.3.3).

Fire temperature and duration are negatively correlated. Intense fires with high fire temperatures tend to be short-lived because the high temperature results from very rapid burning of the combustible material. In determining the joint probability distribution of fire duration and temperature, a negative correlation coefficient of -0.5 was used (refer to Attachment D, Section D2.1.3).

The thermal response of the canister is calculated using simplified radiative, convective, and conductive heat transfer models, which have been calibrated to more precise models. The simplified models are found to accurately match predictions for heating of the canister in either a cask or waste package. The heat transfer models are simplified in order to allow a probabilistic analysis to be performed using Monte Carlo sampling. The models consider radiative and convective heat transfer from the fire to the canister, cask, waste package, or shielded bell. This analysis conservatively models the fire completely engulfing the container.

When calculating the heat load on the target for a fully engulfing fire, radiation is the dominant mode of heat transfer between the fire and the target. The magnitude of the radiant heating of the container depends on the fire temperature, the emissivity of the container, the view factor between the fire and the container, also the duration of the fire.

The total radiant energy deposited in the container can be roughly estimated using Equation 5:

$$Q_{rad} = \varepsilon F_{cf} \sigma (T_{fire})^4 A t \quad (\text{Eq. 5})$$

where

Q_{rad}	=	incident radiant energy over the fire duration (J)
ε	=	emissivity of the container
F_{cf}	=	container-to-fire view factor
σ	=	Stefan-Boltzmann constant ($\text{W}/\text{m}^2 \text{K}^4$)
T_{fire}	=	equivalent blackbody fire temperature (K)
A	=	container surface area (m^2)
t	=	duration of the fire (s)

The following variables in this equation are treated as uncertain: fire temperature, view factor, and fire duration. In the case of a canister inside a waste package, cask, or shielded bell, a more complicated set of equations is used to simulate outer shell heat up and subsequent heat transfer to layers of containment or shielding and then to the canister itself. The model also includes heating of the canister by decay heat from the spent fuel or high-level radioactive waste.

To estimate the uncertainty associated with target fragility, two failure modes were considered:

1. *Creep-Induced Failure.* Creep is the plastic deformation that takes place when a material is held at high temperature for an extended period under tensile load. This mode of failure is possible for long duration fires.
2. *Limit Load Failure.* This failure mode occurs when the load exerted on a material exceeds its structural strength. As the temperature of the canister increases in temperature, its strength decreases. Failure is generally predicted at some fraction (usually around 70%) of the ultimate strength.

Failure is considered to occur when either of the failure thresholds is exceeded.

Equation 3, along with the heat transfer equations, are solved using Monte Carlo simulation (described in Section 4.3.7) with the above described fragility and target fire severity probability distributions, and distributions for the uncertain heat transfer factors. For each Monte Carlo trial, the calculated maximum canister temperature is compared to the sampled target failure temperature. If the maximum temperature of the target exceeds the sampled failure temperature, then target failure is counted. The failure probability in this method is equal to the fraction of the samples for which failure is calculated.

Uncertainty in the calculated canister failure probability is given by a calculated mean and standard deviation, where the mean is simply the number of failures divided by the total number of samples and the standard deviation is given by Equation 6 for the standard deviation of a binomial distribution:

$$\sigma = \sqrt{\frac{\frac{n_{\text{fail}}}{N} \left(\frac{N - n_{\text{fail}}}{N} \right)}{N}} \quad (\text{Eq. 6})$$

where n_{fail} is the number of trials in which failure occurs and N is the total number of Monte Carlo trials.

Fire Event Associated with Shielding Degradation

The thermal analyses in *Reexamination of Spent Fuel Shipment Risk Estimates*. NUREG/CR-6672 (Ref. 2.2.86) indicates that the probability of shielding degradation in a fire scenario should be based on the probability of having a fire that is equivalent to a 1,000°C engulfing fire that lasts for more than a half-hour. However, shielding degradation does not occur unless there is a coincident puncture or breach in the cask that allows a pathway for melted lead to flow out of its usual configuration. These threshold conditions apply to all cask types and would result in radiation streaming from the cask.

The transportation cask is present within the YMP facilities in only three areas: vestibules, preparation rooms, and unloading rooms. The fire ignition frequencies of these areas are summed up in Section 6.5 and Attachment F. Furthermore, the method described above for obtaining the probability distribution of fire severity from input distributions of fire temperature and fire duration, resulted in an estimate of the conditional probability of the threshold fire given a fire ignition. This is a conservative calculation because it did not include the conditional probability that a puncture or failure through the wall to the lead shielding must also occur for shielding degradation.

Other Thermal Events Associated with Possible Breach

The PCSA focuses on the potential of cask, canister, and waste package breach associated with fires. As described above, the fires of most interest were those that surround the target containment. However, one heatup associated with loss of building cooling was also considered.

The analysis of loss of building cooling on containment integrity takes a similar, conservative, analytical approach. A bounding set of conditions and configurations are postulated, and then

using the ANSYS code (Ref. 2.2.16), the maximum steady state temperature is compared to the temperature at which the component would be expected to fail. In no case is a containment barrier found to be near its failure threshold from loss of building cooling.

4.3.3 Utilization of Industry-Wide Reliability Data

4.3.3.1 Use of Population Variability Data

The quantification of event sequence probabilities via event tree and fault tree modeling requires information on the reliability of active equipment and components, as usually represented in fault tree basic events. The PCSA attempts to anticipate event sequences before they happen, which means that associated equipment reliabilities are uncertain.

As presented in *Fault Tree Handbook* (Ref. 2.2.90, Figure X-8, p. X-23), the typical model of failure probability for a component is depicted as a “bathtub curve” illustrated in Figure 4.3-8. The curve is divided into three distinct phases. Phase I represents the component failure probability during the “burn-in” period. Phase II corresponds to the “constant failure rate function” where the exponential distribution can be applied to calculate the probability of failure within a specified “mission time.” Toward the end of the component life or the wear-out period, which is represented by Phase III of the curve; the probability of failure increases.

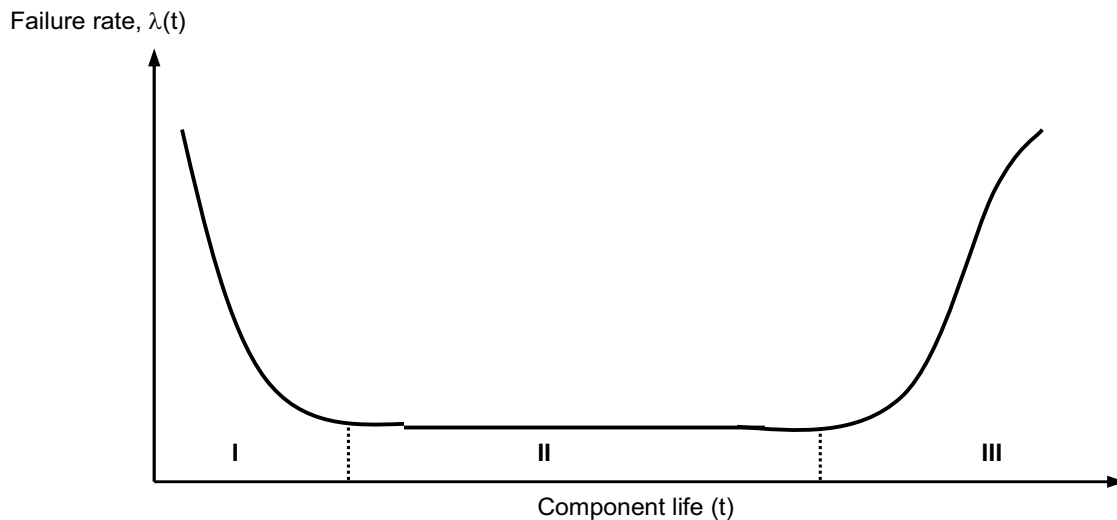

Source: Ref. 2.2.90, Figure X-8, p. X-23.

Figure 4.3-8. Component Failure Rate “Bathtub Curve” Model

As is usually done in PRA, the PCSA uses Phase II because Phase I failures are identified by burn-in testing of equipment before repository operations occur and Phase III failures are eliminated by preventive maintenance which includes manufacturer recommended replacement intervals. In Phase II, the component time-to-failure probability can be represented with the exponential distribution. The probability of failure of a given component (or system) depends on the value of the constant failure rate, λ , and the mission time, t_m , as follows in Equation 7:

$$P_F(\lambda, t_m) = 1 - \exp(-\lambda t_m) \quad (\text{Eq. 7})$$

When the product λt_m is small (<0.1), the failure probability may be calculated by the following Equation 8 approximation, which introduces less than a 10% error:

$$P_F(\lambda, t_m) \cong \lambda t_m \quad (\text{Eq. 8})$$

The PCSA also uses the concept of unavailability to estimate basic event probabilities. This applies to standby equipment such as the emergency diesel generators and fire suppression. The reliability theory assumes that after each test the component or system is “good as new” with a “resetting” of the time-to-failure “clock” for the exponential failure model. The unavailability factor is evaluated as the probability of failure during the time between tests, τ . The average unavailability factor, or failure on demand of the standby unit, q_d , is calculated as shown in Equation 9:

$$q_d(\lambda, \tau) = \frac{1}{2}(\lambda \tau) \quad (\text{Eq. 9})$$

In this model the component failure rate is constant between tests, the test does not require any time, and the test neither introduces another failure mode nor changes the failure rate of the component.

Failure on demand is also needed for equipment, such as cranes, that is challenged in discrete steps. This model is not based on time in service; it is based on the number of times the component or system is called upon to perform its safety function.

Information about hardware failure is characterized as one of the following:

1. Historical performance of successes and failures of an identical piece of equipment under identical environmental conditions and stresses that are being analyzed (e.g., operational experience).
2. Historical performance of successes and failures of an identical piece of equipment under conditions other than those being analyzed (e.g., test data).
3. Historical performance of successes and failures of a similar piece of equipment or similar category of equipment under conditions that may or may not be those under analysis (e.g., another program’s test data or data from handbooks or compilations).
4. General engineering or scientific knowledge about the design, manufacture, and operation of the equipment or an expert’s experience with the equipment.

The YMP repository has not yet operated, and test information on prospective equipment has not yet been developed. It is given that equipment and SSCs designed and purchased for the Yucca Mountain repository are of the population of equipment and SSCs represented in U.S. industry-wide reliability information sources (Assumption 3.2.1). Furthermore, the uncertainty in reliability is represented by the variability of reliabilities across this population. Attachment C contains the list of industry-wide reliability information sources used in the PCSA.

The lack of actual operating experience, the use of industry-wide data, and the consideration of uncertainties (Ref. 2.2.74) suggested that a Bayesian approach was appropriate for the PCSA. A Bayesian approach and the use of judgment in expressing the state-of-knowledge of basic event unreliability is a well-recognized and accepted practice (Ref. 2.2. 60, Ref. 2.2. 12, and Ref. 2.2. 68). Furthermore, to paraphrase *Interim Staff Guidance HLWRS-ISG-02, Preclosure Safety Analysis – Level of Information and Reliability Estimation* (Ref. 2.2. 74), reliability estimates for high reliability SSC may include the use of engineering judgment, supported by sufficient technical basis; and empirical reliability analyses of a SSC, could include values based on industry experience and judgment.

Let λ_j be one failure rate of a set of possible failure rates of a component and E be a new body of evidence. Knowledge of the probability of λ_j given E , is represented by $P(\lambda_j/E)$. For a failure rate, frequency, or probability of active equipment, Bayes' theorem is stated as follows in Equation 10:

$$P(\lambda_j / E) = \frac{P(\lambda_j)L(E / \lambda_j)}{\sum_j P(\lambda_j)P(E / \lambda_j)} \quad (\text{Eq. 10})$$

In summary, this states that the knowledge of the “updated” probability of λ_j , given the new information E , equals the “prior” probability of λ_j , before any new information, times the likelihood function, $L(E/\lambda_j)$. The likelihood function is a probability that the new information really could be observed, assuming that λ_j is the true failure rate. The numerator in Equation 10 is divided by a normalization factor, which must be such that the sum of the probabilities over the entire set of λ_j equals unity. If there is actual operational experience available, then the steps in an application of Bayes' theorem would be as follows: (1) estimate the prior probability using one or more of the four reliability data types; (2) obtain new information in the form of tests or experiments; (3) characterize the test information in the form of a likelihood function; and (4) perform the calculation in accordance with Equation 10 to infer the updated probability.

The PCSA used industry-wide reliability data to develop Bayesian prior distributions for each active equipment/component failure mode in the fault trees. Updates per Equation 10 will await actual test and operations. The following summarizes the methods used to develop the Bayesian prior distributions.

Using multiple reliability databases will typically cause a given active component to have various reliability estimates, each one from a different source. These various estimates can be viewed as independent samples from the same distribution, g , representing the source-to-source variability, also called population variability, of the component reliability (Ref. 2.2.12,

Section 8.1). In a Bayesian approach to reliability estimation, the population-variability distribution of a component constitutes an informative prior distribution for its reliability. The population-variability distributions developed in this analysis attempt to encompass the actual component reliability distributions that are observed at the GROA when operating experience becomes available.

A parametric empirical Bayes method is used to develop the population-variability distributions of active components considered in the PCSA. As indicated in “Bayesian Parameter Estimation in Probabilistic Risk Assessment.” (Ref. 2.2.82, Section 5.1.2), this method is a pragmatic approach that has been used in PRA-related applications; it involves specifying the functional form of the prior population-variability distribution, and fitting the prior to available data, using classical techniques, for example the maximum likelihood method. A discussion of the adequacy of the parametric empirical Bayes method for determining the population-variability distribution is given at the end of this section.

Applying the parametric empirical Bayes method requires first, to categorize the reliability data sources into two types: those that provide information on exposure data, (i.e., the number of failures that were recorded over an exposure time (in case of a failure rate)), or over a number of demands (in case of a failure probability), and those that do not provide such information. In the latter case, reliability estimates for a failure rate or failure probability are provided in the form of a mean or a median value, along with an uncertainty estimate, typically an error factor.

For each data source, the reliability information about a component’s failure rate or failure probability is mathematically represented by its likelihood function. If exposure data are provided, the likelihood function takes the form of a Poisson distribution (for failure rates), or a binomial distribution (for failure probabilities) (Ref. 2.2.82, Section 4.2). When no exposure data is available, the reliability estimates for failure rates or failure probabilities are interpreted as expert opinion, for which an adequate representation of the likelihood function is a lognormal distribution (Ref. 2.2.82, Section 4.4 and Ref. 2.2.58, pp. 312, 314, and 315).

The next step is to specify the form of the population-variability distribution. In its simplest form, the parametric empirical Bayes method only considers exposure data and employs distributions that are conjugate to the likelihood function (i.e., a gamma distribution if the likelihood is a Poisson distribution, and a beta distribution if the likelihood is binomial) (Ref. 2.2.12, Section 8.2.1), which have the advantage of resulting in relatively simpler calculations. This technique, however, is not applicable when both exposure data and expert opinion are to be taken into consideration, because no conjugate distribution exists in this situation. Following the approach of “The Combined Use of Data and Expert Estimates in Population Variability Analysis” (Ref. 2.2.58, Section 3.1), the population-variability distribution in this case is chosen to be lognormal. More generally, for consistency, the parametric empirical Bayes method is applied using the lognormal functional form for the population-variability distributions regardless of the type of reliability data available for the component considered (exposure data, expert opinion, or a combination of the two). In the rest of this section, the population-variability distribution in its lognormal form is noted $g(x, \nu, \tau)$, where x is the reliability parameter for the component (failure rate or failure probability), and ν and τ , the two unknowns to be determined, are respectively the mean and standard deviation of the normal distribution associated with the lognormal. The use of a lognormal distribution is

appropriate for modeling the population-variability of failure rates and failure probabilities, provided in the latter case that any tail truncation above $x = 1$ has a negligible effect (Ref. 2.2.82, p. 99). The validity of this can be confirmed by selecting the failure probability with the highest mean and the most skewed lognormal distribution and calculating what the probability is of exceeding one. In Table C4-1 of Attachment C, PRV-FOD fits this profile, with a mean failure probability of $6.54E-03$ and an error factor of 27.2. The probability that the distribution exceeds one is $2E-04$. Stated equivalently, 99.98% of the values taken by the distribution are less than one. This confirms that the use of a truncated lognormal distribution to represent the probability distribution is appropriate.

To determine ν and τ , it is first necessary to express the likelihood for each data source as a function of ν and τ only, (i.e., unconditionally on x). This is done by integrating, over all possible values of x , the likelihood function evaluated at x , weighted by the probability of observing x , given ν and τ . For example, if the data source i indicates that r failures of a component occurred out of n demands, the associated likelihood function $L_i(\nu, \tau)$, unconditional on the failure probability x , is as follows in Equation 11:

$$L_i(\nu, \tau) = \int_0^1 \text{Binom}(x, r, n) \times g(x, \nu, \tau) dx \quad (\text{Eq. 11})$$

where $\text{Binom}(x, r, n)$ represents the binomial distribution evaluated for r failures out of n demands, given a failure probability equal to x , and $g(x, \nu, \tau)$ is defined as previously indicated. This equation is similar to that shown in “Bayesian Parameter Estimation in Probabilistic Risk Assessment” (Ref. 2.2.82, Equation 37). If the component reliability is expressed in terms of a failure rate and the data source provides exposure data, the binomial distribution in Equation 11 would be replaced by a Poisson distribution. If the data source provided expert opinion only (no exposure data), the binomial distribution in Equation 11 would be replaced by a lognormal distribution.

The maximum likelihood method is an acceptable method to determine ν and τ (Ref. 2.2.82, p. 101). The maximum likelihood estimators for ν and τ are obtained by maximizing the likelihood function for the entire set of data sources. Given the fact that the data sources are independent, the likelihood function is the product of the individual likelihood functions for each data source (Ref. 2.2.58, Equation 4). To find the maximum likelihood estimators for ν and τ , it is equivalent and computationally convenient to maximize the log-likelihood function, which is the sum of the logarithms of the likelihood function for each data source.

The calculation of ν and τ completely determines the population-variability distribution g for the reliability of a given active component. The associated parameters to be plugged into SAPHIRE are the mean and the error factor of the lognormal distribution g , which are calculated using the formulas given in *Handbook of Parameter Estimation for Probabilistic Risk Assessment*. NUREG/CR-6823 (Ref. 2.2.12, Section A.7.3). Specifically, the mean of the lognormal distribution is equal to $\exp(\nu + \tau^2/2)$ and the error factor is equal to $\exp(1.645 \times \tau)$. A discussion of the adequacy of the empirical Bayes method for the YMP analysis is found in Attachment C.

An adjustment to the parametric empirical Bayes method was done in a few instances where the error factor of the calculated lognormal distribution was found to be excessive. In a synthetic examination of the failure rates of various components, “External Maintenance Rate Prediction and Design Concepts for High Reliability and Availability on Space Station Freedom” (Ref. 2.2.54, Figure 3) finds that electromechanical and mechanical components have, overall, a range of variation approximately between 2×10^{-8} /hr (5th percentile) and 6×10^{-5} /hr (95th percentile). Using the definition of the error factor given in *Handbook of Parameter Estimation for Probabilistic Risk Assessment. NUREG/CR-6823* (Ref. 2.2.12, Section A.7.3), this corresponds to an error factor of $\sqrt{6 \cdot 10^{-5} / 2 \cdot 10^{-8}} = 55$. Therefore, in the PCSA, it is considered that lognormal distributions resulting from the empirical Bayes method that yield error factors with a value greater than 55, are too diffuse to adequately represent the population-variability distribution of a component. In such instances (i.e., the two cases in the entire PCSA database when the error factors from the Bayesian estimation were greater than 200), the lognormal distribution used to represent the population-variability is modified as follows. It has the same median as that predicted by the parametric empirical Bayes method, and its error factor is assigned a value of 55. The median is selected as the unvarying parameter because, contrary to the mean, it is not sensitive to the behavior of the tails of the distribution, and therefore is unaffected by the value taken by the error factor. Based on NUREG/CR-6823 (Ref. 2.2.12, Section A.7.3), the median is calculated as $\exp(v)$, where v is obtained by the maximum likelihood estimation.

A limitation of the parametric empirical Bayes method that prevented its use for all active components of the PCSA is that the calculated lognormal distribution can sometimes have a very small error factor (with a value around 1), corresponding to a distribution overly narrow to represent a population-variability distribution. As indicated in NUREG/CR-6823 (Ref. 2.2.12, p. 8-4), this situation can arise when the reliability data sources provide similar estimates for component reliability. The inadequacy of the parametric empirical Bayes method in such situations is made apparent by plotting the probability density function of the lognormal distribution, and comparing it with the likelihood functions associated with the reliability estimates of each data source. In the cases where the lognormal distribution does not approximately encompass the likelihood functions yielded by the data sources, it is not used to model the population-variability distribution. Instead, this distribution is modeled using the data source that yields the most diffuse likelihood using one of the two methods described in the next paragraph.

To be developed, a population-variability distribution requires at least two data sources, and therefore the previous method is not applicable when only one data source is available. In this case, the probability distribution for the reliability parameter of an active component is that yielded by the data source. For example, if the data source provides a mean and an error factor for the component reliability parameter, the probability distribution is modeled in SAPHIRE as a lognormal distribution with that mean, and that error factor. If the data source does not readily provide a probability distribution, but instead exposure data, i.e., a number of recorded failures over an exposure time for failure rates, or over a number of demands for failure probabilities, the probability distribution for the reliability parameter is developed through a Bayesian update using Jeffreys’ noninformative prior distribution as indicated in NUREG/CR-6823 (Ref. 2.2.12,

Section 6.2.2.5.2). This noninformative prior conveys little prior belief or information, thus allowing the data to speak for itself.

4.3.3.2 Dependent Events

Dependent events have long been recognized as a concern for those responsible for the safe design and operation of high-consequence facilities because these events tend to increase the probability of failure of multiple systems and components. Two failure events, A and B, are dependent when the probability of their coincidental occurrence is higher than expected if A and B were each an independent event. Dependent events occur from four dependence mechanisms: functional, spatial, environmental, and human:

1. **Functional dependence** is present when one component or system relies on another to supply vital functions. An example of a functional dependence in this analysis is electric power supply to HVAC. Functional dependence is explicitly modeled in the event tree and fault tree logic.
2. **Environmental dependence** is in play when system functionality relies on maintaining an environment within designed or qualified limits. Here, an example is material property change as a result of temperature change. Environmental effects are modeled in the system reliability analyses as modifications (e.g., multiplying factors) to system- and component-failure probabilities and are also included in the passive equipment failure analyses. External events such as earthquakes, lightning strikes, and high winds that can degrade multiple SSCs are modeled explicitly as initiating events and are discussed in other documents (Ref. 2.2.34 and Ref. 2.4.4).
3. **Spatial dependence** is at work when one SSC fails by virtue of close proximity to another. For example, during an earthquake one SSC may impact another because of close proximity. Another example is inadvertent fire suppression actuation which wets SSCs below it. Spatial dependences are identified by explicitly looking for them in the facility layout drawings. Inadvertent fire suppression is modeled explicitly in the event trees and fault trees. Seismic interactions are modeled in *Seismic Event Sequence Quantification and Categorization* (Ref. 2.4.4) and *ITS SSC/Non-ITS SSC Interactions Analysis* (Ref. 2.4.1).
4. **Human dependence** is present when a SSC, or function fails because humans intervene inappropriately or failed to intervene. In the YMP, most human errors are associated with initiating events (inadvertent actuation) or are pre-initiator failures (failure to restore after maintenance). The PCSA includes an extensive human reliability analysis which is described later in this section, in Section 6.4 and in Attachment E. The results of the human reliability analysis (HRA) are integrated into the event tree and fault tree models for a complete characterization of event sequence frequency.

4.3.3.3 Common-cause Failures

Common-cause failures (CCFs) can result from any of the dependence mechanisms described above. The term common-cause failure is widely employed to describe events in which the same cause degrades the function of two or more SSCs that are relied upon for redundant operations, either at the same time or within a short time relative to the overall component mission time. Because of their significance to overall SSC reliability when redundancy is employed, CCFs are a special class of dependent failures that are addressed in the PCSA.

Because CCFs are relatively uncommon, it is difficult to develop a statistically significant sample from monitoring only one system or facility, or even several systems. The development of CCF techniques and data, therefore, rely on a national data collection effort that monitors a large number of nuclear power systems. Typically, the fraction of component failures associated with common causes leading to multiple failures ranges between 1% and 10% (Ref. 2.2.52, Ref. 2.2.63, and Ref. 2.2.59). This fraction depends on the component; level of redundancy (e.g., two, three, or four); duty cycle; operating and environmental conditions; maintenance interventions; and testing protocol, among others. For example, equipment that is operated in cold standby mode (i.e., called to operate occasionally on demand) with a large amount of preventive maintenance intervention tends to have a higher fraction of CCFs than systems that continuously run.

It is not practical to explicitly identify all CCFs in a fault tree or event tree. Surveys of failure events in the nuclear industry have led to several parameter models. Of these, three are most commonly used: the Beta Factor method (Ref. 2.2.52), the Multiple Greek Letter method (Ref. 2.2.61), and the Alpha Factor method (Ref. 2.2.63). These methods do not require an explicit knowledge of the dependence failure mode.

The PCSA uses the Alpha Factor method (Ref. 2.2.63) which is summarized below. After identifying potential CCF events from the fault trees, appropriate alpha factors are identified according to the procedure described in *Procedure for Analysis of Common-Cause Failures in Probabilistic Safety Analysis*. NUREG/CR-5801 (Ref. 2.2.62). The general equations for estimating the probability of a CCF event in which k of m components fail are as follows in Equation 12, Equation 13 and Equation 14:

$$Q(k,m) = \frac{k}{\binom{m-1}{k-1}} \alpha_k Q_t \quad \text{for staggered test} \quad (\text{Eq. 12})$$

$$Q(k,m) = \frac{k}{\binom{m-1}{k-1}} \frac{\alpha_k}{\alpha_t} Q_t \quad \text{for non-staggered test} \quad (\text{Eq. 13})$$

where α_k denotes the alpha factor for size k , Q_t denotes the total failure probability, and:

$$\alpha_t = \sum_{k=1}^m k \alpha_k \quad (\text{Eq. 14})$$

Generic alpha factors are used in the PCSA taken from NUREG/CR-5801 (Ref. 2.2.62). The process of applying these alpha factors is explained further in Attachment C, Section C3.

4.3.4 Human Reliability Analysis

Human interactions that are typically associated with the operation, test, calibration, or maintenance of a SSC (e.g., drops from a crane when using slings) are implicit in the empirical data. If this is the case, empirical data may be used, provided human errors that cause the SSC failures are explicitly enumerated and determined to be applicable to YMP operations. When this was the case in the PCSA, the appropriate method of Section 4.3.3.1 was applied. Otherwise, an HRA was performed, the methodology of which is summarized in this section. The HRA task is performed in a manner that implements the intent of the high-level requirements for HRA in *Standard for Probabilistic Risk Assessment for Nuclear Power Plant Applications* (Ref. 2.2.8) and incorporates the guidance in *Pre-closure Safety Analysis – Human Reliability Analysis* (Ref. 2.2.75). It emphasizes a comprehensive qualitative analysis and uses applicable quantitative models.

The HRA task identifies, models, and quantifies HFES postulated for YMP operations to assess the impact of human actions on event sequences modeled in the PCSA. YMP operations differ from those of traditional nuclear power plants, and the HRA reflects these differences. Appendix E.IV of Attachment E includes further discussion of these differences and how they influence the choice of methodology.

The overall steps to the PCSA HRA are identification of HFES, preliminary analysis (screening), and detailed analysis. The HRA task ensures that the HFES identified by the other tasks (e.g., HAZOP evaluation, MLD development): (1) are created on a basis that is consistent with the HRA techniques used, (2) are appropriately reincorporated into the PCSA (modeled HFES derived from the previously mentioned PCSA methods), and (3) provide appropriate human error probabilities (HEPs) for all modeled HFES. The HRA work scope largely depends on boundary conditions defined for it.

4.3.4.1 HRA Boundary Conditions

Unless specifically stated otherwise, the following general conditions and limitations are applied throughout the HRA task. The first two conditions always apply. The remaining conditions apply unless the HRA analyst determines that they are inappropriate. This judgment is made for each individual action considered:

1. Only HFES made in the performance of assigned tasks are considered. Malevolent behaviors (e.g., deliberate acts of sabotage) are not considered in this task.
2. All personnel act in a manner they believe to be in the best interests of operations and safety. Any intentional deviation from standard operating procedures is made because employees believe their actions to be more efficient or because they believe the action as stated in the procedure to be unnecessary.

3. Since the YMP is currently in the design phase, facility-specific information and operating experience is generally not available. Instead, similar operations involving similar hazards and equipment are reviewed to establish surrogate operating experience to use in the qualitative analysis. Examples of reviewed information would include SNF handling at reactor sites having independent spent fuel storage installations (ISFSIs), chemical munitions handling at U.S. Army chemical demilitarization facilities, and any other facilities whose primary function includes handling and disposal of very large containers of extremely hazardous material. Equipment design and operational characteristics at the GROA facilities, once they are built and operating (including crew structures, training, and interactions), are adequately represented by these currently operating facilities.
4. The YMP is initially operating under normal conditions and is designed to the highest quality human factor specifications. The level of operator stress is optimal unless the analyst determines that the human action in question cannot be accommodated in such a manner as to achieve optimal stress.
5. In performing the operations, the operator does not need to wear protective clothing unless it is an operation similar to those performed in other comparable facilities where protective clothing is required.
6. The tasks are performed by qualified personnel, such as operators, maintenance workers, or technicians. All personnel are certified in accordance with the training and certification program stipulated in the license. They are to be experienced and have functioned in their present positions for a sufficient amount of time to be proficient.
7. The environment inside each YMP facility is not adverse. The levels of illumination and sound and the provisions for physical comfort are optimal. Judgment is required to determine what constitutes optimal environmental conditions. The analyst makes this determination, and documents, as part of the assessment of performance influencing factors, when there is a belief that the action is likely to take place in a suboptimal environment. Regarding outdoor operations onsite, similar judgments must be made regarding optimal weather conditions.
8. While all personnel are trained to procedures, and procedures exist for all work required, the direct presence and use of procedures (including checklists) during operation is generally restricted to actions performed in the control room. Workers performing skill-of-craft operations do not carry written procedures on their person while performing their activities.

These factors are evaluated qualitatively for each situation being analyzed.

4.3.4.2 HRA Methodology

The HRA consists of several steps that follow the intent of ASME RA-S-2002, *Standard for Probabilistic Risk Assessment for Nuclear Power Plant Applications* (Ref. 2.2.8) and the process guidance provided in *Technical Basis and Implementation Guidelines for Technique for Human Event Analysis (ATHEANA)* NUREG-1624 (Ref. 2.2.72). The step descriptions are based on the

ATHEANA documentation, with some passages taken essentially verbatim and others paraphrased to adapt material that is based on nuclear power plants (NPPs) to the YMP facilities. Additional information is available in the ATHEANA documentation (Ref. 2.2.72, Section 10.3), providing an overview of the method for incorporating HFEs into a PRA. Figure 4.3-9 illustrates this integration method.

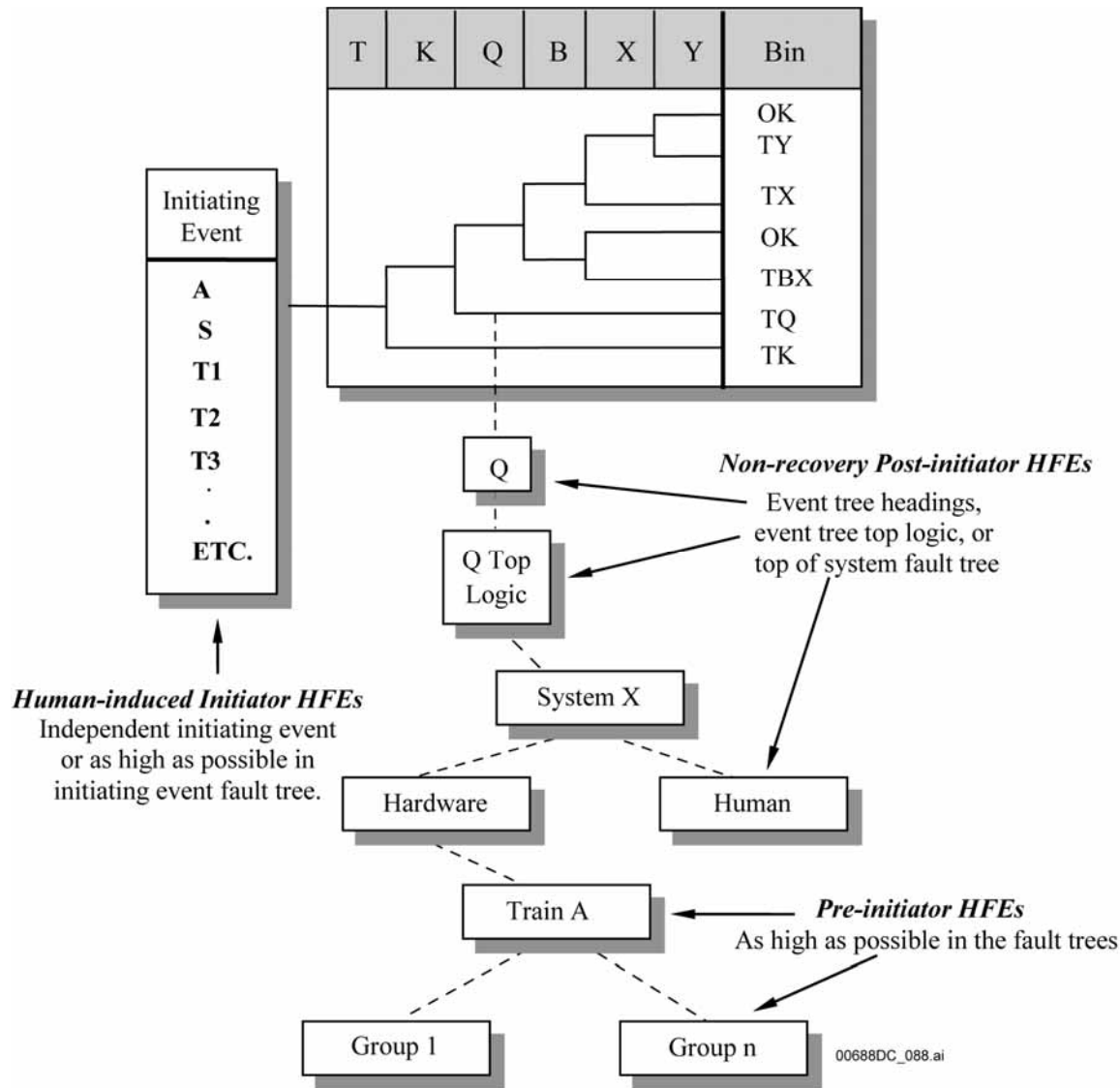

NOTE: HFE = human failure event.

Source: Original

Figure 4.3-9. Incorporation of Human Reliability Analysis within the PRA

Step 1: Define the Scope of the Analysis—The objective of the YMP HRA is to provide a comprehensive qualitative assessment of the HFEs that can contribute to the facility’s event sequences resulting in radiological release, criticality, or direct exposure. Any aspects of the work that provide a basis for bounding the analysis are identified in this step. In the case of the YMP, the scope is bounded by the design state of the facilities and equipment.

Step 2: Describe Base Case Scenarios—In this step, the base case scenarios are defined and characterized for the operations being evaluated. In general, there is one base case scenario for each operation included in the model. The base case scenario represents the most realistic description of expected facility, equipment, and operator behavior for the selected operation.

Step 3: Identify and Define HFEs of Concern—Possible HFEs and/or unsafe actions (i.e., actions inappropriately taken or actions not taken when needed) that result in a degraded state are generally identified and defined in this step. After HFEs are identified they must be classified to support subsequent steps in the process. The result of this identification process is a list of HFEs and a description of each HFE scenario, including system and equipment conditions and any resident or triggered human factor concerns (e.g., performance-shaping factors (PSFs)). This combination of conditions and human factor concerns then become the error-forcing context (EFC) for a specific HFE. As defined by ATHEANA (Ref. 2.2.72), an EFC is the situation that arises when particular combinations of PSFs and plant conditions create an environment in which unsafe actions are more likely to occur. Additions to and refinements of these initial EFCs are made during the preliminary and detailed analyses. The analyses performed in later steps (e.g., Steps 6 and 7) may identify the need to define additional HFEs or unsafe actions.

Step 4: Perform Preliminary Analysis and Identify HFEs for Detailed Analysis—The preliminary analysis is a type of screening analysis used to identify HFEs of concern. This type of analysis is commonly performed in HRA to conserve resources for those HFEs that are involved in the important event sequences. The preliminary quantification process consists of the following subtasks:

1. Identification of the initial scenario context
2. Identification of the key or driving factors of the scenario context
3. Generalization of the context by matching it with generic, contextually anchored rankings or ratings
4. Discussion and justification of the judgments made in subtask 3
5. Refinement of HFEs, associated contexts, and assigned HEPs
6. Determination of final preliminary HEP for HFE and associated context.

Once preliminary values have been assigned, the model is run, and HFEs are identified for a detailed analysis if (1) the HFE is a risk-driver for a dominant sequence, and (2) using the preliminary values, that sequence is Category 1 or Category 2 according to the performance objectives in 10 CFR Part 63.111 (Ref. 2.3.2).

Step 5: Identify Potential Vulnerabilities—This information collection step defines the context for Step 6 in which scenarios that deviate from the base case are identified. In particular, analysts search for potential vulnerabilities in the operators' knowledge and information base for the initiating event or base case scenario(s) under study that might result in the HFEs and/or unsafe actions identified in Step 4. The knowledge and information base is taken in the context of the specific HFE being evaluated. It includes not only the internal state of knowledge of the

operator (i.e., what the operator inherently knows), but also the state of the information provided (e.g., available instrumentation, plant equipment status). The HRA analysts rely on experience in other similar operations.

Step 6: Search for HFE Scenarios—In this step, the analyst must identify deviations from the base case scenario that are likely to result in risk-significant unsafe action(s). These deviations are referred to as HFE scenarios. The method for identifying HFE scenarios in the YMP HRA is stated in Step 3. This process continues throughout the event sequence development and quantification. The result is a description of HFE scenarios, including system and equipment conditions, along with any resident or triggered human factor concerns (e.g., PSFs). These combinations of conditions and human factor concerns then become the EFC for a specific HFE.

Step 7: Quantify Probabilities of HFEs—Detailed HRA quantification is performed for those HFEs that appear in dominant cut sets for event sequences that do not comply with 10 CFR 63.111 performance objectives (Ref. 2.3.2) after initial fault tree or event sequence quantification. The goal of the detailed analysis is to determine whether or not the preliminary HFE quantification is too conservative such that event sequences can be brought into compliance by a more realistic HRA. However, the detailed analysis may result in a requirement for additional design features or specification of a procedural control (Step 9) that reduces the likelihood of a given HFE in order to achieve compliance with 10 CFR 63.111 performance objectives (Ref. 2.3.2). The activities of a detailed HRA are as follows:

- Qualitative analysis (e.g., identification of PSFs, definitions of important characteristics of the given unsafe action, assessment of dependencies)
- Selection of a quantification model
- Quantification using the selected model
- Verification that HFE probabilities are appropriately updated in the PCSA.

The four quantification approaches that are in the PCSA, either alone or in combination, follow:

1. CREAM (Ref. 2.2.56)
2. HEART/NARA (Ref. 2.2.42)
3. THERP (with some modifications) (Ref. 2.2.87)

When an applicable failure mode cannot be reasonably found in one of the above methods, then the following HRA method is used:

4. ATHEANA expert elicitation approach (Ref. 2.2.72).

The selection of a specific quantification method for the failure probability of an unsafe action(s) is based upon the characteristics of the HFE quantified. Appendix E.IV of Attachment E provides a discussion of why these specific methods were selected for quantification, as well as a discussion of why some methods, deemed appropriate for HRA of NPPs, are not suitable for

application in the PCSA. It also gives some background about when a given method is applicable based on the focus and characteristics of the method.

Step 8: Incorporate HFEs into PCSA—After HFEs are identified, defined, and quantified, they must be reincorporated into the PCSA. Section 10.3 of NUREG-1624 (Ref. 2.2.72) provides an overview of the state-of-the-art method for performing this step in PRAs. The term reincorporated is used because some HFEs are identified within the fault tree and event tree analysis. All event sequences that contain multiple HFEs are examined for possible dependencies. Figure 4.3-9 shows how the different types of HFEs discussed previously are incorporated into the model based on their temporal phase, which determines where in the model each type of HFE is placed. More detailed discussion of how this is done is provided in Attachment E.

Step 9: Evaluation of HRA/PCSA Results and Iteration with Design—This last step in the HRA is performed after the entire PCSA is quantified. HFEs that ultimately prove to be important to categorization of event sequences are identified. Because the YMP design and operations were still evolving during the course of this analysis, they could be changed in response to this analysis. This iteration is particularly necessary when an event sequence is not in compliance with the performance objectives of 10 CFR 63.111 (Ref. 2.3.2) because the probability of a given HFE dominates the probability of that event sequence. In those cases, a design feature or procedural safety control could be added to reduce the probability or completely eliminate the HFE. An example of such iteration includes the interlocks that ensure that cask lids are securely grappled. The interlocks might have a bypass feature when a yoke is attached to a grapple. An operator might fail to void the bypass when attempting to grapple a heavy load. The design changed such that the bypass would automatically be voided (by an electromechanical interlock) as soon as a yoke is attached to a grapple.

4.3.4.3 Classification of HFEs

HFEs are classified to support the HRA preliminary analysis, selection of HRA quantification methods, and detailed quantification. A combination of four classification schemes is used in the YMP HRA. The first three schemes are familiar standards in HRA. The fourth scheme has its basis in behavioral science and has been used in some second-generation HRA methods. The four classification schemes are as follows:

1. The three temporal phases used in PRA modeling:
 - A. Pre-initiator
 - B. Human-induced initiator
 - C. Post-initiator
2. Error modes:
 - A. Errors of omission (EOOs)
 - B. Errors of commission (EOCs)

3. Human failure types:
 - A. Slips/lapses
 - B. Mistakes
4. Informational processing failures:
 - A. Monitoring and detection
 - B. Situation awareness
 - C. Response planning
 - D. Response implementation.

These classification schemes are used in concert with each other. They are not mutually exclusive. The first three schemes have been standard PRA practice; additional information on these three schemes can be found in Section E5.1 of Attachment E. The fourth scheme is summarized below.

Assessment of HFEs can be guided by a model of higher-level cognitive activities, such as an information processing model. Several such models have been proposed and used in discussing pilot performance for aviation. The model that is used for the YMP HRA is based on the discussion in Chapter 4 of NUREG-1624 (Ref. 2.2.72) and consists of the following elements:

- Monitoring and detection—Both of these activities are involved with extracting information from the environment. Also, both are influenced by the characteristics of the environment and the person's knowledge and expectations. Monitoring that is driven by the characteristics of the environment is called data-driven monitoring. Monitoring initiated by a person's knowledge or expectations is called knowledge-driven monitoring. Detection can be defined as the onset of realization by operators that an abnormal event is happening.
- Situation awareness—This term is defined as the process by which operators construct an explanation to account for their observations. The result of this process is a mental model, called a situation model that represents the operator's understanding of the present situation and their expectations for future conditions and consequences.
- Response planning—This term is defined as the process by which operators decide on a course of action, given their awareness of a particular situation. Often (but not always) these actions are specified in procedures.
- Response implementation—This term is defined as the activities involved with physically carrying out the actions identified in response planning.

When there are short time frames for response and the possibility of severely challenging operating conditions (e.g., environmental conditions) exists, then failures in all information processing stages must be considered. Also, slips/lapses and mistakes are considered for each information processing stage. Response implementation failures are expected to dominate the pre-initiator failures that are modeled. Post-initiator failures and failures that initiate event

sequences can occur for all information processing stages, although detection failures are likely to be important only for events requiring response in very short time frames.

4.3.5 Fire Analysis

Fire event sequence analysis consists of four parts:

1. Development of fire ignition frequencies for each location in the facility or operations area. These are all called fire initiating event frequencies.
2. Development of the fire severity in terms of both temperature and durations. This was discussed in Section 4.3.2.
3. Development of the conditional probability of fire damaging a cask, canister, or waste package target. This was also discussed in Section 4.3.2.
4. Development of and quantification of fire event sequence diagrams and event trees. Development of the ESDs and event trees was discussed in the *Canister Receipt and Closure Facility Event Sequence Development Analysis* (Ref. 2.2.33). Quantification of fire event trees is conducted exactly like quantification of any other event tree and is described in Section 4.3, Section 4.3.1, and Section 4.3.7.

This section summarizes the method for the fire initiating event analysis performed as a part of the PCSA. The analysis was performed as part of an integrated analysis of internal fires in the surface and subsurface facilities. The full fire analysis and detail on the methods and data are documented in Attachment F to this volume. The fire analysis is subject to the boundary conditions described in the following section.

4.3.5.1 Boundary Conditions

The general boundary conditions used during the fire analysis are compatible with those described in Section 4.3.10. The principal boundary conditions for the fire analysis are listed below:

- Plant Operational State. Initial state of the facility is normal with each system operating within its limiting condition of operation limits.
- Number of Fire Events to Occur. The facility is analyzed to respond to one fire event at a given time. Additional fire events as a result of independent causes or of re-ignition once a fire is extinguished are bounded by the one fire event.
- Ignition Source Counting. Ignition sources are counted in accordance with applicable counting guidance contained in *Detailed Methodology, Volume 2 of EPRI/NRC-RES Fire PRA Methodology for Nuclear Power Facilities* NUREG/CR-6850 (Ref. 2.2.49).
- Fire Cable and Circuit Failure Analysis. Unlike nuclear power plants, which depend on the continued operation of equipment to prevent fuel damage, the YMP facilities cease operating on loss of power or control. Therefore, fire damage in rooms that do not

contain waste cannot result in an increased level of radiological exposure. See Section 6.0 for a more detailed explanation involving treatment of loss of electrical power.

- HVAC Fire Analysis. HVAC is not relied upon to mitigate potential releases associated with fire event sequences in recognition that a large amount of fire generated, non-radiological particulates could render the HVAC filters ineffective.
- No Other Simultaneous Initiating Events. The facility is analyzed to respond to one initiating event at a given time. Additional initiating events as a result of independent causes are bounded by the one initiating event.
- Data Collection Scope. The fire ignition data collection and analysis are performed for locations relevant to waste handling in the facilities.
- Component Failure Modes. The failure mode of a SSC affected by a fire is the most severe with respect to consequences. For example, the failure mode for a canister could be the overpressurization of a reduced strength canister.
- Component Failure Probability. Fires large enough to fail waste containment components are large enough to fail all active components in the same room. Active components fail in a de-energized state for such fires.

4.3.5.2 Analysis Method

Nuclear power plant fire risk assessment techniques have limited applicability to facilities such as the CRCF or other facilities in the GROA. The general methodological basis of the PCSA fire analysis is the *Chemical Agent Disposal Facility Fire Hazard Assessment Methodology* (Ref. 2.2.79). Chemical agent disposal facilities are similar to those in the GROA in that these facilities are handling and disposal facilities for highly hazardous materials. This is a “data based” approach in that it utilizes actual historical experience on fire ignition and fire propagation to determine fire initiating event frequencies. That approach has been adapted to utilize data applicable to the YMP waste handling facilities. To the extent applicable to a non-reactor facility, *EPRI/NRC-RES Fire PRA Methodology for Nuclear Power Facilities*. NUREG/CR-6850: Volumes 1 and 2 (Ref. 2.2.49 and Ref. 2.2.50) are also considered in the development of this analysis method. The method complies with the applicable requirements of *Fire PRA Methodology* (Ref. 2.2.5) that are relevant to a non-reactor facility. The steps in the analysis are summarized below and described in detail in Attachment F, Section F4.

- A. Identification of initiating events. Current techniques in fire risk assessment for nuclear power plants focus on fire that can damage electrical and control circuits or impact other equipment that can compromise process and safety systems. This type of approach is not generally applicable to YMP because loss of electric power is a safe state except for the need for HVAC after a release of radionuclides. In general, when systems are affected by fire, they cease to function. While at a nuclear power plant this is of concern, as described in Section 6.0 for YMP waste handling facilities, this means that fuel handling stops and initiating events capable of producing elevated

levels of radioactivity are essentially unrealizable. The fire analysis, therefore, focused on the potential for a fire to directly affect the waste containers and cause a breach that would result in a release, rather than analyzing fires that would remove power from fuel handling systems. After a release of radionuclides, the HVAC system, with its HEPA filtration, aids in the abatement radioactivity that is released from buildings. However, the occurrence of fires tends to significantly reduce the effectiveness of HEPA filtration and the fire event sequence analysis, therefore, does not rely on this system. Consideration is given both to fires that start in rooms containing waste and fires that start in other rooms and propagate to where the waste is located. The four steps of this process are as follows:

1. Identify fire-rated barriers and designate fire zones. The facility is broken into fire zones based on the location of fire-rated barriers. The rating of the barriers is not significant to the methodology, so barriers of all ratings are considered. In order for a fire zone to exist, the penetrations, doorways, and ducts must also be limited to the perimeter of the zone. Note that a floor is always considered to be a fire barrier as long as it is solid. Zones are identified by a number, determined by the analyst, and will consist of one or more rooms.
2. Identify the rooms where waste can be present. Each room where waste can be present, even if only for a brief time, is listed. The first set of fire initiating events to be considered in the PCSA is fires that affect each of these rooms, but do not affect other rooms that could contain waste.
3. Define local initiating events. Fire ignition occurrences are identified for each room within a fire zone. The total occurrences of a fire within a room containing a waste form is composed of the occurrences of ignitions in that room plus the occurrences of ignitions in surrounding rooms, within the fire zone, which propagate across room boundaries to the room containing the waste form. The locations of fire initiating events were identified in the MLD (Ref. 2.2.33).
4. Define large fire initiating events. Traditional fire risk studies for nuclear power plants have tended to ignore large fires, arguing that the fire barriers in place will prevent such occurrences. However, actual observed historical data shows that large fires in buildings occur. Large fires are defined for this study as those that spread to encompass the entire building. This is recognized in the latest fire risk guidance from the NRC and Electric Power Research Institute (EPRI) (Ref. 2.2.49, Section 11.5.4) in which potential large fire initiating events are identified. The general approach is as follows:
 - a) In the YMP facilities waste containers, except during the short time they are being lifted by a canister transfer machine (CTM), are on the ground floor. Continuing with the focus on rooms that contain waste forms, large fires may be divided two ways. One is associated with fires that start on the ground floor and spread to the entire building and the other is a fire that starts anywhere else in the building.

- b) As a practical analysis technique, any fire that spreads out of a fire area is considered a large fire.
- B. Quantification of fire ignition frequency. The quantification of initiating event frequency involves three steps. First, the overall frequency of fire ignition for the facility is determined, then that frequency is allocated to the individual room in the facility based on the number and types of ignition sources in the rooms. Types of ignition sources are characterized in general terms such as mechanical, electrical, combustible liquid. Finally, propagation probabilities are applied to determine the overall frequency that a fire reaches the area of the waste. Quantification uses data from the following sources for equipment ignition frequencies and conditional probabilities of propagation:
1. *Utilisation of Statistics to Assess Fire Risks in Buildings* (Ref. 2.2.88).
 2. *Summary & Overview*. Volume 1 of *EPRI/NRC-RES Fire PRA Methodology for Nuclear Power Facilities*. EPRI-1011989 and NUREG/CR-6850 (Ref.2.2.50).
 3. *Detailed Methodology*. Volume 2 of *EPRI/NRC-RES Fire PRA Methodology for Nuclear Power Facilities*. EPRI TR-1011989 and NUREG/CR-6850 (Ref. 2.2.49).
 4. *Fires in or at Industrial Chemical, Hazardous Chemical, and Plastic Manufacturing Facilities: 1988 – 1997 Unallocated Annual Averages and Narratives* (Ref. 2.2.1).
 5. *Structure Fires in Radioactive Material Working Facilities and Nuclear Energy Plants of Non-Combustible Construction*. (Ref. 2.2.2).
 6. *Chemical Agent Disposal Facility Fire Hazard Assessment Methodology* (Ref. 2.2.79).
- C. Determine initiating event frequency. The definition of each initiating event includes the implicit condition that the fire actually threatens a target that contains radioactive material. Therefore, for each initiating event, the initiating event frequency considers two aspects: the fraction of time there is a waste container in the room, and the probability of a fire propagates to that waste container. The probability of the presence of a target waste form is the fraction of time that the waste form(s) is in the area affected by the fire; (e.g., for a room fire, it is the fraction of time a waste form is in the room). There are two types of propagation that are considered: propagation within a room and propagation between rooms.
1. Fire propagation within rooms. The question is whether the fire, which can ignite wherever there is an ignition source in the room, reaches the area within the room in which the waste is located. Equation 15 obtains:

$$f_{ier-i} = P_{wri} [f_i (FR_a + (FR_n \times (P_{pc} + P_{rc})) + (FR_f \times P_{rc}))] \quad (\text{Eq. 15})$$

where

- f_{ier-i} = frequency of fire affecting waste form, i-th room
- P_{wri} = probability that a waste form is in the i-th room
- f_i = frequency of ignition, i-th room
- FR_a = fraction of ignition sources at the waste form
- FR_n = fraction of ignition sources near the waste form
- P_{pc} = conditional probability for fire confined to part of room of origin
- FR_f = fraction of ignition sources far from the waste form
- P_{rc} = conditional probability for fire confined to room of origin

The values for P_{wri} , P_{pc} , and P_{rc} in the previous equation were developed from the analysis performed by National Fire Protection Association (NFPA) (Ref. 2.2.2). The frequency f_i is the sum of frequencies of ignition of all ignition sources in the room. The fraction of ignition sources at, near, and far from the waste form was developed from equipment layout drawings such as:

- a) *Canister Receipt Closure Facility #1 ITS Train "A" Electrical Room Equipment Layout* (Ref. 2.2.18).
 - b) *Canister Receipt and Closure Facility 1 General Arrangement Ground Floor Plan* (Ref. 2.2.32).
2. Fire propagation to large fire. The probability of a large fire (defined for this study as one that propagates beyond the fire area of origin) is developed from Equation 16:

$$f_{ief-fj-ri} = f_i \times P_{fc} \quad (\text{Eq. 16})$$

where

- $f_{ief-fj-ri}$ = frequency of fire in zone j starting in room i
- f_i = frequency of ignition, i-th room
- P_{fc} = conditional probability for fire extending beyond the fire area of origin.

The probability of a fire extending beyond the fire area of origin is found from NFPA (*Structure Fires in Radioactive Material Working Facilities and Nuclear Energy Plants of Non-Combustible Construction*, 1980-1998 (Ref. 2.2.2)).

The final initiating event frequency is determined by multiplying the frequency of the fire reaching the waste form (in occurrences per year) times the probability that a waste form is present (fraction of time per waste form) times 50 (years/operating lifetime during the preclosure period). This yields the initiating event frequency for a fire of a specific severity affecting a waste form, per waste form processed, over the preclosure period. The remainder of the event sequence quantification follows in Section 4.3.6.

4.3.6 Event Sequence Quantification

4.3.6.1 Overview of Quantification

Event sequences are represented by event trees and are quantified via the product of the initiating event frequency and the pivotal event probabilities. Event sequences that lead to a successful end state (designated as “OK”) are not considered further. The result of quantification of an event sequence is expressed in terms of the number of occurrences over the preclosure period. This number is the product of the following factors:

1. The number of demands (sometimes called trials) or the time exposure interval of the operation or activity that gives rise to the event sequence. For example, this could be the total number of transfers of a cask in a facility preparation area.
2. The frequency of occurrence per demand or per time interval of the initiating event. For example, this could be the frequency of cask drop per transfer by a crane. Initiating event frequencies are developed either using fault trees or by direct application of industry-wide data, as explained in Section 4.3.2. Factors one and two are represented in the initiator event trees.
3. The conditional probability of each of the pivotal events of the event sequence, which appear in the associated system-response event tree. These probabilities are the results of a passive equipment failure analyses, fault tree analyses (e.g., HVAC), and direct probability input (e.g., moderator introduced), or judgment. For example, the conditional probability of cask failure given a drop from 12 ft or less is less than 1E-05.

SAPHIRE Version 7.26 (Section 4.2) is used as the integrating software for the Boolean reduction and quantification of event sequences. All fault trees and event trees are entered into or produced directly in SAPHIRE. All reliability information relevant to quantification is input into SAPHIRE. Following analyst input instructions or rules, SAPHIRE performs the following functions for this analysis:

- Following analyst instructions, links the initiator event tree with the appropriate system response event tree.
- Following analyst instructions, called rules, links the fault trees and direct pivotal event input probabilities that are involved in an event sequence.
- Performs the Boolean manipulations to obtain minimal cut sets.

- Combines the minimal cut sets of each event sequence and each end state.
- Combines the minimal cut sets of each end state of all little bubbles to obtain the set of minimal cut sets of an end state for a big bubble initiating event.
- Obtains a point estimate number of occurrences of the minimal cut sets using the entered reliability information.
- Obtains the probability distributions of the minimal cut sets using the entered uncertainty information.
- Provides reports, as specified by the analyst, for each end state of each big bubble.

Development of analyst instructions, or rules, is facilitated by the following naming convention. The names identified in the initiating event fault trees are defined to be unique to the event tree. Fault trees are linked by development of a linking fault tree to transfer the appropriate fault tree to the event tree pivotal event or initiating event. Figure 4.3-10 shows an example of this. ESD15-WP-HD-TILT is the unique identifier that is assigned to the initiating event tree to represent the initiating event for a premature WPTT tiltdown. The benefit to using this method is that many smaller, specific fault trees can be linked together into a single initiating or pivotal event, thereby reducing the work associated with development of event sequence specific fault trees.

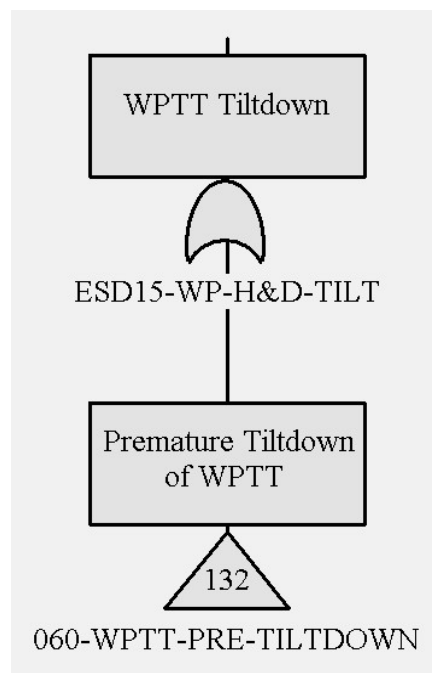

NOTE: WPTT = waste package transfer trolley.

Source: Original

Figure 4.3-10. Transfer from Event Tree to Fault Tree

The frequency of each minimal cut set is the product of the frequency and conditional probabilities of the events that compose it. The frequency of each event sequence is a probabilistic sum of the frequencies of each minimal cut set.

SAPHIRE, developed by Idaho National Laboratory, stands for “Systems Analysis Programs for Hands-on Integrated Reliability Evaluations.” It is 32-bit software that runs under Microsoft Windows. Features of SAPHIRE that help an analyst build and quantify a set of event trees and fault trees are as follows:

- A listing of where a basic event appears, including within cut sets. Conversely, the basic events that are *not* used are known and can be easily removed when it comes time to “clean” the database.
- Context-driven menu system that performs actions (report cut sets, view importance measures, display graphics, etc.) on objects such as fault trees, event trees, and event sequences.

Fault trees can be constructed and analyzed to obtain different measures of system unreliability. These system measures are:

- Overall initiating or pivotal event failure frequency
- Minimal cut sets size, number, and frequency
- Built in features include:
 - Generation, display, and storage of cut sets
 - Graphical editors (fault tree and event tree)
 - Database editors
 - Uncertainty analysis
 - Data Input/Output via ASCII text files (MAR-D)
 - Special seismic analysis capability.

SAPHIRE is equipped with two uncertainty propagation techniques: Monte Carlo and Latin Hypercube sampling. To take advantage of these sampling techniques, twelve uncertainty distributions are built such that the appropriate distribution may be selected. SAPHIRE contains a cross-referencing tool, which provides an overview of every place a basic event, gate, initiating, or pivotal event is used in the model.

4.3.6.2 Propagation of Uncertainties and Event Sequence Categorization with Uncertainties

The fundamental viewpoint of the PCSA is probabilistic in order to develop information suitable for the risk informed nature of 10 CFR Part 63 (Ref. 2.3.2). Any particular event sequence may or may not occur during any operating time interval, and the quantities of the parameters of the models may not be precisely known. Characterizing uncertainties and propagating these uncertainties through the event tree/fault tree model is an essential element of the PCSA. The PCSA includes both aleatory and epistemic uncertainties. Aleatory uncertainty refers to the inherent variation of a physical process over many similar trials or occurrences. For example,

development of a fragility curve to obtain the probability of canister breach after a drop would involve investigating the natural variability of tensile strength of stainless steel. Epistemic uncertainty refers to our state of knowledge about an input parameter or model. Epistemic uncertainty is sometimes called reducible uncertainty because gathering more information can reduce the uncertainty. For example, the calculated uncertainty of a SSC failure rate developed from industry-wide data is reduced when sufficient GROA specific operational information is included in a Bayesian analysis of the SSC failure rate.

Uncertainty in the value of any input parameter and the event sequence frequency is expressed by a probability distribution. Probability distribution is propagated through models using SAPHIRE. As described in Section 4.3.1, categorization is performed using the mean value of event sequences emanating from the big bubble in Figure 4.3-4. By the definition of the term, mean values are derived solely from probability distributions.

Using the screening criteria set out in 10 CFR 63.2 (Ref. 2.3.2), the categorization of an event sequence that is expected to occur m times over the preclosure period (where m is the mean or expected number of occurrences) is carried out as follows:

- A value of m greater than or equal to one places the corresponding event sequence into Category 1.
- A value of m less than one indicates that the corresponding event sequence is not expected to occur before permanent closure. To determine whether the event sequence is Category 2, its probability of occurrence over the preclosure period needs to be compared to 10^{-4} . A measure of the probability of occurrence of the event sequence over the preclosure period is given by a Poisson distribution that has a parameter taken equal to m . The probability, P , that the event sequence occurs at least one time before permanent closure is the complement to one that the event sequence occurs exactly zero times during the preclosure period. Using the Poisson distribution, $P = 1 - \exp(-m)$, a value of P greater than or equal to 10^{-4} implies that value of m is greater than or equal to $-\ln(1 - P) = m$, which is numerically equal to 10^{-4} . Thus, a value of m greater than or equal to 10^{-4} , but less than one, implies the corresponding event sequence is a Category 2 event sequence.
- Event sequences that have a value of m less than 10^{-4} are designated as beyond Category 2.

Using either Monte Carlo or Latin Hypercube methods allows probability distributions to be arithmetically treated to obtain the probability distributions of minimal cut sets and the probability distributions of event sequences. The PCSA used Monte Carlo simulation with 10,000 trials and a standard seed so the results could be reproduced. The number of trials for final results was arrived at by increasing the number of trials until the median, mean, and 95th percentile were stable within the standard Monte Carlo error.

The adequacy of categorization of an event sequence is further investigated if its expected number of occurrences m over the preclosure period is close to a category threshold.

If m is greater than 0.2, but less than one, the event sequence, which a priori is Category 2, is reevaluated differently to determine if it should be recategorized as Category 1. Similarly, if m is greater than 2×10^{-5} , but less than 10^{-4} , the event sequence, which a priori is beyond Category 2, is reevaluated to determine if it should be recategorized as Category 2.

The reevaluation begins with calculating an alternative value of m , designated by m_a , based on an adjusted probability distribution for the number of occurrences of the event sequence under consideration. The possible distributions that are acceptable for such a purpose would essentially have the same central tendency, embodied in the median (i.e., the 50th percentile), but relatively more disparate tails, which are more sensitive to the shape of the individual distributions of the basic events that participate in the event sequence. Accordingly, the adjusted distribution is selected as a lognormal that has the same median M as that predicted by the Monte Carlo sampling. Also, to provide for a reasonable variability in the distribution, an error factor $EF = 10$ is used, which means that the 5th and 95th percentiles of the distribution are respectively lesser or greater than the median by a factor of 10.

If the calculated value of m_a is less than one, the alternative distribution confirms that the event sequence category is the same as that predicted by the original determination, i.e., Category 2. Similarly, if the calculated value of m_a is less than 10^{-4} , the alternative distribution confirms that the event sequence category is the same as that predicted by the original determination, i.e., beyond Category 2.

In contrast, if the calculated value of m_a is greater than one, the alternative distribution indicates that the event sequence is Category 1, instead of Category 2 found in the original determination. In such a case, the conflicting indications are resolved by conservatively assigning the event sequence to Category 1.

Similarly, if the calculated value of m_a is greater than 10^{-4} , the alternative distribution indicates that the event sequence is Category 2, instead of beyond Category 2 found in the original determination. In such a case, the conflicting indications are resolved by conservatively assigning the event sequence to Category 2.

The calculations carried out to quantify an event sequence are performed using the full precision of the individual probability estimates that are used in the event sequence. However, the categorization of the event sequence is based upon an expected number of occurrences over the preclosure period given with one significant digit.

4.3.7 Identification of ITS SSCs, Development of Nuclear Safety Design Bases, and Development of Procedural Safety Controls

4.3.7.1 Identification of ITS SSCs

ITS SSCs are subject to nuclear safety design bases that are established to ensure that safety functions and reliability factors applied in the event sequence analyses are explicitly defined in a manner that assures proper categorization of event sequences.

ITS is defined in 10 CFR 63.2 (Ref. 2.3.2) as:

“Important to safety, with reference to structures, systems, and components, means those engineered features of the geologic repository operations area whose function is:

- (1) To provide reasonable assurance that high-level radioactive waste can be received, handled, packaged, stored, emplaced, and retrieved without exceeding the requirements of § 63.111(b)(1) for Category 1 event sequences; or
- (2) To prevent or mitigate Category 2 event sequences that could result in radiological exposures exceeding the values specified at § 63.111(b)(2) to any individual located on or beyond any point on the boundary of the site.”

Structures are defined as elements that provide support or enclosure such as buildings, free standing tanks, basins, dikes, and stacks. Systems are collections of components assembled to perform a function, such as HVAC, cranes, trolleys, and transporters. Components are items of equipment that taken in groups become systems such as pumps, valves, relays, piping, or elements of a larger array, such as digital controllers.

Implementation of the regulatory definition of ITS has produced the following specific criteria in the PCSA to classify SSCs:

A SSC is classified as ITS if it appears in an event sequence and at least one of the following criteria apply:

- The SSC is relied upon to reduce the frequency of an event sequence from Category 1 to Category 2.
- The SSC is relied upon to reduce the frequency of an event sequence from Category 2 to beyond Category 2.
- The SSC is relied upon to reduce the aggregated dose of Category 1 event sequences by reducing the event sequence mean frequency.
- The SSC is relied upon to perform a dose mitigation or criticality control function.

A SSC is classified as ITS in order to assure safety function availability over the operating lifetime of the repository. The classification process involves the selection of the SSCs in the identified event sequences (including event sequences that involve nuclear criticality) that are relied upon to perform the identified safety functions such that the preclosure performance objectives of 10 CFR Part 63 (Ref. 2.3.2) are not exceeded. The ITS classification extends only to the attributes of the SSCs involved in providing the ITS function. If one or more components of a system are determined to be ITS, the system is identified as ITS, even though only a portion of the system may actually be relied upon to perform a nuclear safety function. However, the specific safety functions that cause the ITS classification are delineated.

Perturbations from normal operations, human errors in operations, human errors during maintenance (preventive or corrective), and equipment malfunctions may initiate Category 1 or Category 2 event sequences. The SSCs supporting normal operations (and not relied upon as described previously for event sequences) are identified as non-ITS. In addition, if a SSC (such as permanent shielding) is used solely to reduce normal operating radiation exposure, it is classified as non-ITS.

4.3.7.2 Development of Nuclear Safety Design Bases

Design bases are established for the ITS SSCs as described in 10 CFR 63.2 (Ref. 2.3.2):

“Design bases means that information that identifies the specific functions to be performed by a structure, system, or component of a facility and the specific values or ranges of values chosen for controlling parameters as reference bounds for design. These values may be constraints derived from generally accepted “state-of-the-art” practices for achieving functional goals or requirements derived from analysis (based on calculation or experiments) of the effects of a postulated event under which a structure, system, or component must meet its functional goals...”

The safety functions for this analysis are developed from the applicable Category 1 and Category 2 event sequences for the SSCs that are classified as ITS. In general, the controlling parameters and values are grouped in, but are not limited to, the following five categories:

1. Mean frequency of SSC failure. It shall be demonstrated by this analysis that the ITS SSC will have a mean frequency of failure (e.g., failure to operate, failure to breach), with consideration of uncertainties, less than or equal to the stated criterion value.
2. Mean frequency of seismic event-induced failure. It shall be demonstrated by this analysis that the ITS SSC will have a mean frequency of a seismic event-induced failure (e.g., tipover, breach) of less than 1E-04 over the preclosure period, considering the full spectrum of seismic events less severe than that associated with a frequency of 1E-07/yr.
3. High confidence of low mean frequency of failure (HCLPF). It shall be demonstrated by this analysis that the ITS SSC will have a HCLPF associated with seismic events of less than or equal to the criterion value. The HCLPF value is a function of uncertainty, expressed as β_c , which is the lognormal standard deviation of the SSC seismic fragility.
4. Preventive maintenance and/or inspection interval. The ITS SSCs shall be maintained or inspected to assure availability, at intervals not to exceed the criterion value.
5. Mean unavailability over time period. It shall be demonstrated by this analysis that the ITS SSCs (e.g., HVAC and emergency electrical power) will have a mean unavailability over a period of a specified number of days, with consideration of uncertainties, of less than the criterion value.

These controlling parameters and values ensure that the ITS SSCs perform their identified safety functions such that 10 CFR Part 63 (Ref. 2.3.2) performance objectives are met. The controlling parameters and values include frequencies or probabilities in order to provide a direct link from the design requirements for categorization of event sequences. The PCSA will demonstrate that these controlling parameters and values are met by design of the respective ITS SSCs.

Table 6.9-1 in Section 6.9 presents a list of ITS SSCs, the nuclear safety design bases of the ITS SSCs, the actual value of the controlling parameter developed in this analysis, and a reference to that portion of the analysis (e.g., fault tree analysis), which demonstrates that the criterion is met.

4.3.7.3 Identification of Procedural Safety Controls

10 CFR 63.112(e) (Ref. 2.3.2) requires that the PCSA include an analysis that “identifies and describes the controls that are relied upon to limit or prevent potential event sequences or mitigate their consequences” and “identifies measures taken to ensure the availability of safety systems.” This section describes the approach for specifying and analyzing the subset of procedural safety controls (PSCs) that are required to support the event sequence analysis and categorization.

The occurrence of an initiating or pivotal event is usually a combination of human errors and equipment malfunctions. A human reliability analysis is performed for the human errors. Those human actions that are relied upon to reduce the frequency of or mitigate the consequence of an event sequence are subject to procedural safety controls.

The approach for deriving PSCs from the event sequence analysis is outlined in the following:

1. Use event tree and supporting fault tree models for initiating events and pivotal events to identify HFEs.
2. Identify the types of PSCs necessary to support the HRA analysis for each of the HFEs. For example, provide clarifications about what is to be accomplished, time constraints, use of instrumentation, interlock and permissives that may back-up the human action.
3. Perform an event sequence analysis using screening HRA values. Identify the PSCs that appear to be needed to reduce the probability of or mitigate the severity of event sequences. The same criteria is used to identify ITS SSCs.
4. Work with the design and engineering organizations to add equipment features that will either eliminate the HFE or support crew and operators in the performance of the action. In effect, this entails development of design features that appear instead of a human action or under an AND gate with a human action.
5. Quantify event sequences again, identifying HFEs for which detailed HRA must be performed. The detailed HRA would lead to specific PSCs that are needed to reduce the frequency of event sequences or mitigate their consequences.

4.3.8 Event Sequence to Dose Relationship

Outputs of the event sequence analysis and categorization process include tabulations of event sequences by expected number of occurrences, end state, and waste form. The event sequences are sorted by Category 1, Category 2 and beyond Category 2. Summaries of the results are tabulated in Section 6.8 and Attachment G with the following information:

1. Event sequence group identifier. A unique designator is provided for each event sequence to permit cross-references between event sequence categorization and consequence and criticality analysis.
2. End state. One of the following is provided for each event sequence:
 - A. DE-SHIELD-DEGRADE or DE-SHIELD-LOSS (Direct Exposure). Condition leading to potential exposure due to degradation of shielding provided by the cask or the aging overpack.
 - B. RR-FILTERED (Radionuclide Release, Filtered). Condition leading to a potential release of radionuclide due to loss of waste form primary containment (e.g., cask with uncanistered commercial SNF or canister). However, the availability of the secondary confinement (structural and HVAC with HEPA filtration) provides mitigation of the consequences.
 - C. RR-UNFILTERED (Radionuclide Release, Unfiltered). Condition leading to a potential release of radionuclide due to loss of waste form primary containment (e.g., cask with uncanistered commercial SNF or canister), and a breach in the secondary confinement boundary (e.g., no HEPA filtration to provide mitigation of the consequences or breach of the structural confinement).
 - D. RR-FILTERED-ITC and RR-UNFILTERED-ITC (Radionuclide Release, Important to Criticality, Filtered or Unfiltered). Condition leading to a potential release of radionuclide due to loss of waste form primary containment (e.g., cask with uncanistered commercial SNF or canister) with or without HEPA filtration. In addition, the potential of exposing the unconfined waste form to moderator could result in conditions important to criticality. This characteristic of the end state is used by both the dose consequence analysts and the criticality analysts.
 - E. ITC (Important to Criticality). This end state is not used for the CRCF because all potential criticality initiators are associated with a radiological release (i.e., end state RR-UNFILTERED-ITC).
3. General description of the event sequence. This is a high level description that is explained by the other conditions described above. For example, "Filtered radionuclide release resulting from a drop from a crane that causes a breach of both sealed transportation cask and sealed TAD canister."

4. Material-at-risk. Identify and define the number of each waste form that contributes to the radioactivity or criticality hazard of the end state (e.g., number of TAD canisters, DPCs, uncanistered commercial SNF assemblies, etc., involved in the event sequence).
5. Expected number of occurrences. Provide the expected mean number of occurrences of the designated event sequences over the preclosure period and associated median and standard deviation.
6. The event sequence categorization. Provide the categorization of the designated event sequence and the basis for the categorization.
7. The bounding consequences. Provide the bounding consequence analysis cross-reference, as applicable, for each Category 1 or 2 event sequence to the bounding event number from the preclosure consequence analysis.

10 CFR 63.111 (Ref. 2.3.2) requires that the doses associated with Category 1 and Category 2 event sequences meet specific performance objectives. There are no performance objectives for beyond Category 2 event sequences. Dose consequences associated with each Category 1 and Category 2 event sequence are evaluated in preclosure consequence analyses, by comparison, to pre-analyzed release conditions (or dose categories) that are intended to characterize or bound the actual event sequences (Ref. 2.2.38). As such, the results of the event sequence analysis and categorization serve as inputs to the consequence analysis for assignment to dose categories.

4.3.9 Event Sequence to Criticality Relationship

The requirements for compliance with preclosure safety regulations are defined in 10 CFR 63.112 (Ref. 2.3.2). Particularly germane to criticality considerations, is the requirement in 10 CFR 63.112, Paragraph (e) and Subparagraph (e)(6) (Ref. 2.3.2). Paragraph (e) requires an analysis to identify the controls that are relied upon to limit or prevent potential event sequences or mitigate their consequences. This is a general requirement imposed on all event sequence analyses. Subparagraph (e)(6) specifically notes that the analyses should include consideration of “means to prevent and control criticality.” The PCSA criticality analyses (Ref. 2.2.39) employ specialized methods that are beyond the scope of the present calculation. However, the event sequence development analyses inform the PCSA criticality analyses by identifying the event sequences and end states that may have a potential for criticality. As noted in Section 4.3, some event sequence end states include the phrase “important to criticality.” This indicates that the end state implies the potential for criticality and that a criticality investigation is indicated.

To determine the criticality potential for each waste form and associated facility and handling operations, criticality sensitivity calculations are performed. These calculations evaluate the impact on system reactivity of variations in each of the parameters important to criticality during the preclosure period, that is, waste form characteristics, reflection, interaction, neutron absorbers (fixed and soluble), geometry, and moderation. The criticality sensitivity calculations determine the sensitivity of the effective neutron multiplication factor (k_{eff}) to variations in any of these parameters as a function of the other parameters. These criticality calculations demonstrate that one of the following is true for each parameter:

- It is bounding (i.e., its analyzed value is greater than or equal to the design limit) or its effect on k_{eff} is bounded and does not need to be controlled. This is designated as a no in Table 4.3-1.
- It needs to be controlled if another parameter is not controlled (conditional control). This is designated as a Conditional in Table 4.3-1.
- It needs to be controlled because it is the primary criticality control parameter. This is designated as a yes in Table 4.3-1.

The criticality control parameters analysis, which comprises the background calculations that led to Table 4.3-1, is presented in detail in the *Preclosure Criticality Safety Analysis* (Ref. 2.2.39). Event sequences that impact the criticality control parameters that have been established as needing to be controlled are identified, developed, quantified, and categorized. These event sequences are referred to as event sequences ITC. The following matrix elements, indicating the need for control, are treated in the current event sequence analysis:

- Conditional: needs to be controlled if moderator is present
- Conditional: needs to be controlled during a boron dilution accident
- Yes: moderation is the primary criticality control
- Yes: interaction for DOE standardized SNF canisters needs to be controlled

Table 4.3-1. Criticality Control Parameter Summary

Parameter \ Operation	CSNF (Dry Operations)	CSNF (WHF Pool and Fill Operations)	DOE SNF	HLW
Waste Form Characteristics	No ^a	No ^a	No ^b	No ^c
Moderation	Yes ^d	N/A	Yes ^d	No
Interaction	No	Conditional ^g	Yes ^e	No
Geometry	Conditional ^f	Conditional ^g	Conditional ^f	No
Fixed Neutron Absorbers	Conditional ^f	Conditional ^g	Conditional ^f	No
Soluble Neutron Absorber	N/A	Yes ^h	N/A	N/A
Reflection	No	No	No	No

NOTE: ^a The *Preclosure Criticality Safety Analysis* (Ref. 2.2.39) considers bounding waste form characteristics. Therefore, there is no potential for a waste form misload.

^b The *Preclosure Criticality Safety Analysis* (Ref. 2.2.39) considers nine representative DOE SNF types. Because the analysis is for representative types and loading procedures for DOE standardized SNF canisters have not been established yet, consideration of waste form misloads is not appropriate.

^c Criticality safety design control features are not necessary for HLW canisters because the concentration of fissile isotopes in an HLW canister is too low to have criticality potential.

^d Moderation is the primary criticality control parameter

^e Placing more than four DOE standardized SNF canisters outside the staging racks or a codisposal waste package needs to be controlled.

^f Needs to be controlled only if moderator is present.

^g Needs to be controlled only if the soluble boron concentration in the pool and transportation cask/DPC fill water is less than the minimum required concentration.

^h Minimum required soluble boron concentration in the pool is 2500 mg/L boron enriched to 90 atom % ¹⁰B.

CSNF = commercial spent nuclear fuel; DOE = U.S. Department of Energy; HLW = high-level radioactive waste; SNF = spent nuclear fuel; WHF = Wet Handling Facility.

Source: *Preclosure Criticality Safety Analysis* (Ref. 2.2.39, Table 6).

4.3.10 Boundary Conditions and Use of Engineering Judgment Within a Risk Informed Framework

4.3.10.1 Boundary Conditions

The initiating events considered in the PCSA define what could occur within the site GROA and are limited to those events that constitute a hazard to a waste form while it is present in the GROA. Initiating events include internal events occurring during waste handling operations conducted within the GROA and external events (e.g., seismic, wind energy, or flood water events) that impose a potential hazard to a waste form, waste handling systems, or personnel within the GROA. Such initiating events are included when developing event sequences for the PCSA. However, initiating events that are associated with conditions introduced in SSCs before they reach the site are not within the scope of the PCSA. The exclusion from consideration of offsite conditions include: drops of casks, canisters, or fuel assemblies during loading at a reactor site; improper drying, closing, or inerting at the reactor site, rail or road accidents during transport; tornado missile strikes on a transportation cask or nonconformances introduced during cask or canister manufacture that results in a reduction of containment strength. Such potential precursors are subject to deterministic regulations such as 10 CFR Part 50 (Ref. 2.3.1), 10 CFR

Part 71 (Ref. 2.3.3), and 10 CFR Part 72 (Ref. 2.3.4) and associated quality assurance programs. As a result of compliance to such regulations, the SSCs are deemed to pose no undue risk to health and safety. Although the analyses do not address quantitative probabilities, it is clear that conservative design criteria and QA controls result in unlikely exposures to radiation.

Other boundary conditions used in the PCSA include:

- Plant operational state. Initial state of the facility is normal with each system operating within its vendor prescribed operating conditions.
- No other simultaneous initiating events. It is standard practice to not consider the occurrence of other initiating events (human-induced and naturally occurring) during the time span of an event sequence because, (a) the probability of two simultaneous initiating events within the time window is small, and (b) each initiating event will cause operations of the waste handling facility to be terminated which further reduces the conditional probability of the occurrence of a second initiating event, given the first has occurred.
- Component failure modes. The failure mode of a SSC corresponds to that required to make the initiating or pivotal event occur.
- Fundamental to the basis for the use of industry-wide reliability parameters within the PCSA, such as failure rates, is the use of SSCs within the GROA that conform to NRC accepted consensus codes and standards, and other regulatory guidance.

4.3.10.2 Use of Engineering Judgment

10 CFR Part 63 (Ref. 2.3.2) is a risk-informed regulation rather than a risk-based regulation. The term risk-informed was defined by the NRC to recognize that a risk assessment can not always be performed using only quantitative modeling. Probabilistic analyses may be supplemented with expert judgment and opinion, based on engineering knowledge. Such practice is fundamental to the risk assessment technology used for the PCSA.

10 CFR Part 63 (Ref. 2.3.2) does not specify analytical methods for demonstrating performance, estimating the reliability of ITS SSCs (whether active or passive), or calculating uncertainty. Instead, the risk-informed and performance-based preclosure performance objectives in 10 CFR Part 63 (Ref. 2.3.2) provide the flexibility to develop a design, and demonstrate that it meets performance objectives for preclosure operations including the use of well established (discipline-specific) methodologies. As exemplified in the suite of risk-informed regulatory guides developed for 10 CFR Part 50 (Ref. 2.3.1) (e.g., (Ref. 2.2.77 and Ref. 2.2.69)), such methodologies use deterministic and probabilistic inputs and analysis insights. The range of well established techniques in the area of PRA, which is used in the PCSA, often relies on the use of engineering judgment and expert opinion (e.g., in development of seismic fragilities, human error probabilities, and the estimation of uncertainties).

As described in Section 4.3.3, for example, active SSC reliability parameters are developed using a Bayesian approach; and the use of judgment in expressing prior state-of-knowledge is a well-recognized and accepted practice (Ref. 2.2.60, Ref. 2.2.6, Ref. 2.2.12, and Ref. 2.2.68).

The NRC issued *Interim Staff Guidance HLWRS-ISG-02, Preclosure Safety Analysis – Level of Information and Reliability Estimation* (Ref. 2.2.74) to provide guidance for compliance to 10 CFR 63.111 and 112 (Ref. 2.3.2). This document states that “treatment of uncertainty in reliability estimates may depend on the risk-significance (or reliance) of a canister system in preventing or reducing the likelihood of event sequences.” Furthermore, *HLWRS-ISG-02* (Ref. 2.2.74) indicates that reliability estimates for high reliability SSCs may include the use of engineering judgment supported by sufficient technical basis; and empirical reliability analyses of a SSC could include values based on industry experience and judgment.

In a risk-informed PCSA, therefore, the depth, rigor of quantitative analysis and the use of judgment depends on the risk-significance of the event sequence. As such, decisions on the level of effort applied to various parts of the PCSA are made, based on the contribution to the frequency of end states and the severity of such end states. An exhaustive analysis need not be performed to make this resource allocation. Accordingly, the PCSA analyst has flexibility in determining and estimating the reliability required for each SSC, at the system or component level, and in selecting approaches in estimating the reliability. The quantified reliability estimates used to reasonably screen out initiating events, support categorization, or screening of event sequences must be based on defensible and traceable technical analyses. The following summarizes the approaches where judgment is applied to varying degrees.

All facility safety analyses, whether or not risk-informed, take into account the physical conditions, dimensions, materials, human-machine interface, or other attributes such as operating conditions and environments to assess potential failure modes and event sequences. Such factors guide the assessment of what can happen, the likelihood, and the potential consequences. In many situations, it could be considered obvious that the probability of a particular exposure scenario is very small. In many cases, it is impractical or unnecessary to actually quantify the probability when a non-probabilistic engineering analysis provides sufficient assurance and insights that permit the event sequence to be either screened out, or demonstrated to be bounded by another event sequence. Examples of such are provided in Section 6.0.

When Empirical Information is Not Available

There is generally no or very little empirical information for the failure of passive SSCs such as transportation casks and spent fuel storage canisters. Such failures are postulated in predictive safety and risk analyses and then the SSCs are designed to withstand the postulated drops, missile impacts, seismic shaking, abnormal temperatures and pressures, etc. While in service, few if any SSCs have been subjected to abnormal conditions that approach the postulated abnormal scenarios so there is virtually no historical data to call on.

Therefore, structural reliability analyses are used in the PCSA to develop analysis-based failure probabilities for the specific event sequences identified within the GROA. Uncertainties in the calculated stresses/strains and the capacity of the SSCs to withstand those demands include the use of judgment, based on standard nuclear industry practices for design, manufacturing, etc.,

under the deterministic NRC regulatory requirements of 10 CFR Part 50 (Ref. 2.3.1), 10 CFR Part 71 (Ref. 2.3.3), and 10 CFR Part 72 (Ref. 2.3.4). It is standard practice to use the information basis associated with the consensus standard and regulatory requirement information as initial conditions of a risk-informed analysis. This approach is acceptable for the PCSA subject to the following:

1. The conditions associated with the consensus codes and standards and regulatory requirements are conservatively applicable to the GROA.
2. Equivalent quality assurance standards are applied at the GROA.
3. Operating processes are no more severe than those licensed under the aforementioned deterministic regulations.

Use of Empirical Reliability Information

In those cases where applicable, quantitative historical component reliability information is available, the PCSA followed Section 4.3 including the application of judgment that is associated with Bayesian analysis. Similarly, as described in Sections 4.3.5, 4.3.6, and 4.3.7, historical data is applied in human reliability, fire, and flooding analyses with judgment-based adjustments as appropriate for the CRCF and GROA operating conditions.

Use of Qualitative Information When Reliability Information is Not Available

In those cases where historical records of failures to support the PCSA are not available, qualitative information may be used to assign numerical failure probabilities and uncertainty. This approach is consistent with the Bayesian framework used in the PCSA, consistent with *HLWRS-ISG-02* (Ref. 2.2.74), and involves the use of judgment in the estimation of reliability or failure probability values and their associated uncertainties. In these cases, the PCSA analyst may use judgment to determine probability and reliability values for components.

The following guidelines are used in the PCSA when it is necessary to use judgment to assess the probability of an event. The analyst will select a median at the point believed to be just as likely that the “true” value will lie above as below. Then, the highest probability value believed possible is conservatively assigned as a 95th percentile or error factor (i.e. the ratio of the 95th percentile to median), rather than a 99th or higher percentile, with a justification for the assignments. A lognormal distribution is used because it is appropriate for situations in which the result is a product of multiple uncertain factors or variables. This is consistent with the “A Central Limit Theorem for Latin Hypercube Sampling” (Ref. 2.2.76). The lower bound, as represented by the 5th percentile, is checked to ensure that the distribution developed using the median and 95th percentile does not cause the lower bound to generate values for the variable that are unrealistic compared to the knowledge held by the analyst.

In some cases, an upper and lower bound is defensible, but no information about a central tendency is available. A uniform distribution between the upper and lower bound is used in such cases.

Another way in which risk-informed judgment is applied to obtain an appropriate level of effort in the PCSA, involves a comparison of event sequences. For example, engineering judgment readily indicates that a 23-foot drop of a canister onto an unyielding surface would do more damage to the confinement boundary, than a collision of a canister with a wall at maximum crane speed (e.g., 20 feet per minute). A rigorous probabilistic structural analysis of the 23-foot drop is performed and these results may be conservatively applied to the relatively benign slow speed collision.

5. LIST OF ATTACHMENTS

	Number of Pages
Attachment A Event Trees	185
Attachment B System/Pivotal Event Analysis – Fault trees	423
Attachment C Active Component Reliability Data Analysis	51
Attachment D Passive Equipment Failure Analysis	93
Attachment E Human Reliability Analysis	231
Attachment F Fire Analysis	176
Attachment G Event Sequence Quantification Summary Tables	2
Attachment H SAPHIRE Model and Supporting Files	2 + CD

6. BODY OF ANALYSIS

The *Canister Receipt and Closure Facility Event Sequence Development Analysis* (Ref. 2.2.33), which describes the CRCF, its equipment, and its operations (Ref. 2.2.33, Section 6.1.2, Attachment A, and Attachment B), should be consulted in conjunction with the present analysis.

6.0 INITIATING EVENT SCREENING

The NRC's interim staff guidance for its evaluation of the level of information and reliability estimation related to the Yucca Mountain repository, *Interim Staff Guidance HLWRS-ISG-02, Preclosure Safety Analysis – Level of Information and Reliability Estimation* (Ref. 2.2.74, p. 3), states that there are multiple approaches that DOE could use to estimate the reliability of SSCs that contribute to initiating events or event sequence propagation (i.e., pivotal events), including the use of judgment. 10 CFR 63.102(f) (Ref. 2.3.2) provides that initiating events are to be considered for inclusion in the PCSA for determining event sequences only if they are reasonably based on the characteristics of the geologic setting and the human environment, and are consistent with the precedents adopted for nuclear facilities with comparable or higher risks to workers and the public.

This section provides screening arguments that eliminate extremely unlikely initiating events from further consideration. Screening of initiating events is a component of a risk-informed approach that allows attention to be concentrated on important contributors to risk. The screening process eliminates those potential initiators that are either incapable of initiating an event sequence having radiological consequences or are too improbable during the preclosure period to warrant further consideration. The screening arguments are based on either a qualitative or quantitative analysis documented under separate cover, or through engineering judgment based on considerations of site and design features documented herein.

Initiating events are screened out and are termed beyond Category 2 if they satisfy either of the following criteria:

- The initiating event has less than one chance in 10,000 of occurring during the preclosure period.
- The initiating event has less than one chance in 10,000 over the preclosure period of causing physical damage to a waste form that would result in the potential for radiation exposure or inadvertent criticality.

In some instances, initiating event screening analysis is based on engineering or expert judgment. Such judgment is based on applications of industry codes and standards, comparison to results of analyses for other similar event sequences that are included, or plausibility arguments based on the combinations of conditions that must be present to allow the initiating event to occur and the event sequence to propagate.

6.0.1 Boundary Conditions for Consideration of Initiating Events

6.0.1.1 General Statement of Boundary Conditions

Manufacturing, loading, and transportation of casks and canisters are subject to regulations other than 10 CFR Part 63 (e.g., 10 CFR Part 50 (Ref. 2.3.1), 10 CFR Part 71 (Ref. 2.3.3), and 10 CFR Part 72 (Ref. 2.3.4)) and associated quality assurance programs. As a result of compliance with such regulations, the affected SSCs are deemed to provide reasonable assurance that the health and safety of the public are protected. However, if a potential precursor condition could result in an airborne release that could exceed the performance objectives for Category 1 or Category 2 event sequences, or a criticality condition, then a qualitative argument that the boundary condition is reasonable is provided. A potential initiating event that is outside of the boundary conditions but has been found to require a qualitative discussion is the failure to properly dry a SNF canister prior to sealing it and shipping it to the repository.

6.0.1.2 Specific Discussion of Receipt of Properly Dried SNF Canisters

Under the boundary conditions stated for this analysis, canisters shipped to the repository in transportation casks are received in the intended internally dry conditions. Shipments of SNF received at the repository, whatever their origin, are required to meet the requirements of 10 CFR Part 71 (Ref. 2.3.3). NUREG-1617 (Ref. 2.2.71) provides guidance for the NRC safety reviews of packages used in the transport of spent nuclear fuel under 10 CFR Part 71 (Ref. 2.3.3). The review guidance, NUREG-1617 (Ref. 2.2.71, Section 7.5.1.2), instructs reviewers that, at a minimum, the procedures described in the safety analysis report should ensure that:

Methods to drain and dry the cask are described, the effectiveness of the proposed methods is discussed, and vacuum drying criteria are specified.

NUREG-1536 (Ref. 2.2.70, Chapter 8, Section V) refers to an acceptable process to evacuate water from SNF canisters. No more than about 0.43 gram-mole of water (about 8 grams) will be left in the canister if adequate vacuum drying is performed (Ref. 2.2.70). The following example is cited as providing adequate drying (Ref. 2.2.70, Chapter 8, Section V):

The cask should be drained of as much water as practicable and evacuated to less than or equal to 4E-4 MPa (3.0 mm Hg or Torr). After evacuation, adequate moisture removal should be verified by maintaining a constant pressure over a period of about 30 minutes without vacuum pump operation. The cask is then backfilled with an inert gas (e.g., helium) for applicable pressure and leak testing.

If the pressure creeps back up to an unacceptable level during the 30-minute evaluation time period, or in cases where it is important to control oxidant concentrations or achieve needed process reliability improvements, a further step may be performed as follows (Ref. 2.2.70, Chapter 8, Section V):

The cask is then re-evacuated and rebackfilled with inert gas before final closure. Care should be taken to preserve the purity of the cover gas and, after backfilling, cover gas purity should be verified by sampling.

The procedure described appears to ensure that very little water is left behind. However, the probability of undetected failure when performing the process is not addressed in the deterministic regulation (10 CFR Part 71 (Ref. 2.3.3) or in NUREG-1536 (Ref. 2.2.70)). Indeed, there is no after-the-fact water or error detection method in NUREG-1536 or the regulation. Therefore, some unknown number of canisters may arrive in the GROA with more residual water than is expected with proper drying. Because the canisters are welded and are not required to provide for sampling the inside of the canister, nondestructive measurement of the residual water content would be difficult. The following discussion provides reasonable assurance that no significant risks are omitted from the analysis due to adoption of the boundary condition that canisters shipped to the repository in transportation casks are received in the intended internally dry conditions.

1. The YMP accepts, handles, and emplaces TAD canisters in a manner consistent with the specifications laid out in the TAD canister system performance specification (Ref. 2.2.45) which prescribes the use of consensus codes and standards along with design requirement associated with GROA specific event sequences.
2. **Criticality.** GROA operating processes are similar to those of nuclear power plant sites with respect to the use of cranes, and there are no processes or conditions that would exacerbate adverse effects associated with abnormal amounts of water retention. Event sequences involving drop and breach of a SNF canister are beyond Category 2 as shown in Section 6.8. To receive a license to transport SNF, 10 CFR 71.55 (Ref. 2.3.3) requires the licensee to demonstrate subcriticality given that “the fissile material is in the most reactive credible configuration consistent with the damaged condition of the package and the chemical and physical form of the contents” under the hypothetical accident conditions specified in 10 CFR 71.73 (Ref. 2.3.3). Drop events, which are unlikely to breach the canister, are also unlikely to impart sufficient energy to the fuel to reconfigure it so dramatically that criticality would be possible even if water is present. It is concluded that existing regulations that apply to the canister and transportation cask for transportation to the repository provide reasonable assurance that a criticality event sequence that depends on the presence of water inside the canister and reconfiguration of the fuel would not occur under conditions that could reasonably be achieved during handling at the repository.
3. **Hydrogen explosion or deflagration.** Radiation from SNF can generate radiolytic hydrogen and oxygen gas in a SNF canister if water is inadvertently left in the canister before it is sealed. Given a processing error that leaves enough residual water, the gas concentrations could conceivably reach levels where a deflagration event could occur. However, precautions taken at the generator sites are expected to make receipt of a canister that was improperly dried unlikely. In addition, an ignition source would be required for an explosion or deflagration to occur. High electrical conductivity of the metal canister would dissipate any high voltage electrical discharge (which is unlikely in any case) and preclude arcing within the canister. Normal handling operations do not subject the canisters to energetic impacts that could cause frictional sparking inside the canister. Therefore, a further unlikely event, such as a canister drop would have to occur to ignite the gas. Considering the combination of unlikely events that must occur, event sequences involving this combination of failures are judged to contribute

insignificantly to the frequency of the grouped event sequences of which they would be a part.

4. **Overpressurization due to residual water.** Given a processing error that leaves an excessive amount of residual water, the internal pressure due to vaporization of water could conceivably breach the canister. If sufficient water were to be left in the canister, overpressurization would occur within hours of the canister being welded closed. Therefore, overpressurization would occur while the canister is still in the supplier's possession and not in the GROA. Ambient environmental conditions in the GROA are similar to those that would be encountered by the canister while it is on the supplier's site and during transportation to the GROA. If there is not enough water to cause overpressurization before the canister reaches the GROA, then overpressurization would not occur in the GROA. Therefore, event sequences associated with this failure mode are considered to be physically unrealizable for loaded canisters that are received from offsite.

6.0.2 Screening of External Initiating Events

6.0.2.1 Initial Screening of External Initiating Events

The *External Events Hazards Screening Analysis* (Ref. 2.2.34) identifies potential external initiating events at the repository for the preclosure period and screens a number of them from further evaluation based on severity or frequency considerations. The four questions that constitute the evaluation criteria for external events screening are:

1. Can the external event occur at the repository?
2. Can the external event occur at the repository with a frequency greater than $10^{-6}/\text{yr}$, that is, have a 1 in 10,000 chance of occurring in the 100 year preclosure period?
3. Can the external event, severe enough to affect the repository and its operation, occur at the repository with a frequency greater than $10^{-6}/\text{yr}$, that is, have a 1 in 10,000 chance of occurring in the 100 year preclosure period?
4. Can a release that results from the external event severe enough to affect the repository and its operations occur with a frequency greater than $10^{-6}/\text{yr}$, that is, have a 1 in 10,000 chance of occurring in the 100 year preclosure period?

The screening criteria are applied for each of the external event categories listed in Table 6.0-1. Each external event category is evaluated separately with a definition and the required conditions for the external event to be present at the repository. Then the four questions are applied. Those external event categories that are not screened out are retained for further evaluation as initiating events in the event sequences for the preclosure safety analysis.

As noted in Table 6.0-1, the potential external initiating event categories that are retained for further evaluation are seismic activity and loss of power. Seismically induced event sequences are developed, categorized, and documented in a separate analysis (Ref. 2.4.4). Loss of offsite power (LOSP) is treated together with internal causes of power loss in Section 6.0.2.2.

Table 6.0-1. Retention Decisions from External Events Screening Analysis

External Event Category	Retention Decision. If Not Retained, Basis for Screening.
Seismic activity	YES. Retained for further analysis.
Nonseismic geologic activity	NO. Except for one of the subcategories, drift degradation, the external events in this category are not applicable to the site or do not occur at a rate that could affect the repository during the preclosure period. The chance of drift degradation severe enough to affect the repository and its operation over the preclosure period is less than 1/10,000.
Volcanic activity	NO. The chance of volcanic activity occurring at the repository over the preclosure period is less than 1/10,000.
High winds / tornadoes	NO. The chance of a high wind or tornado event severe enough to affect the repository and its operation occurring at the repository over the preclosure period is less than 1/10,000.
External floods	NO. The chance of a flood event severe enough to affect the repository and its operation occurring at the repository over the preclosure period is less than 1/10,000.
Lightning	NO. The chance of a lightning event severe enough to affect the repository and its operation occurring at the repository over the preclosure period is less than 1/10,000.
Loss of power event	YES. Retained for further analysis. See Section 6.0.2.2 for a screening analysis of loss of electrical power as an initiating event.
Loss of cooling capability event	NO. The primary requirements for cooling water at the Yucca Mountain site during the preclosure period are makeup water for the Wet Handling Facility (WHF) pool and cooling of HVAC chilled water. The chance of a loss of cooling capability occurring at the repository over the preclosure period is less than 1/10,000.
Aircraft crash	NO. The chance of an accidental aircraft crash occurring at the repository over the preclosure period is less than 1/10,000.
Nearby industrial/military facility accidents	NO. The chance of an industrial or military facility accident occurring at the repository over the preclosure period is less than 1/10,000.
Onsite hazardous materials release	NO. The chance of an accident event sequence initiated by the release of onsite hazardous materials at the repository over the preclosure period is less than 1/10,000.
External fires	NO. The chance of an external fire severe enough to affect the repository and its operation occurring at the repository over the preclosure period is less than 1/10,000.
Extraterrestrial activity	NO. Extraterrestrial activity is defined as an external event involving objects outside the earth's atmosphere and enters the earth's atmosphere, survive the entry through the earth's atmosphere and strike the surface of the earth. Extraterrestrial activity include: meteorites, asteroids, comets, and satellites. The chance of an occurrence at the repository over the preclosure period is less than 1/10,000.

NOTE: The source document defines the categories. HVAC = heating, ventilation, and air conditioning;
WHF = Wet Handling Facility.

Source: Adapted from Ref. 2.2.34 Sections 6 and 7.

6.0.2.2 Screening of Loss of Electrical Power as an Initiating Event

Loss of electrical power, whether caused by onsite or offsite failures, is expected to occur during the preclosure period. Conveyances, cranes, and CTMs that rely on electric power will stop upon loss of power, but are designed to hold loads indefinitely. A set of redundant emergency diesel generators and the associated ITS electrical distribution system would start upon LOSP in order to continue operation of the ITS HVAC confinement system.

LOSP is not shown as an initiating event in the event trees because, by itself, it does not cause mechanical handling equipment to malfunction in a way that causes a drop or other mechanical impact of a waste container. Therefore, load drop and LOSP may be treated as independent events. The following calculation demonstrates that a LOSP and coincident load drop is beyond Category 2.

The LOSP frequency is estimated at 3.6E-02/yr (Ref. 2.2.46, Table 3-8), with a failure to recover power within 24 hours of 1.8E-02 (Ref. 2.2.46, Table 4-1). Thus, during the 50-yr portion of the preclosure period in which waste handling operations are conducted, the expected number of LOSP events is:

$$\begin{aligned}\text{LOSP \#} &= 3.6\text{E-}02 / \text{yr} \times 50 \text{ yr} \\ &= 1.8;\end{aligned}$$

The initiating frequency of a LOSP lasting more than 24 hours would be:

An independent load drop from a crane following a LOSP would probably be caused by crane holding and emergency brake failures or random hoist cable breaks (each CTM and crane uses multiple wire ropes) because no other movement induced failure modes have been identified. Crane brake failures are more frequent than wire rope breaks, and for this calculation, the brake failure rates are used to determine a load drop probability. Two failure modes for the brakes have been modeled: failure of the brake to set and failure of the brakes to hold for an extended period. As documented in Attachment C, Table C4-1, estimated crane brake failure rates are:

- Holding (pneumatic) brake (BRP-FOD & BRP-FOH): 5.0E-05 per demand (initial setting of the brake) and 8.4E-06 per hour (holding the load for the duration of the power loss)
- Emergency brake (BRK-FOD & BRK-FOH): 1.5E-06 per demand (initial setting of the brake) and 4.4E-06/hr (holding the load for the duration of the power loss).

The four components of LOSP and brake failures are:

1. Both the holding brake and emergency brake fail to set on a LOSP resulting in a load drop.
2. Holding brake fails to set at LOSP. Emergency brake sets at LOSP but fails to hold during an extended loss of power (720 hours) resulting in a load drop

3. Emergency brake fails to set at LOSP. Holding brake sets at LOSP but fails to hold during an extended loss of power (720 hours) resulting in a load drop
4. Both brakes set at LOSP but fail to hold during an extended loss of power (720 hours) resulting in a load drop.

The failure components described above are analogous to the failure modes of a two train system in standby where at least on train must successfully start and run for a specified mission time to prevent system failure.

The fourth component described above dominates probabilistically and its calculation is described below. The sum of the other three are more than two orders of magnitude lower.

The likelihood of an extended LOSP has been estimated by using the probability of a LOSP exceeding 24 hours, which is the longest non-recovery period identified in NUREG/CR-6890 (Ref.2.2.46). The 720 hour period for which a brake holding failure has been modeled should provide ample time to either recover offsite power or for operators to implement an alternative means to safely lower any load. Provision for manual lowering of loads is provided in NOG-1 cranes (Ref. 2.2.10).

The probability of the fourth component described above – the combination of LOSP and load drop (brakes set but fail to hold over a 720 hour mission time) is:

$$\begin{aligned} \text{LOSP-IE} \times \text{Holding brake fails} \times \text{Emergency brake fails} &= \\ &= 3.2\text{E-}02 \times (8.4\text{E-}06 \times 720) \times (4.4\text{E-}06 \times 720) \\ &= 6.1\text{E-}07 \end{aligned}$$

Thus, the LOSP load drop probability over the preclosure period is estimated to be 6E-07. This number of occurrences of the compound initiating event is much less than one chance in 10,000 (1E-4) during the preclosure period. Therefore, event sequences with LOSP and a coincident drop load as the initiating event are beyond Category 2.

The possibility of inadvertent direct exposure of workers due to a loss of electrical power is considered next. Canisters are always shielded during facility operations by a transportation cask, a canister preparation platform, concrete floors and walls, the CTM shield bell and shield skirt, the WPTT, facility shield doors, and the TEV shield compartment. Loss of electrical power to any of these simply stops operations while maintaining shielding. For example, inadvertent shield bell and shield door motion can not occur in the absence of electrical power. Therefore, direct exposure to workers owing to loss of electrical power is considered to be beyond Category 2.

It has been shown that loss of electrical power in conjunction with other failures is screened out as an initiating event. Nevertheless, this compound failure mode is included in the initiating and pivotal event fault trees as appropriate. For example, the hoist brake on the CTM requires electrical power to remain unengaged. A loss of power would cut power to the brake, leading to its automatic engagement. If the brake fails in conjunction with a loss of power in this scenario, a drop of the load could occur, initiating an event sequence. This failure scenario is included in the CTM fault tree. For the overhead cranes, the initiating event frequencies are based on industry-wide empirical data for cranes. The ITS HVAC system depends on continued electrical power and it is explicitly modeled in the fault tree for this pivotal event.

6.0.3 Screening of Internal Initiating Events

All facility safety analyses, whether risk-informed or not, take into account the physical conditions, dimensions, materials, human-machine interface, and other attributes such as operating conditions and environments, to assess potential failure modes and event sequences. Such accounting guides the assessment of what can happen, the likelihood, and the potential consequences. In many situations, it is obvious that the probability of a particular exposure scenario is very low. In many cases, it is impractical or unnecessary to actually quantify the probability when a non-probabilistic engineering analysis provides sufficient assurance and insights that permit the scenario to be either screened out or demonstrated to be bounded by another scenario.

Potential initiating events were qualitatively identified in the *Canister Receipt and Closure Facility Event Sequence Development Analysis* (Ref. 2.2.33) for quantitative treatment in the present analysis. For completeness, some events that were identified in the event sequence development analysis are extremely unlikely or physically unrealizable and can reasonably be qualitatively screened from further consideration. A qualitative screening argument for certain internal initiating events is developed in the present analysis as documented in Table 6.0-2. The first column of Table 6.0-2 indicates the branch of the initiator event tree (where applicable) that pertains to the screened initiating event. Each branch of an initiator event tree represents an initiating event or an initiating event group that includes other similar initiating events and corresponds to a little bubble on an ESD (Ref. 2.2.33, Attachments F and G). Some of the initiating events that are addressed in Table 6.0-2 were implicitly screened out in the event sequence development analysis and for that reason there is no applicable event tree. The screening argument for internal flooding is presented in Section 6.0.4. The screened initiating events are assigned frequencies of zero in the quantification of the model.

Table 6.0-2. Bases for Screening Internal Initiating Events

Initiator Event Tree (Branch No.)	Initiating Event Description	Screening Basis
<p>CRCF-ESD01-DSTD (#3) (Figure A5-4)</p> <p>CRCF-ESD01-HLW (#3) (Figure A5-5)</p> <p>CRCF-ESD01-MCO (#3) (Figure A5-6)</p>	<p>Rollover of a truck trailer carrying a transportation cask in the Entry Vestibule or Cask Preparation Room</p>	<p>For a truck trailer to roll over, its center of mass has to move laterally beyond the wheel base of the trailer. This could occur upon traversing a significantly uneven surface, running over a very large object, or turning sharply at high speed. There are no uneven surfaces in the Entry Vestibule or Cask Preparation Room. The area in question has a flat concrete surface. There are no objects that could be run over that could significantly shift the trailer's center of mass. Turning sharply at high speed is not possible inside the building because the rooms are too narrow and the truck comes to a complete stop outside the closed entrance door prior to the door opening and the truck entering. Therefore, event sequences associated with this failure mode are considered to be physically unrealizable.</p>
<p>CRCF-ESD04-DPC (#2) (Figure A5-15)</p> <p>CRCF-ESD04-DSTD (#2) (Figure A5-16)</p> <p>CRCF-ESD04-HLW (#2) (Figure A5-17)</p> <p>CRCF-ESD04-MCO (#2) (Figure A5-18)</p> <p>CRCF-ESD04-TAD (#2) (Figure A5-19)</p>	<p>Operator drops cask during cask preparation activities</p>	<p>The 20-ton auxiliary crane, rather than the 200-ton crane, is used in the lid-removal operation. Because the cask is not intentionally lifted in this step, dropping the cask would require a series of extraordinary human failures.</p> <p>For DPCs, a cask drop would require a series of human failures as follows:</p> <p>During lid removal, the crew must fail to remove some fraction of the lid bolts, fail to properly use the check list to verify bolt removal, and use the wrong crane (the 20-ton crane would be incapable of lifting the cask). The crane operator and at least two other crewmembers stand on the platform in direct view of the cask during lid removal and they all would have to fail to notice that the entire cask is being lifted before the bolts break. Therefore, event sequences associated with this initiating event are judged to contribute insignificantly to the frequency of the grouped event sequences of which they would be a part.</p> <p>For casks other than DPC casks, the lid is not removed from the cask at this point. Therefore, no configuration that could result in a crane lifting the cask occurs for such casks. This initiating event, as it relates to casks other than DPC casks, is considered to be unrealizable.</p>

Table 6.0-2. Bases for Screening Internal Initiating Events (Continued)

Initiator Event Tree (Branch No.)	Initiating Event Description	Screening Basis
<p>CRCF-ESD06-DPC (#2) (Figure A5-22)</p> <p>CRCF-ESD06-DSTD (#2) (Figure A5-24)</p> <p>CRCF-ESD06-HLW (#2) (Figure A5-25)</p> <p>CRCF-ESD06-MCO (#2) (Figure A5-26)</p> <p>CRCF-ESD06-TAD (#2) (Figure A5-27)</p>	<p>Structural damage to transportation cask due to impact from the crane hook or rigging while under the cask preparation platform</p>	<p>In this operation, the lid is unbolted and the lid lift fixture is attached. The cask is flush or recessed with respect to the cask preparation platform, and therefore cannot be impacted. Therefore, event sequences associated with these initiating events are considered to be physically unrealizable.</p>
<p>CRCF-ESD09-DPC (#7) (Figure A5-41)</p> <p>CRCF-ESD09-DSTD (#7) (Figure A5-42)</p> <p>CRCF-ESD09-HLW (#7) (Figure A5-43)</p> <p>CRCF-ESD09-MCO (#7) (Figure A5-44)</p> <p>CRCF-ESD09-TAD (#7) (Figure A5-45)</p>	<p>Canister dropped inside shield bell (with CTM slide gate closed)</p>	<p>Drops within the shield bell have been subsumed within event sequences for drops from the operational lift height, and are not separately addressed. This is conservative because the drop height within the shield bell is less than the operational lift height.</p>
<p>CRCF-ESD09-HLW(#6) (Figure A5-43)</p> <p>CRCF-ESD09-DSTD(#6) (Figure A5-42)</p>	<p>Drop of a heavy object onto an HLW canister or onto a DOE SNF canister</p>	<p>The waste package inner lid and the transportation cask lid are the only pertinent heavy objects (except for another canister) whose drop onto an HLW or DOE SNF canister could jeopardize the canister's structural integrity. Divider plates in the codisposal waste package (part of the basket structure) extend higher than the canisters inside. Therefore, a dropped waste package lid would not impact the canisters. Transportation casks for HLW or DOE SNF canisters are designed such that a lid drop would not impact the canisters inside. (Drop of a HLW canister or DOE SNF canister onto a HLW canister is not screened out and is included in the model. However, the drop of a 24-in HLW canister onto an 18-in DOE SNF canister is screened out due to the difference in diameter and the presence of divider plates.) Thus, the drop of a heavy load does not have an adverse effect on the integrity of HLW or DOE SNF canisters and can be screened from further consideration.</p>
<p>CRCF-ESD09-DPC (#7) (Figure A5-41)</p> <p>CRCF-ESD09-DSTD (#7) (Figure A5-42)</p> <p>CRCF-ESD09-HLW (#7) (Figure A5-43)</p> <p>CRCF-ESD09-MCO (#7) (Figure A5-44)</p> <p>CRCF-ESD09-TAD (#7) (Figure A5-45)</p>	<p>Side impact from a slide gate</p>	<p>Slide gate impacts during CTM transfer are included in the CTM fault tree as a cause of canister drop, rather than as an independent initiating event. In addition, the motors on the slide gates have insufficient power to significantly damage a canister.</p>

Table 6.0-2. Bases for Screening Internal Initiating Events (Continued)

Initiator Event Tree (Branch No.)	Initiating Event Description	Screening Basis
CRCF-ESD11-WP-H&D (#2) (Figure A5-50) CRCF-ESD11-WP-H&M (#2) (Figure A5-51) CRCF-ESD11-WP-TAD (#2) (Figure A5-52)	Welding of the waste package lid causes canister breach	No plausible scenarios have been identified whereby the gas tungsten arc welding process could cause burn through of the waste package and canister (Ref. 2.2.15). Therefore, event sequences associated with this initiating event are considered to be physically unrealizable.
CRCF-ESD14-DPC (#3) (Figure A5-59) CRCF-ESD14-TAD (#3) (Figure A5-60)	Site transporter or aging overpack catches crane hook or rigging resulting in impact to the aging overpack	This initiating event is subsumed within the initiating event for site transporter collision (Branch #2 of the listed event tree in each case).
CRCF-ESD15-WP-H&D (#2) (Figure A5-61) CRCF-ESD15-WP-H&M (#2) (Figure A5-62) CRCF-ESD15-WP-TAD (#2) (Figure A5-63)	TEV collision with stationary waste package	The TEV is parked in the Waste Package Loadout Room when the waste package enters via the WPTT, and cannot collide with the waste package. The WPTT is on rails so its path is well defined. The TEV is separated from the WPTT by the docking station. Even a TEV and/or WPTT derailment can not cause a collision between the two because of the extremely slow speed of these vehicles. Therefore, event sequences associated with these initiating events are considered to be physically unrealizable.
CRCF-ESD13-H&D (#4) (Figure A5-55) CRCF-ESD13-H&M (#4) (Figure A5-57) CRCF-ESD13-TAD (#4) (Figure A5-58)	Tilt-down of WPTT at uncontrolled speed	The main feature of the WPTT is the shielded enclosure, which holds the waste package, the waste package pallet, the waste package transfer carriage, and the waste package pedestal (Ref. 2.2.26, Section 2.1.1). The enclosure pivots between vertical and horizontal orientations to position the waste package for loading and unloading. There are two sets of redundant tipping motor-and-gear systems, each of which is designed to withstand the maximum possible torque without failure. If one motor-and-gear system were to fail, the shielded enclosure would still be supported. The center of gravity of the shielded enclosure is positioned such that the vertical position is the most stable position (Ref. 2.2.26, Section 3.3.2). Therefore, even in the unlikely event that both motor-and-gear systems fail catastrophically, the shielded enclosure would not undergo tilt-down at uncontrolled speed.

Table 6.0-2. Bases for Screening Internal Initiating Events (Continued)

Initiator Event Tree (Branch No.)	Initiating Event Description	Screening Basis
<p>CRCF-ESD06-DPC (No applicable branch) (Figure A5-22)</p> <p>CRCF-ESD06-DSTD (No applicable branch) (Figure A5-24)</p> <p>CRCF-ESD06-HLW (No applicable branch) (Figure A5-25)</p> <p>CRCF-ESD06-MCO (No applicable branch) (Figure A5-26)</p> <p>CRCF-ESD06-TAD (No applicable branch) (Figure A5-27)</p>	<p>Tipover of CTT</p>	<p>The CTT is designed to prevent tip over. (Ref. 2.2.24, Section 3.2). The size, weight, low center of gravity, and low speed of the CTT ensure that no tipover can occur. During cask preparation activities, the CTT is normally set on the floor inside the cask preparation platform. As such, tip over is not physically realizable during preparation activities. During transit, the CTT glides slowly on a cushion of air, an inch or less above the floor. If air pressure is lost, the CTT, with its load, settles to the floor. While the CTT is in transit, or after settling to the floor, any applied force from facility operations is incapable of tipping over the CTT. Due the slow travel of the CTT, a loss of air pressure or a collision with other equipment or a facility structure will not result in tip over. Therefore, tip over of the CTT is considered physically unrealizable for internal events. CTT tipover, however, is analyzed in the seismic event sequence and categorization analysis.</p>
<p>No applicable event trees</p>	<p>Conveyance carrying a waste form collides with a shield door, causing the door to dislodge from its supports and fall onto the waste form</p>	<p>The shield doors are designed to withstand collision of the conveyance into the door without dislodging from their supports such that the stress of all support mechanisms of the door stay below yield. Therefore, this initiating event is considered physically unrealizable.</p>
<p>No applicable event trees</p>	<p>Canister dropped into the Cask Unloading Room or Waste Package Positioning Room with no waste package present</p>	<p>Dropping a canister through a port without a staged waste package below would require a series of human failures and mechanical failures that makes the initiating event unlikely. The design incorporates an interlock to prevent the opening of the waste package port slide gate when the WPTT and waste package shield ring are not present (Ref. 2.2.37). The combination of (a) failure to stage the waste package, (b) failure of more than one operator to notice that it is not staged, (c) failure of the hardwired interlock, and (d) drop of the canister are required for such an initiating event to occur. Considering the combination of unlikely events that must occur to cause this initiating event, event sequences involving this combination of failures are judged to contribute insignificantly to the frequency of the grouped event sequences of which they would be a part.</p>
<p>No applicable event trees</p>	<p>Internal flooding</p>	<p>Internal flooding as an initiating event is screened from further analysis in Section 6.0.4.</p>
<p>No applicable event trees</p>	<p>More than four standardized DOE SNF canisters in single location.</p>	<p>Due to potential criticality implications, more than four standardized DOE SNF canisters must not be put in close proximity without controls on their interaction. The only places where more than four DOE SNF canisters can fit and reasonably be put in uncontrolled proximity is in a TAD waste package, a TAD canister staging rack, or an aging overpack. A series of human errors would be necessary for a misload of this type. For example, a TAD waste package could be erroneously staged in the Waste Package</p>

Table 6.0-2. Bases for Screening Internal Initiating Events (Continued)

Initiator Event Tree (Branch No.)	Initiating Event Description	Screening Basis
		Positioning Room and loaded with multiple DOE SNF canisters (whereas the codisposal waste package is designed to accommodate only one standardized DOE SNF canister). The potential for misloads of this kind has been addressed by a reliance on a combination of human actions and design solutions. Although there are a number of potential locations where a misload of this kind could occur, the one that requires the least deviation from normal operations is staging the wrong waste package. For this case, a screening argument is provided below. The other cases are bounded by the analyzed case because they require a longer series of human failure events.
		There are approximately 385 transportation casks and 3,300 waste packages containing DOE SNF that are unloaded or loaded in the CRCF. The probability of an operator attempting to place more than one DOE SNF canister into a TAD waste package or into a TAD canister staging rack is estimated to be 1E-03 (060-OpDSNFLoad-HFI-NOD) per operation set (where an operation set is the loading of a waste package or the unloading of a transportation cask to the staging rack). To prevent this error, there is an interlock that allows a canister to be emplaced in the waste package or canister staging rack only if the CTM is centered with the receptacle. The demand failure rate for the interlock is 2.7E-06. This interlock is not bypassed during normal operations or regular maintenance. For a second DOE SNF canister to be placed in a TAD waste package or TAD staging rack, the interlock would have to fail. The expected number of occurrences of placing two DOE SNF canisters in a TAD waste package or a TAD canister staging rack is estimated as $[2.7E-06 \times 1E-03 \times (3300+385)]=1E-05$ over the preclosure period. Thus, placing just two DOE SNF canisters in a TAD waste package is Beyond Category 2. Further errors of the same kind would have to be repeated to accumulate five or more canisters in the TAD waste package. The potential for criticality for five or more canisters applies to only a small fraction of DOE SNF canisters. The screening argument conservatively does not include this consideration, which would further lower the estimated event sequence frequency.
No applicable event trees	Explosion of site prime mover fuel tank	The fuel tank of the site prime mover has safety features that preclude fuel tank explosion. Therefore, this initiating event is considered physically unrealizable.

NOTE: Initiator event trees are provided in Attachment A in the figures cited. The branch numbers are shown in each figure under the column labeled "#". CTM = canister transfer machine; CTT = cask transfer trolley; DPC = dual-purpose canister; H&D = HLW & DOE Standardized Canister; H&M = HLW & MCO; HLW = high-level radioactive waste; MCO = multiccanister overpack; TEV = transport and emplacement vehicle; WP = waste package; WPTT = waste package transfer trolley.

Source: Original

6.0.4 Screening of Internal Flooding as an Initiating Event

By the definition of an event sequence, a flood inside a facility would be an initiating event if it led to a sequence of events that would either breach waste containers, causing a release, or caused elevated radiological exposure without a release (i.e., direct exposure of personnel). Internal floods, whether caused by random failure or earthquakes, emerge from two sources. The first is inadvertent actuation of the fire-suppression system. The second is failure of water-carrying pipes or valves associated with chilled water, hot water, potable water, or other water systems. Drains, channels and curbs are situated to remove water from these sources. However, the following discussion does not rely on these.

Transportation casks, canisters, and waste packages are not physically susceptible to breach associated with water in the short-term. With extremely long exposure to water, corrosion may be a factor but intervention to drain water from the buildings would prevent such exposure. Short-term breaches do not occur owing to exposure to water. Canisters are surrounded by transportation casks, and waste packages. Casks are elevated as all times at least five feet above the floor by railcar, truck, or canister transfer trolley. Waste packages are similarly elevated on the waste package transfer trolley. Inside the TEV, the waste package is elevated approximately one foot above the floor. A lifted canister or/and cask is higher than these minimum elevations. Therefore, water from fire suppression and other water systems is unlikely to attain a depth that would contact transportation casks, waste packages, or canisters. Of greater significance, however, is that the fuel is contained in canisters within an overpack nearly all the time and these containers do not fail from short-term exposure to flood water. In this context, short-term is a time period that is at least 30 days but less than the length of time in which significant corrosion may occur.

Water impingement on electrical equipment (e.g., motor control centers, motors, and switchgear cabinets) would ordinarily trigger circuit protection features that would open the circuit and cause a loss of electrical power (which is covered in Section 6.0.2.2). If a short circuit occurred as a result of water impingement, normal circuit protection features or overheating of the wires would subsequently open the affected circuit. In an extreme situation, an electrical fire might be started. Fires from all causes are covered in Section 6.5.

The possibility of inadvertent direct exposure of workers due to internal flooding is considered next. Direct exposure to workers during a flood would occur if shielding were disabled as a result of the flooding. Canisters are always shielded during facility operations by transportation casks, cask preparation platforms, concrete floors and walls, the CTM shield bell or shield skirt, the WPTT, CTT, shield doors, or the shield compartment of the TEV. Loss of electrical power to any of these simply stops operation, if any, without affecting the shielding. Flooding might also cause hot shorts in control boxes. However, hardwired interlocks between the CTM slide gate, shield bell skirt, and shield doors prevents such inadvertent motion. Therefore, internal flooding cannot initiate an event sequence that causes increased levels of radiological exposure to workers.

Moderator intrusion into canisters resulting from event sequences that might breach a waste container is treated quantitatively as described in the pivotal event descriptions of Section 6.2.

6.1 EVENT TREE ANALYSIS

The event trees that are quantified in this analysis were developed from ESDs in the *Canister Receipt and Closure Facility Event Sequence Development Analysis* (Ref. 2.2.33, Attachments F and G). This section describes the use of SAPHIRE (Section 4.2) to model event sequences. The event trees are discussed and presented in Attachment A.

6.1.1 Event Tree Analysis Methods

6.1.1.1 Linked Event Trees and Fault Trees

As described in Section 4, the PCSA uses linked event trees with linked fault trees to calculate the frequency of occurrence of event sequences. The SAPHIRE computer program (Section 4.2) is used for this purpose. The event tree quantification is supported by fault tree analysis (FTA) (Section 6.2 and Attachment B), HRA (Section 6.4 and Attachment E), and PEFA (Section 6.3 and Attachment D). The YMP preclosure handling is performed using four kinds of buildings as summarized below:

1. The Receipt Facility (RF) accepts DPC and TAD canisters and places them into aging overpacks, either destined for the aging pads or the CRCF.
2. The CRCF accepts all waste containers except those supplied by the Naval Nuclear Propulsion Program (NNPP) for placement into waste packages destined for emplacement in the repository emplacement drifts. Three CRCFs are currently considered. This analysis models throughput from all three CRCFs as if it goes through a single building.
3. The WHF accepts DPCs and transportation casks containing uncanistered commercial SNF, transfers the SNF to TAD canisters which are destined for the CRCF or the aging pads.
4. The Initial Handling Facility (IHF) accepts canisters from the NNPP and some canisters containing high-level radioactive waste for placement in waste packages destined for emplacement in the repository emplacement drifts.

Preclosure waste handling as modeled in the PCSA also includes TEV and Subsurface Operations. The TEV accepts waste packages from the CRCF and IHF and, by means of rail, transports it and deposits it into its designated location in the emplacement drifts. All other extra-building transportation, low-level waste handling, and balance of plant is called Intra-Site Operations.

Event sequences are developed for each of the four building types, TEV and Subsurface Operations, and Intra-Site Operations. Because each type of waste container in the CRCF has different characteristics that manifest during event sequences, separate event sequences are developed for each type of waste container. As described in the *Canister Receipt and Closure Facility Event Sequence Development Analysis* (Ref. 2.2.33), event sequences are also developed separately for each major group of waste handling processes, by location within the building. Therefore, event sequences also distinguish among the various steps in waste handling.

As described in Section 4.3, event sequences result in one of the following end states:

1. “OK”
2. Direct Exposure, Degraded Shielding
3. Direct Exposure, Loss of Shielding
4. Radionuclide Release, Filtered (HVAC)
5. Radionuclide Release, Unfiltered (HVAC system is not operating)
6. Radionuclide Release, Filtered, Also Important to Criticality
7. Radionuclide Release, Unfiltered, Also Important to Criticality
8. Important to Criticality (not applicable to the CRCF)

Radionuclide release describes a condition where radioactive material has been released from the container creating a potential inhalation or ingestion hazard, accompanied by the potential for immersion in a radioactive plume and direct exposure.

The SAPHIRE computer program has advanced features that permit the analyst to control the inputs and conditions for quantifying linked event trees and fault trees. One feature is the use of “basic rules” by which the analyst tells the program how and when to link certain variations of fault trees and basic event data that describe a given initiating and pivotal event. This allows path dependent development of sequence minimal cut sets and probabilities.

The primary inputs to the program are the following:

- Event tree logic models
- Fault tree logic models for initiating and pivotal events
- Initiating event frequencies derived from waste-form throughputs and numbers of opportunities for initiating an event sequence
- Basic event data that provides failure rates for active and passive equipment and for HFEs. The basic event data also includes a probability distribution of uncertainty associated with each basic event. The event tree and fault tree logic models are linked to the basic event library.

Each basic event is characterized by a probability distribution. SAPHIRE’s Monte Carlo sampling method is employed to propagate the uncertainties to obtain event sequence mean values and parameters of the underlying probability distribution such as variance. As described in Section 4.3.6, categorization is done on aggregated event sequences, whose resultant probability distributions are also obtained by Monte Carlo simulation. SAPHIRE accounts for the correlation between analogous basic events sharing the same reliability information, which ensures the spread of the probability distribution of the event sequences in which these basic events intervene is not underestimated.

6.1.1.2 Initiator, System-Response, and Self-Contained Event Trees

Event sequences are described and graphically depicted using one or two event trees depending on whether the ESD considered has one or more initiating events:

1. **Self-contained event trees.** Self-contained event trees are used when only one initiating event appears in the corresponding ESD (Ref. 2.2.33, Attachment F). An example is CRCF-ESD07-DPC, which is shown in Figure A5-28 in Attachment A. The feed on the left side of the event tree is an event that represents the frequency of the challenge to the successful operation of the process step represented in the event tree. In the example, the frequency of challenge is equal to the number of transportation casks containing DPCs that are handled over the preclosure period. The initiating event is presented next, followed by the pivotal events. By convention, the description of each branching event is stated as a success. The branching under each event heading represents success by an upward branch and failure by a downward branch. If a given pivotal event cannot occur in a given sequence due to a prior pivotal event or is irrelevant to the sequence, it does not appear in the event sequence as illustrated in the corresponding ESD and no branching occurs in the event tree. Each pathway through a self-contained event tree terminates in an end state. End states that are labeled “OK” mean that the sequence of events does not result in one of the specifically identified undesired outcomes. “OK” often means that normal operation can continue. The undesired end states represent a release of airborne radioactivity, a direct exposure to radiation, or a potential criticality condition.
2. **Separate initiator and system-response event trees.** Separate event trees for initiating events and the system response are used when more than one initiating event appears in the corresponding ESD (Ref. 2.2.33, Attachment F). The initiator event tree decomposes a group of initiating events into the specific failure events that comprise the group. For example, an initiator event tree, CRCF-ESD01-DPC, is shown in Figure A5-2 in Attachment A, and the corresponding system response event tree, RESPONSE-TCASK1, is shown in Figure A5-3. The feed to the left side of the initiator event tree is an event that represents the frequency of challenge to the successful operation of the process step represented in the event tree. In the example, the frequency of challenge is equal to the number of transportation casks containing DPCs that are received during the preclosure period. Initiator event trees do not end at end states but transfer to a system response event tree. The models to be used for the initiating events associated with each initiator event tree are specified in SAPHIRE “basic rules,” which are attached to the initiator event tree.

System response event trees contain only pivotal events. In accordance with the basic rules that are written for a given initiator event tree, the SAPHIRE program links specific fault tree model or basic event to a given pivotal event. For example, the system response tree in Figure A5-3 shows the system response event tree RESPONSE-TCASK1. Because the conditional probability of each pivotal event may be specific to the initiating event for each event sequence, the same system response event tree is quantified by SAPHIRE as many times as there are initiating events in the initiator event tree. The models to be used for the pivotal events

associated with each initiating event and system response event tree are specified in SAPHIRE basic rules, which are attached to the associated initiator event tree.

6.1.1.3 Summary of the Major Pivotal Events

A self-contained event tree or a system response event tree may include pivotal events concerning the success or failure of the waste package, transportation cask, canister, shielding properties, HEPA filtration availability, and moderator intrusion susceptibility. The pivotal events are summarized in Attachment A, Section A3.

Each of the specific failure events included in a self-contained or system-response event tree may be linked to a basic event or to the top event of a fault tree. Two kinds of fault trees are developed and represented in Attachment B. The first type represents equipment fault trees including HFEs that contribute directly to the specific pivotal or initiating event. The second type links initiating and pivotal events to these equipment fault trees (via transfer gates) and miscellaneous events. This second type is called linkage or connector fault trees. The equipment fault tree models are, in turn, linked to basic event reliability information separately entered into SAPHIRE. Some of the pivotal events do not have associated fault trees because they are linked directly to probabilities in the reliability database entered into SAPHIRE. Section 6.2 provides more information about the reliability information developed for this analysis.

6.1.2 Waste Form Throughputs

Each initiator event tree and self-contained event tree begins with the container throughputs, that is, the numbers of waste form units (such as casks, canisters, or waste packages) to be handled over the life of the CRCF. The throughputs are identified in Table 6.1-1 and are drawn into the descriptions of specific event trees as needed. With the number of waste form units as a multiplier in the event tree and the initiating events specified as a probability per waste form unit, the value passed to the system response is the number of occurrences of the initiating event expected over the life of the facility.

Table 6.1-1. Waste Form Throughputs for the CRCF Over the Preclosure Period

Waste Form Unit	CRCF Throughput Over Preclosure Period	Comments
HLW transportation cask	1,960 ^a	Five canisters per cask
Defense SNF (standardized) transportation cask	385 ^a	Five to nine canisters per cask
MCO transportation cask	113 ^a	Four canisters per cask
DPC transportation cask	346 ^a	One canister per cask
TAD canister transportation cask	6,978 ^a	One canister per cask
Aging overpacks containing a TAD canister (outgoing)	6,978 ^a	Bounding number based on every TAD canister arriving by transportation cask going to aging pad
Aging overpacks containing a TAD canister (incoming)	8,143 ^a	Includes TAD canisters from aging pad and from WHF

Table 6.1-1. Waste Form Throughputs for the CRCF Over the Preclosure Period (Continued)

Waste Form Unit	CRCF Throughput Over Preclosure Period	Comments
HLW canisters	9,801 ^b	Bounding number based on all HLW canisters going through CRCF
DOE standardized canister transfers by CTM	3,300 ^b	
MCOs	451 ^b	
DPCs	346 ^a	Same as number of DPC casks
TAD canisters	6,978 ^a	Same as number of TAD canister casks
Aging overpacks containing DPC (outgoing)	346 ^a	Same as number of DPC casks
Waste packages containing 1 DOE standardized canister and 4 to 5 HLW canisters	3,300 ^a	
Waste packages containing 2 HLW canisters and 2 MCOs	225 ^a	
Waste packages loaded with a TAD canister	8,143 ^a	Includes TAD canisters from aging pad and from WHF
Waste packages (all types produced at canister receipt and closure facilities)	11,668 ^a	

NOTE: CRCF = Canister Receipt and Closure Facility; CTM = canister transfer machine; DOE = U.S. Department of Energy; DPC = dual-purpose canister; HLW = high-level radioactive waste; MCO = multiccanister overpack; SNF = spent nuclear fuel; TAD = transportation, aging, and disposal canister; WHF = Wet Handling Facility.

Source: ^{a,b}(Ref. 2.2.31, ^bTable 3, ^aTable 4).

6.1.3 Guide to Event Trees

Event trees are located in Attachment A. Table 6.1-2 contains the crosswalk from the ESD (Ref. 2.2.33, Attachment F) to the initiating event tree and response tree figure location in Attachment A.

Table 6.1-2. Figure Locations for Initiating Event Trees and Response Trees

ESD#	ESD Title	IE Event Tree Name	IE Event Tree Location	Response Tree Name	Response Tree Location
CRC-ESD-01	Event Sequences for Activities Associated with Receipt of TC in Transportation Cask Vestibule and Movement into Cask Preparation Room	CRCF-ESD01-DPC CRCF-ESD01-DSDT CRCF-ESD01-HLW CRCF-ESD01-MCO CRCF-ESD01-TAD	Figure A5-2 Figure A5-4 Figure A5-5 Figure A5-6 Figure A5-7	RESPONSE-TCASK1	Figure A5-3

Table 6.1-2. Figure Locations for Initiating Event Trees and Response Trees (Continued)

ESD#	ESD Title	IE Event Tree Name	IE Event Tree Location	Response Tree Name	Response Tree Location
CRC-ESD-02	Event Sequences for Activities Associated with Receipt of AO in Site Transporter Vestibule and Movement into Cask Preparation Room	CRCF-ESD02-TAD	Figure A5-8	RESPONSE-AO1	Figure A5-9
CRC-ESD-03	Event Sequences for Activities Associated with Removal of Impact Limiters, Upending and Transfer of TC to CTT	CRCF-ESD03-DPC CRCF-ESD03-DSTD CRCF-ESD03-HLW CRCF-ESD03-MCO CRCF-ESD03-TAD	Figure A5-10 Figure A5-11 Figure A5-12 Figure A5-13 Figure A5-14	RESPONSE-TCASK1	Figure A5-3
CRC-ESD-04	Event Sequences for Cask Preparation Activities Associated with Unbolting and Lid Adapter Installation	CRCF-ESD04-DPC CRCF-ESD04-DSTD CRCF-ESD04-HLW CRCF-ESD04-MCO CRCF-ESD04-TAD	Figure A5-15 Figure A5-16 Figure A5-17 Figure A5-18 Figure A5-19	RESPONSE-TCASK1	Figure A5-3
CRC-ESD-05	Event Sequences for AO Preparation Activities Associated with Unbolting and Lid Adapter Installation	CRCF-ESD05-TAD	Figure A5-20	RESPONSE-CANISTER1	Figure A5-21
CRC-ESD-06	Event Sequences Associated with Transfer of Cask on CTT or an AO on ST from Cask Preparation Room to Cask Unloading Room	CRCF-ESD06-DPC CRCF-ESD06-DSTD CRCF-ESD06-HLW CRCF-ESD06-MCO CRCF-ESD06-TAD	Figure A5-22 Figure A5-24 Figure A5-25 Figure A5-26 Figure A5-27	RESPONSE-TCASK2	Figure A5-23
CRC-ESD-07	Event Sequences Associated with Collision of CTT or ST with Cask Unloading Room Shield Door	CRCF-ESD07-DPC CRCF-ESD07-DSTD CRCF-ESD07-HLW CRCF-ESD07-MCO CRCF-ESD07-TAD CRCF-ESD07-WP-H&D CRCF-ESD07-WP-H&M CRCF-ESD07-WP-TAD	Figure A5-28 Figure A5-29 Figure A5-30 Figure A5-31 Figure A5-32 Figure A5-33 Figure A5-34 Figure A5-35	N/A	N/A
CRC-ESD-08	Event Sequences Associated with Collision of two CTMs Loaded with Canisters	CRCF-ESD08-DPC CRCF-ESD08-DSTD CRCF-ESD08-HLW CRCF-ESD08-MCO CRCF-ESD08-TAD	Figure A5-36 Figure A5-37 Figure A5-38 Figure A5-39 Figure A5-40	RESPONSE-CANISTER1	Figure A5-21

Table 6.1-2. Figure Locations for Initiating Event Trees and Response Trees (Continued)

ESD#	ESD Title	IE Event Tree Name	IE Event Tree Location	Response Tree Name	Response Tree Location
CRC-ESD-09	Event Sequences for Activities Associated with Lifting and Lowering a Canister during Transfer to or from Staging, TC, WP, or AO with CTM	CRCF-ESD09-DPC CRCF-ESD09-DSTD CRCF-ESD09-HLW CRCF-ESD09-MCO CRCF-ESD09-TAD	Figure A5-41 Figure A5-42 Figure A5-43 Figure A5-44 Figure A5-45	RESPONSE-CANISTER1	Figure A5-21
CRC-ESD-10	Event Sequences for Activities Associated with WP Transfer from WP Loading Room to Closing Position in WP Positioning Room below WP Closure Room	CRCF-ESD10-WP-H&D CRCF-ESD10-WP-H&M CRCF-ESD10-WP-TAD	Figure A5-46 Figure A5-48 Figure A5-49	RESPONSE-WP1	Figure A5-47
CRC-ESD-11	Event Sequences for Activities Associated with Assembly and Closure of WP	CRCF-ESD11-WP-H&D CRCF-ESD11-WP-H&M CRCF-ESD11-WP-TAD	Figure A5-50 Figure A5-51 Figure A5-52	RESPONSE-WP1	Figure A5-47
CRC-ESD-12	Event Sequences for Activities Associated with Assembly and Closure of AO	CRCF-ESD12-DPC CRCF-ESD12-TAD	Figure A5-53 Figure A5-54	RESPONSE-AO1	Figure A5-9
CRC-ESD-13	Event Sequences for Activities Associated with Transfer of WP from WP Closure Room to WPTT Docking Station	CRCF-ESD13-WP-H&D CRCF-ESD13-WP-H&M CRCF-ESD13-WP-TAD	Figure A5-55 Figure A5-57 Figure A5-58	RESPONSE-WP2	Figure A5-56
CRC-ESD-14	Event Sequences for Activities Associated with Transfer of AO from Cask Unloading Room to Cask Preparation Room	CRCF-ESD14-DPC CRCF-ESD14-TAD	Figure A5-59 Figure A5-60	RESPONSE-AO1	Figure A5-9
CRC-ESD-15	Event Sequences for Activities Associated with Exporting of WP from CRCF	CRCF-ESD15-WP-H&D CRCF-ESD15-WP-H&M CRCF-ESD15-WP-TAD	Figure A5-61 Figure A5-62 Figure A5-63	RESPONSE-WP2	Figure A5-56

Table 6.1-2. Figure Locations for Initiating Event Trees and Response Trees (Continued)

ESD#	ESD Title	IE Event Tree Name	IE Event Tree Location	Response Tree Name	Response Tree Location
CRC-ESD-16	Event Sequences for Activities Associated with Exporting of AO from CRCF	CRCF-ESD16-DPC CRCF-ESD16-TAD	Figure A5-64 Figure A5-65	RESPONSE-AO1	Figure A5-9
CRC-ESD-17	Event Sequences for Activities Associated with Direct Exposure During Cask Preparation Activities	CRCF-ESD17-DPC CRCF-ESD17-DSTD CRCF-ESD17-HLW CRCF-ESD17-MCO CRCF-ESD17-TAD	Figure A5-66 Figure A5-67 Figure A5-68 Figure A5-69 Figure A5-70	N/A	N/A
CRC-ESD-18	Event Sequences for Activities Associated with Direct Exposure During CTM Activities	CRCF-ESD18-DPC CRCF-ESD18-DSTD CRCF-ESD18-HLW CRCF-ESD18-MCO CRCF-ESD18-TAD	Figure A5-71 Figure A5-72 Figure A5-73 Figure A5-74 Figure A5-75	N/A	N/A
CRC-ESD-19	Event Sequences for Activities Associated with Direct Exposure During Closure and Exporting Loaded WP	CRCF-ESD19-WP H&D CRCF-ESD19- WP H&M CRCF-ESD19-WP- TAD	Figure A5-76 Figure A5-77 Figure A5-78	N/A	N/A
CRC-ESD-20	Event Sequences for Fire Occurring in Canister Receipt and Closure Facility	CRCF-ESD20-DPC CRCF-ESD20-DSTD CRCF-ESD20-HLW CRCF-ESD20-MCO CRCF-ESD20-TAD CRCF-ESD20-WP- H&D CRCF-ESD20-WP- H&M	Figure A5-79 Figure A5-81 Figure A5-82 Figure A5-83 Figure A5-84 Figure A5-85 Figure A5-86	RESPONSE-FIRE	Figure A5-80

NOTE: AO = aging overpack; CRCF = Canister Receipt and Closure Facility; CTM = canister transfer machine; CTT = cask transfer trolley; N/A = not applicable; ST = site transporter; TC = transportation cask; WP = waste package; WPTT = waste package transfer trolley.

Source: Attachment A, Table A5-1

6.2 ANALYSIS OF INITIATING AND PIVOTAL EVENTS

6.2.1 Approach to Analysis of Initiating and Pivotal Events for Linking to Event Sequence Quantification

Section 4.3.2 provides a brief introduction to the application of fault tree analysis (FTA) for initiating and pivotal events, including an example fault tree. Many of the initiating events involve faults in complex machinery for which no historical data exists at the system level, an exception being, historical data on load drops from cranes. Therefore, FTA is employed to map elements of equipment design and operational features to various failure modes of components down to a level of assembly, termed “basic events” for which historical data is available. Attachment B presents the fault tree logic and stand-alone quantifications.

Much of the equipment used in the CRCF is also used in other surface facilities and the Intra-Site operations. Furthermore, a given system, such as the site transporter, may affect the event sequences for several operational nodes of the same facility or several kinds of waste forms, as it does for the CRCF. Therefore, the logic of the fault trees described in this section and Attachment B are linked to event trees where appropriate, via an intermediate top event name that is unique to the event sequence per the waste form involved and operational node. In this way, the logic structure of the system fault tree may be used over and over but, by virtue of the rules feature of SAPHIRE, the inputs to each fault tree can be tailored to fit the event sequence.

The fault trees are linked to the event trees via the initiating event tree rules file and the application of linking fault trees. The rules file specifies the names of the linking fault trees for initiating event and pivotal event fault trees to be substituted into the event tree top events during quantification. The rules files also specify the use of particular values for basic events and other probabilistic factors that affect the event sequence quantification. The linking fault trees have unique names for the facility and the operational nodes for each event tree. The linking fault trees are very simple, usually having a single top event that is an OR gate that connects to one of the system fault trees. This allows for application of unique top event probabilities to the different initiating events modeled in the initiating event tree.

Attachment B, Sections B1 to B8, presents all of the system fault trees. The present section describes the bases for the system fault trees and the quantification of their top events.

Attachment B, Section B9, presents all of the linking fault trees used in the CRCF analysis. The linking fault trees are self explanatory. No quantification is performed for the linking trees alone.

A top event occurs when one of the (ITS) success criterion for a given SSC fails to be achieved. At least one success criteria is defined for each system. Multiple success criterion are defined for systems that perform multiple safety functions in the CRCF.

Each of the top events for the initiating event fault trees represent the conditional probability that the top event will occur when the system is put into service. That is, the results of the FTA answer a question such as “what is the probability for each canister lift that the CTM drops the canister, given a lift?” The expected number of canister drop initiating events during the preclosure period is the product of the number of times a canister is lifted during the preclosure operations and the conditional probability of the top event. Such values for the expected number

of canister drops are not developed directly, however. Instead, the initiating event tree in SAPHIRE links the various fault tree logic models to the canister, or other waste form, and the throughput values to generate the initial portions of event sequence cut sets that are subsequently processed as part of the solution of the complete event sequence that includes pivotal events.

By contrast, the top event for the confinement function of the HVAC represents the conditional probability that the confinement feature is not achieved for the required duration following an airborne release of radioactive material inside the CRCF. The quantification of the top event, as summarized in Section 6.2.2.7 and detailed in Attachment B7, is expressed as unavailability. The results provide insight into the reliability of the HVAC and its contribution to event sequence quantification. Again, the quantified top event is not used directly in the event sequence quantification. Instead, the fault tree logic for the HVAC is linked to event sequence analysis via SAPHIRE.

In general, each of the FTAs in Attachment B is developed to include both (1) HFEs, and (2) mechanical failures that result in the occurrence of the top event. The HFEs include postulated unintended operator actions that could potentially occur during the facility activity and, as applicable, hardware failures for those SSCs whose functions are to prevent the top event from occurring given the unintended operator action occurs (e.g., interlock). Mechanical failures typically involve random component failures (electrical, mechanical, etc.) and failures from the loss of a supporting system (e.g., loss of power).

For quantification of the probability of the top event, failure probabilities are developed for each basic event (hardware or HFE) and are used to compute the probability of each cut set. For component failure data that is expressed as “failures per hour,” a “mission time” must be defined. In many instances in the FTA quantification, a mission time of one hour is used if this value is conservative. Where mission time is critical, appropriate times are justified and incorporated into the event sequence quantification. Hardware failure probabilities are taken from the reliability analysis data discussed in Sections 6.3. HFE probabilities are taken from the HFE analysis discussed in Section 6.4.

Uncertainties in the probabilities of basic events are included in the inputs to the SAPHIRE analysis. The uncertainties are propagated through the FTA to yield the uncertainty distribution of the top event.

Issues that are addressed in the fault trees, in addition to the mapping of the descriptions of the physical system into a fault tree logic diagram based on explicit effects of mechanical and hardware failures, include the following:

- Basic event data
- Common-cause and common-mode failures such as failures induced by common training, maintenance practices, fabrication, common electrical supplies, etc.
- Support systems and subsystems such as cooling (HVAC, cooling water), electrical, etc.
- System interactions

- HFEs
- Control logic malfunctions.

The following subsections provide summaries of the analyses detailed in Attachment B. For each fault tree, the following information is provided:

- Physical description
- Operation
- Control system
- System/pivotal event success criteria
- Mission time
- Fault tree results.

6.2.2 Summary of Fault Tree Analysis

6.2.2.1 Site Prime Mover Fault Tree Analysis

The FTA is detailed in Attachment B1. The following is a summary of the design, operations, success criteria, and results of the fault tree quantification. See Attachment B, Section B1 for sources of information on the physical and operational characteristics of the SPM.

6.2.2.1.1 Physical Description

The site prime mover (SPM) is a diesel/electric self-propelled vehicle that is designed to move railcars or truck trailers loaded with transportation casks. The transport occurs for both the Intra-Site operations and within the CRCF. A speed limiter is used on the SPM to ensure the maximum speed does not exceed nine miles per hour. Movement of the SPM with railcars (termed SPMRC) or SPM with truck trailers (termed SPMTT) within the CRCF is limited to the Cask Preparation Room. Retractable railroad wheels attached to the front and rear axles of the SPM are used for rail operations. The driving and braking power comes directly from the road tires, as they are in contact with the rails. A diesel engine provides the energy to operate the SPM outside the facilities. Inside, the SPM is electrically driven via an umbilical cord (or remote control) from the facility main electrical supply.

6.2.2.1.2 Operations

In-facility SPM operations begin after the SPM has positioned the railcar or truck trailer outside the CRCF. The site prime mover diesel engine is shut down and the outer door is opened. Facility power is connected to the SPM for all operations inside the facility. The operator connects the pendant controller or uses a remote (wireless) controller to move the SPM to push the railcar or truck trailer into the vestibule.

In the event of loss of power, the SPM is designed to stop, retain control of the railcar or truck trailer, and enter a locked mode where it remains until operator action is taken, to return to normal operations.

6.2.2.1.3 Control System

A simplified schematic of the functional components on the SPMRC/truck trailer is shown in Attachment B, Section B1, Figure B1.2-1.

The control system provides features for preventing initiating events:

- The SPM is designed to stop whenever 1) commanded to stop or 2) when there is a loss of power.
- The operator can stop the SPM by either commanding a “stop” from the start/stop button or by releasing the palm switch which initiates an emergency stop.
- At anytime there is a loss of power detected, the SPM will perform a controlled stop. Once stopped, the SPM enters into “lock mode” safe state. The SPM will remain in this locked mode until power is returned and the operator restarts the SPM.

6.2.2.1.4 System/Pivotal Event Success Criteria

Success criteria for the SPM are the following:

- Prevent SPMRC AND SPMTT collisions
- Prevented SPMRC derailment
- Prevent SPMTT rollover.

Various design features are provided to achieve each of the success criteria. The failure to achieve each success criterion defines the top event of a fault tree for the SPM.

6.2.2.1.5 Mission Time

A nominal one-hour mission time is used to calculate the failure probability for components having a time-based failure rate. One hour is conservative because it does not require more than one hour to disconnect the SPM from the railcar and remove it from the facility. Otherwise, failure-on-demand probabilities are used.

For railcar derailment, the probability is based on the distance traveled inside the CRCF, 0.04 miles, and industry data derailment rate of 1.18E-5 per mile traveled (Attachment C, Table C4-1, DER-FOM).

6.2.2.1.6 Fault Tree Results

The detailed description in Attachment B, Section B1 documents the application of basic event data, CCFs, and HRA.

The SPMRC or SPMTT has three credible failure scenarios:

1. SPM collides with CRCF structures (DPC on railcar or truck trailer)
2. SPMRC derailment (DPC on railcar)
3. SPMTT rollover (DPC on truck trailer).

Each failure mode may occur with various waste forms that are received in the transportation casks.

Results of the analysis are summarized in Table 6.2.-1.

Table 6.2-1. Summary of Top Event Quantification for the SPM

Top Event	Mean Probability	Standard Deviation
SPMRC collides with CRCF structures	4.3E-3	1.0E-2
SPMRC derailment	4.7E-7	7.4E-9
SPMTT rollover	0	0

NOTE: CRCF = Canister Receipt and Closure Facility; SPM = site prime mover; SPMRC = site prime mover railcar; SPMTT = site prime mover truck trailers.

Source: Attachment B, Section B1, Figures B1.4-1, B1.4-6, B1.4-11 and B1.4-14

6.2.2.2 Cask Transfer Trolley Fault Tree Analysis

The FTA for the CTT is detailed in Attachment B, Section B2. The following is a summary of the design, operations, success criteria, and results of the fault tree quantification. See Attachment B, Section B2 for sources of information on the physical and operational characteristics of the CTT.

6.2.2.2.1 Physical Description

The CTT is an air powered machine that is used to transport various vertically oriented transportation casks from the Cask Preparation Room to the Canister Transfer Room. The trolley consists of a platform, a cask support assembly, a pedestal assembly, a seismic restraint system, and an air system.

The CTT will handle a number of different casks so several different pedestals are used to properly position the cask height. Each pedestal sub-component is designed for its respective cask to sit down in a “cavity.” In addition, the cask is restrained in the longitudinal and transverse directions by the cavity walls and restrained in the vertical down direction by the pedestal itself. This design also ensures the cask is positioned correctly. The trolley is positioned within a set tolerance under the cask port in the Canister Transfer Room using bumpers and stops that are bolted to the floor of the Cask Unloading Room and which are designed with bolts that would break to allow the CTT to slide during a seismic event.

In addition, the cask is restrained by two electric powered linkage systems that prevent side motions during a seismic event. Different cask diameters are handled by bolting unique interface clamps on the seismic restraints. When the restraint system is properly positioned next to the

cask, two locking pins are pneumatically actuated to secure the position of the system. If the locking pins are not secured, the CTT will not be able to power up and move/levitate.

The facility compressed air supply inflates air casters beneath the trolley platform, which allow the CTT to rise above the steel floor. The platform mounted hose reel has an air-powered return, a ball valve shut-off, quick disconnect fittings, and a safety air fuse. A main “off/on” control valve and separate flow control/monitoring valves for each air bearing allow adjustment and verification of pressure/flow for each individual bearing. Interlocks for the air are provided to verify the main incoming pressure is not too high, and to verify that all bearings have sufficient air pressure.

End mounted turtle style drive units that are 360-degrees steerable, are used to steer the CTT. Traction is produced by down-pressure on the wheels provided by a small air bag on each drive unit.

The CTT is evaluated for a collision with another object while carrying the cask. The speed of the drives, 10 feet per minute (fpm), has been set so that the forces the cask experiences during a seismic event would envelope a collision. The speed is controlled in two ways. First, the electrical control system is designed to only give a proportional signal to the air valve that produces a speed of 0 to 10 fpm. In the event this control system fails, a factory set mechanical throttle valve, in line with each motor drive, allows a maximum amount of air through at any time to prevent a “run-away” condition.

6.2.2.2.2 Operation

Initially, the CTT is located in the Cask Preparation Room with the battery fully charged, the seismic restraints retracted, and with no air or electrical power connected. Based on the next planned cask to be loaded onto the trolley, the corresponding pedestal components are installed into the base, and bumpers are bolted onto the seismic restraints and supports. The air hose is then connected to the CTT.

The overhead crane moves a cask onto the pedestal. With the cask still attached to the crane, the operator remotely operates the seismic restraints and secures the cask to the CTT. When the restraints are in place, the locking pins are pneumatically inserted remotely. With the cask secured to the CTT, the overhead crane is disengaged from the cask.

When the locking pins are inserted properly, an interlock allows the air bearings and drive motors to be operated. Once all preparations of the cask are complete, the CTT can be raised and moved to the Cask Unloading Room. Guides bolted to the floor insure that the CTT can only move forward and back, and will position the CTT so that the cask is directly below the transfer port. Once in position, the air pressure to the bearings is stopped and the CTT rests in position. The shield doors that separate the Cask Preparation Room from the Canister Transfer Room are then closed.

6.2.2.2.3 Control System

The control system is relay based and includes a pendant station as its operator interface.

No programmable logic controller (PLC) is used – all interlocks are hard wired. The pendant is a standard crane pendant that has all of the controls for the unit including:

- Deadman handle—operator must depress both handles to allow air to flow to the system so the CTT can levitate or move horizontally
- E-stop button on the pendant control and on the CTT
- Clockwise/counterclockwise momentary switch to turn the drive units for horizontal movement. This rotational characteristic is used to move the CTT to storage or maintenance location after it leaves the Cask Preparation Room
- Forward/reverse switch to determine direction of the drive units
- Drive speed—variable speed control switch
- Cask restraint—selector switch that actuates the motor to close the restraints and automatically engage the locking pin.

During normal operations, the controls operate off a battery system contained on the CTT. Only one operator is needed to drive the CTT since it only travels in one direction when it is carrying a cask.

The main air supply valve is a pilot operated solenoid valve that is fail safe (i.e., it is a spring valve that closes upon loss of electrical power or loss of air pressure). The air supply valve opens when the locking pins actuate the limit switches and the pendant deadman switches are actuated.

6.2.2.2.4 System/Pivotal Event Success Criteria

Success criteria for the CTT are the following:

- Ensure the CTT remains stationary with no spurious movement during transportation cask placement onto the CTT, transportation cask preparation, or during unloading
- Prevent collisions while moving the CTT with cask from the Cask Preparation Room to the Cask Unloading Room.

Various design features are provided to achieve each of the success criteria. The failure to achieve each success criterion defines the top event of a fault tree for the CTT.

6.2.2.2.5 Mission time

In all cases a conservative mission time of one hour per cask transfer is used for each fault tree.

6.2.2.2.6 Fault Tree Results

The detailed analysis is presented in Attachment B, Section B2.

There are four fault trees associated with the CTT:

1. Spurious movement in the Cask Preparation Room while loading a cask onto the CTT
2. Spurious movement in the Cask Preparation Room during unbolting and lid adapter installation
3. Spurious movement at the Cask Unloading Room while unloading canisters from the CTT
4. Collision with an object or structure while moving a cask from the Cask Preparation Room to the Cask Unloading Room.

The results of the analysis are summarized in Table 6.2-2. Four fault trees were developed where the top events correspond to one of the scenarios listed above.

Table 6.2-2. Summary of Top Event Quantification for the CTT

Top Event	Mean Probability	Standard Deviation
Spurious movement of the CTT during cask loading	1.8E-9	5.6E-9
Spurious movement of the CTT during cask preparation	1.2E-4	2.0E-4
CTT collision during cask transfer	1.0E-3	1.2E-3
Spurious movement during canister transfer	2.8E-14	1.3E-13

NOTE: CTT = cask transfer trolley.

Source: Attachment B, Section B2, Figures B2.4-1, B2.4-5, B2.4-8 and B2.4-12.

6.2.2.3 Shield Door and Slide Gate Fault Tree Analysis

Each of the CRCF Cask Unloading Rooms and Waste Package Positioning Rooms have a slide gate providing access to the Canister Transfer Room and a shield door providing access to either the Cask Preparation Room or the Waste Package Loadout Room. The shield doors and slide gates provide shielding during canister unloading and loading.

The FTA is detailed in Attachment B, Section B.3. The following is a summary of the design, operations, success criteria, and results of the fault tree quantification.

6.2.2.3.1 Physical Description

The Cask Unloading Rooms' shield doors are opened to allow cask-carrying equipment, such as the site transporter, to enter the room. Once equipment is positioned properly in a Cask Unloading Room, shield doors may be shut in preparation for removing canisters from the cask. Once the shield doors are shut, the slide gate may be opened, to allow the CTM to perform cask unloading operations. Waste package loading operations in the Waste Package Positioning Rooms are analogous to cask unloading operations.

The shield doors consist of a pair of large heavy doors that close together. The doors are operated by individual motors that have over-torque sensors to prevent crushing of an object. Each door has two position sensors to indicate either a closed or open door and an obstruction

sensor prevents the doors from closing on an object. The shield doors and slide gate are interlocked to prevent one another from opening if the other is open. The shield doors are opened and closed via a hand lever that must be enabled by an enable/disable switch. An emergency open switch exists enabling the doors to be opened in case of an emergency situation.

Similar to the shield doors, the slide gate consists of two gates that close together between the Waste Package Loadout Room/Cask Unloading Room and the Canister Transfer Room. The gates are operated by individual motors that also have over-torque sensors. Each gate has limit switches to indicate open or closed gates. A CTM skirt-in-place switch is interlocked to the slide gate to prevent the gates from opening without the CTM in place and a CTM in-place bypass hand switch exists for maintenance activities. Slide gate operation is controlled by a hand switch coupled with an enable/disable switch and shield door interlocks prevent the slide gate from opening when the shield door is open. Open/closed and CTM in-place indicators exist to assist operators in their activities.

6.2.2.3.2 Operation

The Cask Unloading Room shield doors are opened to allow cask-carrying equipment, such as the SPM, to enter the room. Once equipment is positioned properly in an unloading room, shield doors are shut in preparation for removing canisters from the cask. Once the shield doors are shut, the slide gate may be opened to allow the CTM to perform cask unloading operations. Waste package loading operations in the Waste Package Positioning Rooms are analogous to cask unloading operations. The slide gate may be opened to allow waste package loading access if the shield doors are closed. Once loading is complete and the slide gate is closed, the shield doors may be opened to allow waste package removal.

6.2.2.3.3 Control System

The control systems have hard-wired interlocks for the following functions:

- Redundant hardwire interlocks prevent the shield door from opening while the slide gate is open.
- The shield door system will not have any test, maintenance or other modes/settings that will allow bypass of interlocks.
- A single interlock prevents the slide gate from opening when the CTM skirt is not in place.
- An obstruction sensor is provided to detect objects between the shield doors and prevent door closure initiation.
- Motor over-torque sensors are provided to prevent shield doors from causing damage to casks or waste packages in the event of closure on a conveyance.
- Shield doors and slide gates are equipped with redundant hardwire interlocks to prevent one another from opening when the other is open.

6.2.2.3.4 System/Pivotal Event Success Criteria

Success criteria for the shield door and slide gate are the following:

- Prevent inadvertent opening of shield door
- Prevent inadvertent opening of the slide gate
- Prevent concurrent opening of the shield door and slide gate when waste is present
- Prevent shield door closing on conveyance.

Various design features are provided to achieve each of the success criteria. The failure to achieve each success criterion defines the top event for a fault tree for the CTT.

6.2.2.3.5 Mission time

Most of the basic events in the fault tree models are “failure on demand” for equipment failures and “failure per operation” for HFES. A mission time of one hour is used to calculate the probability of a spurious signal being sent due to PLC failure.

6.2.2.3.6 Fault Tree Results

The detailed analysis is presented in Attachment B, Section B3.

The slide gate and shield door system has three credible failure scenarios:

1. Inadvertent opening of the shield door
2. Inadvertent opening of the slide gate
3. Shield door closes on conveyance.

The results of the analysis are summarized in Table 6.2-3. Three fault trees were developed where the top events correspond to one of the scenarios listed above.

Table 6.2-3. Summary of Top Event Quantification for the Shield Doors and Slide Gate

Top Event	Mean Probability	Standard Deviation
Inadvertent Opening of the Shield Door	1.3E-7	2.0E-7
Inadvertent Opening of the Slide Gate	3.6E-9	9.8E-9
Shield Door Closes on Conveyance	1.9E-6	2.8E-6

Source: Attachment B, Section B3, Figures B3.4-1, B3.4-4 and B3.4-7

6.2.2.4 Canister Transfer Machine Fault Tree Analysis

The FTA is detailed in Attachment B, Section B4. The following is a summary of the design, operations, success criteria, and results of the fault tree quantification. See Attachment B, Section B4 for sources of information on the physical and operational characteristics of the CTM.

6.2.2.4.1 Physical Description and Functions

The two identical CTMs operate in the Canister Transfer Room of the CRCF. Their function is to transfer waste canisters from a cask on a CTT or from any aging overpack on a site transporter to another cask or overpack, or to a waste package supported by a WPTT. The CTMs also have the capability to transfer canisters to staging areas for temporary staging for a later transfer to a waste package. The ports in the floor of the Canister Transfer Room provide access to the Cask Unloading Room and Waste Package Loading Room and access to the canister staging areas.

The CTM is an overhead crane bridge with two trolleys. The first is a canister hoist trolley with a grapple attachment and hoisting capacity of 70 tons. The second is a shield bell trolley that supports the shield bell. The bottom end of the shield bell is attached to a larger chamber to accommodate cask lids. The CTM bottom plate assembly supports a thick motorized slide gate. The slide gate, when closed, provides bottom shielding of the canister once the canister is inside the shield bell. Around the perimeter of the bottom plate, a thick shield skirt is provided which can be raised and lowered to prevent lateral radiation shine during a canister transfer operation.

6.2.2.4.2 Operations

A typical CTM canister transfer operation is the transfer of a waste canister from a transportation cask to a waste package. For this operation, a loaded transportation cask, secured in the CTT, is positioned below the transfer port in the Cask Unloading Room. The cask lid is in place but unbolted. Similarly, an empty waste package secured by the WPTT is positioned under the adjacent transfer port in the Waste Package Positioning Room.

The CTM is moved to a position over the center of the port above the loaded cask. The shield skirt is lowered to rest on the floor, and the port slide gate is opened. The CTM slide gate is opened, and the canister grapple is lowered through the shield bell to engage and lift the cask lid. The port slide gate is closed, and the shield skirt is raised so the CTM can be moved to a cask lid staging area to set down the lid.

The CTM is moved back over the port above the loaded cask to align the canister grapple. The shield skirt is lowered, the port slide gate is opened, and the grapple is lowered to engage the canister lifting feature. The canister is raised into the shield bell. The CTM slide gate and the port slide gate are closed, and the shield skirt is raised so the CTM can be moved to the port above the empty waste package. The waste package loading operations are essentially the reverse of the cask unloading.

The CTM canister grapple is used for handling large diameter canisters such as TAD canisters and DPCs. Other grapples are used to access the smaller diameter DOE SNF, HLW canisters, and the MCOs. These grapples are attached to the CTM canister grapple by positioning the CTM over a hatch located in the Canister Transfer Room floor and lowering the CTM hoist until the CTM grapple is accessible in the room below.

Loading codisposal waste packages may require that a canister be moved from the loaded cask to a staging area as an interim step before the canister is placed into a waste package. For codisposal waste packages, a waste package inner lid (shield plug) is also placed using the CTM after the waste package is loaded.

The CTM is normally controlled from the facility operations room (also referred to as the control room), but a local control station is also provided.

Generally, under off normal conditions the CTM is not in operation. Following a loss of AC offsite power, all power to the CTM motors (e.g., hoist, bridge, trolley, and bell trolley) is lost. If a transfer is underway when power is lost, all of the CTM motors would stop and the hoist holding brake engages. Operations would be suspended until power is restored and the load can be safely moved. Under other off normal conditions, transfer operations would be suspended and the CTM would remain idle.

6.2.2.4.3 Control System

Hard-wired interlocks are provided to:

- Prevent bridge and trolley movement when the shield bell skirt is lowered
- Prevent raising the shield bell skirt when the slide gate is open
- Prevent hoist movement unless the grapple is fully engaged or disengage
- Stop the hoist and erase the lift command when a canister clears the shield bell slide gate
- Stop a lift before upper lift heights are reached (two interlocks are provided for this function)
- Prevent opening of the port gate unless the shield bell skirt is lowered and in position
- Prevent hoist movement unless the shield bell skirt is lowered
- Prevent a collision between the two CRCF CTMs
- Prevent lifting of a load beyond the operational limit of the CTM (load cells).

Some of these interlocks can be bypassed during maintenance. The most significant of these interlocks that can be bypassed is the interlock between the shield skirt position and the position of the slide gate (The shield skirt cannot be raised unless the slide gate is closed or the maintenance bypass is engaged.) The design of the grapple interlock ensures that the bypass is voided when a canister is grappled.

Much of the operational controls are provided by non-ITS PLCs. Spurious or failed operation of the PLCs is in the FTA when such operation may contribute to a drop or collision event.

6.2.2.4.4 System/Pivotal Event Success Criteria

Success criteria for the CTM are the following:

- Prevent a canister drop from a height below the design basis height for canister damage from any cause during the lifting, lateral movement, and lowering portions of the canister transfer
- Prevent a canister drop from above the canister design limit drop height from any cause during the lifting, lateral movement, and lowering portions of the canister transfer
- Prevent a drop of any object onto the canister from any cause during the lifting, lateral movement, and lowering portions of the canister transfer
- Prevent a collision between the canister and the shield bell or Canister Transfer Room floor from any cause during the lifting, lateral movement, and lowering portions of the canister transfer
- Prevent CTM movement that could result in a shearing force being applied to the canister when the canister is being lifted and is between the first and second floors of the CRCF
- Prevent CTM movement that could result in a collision between the two CTMs while either one is transferring a canister.

The failure to achieve each success criterion defines the top event for a fault tree for the CTM.

6.2.2.4.5 Mission Time

The mission time for the ITS CTM is set to one hour.

6.2.2.4.6 Fault Tree Results

The analysis is detailed in Attachment B, Section B4.

There are six scenarios associated with the CTM that represent potential initiating events:

1. The CTM drops a canister from a height below the design basis height for canister damage (this includes canister drops within the shield bell once the bell slide gate has been closed and drops through the Canister Transfer Room ports to the loading/unloading areas that can occur before the bell slide gate is closed).
2. The CTM drops a canister from a height above the design basis height for canister damage.
3. The CTM drops an object onto a canister.

4. The CTM, while carrying a canister, moves in such a manner (spurious movements, exceeding bridge or trolley end of travel limits) as to cause an impact of the canister with the shield bell.
5. The CTM moves when the canister being transferred is being lifted and is between the CRCF floors resulting in shear forces being applied to the canister.
6. The CTM, while carrying a canister, moves in such a manner as to cause a impact of the collision with the second CTM.

These six scenarios apply to operations in all three CRCFs. The facilities and operations within each of these facilities is identical, therefore, only one set of fault trees have been developed to address operations within all three facilities.

The results of the analysis are summarized in Table 6.2-4. Six fault trees were developed. The top events correspond, to the six potential initiating events defined above.

Table 6.2-4. Summary of Top Event Quantification for the CTM

Top Event	Mean Probability	Standard Deviation
CTM drop from below the canister design-limit drop height	1.4E-5	1.3E-5
CTM high drops from above the canister design limit drop height	2.8E-8	7.8E-8
Drop of object onto cask	1.4E-5	1.3E-5
CTM collision results in an impact to canister	3.9E-6	2.7E-7
CTM shear	6.7E-9	1.4E-8
CTM collision with second CTM	3.2E-5	5.4E-5

NOTE: CTM = canister transfer machine.

Source: Attachment B, Section B4, Figures B4.4-1, B4.4-14, B4.4-19, B4.4-33, B4.4-40, and B4.4-45

6.2.2.5 WASTE PACKAGE TRANSFER TROLLEY FAULT TREE ANALYSIS

The FTA for the WPTT is detailed in Attachment B, Section B5. The following is a summary of the design, operations, success criteria, and results of the fault tree quantification. See Attachment B, Section B5 for sources of information on the physical and operational characteristics of the WPTT.

6.2.2.5.1 Physical Description and Functions

The WPTT is an electrically powered machine used to transport the waste package containing various waste canisters from the Waste Package Loading Area to the Waste Package Closure Area and then to the waste package transfer carriage docking station in the Waste Package Loadout Room. The WPTT consists of a shielded enclosure that holds the waste package, waste package pallet, waste package transfer carriage, and pedestal. The shielded enclosure acts as a radiation shield to minimize radiation to the surroundings. The enclosure pivots between a vertical and horizontal position for waste package loading and unloading.

The WPTT travels on rails between the Waste Package Loading Room and the docking station. The crane rails supporting the WPTT are gapped in multiple locations. Power is supplied to the motor by a third rail system and the maximum speed is less than 40 fpm, required by ASME NOG-1-2004 (Ref. 2.2.10), established by the size of the drive motor and the gear drive system. The WPTT includes seismic rail clamps and rails anchored to the floor to ensure the stability of the WPTT during a seismic event.

The rotation of the shielded enclosure from vertical to horizontal is driven by worm gear mechanisms and is also powered by the third rail system. Each of the rotation mechanisms is sized to rotate the full design load (no greater than 178,200 lbs) on its own at a speed no faster than 90-degrees per hour (Ref. 2.2.92). The worm gear mechanism has the inherent property to self lock to prevent uncontrolled tilt-down.

The waste package transfer carriage is a wheeled platform which carries the waste package pallet and waste package. The transfer carriage is moved by a mechanical screw driven carriage retrieval assembly that places an empty waste package in the shielded enclosure and retrieves the loaded and sealed waste package from the shielded enclosure for interfacing with the TEV.

6.2.2.5.2 Operation

The Waste Package Loadout Room operation begins with an empty waste package being loaded into the WPTT. The WPTT is locked into the waste package transfer carriage docking station and rotated to the horizontal position. The transfer carriage with an empty waste package and pallet is moved into the shielded enclosure of the WPTT via the waste package transfer carriage docking station's waste package retrieval assembly. The shielded enclosure is rotated into the vertical position and the shield ring is lowered and locked into position on top of the shielded enclosure by the waste package handling crane.

The WPTT is unlocked from the waste package transfer carriage docking station and is remotely driven into the Waste Package Loadout Room. The WPTT is situated so that the empty waste package is directly beneath the center of the slide gate that separates the Waste Package Loadout Room and Canister Transfer Room.

The WPTT is positioned in the Waste Package Loadout Room and the slide gate is opened to allow the waste canister(s) to be lowered into the empty waste package using the CTM.

After the waste package is loaded and the slide gate closed, the WPTT moves to the Waste Package Closure Area. At this station, the inner lid is placed on top and is welded in place, and the weld is inspected. The air within the waste package is replaced by helium with a helium purging operation. After the inner lid is inspected for leakage, the outer lid is positioned and welded in place. The welds of the outer lid are inspected to ensure the waste package is properly sealed.

After the waste package is sealed, the WPTT is moved into the Waste Package Loadout Room where it is locked into the waste package transfer carriage docking station. The shield ring is remotely removed with the waste package handling crane and the shielded enclosure is rotated into the horizontal position. The waste package carriage retrieval assembly is then retracted to

pull the carriage and waste package out of the shielded enclosure to a position where the TEV is able to lift the waste package and pallet off the carriage.

6.2.2.5.3 Control System

Interlocks prevent translational or rotational motion of the WPTT while a canister is being loaded into the waste package (i.e., when the waste package slide gate is open) or while the waste package is being withdrawn from the shielded enclosure on the transfer carriage. The shielded enclosure is not able to rotate in either direction unless the WPTT is locked into the waste package transfer carriage docking station and the waste package carriage retrieval assembly is completely extended or retracted. Interlocks also prevent over-travel of the trolley and travel through portals when the shield doors are closed. Manually actuated, hardwired emergency stop buttons are available at all control locations to allow power to be removed from the drive motors.

6.2.2.5.4 System/Pivotal Event Success Criteria

Success criteria for the WPTT are the following:

- Ensure the WPTT at the loading area remains stationary with no movement while loading a canister onto the shielded enclosure
- Ensure the WPTT travels at a speed no greater than 20 fpm and the operator be in control and able to stop the WPTT as required
- Ensure the WPTT does not derail during the transport process
- Prevent premature tilt-down of the shield enclosure during transfer
- Prevent premature tilt-up or WPTT departure during loadout operations.

Various design features are provided to achieve each of the success criteria. The failure to achieve each success criterion defines the top event for a fault tree for the WPTT.

6.2.2.5.5 Mission Times

A conservative mission time of one hour per canister is used for canister and waste package transfers through the process for each fault tree.

6.2.2.5.6 Fault Tree Results

The WPTT fault tree analysis is detailed in Attachment B, Section B5.

There are five fault trees associated with the WPTT that represent potential initiating events:

1. Spurious movement at the loading area while loading a cask onto the WPTT.

2. Impact of the WPTT with a structure while moving from the loading area to the Waste Package Positioning Room and then to the Waste Package Loadout Room
3. Derailment of the WPTT while moving from the loading area to the Waste Package Positioning Room and then to the Waste Package Loadout Room
4. Premature tilt-down of the shielded enclosure while moving from the loading area to the Waste Package Positioning Room and then to the Waste Package Loadout Room
5. WPTT or carriage malfunctions while extracting the carriage and waste package from the shielded enclosure at the Waste Package Loadout Room.

The results of the analysis are summarized in Table 6.2-5.

Table 6.2-5. Summary of Top Event Quantification for the WPTT

Top Event	Mean Probability	Standard Deviation
Spurious movement of the WPTT in the loading area while loading the WP with canisters	2.7E-12	3.3E-11
Impact of the WPTT with a structure	3.0E-3	3.5E-3
Derailment of the WPTT	4.7E-7	7.4E-9
Premature tilt-down of the WPTT	2.7E-5	3.3E-5
Malfunction of WPTT or WP transfer carriage	1.0E-3	1.3E-3

NOTE: WP = waste package; WPTT = waste package transfer trolley.

Source: Attachment B, Section B5, Figures B5.4-1, B5.4-7, B5.4-11, B5.4-14 and B5.4-18

6.2.2.6 Site Transporter Fault Tree Analysis

The FTA for the site transporter is detailed in Attachment B, Section B6. The following is a summary of the design, operations, success criteria, and results of the fault tree quantification.

6.2.2.6.1 Physical Description

The site transporter is a diesel/electric self-propelled tracked vehicle that is designed to transport a concrete and steel ventilated aging overpack. The transport occurs both within the Intra-Site and within the CRCF. The analysis described herein is limited to movement of the site transporter within the CRCF: the Entry Vestibule, the Cask Preparation Room, and either of the two Cask Unloading Rooms.

The site transporter is a track driven vehicle with four synchronized tracks (two on each side). The components of the drive system (i.e., tumblers, idlers, rollers) are not included in this analysis since these components are not ITS. An integrated diesel powered electric generator provides the energy to operate the site transporter outside the facility building. Inside the facility buildings the site transporter is electrically driven via an umbilical cord (or remote control) from the facility main electrical supply.

A rear fork assembly and a pair of support arms are used to lift and lower the cask. The rear forks are inserted in two rectangular slots near the base of the aging overpack. Casks are carried in a vertical orientation with the lid at the top. Access to the top of the casks is unobstructed.

A passive restraint system provides stabilization during cask movement. These restraints are brought into contact with the cask after it has been raised to the desired height. A pin is inserted into each of the three restraint arms to keep the restraint in place should there be a failure of the electromechanical assembly. The pins also serve as an interlock that prevents movement of a loaded site transporter without the restraints being properly installed.

6.2.2.6.2 Control System

There are two modes of control provided on the site transporter. Operators can control every operation on the site transporter with either a remote (wireless) controller or through a pendant connected to the site transporter. All safety interlocks and controls of the site transporter are hard wired between the specific relays, drives, circuit breakers, and other electrical equipment. No PLC or computer is used to control the machine.

6.2.2.6.3 Normal Operations

The site transporter operator lines up the front opening of the site transporter to envelop the aging overpack and positions the rear fork down and in-line with the rectangular lifting slots near the bottom of the aging overpack and moves the site transporter forward until the aging overpack is centered in the interior of the site transporter.

The rear forks are raised to contact the bottom of the lift slots but do not attempt to lift the cask at this time. The operator and interlocks (torque and/or position) are incorporated to prevent lifting with the rear forks only.

The operator initiates the lift support arm's interface sequence with the rear forks and cask to prepare for lifting. After the operator and machine's switches have confirmed that the rear forks and lift support are properly aligned with one another, the lift sequence is initiated. The control system will sequence the lift motors so all screws operate together.

When the lift is completed, the operator performs the final positioning of the upper restraint arms and inserts a pin in each arm. When the pins are properly installed, the site transporter can move.

The operator trails behind the site transporter during movement using the remote control to drive the site transporter to the desired location. At the facility, the operator stops the site transporter outside the Site Transporter Vestibule and turns off the diesel generator and an electric power cable is attached.

Once inside the building, the operator positions the site transporter in the Cask Preparation Room and in the Cask Unloading Rooms. During the various movements inside the CRCF, the operator disengages the restraint arms for lower and lift operations at the various stations. Each time, the operator removes or replaces the pins from the restraint arms, as appropriate. The movement interlock is engaged when the pins are removed.

6.2.2.6.4 System/Pivotal Event Success Criteria

Success criteria for the site transporter are the following:

- Prevent a collision of the site transporter with objects, structures, or shield doors
- Prevent runaway situations
- Prevent site transporter movements in the wrong direction
- Preventing a rollover of the site transporter
- Prevent spurious site transporter movements
- Prevent a load drop during lift/lower or transport operations.

Various design features are provided to achieve each of the success criteria. The failure to achieve each success criterion defines the top event of a fault tree for the site transporter.

6.2.2.6.5 Mission Time

For quantification of the site transporter fault trees in Attachment B, Section B6, a mission time of one hour per cask transfer is used.

6.2.2.6.6 Fault Tree Results

There are five basic site transporter fault trees developed for the CRCF. The scenarios represented and the variations by these fault trees are the following:

1. Site transporter collides with CRCF structures:
 - A. Importing aging overpack to Cask Preparation Room
 - B. Transfer aging overpack from Cask Preparation Room to Cask Unloading Room
 - C. Transfer aging overpack from Cask Unloading Room to Cask Preparation Room
 - D. Export aging overpack from Cask Preparation Room.
2. Site transporter load drop during lift/lower
3. Site transporter rollover
4. Site transporter spurious movement during canister transfer by CTM
5. Site transporter spurious movement during preparation or closure of aging overpack.

The results of the analysis are summarized in Table 6.2-6 for the five fault trees.

Table 6.2-6. Summary of Top Event Quantification for the Site Transporter

Top Event	Mean Probability	Standard Deviation
Collides with CRCF structures	4.4E-3	1.3E-2
ST load drop during lift and movement	4.0E-8	1.2E-7
ST rollover	2.3E-6	1.9E-6
ST spurious movement (during canister transfer)	2.0E-13	6.1E-13
ST spurious movement (during preparation/closure)	2.6E-4	2.9E-4

NOTE: CRCF = Canister Receipt and Closure Facility; ST = site transporter.

Source: Attachment B, Section B6, Figures B6.4-1, B6.4-6, B6.4-20, B6.4-23 and B6.4-26

6.2.2.7 HVAC FAULT TREE ANALYSIS

The FTA is detailed in Attachment B, Section B7. The following is a summary of the design, operations, success criteria, and results of the fault tree quantification.

6.2.2.7.1 HVAC Description and Function

The ITS HVAC is a two train system of identical components. One train is always operational and one train is in standby mode. This system is not configured to run both trains at the same time without bypassing control circuitry. This off-normal situation is not addressed in this analysis.

In the CRCF, the train A HVAC equipment is located on the opposite end of the building from train B HVAC equipment. Each HVAC train exhausts air through separate discharge ducts, into the atmosphere. Although these trains are interconnected through interior duct work, the trains are independent. A back-draft damper is used on each train to ensure there is no airflow from the atmosphere back through the standby train.

This HVAC system is composed of four subsystems:

- A series of dampers are used to control pressure, flow, as well as flow direction in this system.
- Three HEPA filters, each consisting of one medium efficiency roughing filter (60 to 90% efficiency), two high efficiency filters for particulate removal in air (99.97% efficiency), and a mister/demister for maintaining proper humidity levels.
- One exhaust fan with a rated capacity of 40,500 cubic feet per minute and an exhaust fan motor rated at 200 horsepower (hp).
- Control circuitry with logic contained in an erasable programmable read-only memory located in the adjustable speed drive controller used for controlling the speed of the operating fan and on fault detection, and for off-nominal conditions, shutting down the operating train and transmitting signals to the standby system to start.

6.2.2.7.2 Success Criteria

One success criterion is defined for the each of independent trains, A and B, for providing the HVAC confinement function—maintain negative differential pressure in the CRCF for the specified mission time.

The respective trains of the ITS portions of the HVAC are identical. Various design features are provided to achieve each of the success criteria for the respective trains and for the combined system.

The HVAC FTA for the HVAC includes separate analyses for the respective trains. The failure to achieve the success criterion defines the top event for the fault tree for each train of the HVAC.

6.2.2.7.3 Mission Time

The mission time for the HVAC system is 720 hours (Attachment B, Section B7). However, the mission time for the backup system has been taken as, half of the active system, (i.e., 360 hours). This is to account for the difference in failure rates between active and passive systems.

6.2.2.7.4 Fault Tree Results

The system failure probability and standard deviation, including failure of electrical power, are as follows:

- The mean HVAC system probability of failure is 3.5E-02 (Figure B7.4-1)
- The standard deviation is 9.4E-02 (Figure B7.4-1).

These values are for the HVAC system coupled with loss of electrical power which is described in the next section. The values for failure of the HVAC system alone, decoupled from the electrical power fault trees, are as follows:

- The mean probability of failure for the HVAC system alone is 3.3E-02 (Section B7.4.1.6)
- The standard deviation for the HVAC system alone is 9.3E-02 (Section B7.4.1.6).

These results are presented in Attachment B, Section B7, Figure B7.4-1

6.2.2.8 AC Power Fault Tree Analysis

The FTA is detailed in Attachment B, Section B8. The following is a summary of the design, operations, success criteria, and results of the fault tree quantification.

6.2.2.8.1 System Description

The ITS AC power system supplies power to the ITS systems (the HVAC Systems). The ITS power system consists of two elements; those used during normal operations and those used during off-normal conditions. During normal operations AC power is supplied from one of two offsite 138 kV offsite power lines through the 138 to 13.8 kV switchyard and then through the plant AC power distribution system to the various facilities throughout the site. Off-normal conditions for the distribution of AC power occur during a loss of offsite power (LOSP).

A LOSP may be the result of problems on the power grid, or may be the result of failures within the plant AC power systems. Under these conditions, the AC power source for the CRCF ITS equipment is two onsite ITS diesel generators. Power is supplied to ITS loads via the same onsite AC power distribution system that is used during normal operation. Each ITS diesel generator supplies power to one division (A or B) of ITS systems. Each ITS diesel generator, its associate support systems, and the power distribution system are independent and electrically isolated from the other diesel generator, its support systems and power distribution system.

The ITS loads within the CRCF are powered via two ITS 480 V Load Centers and two 480 V motor control centers (MCC) located within separate areas in the CRCF. Each division of the AC power supply from the 13.8kV ITS switchgears to the CRCF passes through a 13.8 kV to a 480 V transformer. Separate AC power systems are provided for each of the three CRCFs from the connection to the diesel generator switchgear through the individual loads. The systems supplying power to MCC A1 and B1 are representative of the systems used to power MCCs A2, A3, B2, and B3. The two fault trees developed for the AC power supplies to MCC A1 and B1 are representative of the fault trees for the remaining four MCCs.

The ITS onsite power portion of the ITS power supply system is intended to provide back-up power to selected buildings and operations in the event of a main transmission power loss (a LOSP). The primary components in each division include: a diesel generator, support systems for the diesel generator, and a load sequencer. Both ITS diesel generators are located in the Emergency Diesel Generator Building (EDGB). Each is sized to provide sufficient 13.8 kV power to support one division of all ITS loads in six facilities (i.e., three CRCFs, the WHF, the RF, and the EDGB).

The ITS diesel generator starts upon detection of an undervoltage condition via an undervoltage relay of the diesel generator switchgear. Each ITS diesel generator is equipped with a complete independent set of support systems including HVAC systems, uninterruptible and DC power systems, a fuel oil system, diesel generator start subsystem, diesel generator cooling subsystem and lube oil subsystem.

The load sequencer controls sequence of events that occur after a LOSP and the ITS diesel generator start. Upon a LOSP the load sequencer opens the CRCF ITS Load Center feed breaker. After the ITS diesel generator starts and reaches rated capacity, the load sequence connects the ITS diesel generator to the 13.8kV ITS switchgear and then reconnects the CRCF loads.

6.2.2.8.2 Operations

Under normal operating conditions, AC power is supplied from two 138 kV offsite power lines. Power is passed through the 138 to 13.8 kV switchyard to the two independent 13.8 kV ITS switchgear. From here, power is transmitted via separate lines to a 13.8 to 480 V transformers supporting divisions A and B of the CRCF. Power to individual ITS components within each facility is provided via 480 V ITS Load Centers and MCCs (one each for division A and one each for division B in each facility) powered through these transformers.

During a LOSP, both ITS diesel generators are required to start and accept loads in a timely manner. Upon a LOSP, the onsite power distribution system supporting ITS loads is disconnected from the switchyard; a circuit breaker between the 13.8kV ITS switchgear and the switchyard 13.8 kV switchgear in each division automatically opens. Both ITS diesel generators start automatically and are connected to the 13.8kV ITS switchgear when the connecting breaker is closed by the load sequencer. The load sequencer then reconnects the CRCF loads to the 13.8kV ITS switchgear. Both ITS diesel generators continue to supply AC power until normal power is restored.

Environmental systems are provided to maintain the temperature in the various EDGB rooms and CRCF ITS electrical rooms within acceptable levels.

6.2.2.8.3 Control System

The ITS diesel generator starts upon detection of an undervoltage condition via an undervoltage relay of the 13.8kV ITS switchgear. The 13.8kV ITS switchgears are isolated from the main switchyard upon a loss of power in the switchyard. The loads in the CRCF are shed upon a loss of power indication.

A load sequencer controls the loading of the ITS diesel generator onto the 13.8kV ITS switchgear upon the ITS diesel generator reaching rated output. The same load sequencer controls reloading the CRCF loads onto the AC power system.

6.2.2.8.4 System/Pivotal Event Success Criteria

Success criterion for the AC power system is defined in terms of its support function for the ITS HVAC confinement function. The AC power system must operate in support of the HVAC system for as long as necessary to successfully provide confinement after the potential release of radioactive material inside the CRCF. There are two independent trains of HVAC and each of these must be supported by an independent AC power system. Therefore, the following success criteria apply to the respective AC power supply trains:

- Provide AC power from either the normal offsite power lines or from the ITS diesel generator (DG A) to the HVAC division powered through CRCF ITS Load Center A and ITS MCC A1 for the mission time of 720 hours
- Provide AC power from either the normal offsite power lines or from the ITS diesel generator (DG B) to the HVAC division powered through CRCF ITS Load Center B and ITS MCC B1 for the mission time of 720 hours.

The respective trains of the ITS portions of the AC power system are essentially identical. Various design features are provided to achieve each of the success criteria for the respective trains.

The FTA for the AC power system includes separate analyses for the respective trains. The failure to achieve the success criterion defines the top event for the fault tree for each train of the AC power system.

6.2.2.8.5 Mission Time

The mission time for the ITS AC power system is the same as for the HVAC system, 720 hours.

6.2.2.8.6 Fault Tree Results

Two fault trees are developed for the AC power system, one for train A and one for train B. The respective top events are:

- “Loss of AC power at ITS Load Center A for the CRCF,” defined as a failure of the normal and ITS onsite power supplies to provide power to ITS Load Center A
- “Loss of AC power at ITS Load Center B for the CRCF,” defined as a failure of the normal and ITS onsite power supplies to provide power to ITS Load Center B.

The results are essentially the same for either train:

- The mean probability of failure for either train value is 3.0E-02
- The standard deviation is 7.3E-02.

These results are presented in Attachment B, Section B8, Figure B8.4-1.

6.2.2.9 Potential Moderator Sources

6.2.2.9.1 Internal Floods

Internal floods are potential sources of moderator addition into a canister associated with pivotal events in the event sequences included in Section 6.1. Moderator addition into a canister can occur following a breach of the canister and a subsequent internal flood. The internal flooding analysis considers all waste handling facilities.

During most of its handling at the repository, a canister is surrounded by at least one other barrier to water intrusion: a transportation cask, a transportation cask within a CTT, an aging overpack, a waste package, a waste package within a WPTT, or a waste package within a TEV.

Each facility is equipped with a normally dry, double-preaction sprinkler system in areas where waste forms are handled (Ref. 2.2.19, Ref. 2.2.35, Ref. 2.2.29, and Ref. 2.2.41). Such systems, which require both actuation of smoke and flame detectors to allow the preaction valve to open and heat actuation of a fusible link sprinkler head to initiate suppression, have a very low frequency of spurious operation. A 30-day period from the occurrence of the canister breach to

the time definitive action can be taken to prevent introduction of water into the canister is reasonable and is the same as the period used to assess dose for a radiological release. The spurious actuation frequency over a 30 day mission time after a breach is calculated below.

An estimate of the probability of spurious actuation is developed using a simplified screening model that addresses the following cut sets that result in actuation:

- Spurious preaction valve opens before canister breach × failure of a sprinkler head during post-breach mission time (30 days)
- Failure of a sprinkler head during building evacuation × water left in dry piping after last test (1st quarter following annual test).

The frequency of sprinkler failure is estimated using an individual sprinkler head failure frequency of 1.6E-6/yr (Ref. 2.2.14, Table 1), the estimated number of sprinklers (1 per 130 ft² based on Ref. 2.2.64, Table 8.6.2.2.1(b)) and the applicable area (Ref. 2.2. 23). For example, the area of CRCF Waste Package Loadout Room 1015 is listed as 7,470 ft² in (Ref. 2.2.23, Table 10). At 130 ft²/sprinkler, 58 sprinklers are estimated. The failure of any sprinkler in the room is then estimated to be 58 × 1.6E-6/yr × 1/8,760 hrs/yr, or 1.1E-8/hr.

The frequency of preaction valve, spurious open is estimated using the solenoid valve spurious open data in Section 6.3 of 8.1E-07/hr. This is reasonable because a solenoid valve must open to relieve the air pressure from the diaphragm which keeps the valve closed.

The value of the first cut set is (1.6E-6/yr × 1/8,760 hrs/yr × 720 hrs) × (8.1E-7/hr × 720 hrs) = 8E-11/sprinkler head. The second cut set is more significant: 0.025 (human error screening value) × (1.6E-6/yr × 1/8,760 hr/yr × 720 hrs) = 3E-9/sprinkler head.

Applying the sum of these values, 3E-9/sprinkler head, to the number of sprinklers calculated for the waste handling areas of the four facilities results in the following estimates of the probability of spurious sprinkler actuation found in Table 6.2-7.

Table 6.2-7. Probability of Spurious Sprinkler Actuation

Facility	Waste Handling Area (ft ²) ^a	Number of Sprinkler Heads	Probability of Spurious Actuation in 30 day Period in Waste Handling Areas
CRCF(ea)	42,000	330	1E-6
IHF	30,000	240	9E-7
RF	19,000	150	5E-7
WHF	28,000	215	6E-7

NOTE: ^a CRCF area based on room numbers 1005E, 1016-1026, 2004,2007, 2007A, and 2007B
IHF area based on room numbers 1001-1003, 1006-1008, 1011,1012, 1026 and 2004
RF area based on room numbers 1013, 1015, 1016, 1017, 1017A, and 2007
WHF area based on room numbers 1007-1010, 1016, 2004, 2006, and 2008.
CRCF = Canister Receipt and Closure Facility, ft = feet; IHF = Initial Handling Facility; RF = Receipt Facility; WHF = Wet Handling Facility.

Source: Ref. 2.2. 23

Piping carrying water is present in the waste form handling areas of the CRCF, IHF and WHF. Piping lengths in these areas of the CRCF and WHF are below 100 feet per facility. The probability of a pipe crack in a 30 day period is estimated using the pipe leak data from *Industry-Average Performance for Components and Initiating Events at U.S. Commercial Nuclear Power Plants. NUREG/CR-6928* (Ref. 2.2.47, Table 5-1). Piping leaks and large break rates applicable to non-service water applications are used in the analysis. These values are considered appropriate for repository systems because the conditioning applied to the fluids in the systems is that typical of commercial nuclear power plants:

$$\text{External leak small (1 to 50 gpm): Leak rate} = 2.5\text{E-}10 \text{ hr}^{-1}\text{ft}^{-1}$$

$$\text{External leak large (> 50 gpm): Leak rate} = 2.5\text{E-}11 \text{ hr}^{-1}\text{ft}^{-1}$$

Multiplying the sum of the small and large crack frequencies ($2.8\text{E-}10 \text{ hr}^{-1}\text{ft}^{-1}$) by the length of piping in the waste handling areas of each facility, and the number of hours in a 30 day period (720 hours), a conditional probability of water leakage in all waste handling areas given a breach is approximated as follows:

$$\text{CRCF} = 2.8\text{E-}10 \text{ hr}^{-1}\text{ft}^{-1} \times 100 \text{ ft} \times 720 \text{ hrs} = 2.0\text{E-}05$$

$$\text{IHF} < 2.8\text{E-}10 \text{ hr}^{-1}\text{ft}^{-1} \times 6800 \text{ ft} \times 720 \text{ hrs} = 1.4\text{E-}03$$

$$\text{WHF} = 2.8\text{E-}10 \text{ hr}^{-1}\text{ft}^{-1} \times 75 \text{ ft} \times 720 \text{ hrs} = 1.5\text{E-}05$$

$$\text{RF} = 2.8\text{E-}10 \text{ hr}^{-1}\text{ft}^{-1} \times 0 \text{ ft} \times 720 \text{ hrs} = 0.$$

It is appropriate to use the waste handling area piping lengths because they are separated by concrete walls from the non-waste handling areas of buildings.

The above applies to event sequences that do not involve fires as an initiating event. During fire initiating event sequences, fire suppression would actuate in the locations sufficiently heated by the fire. The fire initiating event analysis is described in Section 6.5, and the conditional probability of canister failure owing to fires is described in Section 6.3. The analysis is performed without the salutary effects of fire suppression in order to demonstrate large margins of safety during fire event sequences. Furthermore, the location of each fire is analyzed as around the outer shell of the overpack that surrounds the canister, which neither accounts for the CTT or WPTT enclosures that surround the overpack, nor the elevated position of the canisters with respect to a fire on the floor. The frequency of containment breach due to fire is significantly overestimated because of this conservative approach.

For fires that occur in locations that contain canisters sealed within bolted transportation casks, the fire location is floor level and the transportation casks rise as much as 20 feet above the floor. Casks are relatively thick walled compared to canisters and sustain a relatively small internal pressurization when compared to canisters. Therefore, if a fire is large enough, it will fail the internal canister first, as indicated in Attachment D. This will cause the bolted and sealed cask to bear the overpressure that is inside the canister. The cask bolts might act as elastic springs allowing the top to break the seal and relieve the internal pressure. This would be a mechanism that prevents cask breach. However, a hot fire may result in sufficient loss of strength of the

bottom portion of the stainless steel cask such that it breaches. If failure occurs because of bolt stretching the cask lid remains on top of the cask preventing fire suppression water from entering. Commercial DPCs and TAD canisters will require at least 100 liters of water to enter the canister if optimally distributed among the fuel rods (Ref. 2.2.39, Section 2.3.10.1). Casks are raised above the floor. They lay on top of railcars, are lifted from there by cranes, sit inside a CTT, or lay sideways on a pallet. They are at least five feet from the floor. If the bottom portion of the canister breaches, there is no physical mechanism for this much water to enter the cask and then the canister, remain as water (not boil off), and optimally mix with the fuel rods.

This latter situation also applies to canisters sealed within a welded waste package. The waste package sits inside a WPTT or is inside a TEV. In the former case it is more than three feet from the floor (Ref. 2.2.20) and in the latter case about one foot from the floor (Ref. 2.2.21). In the latter case, however, the TEV offers an additional layer of protection against fires. In addition, it is physically unrealistic for a sufficient amount of available fire suppression water to cause 100 liters to leak into a breached canister, but not extinguish the fire or at least reduce the severity of the fire such that a breach would not occur.

For a canister inside of an open transportation cask or waste package, the orientation of these is always vertical, and the cask and waste package are always elevated above the floor where the fire occurs. The occurrence of a fire of sufficient severity will fail the canister first as described above. An open transportation cask or waste package might allow fire suppression water to spray in from the top. The building configuration, however, precludes this occurrence. The cask lids are removed while in the upload cell below the CTM. The cask and waste package ports are above the casks and waste package. There is no fire suppression piping spanning the ports because the ports must be kept clear in order to perform lift and load operations. In the Waste Package Positioning Room and welding area, the lid is on the waste package and fire suppression piping can not be above an open waste package because of the welding machine. In the cutting cell in which a cask is open (WHF only), there can be no fire suppression piping above an open cask because of the cutting equipment.

Upon failure of the canister inside the cask, the cask will not be susceptible to pressurization failures as above. Instead, water can only enter in a cask (or waste package) if the cask body melts through. Fires capable of melting stainless steel or Alloy 22, however, have an occurrence frequency within the waste handling facilities of less than $1E-05$ over the preclosure period (Attachment D, Section D1.3). Thus, breach of the cask or waste package in a manner that would allow water to enter the canister is essentially not physically realizable.

When a canister is being lifted, transferred inside the shield bell, and lowered. It is not inside an outer cask. However, fires can not be severe enough to breach a canister while being moved, as described in more detail in Attachment D. Water intrusion, therefore, is not physically realizable for this situation.

It is concluded that moderator entry into breached canisters during fire event sequences is not physically realizable because of a combination of physical mechanisms, building and equipment configuration, and overpack material properties. Furthermore, the existence of water from fire suppression is inconsistent with the fire analyses performed to obtain the probability of containment failure owing to fire. If fire suppression were indeed available, the probabilities of

canister breach would be far lower. However, in order to complete an event sequence quantification, the conditional probability of moderator entry into a canister after canister breach during a fire initiating event sequence is assessed as *extremely unlikely* and assigned a lognormal distribution with a median of 0.001 and an error factor of 10. This yields a mean value of 3E-03. The large error factor is assigned because of the potential of human error to defeat some of the reasons that water will not enter the cask or waste package (e.g., neglecting to place a lid on the waste package just before a severe fire). These assignments are consistent with the methodology on the use of judgment provided in Section 4.3.10.

6.2.2.9.2 Lubricating Fluid

Another source of moderation is lubricating fluid in cranes. Crane lube oil is of limited quantity (<150 gallons) and housed in a welded gear box with a leak pan below it capable of capturing the entire gearbox fluid inventory. An estimate of the leakage rate through the gear box and drip pan is found by multiplying the gearcase motor failure frequency (all modes) of 0.88E-06 per hour (Ref. 2.2.43, Page 2-104 and Section 6.3) by 0.5 (Ref. 2.2.43, Page 2-90), over the 50 years by the conditional probability of oil pan failure. A loss of lubrication would fail the crane operation and also be detected by oil pressure indicators. The conditional probability of oil pan failure may be estimated by analogy to receiver tank leakage during the interval between gearbox failure and detection. The interval is conservatively estimated to be 30 days. The all modes failure rate of a receiver tank is 0.34 E-06 per hour (Ref. 2.2.43, Page 2-213). Using an exposure interval of 50 years (which represents the operating life of the surface facilities), the conditional probability of lubricating fluid entering a breached canister would be less than:

$$0.88\text{E-}06/\text{hr} \times 50 \text{ yrs} \times 8760 \text{ hrs/yr} \times 0.34\text{E-}06/\text{hr} \times 720 \text{ hrs/30days} = 9.4\text{E-}05 \text{ over the preclosure period.}$$

This probability is overstated because a) it does not account for inspections during the operating period of the facility, and b) it does not account for the conditional probability that lubricating fluid can find its way into a breached canister. Therefore, lubricating fluid is eliminated as a potential moderator.

6.3 DATA UTILIZATION

6.3.1 Active Component Reliability Data

The fault tree models described in Section 6.2 include random failures of active mechanical equipment as basic events. In order to numerically solve these models, estimates of the likelihood of failure of these equipment basic events are needed. The active component reliability estimates are developed by gathering and reviewing industry-wide data, and applying Bayesian combinatorial methods to develop mean values and uncertainty bounds that best represented the range of the industry-wide information.

6.3.1.1 Industry-wide Reliability Data for Active Components

While data from the facility being studied are the preferred source of equipment failure rate information, it is common in a safety analysis for information from other facilities in the same industry to be used when facility-specific data is sparse or unavailable. Because the YMP activities are atypical of nuclear power plant activities and no operating history exists, it is necessary to develop the required data from the experience of other nuclear and non-nuclear equipment operations. Industry-wide data sources are documents containing industrial or military experience on component performance. These sources are from previous safety/risk analyses and reliability studies performed nationally or internationally and also standards or published handbooks. For the YMP PCSA, a database is constructed using a library of industry-wide data sources of reliability data from nuclear power plants, equipment used by the military, chemical processing plants and other facilities. The sources used are listed in Attachment C, Section C1.2.

The data source scope has to be sufficiently broad to cover a reasonable number of the equipment types modeled, yet with enough depth to ensure that the subject matter is appropriately addressed. For example, a separate source might be used for electronics data versus mechanical data, so long as the detail and the applicability of the information provided justify its use. Lastly, the quality of the data source is considered to be a measure of the source's credibility. Higher quality data sources are based on equipment failures documented by a facility's maintenance records. Lower quality sources use either abbreviated accounts of the failure event and resulting repair activity, or do not allow the user to trace back to actual failure events. Every effort is made in this analysis to use the highest quality data source available for each active component type and failure mode.

A potential disadvantage of using industry-wide data is that a source may provide failure rates that are not realistic because the industry-wide source environment, either physical or operational, may not correlate to the facility modeled. Part of the PCSA active component reliability analysis effort, therefore, is to evaluate the similarity between the YMP operating environment and that represented in each data source to ensure data appropriateness. This evaluation process is described in Section C1.2.

Given the fact that the YMP is a relatively unique facility (although portions are similar to the spent fuel handling and storage areas of commercial nuclear plants), the data development perspective is to collect as much relevant failure estimate information as possible to cover the spectrum of equipment operational experience. It is reasonable to expect that the YMP equipment would fall within this spectrum. The scope of the sources selected for this data set is therefore deliberately broad to take advantage of the combined experience of many facilities, not a single plant. It is then intended to provide a combined estimate that reflects as best as possible the uncertainty ranges of the individual estimates. This ensures that the data are not skewed towards the possibly atypical behavior of one particular plant, industry or operating environment. The combinatorial process, utilizing Bayes' theorem, is discussed in the following subsection.

Among the active components whose reliability is quantified with industry-wide data are the 200-ton cranes, jib cranes, waste package maneuvering cranes and the spent fuel transfer machine (SFTM). The SFTM is not used in the CRCF; however it is being discussed in this

section for completeness. The rationale for using such data for these estimates is that a significant amount of crane experience exists within the commercial nuclear power industry and other applications and that this experience can be used to bound the anticipated crane performance at YMP. Furthermore, the repository is expected to have training for crane operators and maintenance programs similar to those of nuclear power plants. Crane and SFTM handling incidents that result in a drop are included in the drop probability regardless of cause; they may be caused by equipment failures (including failures in the yokes and grapples), human error, or some combination of the two.

Every attempt is made to find more than one data source for each component type and failure mode combination (TYP-FM), although multiple sources are not always available for a specific piece of equipment. When data was extracted from several sources, it was combined using Bayesian estimation (as described further below), and compared by plotting the individual and combined distributions. However, the comparison process often resulted in one source being selected as most representative of the TYP-FM. Ultimately, 53% of the TYP-FMs are quantified with one data source, eight percent with two data sources, eight percent with three data sources, and 31%, are quantified with four or more data sources.

6.3.1.2 Application of Bayes' Theorem to PCSA Database

The application of industry-wide data sources introduces uncertainty in the input parameters used in basic events and, ultimately, the quantification of probabilities of event sequences. Uncertainty is a probabilistic concept that is inversely proportional to the amount of knowledge, with less knowledge implying more uncertainty. Bayes' theorem is a common method of mathematically expressing a decrease in uncertainty gained by an increase in knowledge (for example, knowledge about failure frequency gained by in-field experience).

There are several approaches for applying Bayes' theorem to data management and combining data sources, as described in *Handbook of Parameter Estimation for Probabilistic Risk Assessment*. NUREG/CR-6823 (Ref. 2.2.12). For the PCSA, the method known as "parametric empirical Bayes" is primarily used. This permits a variety of different sources to be statistically combined and compared, whether the inputs are expressed as the number of failures and exposure time or demands, or as means and lognormal error factors.

A typical application of Bayes' theorem is illustrated as follows. A failure rate for a given component is needed for a fault tree, e.g., a fan motor in the HVAC system. There is no absolute value for the failure rate, but there are several data sources for the same kind of fan and/or similar fans that may exhibit considerable variability for many reasons. Applying any or all of the available data to the YMP introduces uncertainty in the analysis of the reliability of the HVAC system. Bayes' theorem provides a mechanism for systematically treating the uncertainty and applying available data sources using the following steps:

1. Initially, estimate the failure rate to be within some range with a probability distribution. This is termed the "prior" probability of having a certain value of the failure rate that expresses the state of knowledge before any new information is applied.

2. Characterize the test information, or evidence, in the form of a likelihood function that expresses the probability of observing the number of failures in the given number of trials if the failure rate is a certain value. The evidence comprises observations or test results on the number of failure events that occur over a certain exposure, operational, or test duration.
3. Update the probability distribution for the failure rate based on the new body of evidence.

The likelihood function is defined by the analyst in accordance with the kind of evidence. For time-based failure data, a Poisson model is used for the likelihood function. For demand-based failure data, a binomial model is used. The mathematical expression for applying Bayes' theorem to data analysis is described in Attachment C, Section C2.

For the analysis presented herein, MathCAD is used to calculate the population-variability (prior) distributions of active components. As described in Attachment C, Section C2.1, the method of "The Combined Use of Data and Expert Estimates in Population Variability Analysis" (Ref. 2.2.58, pp. 311–321) is used as the basis example for the combinations performed. In this method, the population-variability distribution of the failure rate is approximated by a lognormal distribution whose unknown parameters, ν and τ , respectively the mean and standard deviation of the associated normal distribution, are determined. Calculating ν and τ involves calculating the likelihood function associated with the reliability information in each data source. For a data source providing a failure rate point estimate, the likelihood function is a lognormal distribution, function of the failure rate x , and characterized by its median value and associated error factor. For a data source providing exposure data (given in the form of a number n of recorded failures over an exposure time t), the likelihood function is a Poisson distribution, expressing the probability that n failures are observed when the expected number of failures is x times t .

The maximum likelihood method is used to calculate ν and τ . This involves maximizing the likelihood function for the entire set of data sources. This likelihood function is the product of the individual likelihood function for each data source because the data sources are independent from each other. It is equivalent and computationally convenient to find the maximum likelihood estimators for ν and τ by using the sum of the log-likelihood (logarithm of the likelihood) of each data source. As a result, the likelihood functions from the individual data sources and a population-variability probability density function for the combination are produced and plotted for comparison, as in the example shown as Figure 6.3-1.

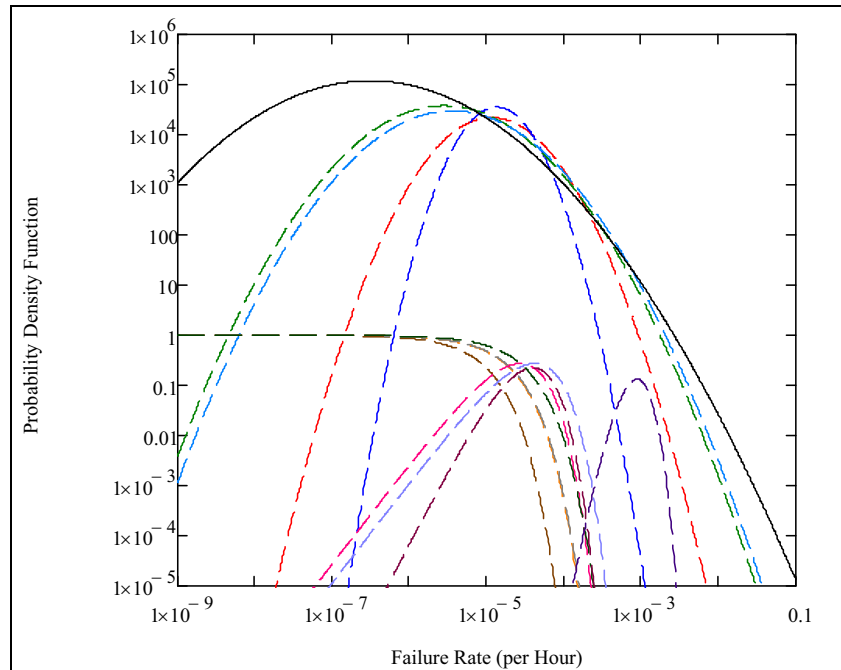

Source: Attachment C, Figure C2.1-1

Figure 6.3-1. Likelihood Functions from Data Sources (Dashed Lines) and Population-Variability Probability Density Function (Solid Line)

If only a single data source is considered applicable to a given TYP-FM combination and if the data source provides a mean and an error factor for the component reliability parameter, the probability distribution is modeled in SAPHIRE as a lognormal distribution with that mean and that error factor. However, if the data source does not readily provide a probability distribution, but instead exposure data, (i.e., a number of recorded failures over an exposure time for failure rates or over a number of demands for failure probabilities), the probability distribution for the reliability parameter is developed through a Bayesian update using Jeffrey’s noninformative prior distribution (i.e., gamma for time-related failure modes and beta for demand based failure modes).

Example implementations of the methods used for these cases are provided in Attachment C.

6.3.1.3 Common-Cause Failure Data

Dependent failures are modeled in event tree and fault tree logic models. When possible, potential dependent failures are modeled explicitly via the logic models. For example, failure of the HVAC system is explicitly dependent upon failure in the electrical supply system that is modeled in the fault trees. Similarly, the effects of erroneous calibration or other human failure events can be explicitly included in the system fault tree models and the basic event probabilities considered during the human reliability analysis (HRA). Otherwise, potential dependencies known as CCFs are included in fault tree logic, but their probabilities are quantified by an implicit, parametric method. Therefore, another subtask of the active component reliability data analysis is to estimate common-cause failure probabilities.

Surveys of failure events in the nuclear industry have led to several parameter models. Of these, three are most commonly used: the Beta Factor method (Ref. 2.2.52), the Multiple Greek Letter method (Ref. 2.2.61), and the Alpha Factor method (Ref. 2.2.63). In a parametric model, the probability of two or more components failing by a CCF is estimated by use of the equations provided in Section 4.3.3.3.

For the PCSA, common-cause failure rates or probabilities are estimated using the Alpha Factor Method (Ref. 2.2.63) because it is a method that includes a self-consistent means for development of uncertainties.

The data analysis reported in the Alpha Factor method (Ref. 2.2.63) consisted of:

1. Identifying the number of redundant components in each subsystem being reported, (e.g., two, three, or four (termed the CCF group size)).
2. Partitioning the total number of reported failure events for a given component into the number of components that failed together, (i.e., one component at a time, two components at a time, and so on up to failure of all components in a given CCF group).
3. Calculating the alpha factor for a given component type to provide a basis for estimating the probability of CCFs involving two, three, etc., or all components. (See equation in Attachment C, Section C3).
4. Performing statistical analysis and curve fitting to define the mean and uncertainty range for alpha factors for various CCF group sizes up to eight.

The data analysis also produces prior distributions for the alpha factors. The results are the mean alpha factors and uncertainty bounds, reported in *Guidelines on Modeling Common-Cause Failures in Probabilistic Risk Assessment* (Ref. 2.2.63, Table 5-11) and reproduced in Attachment C, Table C3-1.

These alpha-factors values are used for failure-on-demand events (e.g., pump failure to start) and by using the alpha factor divided by two for failure-to-operate events (e.g., pump fails to run). For example, for a two-out-of-two failure on demand event, the mean alpha factor of 0.047 (shown in the far right column of Table C3-1 associated with α_2) was multiplied by the mean failure probability for the appropriate component type and failure mode (from Table C4-1) to yield the common-cause failure probability.

6.3.1.4 Input To SAPHIRE Models

Since the primary active component reliability data task objective is to support the quantification of fault tree models developed in SAPHIRE by the system analysts, the output data has to conform to the format appropriate for input to the SAPHIRE code.

SAPHIRE provides template data to the fault tree models in the form of three input comma delimited files:

- BEA – attributes to assign information to the proper SAPHIRE fields
- BED – descriptions of the component type name and failure mode
- BEI – information on the failure rate or probability estimates and distributions used.

Demonstration files for the .BEA, .BED, and .BEI template data files provided with SAPHIRE were originally used to construct the PCSA template data files to ensure the proper formatting of the data for use by the fault tree models. In general, the .BEA file provides attribute designators for the code to implement such that the template data is properly assigned to the appropriate fields in SAPHIRE. The .BED file allows description information to be entered and linked to the template data name or designator (which in the PCSA case, was the TYP-FM coding). Examples of descriptions used for the PCSA template data were, clutch failed to operate, relay spurious operation, position sensor fails on demand, and wire rope breaks. The .BEI file contains the actual active component reliability parameters, namely the mean value and uncertainty parameter, either the lognormal error factor, or the shape parameter of the beta or gamma distributions.

Geometric means of the input parameters from the data sources are initially used as screening values for each TYP-FM and are entered into the .BEI file, along with a default Error Factor of 10. Once the Bayesian combination process is completed for all 275 TYP-FM combinations, mean and uncertainty parameter information are entered into the .BEI files, and tested in SAPHIRE before being distributed to the systems analysts.

The template data is utilized by the fault tree models by being imported into SAPHIRE using the MAR-D portion of the SAPHIRE code, then by using the modify event feature to link the template data to each basic event in the fault tree. This permits each active component of the same type and failure mode to utilize the same failure estimate and uncertainty information, based on the results of the data investigation and Bayesian combination process.

Attachment C, Section C4, presents a more thorough discussion of the active component reliability data development process, as well as a table of the template data that is imported into SAPHIRE.

6.3.1.5 Summary of Active Component Reliability Data in CRCF Analysis

Table 6.3-1 summarizes the active component reliability data used in each basic event of the CRCF models. Development of this table is discussed in detail in Attachment C, Section C4. Mission times are discussed in Section 6.2.

Table 6.3-1. Active Component Reliability Data Summary

Basic Event Name	Basic Event Description	Basic Event Mean Probability ^a	Mean Failure Rate ^a	Mission Time (Hours)
060-#EEE-CRCF1-A-XMR-CCF	CRCF ITS Transformers CCF	4.92E-06	2.91E-07	33.8
060-#EEE-CRCF1-A-XMR-FOH	CRCF ITS Train A Transformer Failure	2.10E-04	2.91E-07	720.0
060-#EEE-CRCF1-B-XMR-FOH	CRCF ITS Transformer Train B Failure	2.10E-04	2.91E-07	720.0
060-#EEE-LDCNTRA-BUA-FOH	CRCF ITS Load Center A Fails	4.39E-04	6.10E-07	720.0
060-#EEE-LDCNTRA-C52-FOD	ITS Load Center A feed breaker (AC) Fails to reclose	2.24E-03		
060-#EEE-LDCNTRA-C52-SPO	ITS Load Center A Feed Circuit Breaker (AC) Spurious Operation	3.82E-03	5.31E-06	720.0
060-#EEE-LDCNTRB-BUA-FOH	CRCF ITS Load Center B Fails	4.39E-04	6.10E-07	720.0
060-#EEE-LDCNTRB-C52-FOD	13.8 ITS SWGR to CRCF ITS LC B Circuit Breaker Fails on Demand	2.24E-03		
060-#EEE-LDCNTRB-C52-SPO	CRCF ITS Load Center Circuit Breaker (AC) Spur Op	3.82E-03	5.31E-06	720.0
060-#EEE-LDCNTRS-C52-CCF	CCF of the ITS Load Center feed breakers to reclose	1.05E-04		
060-#EEE-MCC0001-C52-SPO	CRCF ITS MCC 0001 Feed Breaker Spurious Operation	3.82E-03	5.31E-06	720.0
060-#EEE-MCC0001-MCC-FOH	CRCF ITS MCC 00001 Fails	5.38E-03	7.49E-06	720.0
060-#EEE-MCC0002-C52-SPO	CRCR MCC-00002 Feed Breaker Spurious Operation	3.82E-03	5.31E-06	720.0
060-#EEE-MCC0002-MCC-FOH	CRCF ITS MCC00002 Failure	5.38E-03	7.49E-06	720.0
060-CR---IEL00A--IEL-FOD	Interlock A From Slide Gate Fails	2.75E-05		
060-CR---IEL00B--IEL-FOD	Interlock B From Slide Gate Fails	2.75E-05		
060-CR---IELCCF--IEL-CCF	CCF of Interlocks From Slide Gate	1.29E-06	1.30E-06	1.0
060-CR---IELSKT--IEL-FOD	Skirt Interlock Fails	2.75E-05		
060-CRN2-2BLKDON-CRN-TBK	200 Ton Crane Two Block Drop	4.41E-07		
060-CRN2-2-BLOCK-CRN-TBK	200 Ton Crane Two Block Drop	4.41E-07		
060-CRN2-DRODPDC-CRN-DRP	200 Ton Crane Drop	3.21E-05		
060-CRN2-DRODPDC-CRS-DRP	200 Ton Crane Sling Drop	1.21E-04		
060-CRN2-DROPHLW-CRN-DRP	200 Ton Crane Drop	3.21E-05		
060-CRN2-DROPON--CRN-DRP	200 Ton Crane Drop	3.21E-05		
060-CRN2-DROPSNF-CRN-DRP	200 Ton Crane Drop	3.21E-05		
060-CRN2-DROPTAD-CRN-DRP	200 Ton Crane Drop	3.21E-05		
060-CRN-BRIDGMTR-MOE-FSO	Bridge Motor (Electric) Fails to Shut Off	1.35E-08	1.35E-08	1.0
060-CRNDRPONDPC-CRN-DRP	200-ton Crane Load Drop	3.21E-05		

Table 6.3-1. Active Component Reliability Data Summary (Continued)

Basic Event Name	Basic Event Description	Basic Event Mean Probability ^a	Mean Failure Rate ^a	Mission Time (Hours)
060-CRN-HSTTRLMO-MOE-FSO	Hoist Motor (Electric) Fails to Shut Off	1.35E-08	1.35E-08	1.0
060-CRN-PLC0101#-PLC-SPO	Bridge Motor PLC Spurious Operation	3.65E-07	3.65E-07	1.0
060-CR--PLC001--PLC-SPO	Inadvertent Signal Sent due to PLC Failure	3.65E-07	3.65E-07	1.0
060-CRWT-ATB1001-AT--FOH	Screw Actuator Mechanism on Lift Boom #1 Fails	7.54E-05	7.54E-05	1.0
060-CRWT-ATB1011-AT--FOH	Screw Actuator Mechanism on Lift Boom #1 Fails	7.54E-05	7.54E-05	1.0
060-CRWT-ATB2002-AT--FOH	Screw Actuator Mechanism on Lift Boom #2 Fails	7.54E-05	7.54E-05	1.0
060-CRWT-ATB222-AT--FOH	Screw Actuator Mechanism on Lift Boom #2 Fails	7.54E-05	7.54E-05	1.0
060-CRWT-ATD0002-AT--FOH	ST D-Axis Electrical Actuator #2 Fails Lift/Lower	7.54E-05	7.54E-05	1.0
060-CRWT-ATD001-AT--FOH	ST D-Axis Electrical Actuator #1 Fails Lift/Lower	7.54E-05	7.54E-05	1.0
060-CRWT-ATD03-AT--FOH	ST D Axis Electrical Actuator #1 Movement Fails	7.54E-05	7.54E-05	1.0
060-CRWT-ATD04-AT--FOH	ST D-Axis Electrical Actuator #2 Movement Fails	7.54E-05	7.54E-05	1.0
060-CRWT-ATP002-AT--FOH	ST P-Axis Electrical Failure During Movement	7.54E-05	7.54E-05	1.0
060-CRWT-ATR10002-AT-FOH	ST R-Axis Electrical Actuator #1 Fails Movement	7.54E-05	7.54E-05	1.0
060-CRWT-BEA#1-BEA-BRK	Boom#1 Fails During Cask Movement	2.40E-08	2.40E-08	1.0
060-CRWT-BEA22-BEA-BRK	Boom#2 Fails During Cask Lift	2.40E-08	2.40E-08	1.0
060-CRWT-BEAB202-BEA-BRK	Boom#2 Fails During Cask Movement	2.40E-08	2.40E-08	1.0
060-CRWT-BEAD003-BEA-BRK	ST D-Axis Actuator Structural Arm #2 Failure Movement	2.40E-08	2.40E-08	1.0
060-CRWT-BEAD006-BEA-BRK	ST D-Axis Actuator Structural Arm #1 Failure Movement	2.40E-08	2.40E-08	1.0
060-CRWT-BEAP02-BEA-BRK	ST P-Axis Mechanical Failure During Movement	2.40E-08	2.40E-08	1.0
060-CRWT-BEAR103-BEA-BRK	ST R-Axis Actuator Structural Arm #1 Failure Movement	2.40E-08	2.40E-08	1.0
060-CRWT-BEAR204-BEA-BRK	ST R-Axis Actuator Structural Arm #2 Failure Movement	2.40E-08	2.40E-08	1.0
060-CRWT-CBP0000-CBP-OPC	Electrical Power Dist Cable Failure on ST	9.13E-08	9.13E-08	1.0
060-CRWT-CON0000-CON-FOH	Electrical Power Dist Connectors Fail on ST	7.14E-05	7.14E-05	1.0
060-CRWT-CTSHC000-CT-SPO	Spurious Command to Raise/Lower AO	2.27E-05	2.27E-05	1.0

Table 6.3-1. Active Component Reliability Data Summary (Continued)

Basic Event Name	Basic Event Description	Basic Event Mean Probability ^a	Mean Failure Rate ^a	Mission Time (Hours)
060-CRWT-DROP11-BEA-BRK	Boom#1 Fails During Cask Lift	2.40E-08	2.40E-08	1.0
060-CRWT-EATR2004-AT-FOH	ST R-Axis electrical Actuator #2 Fails Movement	7.54E-05	7.54E-05	1.0
060-CRWT-ECP0000-ECP-FOH	ST Restraint Arms Position Selector Fails	1.79E-06	1.79E-06	1.0
060-CRWT-ELEC-MOE-FOD	ST Electric Motor Failure	6.00E-05		
060-CRWT-IEL0001-IEL-FOD	Restraint System Interlock Failure	2.75E-05		
060-CRWT-LM000011-LC-FOD	ST Lift/Lower Selector Lever Fails	6.25E-04		
060-CRWT-LVRD01-LVR-FOH	ST D-Axis Actuator Structural Arm #1 Failure	2.10E-06	2.10E-06	1.0
060-CRWT-LVRD02-LVR-FOH	ST D-Axis Actuator Structural Arm #2 Failure	2.10E-06	2.10E-06	1.0
060-CRWT-PIND004-PIN-BRK	ST D-Axis Actuator Pin #2 Failure Movement	2.12E-09	2.12E-09	1.0
060-CRWT-PIND005-PIN-BRK	ST D-Axis Actuator Pin #1 Failure Movement	2.12E-09	2.12E-09	1.0
060-CRWT-PINP04-PIN-BRK	ST P-Axis Pin failure During Movement	2.12E-09	2.12E-09	1.0
060-CRWT-PINR103-PIN-BRK	ST R-Axis Mechanical Pin #1 Failure During Movement	2.12E-09	2.12E-09	1.0
060-CRWT-PINR202-PIN-BRK	ST R-Axis Mechanical Pin #2 Failure During Movement	2.12E-09	2.12E-09	1.0
060-CRWT-SJKB011-SJK-FOH	Screw Lift on Boom #1 Fails	8.14E-06	8.14E-06	1.0
060-CRWT-SJKB101-SJK-FOH	Screw Lift on Boom #1 Fails	8.14E-06	8.14E-06	1.0
060-CRWT-SJKB202-SJK-FOH	Screw Lift on Boom #2 Fails	8.14E-06	8.14E-06	1.0
060-CRWT-SJKB22-SJK-FOH	Screw Lift on Boom #2 Fails	8.14E-06	8.14E-06	1.0
060-CRWT-TRD0001-TRD-FOH	Front Portside Track Failure	5.89E-07	5.89E-07	1.0
060-CRWT-TRD0002-TRD-FOH	Rear Portside Track Failure	5.89E-07	5.89E-07	1.0
060-CRWT-TRD0003-TRD-FOH	Front Starboard Track Failure	5.89E-07	5.89E-07	1.0
060-CRWT-TRD0004-TRD-FOH	Rear Starboard Track Failure	5.89E-07	5.89E-07	1.0
060-CRWT-ZSD00005-ZS-FOD	ST D-Axis Position Switch Failure Movement	2.93E-04		
060-CRWT-ZSD0006-ZS-FOD	ST D-Axis Position Switch Failure Lift/Lower	2.93E-04		
060-CRWT-ZSP00003-ZS-FOD	ST P-Axis Position Switch Failure During Movement	2.93E-04		
060-CRWT-ZSR00005-ZS-FOD	ST R-Axis Position Switch Failure Movement	2.93E-04		
060-CTM-#ZSH0112-1ZS-FOH	CTM Shield skirt position switch 0112 fails	7.23E-06	7.23E-06	1.0
060-CTM--121122-ZS--CCF	CCF CTM upper limit position switches	1.10E-05		

Table 6.3-1. Active Component Reliability Data Summary (Continued)

Basic Event Name	Basic Event Description	Basic Event Mean Probability ^a	Mean Failure Rate ^a	Mission Time (Hours)
060-CTM--330121--ZS--FOD	CTM Hoist First Upper Limit Switch 0121 Failure on Demand	2.93E-04		
060-CTM--330122--ZS--FOD	CTM Final Hoist Upper Limit Switch 0122 Failure on Demand	2.93E-04		
060-CTM-ASD0122#-CTL-FOD	CTM Hoist ASD Controller fails	2.03E-03		
060-CTM-BIDGMTR-#TL-FOH	CTM Bridge motor Torque limiter Failure	2.86E-02	8.05E-05	360.0
060-CTM-BREDGMTR-#CT-FOD	CTM Bridge Motor Controller Fails	4.00E-06		
060-CTM-BRIDGETR-#PR-FOH	CTM Bridge End of travel stops fail	1.95E-06	4.45E-10	4380.0
060-CTM-BRIDGETR-IEL-FOD	Bridge over travel interlock fails	2.75E-05		
060-CTM-BRIDGETR-MOE-FSO	CTM Bridge motor fails to stop	1.35E-08	1.35E-08	1.0
060-CTM-BRIDGMTR-IEL-FOD	CTM Shield Skirt-Bridge motor Interlock Failure	2.75E-05		
060-CTM-BRIDGMTR-MOE-SPO	CTM Bridge Motor (Electric) Spurious Operation	6.74E-07	6.74E-07	1.0
060-CTM-BRIDGMTS-MOE-SPO	CTM Bridge Motor (Electric) Spurious Operation -shear	6.74E-08	6.74E-07	0.1
060-CTM--CBL0001-WNE-BRK	CTM Hoist Wire rope Breaks	2.00E-06		
060-CTM--CBL0002-WNE-BRK	CTM Hoist Wire rope Breaks	2.00E-06		
060-CTM--CBL0102-WNE-CCF	CCF CTM Hoist wire ropes	9.40E-08		
060-CTM--DRTRN-CT--FOD	CTM Drive Train Protection and Fail Det. Controller Failure	4.00E-06		
060-CTM--DRUM001-DM--FOD	CTM Drum Failure on Demand	4.00E-08		
060-CTM--DRUMBRK-BRP-FOD	CTM Drum Brake (Pneumatic) Failure on Demand	5.02E-05		
060-CTM--DRUMBRK-BRP-FOH	CTM Drum Brake (Pneumatic) Failure to Hold	2.01E-04	8.38E-06	24.0
060-CTM--EQL-SHV-BLK-FOD	CTM Sheaves Failure on Demand	1.15E-06		
060-CTM--GRAPPLE-GPL-FOD	CTM Grapple Failure on Demand	1.15E-06		
060-CTM-HC0104###-#HC-FOD	CTM hand held radio remote controller fails	1.74E-03		
060-CTM--HOISTMT-MOE-FTR	CTM Hoist Motor (Electric) Fails to Run	6.50E-06	6.50E-06	1.0
060-CTM-HOISTMTR-MOE-FSO	CTM Hoist Motor (Electric) Fails to Shut Off	1.35E-08	1.35E-08	1.0
060-CTM--HOLDBRK-BRK-FOD	Brake Failure on Demand	1.46E-06		
060-CTM--HOLDBRK-BRK-FOH	CTM Holding Brake (Electric) Failure to hold	3.52E-05	4.40E-06	8.0
060-CTM-HSTTRLLS-MOE-SPO	CTM Hoist Trolley Motor (Electric) Spurious Operation	6.74E-08	6.74E-07	0.1

Table 6.3-1. Active Component Reliability Data Summary (Continued)

Basic Event Name	Basic Event Description	Basic Event Mean Probability^a	Mean Failure Rate^a	Mission Time (Hours)
060-CTM-HSTTRLLY-#TL-FOH	CTM Hoist motor Torque limiter Failure	2.86E-02	8.05E-05	360.0
060-CTM-HSTTRLLY-IEL-FOD	CTM shield skirt Hoist Trolley motor Interlock Failure	2.75E-05		
060-CTM-HSTTRLLY-MOE-SPO	CTM Hoist Trolley Motor Spurious Operation	6.74E-07	6.74E-07	1.0
060-CTM--IMEC125-IEL-FOD	CTM Hoist Motor Control Interlock Failure on Demand	2.75E-05		
060-CTM--LOWERBL-BLK-FOD	CTM Lower Sheaves Failure on Demand	1.15E-06		
060-CTM-MISSPOOL--DM-MSP	CTM Mis-spool event	6.86E-07	6.86E-07	1.0
060-CTM-OPSENSOR-SRX-FOH	Canister above CTM slide gate optical sensor fails	4.70E-06	4.70E-06	1.0
060-CTM--OVERSP--ZS--FOD	CTM Hoist motor speed Limit Switch Failure on Demand	2.93E-04		
060-CTM-PLC0101#-PLC-SPO	CTM Bridge Motor PLC Spurious Operation	3.65E-07	3.65E-07	1.0
060-CTM-PLC0101S-PLC-SPO	CTM Bridge Motor PLC Spurious Operation -shear	3.65E-08	3.65E-07	0.1
060-CTM-PLC0102#-PLC-SPO	CTM Shield Bell Trolley PLC Spurious Operation	3.65E-07	3.65E-07	1.0
060-CTM-PLC0102S-PLC-SPO	CTM Shield Bell Trolley PLC Spurious Operation -shear	3.65E-08	3.65E-07	0.1
060-CTM-PLC0103#-PLC-SPO	CTM Hoist Trolley PLC Spurious Operation	3.65E-07	3.65E-07	1.0
060-CTM-PLC0103S-PLC-SPO	CTM Hoist Trolley PLC Spurious Operation -shear	3.65E-08	3.65E-07	0.1
060-CTM--PORTGT1-MOE-SPO	Spurious port gate1 motor operation	6.74E-07	6.74E-07	1.0
060-CTM--PORTGT1-PLC-SPO	Port Gage PLC Spurious Operation	3.65E-07	3.65E-07	1.0
060-CTM--PORTGT2-MOE-SPO	Port Gate Motor (Electric) Spurious Operation	6.74E-07	6.74E-07	1.0
060-CTM--PORTGT2-PLC-SPO	Port Gage 2 PLC Spurious Operation	3.65E-07	3.65E-07	1.0
060-CTM-SBELTRLS-MOE-SPO	CTM shield Bell trolley Motor (Electric) spurious operation-shear	6.74E-08	6.74E-07	0.1
060-CTM-SBELTRLY-#TL-FOH	CTM Shield Bell Motor Torque limiter Failure	2.86E-02	8.05E-05	360.0
060-CTM-SBELTRLY-IEL-FOD	CTM Shield Bell Trolley Interlock Failure	2.75E-05		
060-CTM-SBELTRLY-MOE-SPO	CTM Shield Bell Trolley Motor Spurious Operation	6.74E-07	6.74E-07	1.0
060-CTM-SKRTCTCT-SRP-FOD	CTM Skirt floor contact sensors fail	3.99E-03		

Table 6.3-1. Active Component Reliability Data Summary (Continued)

Basic Event Name	Basic Event Description	Basic Event Mean Probability ^a	Mean Failure Rate ^a	Mission Time (Hours)
060-CTM--SLIDEGT-MOE-SPO	CTM Slide Gate Motor (Electric) Spurious Operation	6.74E-07	6.74E-07	1.0
060-CTM--SLIDEGT-PLC-SPO	CTM Slide Gate PLC Spurious Operation	3.65E-07	3.65E-07	1.0
060-CTM--SLIDGT2-IEL-FOD	CTM Slide Gate Interlock Failure	2.75E-05		
060-CTM-SLIDGT2-SRX-FOD	CTM slide Gate Position Sensor Fails on Demand	1.10E-03		
060-CTM-TROLLEYT-MOE-FSO	CTM Trolley motor fails to stop	1.35E-08	1.35E-08	1.0
060-CTM--TROLLY-MOE-SPO	CTM Trolley Motor (Electric) Spurious Operation	6.74E-07	6.74E-07	1.0
060-CTM-TROLLYTR-#PR-FOH	Passive restraint (bumper) Failure	1.95E-06	4.45E-10	4380.0
060-CTM-TROLYCNT-#HC-FOD	CTM trolley motor hand controller fails	1.74E-03		
060-CTM--UPPERBL-BLK-FOD	CTM Upper Sheaves failure	1.15E-06		
060-CTM--WT0125--SRP-FOD	CTM Load Cell Pressure Sensor Fails on Demand	3.99E-03		
060-CTM--WTSW125-ZS--FOD	CTM Load Cell Limit Switch Failure on Demand	2.93E-04		
060-CTM--YS01129-ZS--FOD	CTM Drum Brake control circuit Limit Switch 1129 Failure	2.93E-04		
060-CTM-ZS##0110--ZS-FOD	CTM position switch (anti-collision) 0110 fails	2.93E-04		
060-CTM--ZSH0111-ZS--SPO	CTM grapple engaged Limit Switch Spurious Operation	1.28E-06	1.28E-06	1.0
060-CTM-ZSL0111-ZS--SPO	CTM Grapple disengaged Limit Switch Spurious Operation	1.28E-06	1.28E-06	1.0
060-CTT--CT001---CT--SPO	On-Board Controller Initiates Spurious Signal	2.27E-05	2.27E-05	1.0
060-CTT--DSW000--ESC-CCF	CCF of Deadman Switches	1.18E-05	1.18E-05	1.0
060-CTT--DSW001--ESC-FOD	Deadman Switch #1 Fails Closed	2.50E-04		
060-CTT--DSW002--ESC-FOD	Deadman Switch #2 Fails Closed	2.50E-04		
060-CTT-FWDREVM1-SV--FOH	Failure of SV Providing Fwd/Rev to Motor 1	4.87E-05	4.87E-05	1.0
060-CTT-FWDREVM2-SV--FOH	Failure of SV Providing Fwd/Rev to Motor 2	4.87E-05	4.87E-05	1.0
060-CTT--HC001---HC--SPO	Hand Held Controller Initiates Spurious Signal	5.23E-07	5.23E-07	1.0
060-CTT--HC021---HC--FOD	Remote Stop Control Transmits Wrong Instruction	1.74E-03		
060-CTT--SV301---SV--SPO	Air Supply Solenoid Valve Spurious Operation	4.09E-07	4.09E-07	1.0

Table 6.3-1. Active Component Reliability Data Summary (Continued)

Basic Event Name	Basic Event Description	Basic Event Mean Probability ^a	Mean Failure Rate ^a	Mission Time (Hours)
060--CTT--SV401--SV--FOH	Failure of Air Supply Solenoid Valve for Air Bags	4.87E-05	4.87E-05	1.0
060-CTT--SV601---SV--FOD	Main Air Supply Valve on CTT Fails to Close	6.28E-04		
060-CTT--SV602---SV--FOD	Solenoid Valve Fails to Close	6.28E-04		
060-CTT-SVROTM1--SV--FOH	Failure of SV Providing Rotation to Motor 1	4.87E-05	4.87E-05	1.0
060-CTT-SVROTM2--SV--FOH	Failure of SV Providing Rotation to Motor 2	4.87E-05	4.87E-05	1.0
060-CTT--ZS301---ZS--FOD	Pin Limit Switch #1 Fails	2.93E-04		
060-CTT--ZS302---ZS--FOD	Restraint Locking Pin Limit Switch #2 Fails	2.93E-04		
060-FL---SC001---SC--FOH	Forklift Speed Control Fails	1.28E-04	1.28E-04	1.0
060-GATE-IEL001--IEL-FOD	Interlock Failure on Demand	2.75E-05		
060-GATE-ZS000---ZS--CCF	CCF of Gate Closed Limit Switches	1.38E-05	3.40E-07	1.0
060-GATE-ZS001---ZS--FOD	Gate Closed Limit Switch #1 Spurious Transfer	2.93E-04		
060-GATE-ZS002---ZS--FOD	Gate Closed Limit Switch #2 Spurious Transfer	2.93E-04		
060-PIN-LIMIT-ZS-CCF	CCF of Limit Switches	1.38E-05	3.40E-07	1.0
060-PORTSLIDEGTE-IEL-FOD	Port Slide gate interlock Fails	2.75E-05		
060-PWRPRTGATINT-IEL-FOD	Power to WPTT Interruption Interlock Fails	2.75E-05		
060-RHS--2BLKDON-CRW-TBK	WP (Non-SFP) Crane Two Block Drop	4.49E-05		
060-RHSCRANE-CRW-DRP	WP (Non-SFP) Crane Drop	1.05E-04		
060-SD---PLC001--PLC-SPO	Spurious Signal from PLC Closes Door	3.65E-07	3.65E-07	1.0
060-SD---SRU001--SRU-FOH	Ultrasonic Obstruction Sensor Fails	2.16E-03	9.62E-05	1.0
060-SD---TL000---TL--CCF	CCF of Over Torque Sensors	6.80E-04	3.78E-06	1.0
060-SD---TL001---TL--FOH	Motor #1 over Torque Sensor Fails	1.44E-02	8.05E-05	1.0
060-SD---TL002---TL--FOH	Motor #2 Over Torque Sensor Fails	1.44E-02	8.05E-05	1.0
060-SLDGATE-IEL-FOD	Slide Gate Interlock Fails	2.75E-05		
060-SPMRC-BRK001-BRP-FOD	SPMRC Pneumatic Brakes Fail	5.02E-05		
060-SPMRC-BRP000-BRP-FOD	Brake (Pneumatic) Failure on Demand	5.02E-05		
060-SPMRC-BRP001-BRP-FOD	SPMRC Fails to Stop on Loss of Power	5.02E-05		
060-SPMRC-CBP001-CBP-OPC	Power Cable to SPMRC - Open Circuit	9.13E-08	9.13E-08	1.0

Table 6.3-1. Active Component Reliability Data Summary (Continued)

Basic Event Name	Basic Event Description	Basic Event Mean Probability ^a	Mean Failure Rate ^a	Mission Time (Hours)
060-SPMRC-CBP001-CBP-SHC	SPMRC Power Cable - Short Circuit	1.88E-08	1.88E-08	1.0
060-SPMRC-CPL000-CPL-FOH	Railcar Automatic Coupler System Fails	1.91E-06	1.91E-06	1.0
060-SPMRC-CT000--CT--FOD	SPMRC Primary Stop Switch Fails	4.00E-06		
060-SPMRC--CT001-CT--FOD	On-Board Controller Fails to Respond	4.00E-06		
060-SPMRC-CT002--CT--FOH	Pendant Direction Controller Fails	6.88E-05	6.88E-05	1.0
060-SPMRC--CT003-CT--SPO	On-Board Controller Initiates Spurious Signal	2.27E-05	2.27E-05	1.0
060-SPMRC-DERAIL-DER-FOM	Derailment of a Railcar per Mile	1.18E-05	1.18E-05	1.0
060-SPMRC-G65000-G65-FOH	SPMRC Speed Control (Governor) Fails	1.16E-05	1.16E-05	1.0
060-SPMRC-HC001-HC--FOD	Pendant Control Transmits Wrong Signal	1.74E-03		
060-SPMRC-HC001--HC--SPO	Spurious Command from Pendant Controller	5.23E-07	5.23E-07	1.0
060-SPMRC-IEL011-IEL-FOD	Failure of Mobile Platform Anti-Collision Interlock	2.75E-05		
060-SPMRC-MOE000-MOE-FSO	Motor (Electric) Fails to Shut Off	1.35E-08	1.35E-08	0.0
060-SPMRC-SC021--SC--FOH	Speed Controller on SPMRC Pendant Fails	1.28E-04	1.28E-04	1.0
060-SPMRC-SEL021-SEL-FOH	Speed Selector on SPMRC Pendant Fails	4.16E-06	4.16E-06	1.0
060-SPMRC-STU001-STU-FOH	SPMRC End Stops Fail	4.81E-08	4.81E-08	1.0
060-SPMTT-BRK000-BRP-FOD	Pneumatic Brakes on SPMTT Fail on Demand	5.02E-05		
060-SPMTT-BRK001-BRP-FOD	SPMTT Pneumatic Brakes Fail	5.02E-05		
060-SPMTT-CBP002-CBP-OPC	SPMTT Power Cable - Open Circuit	9.13E-08	9.13E-08	1.0
060-SPMTT-CBP003-CBP-SHC	SPMTT Power Cable - Short Circuit	1.88E-08	1.88E-08	1.0
060-SPMTT-CPL000-CPL-FOH	Truck Trailer Automatic Coupler System Fails	1.91E-06	1.91E-06	1.0
060-SPMTT-CT000--CT--FOD	SPMTT Primary Stop Switch Fails	4.00E-06		
060-SPMTT--CT001-CT--FOD	On-Board Controller Fails to Respond	4.00E-06		
060-SPMTT--CT001-CT--SPO	On-Board Controller Spurious Operation	2.27E-05	2.27E-05	1.0
060-SPMTT-CT002--CT--FOH	Controller Failure	6.88E-05	6.88E-05	1.0

Table 6.3-1. Active Component Reliability Data Summary (Continued)

Basic Event Name	Basic Event Description	Basic Event Mean Probability ^a	Mean Failure Rate ^a	Mission Time (Hours)
060-SPMTT-G65000-G65-FOH	SPMTT Speed Control (Governor) Fails	1.16E-05	1.16E-05	1.0
060-SPMTT-HC001-HC--FOD	Remote Control Transmits Wrong Signal	1.74E-03		
060-SPMTT-HC002--HC--SPO	Spurious Signal from Pendant Controller	5.23E-07	5.23E-07	1.0
060-SPMTT-IEL102-IEL-FOD	Failure of Mobile Platform Anti-Collision Interlock	2.75E-05		
060-SPMTT-MOE000-MOE-FSO	Motor (Electric) Fails to Shut Off	1.35E-08	1.35E-08	1.0
060-SPMTT-SC021--SC--FOH	Speed Controller on SPMTT Pendant Fails	1.28E-04	1.28E-04	1.0
060-SPMTT-SEL021-SEL-FOH	Speed Selector on SPMTT Pendant Fails	4.16E-06	4.16E-06	1.0
060-SPMTT-STU001-STU-FOH	SPMTT End Stops Fail	4.81E-08	4.81E-08	1.0
060-ST---BRK001--BRK-FOD	ST Fails to Stop on Loss of Power	1.46E-06		
060-ST---CBP004-CBP--OPC	ST Power Cable - Open Circuit	9.13E-08	9.13E-08	1.0
060-ST---CBP004-CBP--SHC	ST Power Cable Short Circuit	1.88E-08	1.88E-08	1.0
060-ST---CT000---CT--FOD	ST Primary Stop Switch Fails	4.00E-06		
060-ST---CT002---CT--FOH	Direction Controller Fails	6.88E-05	6.88E-05	1.0
060-ST---HC000--HC--SPO	Spurious Commands from Remote Control	5.23E-07	5.23E-07	1.0
060-ST---HC001--HC--FOD	Remote Control Transmits Wrong Signal	1.74E-03		
060-ST---HC002---HC--SPO	Spurious Command to Lift/Lower AO	5.23E-07	5.23E-07	1.0
060-ST-MOE0001-MOE-FSO	ST Lock Mode State Fails on Loss of Power	1.35E-08	1.35E-08	1.0
060-ST---MOE000--MOE-FSO	Motor (Electric) Fails to Shut Off	1.35E-08	1.35E-08	1.0
060-ST---MOE021--MOE-FSO	Drive System on Primary Propulsion Fails	1.35E-08	1.35E-08	1.0
060-ST---SC002--SC--FOH	Speed Control on ST Pendant Control Fails	1.28E-04	1.28E-04	1.0
060-ST---SC021---SC--FOH	Speed Controller on ST Pendant Fails	1.28E-04	1.28E-04	1.0
060-ST---SC021---SC--SPO	On-Board Controller Initiates Spurious Signal	3.20E-05	3.20E-05	1.0
060-ST---SEL021--SEL-FOH	Speed Selector on ST Pendant Fails	4.16E-06	4.16E-06	1.0
060-TILTFRAME-CSC-FOH	Cask tilting frame fails	4.81E-08	4.81E-08	1.0
060-VCOO-NITS-PWR-FAILS	Non-ITS Power Failure to CRCF Supply Fan	3.54E-02	5.00E-05	720.0
060-VCOO-SFAN001-FAN-FTR	Supply Fan for CRCF Fails	5.06E-02	7.21E-05	720.0

Table 6.3-1. Active Component Reliability Data Summary (Continued)

Basic Event Name	Basic Event Description	Basic Event Mean Probability ^a	Mean Failure Rate ^a	Mission Time (Hours)
060-VCOO-SFAN002-FAN-FTR	Fan (Motor-Driven) Fails to Run	5.06E-02	7.21E-05	720.0
060-VCT0-AHU0001-AHU-FTR	CRCF ITS Elec AHU 00001 Fails to run	2.65E-03	3.68E-06	720.0
060-VCT0-AHU0001-CTL-FOD	CRCF ITS Elec AHU 00001 Controller Fails	2.03E-03		
060-VCT0-AHU0002-AHU-FTR	CRCF ITS Elec AHU 00002 Fails to Run	2.65E-03	3.68E-06	720.0
060-VCT0-AHU0002-CTL-FOD	CRCF ITS Elec AHU 00002 Controller Fails	2.03E-03		
060-VCT0-AHU0002-FAN-FTS	CRCF ITS Elec AHU 00002 Fails to Start	2.02E-03		
060-VCT0-AHU0004-AHU-FTR	CRCF ITS Elec AHU 00004 Fails to Run	2.65E-03	3.68E-06	720.0
060-VCT0-AHU0004-CTL-FOD	CRCF ITS Elec AHU 00004 Controller Fails	2.03E-03		
060-VCT0-AHU0004-FAN-FTS	CRCF ITS Elec AHU 00004 Fails to Start	2.02E-03		
060-VCT0-AHU0103-AHU-CCR	CCF of the running CRCF ITS Elec AHUs to continue to run	6.20E-05		
060-VCT0-AHU0202-AHU-CCR	CCF of standby CRCF ITS Elec AHUs to start/run	1.60E-04		
060-VCT0-EXH-005-CTL-FOD	CRCF ITS Elec Exh fan 00005 Controller Fails	2.03E-03		
060-VCT0-EXH-005-FAN-FTR	CRCF ITS Elec Exhaust Fan 00005 Fails to Run	5.06E-02	7.21E-05	720.0
060-VCT0-EXH006-CTL-FOD	CRCF ITS Elec Exh Fan 0006 Controller Fails	2.03E-03		
060-VCT0-EXH-006-FAN-FTR	CRCF ITS Elec Exh. Fan Fails to Run	5.06E-02	7.21E-05	720.0
060-VCT0-EXH-006-FAN-FTS	CRCF ITS Elec Exh fan 00006 Fails to Start	2.02E-03		
060-VCT0-EXH-007-CTL-FOD	CRCF ITS Elec Exh fan 00007 Controller Fails	2.03E-03		
060-VCT0-EXH-007-FAN-FTR	CRCF ITS Elec Exhaust Fan 00007 Fails to Run	5.06E-02	7.21E-05	720.0
060-VCT0-EXH008-CTL-FOD	CRCF ITS Elec Exh Fan 0008 Controller Fails	2.03E-03		
060-VCT0-EXH-008-FAN-FTR	CRCF ITS Elec Exh. Fan 8 Fails to Run	5.06E-02	7.21E-05	720.0
060-VCT0-EXH-008-FAN-FTS	CRCF ITS Elec Exh fan 00008 Fails to Start	2.02E-03		
060-VCT0-EXH0507-FAN-CCR	CCF of running Exh fans for CRCF ITS Elec.	1.20E-03		
060-VCT0-EXH0608-FAN-CCF	CCF to start/run: standby Exh fans for the CRCF ITS Elec	1.30E-03		

Table 6.3-1. Active Component Reliability Data Summary (Continued)

Basic Event Name	Basic Event Description	Basic Event Mean Probability ^a	Mean Failure Rate ^a	Mission Time (Hours)
060-VCTO-AHU0003-AHU-FTR	CRCF ITS Elec AHU 00003 Fails to run	2.65E-03	3.68E-06	720.0
060-VCTO-AHU0003-CTL-FOD	CRCF ITS Elec AHU 00003 Controller Fails	2.03E-03		
060-VCTO-AHU0103-AHU-CCR	CCF of the running CRCF ITS Elec AHUs to continue to run	6.20E-05		
060-VCTO--B-FAN--FAN-FTS	Train B Fan Fails to Start	2.02E-03		
060-VCTO-DMP000A-DMP-FRO	Manual Damper for Train A Fails	6.03E-05	8.38E-08	720.0
060-VCTO-DMP000B-DMP-FRO	Manual Damper for Train B Fails	3.02E-05	8.38E-08	360.0
060-VCTO-DMP001A-DMP-FRO	Manual damper Input to Exhaust Fan A Fails	6.03E-05	8.38E-08	720.0
060-VCTO-DMP001B-DMP-FRO	Manual damper Input to Exhaust Fan B Fails	3.02E-05	8.38E-08	360.0
060-VCTO-DMP009I-DMP-FRO	Manual Damper #09 input Train A Fails	6.03E-05	8.38E-08	720.0
060-VCTO-DMP009O-DMP-FRO	Manual Damper #09 Output Train A Fails	6.03E-05	8.38E-08	720.0
060-VCTO-DMP010I-DMP-FRO	Manual Damper #10 Input Train A Fails	6.03E-05	8.38E-08	720.0
060-VCTO-DMP010O-DMP-FRO	Manual Damper #10 Output Train A Fails	6.03E-05	8.38E-08	720.0
060-VCTO-DMP011I-DMP-FRO	Manual Damper #11 Input Train A Fails	6.03E-05	8.38E-08	720.0
060-VCTO-DMP011O-DMP-FRO	Manual Damper #11 Output Train A Fails	6.03E-05	8.38E-08	720.0
060-VCTO-DMP012I-DMP-FRO	Manual Damper #12 input Train B Fails	3.02E-05	8.38E-08	360.0
060-VCTO-DMP012O-DMP-FRO	Manual Damper #12 Output Train B Fails	3.02E-05	8.38E-08	360.0
060-VCTO-DMP013I-DMP-FRO	Manual Damper #13 Input Train B Fails	3.02E-05	8.38E-08	360.0
060-VCTO-DMP013O-DMP-FRO	Manual Damper #13 Output Train B Fails	3.02E-05	8.38E-08	360.0
060-VCTO-DMP014I-DMP-FRO	Manual Damper #14 in Train B Fails	3.02E-05	8.38E-08	360.0
060-VCTO-DMP014O-DMP-FRO	Manual Damper #14 Output Train B Fails	3.02E-05	8.38E-08	360.0
060-VCTO-DTC0A-DTC-RUP	Duct Fails between HEPA and Exhaust Fan (10 feet)	2.68E-03	3.72E-06	720.0
060-VCTO-DTC0B-DTC-RUP	Duct Fails between HEPA and Exhaust Fan (10 feet)	1.34E-03	3.72E-06	360.0
060-VCTO-FAN00A-FAN-FTR	Exhaust Fan in Train A Fails	5.06E-02	7.21E-05	720.0
060-VCTO-FAN00B-FAN-FTR	Exhaust Fan in Train B Fails	2.56E-02	7.21E-05	360.0

Table 6.3-1. Active Component Reliability Data Summary (Continued)

Basic Event Name	Basic Event Description	Basic Event Mean Probability ^a	Mean Failure Rate ^a	Mission Time (Hours)
060-VCTO-FAN00B-FAN-FTS	Exhaust Fan in Train B Fails to Start	2.02E-03		
060-VCTO-FANA-PRM-FOH	Speed Control Exhaust Fan Train A Fails to maintain Delta P	3.87E-04	5.38E-07	720.0
060-VCTO-FANB-PRM-FOH	Speed Control Exhaust Fan Train B Fails to maintain Delta P	1.94E-04	5.38E-07	360.0
060-VCTO-FSLAB0-SRF-FOH	Low Flow Train A Sensor Failure	7.70E-04	1.07E-06	720.0
060-VCTO-HEPA09-DMS-FOH	Moisture Separator/Demister HEPA 09 Fails	6.55E-03	9.12E-06	720.0
060-VCTO-HEPA0A9-HEP-LEK	HEPA #09 Train A Leaks	2.16E-03	3.00E-06	720.0
060-VCTO-HEPA10-DMS-FOH	Moisture Separator/Demister HEPA 10 Fails	6.55E-03	9.12E-06	720.0
060-VCTO-HEPA11-DMS-FOH	Moisture Separator/Demister HEPA 11 Fails	6.55E-03	9.12E-06	720.0
060-VCTO-HEPA12-DMS-FOH	Moisture Separator/Demister HEPA 12 Fails	3.28E-03	9.12E-06	360.0
060-VCTO-HEPA13-DMS-FOH	Moisture Separator/Demister HEPA 13 Fails	3.28E-03	9.12E-06	360.0
060-VCTO-HEPA14-DMS-FOH	Moisture Separator/Demister HEPA 14 Fails	3.28E-03	9.12E-06	360.0
060-VCTO-HEPAA09-HEP-LEK	HEPA #09 Train A Leaks	2.16E-03	3.00E-06	720.0
060-VCTO-HEPAA09-HEP-PLG	HEPA #A09 Train A Plugged	3.07E-03	4.27E-06	720.0
060-VCTO-HEPAA10-HEP-LEK	HEPA #10 Train A Leaks	2.16E-03	3.00E-06	720.0
060-VCTO-HEPAA10-HEP-PLG	HEPA #A10 Train A Plugged	3.07E-03	4.27E-06	720.0
060-VCTO-HEPAA11-HEP-LEK	HEPA #11 Train A Leaks	2.16E-03	3.00E-06	720.0
060-VCTO-HEPAA11-HEP-PLG	HEPA #A11 Train A Plugged	3.07E-03	4.27E-06	720.0
060-VCTO-HEPAB12-HEP-LEK	HEPA #B12 Train B Leaks	1.08E-03	3.00E-06	360.0
060-VCTO-HEPAB12-HEP-PLG	HEPA #B12 Train B Plugged	1.54E-03	4.27E-06	360.0
060-VCTO-HEPAB13-HEP-LEK	HEPA #B13 Train B Leaks	1.08E-03	3.00E-06	360.0
060-VCTO-HEPAB13-HEP-PLG	HEPA #B13 Train B Plugged	1.54E-03	4.27E-06	360.0
060-VCTO-HEPAB14-HEP-LEK	HEPA #B14 Train B Leaks	1.08E-03	3.00E-06	360.0
060-VCTO-HEPAB14-HEP-PLG	HEPA #B14 Train B Plugged	1.54E-03	4.27E-06	360.0
060-VCTO-HEPAB-CCF	CCF of HEPA Filters (2 of 3)	9.80E-05	1.07E-07	360.0
060-VCTO-HEPA-CCF	CCF of HEPA Filters (2 of 3)	1.96E-04	1.07E-07	720.0
060-VCTO-IEL0001-IEL-FOD	CRCF Door Interlock Failure	2.75E-05		
060-VCTO-PDSLA0B-SRP-FOD	Pressure Differential Train A Switch Fails	3.99E-03		
060-VCTO-SUPPLY-FAN-CCF	CCF of CRCF Supply Fans	2.70E-03	1.67E-06	720.0
060-VCTO-TDMP00A-DTM-FOD	Tornado Damper Train A Fails	8.71E-04		
060-VCTO-TDMP00B-DTM-FOD	Tornado damper B fails on demand	8.71E-04		

Table 6.3-1. Active Component Reliability Data Summary (Continued)

Basic Event Name	Basic Event Description	Basic Event Mean Probability ^a	Mean Failure Rate ^a	Mission Time (Hours)
060-VCTO-TDMP00B-DTM-FOH	Tornado damper Train B Fails	8.10E-03	2.26E-05	360.0
060-VCTO-UDMP000-UDM-FOH	Backdraft Damper for Train B exhaust Fails	8.10E-03	2.26E-05	360.0
060-WPCRN-DROPON-CRW-DRP	WP (Non-SFP) Crane Drop	1.05E-04		
060-WPCRN-DROPON-CRW-TBK	WP (Non-SFP) Crane Two Block Drop	4.49E-05		
060-WPTT-BRK401--BRK-FOD	Brake Failure on Demand	1.46E-06		
060-WPTT-CAM001--CAM-FOH	Locking Mechanism at Unload Area Fails	9.84E-07	3.19E-06	1.0
060-WPTT-DERAIL--DER-FOM	Probability of WPTT Derailment per Mile	1.18E-05	1.18E-05	1.0
060-WPTT-HC001---HC--SPO	Remote Control Sends Spurious Signal	5.23E-07	5.23E-07	1.0
060-WPTT-HC002---HC--SPO	Remote Controller Sends Spurious Signal	5.23E-07	5.23E-07	1.0
060-WPTT-HCWPTT1-HC--SPO	Remote Control Sends Spurious Signal	5.23E-07	5.23E-07	1.0
060-WPTT-HCWPTT2-HC--SPO	Remote Control Sends Spurious Signal	5.23E-07	5.23E-07	1.0
060-WPTT-IEL001-IEL-FOD	Carriage Motor Running Interlock Fails to Halt Power to WPTT	2.75E-05		
060-WPTT-IEL003--IEL-FOD	WPTT Dock Interlock Fails to Halt Power to Trolley	2.75E-05		
060-WPTT-IELDK3--IEL-FOD	WPTT Dock Interlock Fails	2.75E-05		
060-WPTT-MOE001-MOE-FSO	Motor (Electric) Fails to Shut Off	1.35E-08	1.35E-08	1.0
060-WPTT-PLC001--PLC-SPO	On-Board PLC Initiated Spurious Signal	3.65E-07	3.65E-07	1.0
060-WPTT-PLC002--PLC-SPO	On-Board PLC Initiates Spurious Signal	3.65E-07	3.65E-07	1.0
060-WPTT-PLCWPT1-PLC-SPO	On-Board PLC Initiates Spurious Signal	3.65E-07	3.65E-07	1.0
060-WPTT-PLCWPT2-PLC-SPO	On-Board PLC Initiates Spurious Signal	3.65E-07	3.65E-07	1.0
26D-##EGBATCHRGA-BYC-FOH	ITS Switchgear A Battery: Battery Charger failure	1.28E-03	7.60E-06	168.0
26D-##EGBATCHRGB-BYC-FOH	ITS DG B Battery Charger failure	1.28E-03	7.60E-06	168.0
26D-##EG-DAYTNKA-TKF-FOH	ITS DG A Day Tank (00002A) Fails	1.58E-04	4.40E-07	360.0
26D-##EG-DAYTNKB-TKF-FOH	ITS DG B Day fuel tank fails	1.58E-04	4.40E-07	360.0
26D-##EG-FLITLKA-IEL-FOD	ITS DG A fuel transfer pumps Interlock Failure	2.75E-05		

Table 6.3-1. Active Component Reliability Data Summary (Continued)

Basic Event Name	Basic Event Description	Basic Event Mean Probability ^a	Mean Failure Rate ^a	Mission Time (Hours)
26D-##EG-FLITLKB-IEL-FOD	ITS DG B fuel transfer pumps Interlock Failure	2.75E-05		
26D-##EG-FTP1DGA-PMD-FTR	ITS DG A Fuel Transfer Pump Fails to Run	1.23E-02	3.45E-05	360.0
26D-##EG-FTP1DGA-PMD-FTS	ITS DG A Fuel Pump 1A Fails to Start	2.50E-03		
26D-##EG-FTP1DGB-PMD-FTR	ITS DG B Fuel Transfer Pump 1 (Motor Driven) Fails to Run	1.23E-02	3.45E-05	360.0
26D-##EG-FTP1DGB-PMD-FTS	ITS DG B Fuel Transfer Pump 1 (Motor Driven) Fails to Start	2.50E-03		
26D-##EG-FTP2DGA-PMD-FTR	ITS DG A Fuel Transfer Pump 2A Fails to Run	1.23E-02	3.45E-05	360.0
26D-##EG-FTP2DGA-PMD-FTS	ITS DG A Fuel Transfer pump 2A Fails to Start	2.50E-03		
26D-##EG-FTP2DGB-PMD-FTR	ITS DG B Fuel Transfer Pump 2 (Motor Driven) Fails to Run	1.23E-02	3.45E-05	360.0
26D-##EG-FTP2DGB-PMD-FTS	ITS DG B Fuel Transfer Pump 2 (Motor Driven) Fails to Start on Demand	2.50E-03		
26D-##EG-FULPMPA-PMD-CCR	CCF of ITS DG A fuel pumps to run	2.90E-04		
26D-##EG-FULPMPA-PMD-CCS	CCF of ITS DG A fuel pumps to start	1.20E-04		
26D-##EG-FULPMPB-PMD-CCR	CCF of ITS DG B fuel pumps to run	2.90E-04		
26D-##EG-FULPMPB-PMD-CCS	CCF of ITS DG B fuel pumps to start	1.20E-04		
26D-##EG-HVACFN1-FAN-FTR	ITS DG B room Fan 1 (Motor-Driven) Fails to Run	2.56E-02	7.21E-05	360.0
26D-##EG-HVACFN1-FAN-FTS	ITS DG B room Fan (Motor-Driven) Fails to Start	2.02E-03		
26D-##EG-HVACFN2-FAN-FTR	ITS DG B room Fan 2 (Motor-Driven) Fails to Run	2.56E-02	7.21E-05	360.0
26D-##EG-HVACFN2-FAN-FTS	ITS DG B Room Fan (Motor-Driven) Fails to Start	2.02E-03		
26D-##EG-HVACFN3-FAN-FTR	ITS DG B room Fan 3 (Motor-Driven) Fails to Run	2.56E-02	7.21E-05	360.0
26D-##EG-HVACFN3-FAN-FTS	ITS DG B Room Fan 3 (Motor-Driven) Fails to Start	2.02E-03		
26D-##EG-HVACFN4-FAN-FTR	ITS DG B Fan 4 (Motor-Driven) Fails to Run	2.56E-02	7.21E-05	360.0
26D-##EG-HVACFN4-FAN-FTS	ITS DG B Room Fan 4 (Motor-Driven) Fails to Start	2.02E-03		
26D-##EG-STRTDGA-C72-SPO	ITS Switchgear A Battery Circuit Breaker (DC) Spur Op	3.85E-04	1.07E-06	360.0
26D-##EG-STRTDGB-C72-SPO	13.8kV ITS SWGR Battery B Circuit Breaker (DC) Spur Op	3.85E-04	1.07E-06	360.0

Table 6.3-1. Active Component Reliability Data Summary (Continued)

Basic Event Name	Basic Event Description	Basic Event Mean Probability ^a	Mean Failure Rate ^a	Mission Time (Hours)
26D-##EG-WKTNK_A-TKF-FOH	ITS DG A Bulk Fuel Tank (00001A) Fails	1.58E-04	4.40E-07	360.0
26D-##EG-WKTNK_B-TKF-FOH	ITS DG B Bulk Fuel Tank Fails	1.58E-04	4.40E-07	360.0
26D-##EESWGRDGA-AHU-FTR	13.8kV ITS Switchgear room Air Handling Unit Fails	2.65E-03	3.68E-06	720.0
26D-###EEE-SWGRDGA-BUA-FOH	13.8kV ITS Switchgear A Failure	4.39E-04	6.10E-07	720.0
26D-###EEE-SWGRDGB-AHU-FTR	EDGB Switchgear Room Air Handling Unit Failure to Run	2.65E-03	3.68E-06	720.0
26D-###EEE-SWGRDGB-BUA-FOH	13.8kV ITS Switchgear B Bus Failure	4.39E-04	6.10E-07	720.0
26D-##EEG-HVACFA1-FAN-FTR	ITS DG A room Fan 1 (Motor-Driven) Fails to Run	2.56E-02	7.21E-05	360.0
26D-##EEG-HVACFA1-FAN-FTS	ITS DG A room Fan 1 (Motor-Driven) Fails to Start	2.02E-03		
26D-##EEG-HVACFA2-FAN-FTR	ITS DG A room Fan 2 (Motor-Driven) Fails to Run	2.56E-02	7.21E-05	360.0
26D-##EEG-HVACFA2-FAN-FTS	ITS DG A room Fan 2 (Motor-Driven) Fails to Start	2.02E-03		
26D-##EEG-HVACFA3-FAN-FTR	ITS DG A room Fan 3 (Motor-Driven) Fails to Run	2.56E-02	7.21E-05	360.0
26D-##EEG-HVACFA3-FAN-FTS	ITS DG A room Fan 3 (Motor-Driven) Fails to Start	2.02E-03		
26D-##EEG-HVACFA4-FAN-FTR	ITS DG A room Fan 4 (Motor-Driven) Fails to Run	2.56E-02	7.21E-05	360.0
26D-##EEG-HVACFA4-FAN-FTS	ITS DG A room Fan 4 (Motor-Driven) Fails to Start	2.02E-03		
26D-##EEU-208_DGA-BUD-FOH	ITS DC Panel A DC Bus Failure	8.64E-05	2.40E-07	360.0
26D-##EEU-208_DGB-BUD-FOH	ITS DG B DC Panel Failure	8.64E-05	2.40E-07	360.0
26D-##EEY-DGALOAD-C52-FOD	DG A Load Breaker (AC) Fails to Close	2.24E-03		
26D-##EEY-DGBLOAD-C52-FOD	ITS DG B Load Breaker (AC) Fails to Close	2.24E-03		
26D-##EEY-DGLOADS-C52-CCF	CCF of ITS DG Load Breakers to close	1.05E-04		
26D-##EEY-ITSDG-A-#DG-FTR	ITS diesel Generator A Fails to Run	7.70E-01	4.08E-03	360.0
26D-##EEY-ITSDG-A-#DG-FTS	Diesel Generator Fails to Start	8.38E-03		
26D-##EEY-ITSDGAB-#DG-CCR	CCF ITS DG A & B Fail to Run	1.80E-02		
26D-##EEY-ITSDGAB-#DG-CCS	CCF DG A and B to Start	3.90E-04		
26D-##EEY-ITSDGB-#DG-FTR	ITS DG B Fails to Run	7.70E-01	4.08E-03	360.0
26D-##EEY-ITS-DGB-#DG-FTS	Diesel Generator Fails to Start	8.38E-03		
26D-##EEY-OB-SWGA-C52-FOD	13.8kV ITS SWGR feed breaker (AC) Fails to open	2.24E-03		

Table 6.3-1. Active Component Reliability Data Summary (Continued)

Basic Event Name	Basic Event Description	Basic Event Mean Probability ^a	Mean Failure Rate ^a	Mission Time (Hours)
26D-#EEY-OB-SWGA-C52-SPO	13.8kV ITS SWGR A feed Breaker Spurious Operation	3.82E-03	5.31E-06	720.0
26D-#EEY-OB-SWGB-C52-FOD	13.8kV Feed Breaker (from SWYD) Fails on Demand	2.24E-03		
26D-#EEY-OB-SWGB-C52-SPO	13.8kV ITS SWGR Feed Breaker (AC) Spurious Op	3.82E-03	5.31E-06	720.0
26D-#EEY-OB-SWGS-C52-CCF	CCF of 13.8kV ITS SWGR feed breakers to open	1.04E-04		
26D-#EG-BATTERYB-BTR-FOD	ITS SWGR Control Battery B No Output	8.20E-03		
26D-#EG-LCKOUTRL-RLY-FTP	13.8kV ITS Switchgear Feed breaker lockout relay fails to Open CB	3.15E-03	8.77E-06	360.0
26D-#EGLDSQNCRA-SEQ-FOD	DG A Load Sequencer Fails	2.67E-03		
26D-#EG-LDSQNCRB-SEQ-FOD	ITS DG B load sequencer fails	2.67E-03		
26D-#EG-LOCKOUTB-RLY-FTP	13.8 ITS SWGR Lockout Relay (Power) Fails to Open CB	3.15E-03	8.77E-06	360.0
26D-EG-BATTERYA-BTR-FOD	ITS Switchgear A Battery No Output Given Challenge	8.20E-03		
27A-#EEE-BUS2DGA-C52-SPO	13.8kV Open Bus 2 ITS Load Breaker Spurious Operation	3.82E-03	5.31E-06	720.0
27A-#EEE-BUS3DGB-C52-SPO	13.8kV Open Bus 4 to ITS B Load Breaker (AC) Spurious Op	3.82E-03	5.31E-06	720.0
27A-#EEN-OPENBS2-BUA-FOH	13.8kV Open Bus 2 Bus Failure	4.39E-04	6.10E-07	720.0
27A-#EEN-OPENBS4-BUA-FOH	13.8kV Open Bus 4 Bus Failure	4.39E-04	6.10E-07	720.0
27A-#EEN-OPNBS1A-SWP-SPO	13.8kV Open Bus 2 to ITS Div A Electric Power Switch Spur. Xfer	1.12E-04	1.55E-07	720.0
27A-#EEN-OPNBS3B-SWP-SPO	13.8kV Open Bus 4 to ITS B Electric Power Switch Spur Xfer	1.12E-04	1.55E-07	720.0

NOTE: ^a Although the values in this table are shown to a precision of three significant figures, the values are not known to that level of precision. The values in Attachment C may show fewer significant figures. Such differences are not meaningful in the context of this analysis because the corresponding uncertainties (which are accounted for in the analysis) are much greater than differences due to rounding.

AC = alternating current; AHU = air-handling unit; CCF = common-cause failure; CRCF = Canister Receipt and Closure Facility; CTM = canister transfer machine; DG = diesel generator; HEPA = high-efficiency particulate air; ITS = important to safety; MCC = motor control center; PLC = programmable logic controller; SFP = spent fuel pool; SPMRC = site prime mover railcar; SPMTT = site prime mover truck trailer; ST = site transporter; SV = solenoid valve ; WP = waste package; WPTT = waste package transfer trolley.

Source: Attachment C, Section C4.

6.3.2 Passive Equipment Failure Analysis

Many event sequences described in Section 6.1 include pivotal events that arise from loss of integrity of a passive component, namely one of the aging overpacks, casks or canisters that contain a radioactive waste form. Such pivotal events involve (1) loss of containment of radioactive material that prevents airborne releases, or (2) LOS effectiveness. Both types of pivotal events may be caused by failure modes caused by either physical impact to the container or by thermal energy transferred to the container. This section summarizes the results of the passive failure analyses detailed in Attachment D that yield the conditional probability of loss of containment or LOS.

6.3.2.1 Probability of Loss of Containment

An overview of the methodology for calculating the probability of failure of passive equipment from drops and impact loads is presented in Section 4.3.2.2. Consistent with *HLWRS-ISG-02*, (Ref. 2.2.74), the methodology essentially consists of comparing the demand upon the equipment to a capacity curve. The probability of failure is the value of the cumulative distribution function for the capacity curve, evaluated at the demand upon the container. More detailed discussion is presented in Attachment D. The methodology is applicable to all of the waste containers that are processed in the CRCF, including transportation casks, aging overpacks, canisters, and waste packages. As described in Section 4.3.2.2, the condition at which a passive component is said to fail depends on the success criteria defined for the component in the CRCF operation. Passive components are designed and manufactured to ensure that the success criteria are met in normal operating conditions and with margin, to ensure that the success criteria are also met when subjected to abnormal loads, including those expected during event sequences. The design margins, and in some cases materials, may be dictated by the code and standards applied to a given type of container as characterized by tensile elongation data for impact loads and by strength at temperature data for thermal loads.

As described in Section 4.3.2.2, the probability of a passive failure is often based on consideration of variability (uncertainty) in the applied load, and the variability in the strength (resistance) of the component. The variability in the physical and thermal loading are derived from the systems analysis that defines the probabilities of physical or thermal loads of a given magnitude in a given event sequence. Such conditions arise from the event sequence analysis described in Section 6.1. For the analysis of the effects of fires on waste containers, probability distributions were developed for both the load and the response. For drops and impacts, however, an event sequence analysis is used to define conservative conditions for the load rather than deal with possible ranges of such parameters. Therefore, the calculation of the probability of passive failures is based on the response or resistance characteristics of the container, given the conservative point value for the drop or impact load defined for a given event sequence.

6.3.2.2 Probability of Loss of Containment for Drops and Impacts

Calculation of the probability of failure of the various containers is based on the variability in the strength (resistance) of the container as derived from tests, and structural analysis, including Finite Element Analysis (FEA), detailed in Attachment D. Loss of containment probability analysis has been evaluated for various containers by three different studies:

- *Seismic and Structural Container Analysis for the PCSA* (Ref. 2.2.40)
- *Structural Analysis Results of the DOE SNF Canisters Subjected to the 23-foot Vertical Repository Drop Event to Support Probabilistic Risk Evaluations* (Ref. 2.2.84) and *Qualitative Analysis of the Standardized DOE SNF Canister for Specific Canister-on-Canister Drop Events at the Repository* (Ref. 2.2.85)
- *Naval Long Waste Package Vertical Impact on Emplacement Pallet and Invert* (Ref.2.2.27)

All analyses have applied essentially the same methods that include FEA to determine the structural response of the various canisters and cask to drop and impact loads, developing a fragility function for the material used in the respective container, and using the calculated responses (strains) with the fragility function to derive the probability of container breach

Failure probabilities for drops are summarized in Table 6.3-2. Conservative representations of drop height are defined for operations with each type of container. Sometimes more than one conservative drop height is specified, for example, for normal height crane lifts and two-block height crane lifts. LLNL, in *Seismic and Structural Container Analyses for the PCSA* (Ref. 2.2.40), predicts failure probabilities of $<1.0 \times 10^{-8}$ for most of the events. If a probability for the event sequence is less than 1×10^{-8} additional conservatism is incorporated in the PCSA by using a failure probability of 1.0×10^{-5} , which are termed “LLNL, adjusted.” This additional conservatism is added to account for a) future evolutions of cask and canister designs, and b) uncertainties such as undetected material defects, undetected manufacturing deviations, and undetected damage associated with handling before the container reaches the repository, which are not included in the tensile elongation data.

LLNL calculates strains by modeling representative casks, aging overpacks, and canisters that encompass TAD canisters, naval SNF canisters, and a variety of DPCs with the dynamic finite element code, LS-Dyna (Ref. 2.2.40). For these canisters, only flat-bottom drops are considered to model transfers by a CTM. This is justified because these canisters fit sufficiently tightly within the CTM and potential dropped canisters are guided by the canister guide sleeve of the CTM to remain in a vertical position.

INL calculates strains by modeling DOE SNF and MCOs with the static finite element code, ABAQUS (Ref. 2.2.84). The structural evaluations consider off-vertical drops. In such cases, the deformation of the waste form container is greater on the localized area of impact than for a flat-bottom drop, and will therefore yield a greater calculated probability of breach.

Probability of failure is conservatively calculated by comparing the peak strain to the cumulative distribution function derived from tensile strain to failure test data reported in the literature, representing aleatory uncertainty associated with the variability of test coupon data.

BSC FEA analysis used LSDyna to model waste packages. Alloy 22 is not stainless steel but a nickel-based alloy, and the most appropriate metric for probability of failure is a cumulative distribution function over extended toughness fraction (See Attachment D, Section D1.4). The probability of failure is calculated using the peak toughness index over the waste package, which is a measure of the alloy’s energy absorbing capability.

Table 6.3-2. Failure Probabilities Due to Drops and Other Impacts

	Drop Height (ft)	Failure Probability	Note
Representative Transportation Cask ^a	13.1	1.0×10^{-5}	4 degrees from vertical, LLNL, adjusted, no impact limiters
	6	1.0×10^{-5}	4 degrees from horizontal, LLNL, adjusted, no impact limiters
	Slapdown after 13.1 foot drop	1.0×10^{-5}	LLNL, adjusted, no impact limiters
Representative Canister	32.5 ^b	1.0×10^{-5}	flat bottomed, LLNL, adjusted
DOE Standardized 24" or 18" canister	23	1.0×10^{-5}	3 degrees from vertical, LLNL, adjusted using INL FEA
Aging overpack	3	1.0×10^{-5}	LLNL, adjusted
MCO canister	23	9.0×10^{-2}	LLNL using INL FEA
HLW canister	30	6.7×10^{-2}	Bayesian interpretation of test data, 0 failures in 13 drops.
Waste package	6	5.0×10^{-3}	BSC FEA, 4 degrees off vertical

NOTE: ^a Also applies to shielded transfer casks used onsite and horizontal transfer casks. Although shielded transfer casks are not used in the CRCF, they are mentioned here for completeness.

^b For transfers by the CTM, this drop height is greater than the maximum drop height (except for CTM transfers in the IHF)

BSC = Bechtel SAIC Company, LLC; DOE = U.S. Department of energy; FEA=finite element analysis; HLW = high-level radioactive waste; INL = Idaho National Laboratory;; LLNL = Lawrence Livermore National Laboratory; MCO = multicanister overpack.

Source: Attachment D

Containment failure probabilities due to other physical impact conditions, equivalent to drops, are listed in Table 6.3-3. These probabilities were modeled by LLNL using FEA, resulting in prediction of failure probabilities of $<1.0 \times 10^{-8}$. Again, additional conservatism was incorporated by using a failure probability of 1.0×10^{-5} for most of these events. The side impact event was not adjusted from the LLNL result of $< 1.0 \times 10^{-8}$ because of the very low velocities involved. A comparison of the strains induced by drops and slow speed, side impacts indicates significantly lower strains for the low velocity impacts.

Table 6.3-3. Failure Probabilities Due to Miscellaneous Events

Event	Failure Probability	Note
Derail	1.0×10^{-5}	LLNL, adjusted, analogous TO 6', 4° from horizontal
Rollover	1.0×10^{-5}	LLNL, adjusted, analogous to 6', 4° from horizontal
Drop on	1.0×10^{-5}	LLNL, adjusted 10-metric-ton load onto container
Tip over	1.0×10^{-5}	LLNL, adjusted, analogous to 13.1-foot drop plus slap-down
Side Impact from collision with rigid surface	1.0×10^{-8}	Or value for low speed collision, whichever is greater (table 6.3-4) crane moving 20 ft/min
Tilt Down/Up	1.0×10^{-5}	LLNL, adjusted; bounded by slap-down

NOTE: LLNL = Lawrence Livermore National Laboratory.

Source: Attachment D.

Table 6.3-4 shows failure probabilities for various collision events for various containers as a function of impact speed. For each of the events, the collision speed, whether in miles per hour (mph) or fpm is converted to feet per second (fps), then to an equivalent drop height in feet. The drop heights are very small compared with the drop heights for the modeled situations summarized in Table 6.3-2. The damage to a container, expressed in terms of strain, is roughly proportional to the impact energy, which is proportional to the drop height, as is readily seen from the following:

Energy from drop = $mgh \propto Fs$ and $F \propto mg$, therefore, $s \propto h$, where s = strain, F = local force on container from drop, m = mass of container, h = drop height, and g = acceleration of gravity.

For drop heights other than those for the modeled situations presented in Table 6.3-2, failure probabilities can be estimated by shifting capacity curve to match the conservative failure probabilities listed in Table 6.3-2. The mean failure drop height, H_m , is found so that the probability of failure, P, is the value listed in Table 6.3-2 for the drop height, H_d , listed in Table 6.3-2.

$$P = \int_{-\infty}^x N(t) dt \quad \text{and} \quad x = \frac{H_d/H_m - 1}{COV} \quad (\text{Eq. 17})$$

where

- P = probability of failure for container dropped from height H_d
- N(t) = standard normal distribution with mean of zero and standard deviation of one
- t = variable of integration
- H_d = modeled drop height for which the failure probability has been determined

- H_m = median failure drop height of the failure drop height distribution such that the failure probability at the modeled drop height, H_d , is P
- COV = coefficient of variation = ratio of standard deviation to mean for strain capacity distribution, applied here to stress capacity or true tensile strength

The probabilities of failure for the collision cases listed in Table 6.3-4 are then determined using the above formula with H_m determined above and with H_d being the drop height corresponding to the collision speed as listed in Table 6.3-4.

Two-blocking events are also included in Table 6.3-4. The failure probabilities of these events are shown in *PEFA Chart.xls* included in Attachment H. The CTM, which lifts canisters, is designed such that drops from the height associated with two-blocking is very low probability and no higher than drops from normal operation. The design features that ensure this are: slide gate closure and two levels of shut-off switches as the normal lift height is exceeded, and a tension relief device that prevents over tensioning of hoist cables if the two-block height is reached. Transportation cask handling cranes are also equipped with the shut-off switches and the tension relief device.

During transfers by a CTM, a shear-type structural challenge was identified as a potential initiating event. This challenge is caused, for example, by the spurious movement of the CTT from which the canister is extracted, before the canister is fully lifted inside the CTM shield bell. A bounding value of one is selected for the probability of failure of the transferred canister. This conservative estimate is used because the structural response of a canister to a shear-type structural challenge was not evaluated and its probability cannot be inferred from comparison with other structural challenges to the canister.

Table 6.3-4. Failure Probabilities for Collision Events and Two-Blocking

Collision Scenario	Speed	Velocity (Ft/Sec)	Equivalent Drop Height (Ft) ^A	Failure Probabilities For Various Container Types				
				Transportation Cask	SNF Canister Analyzed As Representative Of DSTD, DPC, Naval, and TAD Canisters	Waste Package	MCO	High-Level Radioactive Waste
Railcar	2.5 (mph)	3.67	0.21	1.00E-08				
Truck trailer	2.5 (mph)	3.67	0.21	1.00E-08				
CRANE	20 (ft/min)	0.33	0.00	1.00E-08				
CTT	10 (ft/MIN)	0.17	0.00	1.00E-08	1.00E-08		1.00E-08	1.00E-08
ST	2.5 (mph)	3.67	0.21		1.00E-08		1.00E-08	1.00E-08
WPTT	40 (ft/min)	0.67	0.01		1.00E-08	1.00E-08	1.00E-08	1.00E-08
WP (IN TEV)	1.7 (mph)	2.49	0.10			1.00E-08		
CTM	20 (ft/min)	0.33	0.00		1.00E-08		1.00E-08	1.00E-08
CTM	40 (ft/min)	0.67	0.01		1.00E-08		1.00E-08	1.00E-08
Two blocking				1.00E-05	1.00E-05	NA	1.00E+00	6.70E-02

NOTE: ^A Calculated as follows based on constant acceleration due to gravity (no air resistance): $v^2 / (2 \times 32.2 \text{ ft} / \text{sec}^2)$, where v is the velocity in ft / sec. Values are rounded to the nearest hundredth of a ft. Values that are less than 0.005 are reported as 0.00.

CTM = canister transfer machine; CTT = cask transfer trolley; DPC = dual-purpose canister; DOE = U.S. Department of Energy; ft = feet; MCO = multicanister overpack; min = minutes; mph = miles per hour; sec = seconds; ST = site transporter; STD = standardized; TAD = transportation, aging, and disposal; TEV = transport and emplacement vehicle; WP =waste package; WPTT = waste package transfer trolley.

Source:: Original

6.3.2.3 Probability of Canister Failure in a Fire

In addition to passive equipment failures as a result of structural loads, passive failures can also occur as a result of thermal loads such as exposure to fires or abnormal environmental conditions, for example, loss of HVAC cooling. The PCSA evaluates the probability of loss of containment (breach) due to a fire for several types of waste form containers, including: transportation casks containing uncanistered SNF assemblies, and canisters representative of TAD canisters, DPCs, DOE standardized canisters, HLW canisters, and naval SNF canisters.

The methods for analyzing thermally-induced passive failures are discussed in Section 4.3.2.2., and detailed in Attachment D. In summary, the probability of failure of a waste form container as a result of a fire is evaluated by comparing the demand upon a container (which represents the thermal challenges of the fire vis-à-vis the container), with the capacity of the container (which represents the variability in the temperature at which failure would occur). The demand upon the container is controlled by the fire duration and temperature, because these factors control the amount of energy that the fire could transfer to the container.

In response to a fire, the temperature of the waste form container under consideration increases as a function of the fire duration. The maximum temperature is calculated using a heat transfer model that is simplified to allow a probabilistic analysis to be performed that accounts for the variability of key parameters. The model accounts for radiative and convective heat transfers from the fire, and also for the decay heat from the waste form inside a container. The temperature evolution of waste form containers is analyzed based on a simplified geometry with a wall thickness that, for the range of waste form containers of interest in the PCSA, is representative or conservatively small. Specifically, two characteristic canister wall thicknesses are modeled: 0.5 inches, characteristic of some DPCs and other waste canisters; and 1.0 inches, the anticipated thickness of TAD canisters. The wall thickness of a container is an important parameter that governs both container heating and failure. Other conservative and realistic modeling approaches are introduced in the heat transfer model, as appropriate. For example, fires are conservatively considered to engulf a container, regardless of the fact that a fire at the GROA may simply be in the same room as a container. When handled, TAD canisters, DPCs, DOE standardized canisters, HLW canisters and naval SNF canisters are enclosed within another SSC, for example a transportation cask, the shielded bell of a canister transfer machine, or a waste package. Therefore, a fire does not directly impinge on such canisters. In contrast, the external surface of a transportation cask containing uncanistered SNF may be impinged upon directly by the flames of the fire.

Accounting for the uncertainty of the key parameters of the fires and the heat transfer model, the maximum temperature reached by a waste form container, which represents the demand upon the container due to a fire, is characterized with a probability distribution. The distribution is obtained through Monte Carlo simulations.

To determine whether the temperature reached by a waste form container is sufficient to cause the container to fail, the fire fragility distribution curve for the container is evaluated. In the PCSA, this curve is expressed as the probability of breach of the container as a function of its temperature. Two failure modes are considered for a container that is subjected to a thermal challenge: creep-induced failure and limit load failure. Creep, the plastic deformation that takes place when a material is held at high temperature for an extended period under tensile load, is possible for long duration fires. Limit load failure corresponds to situations where the load exerted on a material exceeds its structural strength. This failure mode is considered because the strength of a container decreases as its temperature increases. The variability of the key parameters that can lead to a creep-induced failure or limit load failure is modeled with probability distributions. Monte Carlo simulations are then carried out to produce the fire fragility distribution curve for a container.

The probability of a waste form container losing its containment function as a result of a fire is calculated by running numerous Monte Carlo simulations in which the temperature reached by the container, sampled from the probability distribution representing the demand on the container, is compared to the sampled failure temperature from the fragility curve. The model counts the simulation result as a failure if the container temperature exceeds the failure temperature. Statistics based upon the number of recorded failures in the total number of simulations are used to estimate the mean of the canister failure probability.

Table 6.3-5 shows the calculated mean and standard deviation for the failure probability of a canister in the following configurations: a canister in a transportation cask, a canister in a waste package, and a canister in a shielded bell.

Table 6.3-5. Summary of Canister Failure Probabilities in Fire

Configuration ^b	Failure Probability	
	Mean	Standard Deviation
Thin-Walled ^c Canister in a Waste Package ^a	3.2×10^{-4}	5.7×10^{-5}
Thick-Walled ^c Canister in a Waste Package ^a	1.0×10^{-4}	2.2×10^{-5}
Thin-Walled Canister in a Transport Cask	2.0×10^{-6}	1.4×10^{-6}
Thick-Walled Canister in a Transport Cask	1.0×10^{-6}	1.0×10^{-6}
Thin-Walled Canister in a Shielded Bell	1.4×10^{-4}	2.6×10^{-5}
Thick-Walled Canister in a Shielded Bell	9.0×10^{-5}	1.7×10^{-5}

NOTE: ^a For the 5-DHLW/DOE SNF waste package, this probability applies only to the DOE HLW canisters located on the periphery of the waste package. The DOE SNF canister in the center of the waste package would not be heated appreciably by the fire.

^b Configurations not addressed in this table include, any canister in a waste package that is inside the transfer trolley or any canister inside an aging overpack. In these configurations, the canister is protected from the fire by the massive steel transfer trolley or by the massive concrete overpack. Calculations have shown that the temperatures experienced by the canister in these configurations are well below the canister failure temperature, so that failures for these configurations can be screened. For conservatism, a screening conditional probability of 1×10^{-6} could be used.

^c Naval SNF canisters are modeled as thick walled. Other canisters are modeled as thin walled.

Source: Attachment D, Table D2.1-9.

Note that, no failure probability is provided for a bare canister configuration. The reason for this is that the canister is outside of a waste package or cask for only a short time. During that time, the canister is usually inside the shielded bell of the CTM. The preceding analysis addressed a fire outside the shielded bell. When in that configuration, the canister is shielded from the direct effects of the fire. A fire inside the shielded bell, which could directly heat the canister, is not considered to be credible for two reasons. First, the hydraulic fluid used in the CTM equipment is non-flammable and no other combustible material could be present inside the bell to cause a fire. Second, the annular gap between the canister and the bell is only 3 inches wide, but is approximately 27 feet long. Given this configuration, it is unlikely that there is sufficient inflow of air to sustain a large fire that could heat a significant portion of the canister wall. There may be sufficient inflow to sustain a localized fire, but such a fire would not be adequate to heat the canister to failure.

The canister is also outside of a cask, waste package, or shielded bell as it is being moved from a cask into the shielded bell or from the shielded bell into a waste package. The time during which the canister is in this configuration is extremely short, a matter of minutes, so a fire that occurs during this time is extremely unlikely. In addition, because the gap between the top of the waste package or cask and ceiling of the transfer cell is generally much shorter than the height of the canister, only a small portion of the canister surface is exposed to the fire. Furthermore, this exposure would only be for the short time that the canister was in motion.

In addition, monolithic borosilicate glasses incorporating HLW do not appear to have the potential to release any significant amount of non-volatile radionuclides. These materials would have been heated to temperatures exceeding those anticipated for most fire situations during formation and are not anticipated to undergo any chemical change under fire conditions (Ref. 2.2.9, p. 4-47).

For these reasons, failure of a bare canister was not considered credible and is not explicitly modeled in the PCSA.

6.3.2.4 Probability of Loss of Containment from Heatup

In addition to fire-related passive failures, the PCSA considered other passive equipment failures due to abnormal thermal conditions. The thermal event of greatest concern for the surface facilities is loss of HVAC cooling. If HVAC cooling is lost, the ambient temperature in the facility will increase. This increase is particularly significant for relatively small enclosures such as the transfer cells.

A series of bounding calculations was performed to determine the maximum temperature that could be reached by a canister following loss of HVAC cooling (Ref. 2.2.16). These calculations consider a range of decay heat levels and a loss of cooling for 30 days, which is consistent with NUREG-0800 (Ref. 2.2.69, Section 9.2.5). These analyses indicate that the canister temperature would remain well below 500°C (773°K) (Ref. 2.2.16). This temperature is hundreds of degrees below the temperature at which the canister would fail (Figure D.2.1-4, Attachment D). For that reason, canister failure due to a loss of HVAC is physically unrealizable and considered beyond Category 2.

6.3.2.5 Probability of Loss/Degradation of Shielding

Loss or degradation of shielding probabilities is summarized in Table 6.3-6. However, they are included in this section to illustrate the consistency of methodology across facilities and equipment.

Shielding of a waste form that is being transported inside the GROA is accomplished by several types of shielded SSCs, including: transportation casks, shielded transfer casks, aging overpacks, shielded components of a WPTT, shielded components of a CTM, and shielded components of a TEV. In addition to a shielding function, sealed transportation casks and shielded transfer casks exert a containment function.

A structural challenge may cause shielding degradation or shielding loss. Loss of shielding occurs when an SSC fails in a manner that leaves a direct path for radiation to stream, for example as a result of a breach. Degradation of shielding occurs when a shielding SSC is not breached but its shielding function is degraded. In the PCSA, a shielding degradation probability after a structural challenge is derived for those transportation casks that employ lead for shielding. Finite-element analyses on the behavior of transportation casks subjected to impacts associated with various collision speeds, reported in NUREG/CR-6672 (Ref. 2.2.86), indicate that lead slumping after an end impact could result in a reduction of shielding; transportation casks without lead are not susceptible to such shielding degradation. This information is used in Attachment D to derive the shielding degradation probability of a transportation cask at drop heights characteristic of crane operations. The distribution is developed for impacts on surfaces made of concrete, which compare to the surfaces onto which drops could occur at the GROA. No impact limiter is relied upon to limit the severity of the impact. Conservatively, the distribution is applied to transportation casks and also shielded transfer casks, regardless of whether or not they use lead for shielding. Thus, for containers that have both a containment and shielding function, the PCSA considers a probability of containment failure (which is considered to result in a concurrent loss of shielding), and also a probability of shielding degradation (which is associated with those structural challenges that are not sufficiently severe to cause loss of containment). Table 6.3-6 displays the resulting shielding degradation probabilities for transportation casks and shielded transfer casks after a structural challenge. Given that there is significant conservatism in the calculation of strain and the uncertainty associated with the fragility (strength), the resulting estimates include uncertainties and are considered conservative

Shielding loss is also considered to potentially affect an aging overpack subjected to a structural challenge, if the waste form container inside does not breach. Given the robustness of aging overpacks, a shielding loss after a 3-ft drop height is calculated to have a probability of 5×10^{-6} per aging overpack impact, based upon the judgment that this probability may be conservatively related to but lower than the probability of breach of an unprotected waste form container inside the aging overpack (Attachment D). If the structural challenge is sufficiently severe to cause the loss of containment (breach) of the waste form container inside the aging overpack, the loss of the aging overpack shielding function is considered guaranteed to occur.

A CTM provides shielding with the shield bell, shield skirt, and associated slide gates. Also, the CTM is surrounded by shield walls and doors, which are unaffected by structural challenges

resulting from internal random initiating events. Therefore, such challenges leave the shielding function intact.

A WPTT that transports a waste package is considered to lose its shielding function, if it is subjected to a structural challenge sufficiently severe to cause the breach of the sealed waste package, or, when the waste package is not yet sealed, the breach of one or more canisters inside, as applicable. Conversely, if the structural challenge is not sufficiently severe to cause a canister or waste package breach, it is postulated to also be sufficiently mild to leave the shielding function intact.

Similarly, a TEV that transports a waste package is considered to lose its shielding function if it is subjected to a structural challenge sufficiently severe to cause the breach of the waste package. Conversely, if the structural challenge is not sufficiently severe to cause a waste package breach, it is postulated to also be sufficiently mild to leave the shielding function of the TEV intact

PCSA treats the degradation or loss of shielding of a SSC due to a thermal challenge as described in the following paragraphs.

If the thermal challenge causes the loss of containment (breach) of a canister, the SSC that provides shielding and in which the canister is enclosed is considered to have lost its shielding capability. The SSC providing shielding may be, for example, a WPTT. A transportation cask containing uncanistered SNF is also considered to have lost its shielding if it has lost its containment function.

If the thermal challenge is not sufficiently severe to cause a loss of containment function, it is nevertheless postulated that it will cause shielding loss of the transportation cask, shielded transfer cask, canister transfer machine, cask transfer trolley, waste package transfer trolley, or TEV affected by the thermal challenge and in which the waste form container is enclosed. This is because the neutron shield on these SSCs is made of a polymer which is not anticipated to withstand a fire without failing. Note, however, that the degradation of gamma shielding of these SSCs is unlikely to be affected by a credible fire. Although credible fires could result in the lead melting in a lead-sandwich transportation cask, there is no way to displace the lead, unless the fire is accompanied by a puncture or rupture of the outer steel wall of the cask. Preliminary calculations were unable to disprove the possibility of hydraulic failure of the steel encasing due to the thermal expansion of molten lead, so loss of gamma shielding for steel-lead-steel transportation casks engulfed in fire is postulated. Conservatively, in the PCSA, transportation casks and shielded transfer casks are postulated to lose their shielding function with a probability of one, regardless of whether or not they use lead for shielding.

Aging overpacks made of concrete are not anticipated to lose their shielding function as a consequence of a fire because the type of concrete used for aging overpacks is not sensitive to spallation. In addition, it is likely that the aging overpacks will have an outer steel liner. For these reasons, a loss of aging overpack shielding in a fire has been screened from consideration in the PCSA.

Table 6.3-6. Probabilities of Degradation or Loss of Shielding

	Probability	Note
Sealed Transportation cask and shielded transfer casks shielding degradation after structural challenge	1×10^{-5}	Attachment D, Section D3.4.
Aging overpack shielding loss after structural challenge	5×10^{-6}	Attachment D, Section D3.4
CTM shielding loss after structural challenge	0	Structural challenges sufficiently mild to leave the shielding function intact
WPTT shielding loss after structural challenge	0	Structural challenges sufficiently mild to leave the shielding function intact
TEV shielding loss (shield end)	0	Structural challenges sufficiently mild to leave the shielding function intact
Shielding loss by fire for waste forms in transportation casks or shielded transfer casks	1	Lead shielding could potential expand and degrade. This probability is conservatively applied to transportation casks that do not use lead for shielding.
Shielding loss by fire for aging overpacks, CTM shield bell, and WPTT shielding	0	Type of concrete used for aging overpacks is not sensitive to spallation; Uranium used in CTM shield bell and WPTT shielding does not lose its shielding function as a result of a fire.

NOTE: CTM = canister transfer machine; TEV = transport and emplacement vehicle; WPTT = waste package transfer trolley.

Source: Attachment D, Table D3.4-1.

6.3.2.6 Probability of Other Fire-Related Passive Failures

In addition to the canisters, other passive equipment could fail as a result of a fire. For the PCSA, only failures that would result in a radionuclide release or radiation exposure are considered.

6.3.2.7 Application to Event Sequence Models

Table 6.3-7 summarizes passive failure events needed for the event sequence modeling. The values are either specifically developed in Attachment D, or are values from bounding events. Probabilities for some events were obtained by extrapolation from developed probabilities as described in this section or in Attachment D. The derivation of all passive failure probabilities is described in Attachment D and shown in PEFA Chart.xls included in Attachment H.

It is noted that Table 6.3-7 addresses all passive event failures for the various waste form configurations. Table 6.3-8 identifies the specific passive failure basic events used in event sequence modeling and quantification for the CRCF. The probability of each basic event is based on one of the values presented in Tables 6.3-2 through 6.3-7.

Table 6.3-7. Summary of Passive Event
Failure Probabilities

	10 T dropped on container	Container vertical drop from normal operating height	Container 30- foot vertical drop	Container 45- foot vertical drop	6-foot Horizontal Drop, Rollover	2.5 mph Flat side impact/ collision	2.5 mph Localized side impact/ collision	9 mph Flat side impact/ collision	2.5 mph end- to-end Collision	9 mph end-to- end Collision	Slapdown (bounds tipover)	Thin-Walled Canister Fire	Thick- Walled Canister Fire
Loss of Containment													
Representative Canister ⁵ or HLW Canister in a Transportation Cask	1.E-05	1.E-05	1.E-05	N/A	1.E-05	1.E-08	1.E-08	1.E-08	1.E-08	1.E-08	1.E-05	2.E-06	1.E-06
Transportation Cask with Bare Fuel	1.E-05	1.E-05	1.E-05	N/A	1.E-05	1.E-08	1.E-08	1.E-08	1.E-08	1.E-08	1.E-05	5.E-021	6.E-032
Bare Representative Canister ⁵ (except DSTD)	1.E-05	1.E-05	1.E-05	1.E-05	N/A	N/A	N/A	N/A	N/A	N/A	1.E-05	N/A	N/A
Any Waste Package	1.E-05	N/A	N/A	N/A	1.E-05	1.E-08	N/A	1.E-08	1.E-05	1.E-05	No challenge	3.E-04	1.E-04
Bare MCO	N/A	1.E-01	~ 1	~ 1	N/A	N/A	N/A	N/A	N/A	N/A	N/A	N/A	N/A
Bare DOE Standardized Canister (DSTD)	1.E-05	1.E-05	1.E-05	N/A	N/A	N/A	N/A	N/A	1.E-05	1.E-05	N/A	N/A	N/A
Bare HLW Canister	3.E-023	3.E-02	7.E-02	~ 1	N/A	N/A	N/A	N/A	N/A	N/A	N/A	N/A	N/A
Any Canister in CTM Shield Bell	N/A	1.E-05	N/A	N/A	N/A	1.E-08	N/A	N/A	N/A	N/A	N/A	1.E-04	9.E-05
Applicable Representative Canister in Aging Overpack	1.E-05	1.E-05	N/A	N/A	N/A	1.E-08	1.E-08	1.E-08	N/A	N/A	1.E-05	1.E-06	1.E-06
Loss of Shielding													
Any Transportation Cask	1.E-05	1.E-05	1.E-05	N/A	1.E-05	1.E-08	1.E-08	1.E-08	1.E-08	1.E-08	1.E-05	~ 1	~ 1
Aging Overpack	1.E-05	5.E-06	N/A	N/A	N/A	1.E-05	1.E-05	1.E-05	1.E-05	1.E-05	1.E-05	~ 0	~ 0
TEV, CTM, WPTT	No challenge	No challenge	N/A	N/A	No challenge	No challenge	N/A	No challenge	No challenge	No challenge	No challenge	~ 0	~ 0

NOTE: 1 Truck cask

2 Rail cask

3 Represents passive event failure probabilities for a drop of a HLW canister onto another HLW canister.

4 Naval SNF canisters are modeled as thick walled. Other canisters are modeled as thin walled.

5 SNF Canister analyzed as representative of DOE Standardized SNF Canister (DSTD), DPC, naval, and TAD Canisters.

mph = miles per hour; N/A = not applicable, no scenarios identified.

Source: Attachment D

Table 6.3-8. Passive Failure Basic Events used in CRCF Event Sequence Analysis

Basic Event (BE) ID	Basic Event Description	BE Value	Condition
01-DPC_FAIL_IN_TC	Canister in TCask fails	1.00E+00	Canister in transportation cask fails if cask fails
01-DSNF_FAIL_IN_TC	Canister in TCask fails	1.00E+00	Canister in transportation cask fails if cask fails
01-HLW_FAIL_IN_TC	HLW canister in TCask fails	1.00E+00	Canister in transportation cask fails if cask fails
01-MCO_FAIL_IN_TC	MCO in TCask fails	1.00E+00	Canister in transportation cask fails if cask fails
01-TAD_FAIL_IN_TC	Canister in TCask fails	1.00E+00	Canister in transportation cask fails if cask fails
01-TCASK_RC_COLL	Transportation cask fails in collision	1.00E-08	2.5 mph end-to-end collision
01-TCASK_RC_DERAIL	Transportation cask fails in derailment	1.00E-08	2.5 mph end-to-end collision
01-TCASK_TT_ROLLOVER	Transportation cask fails in rollover	1.00E-05	6-foot horizontal drop - rollover
02-CAN-STAO_ROLL_DROP	Canister fails in AO	1.00E-05	Canister in AO fails in 3-foot drop or tipover
02-ST_AO_COLLIDE	Canister in AO fails	1.00E-08	Canister in AO fails in 2.5 mph side impact collision
03-DPC_FAIL_IN_TC	Canister in TCask fails	1.00E+00	Canister in transportation cask fails if cask fails
03-DPC_FAIL_IN_TC_2BL	Canister fails in TC from 2-block drop	1.00E+00	Canister in transportation cask fails if cask fails
03-DSTD_FAIL_IN_TC	DOE Std. canister in TCask fails	1.00E+00	Canister in transportation cask fails if cask fails
03-DSTD_FAIL_IN_TC_2BL	DOE Std. canister fails in TC from 2-block drop	1.00E+00	Canister in transportation cask fails if cask fails
03-HLW_FAIL_IN_TC	HLW canister in TCask fails	1.00E+00	Canister in transportation cask fails if cask fails
03-HLW_FAIL_IN_TC_2BL	HLW canister fails in TC from 2-block drop	1.00E+00	Canister in transportation cask fails if cask fails
03-MCO_FAIL_IN_TC	MCO in TCask fails	1.00E+00	Canister in transportation cask fails if cask fails
03-MCO_FAIL_IN_TC_2BL	MCO fails in TC from 2-block drop	1.00E+00	Canister in transportation cask fails if cask fails
03-TAD_FAIL_IN_TC	Canister in TCask fails	1.00E+00	Canister in transportation cask fails if cask fails
03-TAD_FAIL_IN_TC_2BL	TAD canister fails in TC from 2-block drop	1.00E+00	Canister in transportation cask fails if cask fails
03-TCASK_2BLK	TC failure from two-block drop	1.00E-05	TC fails in 30 ft vertical drop 2-block event
03-TCASK_IMPACT	Cask fails from impact	1.00E-08	2.5 mph side impact from spurious movement of crane or CTT
03-TCASK_SIMPACT	Cask fails from impact	1.00E-08	2.5 mph side impact from collision with forklift
03-TCASK_TIPOVER	Transportation cask fails	1.00E-05	CTT with TC tips over

Table 6.3-8. Passive Failure Basic Events used in CRCF Event Sequence Analysis (Continued)

Basic Event (BE) ID	Basic Event Description	BE Value	Condition
03-TCASK-DROP	TCask failure	1.00E-05	Vertical 15 ft drop of TC
03-TCASK-DROPON	TCask failure from drop on	1.00E-05	10 ton load dropped onto TC
04-DPC_FAIL_IN_TC	Canister in TCask fails	1.00E+00	Canister in transportation cask fails if cask fails
04-DSNF_FAIL_IN_TC	Canister in TCask fails	1.00E+00	Canister in transportation cask fails if cask fails
04-HLW_FAIL_IN_TC	HLW canister in TCask fails	1.00E+00	Canister in transportation cask fails if cask fails
04-MCO_FAIL_IN_TC	MCO in TCask fails	1.00E+00	Canister in transportation cask fails if cask fails
04-TAD_FAIL_IN_TC	Canister in TCask fails	1.00E+00	Canister in transportation cask fails if cask fails
04-TCASK_IMPACT_TIP	TCask fails from impact caused by tipover	1.00E-05	Tip over of cask
04-TCASK_SIMPACT	Cask fails from impact	1.00E-08	2.5 mph side impact to cask from crane, forklift or spurious CTT movement
04-TCASK-DROP	TCask failure	1.00E-05	Vertical 15 ft drop of TC
04-TCASK-DROPON	TCask failure from drop on	1.00E-05	10 ton load dropped onto TC
05-TAD_AO_IMPACT	TAD canister fails in AO	1.00E-08	2.5 mph Side impact to AO from forklift or spurious ST movement
05-TAD_AO_TIP	TAD canister failure in AO	1.00E-05	AO on ST tips over
05-TCASK_SIMPACT	Cask fails from side impact	1.00E-08	2.5 mph Side impact to cask from crane, forklift or spurious CTT movement
06-DPC-FAIL-CTT-COLLIDE	DPC fails in open TCask	1.00E-08	DPC fails inside open TC in 2.5 mph collision of CTT
06-DPC-FAIL-CTT-IMPACT	DPC fails in open TCask	1.00E-08	DPC fails inside open TC in impact by crane
06-DSNF-FAIL-CTT-COLLIDE	DOE Std. Canister Fails in Open TCask	1.00E-08	DOE SNF canister fails inside open TC in 2.5 mph collision of CTT
06-DSNF-FAIL-CTT-IMPACT	DOE Std. Canister Fails in Open TCask	1.00E-08	DOE SNF canister fails inside open TC in impact by crane
06-HLW-FAIL-CTT-COLLIDE	HLW Canister Fails in Open TCask	1.00E-08	HLW canister fails inside open TC in 2.5 mph collision of CTT
06-HLW-FAIL-CTT-IMPACT	HLW Canister Fails in Open TCask	1.00E-08	HLW canister fails inside open TC in impact by crane
06-MCO-FAIL-CTT-COLLIDE	MCO Fails in Open TCask	1.00E-01	MCO canister fails inside open TC in 2.5 mph collision of CTT
06-MCO-FAIL-CTT-IMPACT	MCO Fails in Open TCask	1.00E-01	MCO canister fails inside open TC in impact by crane
06-TAD_FAIL_ST_AO_IMPACT	TAD canister Fails in Open AO	1.00E-08	Crane impact to open AO
06-TAD_FAIL_STAO_COLLIDE	TAD canister Fails in Open AO	1.00E-08	2.5 mph ST collision

Table 6.3-8. Passive Failure Basic Events used in CRCF Event Sequence Analysis (Continued)

Basic Event (BE) ID	Basic Event Description	BE Value	Condition
06-TAD-FAIL-CTT-COLLIDE	TAD canister Fails in Open TCask	1.00E-08	2.5 mph CTT collision
06-TAD-FAIL-CTT-IMPACT	TAD canister Fails in Open TCask	1.00E-08	Crane impact to open TC
07-DPC-FAIL-SD-IMPACT	DPC in Cask or AO fails by SD impact	1.00E-08	2.5 mph flat side impact to CTT or ST by shield door
07-DSTD-FAIL-CTT-IMPACT	DOE Std. canister in Cask Fails	1.00E-08	2.5 mph flat side impact to open TC by shield door
07-HLW-FAIL-CTT-IMPACT	HLW canister Fails in Open TCask	1.00E-08	2.5 mph flat side impact to open TC by shield door
07-MCO-FAIL-CTT-IMPACT	MCO Fails in Open TCask	1.00E-08	2.5 mph flat side impact to open TC by shield door
07-TAD-FAIL-SD-IMPACT	TAD canister in Cask or AO Fails by SD Impact	1.00E-08	2.5 mph flat side Impact to CTT or ST by Shield door
07-WP_FAIL_IMPACT	WP Fails in Impact	1.00E-08	2.5 mph flat side impact to WPTT by shield door
08-2DPCS_BREACHED	Canisters Breached	1.00E-08	2 CTMs collide
08-2DSNFS_BREACHED	Canisters Breached	1.00E-08	2 CTMs collide
08-2HLWS_BREACHED	Canisters Breached	1.00E-08	2 CTMs collide
08-2MCOS_BREACHED	Canisters Breached	1.00E-08	2 CTMs collide
08-2TADS_BREACHED	Canisters Breached	1.00E-08	2 CTMs collide
09-CAN_FAIL_IN_CTM_2BL	Canister Failure from 2-Block Drop	1.00E-05	DPC or TAD canister fail from 2-block
09-CAN-FAIL-DROP	Canister Failure from Drop	1.00E-05	DPC or TAD canister fail – normal drop
09-CAN-FAIL-DROPON	Canister Failure from Drop On	1.00E-05	DPC or TAD canister fail – 10 ton drop-on
09-CAN-FAIL-IN-BELL	Canister Failure in CTM Bell	1.00E-05	DPC or TAD canister fail – Drop in shield bell
09-CAN-FAIL-LID-IMPACT	Canister Failure from Dropped Cask	1.00E-05	DPC or TAD canister fail – Dropped lid
09-CAN-FAIL-SIMPACT	Canister Fails from Side Impact	1.00E-08	DPC OR TAD canister fail – 2.5 mph CTM side impact
09-CAN-FAIL-SPURMOVE	Canister Failure due to Shear	1.00E+00	DPC, TAD canister or DOE Std canister fail – Shear
09-DSTD_FAIL_IN_CTM_2BL	DOE Std. canister Failure from 2-Block Drop	1.00E-03	DOE Std. canister fail from 2-block
09-DSTD-FAIL-DROP	DOE Std. canister Failure from Drop	1.00E-05	DOE SNF canister fail – normal drop
09-DSTD-FAIL-DROPON	DOE Std. canister Failure from Drop On	1.00E-05	DOE SNF canister fail – 10 ton drop-on
09-DSTD-FAIL-IN-BELL	DOE Std. canister Failure in CTM Bell	1.00E-05	DOE SNF canister fail – Drop in shield bell
09-DSTD-FAIL-LID-IMPACT	DOE Std. canister Failure from Dropped Cask	0.00E-00	DOE SNF canister fail – Dropped lid
09-DSTD-FAIL-SIMPACT	DOE Std. canister Failure from Side Impact	1.00E-08	DOE Std. canister fail – 2.5 mph CTM side impact

Table 6.3-8. Passive Failure Basic Events used in CRCF Event Sequence Analysis (Continued)

Basic Event (BE) ID	Basic Event Description	BE Value	Condition
09-HLW_FAIL_IN_CTM_2BL	Canister Failure from 2-Block Drop	7.00E-02	HLW canister fail from 2-block
09-HLW-FAIL-DROP	HLW Canister Fails from Drop	3.00E-02	HLW Canister fail – normal drop
09-HLW-FAIL-DROPON	HLW Canister Fails from Drop On	3.00E-02	HLW Canister fail – 10 ton drop-on – canister drop on canister
09-HLW-FAIL-IN-BELL	Canister Fails in CTM Bell	1.00E-05	HLW Canister fail – Drop in shield bell
09-HLW-FAIL-LID-IMPACT	HLW Canister Fails from Dropped Cask	0.00E-00	HLW Canister fail – Dropped lid
09-HLW-FAIL-SIMPACT	HLW Canister Fails from Side Impact	1.00E-08	HLW Canister fail – 2.5 mph CTM side impact
09-HLW-FAIL-SPURMOVE	HLW Canister Fails from Shear	1.00E+00	HLW Canister fail – Shear
09-MCO_FAIL_IN_CTM_2BL	MCO Failure from 2-Block Drop	1.00E+00	MCO canister fail from 2-block
09-MCO-FAIL-DROP	MCO Fails from Drop	1.00E-01	MCO Canister fail – normal drop
09-MCO-FAIL-DROPON	MCO Fails from Drop On	1.00E-01	MCO Canister fail – 10 ton drop-on
09-MCO-FAIL-IN-BELL	MCO Fails in CTM Bell	1.00E-01	MCO Canister fail – Drop in shield bell
09-MCO-FAIL-LID-IMPACT	MCO Fails from Dropped Cask	0.00E-00	MCO Canister fail – Dropped lid
09-MCO-FAIL-SIMPACT	MCO Fails from Side Impact	1.00E-01	MCO Canister fail – 2.5 mph CTM side impact
09-MCO-FAIL-SPURMOVE	MCO Fails from Shear	1.00E+00	MCO Canister fail – Shear
10-CAN-FAIL-WPTT-COLLIDE	TAD canister Fails in Open WP	1.00E-08	Canister in open WP fails – 2.5 mph side impact collision to WPTT
10-CAN-FAIL-WPTT-DERAIL	TAD canister Fails in Open WP	1.00E-08	Canister in open WP fails – 2.5 mph end-to-end collision
10-CAN-FAIL-WPTT-TILT	TAD canister Fails in Open WP	0.00E-00	Canister in open WP fails –side impact tilt down
10-H&D-FAIL-WPTT-COLLIDE	DOE Std. canister Fails in Open WP	1.00E-08	Canister in open WP fails – 2.5 mph side impact collision
10-H&D-FAIL-WPTT-DERAIL	DOE Std. canister Fails in Open WP	1.00E-08	Canister in open WP fails – 2.5 mph end-to-end collision
10-H&D-FAIL-WPTT-TILT	DOE Std. canister Fails in Open WP	0.00E-00	Canister in open WP fails –side impact tilt down
10-H&M-FAIL-WPTT-COLLIDE	MCO Fails in Open WP	1.00E-01	Canister in open WP fails – 2.5 mph side impact collision
10-H&M-FAIL-WPTT-DERAIL	MCO Fails in Open WP	1.00E-01	Canister in open WP fails – 2.5 mph end-to-end collision
10-H&M-FAIL-WPTT-TILT	MCO Fails in Open WP	0.00E-00	Canister in open WP fails –side impact tilt down
10-WP_SHIELDING	WP Shielding Fails	0.00E+00	WP shielding fails from tilt-down
10-WPTT_SHIELDING	WPTT Shielding Fails	0.00E+00	WPTT shielding fails from collision or impact
11-CAN-FAIL-WP-DROPON	TAD canister Fails without WP	1.00E-05	Canister fails in open WP from 10 ton drop-on

Table 6.3-8. Passive Failure Basic Events used in CRCF Event Sequence Analysis (Continued)

Basic Event (BE) ID	Basic Event Description	BE Value	Condition
11-H&D-FAIL-WP-DROPON	DOE Std. canister Fails in open WP	1.00E-05	Canister fails in open WP from 10 ton drop-on
11-H&M-FAIL-WP-DROPON	MCO Fails without WP	1.00E+00	Canister fails in open WP from 10 ton drop-on
11-H&M-FAIL-WP-WELD	MCO Fails in WP	1.00E+00	Canister fails in open WP from welding damage
11-WP_SHIELDING	WP Shielding Fails	0.00E+00	WP shielding fails from welding damage or drop-on
12-DPC_AO_IMPACT	DPC Fails in AO	1.00E-08	2.5 mph side impact to AO on ST
12-DPC_AO_TIPOVER	DPC Fails in AO	1.00E-05	Tip over of ST with AO
12-TAD_AO_IMPACT	TAD canister Fails in AO	1.00E-08	2.5 mph side impact to AO on ST
12-TAD_AO_TIP	TAD canister Failure in AO	1.00E-05	Tip over of ST with AO
13-H&D-FAIL-IN-WP	DOE Std. canister Fails in Closed WP	1.00E+00	Canister fails in closed WP
13-H&M-FAIL-IN-WP	MCO Fails in Closed WP	1.00E+00	Canister fails in closed WP
13-TAD-FAIL-IN-WP	TAD Fails in Closed WP	1.00E+00	Canister fails in closed WP
13-WP_FAIL_COLLISION	WP Fails in Collision	1.00E-08	2.5 mph side impact of WPTT
13-WP_FAIL_TILT	WP Fails from Pre-Tilt-down	0.00E+00	WP fails in tilt-down
13-WP_FAILURE_DERAIL	WP Fails During Derailment	1.00E-05	WP fails in 2.5 mph end-to-end collision
13-WP_SHIELDING	WP Shielding Fails	0.00E+00	WP shielding fails in tilt-down
13-WPTT_SHIELDING	WPTT Shielding Fails	0.00E+00	WPTT shielding fails in derailment or collision
14-DPC_AO_IMPACT	DPC Fails in AO	1.00E-08	Canister fails in AO from 2.5 mph side impact
14-DPC_ST_COLLISION	DPC Fails in AO	1.00E-08	Canister fails in AO from 2.5 mph ST side impact collision
14-TAD_AO_IMPACT	TAD canister Fails in AO	1.00E-08	Canister fails in AO from 2.5 mph side impact
14-TAD_ST_COLLISION	TAD canister Fails in AO	1.00E-08	Canister fails in AO from 2.5 mph ST side impact collision
15-H&D-FAIL-IN-WP	DOE Std. canister Fails in Closed WP	1.00E+00	Canister fails in closed WP
15-H&D-FAIL-IN-WP-DRPON	DOE Std. canister Fails in Closed WP	1.00E+00	Canister fails in closed WP
15-H&M-FAIL-IN-WP	MCO Fails in Closed WP	1.00E+00	Canister fails in closed WP
15-H&M-FAIL-IN-WP-DRPON	MCO Fails in Closed WP	1.00E+00	Canister fails in closed WP
15-TAD-FAIL-IN-WP	TAD canister Fails in Closed WP	1.00E+00	Canister fails in closed WP
15-TAD-FAIL-IN-WP-DRPON	TAD canister Fails in Closed WP	1.00E+00	Canister fails in closed WP
15-WP_FAIL_CRANE_IMPACT	WP Fails from Crane Impact	1.00E-08	WP fails from 2.5 mph side impact
15-WP_FAIL_DROPON	WP Fails from Object dropped on WP	1.00E-05	WP fails from 10 ton drop-on

Table 6.3-8. Passive Failure Basic Events used in CRCF Event Sequence Analysis (Continued)

Basic Event (BE) ID	Basic Event Description	BE Value	Condition
15-WP_FAIL_IMPACT	WP Fails in Impact	1.00E-08	WP fails from 2.5 mph side impact
15-WP_FAILURE_COLL	WP Fails from Collision	1.00E-08	WP fails from 2.5 mph side impact collision of WPTT
15-WP-SHIELDING-NONE	No WP Shielding	0.00E+00	No shielding of WP during extraction from shielding enclosure
16-DPC_ST_COLLISION	DPC Fails in AO	1.00E-08	Canister fails in AO in ST 2.5 mph side impact collision
16-DPC-STAO_ROLL_DROP	DPC Fails in AO	1.00E-08	Canister fails in AO from 3 ft drop or ST rollover
16-TAD_ST_COLLISION	TAD canister Fails in AO	1.00E-08	Canister fails in AO in ST 2.5 mph side impact collision
16-TAD-STAO_ROLL_DROP	TAD canister Fails in AO	1.00E-08	Canister fails in AO from 3 ft drop or ST rollover
AO_SHIELDING	Shielding Fails	1.00E-05	AO shielding failure from 2.5 mph collision or impact
CASK-SHIELD-LEAD	Cask Shielding Fails with Lead	1.00E-08	TC shielding with lead fails with collision or impact
CASK-SHIELD-LEAD-2B	Cask Shielding Fails with Lead	1.00E-05	TC shielding with lead fails with 2-block drop
CASK-SHIELD-LEAD-DP	Cask Shielding Fails with Lead	1.00E-05	TC shielding with lead fails with drop
CASK-SHIELD-NOLEAD	Cask Shielding Fails without Lead	0.00E+00	TC shielding without lead fails with collision or impact
CASK-SHIELD-NOLEAD-2B	Cask Shielding Fails without Lead	0.00E+00	TC shielding without lead fails with 2-block drop
CASK-SHIELD-NOLEAD-DP	Cask Shielding Fails without Lead	0.00E+00	TC shielding without lead fails with drop
CTM_SHIELDING	Shielding Failure	0.00E+00	CTM shielding failure all events
SHIELD_DOOR_FAILURE	Shield Door Falls on Conveyance	0.00E+00	Shield door fails due to impact into conveyance
060-DPC-AO-FAIL-CUR-DIE	DPC Canister in AO Fails with Diesel in CUR	1.00E-06	Canister in AO fails in diesel fire in Cask Unloading Room – thin walled canister
060-DPC-AO-FAIL-DIES	DPC Canister in AO Fails with Diesel	1.00E-06	Canister in AO fails in diesel large fire – thin walled canister
060-DPC-AO-FAIL-PREP-DIE	DPC Canister in AO Fails with Diesel in Cask Preparation Room	1.00E-06	Canister in AO fails in diesel fire in Cask Preparation Room – thin walled canister
060-DPC-CTM-CAN-FAIL	DPC Canister fails in CTM Fire	1.00E-04	Canister in CTM fails in fire – thin walled canister
060-DPC-TC-FAIL-CUR-NDIE	DPC Canister in TC Fails without Diesel CUR	2.00E-06	Canister in TC fails in non-diesel fire in Cask Unloading Room – thin walled canister
060-DPC-TC-FAIL-DIES	DPC Canister Fails in TC with Diesel	2.00E-06	Canister in TC fails in diesel large fire – thin walled canister

Table 6.3-8. Passive Failure Basic Events used in CRCF Event Sequence Analysis (Continued)

Basic Event (BE) ID	Basic Event Description	BE Value	Condition
060-DPC-TC-FAIL-NODIES	DPC Canister in TC Fails Without Diesel	2.00E-06	Canister in TC fails in non-diesel large fire – thin walled canister
060-DPC-TC-FAIL-PREP-DIE	DPC Canister Fails with Diesel in Cask Preparation Room	2.00E-06	Canister in TC fails in diesel fire in Cask Preparation Room – thin walled canister
060-DPC-TC-FAIL-PREP-NOD	DPC Canister in TC Fails without Diesel in Cask Preparation Room	2.00E-06	Canister in TC fails in non-diesel fire in Cask Preparation Room – thin walled canister
060-DSNF-CTM-CAN-FAIL	DOE SNF Canister Failure in CTM	1.00E-04	Canister in CTM fails in fire – thin walled canister
060-DSNF-CUR-CAN-FAIL	DOE SNF Canister Failure in Cask Unloading Room	2.00E-06	Canister in TC fails in non-diesel fire in Cask Unloading Room – thin walled canister
060-DSTD-FAIL-CTM	Failure of DOE Std. canister in CTM Fire	1.00E-04	Canister in CTM fails in fire – thin walled canister
060-DSTD-FAIL-TC-DIESEL	Failure of DOE Std. canister in TC with Diesel Fire	2.00E-06	Canister in TC fails in diesel large fire – thin walled canister
060-DSTD-FAIL-TC-NODIES	Failure of DOE Std. canister without Diesel Fire	2.00E-06	Canister in TC fails in non-diesel large fire – thin walled canister
060-DSTD-FAILURE-SA	DOE Std. canister can Failure in a in Staging Area	2.00E-06	DOE SNF Canister failure in staging area in large fire – thin walled canister
060-H&D-WP-CAN-FAIL-LOR	H&D Canisters Fail in WP Loadout Room	3.00E-04	Canister in WP fails in fire in WP Loadout Room – thin walled canister
060-H&D-WP-CAN-FAIL-PR	H&D Canisters in WP Fail in WP Positioning Room	2.00E-06	Canister in WPTT fails in fire in WP Positioning Room – thin walled canister
060-H&M-WP-CAN-FAIL-LOR	H&M Canisters Fail in WP Loadout Room	3.00E-04	Canister in WP fails in fire in WP Loadout Room – thin walled canister
060-H&M-WP-CAN-FAIL-PR	H&M Canisters in WP Fail in WP Positioning Room	2.00E-06	Canister in WPTT fails in fire in WP Positioning Room – thin walled canister
060-HLW-CASK-FAIL	HLW Canister in cask Fails in Cask Unloading Room	2.00E-06	Canister in TC fails in non-diesel fire in Cask Unloading Room – thin walled canister
060-HLW-CTM-FAIL	Probability HLW Canister in CTM Fails	1.0E-04	Probability HLW Canister in CTM Fails in a large fire
060-HLW-CTM-CAN-FAIL	HLW Canister Fails in CTM	1.00E-04	Canister in CTM fails in fire – thin walled canister
060-HLW-WP-FAIL	Probability HLW Canister in WP Fails	3.00E-04	Canister in WP fails in fire – thin walled canister
060-MCO-CTM-CAN-FAIL	MCO Failure in CTM	1.00E-04	Canister in CTM fails in fire – thin walled canister
060-MCO-CUR-CAN-FAIL	MCO Failure in Cask Unloading Room	1.0E-01	Canister in TC fails in non-diesel fire in Cask Unloading Room – thin walled canister

Table 6.3-8. Passive Failure Basic Events used in CRCF Event Sequence Analysis (Continued)

Basic Event (BE) ID	Basic Event Description	BE Value	Condition
060-H&D-WP-CAN-FAIL-LGF	H&D Canisters in WP Fail in Large Fire	2.00E-06	Canister in WPTT fails in large fire– thin walled canister
060-H&M-WP-CAN-FAIL-LGF	H&M Canisters in WP Fail in Large Fire	2.00E-06	Canister in WPTT fails in large fire– thin walled canister
060-HLW-CAN-FAIL-WD	Probability HLW Canister in TC Fails with Diesel	2.00E-06	Canister in TC fails in diesel large fire – thin walled canister
060-HLW-CAN-FAIL-WOD	Probability HLW Canister in TC Fails without Diesel	2.00E-06	Canister in TC fails in non-diesel large fire – thin walled canister
060-HLW-IN-WP-FAIL-IN-PR	HLW in WP Fails in Positioning Room Fire	2.00E-06	Canister in WPTT fails in fire in WP Positioning Room – thin walled canister
060-MCO-FAIL-CTM	Failure of MCO in CTM Fire	1.00E-04	Canister in CTM fails in large fire – thin walled canister
060-MCO-FAIL-TC-DIESEL	Failure of MCO in TC with Diesel Fire	2.00E-06	Canister in TC fails in diesel large fire – thin walled canister
060-MCO-FAIL-TC-NODIES	Failure of MCO without Diesel Fire	2.00E-06	Canister in TC fails in non-diesel large fire – thin walled canister
060-TAD-AO-CAN-FAIL	TAD canister in AO Fails	1.00E-06	Canister in AO fails in fire in Cask Unloading Room – thin walled canister
060-TAD-CAN-AO-FAIL-DIES	TAD canister in AO Fails with Diesel	1.00E-06	Canister in AO fails in fire in Cask Preparation Room – thin walled canister
060-SPMRC-TAD-CAN-DIES	Failure of Canister with Diesel	2.00E-06	Canister in TC fails in diesel in Cask Preparation Room fire – thin walled canister
060-SPMRC-TAD-CAN-WOD	Failure of Canister without Diesel	2.00E-06	Canister in TC fails in non-diesel Cask Preparation Room fire – thin walled canister
060-TAD-CTM-CAN-FAIL	TAD canister in CTM Fails	1.00E-04	Canister in CTM fails in fire – thin walled canister
060-TAD-TC-CAN-FAIL	TAD canister in TC Fails	2.00E-06	Canister in TC fails in fire in Cask Unloading Room – thin walled canister
060-TAD-AO-FAIL-DIESEL	TAD canister in AO Fails in Diesel Fire	1.00E-06	Canister in AO fails in fire in Cask Unloading Room – thick walled canister
060-TAD-CTM-FAIL	TAD canister in CTM Fails in Fire	1.00E-04	Canister in CTM fails in large fire - thin walled canister
060-TAD-TC-FAIL-DIESEL	TAD canister in TC Fails in Diesel Fire	2.00E-06	Canister in TC fails in diesel in large fire – thin walled canister
060-TAD-TC-FAIL-WODIESEL	TAD canister in TC Fails in Non-Diesel Fire	2.00E-06	Canister in TC fails in non-diesel large fire – thin walled canister
060-TAD-WP-CAN-FAIL-LOR	Tad Canister in WPTT Fails in WP Loadout Room	2.00E-06	Canister in WPTT fails in WP Loadout Room fire - thin walled canister
060-TAD-WP-CAN-FAIL-PR	TAD canister in WPTT Fails in Positioning Closure Room	2.00E-06	Canister in WPTT fails in WP Positioning Room fire - thin walled canister

Table 6.3-8. Passive Failure Basic Events used in CRCF Event Sequence Analysis (Continued)

Basic Event (BE) ID	Basic Event Description	BE Value	Condition
060-TAD-WP-FAIL	TAD canister in WP Fails in Fire	3.00E-04	Canister in WP fails in large fire - thin walled canister
060-TAD-WPTT-FAIL	TAD canister in WPTT Fails in Fire	2.00E-06	Canister in WPTT fails in large fire - thin walled canister
060-STAGING-AREA-SHIELD	Failure of shielding in Staging Area	0.00E+00	Failure of DOE SNF in the staging area in a large fire
AO-FIRE-SHIELDING	Probability of Shielding Degradation in a Fire	0.00E+00	AO shielding degradation in a fire
CTM-FIRE-SHIELDING	CTM Shielding Degradation in a Fire	0.00E+00	CTM shielding degradation in a fire
SHIELD-FIRE-TC	TC Shielding Fails	1.00E+00	TC shielding fails in a fire
WP-FIRE-SHIELDING	Probability of Shielding Degradation in a Fire	0.00E+00	WP shielding degradation in a fire

NOTE: Refer to Attachment D for discussion on the development of the BE Values.

AO = aging overpack; CPA = cask preparation area; CTM = canister transfer machine; CTT = cask transfer trolley; CUR = Cask Unloading Room; DOE = U.S. Department of Energy; HLW = high-level radioactive waste; LG = large; LOR = WP Loadout Room; LR = loading room; NVL = naval; TC = transportation cask; PR = WP Positioning Room; SNF = spent nuclear fuel; Std. = standardized; TAD = transportation, aging, and disposal; WP = waste package; WPTT = waste package transfer trolley.

Source: Original

6.3.3 Miscellaneous Data

Split fractions for specific fire scenarios are derived from the exposure frequencies detailed in Section 6.5 and Attachment F. Table 6.3-9 identifies the frequency associated with a waste type in a specific configuration and location with or without diesel fuel present.

Table 6.3-10 provides details on how specific residence time fractions were developed for the CRCF fire event sequence analysis. The formulas use the index notation in Table 6.3-9. For example, index C1 represents the fraction of time that a HLW waste package is present in the WP Positioning/Closure Room over the entire preclosure period. Index E1 represents the fraction of time that a TAD canister waste package is present in the Waste Package Loadout Room over the preclosure period.

Data that is not defined as Active Component Reliability Data (Section 6.3.1) or Passive Equipment Failure Data (Section 6.3.2), but are used in the reliability analysis for this facility are listed in the following Table 6.3-11.

Table 6.3-9. Fire Analysis for Wastes Types in Specific Configuration

Location		DPC	DOE SNF	HLW	MCO	TAD canister	H&D	H&M	Container Type or Location
	Index	A	B	C	D	E	F	G	
WP Positioning/Closure Room (WPTT)	1			8.50E-06		6.50E-05	6.60E-05	6.60E-05	WPTT
WP in TEV in WP Loadout Room	2					1.90E-07	1.90E-07	1.90E-07	WPTT
WPTT in WP Loadout Room	3					7.30E-07	7.30E-07	7.30E-07	WPTT
On CTT in Cask Unloading Room	4	6.40E-08	7.50E-07	4.70E-07	7.50E-07	1.20E-07			TC
Cask Unloading Room (diesel Present)	5	1.20E-07				1.30E-07			AO
Vestibule/Cask Preparation Room w/SPM (diesel Present)	6	4.90E-07	4.90E-07	4.90E-07	4.90E-07	4.70E-07			TC
Cask Preparation Room w/o SPM (No diesel Present)	7	1.90E-06	2.20E-06	2.60E-06	2.20E-06	2.20E-06			TC
Vestibule/Cask Preparation Room (diesel Present)	8	4.20E-06				2.90E-06			AO
On CTT in Cask Preparation Room	9	2.50E-06	2.50E-06	2.30E-06	2.50E-06	2.60E-06			TC
In CTM in Canister Transfer Room	10	1.20E-07	1.10E-07	1.30E-07	1.10E-07	1.10E-07			CTM
Large Fire Threatens TC/TAD canister (diesel Present)	11					1.20E-06			TC
Large Fire Threatens TC/TAD canister (No diesel)	12					1.90E-05			TC
Large Fire Threatens TAD canister in AO (diesel Present)	13					6.50E-06			AO
Large Fire Threatens TAD canister in CTM	14					8.60E-07			CTM

Table 6.3-9. Fire Analysis for Wastes Types in Specific Configuration (Continued)

Location		DPC	DOE SNF	HLW	MCO	TAD canister	H&D	H&M	Container Type or Location
	Index	A	B	C	D	E	F	G	
Large Fire Threatens TAD canister in WP	15					5.90E-05			WPTT
Large Fire Threatens TAD canister in WP in TEV	16					1.00E-06			WP
Large Fire Threatens TC/HLW (diesel Present)	17			1.20E-06					TC
Large Fire Threatens TC/HLW (No diesel)	18			2.00E-05					TC
Large Fire Threatens HLW in CTM (per individual canister)	19			8.60E-07					CTM
Large Fire Threatens HLW in WP	20			7.30E-06					WP
Large Fire Threatens HLW and DOE-SNF in WP	21						6.10E-05		WP
Large Fire Threatens TC/DOE-SNF (diesel Present)	22		1.20E-06						TC
Large Fire Threatens TC/DOE-SNF (No diesel)	23		1.80E-05						TC
Large Fire Threatens DOE-SNF in CTM (per canister)	24		6.40E-07						CTM
Large Fire Threatens DOE-SNF in Staging Area	25		1.76E-04 ¹						Staging Area
Large Fire Threatens HLW and MCO in WP	26							6.10E-05	WP
Large Fire Threatens TC/DOE-MCO (diesel Present)	27				1.20E-06				TC
Large Fire Threatens TC/DOE-MCO (No diesel)	28				1.80E-05				TC
Large Fire Threatens DOE-MCO in CTM (per canister)	29				6.40E-07				CTM
Large Fire Threatens TC/DPC (Vertical) (No diesel)	30	1.70E-05							TC

Table 6.3-9. Fire Analysis for Wastes Types in Specific Configuration (Continued)

Location		DPC	DOE SNF	HLW	MCO	TAD canister	H&D	H&M	Container Type or Location
	Index	A	B	C	D	E	F	G	
Large Fire Threatens TC/DPC (Horizontal) (diesel Present)	31	1.20E-06							TC
Large Fire Threatens AO/DPC (Vertical) (diesel)	32	8.50E-06							AO
Large Fire Threatens DPC (VTC) in CTM	33	7.10E-07							CTM

NOTE: ¹Since no time restriction exists for staging, frequency of 5.8E-1 from Attachment F was divided by the number of DOE Standardized canisters handled in the CRCF (i.e., 3300 canisters).

Source: Table 6.5-4

Table 6.3-10. Split Fractions for Waste Types in Various Configurations

Reference Index for Table 6.3-10	Waste Type and Configuration	Basic Event Identifier	Formula for Split Fraction	Value
	DPC			
DPC-1	Cask Unloading Room (TC or AO)	060-DPC-CASK-UNLOAD-FIRE	SUM(A4:A5)	1.84E-07
DPC-2	Fraction in AO with diesel	060-PROB-DIESEL-AO-CUR	A5/SUM(A4:A5)	6.52E-01
DPC-3	Fraction in TC without diesel	060-PROB-NODIESEL-TC-CUR	A4/SUM(A4:A5)	3.48E-01
DPC-4	Cask Preparation Room	060-DPC-CASK-PREP-FIRE	SUM(A6:A9)	9.09E-06
DPC-5	Fraction in TC with diesel	060-PROB-DIESEL--TC-PREP	A6/SUM(A6:A9)	5.39E-02
DPC-6	Fraction in TC without diesel	060-PROB-NODIESE-TC-PREP	(A7+A9)/SUM(A6:A9)	4.84E-01
DPC-7	Fraction in AO with diesel	060-PROB-DIESEL-AO-PREP	A8/SUM(A6:A9)	4.62E-01
DPC-8	In CTM	060-DPC-CTM-FIRE	A10	1.20E-07
DPC-9	Large Fire (TC)	060-DPC-LARGE-FIRE	SUM(A30:A32)	2.67E-05
DPC-10	Fraction in TC with diesel	060-PROB-DPC-TC-DIESEL	A31/SUM(A30:A32)	4.38E-02
DPC-11	Fraction in TC without diesel	060-PROB-DPC-TC-NODIES	A30/SUM(A30:A32)	6.20E-01
DPC-12	Fraction in AO with diesel	060-PROB-DPC-AO-DIESEL	A32/SUM(A30:A32)	3.10E-01
DPC-13	Fraction in CTM	060-PROB-DPC-IN-CTM	A32/SUM(A30:A33)	2.59E-02
	DOE SNF/DOE STD			
DSNF-1	Cask Unloading Room (TC)	060-DNSF-CASK-CUR-FIRE	B4	7.50E-07
DSNF-2	Cask Preparation Room (TC)	060-DSNF-CSK-CPA-FIRE	SUM(B6:B9)	5.19E-06
DSNF-3	Fraction in TC with diesel	060-SPMRC-DNSF-DIESEL	B6/SUM(B6:B9)	9.44E-02
DSNF-4	Fraction in TC without diesel	060-SPMRC-DNSF-WODIESEL	(B7+B9)/SUM(B6:B9)	9.06E-01
DSNF-5	In CTM	060-DNSF-CAN-CTM-FIRE	B10	1.10E-07
DSNF-6	Large Fire (TC)	060-DNSF-LARGE-FIRE	SUM(B22:B25)	1.96E-04
DSNF-7	Fraction in TC with diesel	060-PROB-DSTD-TC-DIES	B22/SUM(B22:B25)	6.14E-03
DSNF-8	Fraction in TC without diesel	060-PROB-DSTD-TC-NODIES	B23/SUM(B22:B25)	9.20E-02
DSNF-9	Fraction in CTM	060-PROB-DSTD-IN-CTM	B24/SUM(B22:B25)	3.27E-03
DSNF-10	Fraction in Staging Area	060-PROB-DSTD-STAGING	B25/SUM(B22:B25)	8.99E-01
	MCO			
MCO-1	Cask Unloading Room (TC)	060-MCO-CASK-CUR-FIRE	D4	7.50E-07

Table 6.3-10. Split Fractions for Waste Types in Various Configurations (Continued)

Reference Index for Table 6.3-10	Waste Type and Configuration	Basic Event Identifier	Formula for Split Fraction	Value
MCO-2	Cask Preparation Room (TC)	060-MCO-CSK-CPA-FIRE	SUM(D6:D9)	5.19E-06
MCO-3	Fraction in TC with diesel	060-SPMRC-MCO-DIESEL	D6/SUM(D6:D9)	9.44E-02
MCO-4	Fraction in TC without diesel	060-SPMRC-MCO-WODIESEL	(D7+D9)/SUM(D6:D9)	9.06E-01
MCO-5	In CTM	060-MCO-CAN-CTM-FIRE	D10	1.10E-07
MCO-6	Large Fire	060-MCO-LARGE-FIRE	SUM(D27:D29)	1.98E-05
MCO-7	Fraction in TC with diesel	060-PROB-MCO-TC-DIES	D27/SUM(D27:D29)	6.05E-02
MCO-8	Fraction in TC without diesel	060-PROB-MCO-TC-NODIES	D28/SUM(D27:D29)	9.07E-01
MCO-9	Fraction in CTM	060-PROB-MCO-IN-CTM	D289/SUM(D27:D29)	3.23E-02
	HLW			
HLW-1	Cask Unloading Room (TC)	060-HLW-CSK-UNLOAD-RM	C4	4.70E-07
HLW-2	Cask Preparation Room (TC)	060-HLW-FIRE-PREPAREA	SUM(C6:C9)	5.39E-06
HLW-3	Fraction in TC with diesel	060-SPMRC-HLW-DIESEL	C6/SUM(C6:C9)	9.09E-02
HLW-4	Fraction in TC without diesel	060-SPMRC-HLW-WODIESEL	(C7+C9)/SUM(C6:C9)	9.09E-01
HLW-5	In CTM	060-HLW-CAN-CTM-FIRE	C10	1.30E-07
HLW-6	In WP Positioning Room (WP)	060-FIRE-IN-POSITION-RM	C1	8.50E-06
HLW-7	Large Fire	060-HLW-LARGE-FIRE	SUM(C17:C20)	2.94E-05
HLW-8	Fraction in TC with diesel	060-HLW-TC-DIESEL	C17/SUM(C17:C20)	4.09E-02
HLW-9	Fraction in TC without diesel	060-HLW-TC-WO-DIESEL	C18/SUM(C17:C20)	6.81E-01
HLW-10	Fraction in CTM	060-HLW-CTM	C19/SUM(C17:C20)	2.93E-02
HLW-11	Fraction in WP	060-HLW-WP	C20/SUM(C17:C20)	2.49E-01
	TAD			
TAD-1	Cask Unloading Room (TC or AO)	060-TADAO-CUR-DIESEL	SUM(E4:E5)	2.50E-07
TAD-2	Fraction in AO with diesel	060-PROB-TAD-AO-CURDIES	E5/SUM(E4:E5)	5.20E-01
TAD-3	Fraction in TC without diesel	060-PROB-TAD-TC-CURND	E4/SUM(E4:E5)	4.80E-01
TAD-4	Cask Preparation Room	060-TAD-FIRE-PREP-AREA	SUM(E6:E9)	8.17E-06
TAD-5	Fraction in TC with diesel	060-SPMRC-TAD-DIESEL	E6/SUM(E6:E9)	5.75E-02
TAD-6	Fraction in TC without diesel	060-SPMRC-TAD-WODIES	(E7+E9)/SUM(E6:E9)	5.88E-01

Table 6.3-10. Split Fractions for Waste Types in Various Configurations (Continued)

Reference Index for Table 6.3-10	Waste Type and Configuration	Basic Event Identifier	Formula for Split Fraction	Value
TAD-7	Fraction in AO with diesel	060-TAD-AO-DIESEL	E8/SUM(E6:E9)	3.55E-01
TAD-8	Loadout Room (WP)	060-TAD-WP-LOADOUT-RM	E2+E3	9.20E-07
TAD-9	In Positioning Room (WP)	060-TAD-WP-POSIT-RM-FIRE	E1	6.50E-05
TAD-10	In CTM	060-TAD-CAN-CTM-FIRE	E10	1.10E-07
TAD-11	Large Fire	060-TAD-LARGE-FIRE	SUM(E11:E16)	8.76E-05
TAD-12	Fraction in TC with diesel	060-PROB-TAD-TC-DIESEL	E11/SUM(E11:E16)	1.37E-02
TAD-13	Fraction in TC without diesel	060-PROB-TAD-TC-WODIESEL	E12/SUM(E11:E16)	2.17E-01
TAD-14	Fraction in AO with diesel	060-PROB-TAD-AO-DIES	E13/SUM(E11:E16)	7.42E-02
TAD-15	Fraction in CTM	060-PROB-TAD-CTM	E14/SUM(E11:E16)	9.82E-03
TAD-16	Fraction in WP	060-PROB-TAD-WP	E16/SUM(E11:E16)	1.14E-02
TAD-17	Fraction in WPTT	060-PROB-TAD-WPTT	E15/SUM(E11:E16)	6.74E-01
	H&D (WP)			
H&D-1	In WP Positioning Room (WP)	060-H&D-WP-POSIT-RM-FIRE	F1	6.60E-05
H&D-2	WP Loadout Room (WP)	060-H&D-WP-LDOUT-RM	F2+F3	9.20E-07
H&D-3	Large Fire	060-H&D-LARGE-FIRE	F21	6.10E-05
	H&M (WP)			
H&M-1	In WP Positioning Room	060-H&M-WP-POSIT-RM-FIRE	G1	6.60E-05
H&M-2	WP Loadout Room (WP)	060-H&M-WP-LDOUT-RM	G2+G3	9.20E-07
H&M-3	Large Fire	060-H&M-LARGE-FIRE	G26	6.10E-05

NOTE: AO = aging overpack; CTM = canister transfer machine; TC = transportation cask; WP = waste package; WPTT = waste package transfer trolley;

Source: Original

Table 6.3-11. Miscellaneous Data Used In the Reliability Analysis

Basic Event (BE) ID	Basic Event Description	BE Value	Bases	References
060-#EEE-LDCNTRA-BUA-MTN	ITS Load Center Train A OOS for Maintenance	1.03E-04	Load center A is out of service for maintenance with a frequency of 6.10E-07/hour. Out of service time is limited to one week, or 168 hours	Attachment B, Section B8
060-#EEE-LDCNTRA-BUA-ROE	Failure to Restore ITS Load Center Train A post maintenance	1.03E-05	Failure to restore load center after maintenance is taken as 10% of the probability of maintenance.	Attachment B, Section B8
060-#EEE-LDCNTRB-BUA-MTN	ITS Load Center Train B OOS for Maintenance	1.03E-04	Load center A is out of service for maintenance with a frequency of 6.10E-07/hour. Out of service time is limited to one week, or 168 hours	Attachment B, Section B8
060-#EEE-LDCNTRB-BUA-ROE	ITS Failure to Restore Load Center Train B post maintenance	1.03E-05	Failure to restore load center after maintenance is taken as 10% of the probability of maintenance.	Attachment B, Section B8
060-PWR-LOSS	Loss of Site Power	4.10E-06	Frequency of off site power loss (per hour)	Ref. 2.2.46, Ref. 2.2.33, and Attachment B, Section B8
060-PWR-LOSS-2	Loss of Power	4.10E-06	Frequency of off site power loss (per hour)	Ref. 2.2.46, Ref. 2.2.33 and Attachment B, Section B8
LOSP	Loss of offsite power	2.99E-03	Frequency of off site power loss (per hour) Multiplied by 720 hours (30 days) for diesels in HVAC system	Ref. 2.2.46, Ref. 2.2.33, and Attachment B, Sections B7 and B8
LOSP-4	Failure of Off Site Power	4.10E-06	Frequency of off site power loss (per hour)	Ref. 2.2.46, Ref. 2.2.33, and Attachment B, Section B8
060-7-FRACTION-OF-AOS	Fraction of DPCs in AOs Traversing SD	6.70E-01	DPCs in AOs pass through 2 shield doors on STs and DPCs in TCs pass through 1 shield door on CTTs. This represents the fraction of the total DPCs in AOs that could impact a shield door. Established in facility plan and operating procedures.	Ref. 2.2.33

Table 6.3-11. Miscellaneous Data Used In the Reliability Analysis (Continued)

Basic Event (BE) ID	Basic Event Description	BE Value	Bases	References
060-7-FRACTION-OF-CASKS	Fraction of DPCs in Casks Traversing SD	3.30E-01	DPCs in AOs pass through 2 shield doors on STs and DPCs in TCs pass through 1 shield door on CTTs. This represents the fraction of the total DPCs in TCs that could impact a shield door. Established in facility plan and operating procedures.	Ref. 2.2.33
060-CR-CASK-UNLOADING	Canister is Exposed During Mid-Unloading	1.00E+00	Probability that the cask is exposed during unloading. A conservative value of 1.0 is applied.	N/A
060-CSKPREPLIFTNUMBER	Number of object Lifts for Cask Prep	1.00E+00	During preparation activities associated with a TC, there is one lift of a heavy object such as a lift fixture over the cask. Therefore, a value of 1 is assigned to this basic event.	N/A
060-CTMOBJLIFTNUMBER	Number of Object Lifts during MCO or DOE Std. canister transfers	2.00E+00	During transfer of DOE Std. canister, HLW, MCO or TAD from the TC to the WP, the CTM lifts a lid and the WP crane lifts a lid over the cask. Therefore, a value of 2 is assigned to this basic event.	N/A
060-CTMOBJLIFTNUMBERD	Number of Object Lifts during DPC Transfers	1.00E+00	During transfer of DPC from the AO to the WP, the DPC enters the unloading area without a lid on the AO and the WP crane lifts a lid over the cask. Therefore, a value of 1 is assigned to this basic event.	N/A
060-DNSF-CAN-CTM-FIRE	Localized fire threatens canister in the CTM	1.10E-07	Localized Fire Threatens DOE SNF in CTM in Canister Transfer Room (per individual canister)	Section 6.5, Table 6.5-4
060-DNSF-CASK-CUR-FIRE	Localized Fire Threatens TC/DOE SNF on CTT in Cask Unloading Room	7.50E-07	Localized Fire Threatens TC/DOE SNF on CTT in Cask Unloading Room	Section 6.5, Table 6.5-4
060-DNSF-LARGE-FIRE	Large fire threatens DNSF anywhere in CRCF	1.96E-04	Large Fire Threatens TC/DOE SNF (diesel Present), TC/DOE SNF (No diesel), in CTM (per canister), and in Staging Area	Section 6.5, Table 6.5-4

Table 6.3-11. Miscellaneous Data Used In the Reliability Analysis (Continued)

Basic Event (BE) ID	Basic Event Description	BE Value	Bases	References
060-DPC-CASK-PREP-FIRE	Fire in Cask Preparation Room	9.09E-06	Localized Fire Threatens TC/DPC (VTC) in Vestibule/Cask Preparation Room (diesel Present), TC/DPC (VTC) in Cask Preparation Room (No diesel Present), DPC (VTC) in AO in Vestibule/Cask Preparation Room (diesel Present), and TC/DPC (VTC) on CTT	Section 6.5, Table 6.5-4
060-DPC-CASK-UNLOAD-FIRE	Fire in the Cask Unloading Room	1.84E-07	Localized Fire Threatens TC/DPC (VTC) or AO (diesel Present) in Cask Unloading Room	Section 6.5, Table 6.5-4
060-DPC-CTM-FIRE	Fire in Transfer Room Affecting Can in CTM	1.20E-07	Localized Fire Threatens DPC in CTM in Canister Transfer Room	Section 6.5, Table 6.5-4
060-DPC-LARGE-FIRE	Large Fire in CRCF	2.67E-05	Large Fire Threatens TC/DPC (VTC) (diesel), TC/DPC (VTC) (No diesel), DPC (VTC) in CTM, and DPC (VTC) in AO (diesel)	Section 6.5, Table 6.5-4
060-DPCPREPLIFTNUMBER	Number of object Lifts for DPC Prep	3.00E+00	During preparation activities associated with a DPC, there are three lifts of heavy objects over the cask; a lid lift fixture, the lid and a canister lift fixture. Therefore, a value of 3 is assigned to this basic event.	N/A
060-DSNF-CSK-CPA-FIRE	Probability of Fire in Cask Preparation Room	5.19E-06	Localized Fire Threatens TC/DOE SNF in Vestibule/Cask Preparation Room w/SPM (diesel Present), TC/DOE SNF in Cask Preparation Room w/o SPM (No diesel Present), and TC/DOE SNF on CTT (No diesel Present).	Section 6.5, Table 6.5-4
060-EXCESSIVE-WIND-SPEED	Sustained Wind Exceeds 40 MPH & Gust to 90 MPH	4.70E-03	Sustained wind with speed exceeding 40 MPH and gust to 90 MPH has an estimated frequency of 5.7E-02 per yr, and with a mission time of 720 hours, the probability of such an occurrence is 4.7E-3.	Ref. 2.2.30
060-FIRE-IN-POSITION-RM	Fire in WP Positioning/Closure Room Threatens WP	8.50E-06	Localized Fire Threatens HLW in WP in WP Positioning/Closure Room	Section 6.5, Table 6.5-4

Table 6.3-11. Miscellaneous Data Used In the Reliability Analysis (Continued)

Basic Event (BE) ID	Basic Event Description	BE Value	Bases	References
060-FIRE-SUPPRESSION	Inadvertent Actuation of Fire Suppression System	1E-06	(Section 6.2.2.9)	Section 6.2.2.9
060-H&D-LARGE-FIRE	Large fire threatens H&D anywhere in CRCF	6.10E-05	Large Fire Threatens HLW and DOE SNF in WP	Section 6.5, Table 6.5-4
060-H&D-WP-LDOUT-RM	Localized fire threatens WP in the WP Loadout Room	9.20E-07	Localized Fire Threatens HLW and DOE SNF in WP in TEV in WP Loadout Room	Section 6.5, Table 6.5-4
060-H&D-WP-POSIT-RM-FIRE	Localized fire threatens H&D WP in WP Position Room	6.60E-05	Localized Fire Threatens HLW and DOE SNF in WP and TEV in WP Positioning/Closure Room	Section 6.5, Table 6.5-4
060-H&M-LARGE-FIRE	Large fire threatens H&M anywhere in CRCF	6.10E-05	Large Fire Threatens HLW and MCO in WP	Section 6.5, Table 6.5-4
060-H&M-WP-LDOUT-RM	Localized fire threatens WP in the WP Loadout Room	9.20E-07	Localized Fire Threatens HLW and MCO in WP in TEV in WP Loadout Room	Section 6.5, Table 6.5-4
060-H&M-WP-POSIT-RM-FIRE	Localized fire threatens H&M WP in WP Position Room	6.60E-05	Localized Fire Threatens HLW and MCO in WP and TEV in WP Positioning/Closure Room	Section 6.5, Table 6.5-4
060-HEPA-PLUG	HEPA Filters Plug in a Large Fire	1.00E+00	Burning embers and combustible byproducts generated by a large fire have the potential to plug filters. To ensure a conservative analysis, this value is set to a value of 1.0.	N/A
060-HLW-CAN-CTM-FIRE	Localized fire threatens HLW canister in CTM	1.30E-07	Localized Fire Threatens HLW in CTM in Canister Transfer Room (per individual canister)	Section 6.5, Table 6.5-4
060-HLW-CSK-UNLOAD-RM	Localized Fire threatens TC in Cask Unloading Room	4.70E-07	Localized Fire Threatens TC/HLW on CTT in Cask Unloading Room	Section 6.5, Table 6.5-4
060-HLW-CTM	Probability HLW in CTM	2.93E-02	Based on the fire frequency analysis, this value represents the fraction of time that a HLW canister is in the CTM in a large fire.	Section 6.5, Table 6.5-4
060-HLW-FIRE-PREPAREA	Fire involving HLW in Cask Preparation Room	5.39E-06	Localized Fire Threatens TC/HLW in Vestibule/Cask Preparation Room w/SPM (diesel Present), w/o SPM (No diesel Present), and TC/HLW on CTT (No diesel Present).	Section 6.5, Table 6.5-4

Table 6.3-11. Miscellaneous Data Used In the Reliability Analysis (Continued)

Basic Event (BE) ID	Basic Event Description	BE Value	Bases	References
060-HLW-LARGE-FIRE	Large fire threatens HLW anywhere in CRCF	2.94E-05	Large Fire Threatens TC/HLW (diesel Present), TC/HLW (No diesel), HLW in CTM (per Individual canister), and HLW in WP	Section 6.5, Table 6.5-4
060-HLW-MODERATOR	Moderator Infiltrates HLW Canister	0.00E+00	A moderator source has no impact on HLW criticality . Probability set to 0.00	N/A
060-HLW-TC-DIESEL	Probability HLW in TC with diesel Present	4.09E-02	Based on the fire frequency analysis, this value represents the fraction of time that a HLW canister is in the TC when diesel fuel is present in a large fire.	Section 6.5, Table 6.5-4
060-HLW-TC-WO-DIESEL	Probability HLW in TC Without diesel Present	6.81E-01	Based on the fire frequency analysis, this value represents the fraction of time that a HLW canister is in the TC when diesel fuel is not present in a large fire..	Section 6.5, Table 6.5-4
060-HLW-WP	Probability HLW in WP	2.49E-01	Based on the fire frequency analysis, this value represents the fraction of time that a HLW canister is in the WP in a large fire.	Section 6.5, Table 6.5-4
060-LIFTS-PER-DPC-CAN	Number of CTM lifts per DPC Canister	1.00E+00	DPC is lifted out of a TC by the CTM and placed into an AO for transfer to aging pad. This occurs in one single lift, and thus, a value of 1 is assigned to this basic event.	N/A
060-LIFTS-PER-DSNF-CAN	Number of Lifts per DOE SNF Canister	2.00E+00	DOE SNF is lifted out of a TC by the CTM and placed into a staging area. Subsequently, it is lifted by the CTM from the staging area and placed into a WP. This occurs in 2 lifts, and thus, a value of 2 is assigned to this basic event.	N/A
060-LIFTS-PER-HLW-CAN	Number of Lifts per HLW Canister	1.20E+00	HLW is lifted out of a TC by the CTM; 80% is placed directly into a WP whereas 20% is placed into a staging area and subsequently lifted by the CTM from the staging area and placed into a WP. A value of 1.2 is assigned to this basic event.	Ref. 2.2.31

Table 6.3-11. Miscellaneous Data Used In the Reliability Analysis (Continued)

Basic Event (BE) ID	Basic Event Description	BE Value	Bases	References
060-LIFTS-PER-MCO-CAN	Number of Lifts per MCO Canister	1.00E+00	MCO is lifted out of a TC by the CTM and placed into a WP. This occurs in one single lift, and thus, a value of 1 is assigned to this basic event.	N/A
060-LIFTS-PER-TAD-CAN	Number of Lifts per TAD canister	1.00E+00	TAD canister is lifted out of a TC by the CTM and placed into a WP. This occurs in one single lift, and thus, a value of 1 is assigned to this basic event.	N/A
060-MCO-CAN-CTM-FIRE	Localized fire threatens canister in the CTM	1.10E-07	Localized fire threatens MCO in CTM	Table 6.3-10 (MCO-5)
060-MCO-CASK-CUR-FIRE	Localized fire threatens TC Cask Unload Area	7.50E-07	Localized fire threatens TC/MCO in Cask Unloading Room	Table 6.3-10 (MCO-1)
060-MCO-CSK-CPA-FIRE	Probability of Fire in Cask Preparation Room	5.19E-06	Localized fire threatens TC/MCO in Cask Preparation Room	Table 6.3-10 (MCO-2)
060-MCO-LARGE-FIRE	Large fire threatens MCO anywhere in CRCF	1.98E-05	Large Fire Threatens TC/MCO (diesel Present), TC/MCO (No diesel), in CTM (per canister)	Table 6.3-10 (MCO-6)
060-MODERATOR-IN-FIRE	Water Moderator Enters Cask	1.00E-03	In the fire scenario, although the fire frequency was estimated without fire suppression, a sufficient amount of water moderator intrusion into a DPC, HLW or TAD canister to create conditions favorable for a criticality event is conservatively assigned with a value of 1E-3 to denote the potential of fire suppression with water. This will put an upper bound value to the event sequences that include water moderator event.	Section 6.2.2.9
060-MODERATOR-IN-FIREDOE	Water Moderator Enters Cask	1.00E-03	In the fire scenario, although the fire frequency was estimated without fire suppression, water moderator intrusion into a DOE Std. canister or MCO is conservatively assigned with a value of 1E-3 to denote the potential of fire suppression with water. This will put an upper bound value to the event sequences that include water moderator event.	Section 6.2.2.9

Table 6.3-11. Miscellaneous Data Used In the Reliability Analysis (Continued)

Basic Event (BE) ID	Basic Event Description	BE Value	Bases	References
060-OIL-MODERATOR	Gear Box Leaks	9.00E-05	This value is based on standard industrial data.	Attachment C, Table C4-1.
060-OTHER-WATER	Water Moderator Sources Other Than Fire Suppression	2.00E-05	Water moderator sources other than inadvertent actuation of the fire suppression system is estimated at 2E-5 for this facility	Section 6.2.2.9
060-PERCENT-DPC--ON-RC	Percentage of Casks with DPCs Received by Rail	1.00E+00	DPCs can be received by rail or by truck. Due to the DPC size, the most likely method of transportation for the DPCs is by rail. Thus, it is conservatively considered that all DPCs received by the facility from outside of the GROA are by rail, or a probability of 1. Conversely, the probability of receiving DPCs by truck is 0.	N/A
060-PERCENT-DPC-ON-TT	Percentage of Casks with DPCs Received by Truck	0.00E+00	See above – 060-FRACTION-DPC- -ON-RC	N/A
060-PERCENT-DSNF-ON-RC	Percentage of Casks with DOE Std. Can. Received by Rail	1.00E+00	Similar discussion. See above – 060-FRACTION-DPC- -ON-RC	N/A
060-PERCENT-DSNF-ON-TT	Percentage of Casks with DOE Std. Can. Received by Truck	0.00E+00	Similar discussion. See above – 060-FRACTION-DPC- -ON-RC	N/A
060-PERCENT-HLW-ON-RC	Percentage of Casks with HLW Received by Rail	1.00E+00	HLW canisters can be transported either by rail or by truck. Since there is no information on the anticipated method of delivery, a 50/50 chance between the two means of transport is selected	N/A
060-PERCENT-HLW-ON-TT	Percentage of HLW on TT	0.00E+00	See above - 060-FRACTION-HLW-ON-RC	N/A
060-PERCENT-MCO-ON-RC	Percentage of Casks with MCO Received by Rail	1.00E+00	Similar discussion. See above – 060-FRACTION-DPC- -ON-RC	N/A
060-PERCENT-MCO-ON-TT	Percentage of Casks with MCO Received by Truck	0.00E+00	Similar discussion. See above – 060-FRACTION-DPC- -ON-RC	N/A
060-PERCENT-TAD-ON-RC	Percentage TAD canister on RC	1.00E+00	Similar discussion. See above – 060-FRACTION-DPC- -ON-RC	N/A
060-PERCENT-TAD-ON-TT	Percentage TAD canister on TT	0.00E+00	Similar discussion. See above – 060-FRACTION-DPC- -ON-RC	N/A

Table 6.3-11. Miscellaneous Data Used In the Reliability Analysis (Continued)

Basic Event (BE) ID	Basic Event Description	BE Value	Bases	References
060-PROB-AO	Probability of AO in Process	4.60E-01	Fraction of unloading operations with CTM involving AOs.	N/A
060-PROB-CTT-TAD	Probability of CTT with TAD canister in TC	4.61E-01	Fraction of time that TAD canister is in TC (vs. in an AO).	N/A
060-PROB-DIESEL-AO-CUR	Probability of DPC in AO & diesel in CUR	6.52E-01	Based on the fire frequency analysis, this value represents the fraction of time that a DPC is in the AO in the Cask Unloading Room while diesel fuel is present.	Section 6.5, Table 6.5-4
060-PROB-DIESEL-AO-PREP	Probability of DPC in AO & diesel in Cask Preparation Room	4.62E-01	Based on the fire frequency analysis, this value represents the fraction of time that a DPC is in the AO in the cask preparation room while diesel fuel is present.	Section 6.5, Table 6.5-4
060-PROB-DIESEL--TC-PREP	Probability of DPC in TC & diesel in Cask Preparation Room	5.39E-02	Based on the fire frequency analysis, this value represents the fraction of time that a DPC is in the TC in the cask preparation room while diesel fuel is present.	Section 6.5, Table 6.5-4
060-PROB-DPC-AO-DIESEL	Probability of DPC in AO with diesel	3.10E-01	Based on the fire frequency analysis, this value represents the fraction of time that a DPC is in the AO while diesel fuel is present in a large fire.	Section 6.5, Table 6.5-4
060-PROB-DPC-IN-AO-LF	Probability DPC in AO in Large Fire	3.10E-01	Based on the fire frequency analysis, this value represents the fraction of time that a DPC is in the AO in a large fire.	Section 6.5, Table 6.5-4
060-PROB-DPC-IN-CTM	Probability DPC in CTM in Large Fire	2.59E-02	Based on the fire frequency analysis, this value represents the fraction of time that a DPC is in the CTM in a large fire.	Section 6.5, Table 6.5-4
060-PROB-DPC-IN-TC-LF	Probability DPC in TC in Large Fire	6.64E-01	Based on the fire frequency analysis, this value represents the fraction of time that a DPC is in the TC in a large fire.	Section 6.5, Table 6.5-4
060-PROB-DPC-TC-DIESEL	Probability of DPC in TC with diesel	4.38E-02	Based on the fire frequency analysis, this value represents the fraction of time that a DPC is in the TC while diesel fuel is present in a large fire.	Section 6.5, Table 6.5-4

Table 6.3-11. Miscellaneous Data Used In the Reliability Analysis (Continued)

Basic Event (BE) ID	Basic Event Description	BE Value	Bases	References
060-PROB-DPC-TC-NODIES	Probability of DPC in TC without diesel	6.20E-01	Based on the fire frequency analysis, this value represents the fraction of time that a DPC is in the TC while diesel fuel is not present in a large fire.	Section 6.5, Table 6.5-4
060-PROB-DSTD-IN-CTM	Probability DOE Std. canister in CTM	3.27E-03	Based on the fire frequency analysis, this value represents the fraction of time that a DOE Std. canister is in the CTM in a large fire.	Section 6.5, Table 6.5-4
060-PROB-DSTD-IN-CTM-LF	Probability DOE Std. canister in CTM in Large Fire	3.27E-03	Based on the fire frequency analysis, this value represents the fraction of time that a DOE Std. canister is in the CTM in a large fire.	Section 6.5, Table 6.5-4
060-PROB-DSTD-IN-STG-LF	Probability DOE Std. canister in Staging Area in Large Fire	8.99E-01	Based on the fire frequency analysis, this value represents the fraction of time that a DOE Std. canister is in the staging area in a large fire.	Section 6.5, Table 6.5-4
060-PROB-DSTD-IN-TC-LF	Probability DOE Std. canister in TC in Large Fire	9.82E-02	Based on the fire frequency analysis, this value represents the fraction of time that a DOE Std. canister is in the TC in a large fire.	Section 6.5, Table 6.5-4
060-PROB-DSTD-STAGING	Probability DOE Std. canister in Staging Area	8.99E-01	Based on the fire frequency analysis, this value represents the fraction of time that a DOE Std. canister is in the staging area in a large fire.	Section 6.5, Table 6.5-4
060-PROB-DSTD-TC-DIES	Probability DOE Std. canister in TD with diesel Fire	6.14E-03	Based on the fire frequency analysis, this value represents the fraction of time that a DOE Std. canister is in a TC while diesel fuel is present in a large fire.	Section 6.5, Table 6.5-4
060-PROB-DSTD-TC-NODIES	Probability DOE Std. canister in TC without diesel Fire	9.20E-02	Based on the fire frequency analysis, this value represents the fraction of time that a DOE Std. canister is in a TC while diesel fuel is not present in a large fire.	Section 6.5, Table 6.5-4
060-PROB-HLW-IN-CTM-LF	Probability HLW in CTM in Large Fire	2.93E-02	Based on the fire frequency analysis, this value represents the fraction of time that a HLW canister is in the CTM in a large fire.	Section 6.5, Table 6.5-4

Table 6.3-11. Miscellaneous Data Used In the Reliability Analysis (Continued)

Basic Event (BE) ID	Basic Event Description	BE Value	Bases	References
060-PROB-HLW-IN-TC-LF	Probability HLW in TC in Large Fire	7.22E-01	Based on the fire frequency analysis, this value represents the fraction of time that a HLW canister is in the TC in a large fire.	Section 6.5, Table 6.5-4
060-PROB-HLW-IN-WP-LF	Probability HLW in WP in Large Fire	2.49E-01	Based on the fire frequency analysis, this value represents the fraction of time that a HLW canister is in the WP in a large fire.	Section 6.5, Table 6.5-4
060-PROB-MCO-IN-CTM	Probability MCO in CTM	3.23E-02	Based on the fire frequency analysis, this value represents the fraction of time that a MCO is in the CTM. Data for MCO is the same as for the DOE Std. canister.	Section 6.5, Table 6.5-4
060-PROB-MCO-IN-CTM-LF	Probability MCO in CTM in Large Fire	3.23E-02	Based on the fire frequency analysis, this value represents the fraction of time that a MCO is in the CTM in a large fire. . Data for MCO is the same as for the DOE Std. canister.	Section 6.5, Table 6.5-4
060-PROB-MCO-IN-TC-LF	Probability MCO in TC in Large Fire	9.68E-01	Based on the fire frequency analysis, this value represents the fraction of time that a MCO is in the TC in a large fire. . Data for MCO is the same as for the DOE Std. canister.	Section 6.5, Table 6.5-4
060-PROB-MCO-TC-DIES	Probability MCO in TD with diesel Fire	6.05E-02	Based on the fire frequency analysis, this value represents the fraction of time that a MCO is in the TC while diesel fuel is present in a large fire. Data for MCO is the same as for the DOE Std. canister.	Section 6.5, Table 6.5-4
060-PROB-MCO-TC-NODIES	Probability MCO in TC without diesel Fire	9.07E-01	Based on the fire frequency analysis, this value represents the fraction of time that a MCO is in the TC while diesel fuel is not present in a large fire. . Data for MCO is the same as for the DOE Std. canister.	Section 6.5, Table 6.5-4
060-PROB-NODIESEL-TC-CUR	Probability of DPC in TC without diesel in CUR	3.48E-01	Based on the fire frequency analysis, this value represents the fraction of time that a DPC is in the TC in the Cask Unloading Room while diesel fuel is not present.	Section 6.5, Table 6.5-4

Table 6.3-11. Miscellaneous Data Used In the Reliability Analysis (Continued)

Basic Event (BE) ID	Basic Event Description	BE Value	Bases	References
060-PROB-NODIESE-TC-PREP	Probability of DPC in TC & no diesel in Cask Preparation Room	4.84E-01	Based on the fire frequency analysis, this value represents the fraction of time that a DPC is in the TC in the Cask Preparation Room while diesel fuel is not present.	Section 6.5, Table 6.5-4
060-PROB-ST-TAD	Probability of ST with TAD canister in AO	5.39E-01	Fraction of time that TAD canister is in AO on an ST (vs. in a TC on a CTT).	N/A
060-PROB-TAD-AO-CUR	Probability TAD canister in AO in Cask Unloading Room	5.20E-01	Based on the fire frequency analysis, this value represents the fraction of time that a TAD canister in an AO in the Cask Unloading Room.	Section 6.5, Table 6.5-4
060-PROB-TAD-AO-CURDIES	Probability TAD canister in AO in Unloading Room with diesel Fire	5.20E-01	Based on the fire frequency analysis, this value represents the fraction of time that a TAD canister in an AO in the Cask Unloading Room while diesel fuel is present.	Section 6.5, Table 6.5-4
060-PROB-TAD-AO-DIES	Probability TAD canister in AO in Fire with diesel	7.42E-02	Based on the fire frequency analysis, this value represents the fraction of time that a TAD canister in an AO while diesel fuel is present in a large fire..	Section 6.5, Table 6.5-4
060-PROB-TAD-AO-PREP	Probability TAD canister in AO in Cask Preparation Room	3.55E-01	Based on the fire frequency analysis, this value represents the fraction of time that a TAD canister in an AO in the Cask Preparation Room.	Section 6.5, Table 6.5-4
060-PROB-TAD-CTM	Probability TAD canister in CTM in Fire	9.82E-03	Based on the fire frequency analysis, this value represents the fraction of time that a TAD canister is in the CTM in a large fire.	Section 6.5, Table 6.5-4
060-PROB-TAD-IN-AO-LF	Probability TAD canister in AO in Large Fire	7.51E-02	Based on the fire frequency analysis, this value represents the fraction of time that a TAD canister is in an AO in a large fire.	Section 6.5, Table 6.5-4
060-PROB-TAD-IN-CTM-LF	Probability TAD canister in CTM in Large Fire	9.94E-03	Based on the fire frequency analysis, this value represents the fraction of time that a TAD canister is in the CTM in large fire.	Section 6.5, Table 6.5-4
060-PROB-TAD-IN-TC-LF	Probability TAD canister in TC in Large Fire	2.33E-01	Based on the fire frequency analysis, this value represents the fraction of time that a TAD canister is in the TC in large fire.	Section 6.5, Table 6.5-4

Table 6.3-11. Miscellaneous Data Used In the Reliability Analysis (Continued)

Basic Event (BE) ID	Basic Event Description	BE Value	Bases	References
060-PROB-TAD-IN-WP-LF	Probability TAD canister in WP in Large Fire	6.82E-01	Based on the fire frequency analysis, this value represents the fraction of time that a TAD canister is in the WP in large fire.	Section 6.5, Table 6.5-4
060-PROB-TAD-TC-CUR	Probability TAD canister in TC in Cask Unloading Room	4.80E-01	Based on the fire frequency analysis, this value represents the fraction of time that a TAD canister is in the TC in the Cask Unloading Room.	Section 6.5, Table 6.5-4
060-PROB-TAD-TC-CURND	Probability TAD canister in TC without diesel Fire	4.80E-01	Based on the fire frequency analysis, this value represents the fraction of time that a TAD canister is in the TC in the Cask Unloading Room while diesel fuel is not present.	Section 6.5, Table 6.5-4
060-PROB-TAD-TC-DIESEL	Probability TAD canister in TC with diesel Fire	1.37E-02	Based on the fire frequency analysis, this value represents the fraction of time that a TAD canister is in the TC while diesel fuel is present in large fire.	Section 6.5, Table 6.5-4
060-PROB-TAD-TC-PREP	Probability TAD canister in TC in Cask Preparation Room	6.45E-01	Based on the fire frequency analysis, this value represents the fraction of time that a TAD canister is in the TC in the Cask Preparation Room.	Section 6.5, Table 6.5-4
060-PROB-TAD-TC-WODIESEL	Probability TAD canister in TC in Fire without diesel	2.17E-01	Based on the fire frequency analysis, this value represents the fraction of time that a TAD canister is in the TC while diesel fuel is not present in large fire.	Section 6.5, Table 6.5-4
060-PROB-TAD-WP	Probability TAD canister in WP in Fire	1.14E-02	Based on the fire frequency analysis, this value represents the fraction of time that a TAD canister is in the WP in large fire.	Section 6.5, Table 6.5-4
060-PROB-TAD-WPTT	Probability TAD canister in WPTT in Fire	6.74E-01	Based on the fire frequency analysis, this value represents the fraction of time that a TAD canister is in the WP in the WPTT in large fire.	Section 6.5, Table 6.5-4
060-RHSLIFTNUMBER-000001	Number of RHS Lifts	2.00E+00	This value represents the number of lifts performed by the remote handling system during the process of sealing the WP.	Attachment E, Table E6.6-1

Table 6.3-11. Miscellaneous Data Used In the Reliability Analysis (Continued)

Basic Event (BE) ID	Basic Event Description	BE Value	Bases	References
060-SLIDEGATECLOSES-CAN	Slide gate impact damages canister	0.00E+00	The port slide gate and the CTM bell slide gate are designed to operate with a low-torque motor that prevent crushing a canister, should the canister be in transit through the gate. (see Section 6.0)	Attachment B4, Section B4.4.1.3
060-SPMRC-DNSF-DIESEL	Probability of Fire in Cask Preparation Room with diesel	9.44E-02	Based on the fire frequency analysis, this value represents the fraction of time that a DOE Std. canister is in a TC in the Cask Preparation Room in a diesel fire.	Table 6.3-10 (DSNF-3)
060-SPMRC-DNSF-WODIESEL	Probability of Fire in Cask Preparation Room without diesel	9.06E-01	Based on the fire frequency analysis, this value represents the fraction of time that a DOE Std. canister is in a TC in the Cask Preparation Room in a non-diesel fire.	Table 6.3-10 (DSNF-4)
060-SPMRC-HLW-DIESEL	Fire in Cask Preparation Room SPMRC with diesel	9.09E-02	Based on the fire frequency analysis, this value represents the fraction of time that a HLW canister is in a TC in the Cask Preparation Room in a diesel fire.	Table 6.3-10 (HLW-3)
060-SPMRC-HLW-WODIESEL	Fire in Cask Preparation Room SPMRC without diesel	9.09E-01	Based on the fire frequency analysis, this value represents the fraction of time that a HLW canister is in a TC in the Cask Preparation Room in a non-diesel fire.	Table 6.3-10 (HLW-4)
060-SPMRC-MCO-DIESEL	Probability of Fire in Cask Preparation Room with diesel	9.44E-02	Based on the fire frequency analysis, this value represents the fraction of time that a MCO canister in a TC is in the Cask Preparation Room in a diesel fire. . Data for MCO is the same as for the DOE Std. canister.	Table 6.3-10 (MCO-3)
060-SPMRC-MCO-WODIESEL	Probability of Fire in Cask Preparation Room without diesel	9.06E-01	Based on the fire frequency analysis, this value represents the fraction of time that a MCO canister in a TC is in the Cask Preparation Room in a non-diesel fire. . Data for MCO is the same as for the DOE Std. canister.	Table 6.3-10 (MCO-4)

Table 6.3-11. Miscellaneous Data Used In the Reliability Analysis (Continued)

Basic Event (BE) ID	Basic Event Description	BE Value	Bases	References
060-SPMRC-MILES-IN-CRCF	Miles Traveled in CRCF	4.00E-02	The distance the SPMRC travels in the CRCF is estimated to be 215 feet.	Ref. 2.2.32
060-SPMRC-TAD-DIESEL	Fire in Cask Preparation Room SPMRC with diesel	5.75E-02	Based on the fire frequency analysis, this value represents the fraction of time that a TAD canister in a TC is in the Cask Preparation Room in a diesel fire.	Table 6.3-10 (TAD-5)
060-SPMRC-TAD-WODIES	Fire in Cask Preparation Room SPMRC without diesel	5.88E-01	Based on the fire frequency analysis, this value represents the fraction of time that a TAD canister in a TC is in the Cask Preparation Room in a non-diesel fire.	Table 6.3-10 (TAD-6)
060-STAGING-AREA-SHIELD	Failure of shielding in Staging Area	0.00E+00	Insulation provides protection to prevent loss of shielding	Table 6.3-6
060-ST-#-OF-SHIELD-DOORS	Number of Shield Doors ST Passes Through	2.00E+00	The ST is required to go across two shield doors during transit from outside of the facility into the Cask Unloading Room; (1) the door to the Cask Preparation Room, and (2) the Cask Unloading Room shield door.	Ref. 2.2.32
060-TADAO-CUR-DIESEL	Localized fire threatens TAD canister in Cask Unloading Room	2.50E-07	Localized Fire Threatens TAD canister in WP or TAD canister in AO (with diesel present) in Cask Unloading Room (diesel Present)in WP Loadout Room	Section 6.5, Table 6.5-4

Table 6.3-11. Miscellaneous Data Used In the Reliability Analysis (Continued)

Basic Event (BE) ID	Basic Event Description	BE Value	Bases	References
060-TAD-AO-DIESEL	Fire in Cask Preparation Room with diesel - TAD canister in AO	3.55E-01	Based on the fire frequency analysis, this value represents the fraction of time that a TAD canister in an AO is in the Cask Preparation Room in a diesel fire.	N/A
060-TAD-CAN-CTM-FIRE	Localized fire threatens canister in the CTM	1.10E-07	Localized Fire Threatens TAD canister in CTM in Canister Transfer Room	Section 6.5, Table 6.5-4
060-TAD-FIRE-PREP-AREA	Probability of Fire Affecting TAD canister in Cask Preparation Room	8.17E-06	Localized Fire Threatens TC/TAD canister in Vestibule/Cask Preparation Room w/SPM (diesel Present), TC/TAD canister without SPM (No diesel Present), TAD canister in AO (diesel Present), and TC/TAD canister on CTT (No diesel Present).	Section 6.5, Table 6.5-4
060-TAD-LARGE-FIRE	Large fire threatens TAD canister anywhere in CRCF	8.76E-05	Large Fire Threatens TC/TAD canister (diesel Present), TC/TAD canister (No diesel), TAD canister in AO (diesel Present), TAD canister in CTM, TAD canister in WP in WPTT, and TAD canister in WP in TEV	Section 6.5, Table 6.5-4
060-TAD-WP-LOADOUT-RM	Localized fire threatens TAD canister in WP in Loadout Room	9.20E-07	Localized Fire Threatens TAD canister in WP and TEV in WP Loadout Room	Section 6.5, Table 6.5-4
060-TAD-WP-POSIT-RM-FIRE	Localized fire threatens TAD canister in WP in Position Room	6.50E-05	Mean probability that a Localized Fire Threatens TAD canister in WP in WP Positioning/Closure Room	Section 6.5, Table 6.5-4
060-TOTAL-SHIELD-DOORS	Total Number of Shield Doors	3.00E+00	Total number of shield doors traversed by the CTT or ST	Ref. 2.2.32

Table 6.3-11. Miscellaneous Data Used In the Reliability Analysis (Continued)

Basic Event (BE) ID	Basic Event Description	BE Value	Bases	References
060-TRANSCTTLIFTNUMBER	Number of Crane Lifts	3.00E+00	Total number of lifts by the 200-ton crane during transfer of a TC from conveyance to preparation station. A number of 3 lifts per transfer (whether the transfer is directly from the conveyance – 1 lift – or has to be transferred to a cask stand then to a cask tilting frame – 2 lifts) is used to conservatively bind all possible methods for transferring the cask.	Attachment E
060-TRANSNSCTTLIFTNUMBER	Number of Crane Lifts without sling	1.00E+00	Horizontal casks can be lifted directly from the conveyance and transferred to a preparation station; therefore, it requires one lift. On the other hand, transfer of some casks may require sling. In that case, the cask is first transferred from the conveyance to a cask stand by sling. Then, from the cask stand to a cask tilting frame, the transfer is also done with sling. (Thus, 2 lifts are done with sling). From the tilting frame to the preparation station, the cask is lifted without sling. That's one lift without sling.	Attachment E
060-TRANSSTANDLIFTNUMBER	Crane Lifts with sling lift	2.00E+00	See above - 060-TRANSNSCTTLIFTNUMBER	Attachment E
060-UPENDOBJLIFTNUMBER	Number of object lifts	3.00E+00	During upending a horizontal TC from the railcar, the most bounding scenario is upending a cask with a sling lift. This involves (1) lifting the cask with a sling from the conveyance to the cask stand; (2) lifting the cask from the stand to the cask tilting frame with sling; and (3) lifting the cask from the tilting frame to the cask preparation station. For each lift, there is an opportunity to lift a heavy object over the cask and drop it onto the cask.	Attachment E

Table 6.3-11. Miscellaneous Data Used In the Reliability Analysis (Continued)

Basic Event (BE) ID	Basic Event Description	BE Value	Bases	References
060-VCTO-CONTDOORS-OPEN	Vestibule Doors Open Receipt or Export from CRCF	1.00E+00	Set as "TRUE" that the vestibule doors are open during receipt or export of a TC or AO	N/A
060-VCTO-DRS0000-DRS-OPN	Vestibule Door Open During Receipt/Export	1.60E-04	During receipt of a transportation cask or aging overpack or during the export of a waste package or aging overpack, delta pressure is lost for a period of time not to exceed 7 minutes per event (this is a conservative estimate of the time it will take for the HVAC system to return the vestibule to a negative pressure). This occurs as a direct consequence of opening vestibule doors to allow the site transporter , the site prime mover or the transport and emplacement vehicle .	Attachment B, Section B7
060-VCTO-TRAINB-MAINT	Train B HVAC is Off-Line for Maintenance	4.57E-03		Attachment B, Section B7
060-WPTT-MILES-IN-CRCF	Miles Traveled by WPTT During Transfer	4.00E-02	This value represents the number of miles that the WPTT will travel in the CRCF during normal operations.	N/A
11-CAN-FAIL-WP-WELD	TAD canister fails without WP	1.00E-08	Low welding temperature	Section 6.0, Table 6.0-2
11-H&D-FAIL-WP-WELD	DOE Std. canister fails in Open WP	0	Low welding temperature	Section 6.0, Table 6.0-2
26D-#EEY-ITSDG-A-#DG-MTN	ITS DG A OOS Maintenance	1.95E-03	Diesel Generator A out of service for maintenance	Attachment B, Section B8
26D-#EEY-ITSDG-A-#DG-RSS	Failure to properly return ITS DG A to service	1.95E-04	Operator fails to properly return diesel generator A to service after maintenance	Attachment B, Section B8
26D-#EEY-ITSDG-B-#DG-MTN	ITS DG B OOS Maintenance	1.95E-03	Diesel generator B out of service for maintenance	Attachment B, Section B8

Table 6.3-11. Miscellaneous Data Used In the Reliability Analysis (Continued)

Basic Event (BE) ID	Basic Event Description	BE Value	Bases	References
26D-#EEY-ITSDG-B-#DG-RSS	Failure to properly restore ITS DG-B to service	1.95E-04	Operator fails to properly return diesel generator B to service after maintenance	Attachment B, Section B8
AO-TAD canister	Number of AOs containing TAD canisters processed during preclosure period	8.14E+03	Number of TAD canisters in AOs processed during the preclosure period as established in the throughput analysis.	Ref. 2.2.31
AO-TAD-IN	Number of AOs containing TAD canisters received during preclosure period	8.14E+03	Number of TAD canisters in AOs processed during the preclosure period as established in the throughput analysis.	Ref. 2.2.31
AO-TAD-OUT	Number of TAD canisters in AOs outgoing	6.98E+03	This basic event represents the number of AOs that are exported from the CRCF during the preclosure period. The value for this basic event is obtained from the throughput analysis.	Ref. 2.2.31
DPC	Number of DPCs processed during preclosure period	3.46E+02	This basic event represents the number of DPCs handled by the CTM during the preclosure period. The value for this basic event is obtained from the throughput analysis.	Ref. 2.2.31
DSTD	Number of DOE Std. Canisters moved during preclosure period	6.22E+03	This basic event represents the number of DOE Std. canisters handled by the CTM during the preclosure period. The value for this basic event is obtained from the throughput analysis.	Ref. 2.2.31
HLW	Number of HLW Canisters moved during preclosure period	9.80E+03	This basic event represents the number of HLW Canisters handled by the CTM during the preclosure period. The value for this basic event is obtained from the throughput analysis.	Ref. 2.2.31
MCO	Number of MCOs moved during preclosure period	4.51E+02	This basic event represents the number of MCOs handled by the CTM during the preclosure period. The value for this basic event is obtained from the throughput analysis.	Ref. 2.2.31

Table 6.3-11. Miscellaneous Data Used In the Reliability Analysis (Continued)

Basic Event (BE) ID	Basic Event Description	BE Value	Bases	References
PROB-LEAD	Probability of Lead Casks	1.00E+00	The number of leaded TC received by the facility is unknown. This value is set to a value of 1.0 to ensure a conservative analysis.	N/A
PROB-NON-LEAD	Probability of Non-Lead Casks	0.00E+00	Since all TCs received by the facility are considered as leaded casks, then the probability of receiving non-leaded casks is 0.	N/A
SHIELD_DOOR_FAILURE	Shield Door Falls on Conveyance	0.00E+00	Design of shield door prevents failure due to low speed collisions within the CRCF.	Table 6.0-2
SHIELD-BELL-DROPS-SUBSUM	shield bell drops addressed in general CTM drop events	0.00E+00	Drops of canisters are subsumed in canister drop fault trees	N/A
TAD	Number of TAD canisters moved during preclosure period	1.51E+04	This basic event represents the number of TAD canisters transferred from a TC to an AO, from an AO to a WP, or from a TC to a WP. The value for this basic event is obtained from the throughput analysis.	Ref. 2.2.31
TC-AO-TAD	Number of TCs and AOs containing TAD canisters moved during preclosure period	1.51E+04	This basic event represents the number of TAD canisters transferred from a TC to an AO, from an AO to a WP, or from a TC to a WP. The value for this basic event is obtained from the throughput analysis.	Ref. 2.2.31
TC-DPC	Number of TCs containing DPCs moved during preclosure period	3.46E+02	This basic event represents the number of TCs containing DPC. The value for this basic event is obtained from the throughput analysis.	Ref. 2.2.31
TC-DSTD	Number of TCs containing DOE Std. Canisters moved during preclosure period	3.85E+02	This basic event represents the number of TCs containing defense SNF. The value for this basic event is obtained from the throughput analysis.	Ref. 2.2.31
TC-HLW	Number of TCs containing HLW Canisters moved during preclosure period	1.96E+03	This basic event represents the number of TCs containing HLW. The value for this basic event is obtained from the throughput analysis.	Ref. 2.2.31

Table 6.3-11. Miscellaneous Data Used In the Reliability Analysis (Continued)

Basic Event (BE) ID	Basic Event Description	BE Value	Bases	References
TC-MCO	Number of TCs containing MCOs received during preclosure period	1.13E+02	This basic event represents the number of TCs containing MCOs. The value for this basic event is obtained from the throughput analysis.	Ref. 2.2.31
TC-TAD	Number of TCs containing TAD canisters moved during preclosure period	6.98E+03	This basic event represents the number of TCs containing MCOs. The value for this basic event is obtained from the throughput analysis.	Ref. 2.2.31
TEV_COLLISION	TEV collides with WPTT	0.00E+00	The TEV is in place and stationary when the WPTT enters the WP Loadout Room. The probability the TEV collides with the WEPTT is set to 0.	N/A
WELD_DAMAGE	Weld Generates Sufficient Heat to Damage Can	0.00E+00	Welder malfunctions during the inner lid or outer lid welding. Since the welder can not generate sufficient heat to damage the WP, a value of 0.00 is assigned to the event.	N/A
WP-FIRE-SHIELDING	Probability of Shielding Degradation in a fire	0.00E+00	WPTT shielding remains intact	Table 6.3-6
WP-H&D	Number of WPs containing H&D	3.30E+03	This basic event represents the number of WPs containing 4 to 5 HLW canisters and 1 DOE SNF standard canister in the middle. The value for this basic event is obtained from the throughput analysis.	Ref. 2.2.31
WP-H&M	Number of WPs with MCOs moved during preclosure period	2.26E+02	This basic event represents the number of WPs containing 2 HLW canisters and 2 MCOs. The value for this basic event is obtained from the throughput analysis.	Ref. 2.2.31
WP-TAD	Number of WPs containing TAD canisters	8.14E+03	This basic event represents the number of WPs containing TAD canister. The value for this basic event is obtained from the throughput analysis.	Ref. 2.2.31

6.4 HUMAN RELIABILITY ANALYSIS

The PCSA has emphasized human reliability analysis (HRA) because the waste handling processes include substantial interactions between equipment and operating personnel. If there are human interactions that are typically associated with the operation, test, calibration, or maintenance of a certain type of SSC (e.g., drops from a crane when using slings) and this SSC has been treated using industry-wide data per Attachment C, then human failure events may be implicit in the reliability data. The analyst is tasked with determining whether that is the case. Otherwise, the analyst includes explicit identification, qualitative modeling, and quantification of HFES, as described in this section. The detailed description of the HRA is presented in Attachment E.

6.4.1 HRA Scope

The scope of the HRA is established in order to focus the analysis on the issues pertinent to the goals of the overall PCSA. Thus, the scope is as follows:

1. HFES are only considered if they contribute to a scenario that has the potential to result in a release of radioactivity, a criticality event, or a radiation exposure to workers. Such scenarios may include the need for mitigation of radionuclides, for example, provided by the confinement HVAC system.
2. Pursuant to the above, the following types of HFES are excluded:
 - A. HFES resulting in standard industrial injuries (e.g., falls)
 - B. HFES resulting in the release of hazardous nonradioactive materials, regardless of amount
 - C. HFES resulting solely in delays to or losses of process availability, capacity, or efficiency.
3. The identification of HFES is restricted to those areas of the facility that handle waste forms and only during the times that waste forms are being handled (e.g., HFES are not identified for the Cask Preparation Room during the export of empty transportation casks).
4. The exception to #3 is that system-level HFES are considered for support systems (e.g., electrical power for confinement HVAC) when those HFES could result in a loss of a safety function related to the occurrence or consequences associated with the events specified in #1.

5. Post-initiator recovery actions (as defined in Section E5.1.1.1) are not credited in the analysis; therefore, HFEs associated with them are not considered.
6. In accordance with Section 4.3.10.1 (on boundary conditions of the PCSA), initiating events associated with conditions introduced in SSCs before they reach the site are not, by definition of 10 CFR 63.2 (Ref. 2.3.2), within the scope of the PCSA nor, by extension, within the scope of the HRA.

6.4.2 Base Case Scenarios

The first step in this analysis is to describe the CRCF operations in sufficient detail such that the human reliability analysts can identify specific deviations that would lead to a radiation release, a direct exposure, or a criticality event. To do this, the CRCF operations were broken into eight separate operational steps, as depicted in Figure 6.4-1.

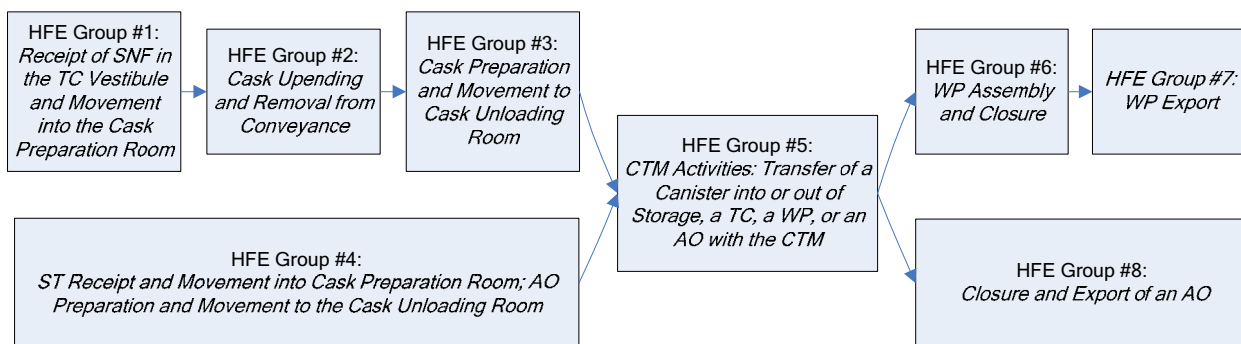

NOTE: AO = aging overpack; CTM = canister transfer machine; HFE = human failure event; SNF = spent nuclear fuel; ST = site transporter; TC = transportation cask; WP = waste package.

Source: Original

Figure 6.4-1. CRCF Operations

The base case scenario for each HFE group represents a realistic description of expected facility, equipment, and operator behavior for the selected operation. These scenarios are created from discussions between the human reliability analysts, other PCSA analysts, and personnel from engineering and operations. In addition to a detailed description of the operation itself, these base case scenarios include a brief description of the initial conditions and relevant equipment features (e.g., interlocks). The relationship between these HFE groups and the corresponding PFD nodes and ESDs are mapped in Attachment E, Table E6.0-1.

6.4.3 Identification of Human Failure Events

There are many possible human errors that could occur at YMP the effects of which might be significant to safety. Human errors, based upon the three temporal phases used in PRA modeling, are categorized as follows:

- Pre-initiator HFEs
- Human-induced initiator HFEs

- Post-initiator HFEs¹:
 - Non-recovery
 - Recovery.

Each of these types of HFEs is defined in Attachment E, Section E5.1.1.1. The PCSA model was developed and quantified with pre-initiator and human-induced initiator, and HFEs included in the model. Moreover, recovery post-initiator HFEs were not identified and not relied upon to reduce event sequence frequency. The safety philosophy of waste handling operations is that an operator need not take any action after an initiating event, and there are no actions identified that could exacerbate the consequences of an initiating event. This stems from the definitions and modeling of initiating events and subsequent pivotal events as described in Section 6.1 and Attachment A. All initiating events are proximal causes of either radionuclide release or direct exposure to personnel. With respect to the latter, personnel evacuation was not considered in reducing the frequency of direct exposure, but personnel action could cause an initiating event. With respect to the former, pivotal events address containment integrity, confinement availability, shielding integrity, and moderator availability that have no post-initiator human interactions. Containment and shielding integrity are associated only with the physical robustness of the waste containers. Confinement availability is associated with a continuously operating HVAC and the status of equipment confinement doors. Human interactions for HVAC are pre-initiator. Human actions for shielding are associated with the initiator phase. Thus, the focus of the HRA task is to support the other PCSA tasks to identify these two HFE phases.

Pre-Initiator HFEs

Pre-initiators are identified by the system analysts when modeling fault trees during the system analysis task. Special attention is paid to the possibility that an error can be repeated in similar redundant components or trains, leading to a human CCF.

Human-Induced Initiator HFEs

Human-induced initiator HFEs are identified through an iterative process whereby the human reliability analysts, in conjunction with other PCSA analysts and Engineering and Operations personnel, meet and discuss the design and operations of the facility and the SSCs in order to appropriately model the human interface. This iterative process began with the HAZOP evaluation, the MLD and event sequence development, and the event tree and fault tree modeling, and it culminated in the preliminary analysis and incorporation of HFEs into the model. Included in this process is an extensive information collection process where industry data for potential vulnerabilities and HFE scenarios are reviewed. The following sources were examined:

- *A Survey of Crane Operating Experience at U.S. Nuclear Power Plants from 1968 – 2002*, NUREG-1774 (Ref. 2.2.57)

¹ Terminology common to NPPs refer to post-initiator non-recovery events as Type C events and recovery events as Type CR events.

- *Control of Heavy Loads at Nuclear Power Plants*, NUREG-0612 (Ref. 2.2.67)
- Naval Facilities Engineering Command Internet Web Site, Navy Crane Center (“DOE Occurrence Reporting and Processing System (ORPS) Website and Naval Facilities Engineering Command (NAVFAC) Navy Crane Center Website.” The database includes the following information:
 - NCC Quarterly Reports (“Crane Corner”) 2001 through 2007
 - NCC Fiscal Year 2006 Crane Safety Reports (covers fiscal year 2001 through 2006)
 - NCC Fiscal Year 2006 Audit Report
- DOE Occurrence Reporting and Processing System (ORPS) Internet Web Site, Operational Experience Summaries (2002 through 2007) (<http://www.hss.energy.gov/CSA/analysis/orps/orps.html>)
- Institute of Nuclear Power Operations (INPO) database (<https://www.inpo.org>). The INPO database contains the following information:
 - Licensee event reports
 - Equipment Performance and Information Exchange System
 - Nuclear Plant Reliability Data System.
- *Savannah River Site Human Error Data Base Development for Nonreactor Nuclear Facilities (U)* (Ref. 2.2.13)
- All Scientech/Licensing Information Service (LIS) data on ISFSI events (1994 through 2007) and Dry Storage Information Forum (New Orleans, LA, May 2-3, 2001): This database includes the following information:
 - Inspection reports
 - Trip reports
 - Letters, etc.

HFEs identified include both EOOs and EOCs.

The result of this identification process is a list of HFEs and a description of each HFE scenario, including system and equipment conditions and any resident or triggered human factor concerns (e.g., PSFs). This combination of conditions and human factor concerns then becomes the EFC for a specific HFE. Additions and refinements to these initial EFCs are made during the preliminary and detailed analyses.

6.4.4 Preliminary Analysis

A preliminary analysis is performed to allow HRA resources for the detailed analyses to be focused on only the most risk-significant HFEs. The preliminary analysis includes verification of the validity of HFEs included in the initial PCSA model, assignment of conservative HEPs to all HFEs, and verification of those probabilities. The actual quantification of preliminary values

is a six-step process that is described in detail in Appendix E.III of Attachment E. Once the preliminary probabilities are assigned, the PCSA model is quantified (initial quantification) to determine which HFEs require a detailed quantification. HFEs are identified for a detailed analysis if (1) the HFE is a risk-driver for a dominant sequence, and (2) using the preliminary values, an aggregated event sequence is Category 1 or Category 2 according to 10 CFR 63.111 (Ref. 2.3.2) performance objectives.

In cases where HFEs are completely mitigated by hardware (i.e., interlocks), the HFE is generally assigned a value of 1.0 unless otherwise noted, and the hardware is modeled explicitly in the fault tree.

6.4.5 Detailed Analysis

Once preliminary values have been assigned, the model is run, and HFEs are identified for a detailed analysis if (1) the HFE is a risk-driver for a dominant sequence, and (2) using the preliminary values, that sequence is Category 1 or Category 2. A dominant sequence is one that does not meet the performance objectives according to the performance objectives in 10 CFR 63.111 (Ref. 2.3.2). The objective of a detailed analysis is to develop a more realistic HRA and identify design features to be added that will provide compliance with the aforementioned regulation. Many of the ITS features of Section 6.9 were identified during the HRA. The remaining HFEs retain their assigned preliminary values. For the preliminary analysis, many of the HFEs are modeled in a simplified form in the event trees and fault trees; although, for the preliminary analysis, each action is separated as much as possible for the detailed analysis. This separation is done to ensure that the detailed analysis is thorough and that the relationship between the system functionality and operations crew is transparent. First an HFE is broken down into the various scenarios that lead to the failure. Then, each scenario is further broken down into specific required actions and their applicable procedures, along with the systems and components that must be operated during performance of each action. Each action in each scenario has its own unique context, dependencies, and set of PSFs, and each is quantified independently. The failure probabilities for these unsafe actions are quantified by the HRA method appropriate to the HFE, its classification (e.g., EOC, EOO, observation error, execution error), and the context. For this analysis, several HRA methods were considered, and the following four methods were selected (Appendix E.IV of Attachment E provides a discussion of the selection process):

- CREAM (Cognitive Reliability and Error Analysis Method, CREAM (Ref. 2.2.56))
- HEART/NARA (“HEART - A Proposed Method for Assessing and Reducing Human Error” (Ref. 2.2.91)/, and *A User Manual for the Nuclear Action Reliability Assessment (NARA) Human Error Quantification Technique* (Ref. 2.2.42))
- THERP with some modifications (*Handbook of Human Reliability Analysis with Emphasis on Nuclear Power Plant Applications Final Report*. (Ref. 2.2.87))
- ATHEANA’s expert elicitation approach (*Technical Basis and Implementation Guidelines for a Technique for Human Event Analysis (ATHEANA)*. (Ref. 2.2.72)).

For the preliminary analysis, HFEs are modeled at a high level where several subtasks are combined into a single task so that explicit consideration of dependencies between subtasks is eliminated. For a detailed assessment, where the various actions that constitute an HFE are explicitly quantified, dependencies are also explicitly addressed using the basic formulae in Table 6.4-1 from the THERP method (Ref. 2.2.87), where N is the independently derived HEP.

Table 6.4-1. Formulae for Addressing HFE Dependencies

Level of Dependence	Zero	Low	Medium	High	Complete
Conditional Probability	N	$\frac{1 + 19N}{20}$	$\frac{1 + 6N}{7}$	$\frac{1 + N}{2}$	1.0

Source: Modified from Ref. 2.2.87, Table 20-17, p. 20–33.

After estimates for HFE probabilities are generated, these results are reviewed by the HRA team and, in some cases, by knowledgeable operations personnel, as a “sanity check.” Principally, such checks are used, for example, to compare the probabilities of different HFEs and determine whether or not these probabilities are consistent with the judgment of experts regarding the associated operator actions. A review of this type is particularly important for HFE probabilities that are generated using data from the THERP method (Ref. 2.2.87) since it is difficult to identify all important PSFs that are appropriate for repository operations. In addition, the HFE probability estimates are reviewed to ensure that they do not exceed the lower limit of credible human performance as defined by NARA (Ref. 2.2.42). HFE probabilities produced in this HRA are mean values; uncertainties are accounted for by applying an error factor to the mean value of the overall HFE according to the guidelines presented in Section E3.4 of Attachment E.

6.4.6 Human Failure Event Probabilities used in CRCF Event Sequences Analysis

The results of the HRA are the HFE probabilities used in the event tree and fault tree quantification process, which are listed in Table 6.4-2.

Table 6.4-2. Human Failure Event Probability Summary

Basic Event Name	HFE Description	ESD	HFE Group	Basic Event Mean Probability	Error Factor	Type of Analysis
060-#EEE-LDCNTRA-BUA-ROE	Operator fails to restore ITS load center Train A post maintenance	Electrical	OA (Pre-Initiator)	1.03E-05	10	Preliminary
060-#EEE-LDCNTRB-BUA-ROE	Operator fails to restore ITS load center Train B post maintenance	Electrical	OA (Pre-Initiator)	1.03E-05	10	Preliminary
060-Liddisplace1-HFI-NOD	Operator inadvertently displaces cask lid during platform activities	17	3, 4, 8	N/A ^b	N/A	Omitted from analysis
060-OpAOImpact01-HFI-NOW	Operator causes AO impact during AO platform activities (preparation or closure)	5, 12	4, 8	3.00E-03	5	Preliminary
060-OpCaskDrop01-HFI-NOD	Operator drops cask during cask preparation activities	4	3	N/A ^b	N/A	Omitted from analysis

Table 6.4-2. Human Failure Event Probability Summary (Continued)

Basic Event Name	HFE Description	ESD	HFE Group	Basic Event Mean Probability	Error Factor	Type of Analysis
060-OpCICTMGate1-HFI-NOD	Operator inappropriately closes slide or port gate during vertical canister movement and continues lifting	9	5	1.00E-03	5	Preliminary
060-OpCollide001-HFI-NOD	Operator causes low-speed collision of auxiliary vehicle with RC, TT, CTT, or TTC	3	2	3.00E-03	5	Preliminary
060-OpCranelntfr-HFI-NOD	Operator causes WP handling crane to interfere with TEV or WPTT	15	7	1.00E-04	10	Preliminary
060-OpCTCollide1-HFI-NOD	Operator causes low-speed collision of auxiliary vehicle with ST/CTT	4, 5, 12	3, 4, 8	3.00E-03	5	Preliminary
060-OpCTCollide2-HFI-NOD	Operator causes low-speed collision of CTT with SSC during transfer from preparation station to Cask Unloading Room	6	3	1.00E-03	5	Preliminary
060-OpCTMDirExp1-HFI-NOD	Operator causes direct exposure during CTM activities (second floor)	18	5	8E-06	10	Detailed
060-OpCTMDrInt01-HFI-COD	Operator lifts object or canister too high with CTM (two-block)	9	5	1.0	N/A	Preliminary
060-OpCTMdrop001-HFI-COD	Operator drops object onto canister during CTM operations	9	5	4.00E-07	10	Detailed
060-OpCTMdrop002-HFI-COD	Operator drops canister during CTM operations	9	5	5.00E-07	10	Detailed
060-OpCTMImpact1-HFI-COD	Operator moves the CTM while canister or object is below or between levels	9	5	4.00E-08	10	Detailed
060-OpCTMImpact2-HFI-COD	Operator causes canister impact with lid during CTM operations (non-DPC)	9	5	N/A ^b	N/A	Omitted from analysis
060-OpCTMImpact3-HFI-COD	Operator causes two CTMs to collide.	9	5	1.00E-01	3	Preliminary
060-OpCTMImpact5-HFI-COD	Operator causes canister impact with SSC during CTM operations	9	5	1.0	N/A	Preliminary
060-OpCTTImpact1-HFI-NOD	Operator causes an impact between cask and SSC due to crane operations	4	3	3.00E-03	5	Preliminary
060-OpDirExpose1-HFI-NOD	Operator causes direct exposure during CTM activities (first floor)	18	5	1.00E-01	3	Preliminary

Table 6.4-2. Human Failure Event Probability Summary (Continued)

Basic Event Name	HFE Description	ESD	HFE Group	Basic Event Mean Probability	Error Factor	Type of Analysis
060-OpDirExpose2-HFI-NOD	Operator causes direct exposure during CTM activities (transfer into an AO)	18	5	1.00E-04	10	Preliminary
060-OpDirExpose3-HFI-NOD	Operator causes direct exposure during TEV loading	19	7	3.00E-05	10	Detailed
060-OpDPCShield1-HFI-NOW	Operator causes loss of shielding while installing DPC lift fixture	17	3	4.00E-04	10	Detailed
060-OpDSNFLoad-HFI-NOD	Operator misloads DOE SNF	N/A	5	1.00E-03	5	Preliminary
060-OpFailRstInt-HFI-NOM	Operator fails to restore interlock after maintenance	18	5, 7	1.00E-02	3	Preliminary
060-OpFailSG-HFI-NOD	Operator fails to close the CTM slide gate moving CTM with canister inside bell (direct exposure)	18	5	1E-03	5	Preliminary
060-OpFailStop-HFI-NOD	Operator fails to stop ST if tread fails	2, 16	4, 8	1.0	N/A	Preliminary
060-OpFLCollide1-HFI-NOD	Operator causes high-speed collision of auxiliary vehicle with RC, TT, ST, CTT or TTC	3, 4, 5, 12	2, 3, 4, 8	1.0	N/A	Preliminary
060-OpImpact0000-HFI-NOD	Operator causes impact of cask during transfer between preparation station and Cask Unloading Room	6, 14	3, 4, 8	N/A ^b	N/A	Omitted from analysis
060-OpLoadDrop-HFI-NOD	Operator causes ST to drop AO	2, 16	4, 8	N/A ^b	N/A	Omitted from analysis
060-OpNoDiscoAir-HFI-NOD	Operator fails to disconnect air supply from CTT in the Cask Unloading Room	9	5	1.00E-03	5	Preliminary
060-OpNoUnBolt00-HFI-NOD	Operator fails to fully unbolt the cask lid before moving CTT into the Cask Unloading Room (non-DPC)	9	5	1.00E-03	5	Preliminary
060-OpNoUnBoltDP-HFI-NOD	Operator fails to fully unbolt the cask lid before moving CTT into the Cask Unloading Room (DPC)	9	5	N/A ^b	N/A	Omitted from analysis
060-OpNoUnplugST-HFI-NOD	Operator fails to disconnect the power supply from the ST in the Cask Unloading Room	9	5	1.00E-03	5	Preliminary
060-OpRCCollide1-HFI-NOD	Operator causes low-speed collision between RC and facility SSCs	1	1	3.00E-03	5	Preliminary

Table 6.4-2. Human Failure Event Probability Summary (Continued)

Basic Event Name	HFE Description	ESD	HFE Group	Basic Event Mean Probability	Error Factor	Type of Analysis
060-OpRCIntCol01-HFI-NOD	Operator causes high-speed collision between RC and facility SSCs	1	1	1.0	N/A	Preliminary
060-OpRCIntCol02-HFI-NOD	Operator causes MAP to collide into RC	1	1	1.0	N/A	Preliminary
060-OpSDClose001-HFI-NOD	Operator closes shield door on conveyance	7	OA (1, 3, 4, 7, 8)	1.0	N/A	Preliminary
060-OpShieldRing-HFI-NOD	Operator fails to install WP shield ring in WPTT (direct exposure)	19	7	1.00E-04	10	Preliminary
060-OpSpurMove01-HFI-NOD	Operator causes spurious movement of CTT or ST in the Cask Preparation Room	3, 4, 5, 12	2, 3, 4, 8	1.00E-04	10	Preliminary
060-OpStageRack1-HFI-NOD	Operator causes direct exposure during canister staging	18	5	3.00E-05	10	Detailed
060-OpSTCollide1-HFI-NOD	Operator causes low-speed collision of ST with SSC while moving to the Cask Preparation Room	2	4	3.00E-03	5	Preliminary
060-OpSTCollide2-HFI-NOD	Operator causes low-speed collision of ST with SSC while moving to the Cask Unloading Room	6	4	3.00E-03	5	Preliminary
060-OpSTCollide3-HFI-NOD	Operator causes low-speed collision of ST with SSC while moving from the Cask Unloading Room to the Cask Preparation Room	14	8	3.00E-03	5	Preliminary
060-OpSTCollide4-HFI-NOD	Operator causes low-speed collision of ST with SSC while exporting the ST	16	8	3.00E-03	5	Preliminary
060-OpTCImpact01-HFI-NOD	Operator causes an impact between cask and SSC during upending and removal	3	2	3.00E-03	5	Preliminary
060-OpTEVDrClosd-HFI-NOD	Operator begins WP extraction before TEV doors open	15	7	1.00E-03	5	Preliminary
060-OpTiltDown01-HFI-NOD	Operator causes premature tilt-down of the WPTT	9, 10, 13	5, 6, 7	1.0	N/A	Preliminary
060-OpTipover001-HFI-NOD	Operator causes cask to tip over during cask upending and removal	3	2	1.00E-04	10	Preliminary
060-OpTipover002-HFI-NOD	Operator causes cask to tip over during cask preparation activities	4	3	1.00E-04	10	Preliminary

Table 6.4-2. Human Failure Event Probability Summary (Continued)

Basic Event Name	HFE Description	ESD	HFE Group	Basic Event Mean Probability	Error Factor	Type of Analysis
060-OpTipOver003-HFI-NOD	Operator causes tipover of ST	5, 12	4, 8	1.00E-04	10	Preliminary
060-OpTipOver3-HFI-NOD	Operator causes tipover of ST or CTT during movement between the Cask Unloading Room and Cask Preparation Area	6	3, 4	N/A ^b	N/A	Omitted from analysis
060-OpTTCollide1-HFI-NOD	Operator causes low-speed collision between TT and facility SSCs	1	1	3.00E-03	5	Preliminary
060-OpTTIntCol01-HFI-NOD	Operator causes high-speed collision between TT and facility SSCs	1	1	1.0	N/A	Preliminary
060-OpTTIntCol02-HFI-NOD	Operator causes MAP to collide into TT	1	1	1.0	N/A	Preliminary
060-OpTTRollover-HFI-NOD	Operator causes rollover of TT	1	1	N/A ^b	N/A	Omitted from analysis
060-OpWPCollide1-HFI-NOD	Operator causes low-speed collision of WPTT into SSC	10, 13	6, 7	3.00E-03	5	Preliminary
060-OpWPInnerLid-HFI-NOD	Operator fails to install WP inner lid (direct exposure)	19	6	6.00E-06	10	Detailed
060-OpWPTiltUp01-HFI-NOD	Operator prematurely tilts up the WPTT	15	7	1.0	N/A	Preliminary
060-OpWPTTSpur01-HFI-NOD	Operator causes spurious movement of WPTT during canister loading	9	5	1.00E-03	5	Preliminary
060-VCTO-DR00001-HFI-NOD	Operators open two or more Vestibule Doors in CRCF	HVAC	OA (Pre-Initiator)	1.00E-02	3	Preliminary
060-VCTO-HFIA000-HFI-NOM	Human error exhaust fan switch wrong position	HVAC	OA (Pre-Initiator)	1.00E-01	3	Preliminary
060-VCTO-HEPALK-HFI-NOD	Operator fails to notice HEPA filter leak in Train A	HVAC	OA (Pre-Initiator)	1.0	N/A	Preliminary
26D-#EEY-ITSDG-A-#DG-RSS	Operator fails to restore Diesel Generator A to service	Electrical	OA (Pre-Initiator)	1.95E-04	10	Preliminary
26D-#EEY-ITSDG-B-#DG-RSS	Operator fails to restore Diesel Generator B to service	Electrical	OA (Pre-Initiator)	1.95E-04	10	Preliminary
Crane drops (drop of cask or object onto cask)	Operator drops cask or drops object onto cask during crane operations	Various (3, 4, 11, 15)	OA (2, 3, 6, 7)	N/A ^a	N/A	Historical data
Gas sampling	Operator improperly performs gas sampling	N/A	3	N/A	N/A	Omitted from analysis

Table 6.4-2. Human Failure Event Probability Summary (Continued)

Basic Event Name	HFE Description	ESD	HFE Group	Basic Event Mean Probability	Error Factor	Type of Analysis
Improper WP closure	Operator damages canister or fails to properly weld the WP	11	6	N/A ^b	N/A	Omitted from analysis
Load too heavy	Operator causes drop of cask by attempting to lift a load that is too heavy for the crane	N/A	OA	N/A ^b	N/A	Omitted from analysis
Moderator	Operator introduces moderator into a moderator-controlled area of the CRCF	N/A	OA	N/A ^b	N/A	Omitted from analysis
RC derailment	Operator causes the RC to derail	1	1	N/A ^a	N/A	Historical data
Spurious movement of CTT/ST during CTM activities	Operator causes spurious movement of the CTT or ST during canister loading and unloading	9	5	N/A ^b	N/A	Omitted from analysis
ST rollover	Operator causes rollover of ST	2, 16	4, 8	N/A ^b	N/A	Omitted from analysis
TEV_Collision	Operator causes TEV to collide with WP or WPTT	15	7	N/A ^b	N/A	Omitted from analysis
WPTT derailment	Operator causes WPTT to derail	10, 13	6, 7	N/A ^a	N/A	Historical data
WPTT uncontrolled tilt-down	Operator causes an uncontrolled tilt-down of the WPTT	10, 15	6, 7	N/A ^b	N/A	Omitted from analysis

NOTE: ^a Historical data was used to produce a probability of crane drops; this historical data is not included as part of the HRA, but is addressed in Attachment C.

^b These HFEs were initially identified, but omitted from analysis for various reasons, including a design change precluding the human failure, or the failure would require a series of unsafe actions in combination with mechanical failures, such that the event is no longer credible. See the appropriate HFE group in Attachment E for a case-by-case justification for these omissions.

AO = aging overpack; CRCF = Canister Receipt and Closure Facility; CTM = canister transfer machine; CTT = cask transfer trolley; DPC = dual-purpose canister; DOE = U.S. Department of Energy; ESD = event sequence diagram; HFE = human failure event; HVAC = heating, ventilation, and air conditioning; MAP = mobile access platform; MCC = motor control center; N/A = not applicable; OA = over arching (applies to multiple HFE groups (Section E6.0.2)); RC = railcar; SNF = spent nuclear fuel; SSC = structure, system, or component; SSCs = structures, systems, and components; ST = site transporter; TEV = transport and emplacement vehicle; TTC = a transportation cask that is upended using a tilt frame; TT = truck trailer; WP = waste package; WPTT = waste package transfer trolley.

Source: Original (Attachment E, Table E7-1)

6.5 FIRE INITIATING EVENTS

Attachment F of this document describes the work scope, definitions and terms, method, and results for the fire analysis performed as a part of the PCSA. The internal events of the PCSA model are evaluated with respect to fire initiating events and modified as necessary to address fire-induced failures that lead to exposures. The list of fire-induced failures included in the model, are evaluated as to fire vulnerability, and fragility analyses are conducted as needed (Section 6.3.2 and Attachment D).

Fire initiating event frequencies have been calculated for each initiating event identified for the CRCF. Section F5 of Attachment F details the analysis performed to determine these frequencies, using the methodology described in Section F4 of Attachment F.

6.5.1 Input to Initiating Events

Room and building areas; ignition frequencies; ignition source distributions; propagation probabilities; and residence fractions are the set of calculated values which contribute to calculating initiating event frequencies.

Room dimensions (Section F5.2.1 of Attachment F) are utilized to determine individual room areas, and the total building area. The area of the CRCF is utilized to evaluate the building ignition frequency. From methodology and equations presented in Section F4.3.1 of Attachment F, the building ignition frequency over the 50 year facility operation period -- of 3.7 is obtained for the CRCF. The results of this portion of the analysis are summarized in Table 6.5-1.

As discussed in Section F4.3.2.1, F5.3, and F5.4 of Attachment F, an industrial building fire can begin as the result of numerous types of ignition sources, which are grouped into nine categories:

1. Electrical equipment
2. HVAC equipment
3. Mechanical process equipment
4. Heat generating process equipment
5. Torches, welders, and burners
6. Internal combustion engines
7. Office and kitchen equipment
8. Portable and special equipment
9. No equipment involved.

Table 6.5-1. Room Areas and Total Ignition Frequency

Room	Area (m2)	Room	Area (m2)	Room	Area (m2)	Room	Area (m2)
1001	233	1019	213	1045	27	2006J	89
1001A	141	1020	33	1046	7	2006K	73
1002	74	1021	31	1047	76	2007	247
1002A	13	1022	28	1047A	66	2007A	27
1003	164	1023	78	1048	42	2007B	27
1004	119	1024	78	1049	76	2008	433

Table 6.5-1. Room Areas and Total Ignition Frequency (Continued)

Room	Area (m2)	Room	Area (m2)	Room	Area (m2)	Room	Area (m2)
1005A	103	1025	28	1049A	66	2010	186
1005B	68	1026	2143	1050	42	2011	224
1005C	51	1027	342	1051	32	2011A	19
1005D	67	1028	423	1052	32	2012	493
1005E	116	1029	164	1053	28	2038	40
1005F	109	1029A	25	1054	29	2039	42
1005G	53	1030	46	1201 - 1210	226	2040	42
1005H	58	1031	139	1211 - 1213 & 1215 - 1222	295	2041	48
1005J	141	1032	307			2042	42
1007	410	1033	144	1214	54	2043	36
1007A	36	1034	48	2001	433	2045	15
1008	164	1035	184	2002	183	2045A	15
1008A	25	1036	239	2003	211	2046	6
1009	46	1036A	208	2003A	19	2048	42
1010	129	1036B	20	2004	3846	2050	43
1011	313	1037	51	2005	511	3001	121
1012	147	1038	39	2005A	33	3002	61
1013	164	1039	39	2006A	90	3038	40
1013A	11	1040	39	2006B	71	3041	48
1014	385	1041	48	2006D	90	3045	15
1015	1326	1042	42	2006E	52	3045A	15
1016	33	1043	36	2006F	38	3046	7
1017	37	1044	20	2006G	129	3048	42
1018	213	1044A	7	2006H	40	3050	43
Total Area (m ²)				19611			
Ignition Frequency (per m ² /yr)				3.77E-06			
Ignition Frequency (per yr)				7.40E-02			
Ignition Frequency (50 years - preclosure period)				3.70E+00			

NOTE: m = meter; yr = year.

Source: Table F5.2-1 of Attachment F.

Each category has a fraction representing the probability that, given an ignition, that category is the source of the ignition. These fractions are combined with the number of units in each category to determine the ignition frequency per ignition source. Uncertainty distributions have been applied to the ignition frequencies (Appendix F.II of Attachment F), and contribute to the resulting distribution for fire initiating event frequencies. The number of ignition sources in each category is further divided by location into specific rooms. Each piece of equipment in a category is defined as one ignition source, with some exceptions:

- MCCs, load centers, and equipment racks contribute an ignition source for each active vertical cabinet.

- An ignition source is counted for each motor over 5 hp for all equipment with motors.
- A welding ignition source is counted for each hour of operation expected per year.
- The ignition sources for mobile equipment are split between the rooms the equipment occupies in proportion to the amount of time the equipment will spend in each room.
- An ignition source is counted for every square meter in the room for the no equipment involved category.

The distribution and determination of ignition sources is further discussed in Section F5.4 of Attachment F, and summarized in Table 6.5-2. Because the no equipment involved category ignition sources are equal to the square meters values (available in Table 6.5-1), and because there is no equipment for any of the facilities that falls under the heat-generating process equipment category (F5.4.4), those categories are not presented in the summary Table 6.5-2.

Table 6.5-2. Ignition Source Category and Room-by-Room Population

Room	Electrical	HVAC	Mechanical Equipment	Torches, welders, burners	Internal combustion engines	Office/ kitchen equipment	Portable Equipment
1001				5			
1001A		2					2
1003		4					2
1004	1	4					2
1007	105						2
1007A	2						
1008	25	2					2
1008A	1						
1009		4		5			2
1010		2					2
1011		4					2
1013	16					1	
1014		2	2				1
1015	1	2	9.2				2
1018			2.4				1
1019			2.4				1
1023			1.05				1
1024			1.05				1
1026	1		19.9		130		4
1027		2	2	5	10		
1028	1	2	4	400			
1029	22	2					2
1029A	1						
1030		4					2
1031		2					2

Table 6.5-2. Ignition Source Category and Room-by-Room Population (Continued)

Room	Electrical	HVAC	Mechanical Equipment	Torches, welders, burners	Internal combustion engines	Office/ kitchen equipment	Portable Equipment
1032		4					2
1035		4					2
1036		2			37		
1036A		2			23		
1044			1				
1047			1				
1049			1				
1201 - 1210						5	
1211 - 1213 & 1215 - 1222						4	
2001	26	6					4
2002				5			
2003	11		1				1
2004		2	14	10			1
2005	21	2					4
2007			5	946			2
2007A	9						1
2007B							1
2008	16	2					4
2010				5			
2011	11		1				1
2012	12	4					4
TOTAL	282	66	68	1381	200	10	60

NOTE: HVAC = heating, ventilation, and air conditioning.

Source: Table F5.5-1 of Attachment F.

Propagation probabilities (Section F5.6, Attachment F) are utilized in the analysis to define the probability of a fire spreading to various points specifically identified as areas in which a waste form may be vulnerable. Uncertainty distributions have been applied to the propagation probabilities (Appendix F.II of Attachment F), and contribute to the resulting distribution for fire initiating event frequencies.

Residence fractions (Section F5.7.1, Attachment F) developed from process throughputs, define the length of time (in minutes) a waste form is vulnerable in a particular area of the building and in a particular configuration. The minutes are converted to the fraction of time the vulnerability is present over the 50 year preclosure surface operation period, and are summarized in Table 6.5-3.

Table 6.5-3. Residence Fractions

Initiating Event	Residence Fraction
Waste Form in WP in WP Positioning/Closure Room	
TAD canister in WP in WP Positioning/Closure Room	9.6E-05
HLW in WP in WP Positioning/Closure Room	1.3E-05
HLW and DOE-SNF in WP in WP Positioning/Closure Room	9.8E-05
Waste Form in TEV in WP Loadout Room	
TAD canister/WP in TEV in WP Loadout Room	1.2E-06
HLW and DOE-SNF in WP, in TEV in WP Loadout Room	1.2E-06
Waste Form in WP in WP Loadout Room	
TAD canister in WP in WP Loadout Room	7.1E-06
HLW and DOE-SNF in WP in WP Loadout Room	7.1E-06
Waste Form on CTT in Cask Unloading Room	
TC/TAD canister on CTT in Cask Unloading Room	3.3E-06
TC/HLW on CTT in Cask Unloading Room	1.3E-05
TC/DOE-SNF on CTT in Cask Unloading Room	2.1E-05
TC/DPC (VTC) in Cask Unloading Room	1.8E-06
Waste Form in AO in Cask Unloading Room (Diesel Present)	
TAD canister in AO in Cask Unloading Room (Diesel Present)	3.5E-06
DPC (VTC) in AO in Cask Unloading Room (Diesel Present)	3.3E-06
Waste Form in Vestibule/Cask Preparation Room w/SPM (Diesel Present)	
TC/TAD canister in Vestibule/Cask Preparation Room w/SPM (Diesel Present)	2.1E-06
TC/HLW in Vestibule/Cask Preparation Room w/SPM (Diesel Present)	2.1E-06
TC/DOE-SNF in Vestibule/Cask Preparation Room w/SPM (Diesel Present)	2.1E-06
TC/DPC (VTC) in Vestibule/Cask Preparation Room (Diesel Present)	2.1E-06
Waste Form in Cask Preparation Room w/o SPM (No Diesel Present)	
TC/TAD canister in Cask Preparation Room w/o SPM (No Diesel Present)	1.5E-05
TC/HLW in Cask Preparation Room w/o SPM (No Diesel Present)	1.8E-05
TC/DOE-SNF in Cask Preparation Room w/o SPM (No Diesel Present)	1.5E-05
TC/DPC (VTC) in Cask Preparation Room (No Diesel Present)	1.3E-05
Waste Form in AO in Vestibule/Cask Preparation Room (Diesel Present)	
TAD canister in AO in vestibule/Cask Preparation Room (diesel present)	8.4E-06
DPC (VTC) in AO in vestibule/Cask Preparation Room (diesel present)	1.2E-05
Waste Form on CTT in Cask Preparation Room	
TC/TAD canister on CTT in Cask Preparation Room	1.6E-05
TC/HLW on CTT in Cask Preparation Room	1.4E-05
TC/DOE-SNF on CTT in Cask Preparation Room	1.5E-05
TC/DPC (VTC) in Cask Preparation Room	1.5E-05
Waste Form in CTM in Canister Transfer Room	
TAD canister in CTM in Canister Transfer Room	1.1E-06
HLW in CTM in Canister Transfer Room (per individual canister)	1.3E-06

Table 6.5-3. Residence Fractions (Continued)

Initiating Event	Residence Fraction
DOE-SNF in CTM in Canister Transfer Room (per individual canister)	1.1E-06
DPC in CTM in Canister Transfer Room	1.2E-06
TC/TAD canister (Diesel Present)	2.1E-06
TC/TAD canister (No Diesel)	3.3E-05
TAD canister in AO (Diesel Present)	1.1E-05
TAD canister in CTM	1.5E-06
TAD canister in WP in WPTT	1.0E-04
TAD canister in WP in TEV	1.8E-06
TC/HLW (Diesel Present)	2.1E-06
TC/HLW (No Diesel)	3.4E-05
HLW in CTM (per individual canister)	1.5E-06
HLW in WP	1.3E-05
HLW and DOE-SNF in WP	1.1E-04
TC/DOE-SNF (Diesel Present)	2.1E-06
TC/DOE-SNF (No Diesel)	3.2E-05
DOE-SNF in CTM (per canister)	1.1E-06
DOE-SNF in Staging Area	1.0E+00
TC/DPC (VTC) (Diesel)	2.1E-06
TC/DPC (VTC) (No Diesel)	3.0E-05
DPC (VTC) in CTM	1.2E-06
DPC (VTC) in AO (Diesel)	1.5E-05

NOTE: AO = aging overpack; CTM = canister transfer machine; CTT = cask transfer trolley; DOE = U.S. Department of Energy; DPC = dual-purpose canister; HLW = high-level radioactive waste; SNF = spent nuclear fuel; SPM = site prime mover; TAD = transportation, aging, and disposal; TC = transportation cask; TEV = transport and emplacement vehicle; VTC = a transportation cask that is upended on a railcar; WP = waste package; WPTT = waste package transfer trolley.

Source: Tables F5.7-1, F5.7-2, and F5.7-3 of Attachment F.

6.5.2 Initiating Event Frequencies

The results of the fire initiating event analysis are, the fire initiating event frequencies and their associated distributions, as presented in Table 6.5-4. The frequencies represent the probability, over the length of the preclosure surface operation period, that a fire will threaten the stated waste container in the stated location. Initiating event frequencies are divided into two types of calculations, localized fires and large fires, and are calculated for all locations associated with waste handling operations and locations from which a fire can spread to a waste handling operational location. (In Attachment F, these locations are sometimes called vulnerabilities). Calculations performed to obtain the initiating event are detailed in Section F5.7 of Attachment F.

Uncertainty distributions are utilized in the contribution to initiating event frequency calculations to account for statistical uncertainty in the data. Uncertainty distributions utilized for this analysis are lognormal distribution, and normal distribution. The normal distribution can be accurately represented by a mean and 97.5% value, the lognormal distribution is represented by a median (50%) and 97.5% value. The mean and median can be inputs to calculate the error factor. The 97.5% value is also provided, and is a figure that represents a point at which only 2.5% of all possible outcomes will vary from the mean more significantly. Three uncertainty distributions were developed for this analysis, details for which are in Appendices F.II and F.III of Attachment F.

Monte Carlo simulations are performed to determine the mean, median, standard deviation, variance, minimum, and maximum values of each of the initiating event frequencies based on the variance of the contributing data. To accomplish this, the Microsoft Excel add-on package Crystal Ball is used (Section F5.8). This software requires input of two parameters (e.g., in the lognormal case, 50% and 97.5% values). Crystal Ball software allows probability distributions to be combined per formulas or equations representing initiating event frequency inputs entered into EXCEL. The software randomly selects a value from the possibilities defined by the distribution. Ten thousand Monte Carlo trials are performed.

Crystal Ball is run for all of the initiating events, the complete output of which is available in Appendix VI of Attachment F. In addition to showing the initiating event frequency distribution, the full output also shows the input distribution for the parameters that are varied, which match the distributions developed and documented in Appendices F.II and F.III of Attachment F.

Table 6.5-4. Results from Monte Carlo Simulation of Initiating Event Frequency Distributions

Initiating Event	Equipment	Mean	Median	97.5% Value	EF	Type
Localized Fire Threatens TAD canister in WP in WP Positioning/Closure Room	-	6.5E-05	5.8E	1.4E-4	2.2E+00	Lognormal
Localized Fire Threatens HLW in WP in WP Positioning/Closure Room	-	8.5E-06	7.6E-06	1.9E-05	2.2E+00	Lognormal
Localized Fire Threatens HLW and DOE SNF in WP in WP Positioning/Closure Room	-	6.6E-05	5.9E-05	1.4E-04	2.2E+00	Lognormal
Localized Fire Threatens Waste Form in TEV in WP Loadout Room	Transportation emplacement vehicle					
Localized Fire Threatens TAD canister/WP in TEV in WP Loadout Room	-	1.9E-07	1.7E-07	4.1E-07	2.1E+00	Lognormal
Localized Fire Threatens HLW and DOE SNF in WP in TEV in WP Loadout Room	-	1.9E-07	1.7E-07	4.1E-07	2.1E+00	Lognormal

Table 6.5-4. Results from Monte Carlo Simulation of Initiating Event Frequency Distributions (Continued)

Initiating Event	Equipment	Mean	Median	97.5% Value	EF	Type
Localized Fire Threatens Waste Form in WP in WP Loadout Room	WP transfer trolley					
Localized Fire Threatens TAD canister in WP in WP Loadout Room	-	7.3E-07	6.6E-07	1.6E-06	2.0E+00	Lognormal
Localized Fire Threatens HLW and DOE SNF in WP in WP Loadout Room	-	7.3E-07	6.6E-07	1.6E-06	2.0E+00	Lognormal
Localized Fire Threatens Waste Form on CTT in Cask Unloading Room	Cask transfer trolley					
Localized Fire Threatens TC/TAD canister on CTT in Cask Unloading Room	-	1.2E-07	1.1E-07	2.8E-07	2.3E+00	Lognormal
Localized Fire Threatens TC/HLW on CTT in Cask Unloading Room	-	4.7E-07	4.2E-07	1.1E-06	2.2E+00	Lognormal
Localized Fire Threatens TC/DOE SNF on CTT in Cask Unloading Room	-	7.5E-07	6.7E-07	1.7E-06	2.2E+00	Lognormal
Localized Fire Threatens TC/DPC (VTC) in Cask Unloading Room	-	6.4E-08	5.6E-08	1.5E-07	2.3E+00	Lognormal
Localized Fire Threatens Waste Form in AO in Cask Unloading Room (Diesel Present)	Site transporter					
Localized Fire Threatens TAD canister in AO in Cask Unloading Room (Diesel Present)	-	1.3E-07	1.1E-07	2.9E-07	2.5E+00	Lognormal
Localized Fire Threatens DPC (VTC) in AO in Cask Unloading Room (Diesel Present)	-	1.2E-07	1.0E-07	2.7E-07	2.4E+00	Lognormal
Localized Fire Threatens Waste Form in Vestibule/Cask Preparation Room w/SPM (Diesel Present)	Site prime mover					
Localized Fire Threatens TC/TAD canister in Vestibule/Cask Preparation Room w/SPM (Diesel Present)	-	4.7E-07	4.2E-07	1.1E-06	2.2E+00	Lognormal

Table 6.5-4. Results from Monte Carlo Simulation of Initiating Event Frequency Distributions (Continued)

Initiating Event	Equipment	Mean	Median	97.5% Value	EF	Type
Localized Fire Threatens TC/HLW in Vestibule/Cask Preparation Room w/SPM (Diesel Present)	-	4.9E-07	4.3E-07	1.1E-06	2.2E+00	Lognormal
Localized Fire Threatens TC/DOE SNF in Vestibule/Cask Preparation Room w/SPM (Diesel Present)	-	4.9E-07	4.3E-07	1.1E-06	2.2E+00	Lognormal
Localized Fire Threatens TC/DPC (VTC) in Vestibule/Cask Preparation Room (Diesel Present)	-	4.9E-07	4.3E-07	1.1E-06	2.2E+00	Lognormal
Localized Fire Threatens Waste Form in Cask Preparation Room w/o SPM (No Diesel Present)	Railcar					
Localized Fire Threatens TC/TAD canister in Cask Preparation Room w/o SPM (No Diesel Present)	-	2.2E-06	2.0E-06	4.7E-06	2.2E+00	Lognormal
Localized Fire Threatens TC/HLW in Cask Preparation Room w/o SPM (No Diesel Present)	-	2.6E-06	2.3E-06	5.6E-06	2.2E+00	Lognormal
Localized Fire Threatens TC/DOE SNF in Cask Preparation Room w/o SPM (No Diesel Present)	-	2.2E-06	2.0E-06	4.7E-06	2.2E+00	Lognormal
Localized Fire Threatens TC/DPC (VTC) in Cask Preparation Room (No Diesel Present)	-	1.9E-06	1.7E-06	4.1E-06	2.1E+00	Lognormal
Localized Fire Threatens Waste Form in AO in Vestibule/Cask Preparation Room (Diesel Present)	Site transporter					
Localized Fire Threatens TAD canister in AO in Vestibule/Cask Preparation Room (Diesel Present)	-	2.9E-06	2.6E-06	6.3E-06	2.2E+00	Lognormal
Localized Fire Threatens DPC (VTC) in AO in Vestibule/Cask Preparation Room (Diesel Present)	-	4.2E-06	3.8E-06	9.2E-06	2.1E+00	Lognormal

Table 6.5-4. Results from Monte Carlo Simulation of Initiating Event Frequency Distributions (Continued)

Initiating Event	Equipment	Mean	Median	97.5% Value	EF	Type
Localized Fire Threatens Waste Form on CTT in Cask Preparation Room	Cask transfer trolley					
Localized Fire Threatens TC/TAD canister on CTT in Cask Preparation Room	-	2.6E-06	2.4E-06	6.0E-06	2.1E+00	Lognormal
Localized Fire Threatens TC/HLW on CTT in Cask Preparation Room	-	2.3E-06	2.1E-06	5.3E-06	2.0E+00	Lognormal
Localized Fire Threatens TC/DOE SNF on CTT in Cask Preparation Room	-	2.5E-06	2.2E-06	5.6E-06	2.3E+00	Lognormal
Localized Fire Threatens TC/DPC (VTC) in Cask Preparation Room	-	2.5E-06	2.2E-06	5.6E-06	2.2E+00	Lognormal
Localized Fire Threatens Waste Form in CTM in Canister Transfer Room	Canister transfer machine					
Localized Fire Threatens TAD canister in CTM in Canister Transfer Room	-	1.1E-07	1.0E-07	2.5E-07	2.0E+00	Lognormal
Localized Fire Threatens HLW in CTM in Canister Transfer Room (per individual canister)	-	1.3E-07	1.2E-07	2.9E-07	2.0E+00	Lognormal
Localized Fire Threatens DOE SNF in CTM in Canister Transfer Room (per individual canister)	-	1.1E-07	1.0E-07	2.5E-07	2.0E+00	Lognormal
Localized Fire Threatens DPC in CTM in Canister Transfer Room	-	1.2E-07	1.1E-07	2.7E-07	1.9E+00	Lognormal
Large Fire Threatens TC/TAD canister (Diesel Present)	-	1.2E-06	1.1E-06	2.8E-06	2.3E+00	Lognormal
Large Fire Threatens TC/TAD canister (No Diesel)	-	1.9E-05	1.7E-05	4.4E-05	2.2E+00	Lognormal
Large Fire Threatens TAD canister in AO (Diesel Present)	-	6.5E-06	5.8E-06	1.5E-05	2.2E+00	Lognormal
Large Fire Threatens TAD canister in CTM	-	8.6E-07	7.7E-07	2.0E-06	2.2E+00	Lognormal
Large Fire Threatens TAD canister in WP in WPTT	-	5.9E-05	5.3E-05	1.4E-04	2.1E+00	Lognormal
Large Fire Threatens TAD canister in WP in TEV	-	1.0E-06	9.1E-07	2.3E-06	2.0E+00	Lognormal

Table 6.5-4. Results from Monte Carlo Simulation of Initiating Event Frequency Distributions (Continued)

Initiating Event	Equipment	Mean	Median	97.5% Value	EF	Type
Large Fire Threatens TC/HLW (Diesel Present)	-	1.2E-06	1.1E-06	2.8E-06	2.3E+00	Lognormal
Large Fire Threatens TC/HLW (No Diesel)	-	2.0E-05	1.7E-05	4.6E-05	2.4E+00	Lognormal
Large Fire Threatens HLW in CTM (per individual canister)	-	8.6E-07	7.7E-07	2.0E-06	2.2E+00	Lognormal
Large Fire Threatens HLW in WP	-	7.3E-06	6.6E-06	1.7E-05	2.1E+00	Lognormal
Large Fire Threatens HLW and DOE SNF in WP	-	6.1E-05	5.5E-05	1.4E-04	2.2E+00	Lognormal
Large Fire Threatens TC/DOE SNF (Diesel Present)	-	1.2E-06	1.1E-06	2.8E-06	2.3E+00	Lognormal
Large Fire Threatens TC/DOE SNF (No Diesel)	-	1.8E-05	1.7E-05	4.2E-05	2.0E+00	Lognormal
Large Fire Threatens DOE SNF in CTM (per canister)	-	6.4E-07	5.8E-07	1.5E-06	2.1E+00	Lognormal
Large Fire Threatens DOE SNF in Staging Area	-	5.8E-01	5.2E-01	1.4E+00	2.2E+00	Lognormal
Large Fire Threatens TC/DPC (VTC) (Diesel)	-	1.2E-06	1.1E-06	2.9E-06	2.0E+00	Lognormal
Large Fire Threatens TC/DPC (VTC) (No Diesel)	-	1.7E-05	1.5E-05	4.0E-05	2.1E+00	Lognormal
Large Fire Threatens DPC (VTC) in CTM	-	7.1E-07	6.3E-07	1.6E-06	2.2E+00	Lognormal
Large Fire Threatens DPC (VTC) in AO (Diesel)	-	8.5E-06	7.6E-06	2.0E-05	2.2E+00	Lognormal

NOTE: AO = aging overpack; CTM = canister transfer machine; CTT = cask transfer trolley; DPC = dual-purpose canister; DOE = U.S. Department of Energy; EF = error factor; HLW = high-level radioactive waste; SPM = site prime mover; SNF = spent nuclear fuel; TAD = transportation, aging, and disposal; TEV = transport and emplacement vehicle; TC = transportation cask; VTC = transportation cask in vertical position; WP = waste package; WPTT = waste package transport trolley.

Source: Table F5.7-7 of Attachment F.

Table 6.5-5 provides the fire analysis data for the basic events in this model.

Table 6.5-5. Basic Events Data Associated with Fire Analysis

Basic Event (BE) ID	Basic Event Description	BE Value	Bases	References	Index Table 6.3-11
060-DNSF-CAN-CTM-FIRE	Localized fire threatens canister in the CTM	1.10E-07	Localized Fire Threatens DOE SNF in CTM in Canister Transfer Room (per individual canister)	Section 6.3, Table 6.3-11	DSNF-5
060-DNSF-CASK-CUR-FIRE	Localized Fire Threatens TC/DOE SNF on CTT in Cask Unloading Room	7.50E-07	Localized Fire Threatens TC/DOE SNF on CTT in Cask Unloading Room	Section 6.3, Table 6.3-11	DSNF-1
060-DNSF-LARGE-FIRE	Large fire threatens DNSF anywhere in CRCF	1.96E-04	Large Fire Threatens TC/DOE SNF (diesel Present), TC/DOE SNF (No diesel), in CTM (per canister), and in Staging Area	Section 6.3, Table 6.3-11	DSNF-6
060-DPC-CASK-PREP-FIRE	Fire in Cask Preparation Room	9.09E-06	Localized Fire Threatens TC/DPC (VTC) in Vestibule/Cask Preparation Room (diesel Present), TC/DPC (VTC) in Cask Preparation Room (No diesel Present), DPC (VTC) in AO in Vestibule/Cask Preparation Room (diesel Present), and TC/DPC (VTC) on CTT	Section 6.3, Table 6.3-11	DPC-4
060-DPC-CASK-UNLOAD-FIRE	Fire in the Cask Unloading Room	1.84E-07	Localized Fire Threatens TC/DPC (VTC) or AO (diesel Present) in Cask Unloading Room	Section 6.3, Table 6.3-11	DPC-1
060-DPC-CTM-FIRE	Fire in Transfer Room Affecting Can in CTM	1.20E-07	Localized Fire Threatens DPC in CTM in Canister Transfer Room	Section 6.3, Table 6.3-11	DPC-8
060-DPC-LARGE-FIRE	Large Fire in CRCF	2.67E-05	Large Fire Threatens TC/DPC (VTC) (diesel), TC/DPC (VTC) (No diesel), DPC (VTC) in CTM, and DPC (VTC) in AO (diesel)	Section 6.3, Table 6.3-11	DPC-9
060-DSNF-CSK-CPA-FIRE	Probability of Fire in Cask Preparation Room	5.19E-06	Localized Fire Threatens TC/DOE SNF in Vestibule/Cask Preparation Room w/SPM (diesel Present), TC/DOE SNF in Cask Preparation Room w/o SPM (No diesel Present), and TC/DOE SNF on CTT (No diesel Present).	Section 6.3, Table 6.3-11	DSNF-2

Table 6.5-5. Basic Events Data Associated with Fire Analysis (Continued)

Basic Event (BE) ID	Basic Event Description	BE Value	Bases	References	Index Table 6.3-11
060-FIRE-IN-POSITION-RM	Fire in WP Positioning/Closure Room Threatens WP	8.50E-06	Localized Fire Threatens HLW in WP in WP Positioning/Closure Room	Section 6.3, Table 6.3-11	HLW-6
060-H&D-LARGE-FIRE	Large fire threatens H&D anywhere in CRCF	6.10E-05	Large Fire Threatens HLW and DOE SNF in WP	Section 6.3, Table 6.3-11	H&D-3
060-H&D-WP-LDOUT-RM	Localized fire threatens WP in the WP Loadout Room	9.20E-07	Localized Fire Threatens HLW and DOE SNF in WP in TEV in WP Loadout Room	Section 6.3, Table 6.3-11	H&D-2
060-H&D-WP-POSIT-RM-FIRE	Localized fire threatens H&D WP in WP Positioning Room	6.60E-05	Localized Fire Threatens HLW and DOE SNF in WP and TEV in WP Positioning/Closure Room	Section 6.3, Table 6.3-11	H&D-1
060-H&M-LARGE-FIRE	Large fire threatens H&M anywhere in CRCF	6.10E-05	Large Fire Threatens HLW and MCO in WP	Section 6.3, Table 6.3-11	H&M-3
060-H&M-WP-LDOUT-RM	Localized fire threatens WP in the WP Loadout Room	9.20E-07	Localized Fire Threatens HLW and MCO in WP in TEV in WP Loadout Room	Section 6.3, Table 6.3-11	H&M-2
060-H&M-WP-POSIT-RM-FIRE	Localized fire threatens H&M WP in WP Positioning Room	6.60E-05	Localized Fire Threatens HLW and MCO in WP and TEV in WP Positioning/Closure Room	Section 6.3, Table 6.3-11	H&M-1
060-HLW-CAN-CTM-FIRE	Localized fire threatens HLW canister in CTM	1.30E-07	Localized Fire Threatens HLW in CTM in Canister Transfer Room (per individual canister)	Section 6.3, Table 6.3-11	HLW-5
060-HLW-CSK-UNLOAD-RM	Localized Fire threatens TC in Cask Unloading Room	4.70E-07	Localized Fire Threatens TC/HLW on CTT in Cask Unloading Room	Section 6.3, Table 6.3-11	HLW-1
060-HLW-CTM	Probability HLW in CTM	2.93E-02	Based on the fire frequency analysis, this value represents the fraction of time that a HLW canister is in the CTM in a large fire.	Section 6.3, Table 6.3-11	HLW-10
060-HLW-FIRE-PREPAREA	Fire involving HLW in Cask Preparation Room	5.39E-06	Localized Fire Threatens TC/HLW in Vestibule/Cask Preparation Room w/SPM (diesel Present), w/o SPM (No diesel Present), and TC/HLW on CTT (No diesel Present).	Section 6.3, Table 6.3-11	HLW-2
060-HLW-LARGE-FIRE	Large fire threatens HLW anywhere in CRCF	2.94E-05	Large Fire Threatens TC/HLW (diesel Present), TC/HLW (No diesel), HLW in CTM (per Individual canister), and HLW in WP	Section 6.3, Table 6.3-11	HLW-7

Table 6.5-5. Basic Events Data Associated with Fire Analysis (Continued)

Basic Event (BE) ID	Basic Event Description	BE Value	Bases	References	Index Table 6.3-11
060-HLW-TC-DIESEL	Probability HLW in TC with diesel Present	4.09E-02	Based on the fire frequency analysis, this value represents the fraction of time that a HLW canister is in the TC when diesel fuel is present in a large fire.	Section 6.3, Table 6.3-11	HLW-8
060-HLW-TC-WO-DIESEL	Probability HLW in TC Without diesel Present	6.81E-01	Based on the fire frequency analysis, this value represents the fraction of time that a HLW canister is in the TC when diesel fuel is not present in a large fire.	Section 6.3, Table 6.3-11	HLW-9
060-HLW-WP	Probability HLW in WP	2.49E-01	Based on the fire frequency analysis, this value represents the fraction of time that a HLW canister is in the WP in a large fire.	Section 6.3, Table 6.3-11	HLW-11
060-MCO-CAN-CTM-FIRE	Localized fire threatens canister in the CTM	1.10E-07	Localized fire threatens MCO in CTM	Section 6.3, Table 6.3-11	MCO-5
060-MCO-CASK-CUR-FIRE	Localized fire threatens TC Cask Unloading Room	7.50E-07	Localized fire threatens TC/MCO in Cask Unloading Area	Section 6.3, Table 6.3-11	MCO-1
060-MCO-CSK-CPA-FIRE	Probability of Fire in Cask Preparation Room	5.19E-06	Localized fire threatens TC/MCO in Cask Preparation Room	Section 6.3, Table 6.3-11	MCO-2
060-MCO-LARGE-FIRE	Large fire threatens MCO anywhere in CRCF	1.98E-05	Large Fire Threatens TC/MCO (diesel Present), TC/MCO (No diesel), in CTM (per canister)	Section 6.3, Table 6.3-11	MCO-6
060-PROB-DIESEL-AO-CUR	Probability of DPC in AO & diesel in Cask Unloading Room	6.52E-01	Based on the fire frequency analysis, this value represents the fraction of time that a DPC is in the AO in the Cask Unloading Room while diesel fuel is present.	Section 6.3, Table 6.3-11	DPC-2
060-PROB-DIESEL-AO-PREP	Probability of DPC in AO & diesel in Cask Preparation Room	4.62E-01	Based on the fire frequency analysis, this value represents the fraction of time that a DPC is in the AO in the cask preparation room while diesel fuel is present.	Section 6.3, Table 6.3-11	DPC-7

Table 6.5-5. Basic Events Data Associated with Fire Analysis (Continued)

Basic Event (BE) ID	Basic Event Description	BE Value	Bases	References	Index Table 6.3-11
060-PROB-DIESEL--TC-PREP	Probability of DPC in TC & diesel in Cask Preparation Room	5.39E-02	Based on the fire frequency analysis, this value represents the fraction of time that a DPC is in the TC in the cask preparation room while diesel fuel is present.	Section 6.3, Table 6.3-11	DPC-5
060-PROB-DPC-AO-DIESEL	Probability of DPC in AO with diesel	3.10E-01	Based on the fire frequency analysis, this value represents the fraction of time that a DPC is in the AO while diesel fuel is present in a large fire.	Section 6.3, Table 6.3-11	DPC-12
060-PROB-DPC-IN-AO-LF	Probability DPC in AO in Large Fire	3.10E-01	Based on the fire frequency analysis, this value represents the fraction of time that a DPC is in the AO in a large fire.	Section 6.3, Table 6.3-11	DPC-12
060-PROB-DPC-IN-CTM	Probability DPC in CTM in Large Fire	2.59E-02	Based on the fire frequency analysis, this value represents the fraction of time that a DPC is in the CTM in a large fire.	Section 6.3, Table 6.3-11	DPC-13
060-PROB-DPC-IN-TC-LF	Probability DPC in TC in Large Fire	6.64E-01	Based on the fire frequency analysis, this value represents the fraction of time that a DPC is in the TC in a large fire.	Section 6.3, Table 6.3-11	DPC-10 + DPC11
060-PROB-DPC-TC-DIESEL	Probability of DPC in TC with diesel	4.38E-02	Based on the fire frequency analysis, this value represents the fraction of time that a DPC is in the TC while diesel fuel is present in a large fire.	Section 6.3, Table 6.3-11	DPC-10
060-PROB-DPC-TC-NODIES	Probability of DPC in TC without diesel	6.20E-01	Based on the fire frequency analysis, this value represents the fraction of time that a DPC is in the TC while diesel fuel is not present in a large fire.	Section 6.3, Table 6.3-11	DPC-11
060-PROB-DSTD-IN-CTM	Probability DOE Std. canister in CTM	3.27E-03	Based on the fire frequency analysis, this value represents the fraction of time that a DOE Std. canister is in the CTM in a large fire.	Section 6.3, Table 6.3-11	DSNF-9

Table 6.5-5. Basic Events Data Associated with Fire Analysis (Continued)

Basic Event (BE) ID	Basic Event Description	BE Value	Bases	References	Index Table 6.3-11
060-PROB-DSTD-IN-CTM-LF	Probability DOE Std. canister in CTM in Large Fire	3.27E-03	Based on the fire frequency analysis, this value represents the fraction of time that a DOE Std. canister is in the CTM in a large fire.	Section 6.3, Table 6.3-11	DSNF-9
060-PROB-DSTD-IN-STG-LF	Probability DOE Std. canister in Staging Area in Large Fire	8.99E-01	Based on the fire frequency analysis, this value represents the fraction of time that a DOE Std. canister is in the staging area in a large fire.	Section 6.3, Table 6.3-11	DSNF-10
060-PROB-DSTD-IN-TC-LF	Probability DOE Std. canister in TC in Large Fire	9.82E-02	Based on the fire frequency analysis, this value represents the fraction of time that a DOE Std. canister is in the TC in a large fire.	Section 6.3, Table 6.3-11	DSNF-7 + DSNF-8
060-PROB-DSTD-STAGING	Probability DOE Std. canister in Staging Area	8.99E-01	Based on the fire frequency analysis, this value represents the fraction of time that a DOE Std. canister is in the staging area in a large fire.	Section 6.3, Table 6.3-11	DSNF-10
060-PROB-DSTD-TC-DIES	Probability DOE Std. canister in TD with diesel Fire	6.14E-03	Based on the fire frequency analysis, this value represents the fraction of time that a DOE Std. canister is in a TC while diesel fuel is present in a large fire.	Section 6.3, Table 6.3-11	DSNF-7
060-PROB-DSTD-TC-NODIES	Probability DOE Std. canister in TC without diesel Fire	9.20E-02	Based on the fire frequency analysis, this value represents the fraction of time that a DOE Std. canister is in a TC while diesel fuel is not present in a large fire.	Section 6.3, Table 6.3-11	DSNF-8
060-PROB-HLW-IN-CTM-LF	Probability HLW in CTM in Large Fire	2.93E-02	Based on the fire frequency analysis, this value represents the fraction of time that a HLW canister is in the CTM in a large fire.	Section 6.3, Table 6.3-11	HLW-10
060-PROB-HLW-IN-TC-LF	Probability HLW in TC in Large Fire	7.22E-01	Based on the fire frequency analysis, this value represents the fraction of time that a HLW canister is in the TC in a large fire.	Section 6.3, Table 6.3-11	HLW-8 + HLW-9

Table 6.5-5. Basic Events Data Associated with Fire Analysis (Continued)

Basic Event (BE) ID	Basic Event Description	BE Value	Bases	References	Index Table 6.3-11
060-PROB-HLW-IN-WP-LF	Probability HLW in WP in Large Fire	2.49E-01	Based on the fire frequency analysis, this value represents the fraction of time that a HLW canister is in the WP in a large fire.	Section 6.3, Table 6.3-11	HLW-11
060-PROB-MCO-IN-CTM	Probability MCO in CTM	3.23E-02	Based on the fire frequency analysis, this value represents the fraction of time that a MCO is in the CTM. Data for MCO is the same as for the DOE Std. canister.	Section 6.3, Table 6.3-11	MCO-9
060-PROB-MCO-IN-CTM-LF	Probability MCO in CTM in Large Fire	3.23E-02	Based on the fire frequency analysis, this value represents the fraction of time that a MCO is in the CTM in a large fire. . Data for MCO is the same as for the DOE Std. canister.	Section 6.3, Table 6.3-11	MCO-9
060-PROB-MCO-IN-TC-LF	Probability MCO in TC in Large Fire	9.68E-01	Based on the fire frequency analysis, this value represents the fraction of time that a MCO is in the TC in a large fire. . Data for MCO is the same as for the DOE Std. canister.	Section 6.3, Table 6.3-11	MCO-7 + MCO-8
060-PROB-MCO-TC-DIES	Probability MCO in TC with diesel Fire	6.05E-02	Based on the fire frequency analysis, this value represents the fraction of time that a MCO is in the TC while diesel fuel is present in a large fire. Data for MCO is the same as for the DOE Std. canister.	Section 6.3, Table 6.3-11	MCO-7
060-PROB-MCO-TC-NODIES	Probability MCO in TC without diesel Fire	9.07E-01	Based on the fire frequency analysis, this value represents the fraction of time that a MCO is in the TC while diesel fuel is not present in a large fire. . Data for MCO is the same as for the DOE Std. canister.	Section 6.3, Table 6.3-11	MCO-8
060-PROB-NODIESEL-TC-CUR	Probability of DPC in TC without diesel in Cask Unloading Room	3.48E-01	Based on the fire frequency analysis, this value represents the fraction of time that a DPC is in the TC in the Cask Unloading Room while diesel fuel is not present.	Section 6.3, Table 6.3-11	DPC-3

Table 6.5-5. Basic Events Data Associated with Fire Analysis (Continued)

Basic Event (BE) ID	Basic Event Description	BE Value	Bases	References	Index Table 6.3-11
060-PROB-NODIESE-TC-PREP	Probability of DPC in TC & no diesel in Cask Preparation Room	4.84E-01	Based on the fire frequency analysis, this value represents the fraction of time that a DPC is in the TC in the Cask Preparation Room while diesel fuel is not present.	Section 6.3, Table 6.3-11	DPC-6
060-PROB-TAD-AO-CUR	Probability TAD canister in AO in Cask Unloading Room	5.20E-01	Based on the fire frequency analysis, this value represents the fraction of time that a TAD canister in an AO in the Cask Unloading Room.	Section 6.3, Table 6.3-11	TAD-2
060-PROB-TAD-AO-CURDIES	Probability TAD canister in AO in Cask Unloading Room with diesel Fire	5.20E-01	Based on the fire frequency analysis, this value represents the fraction of time that a TAD canister in an AO in the Cask Unloading Room while diesel fuel is present.	Section 6.3, Table 6.3-11	TAD-2
060-PROB-TAD-AO-DIES	Probability TAD canister in AO in Fire with diesel	7.42E-02	Based on the fire frequency analysis, this value represents the fraction of time that a TAD canister in an AO while diesel fuel is present in a large fire..	Section 6.3, Table 6.3-11	TAD-14
060-PROB-TAD-AO-PREP	Probability TAD canister in AO in Cask Preparation Room	3.55E-01	Based on the fire frequency analysis, this value represents the fraction of time that a TAD canister in an AO in the Cask Preparation Room.	Section 6.3, Table 6.3-11	TAD-7
060-PROB-TAD-CTM	Probability TAD canister in CTM in Fire	9.82E-03	Based on the fire frequency analysis, this value represents the fraction of time that a TAD canister is in the CTM in a large fire.	Section 6.3, Table 6.3-11	TAD-15
060-PROB-TAD-IN-AO-LF	Probability TAD canister in AO in Large Fire	7.51E-02	Based on the fire frequency analysis, this value represents the fraction of time that a TAD canister is in an AO in a large fire.	Section 6.3, Table 6.3-11	TAD-14
060-PROB-TAD-IN-CTM-LF	Probability TAD canister in CTM in Large Fire	9.94E-03	Based on the fire frequency analysis, this value represents the fraction of time that a TAD canister is in the CTM in large fire.	Section 6.3, Table 6.3-11	TAD-15

Table 6.5-5. Basic Events Data Associated with Fire Analysis (Continued)

Basic Event (BE) ID	Basic Event Description	BE Value	Bases	References	Index Table 6.3-11
060-PROB-TAD-IN-TC-LF	Probability TAD canister in TC in Large Fire	2.33E-01	Based on the fire frequency analysis, this value represents the fraction of time that a TAD canister is in the TC in large fire.	Section 6.3, Table 6.3-11	TAD-12 + TAD-13
060-PROB-TAD-IN-WP-LF	Probability TAD canister in WP in Large Fire	6.82E-01	Based on the fire frequency analysis, this value represents the fraction of time that a TAD canister is in the WP in large fire.	Section 6.3, Table 6.3-11	TAD-16 + TAD-17
060-PROB-TAD-TC-CUR	Probability TAD canister in TC in Cask Unloading Room	4.80E-01	Based on the fire frequency analysis, this value represents the fraction of time that a TAD canister is in the TC in the Cask Unloading Room.	Section 6.3, Table 6.3-11	TAD-3
060-PROB-TAD-TC-CURND	Probability TAD canister in TC without diesel Fire	4.80E-01	Based on the fire frequency analysis, this value represents the fraction of time that a TAD canister is in the TC in the Cask Unloading Room while diesel fuel is not present.	Section 6.3, Table 6.3-11	TAD-3
060-PROB-TAD-TC-DIESEL	Probability TAD canister in TC with diesel Fire	1.37E-02	Based on the fire frequency analysis, this value represents the fraction of time that a TAD canister is in the TC while diesel fuel is present in large fire.	Section 6.3, Table 6.3-11	TAD-12
060-PROB-TAD-TC-PREP	Probability TAD canister in TC in Cask Preparation Room	6.45E-01	Based on the fire frequency analysis, this value represents the fraction of time that a TAD canister is in the TC in the Cask Preparation Room.	Section 6.3, Table 6.3-11	TAD-5 + TAD-6
060-PROB-TAD-TC-WODIESEL	Probability TAD canister in TC in Fire without diesel	2.17E-01	Based on the fire frequency analysis, this value represents the fraction of time that a TAD canister is in the TC while diesel fuel is not present in large fire.	Section 6.3, Table 6.3-11	TAD-13
060-PROB-TAD-WP	Probability TAD canister in WP in Fire	1.14E-02	Based on the fire frequency analysis, this value represents the fraction of time that a TAD canister is in the WP in large fire.	Section 6.3, Table 6.3-11	TAD-16

Table 6.5-5. Basic Events Data Associated with Fire Analysis (Continued)

Basic Event (BE) ID	Basic Event Description	BE Value	Bases	References	Index Table 6.3-11
060-PROB-TAD-WPTT	Probability TAD canister in WPTT in Fire	6.74E-01	Based on the fire frequency analysis, this value represents the fraction of time that a TAD canister is in the WP in the WPTT in large fire.	Section 6.3, Table 6.3-11	TAD-17
060-SPMRC-DNSF-DIESEL	Probability of Fire in Cask Preparation Room with diesel	9.44E-02	Based on the fire frequency analysis, this value represents the fraction of time that a DOE Std. canister is in a TC in the Cask Preparation Room in a diesel fire.	Section 6.3, Table 6.3-11	DSNF-3
060-SPMRC-DNSF-WODIESEL	Probability of Fire in Cask Preparation Room without diesel	9.06E-01	Based on the fire frequency analysis, this value represents the fraction of time that a DOE Std. canister is in a TC in the Cask Preparation Room in a non-diesel fire.	Section 6.3, Table 6.3-11	DSNF-4
060-SPMRC-HLW-DIESEL	Fire in Cask Preparation Room SPMRC with diesel	9.09E-02	Based on the fire frequency analysis, this value represents the fraction of time that a HLW canister is in a TC in the Cask Preparation Room in a diesel fire.	Section 6.3, Table 6.3-11	HLW-3
060-SPMRC-HLW-WODIESEL	Fire in Cask Preparation Room SPMRC without diesel	9.09E-01	Based on the fire frequency analysis, this value represents the fraction of time that a HLW canister is in a TC in the Cask Preparation Room in a non-diesel fire.	Section 6.3, Table 6.3-11	HLW-4
060-SPMRC-MCO-DIESEL	Probability of Fire in Cask Preparation Room with diesel	9.44E-02	Based on the fire frequency analysis, this value represents the fraction of time that a MCO canister in a TC is in the Cask Preparation Room in a diesel fire. . Data for MCO is the same as for the DOE Std. canister.	Section 6.3, Table 6.3-11	MCO-3
060-SPMRC-MCO-WODIESEL	Probability of Fire in Cask Preparation Room without diesel	9.06E-01	Based on the fire frequency analysis, this value represents the fraction of time that a MCO canister in a TC is in the Cask Preparation Room in a non-diesel fire. . Data for MCO is the same as for the DOE Std. canister.	Section 6.3, Table 6.3-11	MCO-4

Table 6.5-5. Basic Events Data Associated with Fire Analysis (Continued)

Basic Event (BE) ID	Basic Event Description	BE Value	Bases	References	Index Table 6.3-11
060-SPMRC-TAD-DIESEL	Fire in Cask Preparation Room SPMRC with diesel	5.75E-02	Based on the fire frequency analysis, this value represents the fraction of time that a TAD canister in a TC is in the Cask Preparation Room in a diesel fire.	Section 6.3, Table 6.3-11	TAD-5
060-SPMRC-TAD-WODIES	Fire in Cask Preparation Room SPMRC without diesel	5.88E-01	Based on the fire frequency analysis, this value represents the fraction of time that a TAD canister in a TC is in the Cask Preparation Room in a non-diesel fire.	Section 6.3, Table 6.3-11	TAD-6
060-TADAO-CUR-DIESEL	Localized fire threatens TAD canister in Cask Unloading Room	2.50E-07	Localized Fire Threatens TAD canister in WP or TAD canister in AO (with diesel present) in Cask Unloading Room (diesel Present) in WP Loadout Room	Section 6.3, Table 6.3-11	TAD-1
060-TAD-AO-DIESEL	Fire in Cask Preparation Room with diesel - TAD canister in AO	3.55E-01	Based on the fire frequency analysis, this value represents the fraction of time that a TAD canister in an AO is in the Cask Preparation Room in a diesel fire.	Section 6.3, Table 6.3-11	TAD-7
060-TAD-CAN-CTM-FIRE	Localized fire threatens canister in the CTM	1.10E-07	Localized Fire Threatens TAD canister in CTM in Canister Transfer Room	Section 6.3, Table 6.3-11	TAD-10
060-TAD-FIRE-PREP-AREA	Probability of Fire Affecting TAD canister in Cask Preparation Room	8.17E-06	Localized Fire Threatens TC/TAD canister in Vestibule/Cask Preparation Room w/SPM (diesel Present), TC/TAD canister without SPM (No diesel Present), TAD canister in AO (diesel Present), and TC/TAD canister on CTT (No diesel Present).	Section 6.3, Table 6.3-11	TAD-4

Table 6.5-5. Basic Events Data Associated with Fire Analysis (Continued)

Basic Event (BE) ID	Basic Event Description	BE Value	Bases	References	Index Table 6.3-11
060-TAD-LARGE-FIRE	Large fire threatens TAD canister anywhere in CRCF	8.76E-05	Large Fire Threatens TC/TAD canister (diesel Present), TC/TAD canister (No diesel), TAD canister in AO (diesel Present), TAD canister in CTM, TAD canister in WP in WPTT, and TAD canister in WP in TEV	Section 6.3, Table 6.3-11	TAD-11
060-TAD-WP-LOADOUT-RM	Localized fire threatens TAD canister in WP in WP Loadout Room	9.20E-07	Localized Fire Threatens TAD canister in WP and TEV in WP Loadout Room	Section 6.3, Table 6.3-11	TAD-8
060-TAD-WP-POSIT-RM-FIRE	Localized fire threatens TAD canister in WP in WP Positioning Room	6.50E-05	Mean probability that a Localized Fire Threatens TAD canister in WP in WP Positioning/Closure Room	Section 6.3, Table 6.3-11	TAD-9

NOTE: AO = aging overpack; CRCF = Canister Receipt and Closure Facility; CTM = canister transfer machine; CTT = cask transfer trolley; DOE = U.S. Department of Energy; DPC = dual-purpose canister; HLW = high-level radioactive waste; MCO = multicanister overpack; SNF = spent nuclear fuel; SPM = site prime mover; SPMRC = site prime mover railcar; SPMTT = site prime mover truck trailer; TAD = transportation, aging, and disposal; TEV = transport and emplacement vehicle; TC transportation cask; VTC = a transportation cask that is upended on a railcar; WP = waste package; waste package transfer trolley.

Source: Original

6.6 NOT USED

6.7 EVENT SEQUENCE FREQUENCY RESULTS

This section provides the results of the event sequence quantification as produced from the SAPHIRE (Section 4.2) analyses. Quantification of an event sequence consists of calculating its number of occurrences over the preclosure period by combining the frequency of a single initiating event with the conditional probabilities of pivotal events that comprise the sequence. The quantification results are presented as an expression of the mean and median number of occurrences of each event sequence over the preclosure period, and the standard deviation as a measure of uncertainty. Section 6.8 describes the process for aggregation of similar event sequences to permit categorization as Category 1, Category 2, or beyond Category 2 event sequences.

The section presents a summary of how the quantification is performed by linking of event trees, fault trees, and basic event input parameters. The discussion includes the rationale for truncating low values and the analysis of uncertainties.

The results include a summary of all event sequences that are quantified and a table summarizing the results of the final quantification (found in Attachment G).

6.7.1 Process for Event Sequence Quantification

Internal event sequences that are based on the event trees presented in Section 6.1 and fault trees presented in Section 6.2 are quantified using SAPHIRE (Section 4.2). In SAPHIRE, the quantification of an event sequence is always labeled as a “frequency” in the output formats.

The event sequence quantification methodology is presented in Section 4.3.6. An event sequence frequency is the product of several factors, as follows (with examples):

- The number of times the operation or activity that gives rise to the event sequence is performed over the preclosure period, for example, the total number of transfers of a TAD canister by a CTM in the CRCF over the preclosure period. In SAPHIRE, this number is entered in the first event of the initiator event tree from which the event sequence arises or in the first event of the system-response event tree if no initiator event tree exists.
- The probability of occurrence of the initiating event for the event sequence considered. Continuing with the previous example, this could be the probability of dropping a TAD canister during its transfer by the CTM in the CRCF, or the probability of occurrence of a fire that could affect the TAD canister during its transfer by the CTM. The initiating event probability is modeled in SAPHIRE with a fault tree or with a basic event. In an initiator event tree, this probability is assigned on the branch associated with that initiating event, through the use of SAPHIRE rules (i.e., textual logic instructions that determine which fault tree or basic event is to be used). If no initiator event tree exists, this probability is entered in the second event of the system-response event tree.

- The conditional probability of each of the pivotal events of the event sequence, which appear in the system-response event tree. The pivotal event may represent a passive failure such as the breach of the containment boundary of the TAD canister or an active system failure such as the unavailability of the HVAC system. The conditional event probabilities of pivotal events are linked to the event sequence in SAPHIRE through the linkage to basic events in a fault tree that represents the pivotal event. The selection of pivotal event models and the associated basic event values may be determined by SAPHIRE rules.

Uncertainties in input parameters such as throughput rates, equipment failure rates, passive failure probabilities, and HFEs used to calculate basic event probabilities are propagated through the fault tree and event sequence logic to quantify the uncertainty in the event sequence quantification.

To quantify an event sequence, SAPHIRE (Section 4.2) first establishes the logic of the event sequence (i.e., the combination of individual successes and failures of pivotal events after the initiating event). SAPHIRE then links together the fault trees that support the initiating event and the pivotal events and uses Boolean logic to identify dependencies between the initiating event and the pivotal events and between pivotal events. SAPHIRE finally develops minimal cut sets for the event sequence considered. A minimal cut set for an event sequence is a Boolean reduced combination of a set of basic events that, if it occurs, will cause the event sequence to occur. The event sequence frequency is calculated as the sum of frequencies of the cut sets. No cutoff probability was used to ensure that event sequences are grouped properly.

As an illustration of the above process, the quantification of the event sequence initiated by a drop of a TAD canister during a transfer in the CRCF, followed by the breach of the canister, the subsequent failure of the HVAC confinement to perform its confinement and filtering function over its mission time, but no moderator entry into the canister, is outlined in the following paragraphs.

The event sequence, which leads to an unfiltered radionuclide release that is not important to criticality, starts with an initiator event tree that depicts the number of TAD canisters that are transferred by the CTM in the CRCF over the preclosure period. Based on *Waste Form Throughputs for Preclosure Safety Analysis* (Ref. 2.2.31, Table 4), there are 15,121 such transfers. Next, the branch on the initiator event tree that deals with the drop of a canister is selected. In practice, this is done by SAPHIRE through the use of rules, which are assigned to the pivotal event called "INIT-EVENT," the fault tree whose top event models the probability of a TAD canister drop. Multiplying the number of TAD canister transfers by the probability of a drop yields the number of occurrences, over the preclosure period, of the initiating event for the event sequence considered.

SAPHIRE (Section 4.2) continues the construction of event sequence logic via a transfer to the system-response event tree which provides the basis for quantifying the rest of the event sequence through the use of the pivotal events described in Section 6.1 and Attachment B. First, the breach of the canister, given its drop, is evaluated under the pivotal event called "CANISTER." SAPHIRE rules are used to ensure that the probability assigned to this pivotal event pertains to the waste form considered in this event sequence—a TAD canister. The next

pivotal event that appears in the system-response event tree is called “SHIELDING.” This pivotal event has a probability of one, indicating that a loss of shielding is considered to occur if the canister breaches. This modeling conforms to the approach taken in the PCSA, where event sequences that lead to a radionuclide release also embed direct exposure of personnel to radiation that could result from a LOS. The next pivotal event is called “CONFINEMENT.” This event models the failure of HVAC to maintain confinement and perform filtering of the radionuclide release. This pivotal event is quantified with a fault tree. The mission time for the system is 720 hours (i.e., 30 days). Finally, the last pivotal event is called “MODERATOR.” This event models moderator intrusion into the breached canister. In the event sequence analyzed, no moderator entry occurs, that is, the success branch is followed.

Two fault trees appear in this example event sequence: one models the drop of the canister and the other models the loss of the HVAC system. These fault trees are linked by SAPHIRE and a Boolean reduction is applied to identify dependencies (such as a loss of power, which is a contributor to both a load drop by the CTM and the loss of the HVAC system), and remove nonminimal cut sets.

The SAPHIRE event sequence quantification report includes the number of occurrences of each cut set that contributes to an event sequence, and the summation over the cut set to yield a number of occurrences of the event sequence over the preclosure period. The internal processes of SAPHIRE provides quantification of cut sets that represent combinations of basic events from respective initiating event trees and pivotal event trees, the summation over such cut sets represents the cumulative frequency of an initiating event (e.g., drop), containment (e.g., canister) breach, confinement unavailability, and moderator availability.

As noted, uncertainties in input parameters are propagated through the fault tree and event sequence logic to quantify the uncertainty in the event sequence quantification. The uncertainty analysis uses the Monte Carlo method that is built into SAPHIRE. Each event sequence was analyzed using 10,000 trials. The number of trials is considered sufficient to ensure accurate results for the distribution parameters.

6.7.2 Event Sequence Quantification Summary

Table G-1 of Attachment G presents the result of the event sequence quantification. Table G-1 summarizes the results of the final quantification and lists the following elements: (1) event tree from which the sequence is generated, (2) SAPHIRE event sequence designator, (3) initiating event description, (4) event sequence logic, (5) event sequence end state, (6) event sequence mean value, (7) event sequence median value, and (8) event sequence variance.

6.8 EVENT SEQUENCE GROUPING AND CATEGORIZATION

An aggregation grouping process is applied prior to a categorization of event sequences as was described in Section 4.3.1. It is appropriate for purposes of categorization, to add the frequencies of event sequences that are derived from the same ESD, that elicits the same combination of failure and success of pivotal events, and have the same end state. This is termed final event sequence quantification, discussed in Section 6.8.1, and the results give the final frequency of occurrence. Using the final frequency of occurrence, the event sequences are categorized

according to the definition of Category 1 and Category 2 event sequences given in 10 CFR 63.2 (Ref. 2.3.2). Dose consequences for Category 1 and Category 2 event sequences are subject to the performance objectives of 10 CFR 63.111 (Ref. 2.3.2), which is performed in *Preclosure Consequence Analyses* (Ref. 2.2.38). Event sequences with a frequency of occurrence less than one chance in 10,000 of occurring before permanent closure of the repository are designated as beyond Category 2 event sequences and are not analyzed for dose consequences.

Rather than calculate dose consequences for each Category 2 event sequence identified in the categorization process, dose consequences are performed for a set of bounding events that encompass the end states and material at risk for event sequences. Therefore, dose consequences are determined for a representative set of postulated Category 2 event sequences, identified in Table 6.8-1 (Ref. 2.2.38, Table 2 and Section 7). Because all waste form types and configurations that are applicable to the repository are included in Table 6.8.1, some of the bounding event sequences do not apply to the present analysis. Once event sequence categorization is complete, Category 2 event sequences are cross referenced with the bounding event number given in Table 6.8-1, thus ensuring that Category 2 event sequences have been evaluated for dose consequences and compared to the 10 CFR 63.111 (Ref. 2.3.2) performance objectives.

Table 6.8-1. Bounding Category 2 Event Sequences

Bounding Event Number	Affected Waste Form	Description of End State	Material At Risk
2-01	LLWF inventory and HEPA filters	Seismic event resulting in LLWF collapse and failure of HEPA filters and ductwork in other facilities.	HEPA filters LLWF inventory
2-02	HLW canister in transportation cask	Breach of sealed HLW canisters in a sealed transportation cask	5 HLW canisters
2-03	HLW canister	Breach of sealed HLW canisters in an unsealed waste package	5 HLW canisters
2-04	HLW canister	Breach of sealed HLW canister during transfer (one drops onto another)	2 HLW canisters
2-05*	Uncanistered commercial SNF in transportation cask	Breach of uncanistered commercial SNF in a sealed truck transportation cask in air	4 PWR or 9 BWR commercial SNF
2-06*	Uncanistered commercial SNF in pool	Breach of uncanistered commercial SNF in an unsealed truck transportation cask in pool	4 PWR or 9 BWR commercial SNF
2-07	DPC in air	Breach of a sealed DPC in air	36 PWR or 74 BWR commercial SNF
2-08*	DPC in pool	Breach of commercial SNF in unsealed DPC in pool	36 PWR or 74 BWR commercial SNF
2-09	TAD canister in air	Breach of a sealed TAD canister in air within facility	21 PWR or 44 BWR commercial SNF

Table 6.8-1. Bounding Category 2 Event Sequences (Continued)

Bounding Event Number	Affected Waste Form	Description of End State	Material At Risk
2-10*	TAD canister in pool	Breach of commercial SNF in unsealed TAD canister in pool	21 PWR or 44 BWR commercial SNF
2-11*	Uncanistered commercial SNF	Breach of uncanistered commercial SNF assembly in pool (one drops onto another)	2 PWR or 2 BWR commercial SNF
2-12*	Uncanistered commercial SNF	Breach of uncanistered commercial SNF in pool	1 PWR or 1 BWR commercial SNF
2-13*	Combustible and non combustible LLW	Fire involving LLWF inventory	Combustible and non combustible LLW
2-14*	Uncanistered commercial SNF in truck transportation cask	Breach of a sealed truck transportation cask due to a fire	4 PWR or 9 BWR commercial SNF

NOTE: BWR = boiling water reactor; DPC = dual-purpose canister; HEPA = high-efficiency particulate air; HLW = high-level radioactive waste; LLWF = Low-Level Waste Facility; PWR = pressurized water reactor; SNF = spent nuclear fuel; TAD = transportation, aging and disposal. Items marked with an asterisk (*) are not applicable to the CRCF.

Source: Ref. 2.2.38, Table 2

6.8.1 Event Sequence Grouping and Final Quantification

Event sequences are modeled to represent the GROA operations and SSCs. Accordingly, an event sequence is unique to a given operational activity in a given operational area, which is depicted in an ESD. When more than one initiating event (for example, the drop, collision, or other structural challenges that could affect the canister) share the same ESD (and therefore elicit the same pivotal events and the same end states), it may be necessary to quantify the event sequence for each initiating event individually because the conditional probabilities of the pivotal events depend on the specific initiating event. In such cases, the frequencies of event sequences that are represented in the same ESD, having the same path through the event tree, and having the same end state, are added together thus comprising an event sequence grouping.

For example, an ESD may show event sequences that could occur during the transfer of a canister from one container to another by the CTM in the CRCF. More than one initiating event (for example, the drop, collision, or other structural challenges that could affect the canister) may share the same ESD (and therefore elicit the same pivotal events and the same end states), but give rise to event sequences that are quantified for each initiating event because the conditional probabilities of their pivotal events depend on the specific initiating event.

By contrast, some ESDs indicate a single initiating event. Such initiating events may be composites of several individual initiating events, but because the conditional probabilities of pivotal events and the end states are the same for each of the constituents, the initiators are grouped before the event sequence quantification.

In the PCSA, event sequence grouping is performed for a given waste form configuration at the ESD level. The waste container configurations considered are as follows. Note that not all waste form configurations are applicable to the CRCF:

- Waste package
- Naval SNF canister, by itself or in a transportation cask (not applicable to CRCF)
- HLW canister, by itself or in a transportation cask
- DOE standardized canister, containing DOE owned SNF, by itself or in a transportation cask
- MCO, by itself or in a transportation cask
- TAD canister, by itself, in a transportation cask, or in an aging overpack
- DPC, by itself, in a transportation cask, or an aging overpack
- Transportation cask containing bare SNF assemblies (not applicable to CRCF)
- SNF assembly (handled in the pool of the WHF and not applicable to CRCF)
- Low-level waste (not applicable to CRCF).

In SAPHIRE (Ref. 2.2.80), the grouping of event sequences is carried out using textual instructions, designated as partitioning rules. Partitioning rules gather into a single end state the minimal cut sets from the relevant individual event sequences that need to be grouped together, and further apply a Boolean reduction to ensure that nonminimal cut sets are removed. The event sequence frequencies from this step comprise the final event sequence quantification.

An illustration of the grouping of event sequences is described in the following. The potential structural challenges to a given canister during its transfer by the CTM into the CRCF are partitioned among seven different initiating events such as canister drop, collision, drop of a heavy load on the canister, etc. The event sequences involving the canister are quantified separately seven times, once for each initiating event. After an initiating event, the event sequences that elicit the same system response and lead to the same end state (i.e., those event sequences that follow the same path on the system-response event tree) are grouped together for purposes of categorization. Thus, the seven individual event sequences initiated by a TAD canister drop, collision, etc., that eventually result in a specific end state (i.e., a filtered mitigated radionuclide release), are grouped together for the purposes of categorization as a single aggregated event sequence with a unique name termed the “event sequence group ID.” Since there are five different end states that can lead to exposure of personnel to radiation (i.e., result in

an end state other than “OK”), there are five aggregated event sequences involving the TAD canister, each having a unique name. The frequency of each of the five aggregated event sequences represents the sum of frequencies of the seven individual event sequences.

The uncertainties in the grouped event sequences are generated by SAPHIRE as described in Section 6.7. The logic of the grouped event sequences is applied to recalculate the output probability distribution from the input parameters such as throughput rates, equipment failure rates, passive failure probabilities, and HFEs used to calculate basic event probabilities. These probability distributions are propagated through the fault tree and event sequence logic to quantify the uncertainty in the event sequence quantification.

6.8.2 Event Sequence Categorization

Based on the resultant frequency of occurrence, the event sequences are categorized as Category 1 or Category 2, per the definitions in 10 CFR 63.2 (Ref. 2.3.2), or beyond Category 2. The categorization is done on the basis of the expected number of occurrences of each event sequence during the preclosure period. For purposes of this discussion, the expected number of occurrences of a given event sequence over the preclosure period is represented by the quantity m .

Some event sequences are not directly dependent on the duration of the preclosure period. For example, the expected number of occurrences of TAD canister drops in the CRCF over the preclosure period is essentially controlled, among other things, by the number of TAD canisters and the number of lifts of these canisters. The duration of the preclosure period is not directly relevant for this event sequence, but is implicitly built into the operations. In contrast, for other event sequences, time is a direct input. For example, seismically induced event sequences are evaluated over a period of time. In such cases, event sequences are evaluated and categorized for the time during which they are relevant.

Using the parameter m for a given event sequence, categorization is performed using the screening criteria set out in 10 CFR 63.2 (Ref. 2.3.2), as follows:

- Those event sequences that are expected to occur one or more times before permanent closure of the GROA are referred to as Category 1 event sequences (Ref. 2.3.2). Thus, a value of m greater than or equal to one means the event sequence is a Category 1 event sequence.
- Other event sequences that have at least one chance in 10,000 of occurring before permanent closure are referred to as Category 2 event sequences (Ref. 2.3.2). Thus, a value of m less than one but greater than or equal to 10^{-4} , means the event sequence is a Category 2 event sequence.

- A measure of the probability of occurrence of the event sequence over the preclosure period is given by a Poisson distribution that has a parameter taken equal to m . The probability, P , that the event sequence occurs at least one time before permanent closure is the complement to one that the event sequence occurs exactly zero times during the preclosure period. Using the Poisson distribution, $P = 1 - \exp(-m)$ (Ref. 2.2.12, p. A-3). A value of P greater than or equal to 10^{-4} implies the value of m is greater than or equal to $-\ln(1 - P) = -\ln(1 - 10^{-4})$, which is approximately equal to 10^{-4} . Thus, a value of m greater than or equal to 10^{-4} , but less than one, implies the corresponding event sequence is a Category 2 event sequence.
- Event sequences that have a value of m less than 10^{-4} are designated as beyond Category 2.

An uncertainty analysis is performed on m to determine the main characteristics of its associated probability distribution, specifically the mean 50th percentile (i.e., the median), and the standard deviation. The uncertainty analysis is performed in SAPHIRE (Section 4.2), using Monte Carlo with 10,000 samples as described in Section 4.3.6.2.

The calculations carried out to quantify an event sequence are performed using the full precision of the individual probability estimates that are used in the event sequence. However, the categorization of event sequences is based upon the expected number of occurrences over the preclosure period with one significant digit.

6.8.3 Final Event Sequence Quantification Summary

Initially, the results of the SAPHIRE event sequence gathering and quantification process are reported in a single table of all event sequences for the CRCF (Attachment G, Table G-2). Following the final categorization, the event sequences for the respective Category 2 (Table 6.8-3) and beyond Category 2 (Attachment G, Table G-3) are tabulated separately. There are no Category 1 (Table 6.8-2) events for the CRCF. As desired, other sorting may be performed. For example, event sequences that have end states important to criticality are tabulated separately (Attachment G, Table G-4). The format of the table headings and content are the same for each table as follows:

1. Event sequence group ID – assigned during the grouping process in SAPHIRE
2. End state – taken from the event tree.
3. Event sequence description – narrative to describe the initiating event(s) and pivotal events that are involved.
4. Material at risk – describes the quantity and type of waste form involved

5. Mean event sequence frequency (number of occurrences over the preclosure period).
6. Median event sequence frequency (number of occurrences over the preclosure period).
7. Standard deviation of the event sequence frequency (number of occurrences over the preclosure period).
8. Event sequence category – declaration of Category 1, Category 2, or Beyond Category 2.
9. Basis for categorization (e.g., categorization by mean frequency, or from sensitivity study for mean frequencies near a threshold as described in Section 4.3.6.2).
10. Consequence analysis – cross-reference to the bounding event number in the dose consequence analysis (Table 6.8-1) (Ref. 2.2.38, Table 2 and Section 7).

Table 6.8-2. Category 1 Final Event Sequences Summary

Event Sequence Group ID	End State	Description	Material-At-Risk	Mean	Median	Std. Dev	Event Sequence Category	Basis for Categorization	Consequence Analysis
None									

Source: Original.

Table 6.8-3. Category 2 Final Event Sequences Summary

Event Sequence Group ID ^a	End State	Description	Material-At-Risk ^b	Mean ^c	Median ^c	Std. Dev ^c	Event Sequence Cat.	Basis for Categorization	Consequence Analysis ^d
ESD18-DSTD-SEQ2	Direct exposure, loss of shielding	This event sequence represents a temporary loss of shielding during CTM operations, while a DOE standardized canister is being transferred. In this sequence there are no pivotal events.	1 DOE standardized canister	3.E-01	3.E-01	1.E-01	Category 2	Mean of distribution for number of occurrences of event sequence near a category threshold. Categorization confirmed by alternative distribution	N/A ^e
ESD19-WP-TAD-SEQ3	Direct exposure, loss of shielding	This event sequence represents a direct exposure during export of a waste package containing a TAD canister. In this event sequence there are no pivotal events.	1 TAD canister	2.E-01	9.E-02	5.E-01	Category 2	Mean of distribution for number of occurrences of event sequence near a category threshold. Categorization confirmed by alternative distribution	N/A ^e
ESD20-TAD-SEQ2-DE	Direct exposure, loss of shielding	This event sequence represents a thermal challenge to a TAD canister inside a transportation cask, due to a fire, resulting in a direct exposure from loss of shielding. In this sequence the canister remains intact, and the shielding fails.	1 TAD canister	2.E-01	2.E-01	7.E-02	Category 2	Mean of distribution for number of occurrences of event sequence near a category threshold. Categorization confirmed by alternative distribution	N/A ^e

Table 6.8-3. Category 2 Final Event Sequences Summary (Continued)

Event Sequence Group ID ^a	End State	Description	Material-At-Risk ^b	Mean ^c	Median ^c	Std. Dev ^c	Event Sequence Cat.	Basis for Categorization	Consequence Analysis ^d
ESD17-DPC-SEQ2	Direct exposure, loss of shielding	This event sequence represents a direct exposure during preparation activities of a transportation cask containing a DPC. In this sequence there are no pivotal events.	1 DPC	1.E-01	5.E-02	3.E-01	Category 2	Mean of distribution for number of occurrences of event sequence	N/A ^e
ESD18-TAD-SEQ2	Direct exposure, loss of shielding	This event sequence represents a temporary loss of shielding during CTM operations, while a TAD canister is being transferred. In this sequence there are no pivotal events.	1 TAD canister	1.E-01	1.E-01	2.E-02	Category 2	Mean of distribution for number of occurrences of event sequence	N/A ^e
ESD19-WP-H&D-SEQ3	Direct exposure, loss of shielding	This event sequence represents a direct exposure during export of a waste package containing a combination of a DOE standardized canister and HLW canisters. In this event sequence there are no pivotal events.	5 HLW canisters and 1 DOE standardized canister	9.E-02	4.E-02	2.E-01	Category 2	Mean of distribution for number of occurrences of event sequence	N/A ^e
ESD18-HLW-SEQ2	Direct exposure, loss of shielding	This event sequence represents a temporary loss of shielding during CTM operations, while an HLW canister is being transferred. In this sequence there are no pivotal events.	1 HLW canister	8.E-02	8.E-02	1.E-02	Category 2	Mean of distribution for number of occurrences of event sequence	N/A ^e

Table 6.8-3. Category 2 Final Event Sequences Summary (Continued)

Event Sequence Group ID ^a	End State	Description	Material-At-Risk ^b	Mean ^c	Median ^c	Std. Dev ^c	Event Sequence Cat.	Basis for Categorization	Consequence Analysis ^d
ESD10-WP-H&M-SEQ03-RRF	Filtered radionuclide release	This event sequence represents a structural challenge to a combination of MCOs and HLW canisters inside a waste package, during WPTT transfer to the Waste Package Positioning Room, resulting in a filtered radionuclide release. In this sequence a canister fails, the confinement boundary remains intact, and a moderator is excluded from entering the canister.	2 HLW canisters and 2 MCOs	7.E-02	4.E-02	9.E-02	Category 2	Mean of distribution for number of occurrences of event sequence	N/A ^{a and e}
ESD19-WP-TAD-SEQ2	Direct exposure, loss of shielding	This event sequence represents a direct exposure during assembly and closure of a waste package containing a TAD canister. In this event sequence there are no pivotal events.	1 TAD canister	6.E-02	3.E-02	1.E-01	Category 2	Mean of distribution for number of occurrences of event sequence	N/A ^e
ESD20-HLW-SEQ2-DE	Direct exposure, loss of shielding	This event sequence represents a thermal challenge to an HLW canister inside a transportation cask, due to a fire, resulting in a direct exposure from loss of shielding. In this sequence the canister remains intact, and the shielding fails.	5 HLW canisters	5.E-02	5.E-02	2.E-02	Category 2	Mean of distribution for number of occurrences of event sequence	N/A ^e

Table 6.8-3. Category 2 Final Event Sequences Summary (Continued)

Event Sequence Group ID ^a	End State	Description	Material-At-Risk ^b	Mean ^c	Median ^c	Std. Dev ^c	Event Sequence Cat.	Basis for Categorization	Consequence Analysis ^d
ESD19-WP-H&D-SEQ2	Direct exposure, loss of shielding	This event sequence represents a direct exposure during assembly and closure of a waste package containing a combination of a DOE standardized canister and HLW canisters. In this event sequence there are no pivotal events.	5 HLW canisters and 1 DOE standardized canister	2.E-02	1.E-02	5.E-02	Category 2	Mean of distribution for number of occurrences of event sequence	N/A ^e
ESD09-HLW-SEQ3-RRF	Filtered radionuclide release	This event sequence represents a structural challenge to an HLW canister, during canister transfer by a CTM, resulting in a filtered radionuclide release. In this sequence the canister fails, the confinement boundary remains intact, and a moderator is excluded from entering the canister.	2 HLW canisters	1.E-02	1.E-02	1.E-02	Category 2	Mean of distribution for number of occurrences of event sequence	2-04
ESD20-DSTD-SEQ2-DE	Direct exposure, loss of shielding	This event sequence represents a thermal challenge to a DOE standardized canister inside a transportation cask, due to a fire, resulting in a direct exposure from loss of shielding. In this sequence the canister remains intact, and the shielding fails.	9 DOE standardized canisters	1.E-02	1.E-02	4.E-03	Category 2	Mean of distribution for number of occurrences of event sequence	N/A ^e

Table 6.8-3. Category 2 Final Event Sequences Summary (Continued)

Event Sequence Group ID ^a	End State	Description	Material-At-Risk ^b	Mean ^c	Median ^c	Std. Dev ^c	Event Sequence Cat.	Basis for Categorization	Consequence Analysis ^d
ESD06-MCO-SEQ3-RRF	Filtered radionuclide release	This event sequence represents a structural challenge to an MCO inside a transportation cask, during CTT transfer to the Cask Unloading Room, resulting in a filtered radionuclide release. In this sequence the canister fails, the confinement boundary remains intact, and a moderator is excluded from entering the canister.	4 MCOs	1.E-02	7.E-03	1.E-02	Category 2	Mean of distribution for number of occurrences of event sequence	N/A ^a
ESD20-DPC-SEQ2-DE	Direct exposure, loss of shielding	This event sequence represents a thermal challenge to a DPC inside a transportation cask, due to a fire, resulting in a direct exposure from loss of shielding. In this sequence the canister remains intact, and the shielding fails.	1 DPC	9.E-03	9.E-03	3.E-03	Category 2	Mean of distribution for number of occurrences of event sequence	N/A ^e

Table 6.8-3. Category 2 Final Event Sequences Summary (Continued)

Event Sequence Group ID ^a	End State	Description	Material-At-Risk ^b	Mean ^c	Median ^c	Std. Dev ^c	Event Sequence Cat.	Basis for Categorization	Consequence Analysis ^d
ESD11-WP-H&M-SEQ03-RRF	Filtered radionuclide release	This event sequence represents a structural challenge to a combination of MCOs and HLW canisters inside a waste package, during waste package assembly and closure, resulting in a filtered radionuclide release. In this sequence a canister fails, the confinement boundary remains intact, and a moderator is excluded from entering the canister.	2 HLW canisters and 2 MCOs	7.E-03	6.E-03	3.E-03	Category 2	Mean of distribution for number of occurrences of event sequence	N/A ^a
ESD19-WP-H&M-SEQ3	Direct exposure, loss of shielding	This event sequence represents a direct exposure during export of a waste package containing a combination of MCOs and HLW canisters. In this event sequence there are no pivotal events.	2 HLW canisters and 2 MCOs	6.E-03	3.E-03	1.E-02	Category 2	Mean of distribution for number of occurrences of event sequence	N/A ^{a and e}
ESD18-MCO-SEQ2	Direct exposure, loss of shielding	This event sequence represents a temporary loss of shielding during CTM operations, while an MCO is being transferred. In this sequence there are no pivotal events.	1 MCO	4.E-03	4.E-03	6.E-04	Category 2	Mean of distribution for number of occurrences of event sequence	N/A ^{a and e}

Table 6.8-3. Category 2 Final Event Sequences Summary (Continued)

Event Sequence Group ID ^a	End State	Description	Material-At-Risk ^b	Mean ^c	Median ^c	Std. Dev ^c	Event Sequence Cat.	Basis for Categorization	Consequence Analysis ^d
ESD18-DPC-SEQ2	Direct exposure, loss of shielding	This event sequence represents a temporary loss of shielding during CTM operations, while a DPC is being transferred. In this sequence there are no pivotal events.	1 DPC	3.E-03	3.E-03	4.E-04	Category 2	Mean of distribution for number of occurrences of event sequence	N/A ^e
ESD20-MCO-SEQ2-DE	Direct exposure, loss of shielding	This event sequence represents a thermal challenge to an MCO inside a transportation cask, due to a fire, resulting in a direct exposure from loss of shielding. In this sequence the canister remains intact, and the shielding fails.	4 MCOs	3.E-03	3.E-03	1.E-03	Category 2	Mean of distribution for number of occurrences of event sequence	N/A ^{a and e}
ESD10-WP-H&M-SEQ05-RRU	Unfiltered radionuclide release	This event sequence represents a structural challenge to a combination of MCOs and HLW canisters inside a waste package, during WPTT transfer to the Waste Package Positioning Room, resulting in an unfiltered radionuclide release. In this sequence a canister fails, the confinement boundary fails, and a moderator is excluded from entering the canister.	2 HLW canisters and 2 MCOs	2.E-03	6.E-04	6.E-03	Category 2	Mean of distribution for number of occurrences of event sequence	N/A ^a

Table 6.8-3. Category 2 Final Event Sequences Summary (Continued)

Event Sequence Group ID ^a	End State	Description	Material-At-Risk ^b	Mean ^c	Median ^c	Std. Dev ^c	Event Sequence Cat.	Basis for Categorization	Consequence Analysis ^d
ESD09-MCO-SEQ3-RRF	Filtered radionuclide release	This event sequence represents a structural challenge to an MCO, during canister transfer by a CTM, resulting in a filtered radionuclide release. In this sequence the canister fails, the confinement boundary remains intact, and a moderator is excluded from entering the canister.	1 MCO and 1 HLW canister	2.E-03	2.E-03	2.E-03	Category 2	Mean of distribution for number of occurrences of event sequence	N/A ^a
ESD19-WP-H&M-SEQ2	Direct exposure, loss of shielding	This event sequence represents a direct exposure during assembly and closure of a waste package containing a combination of MCOs and HLW canisters. In this event sequence there are no pivotal events.	2 HLW canisters and 2 MCOs	2.E-03	7.E-04	3.E-03	Category 2	Mean of distribution for number of occurrences of event sequence	N/A ^{a and e}
ESD08-MCO-SEQ03-RRF	Filtered radionuclide release	This event sequence represents a structural challenge to an MCO, due to collision between two CTMs during canister transfer, resulting in a filtered radionuclide release. In this sequence the canister fails, the confinement boundary remains intact, and a moderator is excluded from entering the canister.	1 MCO and another canister	1.E-03	7.E-04	2.E-03	Category 2	Mean of distribution for number of occurrences of event sequence	N/A ^a

Table 6.8-3. Category 2 Final Event Sequences Summary (Continued)

Event Sequence Group ID ^a	End State	Description	Material-At-Risk ^b	Mean ^c	Median ^c	Std. Dev ^c	Event Sequence Cat.	Basis for Categorization	Consequence Analysis ^d
ESD20-MCO-SEQ5-RRU	Unfiltered radionuclide release	This event sequence represents a thermal challenge to an MCO, due to a fire, resulting in an unfiltered radionuclide release. In this sequence the canister fails, the confinement boundary fails, and a moderator is excluded from entering the canister.	4 MCOs	9.E-04	8.E-04	4.E-04	Category 2	Mean of distribution for number of occurrences of event sequence	N/A ^a
ESD05-TAD-SEQ2-DE	Direct exposure, loss of shielding	This event sequence represents a structural challenge to a TAD canister, during aging overpack preparation activities, resulting in a direct exposure from loss of shielding. In this sequence the canister remains intact, and the shielding fails.	1 TAD canister	5.E-04	2.E-04	1.E-03	Category 2	Mean of distribution for number of occurrences of event sequence	N/A ^e
ESD09-HLW-SEQ5-RRU	Unfiltered radionuclide release	This event sequence represents a structural challenge to an HLW canister, during canister transfer by a CTM, resulting in an unfiltered radionuclide release. In this sequence the canister fails, the confinement boundary fails, and a moderator is excluded from entering the canister.	2 HLW canisters	5.E-04	2.E-04	1.E-03	Category 2	Mean of distribution for number of occurrences of event sequence	2-04

Table 6.8-3. Category 2 Final Event Sequences Summary (Continued)

Event Sequence Group ID ^a	End State	Description	Material-At-Risk ^b	Mean ^c	Median ^c	Std. Dev ^c	Event Sequence Cat.	Basis for Categorization	Consequence Analysis ^d
ESD12-TAD-SEQ02-DE	Direct exposure, loss of shielding	This event sequence represents a structural challenge to a TAD canister inside an aging overpack, during aging overpack assembly and closure, resulting in a direct exposure from loss of shielding. In this sequence the canister remains intact, and the shielding fails.	1 TAD canister	4.E-04	1.E-04	1.E-03	Category 2	Mean of distribution for number of occurrences of event sequence	N/A ^e
ESD06-MCO-SEQ5-RRU	Unfiltered radionuclide release	This event sequence represents a structural challenge to an MCO inside a transportation cask, during CTT transfer to the Cask Unloading Room, resulting in an unfiltered radionuclide release. In this sequence the canister fails, the confinement boundary fails, and a moderator is excluded from entering the canister.	4 MCOs	4.E-04	1.E-04	1.E-03	Category 2	Mean of distribution for number of occurrences of event sequence	N/A ^a

Table 6.8-3. Category 2 Final Event Sequences Summary (Continued)

Event Sequence Group ID ^a	End State	Description	Material-At-Risk ^b	Mean ^c	Median ^c	Std. Dev ^c	Event Sequence Cat.	Basis for Categorization	Consequence Analysis ^d
ESD14-TAD-SEQ02-DE	Direct exposure, loss of shielding	This event sequence represents a structural challenge to a TAD canister inside an aging overpack, during transfer from Cask Unloading Room to Cask Preparation Room, resulting in a direct exposure from loss of shielding. In this sequence the canister remains intact, and the shielding fails.	1 TAD canister	3.E-04	6.E-05	4.E-03	Category 2	Mean of distribution for number of occurrences of event sequence	N/A ^e
ESD02-TAD-SEQ02-DE	Direct exposure, loss of shielding	This event sequence represents a structural challenge to a TAD canister inside an aging overpack, during receipt activities, resulting in a direct exposure from loss of shielding. In this sequence the canister remains intact, and the shielding fails.	1 TAD canister	3.E-04	7.E-05	2.E-03	Category 2	Mean of distribution for number of occurrences of event sequence	N/A ^e

Table 6.8-3. Category 2 Final Event Sequences Summary (Continued)

Event Sequence Group ID ^a	End State	Description	Material-At-Risk ^b	Mean ^c	Median ^c	Std. Dev ^c	Event Sequence Cat.	Basis for Categorization	Consequence Analysis ^d
ESD06-TAD-SEQ2-DE	Direct exposure, loss of shielding	This event sequence represents a structural challenge to a TAD canister inside a transportation cask or aging overpack, during CTT or site transporter transfer to the Cask Unloading Room, resulting in a direct exposure from loss of shielding. In this sequence the canister remains intact, and the shielding fails.	1 TAD canister	3.E-04	7.E-05	1.E-03	Category 2	Mean of distribution for number of occurrences of event sequence	N/A ^e
ESD16-TAD-SEQ02-DE	Direct exposure, loss of shielding	This event sequence represents a structural challenge to a TAD canister inside an aging overpack, during export activities, resulting in a direct exposure from loss of shielding. In this sequence the canister remains intact, and the shielding fails.	1 TAD canister	3.E-04	6.E-05	2.E-03	Category 2	Mean of distribution for number of occurrences of event sequence	N/A ^e

Table 6.8-3. Category 2 Final Event Sequences Summary (Continued)

Event Sequence Group ID ^a	End State	Description	Material-At-Risk ^b	Mean ^c	Median ^c	Std. Dev ^c	Event Sequence Cat.	Basis for Categorization	Consequence Analysis ^d
ESD11-WP-H&M-SEQ05-RRU	Unfiltered radionuclide release	This event sequence represents a structural challenge to a combination of MCOs and HLW canisters inside a waste package, during waste package assembly and closure, resulting in an unfiltered radionuclide release. In this sequence a canister fails, the confinement boundary fails, and a moderator is excluded from entering the canister.	2 HLW canisters and 2 MCOs	2.E-04	9.E-05	5.E-04	Category 2	Mean of distribution for number of occurrences of event sequence	N/A ^a
ESD09-TAD-SEQ3-RRF	Filtered radionuclide release	This event sequence represents a structural challenge to a TAD canister, during canister transfer by a CTM, resulting in a filtered radionuclide release. In this sequence the canister fails, the confinement boundary remains intact, and a moderator is excluded from entering the canister.	1 TAD canister	1.E-04	6.E-05	2.E-04	Category 2	Mean of distribution for number of occurrences of event sequence	2-09

Table 6.8-3. Category 2 Final Event Sequences Summary (Continued)

Event Sequence Group ID ^a	End State	Description	Material-At-Risk ^b	Mean ^c	Median ^c	Std. Dev ^c	Event Sequence Cat.	Basis for Categorization	Consequence Analysis ^d
--------------------------------------	-----------	-------------	-------------------------------	-------------------	---------------------	-----------------------	---------------------	--------------------------	-----------------------------------

NOTE: ^aThe expected number of occurrences, over the preclosure period, of event sequences involving MCOs may not lead to an acceptable categorization with regard to 10 CFR 63.111 (Ref. 2.3.2) performance objectives. Therefore, further investigation of these event sequences may be needed. As a consequence, the categorization of event sequences involving MCOs is considered to be preliminary and no bounding event number for consequence analyses is provided.

^bThe material at risk is, as relevant, based upon the nominal capacity of the waste form container involved in the event sequence under consideration, or accounts for the specific operation covered by the event sequence.

^cThe mean, median, and standard deviation displayed are for the number of occurrences, over the preclosure period, of the event sequence under consideration.

^dThe bounding event number provided in this column identifies the bounding Category 2 event sequence identified in Table 6.8-1 from Ref. 2.2.38, Table 2 that results in dose consequences that bound the event sequence under consideration.

^eBecause of the great distances to the locations of the offsite receptors, doses to members of the public from direct radiation after a Category 2 event sequence are reduced by more than 13 orders of magnitude to insignificant levels (*GROA External Dose Rate Calculation*, Ref. 2.2.25).

CTM = canister transfer machine; CTT = cask transfer trolley; DOE = U.S. Department of Energy; DPC = dual-purpose canister; HLW = high-level radioactive waste; MCO = multicanister overpack; RHS = remote handling system; ST = site transporter; TAD = transportation, aging, and disposal; TC = transportation cask; WP = waste package; WPTT = waste package transfer trolley.

Source: Original

6.9 IMPORTANT TO SAFETY STRUCTURES, SYSTEMS, AND COMPONENTS AND PROCEDURAL SAFETY CONTROL REQUIREMENTS

The results of the PCSA are used to define design bases for repository SSCs to prevent or mitigate event sequences that could lead to the release of radioactive material and/or result in radiological exposure of workers or the public. Potential releases of radioactive material are minimized to ensure resulting worker and public exposures to radiation are below the limits established by 10 CFR 63.111 Ref. 2.3.2. This strategy requires using prevention features in the repository design wherever reasonable. This strategy is implemented by performing the PCSA as an integral part of the design process in a manner consistent with a performance-based, risk-informed philosophy. This integral design approach ensures the ITS design features and operational controls are selected in a manner that ensures safety while minimizing design and operational complexity through the use of proven technology. Using this strategy, design rules are developed to provide guidance on the safety classification of SSCs. The following information is developed in order to implement this strategy:

- Essential safety functions needed to ensure worker and public safety
- SSCs relied upon to ensure essential safety functions
- Design criteria that will ensure that the essential safety functions will be performed with a high degree of reliability and margin of safety
- Administrative and procedural safety controls that, in conjunction with the repository design ensure operations are conducted within the limits of the PCSAs.

Section 6.9.1 identifies ITS SSCs and Section 6.9.2 identifies the procedural safety controls.

6.9.1 Important to Safety Structures, Systems, and Components

Table 6.9-1 contains the nuclear safety design bases for the CRCF ITS SSCs. The first three columns identify the ITS system or facility, subsystem and component. The fourth column identifies the safety function relied upon in the event sequence analysis. The fifth column provides the characteristics of the safety function (i.e. controlling parameter or value) that is demonstrated to occur or exist in the design. The sixth column provides an event sequence in which, the safety function and the characteristic is relied upon. The seventh column provides the source, usually a fault tree, for the controlling parameter or value.

6.9.2 Procedural Safety Controls

Procedural safety controls (PSCs) are the controls that are relied upon to limit or prevent potential event sequences or mitigate their consequences. For this analysis, all PSCs were derived to reduce the initiating event sequence to an acceptable level.

Table 6.9-2 lists the PSCs that are required to support the event sequence analysis and categorization. The event sequence column identifies a representative event sequence that relies upon the PSC.

Table 6.9-1 Preclosure Nuclear Safety Design Bases for the CRCF ITS SSCs

System or Facility (System Code)	Subsystem (As Applicable)	Component	Nuclear Safety Design Bases		Representative Affiliated Event Sequence (Sequence Number)	Source
			Safety Function	Controlling Parameters and Values		
Aging facility (AP)	Aging Handling / Cask Transfer	Site Transporter (170-HAT0-MEQ-00001)	Protect against ^a spurious movement	1. The mean probability of spurious movement of the ST while a canister is being lifted or lowered shall be less than 1E-9 ^b per transfer.	CRCF-ESD09-TAD (Seq. 4-3)	060-9-ST-SPURMOVE
			Limit speed	2. The speed of the site transporter shall be limited to 2.5 mi/hr.	CRCF-ESD06-TAD (Seq. 4-4)	This parameter limits the conditional probability of cask breach given a collision to the appropriate value from Table 6.3-7.
			Preclude a cask breach due to explosion	3. The site transporter fuel tank shall preclude fuel tank explosions.	Initiating event does not require further analysis ^c .	Table 6.0-2.
			Reduce severity of a drop	4. The site transporter shall preclude a drop of an aging overpack from a height greater than 3 ft measured from the equipment base.	CRCF-ESD16-DPC (Seq. 3-3)	This parameter limits the conditional probability of canister breach given a drop to the appropriate value from Table 6.3-7.
	Aging Handling/Aging Overpack	Aging Overpack (TAD: [170-HAC0-ENCL-00003]) DPC:[170-HAC0-INCL-00002])	Protect against direct exposure to personnel ^a	5. The mean conditional probability of loss of shielding of the aging overpack resulting from an impact or collision shall be less than or equal to 1E-5 per impact.	CRCF-ESD02-TAD (Seq. 2-2)	AO-SHIELDING
				6. The mean conditional probability of loss of shielding of the aging overpack resulting from a drop at the equipment base shall be less than or equal to 5E-6 per drop.	CRCF-ESD16-TAD (Seq. 3-2)	AO-SHIELDING

(Vertical

Table 6.9-1. Preclosure Nuclear Safety Design Bases for the CRCF ITS SSCs (Continued)

System or Facility (System Code)	Subsystem (As Applicable)	Component	Nuclear Safety Design Bases		Representative Affiliated Event Sequence (Sequence Number)	Source
			Safety Function	Controlling Parameters and Values		
Canister Receipt and Closure Facility (CR)	Canister Receipt and Closure Facility (CRCF)	Shield doors (including anchorages) and equipment confinement doors	Protect against ^a direct exposure of personnel	7. Equipment and personnel shield doors shall have a mean probability of inadvertent opening less than or equal to 1E-7 per waste container handled.	CRCF-ESD18-TAD (Seq. 2)	060-18-SHLDDR-DIRCT-EXP
			Preclude collapse onto waste containers	8. An equipment shield door falling onto a waste container as a result of impact from a conveyance shall be precluded.	Initiating event does not require further analysis ^c	Table 6.0-2
			Mitigate the consequences of radionuclide release	9. The mean probability that the HVAC system in the CRCF confinement areas becomes unavailable (during a 30-day mission time following a radionuclide release) due to the simultaneous opening of an equipment confinement door and a cask unloading room shield door, shall be less than or equal to 3E-07.	CRCF-ESD09-TAD (Seq. 3-5)	VESTIBULE-DOORS-OPEN
		DOE Canister Slide Gates (060-HTC0-HTCH-00005, 6, 7, 8, 9)	Protect against ^a dropping a canister due to a spurious closure of the slide gate	10. The mean probability of a canister drop resulting from a spurious closure of the slide gate shall be less than or equal to 2E-6 per transfer.	CRCF-ESD09-DSTD (Seq. 3-3)	GATE-36-109 OF CTM-DROP---ALL-HEIGHTS
			Protect against ^a direct exposure to personnel	11. The mean probability of occurrence of an inadvertent opening of a slide gate shall be less than or equal to 4E-9 per transfer.	CRCF-ESD18-DSTD (Seq. 2)	060-18-SLIDE-GATE-DIR-EX

Table 6.9-1. Preclosure Nuclear Safety Design Bases for the CRCF ITS SSCs (Continued)

System or Facility (System Code)	Subsystem (As Applicable)	Component	Nuclear Safety Design Bases		Representative Affiliated Event Sequence (Sequence Number)	Source
			Safety Function	Controlling Parameters and Values		
			Preclude canister breach	12. Closure of the slide gate shall be incapable of breaching a canister.	Initiating event does not require further analysis ^c	Table 6.0-2
		Cask port slide gates (060-HTC0-HTCH-00001, 2)	Protect against ^a dropping a canister due to a spurious closure of the slide gate	13. The mean probability of a canister drop resulting from a spurious closure of the slide gate shall be less than or equal to 2E-6 per transfer.	CRCF-ESD09-HLW (Seq. 3-3)	GATE-36-109 OF CTM-DROP---ALL-HEIGHTS
			Protect against ^a direct exposure to personnel	14. The mean probability of occurrence of an inadvertent opening of a slide gate shall be less than or equal to 4E-9 per transfer.	CRCF-ESD18-TAD (Seq. 2)	060-18-SLIDE-GATE-DIR-EX
			Preclude canister breach	15. Closure of the slide gate shall be incapable of breaching a canister.	Initiating event does not require further analysis ^c	Table 6.0-2
		TAD canister slide gates (060-HTC0-HTCH-00010, 11)	Protect against ^a dropping a canister due to a spurious closure of the slide gate	16. The mean probability of a canister drop resulting from a spurious closure of the slide gate shall be less than or equal to 2E-6 per transfer.	CRCF-ESD09-TAD (Seq. 3-3)	GATE-36-109 OF CTM-DROP---ALL-HEIGHTS
			Protect against ^a direct exposure to personnel	17. The mean probability of occurrence of an inadvertent opening of a slide gate shall be less than or equal to 4E-9 per transfer.	CRCF-ESD18-TAD (Seq. 2)	060-18-SLIDE-GATE-DIR-EX
			Preclude canister breach	18. Closure of the slide gate shall be incapable of breaching a canister.	Initiating event does not require further analysis ^c	Table 6.0-2

Table 6.9-1. Preclosure Nuclear Safety Design Bases for the CRCF ITS SSCs (Continued)

System or Facility (System Code)	Subsystem (As Applicable)	Component	Nuclear Safety Design Bases		Representative Affiliated Event Sequence (Sequence Number)	Source
			Safety Function	Controlling Parameters and Values		
		Waste package port slide gates (060-HTC0-HTCH-00003, 4)	Protect against ^a dropping a canister due to a spurious closure of the slide gate	19. The mean probability of a canister drop resulting from a spurious closure of the slide gate shall be less than or equal to 2E-6 per transfer.	CRCF-ESD09-HLW (Seq. 3-3)	GATE-36-109 OF CTM-DROP---ALL-HEIGHTS
			Protect against ^a direct exposure to personnel	20. The mean probability of occurrence of an inadvertent opening of a slide gate shall be less than or equal to 4E-9 per transfer.	CRCF-ESD18-TAD (Seq. 2)	060-18-SLIDE-GATE-DIR-EX
			Preclude canister breach	21. Closure of the slide gate shall be incapable of breaching a canister.	Initiating event does not require further analysis ^c	Table 6.0-2
			Preclude canister drop onto floor	22. The waste package port slide gate shall be incapable of opening without a waste package transfer trolley with waste package in position to receive a canister.	Initiating event does not require further analysis ^c	Table 6.0-2
DOE and commercial waste package system (DS)	DOE and commercial waste package	Entire	Provide containment	23. The mean conditional probability of breach of a sealed waste package resulting from a side impact shall be less than or equal to 1E-08 per drop.	CRCF-ESD13-WP-TAD (Seq. 2-4)	13-WP_FAIL_COLLISION
				24. The mean conditional probability of breach of a sealed waste package resulting from a drop of a load onto the waste package shall be less than or equal to 1E-05 per drop.	CRCF-ESD15-WP-TAD (Seq. 3-4)	15-WP_FAIL_DROPON

Table 6.9-1. Preclosure Nuclear Safety Design Bases for the CRCF ITS SSCs (Continued)

System or Facility (System Code)	Subsystem (As Applicable)	Component	Nuclear Safety Design Bases		Representative Affiliated Event Sequence (Sequence Number)	Source
			Safety Function	Controlling Parameters and Values		
				25. The mean conditional probability of breach of a sealed waste package resulting from an end-on impact or collision shall be less than or equal to 1E-05 per impact.	CRCF-ESD15-WP-TAD (Seq. 3-4)	15-WP_FAIL_COLLISION
	Defense high-level waste/DOE SNF codisposal	DOE Standardized canister	Provide containment	26. The mean conditional probability of breach of a DOE standardized canister resulting from a drop of the canister shall be less than or equal to 1E-5 per drop.	CRCF-ESD09-DSTD (Seq. 3-3)	09-DSTD-FAIL-DROP
27. The mean conditional probability of breach of a DOE standardized canister resulting from a drop of a load onto the canister shall be less than or equal to 1E-5 per drop.				CRCF-ESD09-DSTD (Seq. 6-3)	09-DSTD-FAIL-DROPON	
28. The mean conditional probability of breach of a DOE standardized canister resulting from a side impact or collision shall be less than or equal to 1E-8 per impact.				CRCF-ESD10-WP-H&D (Seq. 3-3)	10-H&D-FAIL-WPTT-COLLIDE	
29. The mean conditional probability of breach of a DOE standardized canister contained within a waste package resulting from the spectrum of fires shall be less than or equal to 3E-4 per fire event.				CRCF-ESD20-WP-H&D (Seq. 3-3)	060-H&D-WP-CAN-FAIL-LOR	

Table 6.9-1. Preclosure Nuclear Safety Design Bases for the CRCF ITS SSCs (Continued)

System or Facility (System Code)	Subsystem (As Applicable)	Component	Nuclear Safety Design Bases		Representative Affiliated Event Sequence (Sequence Number)	Source
			Safety Function	Controlling Parameters and Values		
				30. The mean conditional probability of breach of a DOE standardized canister contained within a transportation cask or staging area resulting from the spectrum of fires shall be less than or equal to 2E-6 per fire event.	CRCF-ESD20-DSTD (Seq. 5-5)	060-DSTD-FAIL-TC-DIESEL; 060-DSTD-FAIL-TC-NODIES; 060-FAIL-DSTD-SA
				31. The mean conditional probability of breach of a DOE standardized canister located within the CTM Shield Bell resulting from the spectrum of fires shall be less than or equal to 1E-4 per fire event.	CRCF-ESD20-DSTD (Seq. 5-5)	060-DSTD-FAIL-CTM
				32. The mean conditional probability of breach of a DOE standardized canister, given the drop of an HLW canister onto the DOE standardized canister, shall be less than or equal to 1E-5 per drop.	CRCF-ESD09-DSTD (Seq. 6-3)	09-DSTD-FAIL-DROPON
				33. The mean conditional probability of breach of a DOE standardized canister, given the drop of another DOE standardized canister onto the first canister, shall be less than or equal to 1E-5 per drop.	CRCF-ESD09-DSTD (Seq. 6-3)	09-DSTD-FAIL-DROPON
		HLW canister	Provide containment	34. The mean conditional probability of breach of a HLW canister resulting from a drop of the canister shall be less than or equal to 3E-2 per drop.	CRCF-ESD09-HLW (Seq. 3-3)	09-HLW-FAIL-DROP

Table 6.9-1. Preclosure Nuclear Safety Design Bases for the CRCF ITS SSCs (Continued)

System or Facility (System Code)	Subsystem (As Applicable)	Component	Nuclear Safety Design Bases		Representative Affiliated Event Sequence (Sequence Number)	Source
			Safety Function	Controlling Parameters and Values		
				35. The mean conditional probability of breach of a HLW canister resulting from a drop of a load onto the canister shall be less than or equal to 3E-2 per drop	CRCF-ESD09-HLW (Seq. 6-3)	09-HLW-FAIL-DROPON
				36. The mean conditional probability of breach of a HLW canister resulting from a side impact or collision shall be less than or equal to 1E-8 per impact.	CRCF-ESD10-WP-H&D (Seq. 3-3)	10-H&D-FAIL-WPTT-COLLIDE
				37. The mean conditional probability of breach of a HLW canister contained within a waste package resulting from the spectrum of fires shall be less than or equal to 3E-4 per fire event.	CRCF-ESD20-WP-H&D (Seq. 3-3)	060-H&D-WP-CAN-FAIL-LOR
				38. The mean conditional probability of breach of a HLW canister contained within a transportation cask resulting from the spectrum of fires shall be less than or equal to 2E-6 per fire event.	CRCF-ESD20-HLW (Seq. 5-5)	060-HLW-CAN-FAIL-WD; 060-HLW-CAN-FAIL-WOD
				39. The mean conditional probability of breach of a HLW canister located within the CTM Shield Bell resulting from the spectrum of fires shall be less than or equal to 1E-4 per fire event.	CRCF-ESD20-HLW (Seq. 5-5)	060-HLW-CTM-FAIL

Table 6.9-1. Preclosure Nuclear Safety Design Bases for the CRCF ITS SSCs (Continued)

System or Facility (System Code)	Subsystem (As Applicable)	Component	Nuclear Safety Design Bases		Representative Affiliated Event Sequence (Sequence Number)	Source
			Safety Function	Controlling Parameters and Values		
				40. The mean conditional probability of breach of an HLW canister, given the drop of a DOE standardized canister onto the HLW canister, shall be less than or equal to 3E-2 per drop.	CRCF-ESD09-HLW (Seq. 6-3)	09-HLW-FAIL-DROPON
				41. The mean conditional probability of breach of an HLW canister, given the drop of another HLW canister onto the first canister, shall be less than or equal to 3E-2 per drop.	CRCF-ESD09-HLW (Seq. 6-3)	09-HLW-FAIL-DROPON
	Canistered spent nuclear fuel	Dual-purpose canister (analyzed as a representative canister)	Provide containment	42. The mean conditional probability of breach of a representative canister resulting from a drop of the canister shall be less than or equal to 1E-5 per drop.	CRCF-ESD09-DPC (Seq. 3-3)	09-CAN-FAIL-DROP
				43. The mean conditional probability of breach of a canister resulting from a drop of a load onto the canister shall be less than or equal to 1E-5 per drop.	CRCF-ESD09-DPC (Seq. 6-3)	09-CAN-FAIL-DROPON
				44. The mean conditional probability of breach of a canister resulting from a side impact or collision shall be less than or equal to 1E-8 per impact	CRCF-ESD14-DPC (Seq. 2-3)	14-DPC_ST-COLLISION

Table 6.9-1. Preclosure Nuclear Safety Design Bases for the CRCF ITS SSCs (Continued)

System or Facility (System Code)	Subsystem (As Applicable)	Component	Nuclear Safety Design Bases		Representative Affiliated Event Sequence (Sequence Number)	Source
			Safety Function	Controlling Parameters and Values		
				45. The mean conditional probability of breach of a canister contained within a cask resulting from the spectrum of fires shall be less than or equal to 2E-6 per fire event.	CRCF-ESD20-DPC (Seq. 5-5)	060-DPC-TC-FAIL-DIES; 060-DPC-TC-FAIL-NODIES
				46. The mean conditional probability of breach of a canister contained within an aging overpack resulting from the spectrum of fires shall be less than or equal to 1E-6 per fire event.	CRCF-ESD20-DPC (Seq. 5-5)	060-DPC-AO-FAIL-DIES
				47. The mean conditional probability of breach of a canister located within the CTM Shield Bell resulting from the spectrum of fires shall be less than or equal to 1E-4 per fire event.	CRCF-ESD20-DPC (Seq. 4-3)	060-DPC-CTM-CAN-FAIL
		TAD canister (analyzed as a representative canister)	Provide containment	48. The mean conditional probability of breach of a canister resulting from a drop of the canister shall be less than or equal to 1E-5 per drop.	CRCF-ESD09-TAD (Seq. 3-3)	09-CAN-FAIL-DROP
				49. The mean conditional probability of breach of a canister resulting from a drop of a load onto the canister shall be less than or equal to 1E-5 per drop.	CRCF-ESD11-WP-TAD (Seq. 3-3)	11-CAN-FAIL-WP-DROPON

Table 6.9-1. Preclosure Nuclear Safety Design Bases for the CRCF ITS SSCs (Continued)

System or Facility (System Code)	Subsystem (As Applicable)	Component	Nuclear Safety Design Bases		Representative Affiliated Event Sequence (Sequence Number)	Source
			Safety Function	Controlling Parameters and Values		
				50. The mean conditional probability of breach of a canister resulting from a side impact or collision shall be less than or equal to 1E-8 per impact	CRCF-ESD06-TAD (Seq. 4-3)	06-TAD-FAIL-CTT-COLLIDE
				51. The mean conditional probability of breach of a canister contained within a waste package cask resulting from the spectrum of fires shall be less than or equal to 3E-4 per fire event.	CRCF-ESD20-TAD (Seq. 7-5)	060-TAD-WP-FAIL
				52. The mean conditional probability of breach of a canister contained within a cask resulting from the spectrum of fires shall be less than or equal to 2E-6 per fire event.	CRCF-ESD20-TAD (Seq. 7-5)	060-TAD-TC-FAIL-DIESEL; 060-TAD-TC-FAIL-WODIESEL
				53. The mean conditional probability of breach of a canister located within the aging overpack resulting from the spectrum of fires shall be less than or equal to 1E-6 per fire event.	CRCF-ESD20-TAD (Seq. 7-5)	060-TAD-AO-FAIL-DIESEL
				54. The mean conditional probability of breach of a canister located within the CTM Shield Bell resulting from the spectrum of fires shall be less than or equal to 1E-4 per fire event.	CRCF-ESD20-TAD (Seq. 7-5)	060-TAD-CTM-FAIL

Table 6.9-1. Preclosure Nuclear Safety Design Bases for the CRCF ITS SSCs (Continued)

System or Facility (System Code)	Subsystem (As Applicable)	Component	Nuclear Safety Design Bases		Representative Affiliated Event Sequence (Sequence Number)	Source
			Safety Function	Controlling Parameters and Values		
Electrical power system (EE)	ITS power	ITS Distribution (Feeders Up to and including ITS loads, ITS Direct Current Power, ITS uninterruptible power supply power)	Provide electrical power to ITS surface nuclear confinement HVAC systems	55. The mean conditional probability for ITS electrical power distribution failure, given the loss of offsite power, shall be less than or equal to 7E-3 over a period of 720 hours following a radionuclide release.	CRCF-ESD11-WP-H&M (Seq. 3-3)	ITS-EP-FAILURE-FEEDERS
		ITS diesel generators (including ITS diesel generator fuel oil system, ITS diesel generator air start system, ITS diesel generator jacket water cooling system, ITS diesel generator lubricating oil system, ITS diesel generator air intake and exhaust system.)	Provide electrical power to ITS surface nuclear confinement HVAC systems	56. The mean conditional probability for ITS electrical power failure, given the loss of offsite power, shall be less than or equal to 3E-1 over a period of 720 hours following a radionuclide release.	CRCF-ESD11-WP-H&M, (Seq. 3-3)	ITS-EP-FAILURE

Table 6.9-1. Preclosure Nuclear Safety Design Bases for the CRCF ITS SSCs (Continued)

System or Facility (System Code)	Subsystem (As Applicable)	Component	Nuclear Safety Design Bases		Representative Affiliated Event Sequence (Sequence Number)	Source
			Safety Function	Controlling Parameters and Values		
Fire protection system (FP)	Fire suppression	Preaction valves, sprinkler heads, and system actuation panels associated with double-interlock preaction suppression systems that protect areas where there is a potential for canister breach	Maintain moderator control	57. The mean probability of inadvertent introduction of fire suppression water into a canister shall be less than or equal to 1E-6 over a 720-hour period following a radionuclide release.	CRCF-ESD09-TAD (Seq. 3-4)	060-FIRE-SUPPRESSION
	Fire detection	Fire detection system for the ITS preaction valves with associated detectors and control box	Maintain moderator control	58. The mean probability of inadvertent introduction of fire suppression water into a canister shall be less than or equal to 1E-6 over a 720-hour period following a radionuclide release.	CRCF-ESD09-TAD (Seq. 3-4)	060-FIRE-SUPPRESSION
Mechanical handling system (H)	Cask handling	Transportation cask (analyzed as a representative cask)	Provide containment	59. The mean conditional probability of breach of a canister in a sealed transportation cask resulting from a drop shall be less than or equal to 1E-5 per drop.	CRCF-ESD04-TAD (Seq. 3-4)	04-TCASK_IMPACT_TIP
				60. The mean conditional probability of breach of a canister in a sealed transportation cask resulting from a drop of a load onto the cask shall be less than or equal to 1E-5 per drop.	CRCF-ESD03-TAD, Seq. 6-4	03-TCASK-DROPON

Table 6.9-1. Preclosure Nuclear Safety Design Bases for the CRCF ITS SSCs (Continued)

System or Facility (System Code)	Subsystem (As Applicable)	Component	Nuclear Safety Design Bases		Representative Affiliated Event Sequence (Sequence Number)	Source
			Safety Function	Controlling Parameters and Values		
			Protect against ^a direct exposure to personnel	61. The mean conditional probability of breach of a canister in a sealed transportation cask resulting from a side impact or collision shall be less than or equal to 1E-08 per impact.	CRCF-ESD04-TAD (Seq. 4-4)	04-TCASK_SIMPACT
				62. The mean conditional probability of loss of cask gamma shielding of a representative transportation cask resulting from a drop of a cask shall be less than or equal to 1E-5 per drop.	CRCF-ESD04-TAD (Seq. 3-2)	CASK-SHIELD-LEAD-DP
				63. The mean conditional probability of loss of cask gamma shielding resulting from a collision or side impact to a cask shall be less than or equal to 1E-8 per impact.	CRCF-ESD04-TAD (Seq. 4-2)	CASK-SHIELD-LEAD
			Preclude lid contact with canister	64. The mean conditional probability of loss of cask gamma shielding resulting from a drop of a load onto a cask shall be less than or equal to 1E-5 per impact	CRCF-ESD03-TAD (Seq. 6-2)	CASK-SHIELD-LEAD-DP
				65. The geometry of the casks that carry DOE standardized canisters or HLW canisters shall preclude lid contact with canisters following a drop of a cask lid.	Initiating event does not require further analysis ^c	Table 6.0-2

Table 6.9-1. Preclosure Nuclear Safety Design Bases for the CRCF ITS SSCs (Continued)

System or Facility (System Code)	Subsystem (As Applicable)	Component	Nuclear Safety Design Bases		Representative Affiliated Event Sequence (Sequence Number)	Source
			Safety Function	Controlling Parameters and Values		
		Site Prime Mover	Limit speed	66. The speed of the site prime mover shall be limited to 9 mi/hr.	CRCF-ESD01-HLW (Seq. 4-4)	This parameter limits the conditional probability of cask breach given a collision to the appropriate value from Table 6.3-7.
			Preclude fuel tank explosion	67. The fuel tank of a site prime mover shall preclude fuel tank explosions	Initiating event does not require further analysis ^c	Table 6.0-2
		Cask handling yoke (060-HM00-BEAM-00001)	Protect against ^a drop	68. The cask handling yoke is an integral part of the load-bearing path. See "Cask Handling Crane" requirements.	See "Cask Handling Crane" requirements.	See "Cask Handling Crane" requirements.
		Cask handling crane; 200-ton (060-HM00-CRN-00001)	Protect against ^a drop	69. The mean probability of dropping a loaded cask from a less than the two-block height resulting from the failure of a piece of equipment within the load-bearing path shall be less than or equal to 3E-5 per transfer with the cask yoke or 1E-4 per transfer with a sling.	CRCF-ESD03-TAD (Seq. 2-4) (yoke) CRCF-ESD03-DPC (Seq. 2-4) (sling)	060-CRN2-DROPTAD-CRN-DRP (yoke) 060-CRN2-DROPDPC-CRS-DRP (sling)
			Protect against ^a drop	70. The mean probability of dropping a loaded cask from a two-block height resulting from the failure of a piece of equipment within the load-bearing path shall be less than or equal to 4E-7 per transfer.	CRCF-ESD03-TAD (Seq. 7-4)	060-CRN2-2-BLOCK-CRN-TBK

Table 6.9-1. Preclosure Nuclear Safety Design Bases for the CRCF ITS SSCs (Continued)

System or Facility (System Code)	Subsystem (As Applicable)	Component	Nuclear Safety Design Bases		Representative Affiliated Event Sequence (Sequence Number)	Source
			Safety Function	Controlling Parameters and Values		
			Limit drop height	71. The two-block drop height shall not exceed 30 feet from bottom of the shortest cask to the floor.	CRCF-ESD03-TAD, Seq. 7-4	This parameter limits the conditional probability of cask breach given a collision to the appropriate value from Table 6.3-7.
			Protect against ^a drop of a load onto a cask	72. The mean probability of dropping a load onto a loaded cask or its contents shall be less than or equal to 4E-5 per cask handled.	CRCF-ESD03-TAD, Seq. 6-4	060-CRN2-DROPON--CRN-DRP
			Maintain moderator control	73. The mean probability of inadvertent introduction of an oil moderator into a canister shall be less than or equal to 9E-5 over a 720-hour period following a radioactive release.	CRCF-ESD09-TAD (Seq. 3-4)	060-OIL-MODERATOR
			Limit speed	74. The speed of the trolley and bridge shall be limited to 20 ft/min.	CRCF-ESD09-TAD (Seq. 3-4)	This parameter limits the conditional probability of cask breach given a collision to the appropriate value from Table 6.3-7. (2.5 mi/hr, from Table 6.3-7, equals 220 ft/min, which bounds 20 ft/min.)

Table 6.9-1. Preclosure Nuclear Safety Design Bases for the CRCF ITS SSCs (Continued)

System or Facility (System Code)	Subsystem (As Applicable)	Component	Nuclear Safety Design Bases		Representative Affiliated Event Sequence (Sequence Number)	Source
			Safety Function	Controlling Parameters and Values		
Cask	Handling/Cask Receipt	Cask Transfer Trolley (CTT) and Pedestals Trolleys: (060-HM00-TRLY-00001-2) Pedestals: (060-HM00-PED-00001-2)	Limit speed	75. The speed of the CTT shall be limited to 2.5 mi/hr.	CRCF-ESD06-TAD (Seq. 3-3)	This parameter limits the conditional probability of canister breach given a collision to the appropriate value from Table 6.3-7.
			Protect against ^a spurious movement	76. The mean probability of spurious movement of the CTT while a canister is being lifted by the CTM shall be less than or equal to 1E-9 ^b per transfer.	CRCF-ESD09-HLW (Seq. 4-3)	060-9-CTT-SPUR-MOVE
		Horizontal Lifting Beam (200-HMC0-BEAM-00001) (shared with RF)	Protect against ^a drop	77. The horizontal lifting beam is an integral part of the load-bearing path. See Cask Handling Crane requirements.	See Cask Handling Crane requirements	See Cask Handling Crane requirements
		Cask lid-lifting grapples (DPC) (060-HMH0-HEQ-00012)	Protect against ^a drop of a load onto a canister	78. The cask lid lifting grapple is an integral part of the load-bearing path. See "cask handling crane" requirements.	See Cask Handling Crane requirements	See Cask Handling Crane requirements
		DPC Lid Adapter (060-HMH0-HEQ-00005-6)	Protect against ^a drop of a DPC	79. The DPC lid adapter is an integral part of the load-bearing path. See Canister Transfer Machine requirements.	See Canister Transfer Machine requirements	See Canister Transfer Machine requirements

Table 6.9-1. Preclosure Nuclear Safety Design Bases for the CRCF ITS SSCs (Continued)

System or Facility (System Code)	Subsystem (As Applicable)	Component	Nuclear Safety Design Bases		Representative Affiliated Event Sequence (Sequence Number)	Source
			Safety Function	Controlling Parameters and Values		
Cask	Handling/Cask Preparation	Rail Cask Lid Adapters (060-4MH0-HEQ-00003-4)	Protect against ^a drop	80. The rail cask lid adapters is an integral part of the load-bearing path. See Cask Handling Crane requirements	See Cask Handling Crane requirements	See Cask Handling Crane requirements
	Waste transfer/canister transfer	Canister transfer machine (060-HTC0-FHM-00001-2)	Protect against ^a drop	81. The mean probability of dropping a canister from below the two-block height due to the failure of a piece of equipment within the load-bearing path shall be less than or equal to 1E-5 per transfer for each CTM.	CRCF-ESD09-HLW, (Seq. 3-3)	CTM-DROP---ALL-HEIGHTS
			Protect against ^a drop	82. The mean probability of drop of a canister from the two-block height due to the failure of a piece of equipment within the load-bearing path shall be less than or equal to 3E-8 per transfer.	CRCF-ESD09-HLW (Seq. 8-3)	CTM-2-BLOCK
			Limit drop height	83. The two-block drop height shall not exceed 45 feet from the bottom of a canister to the cavity floor of the cask, aging overpack, or waste package.	CRCF-ESD09-HLW (Seq. 8-3)	This parameter limits the conditional probability of cask breach given a collision to the appropriate value from Table 6.3-7.
			Protect against ^a drop of a load onto a canister	84. The mean probability of dropping a load onto a canister shall be less than or equal to 1E-5 per transfer.	CRCF-ESD09-HLW (Seq. 6-3)	CTM-DROP-ONTO-CASK

Table 6.9-1. Preclosure Nuclear Safety Design Bases for the CRCF ITS SSCs (Continued)

System or Facility (System Code)	Subsystem (As Applicable)	Component	Nuclear Safety Design Bases		Representative Affiliated Event Sequence (Sequence Number)	Source
			Safety Function	Controlling Parameters and Values		
			Protect against ^a spurious movement	85. The mean probability of a spurious movement of the CTM while a canister is being lifted or lowered shall be less than or equal to 7E-9 per transfer for each CTM.	CRCF-ESD09-TAD (Seq. 4-3)	CTM-SHEAR
			Limit speed	86. The speed of the CTM trolley and bridge shall be limited to 20 ft/min.	CRCF-ESD09-HLW (Seq. 5-3)	This parameter limits the conditional probability of cask breach given a collision to the appropriate value from Table 6.3-7. (2.5 mi/hr, from Table 6.3-7, equals 220 ft/min, which bounds 20 ft/min.)
			Preclude non-flat bottom drop of a DPC or TAD canister	87. The CTM shall preclude non-flat-bottom drops of DPCs and TAD canisters.	Initiating event does not require further analysis ^c	Table 6.0-2
			Protect against ^a direct exposure to personnel	88. The mean probability of inadvertent radiation streaming to workers resulting from the inadvertent opening of the CTM slide gate, the inadvertent raising of the CTM shield skirt, or an inadvertent motion of the CTM away from an open port shall be less than or equal to 9E-6 per transfer.	CRCF-ESD18-TAD (Seq. 2)	ESD18-TEMP-SHIELD-LOSS

Table 6.9-1. Preclosure Nuclear Safety Design Bases for the CRCF ITS SSCs (Continued)

System or Facility (System Code)	Subsystem (As Applicable)	Component	Nuclear Safety Design Bases		Representative Affiliated Event Sequence (Sequence Number)	Source
			Safety Function	Controlling Parameters and Values		
			Maintain moderator control	89. The mean probability of inadvertent introduction of an oil moderator into a canister shall be less than or equal to 9E-5 over a 720-hour period following the breach of a canister.	CRCF-ESD09-TAD (Seq. 3-4)	060-OIL-MODERATOR
			Preclude canister breach	90. Closure of the CTM slide gate shall be incapable of breaching a canister.	Initiating event does not require further analysis ^c	Table 6.0-2
			Maintain DOE Standardized canister separation	91. The conditional probability of inadvertent placement of more than four DOE Standardized canisters in a TAD, WP, TAD staging rack, or AO shall be less than or equal to 3E-6.	Initiating event does not require further analysis ^c	Table 6.0-2
		Canister grapples (060-HTC0-HEQ-00003-7)	Protect against ^a drop	92. The grapple is an integral part of the load-bearing path. See "Canister Transfer Machine" requirements.	See "Canister Transfer Machine" requirements.	See "Canister Transfer Machine" requirements.
		Canister transfer machine grapples (060-HTC0-HEQ-00001-2)	Protect against ^a drop of a load onto a canister	93. The grapple is an integral part of the load-bearing path. See "Canister Transfer Machine" requirements.	See "Canister Transfer Machine" requirements.	See "Canister Transfer Machine" requirements.
		TAD Staging Racks (and Thermal Barrier) (060-HTC0-RK-00011-12)	Protect against canister breach	94. The mean conditional probability of breach of a DOE standardized canister contained within a staging area resulting from the spectrum of fires shall be less than or equal to 2E-6 per fire event.	CRCF-ESD20-DSTD (Seq. 5-3) ^d	060-DSTD-FAILURE-SA ^d

Table 6.9-1. Preclosure Nuclear Safety Design Bases for the CRCF ITS SSCs (Continued)

System or Facility (System Code)	Subsystem (As Applicable)	Component	Nuclear Safety Design Bases		Representative Affiliated Event Sequence (Sequence Number)	Source
			Safety Function	Controlling Parameters and Values		
		DOE Canister Staging Racks (and Thermal Barrier) (060-HTC0-RK-00006-10)	Protect against canister breach	95. The mean conditional probability of breach of a DOE standardized canister contained within a staging area resulting from the spectrum of fires shall be less than or equal to 2E-6 per fire event.	CRCF-ESD20-DSTD (Seq. 5-3)	060-DSTD-FAILURE-SA
		Waste package transfer trolley (including pedestals, seismic rail restraints, and rail system) (Trolleys: 060-HL00-TRLY-00001-2) (Pedestals: 060-HL00-PED-00001-8)	Preclude rapid tilt-down	96. The WPTT shall be incapable of rapid tilt-down.	Initiating event does not require further analysis ^c	Table 6.0-2
		Limit speed	97. The speed of the WPTT shall be limited to 2.5 mi/hr.	CRCF-ESD13-WP-H&D (Seq. 3-3)	This parameter limits the conditional probability of canister breach given a collision to the appropriate value from Table 6.3-7.	
		Protect against ^a spurious movement	98. The mean probability of spurious movement of the WPTT while a canister is being lowered by the CTM shall be less than or equal to 1E-09 ^b per transfer.	CRCF-ESD09-HLW (Seq. 4-3)	060-9-WPTT-SPURMOVE	

Table 6.9-1. Preclosure Nuclear Safety Design Bases for the CRCF ITS SSCs (Continued)

System or Facility (System Code)	Subsystem (As Applicable)	Component	Nuclear Safety Design Bases		Representative Affiliated Event Sequence (Sequence Number)	Source
			Safety Function	Controlling Parameters and Values		
Surface Nuclear Confinement HVAC System (VC)	Surface Nuclear Confinement HVAC	Portions of the surface nuclear confinement HVAC system that exhaust from areas with a potential for a breach	Mitigate the consequences of radionuclide release	99. The mean probability that the HVAC system (including HEPA filtration of exhaust air from in the CRCF confinement areas) becomes unavailable during a 30-day mission time following a radionuclide release shall be less than or equal to 4E-2. This parameter does not apply in the case of large fires, which may disable the HVAC system	CRCF-ESD09-TAD (Seq. 3-5)	060-DP-LOSS-CRCF
		Portions of the surface nuclear confinement HVAC system that support the cooling of ITS electrical equipment and battery rooms	Support ITS electrical function	100. The mean conditional probability of failure of the portions of the surface nuclear confinement HVAC system that support the cooling of ITS electrical equipment and battery rooms in the CRCF shall be less than or equal to 2E-2 per ITS electrical train over a period of 720 hours following a radionuclide release.	CRCF-ESD09-TAD (Seq. 3-5)	EP-CRCF-COOL-1
		Portions of the surface non-confinement HVAC system that support the cooling of ITS electrical and battery rooms (EDGF)	Support ITS electrical function	101. The mean conditional probability of failure of the portions of the surface non-confinement HVAC system that support the cooling of ITS electrical equipment and battery rooms in the EDGF shall be less than or equal to 2E-2 per ITS electrical train over a period of 720 hours following a radionuclide release.	CRCF-ESD09-TAD (Seq. 3-5)	EP-CRCF-COOL-1

Table 6.9-1. Preclosure Nuclear Safety Design Bases for the CRCF ITS SSCs (Continued)

System or Facility (System Code)	Subsystem (As Applicable)	Component	Nuclear Safety Design Bases		Representative Affiliated Event Sequence (Sequence Number)	Source
			Safety Function	Controlling Parameters and Values		

- NOTE: ^a. 'Protect against' in this table means either 'reduce the probability of' or 'reduce the frequency of'.
- ^b. Extremely low probabilities are reported in this table as 1E-9. Increasing the source probability to 1E-9 does not impact the categorization of event sequences.
- ^c. Design requirement is applied to reduce the frequency of any event sequence that could result in damage to a waste container to beyond Category 2.
- ^d. The TAD staging racks are not anticipated to be used to stage TAD canisters. The controlling parameters, sequence number, and source are from the DOE Canister Staging Racks requirement to provide protection in the event a DOE standardized canister is inadvertently placed into a TAD staging rack.
- ^e. Source value bounds the controlling value.

CRCF = Canister Receipt and Closure Facility; CTM = canister transfer machine; CTT = cask transfer trolley; DOE = U.S. Department of Energy; DPC = dual-purpose canister; ESD = event sequence diagram; HEPA = high-efficiency particulate air; HLW = high-level radioactive waste; HVAC = heating, ventilation, and air conditioning; ITS = important to safety; SNF = spent nuclear fuel; ST = site transporter; TAD = transportation, aging, and disposal; WPTT = waste package transfer trolley.

Source: Original

Table 6.9-2. Summary of Procedural Safety Controls for the CRCF

Item	SSC	Procedural Safety Controls	Basis for Selection	Representative Event Sequence
1	CTT	The CTT is deflated during loading of cask onto trolley, cask preparation activities, and during canister unloading or loading activities.	This control limits the probability of spurious movement of the CTT and resulting collision or tipover.	CRCF-ESD09-TAD (Seq. 4-3)
2	ST Site Prime Mover	The ST is turned off during, AO bolting and unbolting, and canister unloading or loading activities. The site prime mover and cask tractor are disconnected or secured to prevent motion before waste handling operations begin.	This control limits the probability of spurious movement of the ST or site prime mover and resulting collision or tipover.	CRCF-ESD09-TAD (Seq. 4-3)
3	WPTT	Personnel are verified to be outside of the WP Positioning Room and the WP Loadout Room prior to movement of a loaded WP into the WP Positioning Room or the WP Loadout Room.	This control limits the probability of operators receiving a direct exposure during the loading of a WP into the TEV.	CRCF-ESD19-TAD (Seq. 3)
4	Surface Nuclear Confinement HVAC, ITS exhaust subsystem serving ITS confinement areas and ITS subsystems serving ITS electrical and battery rooms	One train of HVAC is required to be operating and the second train is required to be in standby before commencing waste handling operations.	HVAC analysis uses this configuration. This control limits the probability that the HVAC system will fail to start when relied upon to mitigate the consequences of an event sequence.	CRCF-ESD09-TAD (Seq. 3-5)
5	ITS Diesel Generators	Before commencing waste handling operations, two ITS diesel generators are aligned to start on detection of undervoltage. Following the start of the diesel generators, the operator manages the operation of the ITS diesel generators to ensure continuous operation of a train of the Surface Nuclear Confinement HVAC, ITS exhaust subsystem serving ITS confinement areas and ITS subsystems serving ITS electrical and battery rooms in each of the waste handling facilities.	The PCSA reliability analysis models both ITS diesel generators to start and run 720 hours to support the operation of the Surface Nuclear Confinement HVAC System.	CRCF-ESD09-TAD (Seq. 3-5)

Table 6.9-2. Summary of Procedural Safety Controls for the CRCF (Continued)

Item	SSC	Procedural Safety Controls	Basis for Selection	Representative Event Sequence
6	ITS SSCs	The amount of time that a waste form spends in each process area or in a given process operation, including total residence time in a facility, is periodically compared against the average exposure times used in the PCSA. Additionally, component failures per demand and component failures per time period are compared against the PCSA. Significant deviations will be analyzed for risk significance.	PCSA uses exposure/residence times and reliability data to calculate the probability of an initiating event, or the probability of seismic induced failures that lead to an event sequence. This control ensures that the average exposure times and reliability data are maintained consistent with those analyzed in the PCSA.	Applies to all event sequence and fault tree quantification that uses data from Attachment C. Also applies to fire analysis per Section 4.3 and Attachment E.
7	Cask Preparation Platform	Transportation cask lid bolts are independently verified to have been removed prior to moving the cask from the cask preparation area to the unloading room or pool.	This control prevents the CTM from attempting to remove the cask lid with bolts still in place resulting in failure of the bolts and possible drop of the lid or cask.	CRCF-ESD09-TAD (Seq. 2-3)
8	CTM Port Slide Gates	At completion of a canister transfer operation, the port slide gates are verified to be closed	While the CTM is being used to perform transfer operations, the Operational Radiation Protection Program provides the necessary controls to ensure that workers are not present with the slide gates open. This control limits the probability of workers receiving a direct exposure by entering the transfer room with the CTM away from a port with a waste form present and the slide gate open.	CRCF-ESD18-TAD (Seq. 2)
9	CTM	Prior to lifting or lowering a DPC, TAD canister, or naval canister, the CTM guide sleeve is to be verified to have been lowered.	This control limits the probability that a DPC, TAD canister, or naval canister is not in a vertical orientation during transfer such that any potential drops would be flat bottom drops.	CRCF-ESD09-TAD (Seq. 3-3)

Table 6.9-2. Summary of Procedural Safety Controls for the CRCF (Continued)

Item	SSC	Procedural Safety Controls	Basis for Selection	Representative Event Sequence
10	Cask Preparation Room Equipment Confinement Doors	The cask preparation room equipment confinement doors are to be closed when conducting operations with a potential for a drop involving a loaded cask.	This control is to ensure that the confinement boundary is intact when there is a potential for an event sequence that could result in radiological releases.	CRCF-ESD03-MCO (Seq. 2-6)

NOTE: AO = aging overpack; CTM = canister transfer machine; CTT = cask transfer trolley; DPC = dual-purpose canister; ST = site transporter; TAD = transportation, aging, and disposal; WP = waste package.

Source: Original

7. RESULTS AND CONCLUSIONS

This analysis and its predecessor, the event sequence development analysis (Ref. 2.2.33), are part of the preclosure safety analysis (PCSA) for the geologic repository operations area (GROA) that supports the license application. In combination, these documents identify, evaluate, quantify, and categorize event sequences for the GROA facilities and operations. They are part of a collection of analysis reports that encompass all waste handling activities and facilities of the GROA from initial operations to the end of the preclosure period. Probabilistic risk assessment techniques derived from both nuclear power plant and aerospace methods are used to perform the analyses to comply with the risk-informed aspects of 10 CFR 63.111 and 63.112 (Ref. 2.3.2), and to be responsive to the acceptance criteria articulated in the *Yucca Mountain Review Plan, Final Report* (Ref. 2.2.73). The identification and development of the event sequences is limited to those that might lead to direct radiation exposure of workers or onsite members of the public; radiological releases that may affect the workers or public (onsite and offsite); and nuclear criticality.

The results of the analysis are discussed and presented in the logical progression through Section 6 of this document and are not reiterated here. Instead, only key points are highlighted. For the ungrouped event sequence results and the complete grouped event sequence summaries, electronic files are provided due to the large size of hard copy versions (refer to Attachments G and H). In addition, although the results from the SAPHIRE model are used and presented in Section 6 and Attachment B, the model itself is difficult to completely represent in paper form. Therefore, these outputs are also provided electronically (refer to Attachment H). Table 7-1 describes the results and indicates the location within this analysis for each result provided.

Table 7-1. Key to Results

Result	Description	Cross Reference
Grouping of event sequences	Grouping of event sequences and description of event sequence groups	Table G-1
Quantification of event sequences	Calculation of probability distributions for the numbers of occurrences of internal event sequence groups over the preclosure period	Table G-2
Categorization of event sequences	Assignment of frequency categories Category 1, Category 2, or beyond Category 2 to internal event sequence groups based on mean numbers of occurrences	Table 6.8-2 Table 6.8-3 Table G-3
Designation of SSCs as ITS	Identification of SSCs that are relied on in the quantification of internal event sequences for prevention or mitigation	Table 6.9-1

Table 7-1. Key to Results (Continued)

Result	Description	Cross Reference
Statement of nuclear safety design bases	Determination of nuclear safety design bases for SSCs that are relied on in the quantification of internal event sequences for prevention or mitigation	Table 6.9-1
Statement of procedural safety controls	Determination of procedural safety controls that are relied on in the quantification of internal event sequences for prevention or mitigation	Table 6.9-2

NOTE: ITS = important to safety; SSCs = structures, systems, and components.

Source: Original

Summary of Event Sequences

The analysis concludes that there are no Category 1 event sequences and 35 Category 2 event sequences. Table 7-2 gives the number of Category 2 event sequences by end state for each waste form.

Summary of Conservatisms

It is noted that the event sequence identification and categorization were conducted with conservatisms that increase confidence in the results. These conservatisms include those listed below.

1. Fire frequency and damage analyses are performed without relying on fire suppression. This increases the calculated frequency of large fires and also increases the duration and peak temperature of fires, thereby significantly increasing the calculated probability of waste container failure.
2. If a fire is calculated to propagate out of the initiating location fire zone, the entire building is considered to be involved in the fire.
3. In the passive equipment failure analysis (PEFA) for thermal and fire scenarios, conservatism is built into the boundary conditions, which consider the fire as occurring next to the waste containers instead of only a fraction of the fire occurrence being near the waste form. A fire closer to the target will lead to a higher target failure probability than a fire located further away. By considering all fires to be next to the waste forms, the thermal PEFA yields higher waste form failure probabilities than is likely.
4. For event sequences in which a cask containing a canister is subjected to a drop, slapdown, or in which a load is dropped onto the cask, the calculated containment failure probability pertains to the canister inside without regard to the integrity of the cask. That is, cask containment is not relied upon to reduce probability of containment failure.

Table 7-2. Summary of Category 2 Event Sequences

End State	Description	Waste Forms							
		DPC	DSTD	HLW	MCO	TAD	WP-H&D	WP-H&M	WP-TAD
DE-SHIELD-DEGRADE	Direct exposure due to degradation of shielding	None	None	None	None	1	None	None	None
DE-SHIELD-LOSS	Direct exposure due to loss of shielding	3	2	2	2	7	2	2	2
RR-UNFILTERED	Radionuclide release, unfiltered	None	None	1	2 ^a	None	None	2 ^a	None
RR-FILTERED	Radionuclide release, filtered	None	None	1	3 ^a	1	None	2 ^a	None
RR-UNFILTERED-ITC	Radionuclide release, unfiltered, also important to criticality	None	None	None	None	None	None	None	None
RR-FILTERED-ITC	Radionuclide release, filtered, also important to criticality	None	None	None	None	None	None	None	None
ITC	Important to criticality	None	None	None	None	None	None	None	None

NOTE: ^a Results for MCO exceed criteria of 10 CFR 63.112 (Ref. 2.3.2), therefore additional analysis is required for this waste form.
DPC = dual-purpose canister; DOE = U.S. Department of Energy; HLW = high-level radioactive waste; MCO = multicanister overpack;
TAD = transportation, aging and disposal; WP = waste package.

Source: Original

5. The structural PEFA uses a conservative failure probability of $1E-5$, whereas the actual PEFA assessment indicates values of less than $1E-8$ failure probabilities (Table D1.2-7 of Attachment D). This conservatism provides event sequence quantification results of magnitude higher than what they would be if the actual PEFA assessment values are used.
6. The event sequence development for shielding degradation of transportation casks caused by an impact event, considers all casks as if they contained lead gamma shielding that could slump. However, not all transportation casks received at the GROA are lead casks. Because non-lead casks are not affected by this degraded shielding condition, the introduction of this conservatism increases the event sequence quantification value.
7. The structural analyses for drops and collisions of canisters or casks model a rigid, unyielding surface as the target.
8. The structural analysis for drops of loads onto casks or canisters uses a rigid unyielding object for the dropped load.
9. The probabilities of event sequences involving drops of casks and canisters represent a drop height of up to 40 feet for casks and 45 feet for bare canisters. This is much higher than the normal operational lift height but is applied for all lower drop heights. Lower drop heights would result in less structural challenge to casks and canisters.
10. When a canister is inside a waste package, failure of the waste package is considered to fail containment. That is, the canister is not relied upon to reduce the probability of containment failure.
11. Transportation casks are analyzed without impact limiters even for those event sequences in which impact limiters would be attached.
12. The speed limitation of crane and conveyances within facilities to 20 ft/min and 2.5 mph, respectively, is set to ensure no breach of casks or canisters. The probability of breach at such speeds is calculated to be less than $1E-08$ per impact. Speeds could be considerably larger without changing the categorizations of event sequences.
13. The reliability evaluation of the ITS HVAC system, which provides confinement of radioactive material releases following a breach of a waste container, is based a mission time of 720 hrs (30 days). The use of this mission time in the analysis leads to a requirement that the emergency diesel generators provide power to the HVAC for 720 hours following a release. The analysis does not account for the high likelihood of recovering offsite power within the mission time. Recovery of offsite power would reduce the length of time that the diesel generators would be required to run and would thereby reduce the calculated unavailability of the diesel generators. This conservative consideration leads to a lower ITS HVAC availability than is realistically expected.

14. The human reliability analysis screening values used for human failure events are typically one or more orders of magnitude higher than values that are obtained through detailed analysis.
15. The probability of failure associated with the structural analysis of mechanical impact loads to casks and canisters is conservatively based on the maximum effective plastic strain of any brick (i.e., finite element mesh) in the modeled structure rather than on evidence of through-wall cracking.
16. Categorization of event sequences is based on the highest category after application of a conservative adjustment to account for the uncertainty in the calculated uncertainties
17. To preserve flexibility in the conduct of operations, the throughput analysis (Ref. 2.2.31) embeds multiple and bounding waste handling scenarios in the throughput numbers. For example, it considers that all TAD canisters and DPCs could transit through the CRCF to the aging facility. In fact, the capability to transfer of TAD and DPC canisters from transportation casks to aging overpacks is shared between the RF and the CRCF. As a result, the allocated numbers for both facilities are higher than is realistically expected. Including this conservatism in the analysis yields calculated event sequence frequencies that are higher than is realistically expected.

ATTACHMENT A
EVENT TREES

CONTENTS

	Page
A1 INTRODUCTION	A-13
A2 READER'S GUIDE TO THE EVENT TREE DESCRIPTIONS	A-13
A3 SUMMARY OF THE MAJOR PIVOTAL EVENT TYPES	A-14
A4 EVENT TREE DESCRIPTIONS	A-15
A4.1 EVENT TREES FOR CRC-ESD-01	A-15
A4.2 EVENT TREES FOR CRC-ESD-02	A-21
A4.3 EVENT TREES FOR CRC-ESD-03	A-23
A4.4 EVENT TREES FOR CRC-ESD-04	A-30
A4.5 EVENT TREES FOR CRC-ESD-05	A-37
A4.6 EVENT TREES FOR CRC-ESD-06	A-39
A4.7 EVENT TREES FOR CRC-ESD-07	A-43
A4.8 EVENT TREES FOR CRC-ESD-08	A-47
A4.9 EVENT TREES FOR CRC-ESD-09	A-50
A4.10 EVENT TREES FOR CRC-ESD-10	A-60
A4.11 EVENT TREES FOR CRC-ESD-11	A-63
A4.12 EVENT TREES FOR CRC-ESD-12	A-66
A4.13 EVENT TREES FOR CRC-ESD-13	A-68
A4.14 EVENT TREES FOR CRC-ESD-14	A-72
A4.15 EVENT TREES FOR CRC-ESD-15	A-75
A4.16 EVENT TREES FOR CRC-ESD-16	A-80
A4.17 EVENT TREES FOR CRC-ESD-17	A-83
A4.18 EVENT TREES FOR CRC-ESD-18	A-84
A4.19 EVENT TREES FOR CRC-ESD-19	A-85
A4.20 EVENT TREES FOR CRC-ESD-20	A-86
A5. EVENT TREES	A-96

FIGURES

	Page
A5-1. Example Initiator Event Tree Showing Navigation Aids	A-96
A5-2. Event Tree CRCF-ESD01-DPC – Receipt of Transportation Cask with DPC Canister in the Cask Preparation Room	A-101
A5-3. Event Tree RESPONSE-TCASK1 – Response to Structural Challenges to Transportation Cask Prior to Removal of Lid Bolts	A-102
A5-4. Event Tree CRCF-ESD01-DSTD – Receipt of Transportation Cask with DOE Std. Canister in the Cask Preparation Room.....	A-103
A5-5. Event Tree CRCF-ESD01-HLW - Receipt of Transportation Cask with HLW Canister in the Cask Preparation Room	A-104
A5-6. Event Tree CRCF-ESD01-MCO - Receipt of Transportation Cask with MCO in the Cask Preparation Room	A-105
A5-7. Event Tree CRCF-ESD01-TAD – Receipt of Transportation Cask with TAD Canister in the Cask Preparation Room	A-106
A5-8. Event Tree CRCF-ESD02-TAD – Receipt of Aging Overpack with TAD Canister in the Cask Preparation Room.....	A-107
A5-9. Event Tree RESPONSE-AO1 – Response to Structural Challenges to Aging Overpack.....	A-108
A5-10. Event Tree CRCF-ESD03-DPC – Upending and Transfer of Transportation Cask with DPC to CTT	A-109
A5-11. Event Tree CRCF-ESD03-DSTD – Upending and Transfer of Transportation Cask with DOE Std. Canister to CTT	A-110
A5-12. Event Tree CRCF-ESD03-HLW – Upending and Transfer of Transportation Cask with HLW Canister to the CTT	A-111
A5-13. Event Tree CRCF-ESD03-MCO – Upending and Transfer of Transportation Cask with MCO to the CTT	A-112
A5-14. Event Tree CRCF-ESD03-TAD – Upending and Transfer of Transportation Cask with TAD Canister to the CTT	A-113
A5-15. Event Tree CRCF-ESD04-DPC – Transportation Cask with DPC Preparation Activities.....	A-114
A5-16. Event Tree CRCF-ESD04-DSTD – Transportation Cask with DOE Std. Canister Preparation Activities	A-115
A5-17. Event Tree CRCF-ESD04-HLW – Transportation Cask with HLW Canister Preparation Activities.....	A-116
A5-18. Event Tree CRCF-ESD04-MCO – Transportation Cask with MCO Preparation Activities.....	A-117

FIGURES (Continued)

	Page
A5-19. Event Tree CRCF-ESD04-TAD – Transportation Cask with TAD Canister Preparation Activities.....	A-118
A5-20. Event Tree CRCF-ESD05-TAD – Aging Overpack with TAD Canister Preparation Activities.....	A-119
A5-21. Event Tree RESPONSE-CANISTER1 – Response to Structural Challenges to Canister	A-120
A5-22. Event Tree CRCF-ESD06-DPC – Transfer of Transportation Cask with DPC from Cask Preparation Room to Cask Unloading Room.....	A-121
A5-23. Event Tree RESPONSE-TCASK2 – Response to Structural Challenges to Transportation Cask Following Removal of Lid Bolts.....	A-122
A5-24. Event Tree CRCF-ESD06-DSTD – Transfer of Transportation Cask with DOE SNF from Cask Preparation Room to Cask Unloading Room	A-123
A5-25. Event Tree CRCF-ESD06-HLW – Transfer of Transportation Cask with HLW Canister from Cask Preparation Room to Cask Unloading Room	A-124
A5-26. Event Tree CRCF-ESD06-MCO – Transfer of Transportation Cask with MCO from Cask Preparation Room to Cask Unloading Room.....	A-125
A5-27. Event Tree CRCF-ESD06-TAD – Transfer of Transportation Cask or Aging Overpack with TAD Canister from Cask Preparation Room to Cask Unloading Room.....	A-126
A5-28. Event Tree CRCF-ESD07-DPC – CTT Carrying Transportation Cask with DPC Collides with Cask Unloading Room Shield Door	A-127
A5-29. Event Tree CRCF-ESD07-DSTD – CTT Carrying Transportation Cask with DOE Std. Canister Collides with Cask Unloading Room Shield Door	A-128
A5-30. Event Tree CRCF-ESD07-HLW – CTT Carrying Transportation Cask with HLW Canister Collides with Cask Unloading Room Shield Door.....	A-129
A5-31. Event Tree CRCF-ESD07-MCO – CTT Carrying Transportation Cask with MCO Collides with Cask Unloading Room Shield Door.....	A-130
A5-32. Event Tree CRCF-ESD07-TAD – CTT Carrying Transportation Cask with TAD Canister or Site Transporter Carrying Aging Overpack with TAD Canister Collides with Cask Unloading Room Shield Door.....	A-131
A5-33. Event Tree CRCF-ESD07-WP-H&D – H&D in Waste Package.....	A-132
A5-34. Event Tree CRCF-ESD07-WP-H&M – H&M in Waste Package.....	A-133
A5-35. Event Tree CRCF-ESD07-WP-TAD – TAD Canister in Waste Package.....	A-134
A5-36. Event Tree CRCF-ESD08-DPC – Collision between 2 CTMs Carrying DPCs...	A-135

FIGURES (Continued)

	Page
A5-37. Event Tree CRCF-ESD08-DSTD – Collision between 2 CTMs Carrying DOE Std. Canister.....	A-136
A5-38. Event Tree CRCF-ESD08-HLW – Collision between 2 CTMs Carrying HLW Canister	A-137
A5-39. Event Tree CRCF-ESD08-MCO – Collision between 2 CTMs Carrying MCO..	A-138
A5-40. Event Tree CRCF-ESD08-TAD – Collision between 2 CTMs Carrying TAD Canisters.....	A-139
A5-41. Event Tree CRCF-ESD09-DPC – Transferring a DPC with the CTM	A-140
A5-42. Event Tree CRCF-ESD09-DSTD – Transferring DOE Std. Canister with the CTM.....	A-141
A5-43. Event Tree CRCF-ESD09-HLW – Transferring a HLW Canister with the CTM.....	A-142
A5-44. Event Tree CRCF-ESD09-MCO – Transferring MCO with the CTM.....	A-143
A5-45. Event Tree CRCF-ESD09-TAD – Transferring a TAD Canister with the CTM .	A-144
A5-46. Event Tree CRCF-ESD10-WP-H&D – Transfer of Waste Package with HLW and either a DOE Std. Canister or MCO on WPTT from Waste Package Loading Room to Waste Package Positioning Room.....	A-145
A5-47. Event Tree RESPONSE-WP1 – Response to Structural Challenges to Waste Package Prior to Closure of Waste Package.....	A-146
A5-48. Event Tree CRCF-ESD10-WP-H&M – Transfer of Waste Package with HLW and MCO on WPTT from Waste Package Loading Room to Waste Package Positioning Room.....	A-147
A5-49. Event Tree CRCF-ESD10-WP-TAD – Transfer of Waste Package with TAD Canister on WPTT from Waste Package Loading Room to Waste Package Positioning Room.....	A-148
A5-50. Event Tree CRCF-ESD11-WP-H&D – Assembly and Closure of Waste Package with HLW and either a DOE Std. Canister or MCO	A-149
A5-51. Event Tree CRCF-ESD11-WP-H&M – Assembly and Closure of Waste Package with HLW and MCO	A-150
A5-52. Event Tree CRCF-ESD11-WP-TAD – Assembly and Closure of Waste Package with TAD Canister.....	A-151
A5-53. Event Tree CRCF-ESD12-DPC – Assembly and Closure of Aging Overpack with DPC.....	A-152
A5-54. Event Tree CRCF-ESD12-TAD – Assembly and Closure of Aging Overpack with TAD Canister.....	A-153

FIGURES (Continued)

	Page
A5-55. Event Tree CRCF-ESD13-WP- H&D – Transfer of Waste Package with HLW and either a DOE Std. Canister or MCO on WPTT from Waste Package Positioning Room to Waste Package Loadout Room.....	A-154
A5-56. Event Tree RESPONSE-WP2 – Response to Structural Challenge to Waste Package Following Closure of Waste Package.....	A-155
A5-57. Event Tree CRCF-ESD13-WP-H&M – Transfer of Waste Package with HLW and MCO on WPTT from Waste Package Positioning Room to Waste Package Loadout Room	A-156
A5-58. Event Tree CRCF-ESD13-WP-TAD – Transfer of Waste Package with TAD Canister on WPTT from Waste Package Positioning Room to Waste Package Loadout Room	A-157
A5-59. Event Tree CRCF-ESD14-DPC – Transfer of Aging Overpack with DPC on Site Transporter from Cask Unloading Room to Cask Preparation Room.....	A-158
A5-60. Event Tree CRCF-ESD14-TAD – Transfer of Aging Overpack with TAD Canister on Site Transporter from Cask Unloading Room to Cask Preparation Room.....	A-159
A5-61. Event Tree CRCF-ESD15-WP-H&D – Export Waste Package with HLW and either a DOE Std. Canister or MCO from CRCF	A-160
A5-62. Event Tree CRCF-ESD15-WP-H&M – Export Waste Package with HLW and MCO from CRCF	A-161
A5-63. EventTree CRCF-ESD15-WP-TAD – Export Waste Package with TAD Canister from CRCF	A-162
A5-64. Event Tree CRCF-ESD16-DPC – Exporting Aging Overpack with DPC from CRCF	A-163
A5-65. Event Tree CRCF-ESD16-TAD – Exporting Aging Overpack with TAD Canister from CRCF	A-164
A5-66. Event Tree CRCF-ESD17-DPC – Direct Exposure During Cask Preparation Activities.....	A-165
A5-67. Event Tree CRCF-ESD17-DSTD – Direct Exposure During Cask Preparation Activities.....	A-166
A5-68. Event Tree CRCF-ESD17-HLW – Direct Exposure During Cask Preparation Activities.....	A-167
A5-69. Event Tree CRCF-ESD17-MCO – Direct Exposure During Cask Preparation Activities.....	A-168
A5-70. Event Tree CRCF-ESD17-TAD – Direct Exposure During Cask Preparation Activities.....	A-169

FIGURES (Continued)

	Page
A5-71. Event Tree CRCF-ESD18-DPC – Direct Exposure During CTM Activities	A-170
A5-72. Event Tree CRCF-ESD18-DSTD – Direct Exposure During CTM Activities	A-171
A5-73. Event Tree CRCF-ESD18-HLW – Direct Exposure During CTM Activities.....	A-172
A5-74. Event Tree CRCF-ESD18-MCO – Direct Exposure During CTM Activities.....	A-173
A5-75. Event Tree CRCF-ESD18-TAD – Direct Exposure During CTM Activities.....	A-174
A5-76. Event Tree CRCF-ESD19-WP-H&D – Direct Exposure During Waste Package Closure Activities	A-175
A5-77. Event Tree CRCF-ESD19-WP-H&M – Direct Exposure During Waste Package Closure Activities	A-176
A5-78. Event Tree CRCF-ESD19 WP TAD – Direct Exposure During Waste Package Closure Activities.....	A-177
A5-79. Event Tree CRCF-ESD20-DPC – Fire Occurring in the CRCF Involving DPCs	A-178
A5-80. Event Tree RESPONSE-FIRE – Response to Fire Events	A-179
A5-81. Event Tree CRCF-ESD20-DSTD – Fire Occurring in the CRCF Involving DOE SNF	A-180
A5-82. Event Tree CRCF-ESD20-HLW – Fire Occurring in the CRCF Involving HLW Canisters.....	A-181
A5-83. Event Tree CRCF-ESD20-MCO – Fire Occurring in the CRCF Involving MCO	A-182
A5-84. Event Tree CRCF-ESD20-TAD – Fire Occurring in the CRCF Involving TAD Canisters.....	A-183
A5-85. Event Tree CRCF-ESD20-WP-H&D – Fire Occurring in the CRCF Involving HLW and DOE SNF in Waste Package.....	A-184
A5-86. Event Tree CRCF-ESD20-WP-H&M – Fire Occurring in the CRCF Involving HLW and MCO in Waste Package	A-185

TABLES

	Page
A4.1-1. Summary of Event Trees for CRC-ESD-01.....	A-15
A4.1-2. Initiating Event Assignments for CRC-ESD-01.....	A-16
A4.1-3. Basic Event Associated with the TRANSCASK Pivotal Events of CRC-ESD-01.....	A-18
A4.1-4. Basic Events Associated with the CANISTER Pivotal Events of CRC-ESD-01...	A-19
A4.1-5. Basic Event Associated with the SHIELDING Pivotal Events of CRC-ESD-01...	A-19
A4.1-6. Basic Event Associated with the CONFINEMENT Pivotal Events of CRC-ESD-01.....	A-20
A4.1-7. Basic Event Associated with the MODERATOR Pivotal Events of CRC-ESD-01.....	A-21
A4.2-1. Summary of Event Trees for CRC-ESD-02.....	A-21
A4.2-2. Initiating Event Assignments for CRC-ESD-02.....	A-22
A4.2-3. Basic Events Associated with the CANISTER Pivotal Events of CRC-ESD-02...	A-22
A4.2-4. Basic Event Associated with the SHIELDING Pivotal Events of CRC-ESD-02...	A-23
A4.2-5. Basic Event Associated with the CONFINEMENT Pivotal Events of CRC-ESD-02.....	A-23
A4.2-6. Basic Event Associated with the MODERATOR Pivotal Events of CRC-ESD-02.....	A-23
A4.3-1. Summary of Event Trees for CRC-ESD-03.....	A-24
A4.3-2. Initiating Event Assignments for CRC-ESD-03.....	A-25
A4.3-3. Basic Event Associated with the TRANSCASK Pivotal Events of CRC-ESD-03.....	A-26
A4.3-4. Basic Events Associated with the CANISTER Pivotal Events of CRC-ESD-03...	A-27
A4.3-5. Basic Events Associated with the SHIELDING Pivotal Events of CRC-ESD-03.....	A-28
A4.3-6. Basic Event Associated with the CONFINEMENT Pivotal Events of CRC-ESD-03.....	A-29
A4.3-7. Basic Event Associated with the MODERATOR Pivotal Events of CRC-ESD-03.....	A-30
A4.4-1. Summary of Event Trees for CRC-ESD-04.....	A-31
A4.4-2. Initiating Event Assignments for CRC-ESD-04.....	A-32
A4.4-3. Basic Event Associated with the TRANSCASK Pivotal Events of CRC-ESD-04.....	A-33

TABLES (Continued)

	Page
A4.4-4. Basic Events Associated with the CANISTER Pivotal Events of CRC-ESD-04...	A-33
A4.4-5. Basic Event Associated with the SHIELDING Pivotal Events of CRC-ESD-04...	A-34
A4.4-6. Basic Event Associated with the CONFINEMENT Pivotal Events of CRC-ESD-04.....	A-35
A4.4-7. Basic Event Associated with the MODERATOR Pivotal Events of CRC-ESD-04.....	A-36
A4.5-1. Summary of Event Trees for CRC-ESD-05.....	A-37
A4.5-2. Initiating Event Assignments for CRC-ESD-05.....	A-37
A4.5-3. Basic Events Associated with the CANISTER Pivotal Events of CRC-ESD-05...	A-38
A4.5-4. Basic Events Associated with the SHIELDING Pivotal Events of CRC-ESD-05.....	A-38
A4.5-5. Basic Events Associated with the CONFINEMENT Pivotal Events of CRC-ESD-05.....	A-38
A4.5-6. Basic Events Associated with the MODERATOR Pivotal Events of CRC-ESD-05.....	A-39
A4.6-1. Summary of Event Trees for CRC-ESD-06.....	A-39
A4.6-2. Initiating Event Assignments for CRC-ESD-06.....	A-40
A4.6-3. Fault Trees Associated with the CANISTER Pivotal Events of CRC-ESD-06.....	A-41
A4.6-4. Fault Trees Associated with the SHIELDING Pivotal Events of CRC-ESD-06....	A-41
A4.6-5. Fault Trees Associated with the CONFINEMENT Pivotal Events of CRC-ESD-06.....	A-42
A4.6-6. Fault Trees Associated with the MODERATOR Pivotal Events of CRC-ESD-06.....	A-42
A4.7-1. Initiating Event Assignments for CRC-ESD-07.....	A-44
A4.7-2. Basic Events Associated with the CELL-DOOR Pivotal Events of CRC-ESD-07.....	A-45
A4.7-3. Basic Events Associated with the CONTAINMENT Pivotal Events of CRC-ESD-07.....	A-45
A4.7-4. Basic Events Associated with the SHIELDING Pivotal Events of CRC-ESD-07.....	A-46
A4.7-5. Basic Events Associated with the CONFINEMENT Pivotal Events of CRC-ESD-07.....	A-46
A4.7-6. Basic Events Associated with the MODERATOR Pivotal Events of CRC-ESD-07.....	A-47

TABLES (Continued)

	Page
A4.8-1. Summary of Event Trees for CRC-ESD-08.....	A-47
A4.8-2. Initiating Event Assignments for CRCF-ESD-08.....	A-48
A4.8-3. Basic Events Associated with the CANISTER Pivotal Events of CRC-ESD-08...	A-48
A4.8-4. Basic Events Associated with the SHIELDING Pivotal Events of CRC-ESD-08.....	A-49
A4.8-5. Basic Events Associated with the CONFINEMENT Pivotal Events of CRC-ESD-08.....	A-49
A4.8-6. Basic Events Associated with the MODERATOR Pivotal Events of CRC-ESD-08.....	A-49
A4.9-1. Summary of Event Trees for CRC-ESD-09.....	A-50
A4.9-2. Initiating Event Assignments for CRCF-ESD-09.....	A-51
A4.9-3. Basic Events Associated with the CANISTER Pivotal Events of CRC-ESD-09...	A-55
A4.9-4. Basic Events Associated with the SHIELDING Pivotal Events of CRC-ESD-09.....	A-56
A4.9-5. Basic Event Associated with the CONFINEMENT Pivotal Events of CRC-ESD-09.....	A-57
A4.9-6. Basic Event Associated with the MODERATOR Pivotal Events of CRC-ESD-09.....	A-59
A4.10-1. Summary of Event Trees for CRC-ESD-10.....	A-60
A4.10-2. Initiating Event Assignments for CRCF-ESD-10.....	A-61
A4.10-3. Basic Events Associated with the CANISTER Pivotal Events of CRC-ESD-10...	A-61
A4.10-4. Basic Events Associated with the SHIELDING Pivotal Events of CRC-ESD-10.....	A-62
A4.10-5. Basic Event Associated with the CONFINEMENT Pivotal Events of CRC-ESD-10.....	A-62
A4.10-6. Basic Event Associated with the MODERATOR Pivotal Events of CRC-ESD-10.....	A-63
A4.11-1. Summary of Event Trees for CRC-ESD-11.....	A-63
A4.11-2. Initiating Event Assignments for CRCF-ESD-11.....	A-64
A4.11-3. Basic Events Associated with the CANISTER Pivotal Events of CRC-ESD-11...	A-64
A4.11-4. Basic Events Associated with the SHIELDING Pivotal Events of CRC-ESD-11.....	A-65
A4.11-5. Basic Event Associated with the CONFINEMENT Pivotal Events of CRC-ESD-11.....	A-65

TABLES (Continued)

	Page
A4.11-6. Basic Event Associated with the MODERATOR Pivotal Events of CRC-ESD-11.....	A-66
A4.12-1. Summary of Event Trees for CRC-ESD-12.....	A-66
A4.12-2. Initiating Event Assignments for CRCF-ESD-12.....	A-67
A4.12-3. Basic Events Associated with the CANISTER Pivotal Events of CRC-ESD-12...	A-67
A4.12-4. Basic Event Associated with the SHIELDING Pivotal Events of CRC-ESD-12...	A-68
A4.12-5. Basic Event Associated with the CONFINEMENT Pivotal Events of CRC-ESD-12.....	A-68
A4.12-6. Basic Event Associated with the MODERATOR Pivotal Events of CRC-ESD-12.....	A-68
A4.13-1. Summary of Event Trees for CRC-ESD-13.....	A-69
A4.13-2. Initiating Event Assignments for CRCF-ESD-13.....	A-69
A4.13-3. Basic Event Associated with the Waste Package Pivotal Events of CRC-ESD-13.....	A-70
A4.13-4. Basic Events Associated with the CANISTER Pivotal Events of CRC-ESD-13...	A-70
A4.13-5. Basic Events Associated with the SHIELDING Pivotal Events of CRC-ESD-13.....	A-71
A4.13-6. Basic Event Associated with the CONFINEMENT Pivotal Events of CRC-ESD-13.....	A-71
A4.13-7. Basic Event Associated with the MODERATOR Pivotal Events of CRC-ESD-13.....	A-72
A4.14-1. Summary of Event Trees for CRC-ESD-14.....	A-73
A4.14-2. Initiating Event Assignments for CRCF-ESD-14.....	A-73
A4.14-3. Basic Events Associated with the CANISTER Pivotal Events of CRC-ESD-14...	A-73
A4.14-4. Basic Event Associated with the SHIELDING Pivotal Events of CRC-ESD-14...	A-74
A4.14-5. Basic Event Associated with the CONFINEMENT Pivotal Events of CRC-ESD-14.....	A-74
A4.14-6. Basic Event Associated with the MODERATOR Pivotal Events of CRC-ESD-14.....	A-74
A4.15-1. Summary of Event Trees for CRC-ESD-15.....	A-75
A4.15-2. Initiating Event Assignments for CRCF-ESD-15.....	A-76
A4.15-3. Basic Event Associated with the Waste Package Pivotal Events of CRC-ESD-15.....	A-76

TABLES (Continued)

	Page
A4.15-4. Basic Events Associated with the CANISTER Pivotal Events of CRC-ESD-15 ...	A-77
A4.15-5. Basic Events Associated with the SHIELDING Pivotal Events of CRC-ESD-15.....	A-78
A4.15-6. Basic Event Associated with the CONFINEMENT Pivotal Events of CRC-ESD-15.....	A-78
A4.15-7. Basic Event Associated with the MODERATOR Pivotal Events of CRC-ESD-15.....	A-79
A4.16-1. Summary of Event Trees for CRC-ESD-16.....	A-80
A4.16-2. Initiating Event Assignments for CRC-ESD-16.....	A-81
A4.16-3. Basic Events Associated with the CANISTER Pivotal Events of CRC-ESD-16...	A-81
A4.16-4. Basic Event Associated with the SHIELDING Pivotal Events of CRC-ESD-016.....	A-82
A4.16-5. Basic Event Associated with the CONFINEMENT Pivotal Events of CRC-ESD-16.....	A-82
A4.16-6. Basic Event Associated with the MODERATOR Pivotal Events of CRC-ESD-016.....	A-82
A4.17-1. Summary of Event Trees for CRC-ESD-17.....	A-83
A4.17-2. Initiating Event Assignments for CRC-ESD-17.....	A-83
A4.18-1. Summary of Event Trees for CRC-ESD-18.....	A-84
A4.18-2. Initiating Event Assignments for CRC-ESD-18.....	A-85
A4.19-1. Summary of Event Trees for CRC-ESD-19.....	A-85
A4.20-1. Summary of Event Trees for CRC-ESD-20.....	A-87
A4.20-2. Initiating Event Assignments for CRC-ESD-20.....	A-88
A4.20-3. Basic Events Associated with the CANISTER Pivotal Events of CRC-ESD-20 ...	A-89
A4.20-4. Fault Tree Associated with the SHIELDING Pivotal Events of CRC-ESD-020 ...	A-91
A4.20-5. Fault Tree Associated with the CONFINEMENT Pivotal Events of CRC-ESD-020.....	A-93
A4.20-6. Basic Event Associated with the MODERATOR Pivotal Events of CRC-ESD-020.....	A-94
A5-1. ESDs to Event Trees	A-97

ATTACHMENT A EVENT TREES

A1 INTRODUCTION

This attachment presents event trees that are derived from the ESDs in Attachment F of the *Canister Receipt and Closure Facility Event Sequence Development Analysis* (Ref. 2.2.33). All initiator event trees and system response event trees are located at the end of this attachment. Refer to Table A5-1 for the figure locations of specific event and response trees. The event trees are presented in Figures A5-2 through A5-86 according to ordering rules of hierarchy in SAPHIRE. The first rule is that event trees are presented in ESD order. For example, the event trees associated with CRCF-ESD-01 appear first, and those associated with CRCF-ESD-02 appear after that, and so on. The second rule is that the first initiator event tree associated with the ESD appears first and the system response event trees are placed immediately following the first initiator event tree followed by the remaining initiator event trees for the ESD. For example, the first initiator event tree (CRCF-ESD01-DPC) associated with the first ESD (CRCF-ESD-01) is the first event tree figure. Then the system response event tree (RESPONSE-TCASK1) appears, followed by the remaining initiator event trees for the ESD (CRCF-ESD01-DSTD, CRCF-ESD01-HLW, CRCF-ESD01-MCO, and CRCF-ESD01-TAD). The same kind of ordering is done for each group in turn.

A2 READER'S GUIDE TO THE EVENT TREE DESCRIPTIONS

The following sections are organized by ESD. The event trees that correspond to each ESD are presented as follows:

1. The event trees for the waste forms covered are briefly described and listed (initiator and system-response event trees or self contained event trees, as applicable).
2. The initiating events are described and listed. The listing is provided as a table that includes the assignments of fault trees or basic events to the initiating events. The assignments are made in SAPHIRE using basic rules or by fault-tree construction. The goal of the initiating event table is to provide a link to the underlying system fault tree (covered in Section 6.2 and Attachment B) or basic event (covered in Section 6.3 and Attachment C). In a few cases, the assignment is not straightforward and a supplemental fault tree provides a link to the system fault tree or basic event level (covered in Attachment B). Note that the initiating event frequencies are defined on a per-unit-handled basis. Thus, when the initiating event frequencies are multiplied by the number of units handled over the preclosure period, the result is an initiating event frequency over the preclosure period.
3. The system-response event tree that corresponds to the initiator event tree or the system response for a self-contained event tree is covered as follows. Each pivotal event used in an event tree is listed in the event tree description section and summarized in Section A3. Each pivotal event is accompanied by a table that provides a link between the name given to the pivotal event in the event tree and the associated system fault tree or basic event. The goal of the pivotal event table is to provide a link

to the underlying system fault tree (covered in Section 6.2) or basic event (covered in Section 6.3). In a few cases, the assignment is not straightforward and a supplemental fault tree provides a link to the system fault tree or basic event level.

A3 SUMMARY OF THE MAJOR PIVOTAL EVENT TYPES

A self-contained event tree or a system response event tree may include pivotal events of following types:

CELL-DOOR. This pivotal event represents the success or failure of the shield door to not fail and damage waste forms.

WP. This pivotal event represents the success or failure of the waste package to contain radioactive material after the impact caused by the initiating event. The failure of this pivotal event leads to loss of the waste package's containment function. The failure probability for this pivotal event depends on the selection of initiating event and is determined by PEFA, and is given in Table 6.3-4 in Section 6.3.2.2.

TRANSCASK. This pivotal event represents the success or failure of the transportation cask to contain radioactive material after the impact caused by the initiating event. The failure of this pivotal event leads to the loss of the cask's containment function. The failure probability for this pivotal event is determined by PEFA, and is given in Table 6.3-4 in Section 6.3.2.2. In accordance with a simplifying approximation, the same failure probability is used for all casks for the various initiating events.

CANISTER. This pivotal event represents the success or failure of the canister to contain radioactive material after the impact caused by the initiating event. Failure of a containment pivotal event means that a release could occur if the canister containment barrier is breached (along with the cask or waste-package containment, as applicable). In accordance with a simplifying approximation, the conditional probability of canister breach given cask breach is taken to be 1.

SHIELDING. Failure of a shielding pivotal event means that a direct exposure could occur. Casks, some canisters, the cask transfer machine shield bell, and the aging overpack include integral shields that could be pierced or degraded in some impact events. In addition, a breach of a container's seal can also result in a loss of shielding. Thus, this pivotal event represents the success or failure of the shielding function of the cask, canister, or aging overpack after the impact caused by the initiating event. Failure of shielding in this instance refers to an unspecified degree of shielding degradation due to the impact.

CONFINEMENT. This pivotal event represents the success or failure of the HVAC system in continuing to provide HEPA filtration (radiological confinement) after the initiating event. Success of the pivotal event requires the facility structural integrity as well as the functioning of equipment associated with the HVAC system. Failure results in a potential airborne release that is not mitigated by the HEPA filtration system.

MODERATOR. This pivotal event represents the conditional probability of introducing liquid moderator (water or crane gearbox lubricating oil) into a breached canister, given that a breached

canister is present. The conditional probability of failure (introduction of liquid moderator) is the same for all waste forms and all initiating events. Failure of a moderator pivotal event results in an end state that may be susceptible to nuclear criticality. The opportunity for criticality also depends on other pivotal events (e.g., loss of containment, which may allow liquid moderator into a breached canister) and physical properties of the waste form. HLW is not subject to the possibility of criticality; therefore, all moderator trees pertaining to criticality sequences for HLW are set to “0.00E+00.”

Each of the specific failure events included in a self-contained or system-response event tree may be linked to a basic event or to the top event of a fault tree that represents equipment failure modes and human failure events that can initiate the specific event. The fault tree models are, in turn, linked to basic events that provide the failure frequencies. Some of the pivotal events represent failure of equipment whose failure probabilities are linked to a separately developed basic event and not to a fault tree.

A4 EVENT TREE DESCRIPTIONS

A4.1 EVENT TREES FOR CRC-ESD-01

CRC-ESD-01 covers event sequences associated with receipt of a truck trailer or railcar carrying a transportation cask (Ref. 2.2.33, Figure F-1). This ESD covers five types of transportation casks. Corresponding to each type of cask is an initiator event tree (Table A4.1-1). Although the initiator event trees transfer to the same system-response event tree, it is customized within SAPHIRE for each initiator event tree by the use of basic rules. The rules instruct SAPHIRE where to look for the fault tree that models each pivotal event. The assignments made in the rules files are indicated in this section.

Table A4.1-1. Summary of Event Trees for CRC-ESD-01

Waste Form Unit	Associated Event Trees	Number of Waste Form Units
Transportation cask containing a DPC	Initiator: CRCF-ESD01-DPC Response: RESPONSE-TCASK1	346
Transportation cask containing DOE Standardized SNF canisters	Initiator: CRCF-ESD01-DSTD Response: RESPONSE-TCASK1	385
Rail-based Transportation cask containing HLW canisters	Initiator: CRCF-ESD01-HLW Response: RESPONSE-TCASK1	1,960
Transportation cask containing MCOs	Initiator: CRCF-ESD01-MCO Response: RESPONSE-TCASK1	113
Transportation cask containing a TAD canister	Initiator: CRCF-ESD01-TAD Response: RESPONSE-TCASK1	6,978

Source: Ref. 2.2.31, Table 4

A4.1.1 Initiating Events for CRC-ESD-01

The following initiating events are associated with CRC-ESD-01. The assignments made within SAPHIRE for quantification of these initiating events are indicated in Table A4.1-2.

Railcar Derailment. This initiating event accounts for the potential impact to the transportation cask on the railcar due to a derailment. The fault tree accounts for the fraction of casks received that are rail casks as opposed to truck casks. This fraction is set to one to reflect the expectation that only rail casks will be received at the CRCF.

Railcar or Truck Trailer Collision. This initiating event covers the potential impact to the transportation cask on the conveyance due to a collision with another vehicle. The fault tree accounts for the fraction of casks received that are truck casks as opposed to rail casks.

Truck Trailer Rollover. This initiating event accounts for the potential impact to the transportation cask on the truck trailer due to a rollover. Rollover is not considered possible under the conditions inside the CRCF. Therefore, the probability of truck rollover per truck cask received is modeled as a single-event fault tree with guaranteed success (Section 6.0.3).

Table A4.1-2. Initiating Event Assignments for CRC-ESD-01

Initiating Event Description	Initiating Event Tree	SAPHIRE Assignment by Basic Rules	SAPHIRE Assignment at Fault Tree Level ^a
Railcar derailment	CRCF-ESD01-DPC	ESD1-DPC-DETRAIL	060-1-SPMRC-DETRAIL
	CRCF-ESD01-DSTD	ESD1-DSNF-DETRAIL	060-1-SPMRC-DETRAIL AND 060-PERCENT-DSNF-ON-RC
	CRCF-ESD01-HLW	ESD1-HLW-DETRAIL	060-1-SPMRC-DETRAIL AND 060-PERCENT-HLW-ON-RC
	CRCF-ESD01-MCO	ESD1-MCO-DETRAIL	060-1-SPMRC-DETRAIL AND 060-PERCENT-MCO-ON-RC
	CRCF-ESD01-TAD	ESD1-TAD-DETRAIL	060-1-SPMRC-DETRAIL
Railcar or truck trailer collision	CRCF-ESD01-DPC	ESD1-DPC-COLLIDE	060-1-SPMRC-COLLISION AND 060-PERCENT-DPC--ON-RC OR 060-1-SPMTT-COLLISION AND 060-PERCENT-DPC-ON-TT

Table A4.1-2. Initiating Event Assignments for CRC-ESD-01 (Continued)

Initiating Event Description	Initiating Event Tree	SAPHIRE Assignment by Basic Rules	SAPHIRE Assignment at Fault Tree Level ^a
Railcar or truck trailer collision	CRCF-ESD01-DSTD	ESD1-MCO-COLLIDE	060-1-SPMRC-COLLISION AND 060-PERCENT- DSNF --ON-RC OR 060-1-SPMTT-COLLISION AND 060-PERCENT- DSNF -ON-TT
Railcar or truck trailer collision	CRCF-ESD01-HLW	ESD1-HLW-COLLIDE	060-1-SPMRC-COLLISION AND 060-PERCENT- HLW --ON-RC OR 060-1-SPMTT-COLLISION AND 060-PERCENT- HLW -ON-TT
Railcar or truck trailer collision	CRCF-ESD01-MCO	ESD1-DSNF-COLLIDE	060-1-SPMRC-COLLISION AND 060-PERCENT- MCO --ON-RC OR 060-1-SPMTT-COLLISION AND 060-PERCENT- MCO -ON-TT
Railcar or truck trailer collision	CRCF-ESD01-TAD	ESD1-TAD-COLLIDE	060-1-SPMRC-COLLISION AND 060-PERCENT- TAD --ON-RC OR 060-1-SPMTT-COLLISION AND 060-PERCENT- TAD -ON-TT

Table A4.1-2. Initiating Event Assignments for CRC-ESD-01 (Continued)

Initiating Event Description	Initiating Event Tree	SAPHIRE Assignment by Basic Rules	SAPHIRE Assignment at Fault Tree Level ^a
Truck trailer rollover	CRCF-ESD01-DSTD	ESD1-DSNF-ROLLOVER	Screened out (Section 6.1)
	CRCF-ESD01-HLW	ESD1-HLW-ROLLOVER	
	CRCF-ESD01-MCO	ESD1-DSNF-ROLLOVER	

NOTE: ^aThis column may contain fault trees and basic events. See Attachment B for fault trees and Attachment C for basic events.

Source: Original

A4.1.2 System Response Event Tree RESPONSE-TCASK1

The pivotal events that appear in RESPONSE-TCASK1 follow and are summarized in Section A3. The accompanying tables show the association of pivotal event names with basic event or fault tree names.

TRANSCASK. Table A4.1-3 indicates the basic event that is associated with this pivotal event for each initiating event.

Table A4.1-3. Basic Event Associated with the TRANSCASK Pivotal Events of CRC-ESD-01

Initiator Event Tree	Initiating Event Name	Name Assigned to TRANSCASK	Associated Fault Tree or Basic Event ^a
CRCF-ESD01-DPC	ESD1-DPC-DERAIL	ESD1-DPC-DERAIL-TCASK	01-TCASK_RC_DERAIL
	ESD1-DPC-COLLIDE	ESD1-DPC-COLLIDE-TCASK	01-TCASK_RC_COLL
CRCF-ESD01-DSTD	ESD1-DSNF-DERAIL	ESD1-DSNF-DERAIL-TCASK	01-TCASK_RC_DERAIL
	ESD1-DSNF-ROLLOVER	ESD1=DSNF=ROLLOVER-TCASK	01-TCASK_TT_ROLLOVER
	ESD1-DSNF-COLLIDE	ESD1-DSNF-COLLIDE-TCASK	01-TCASK_RC_COLL
CRCF-ESD01-HLW	ESD1-HLW-DERAIL	ESD1-HLW-DERAIL-TCASK	01-TCASK_RC_DERAIL
	ESD1-HLW-ROLLOVER	ESD1-HLW-ROLLOVER-TCASK	01-TCASK_TT_ROLLOVER
	ESD1-HLW-COLLIDE	ESD1-HLW-COLLIDE-TCASK	01-TCASK_RC_COLL
CRCF-ESD01-MCO	ESD1-MCO-DERAIL	ESD1-MCO-DERAIL-TCASK	01-TCASK_RC_DERAIL
	ESD1-MCO-ROLLOVER	ESD1-MCO-ROLLOVER-TCASK	01-TCASK_TT_ROLLOVER
	ESD1-MCO-COLLIDE	ESD1-MCO-COLLIDE-TCASK	01-TCASK_RC_COLL

Table A4.1-3. Basic Event Associated with the TRANSCASK Pivotal Events of CRC-ESD-01 (Continued)

Initiator Event Tree	Initiating Event Name	Name Assigned to TRANSCASK	Associated Fault Tree or Basic Event ^a
CRCF-ESD01-TAD	ESD1-TAD-DERAIL	ESD1-TAD-DERAIL-TCASK	01-TCASK_RC_DERAIL
	ESD1-TAD-COLLIDE	ESD1-TAD-COLLIDE-TCASK	01-TCASK_RC_COLL

NOTE: ^a This column may contain fault trees and basic events. See Attachment B for fault trees and Attachment C for basic events.

Source: Original

CANISTER. Table A4.1-4 indicates the basic event that is associated with this pivotal event for each initiating event.

Table A4.1-4. Basic Events Associated with the CANISTER Pivotal Events of CRC-ESD-01

Initiator Event Tree	Initiating Event Name	Name Assigned to CANISTER	Associated Fault Tree or Basic Event ³
CRCF-ESD01-DPC	ESD1-DPC-DERAIL	ESD1-DPC-DERAIL-CAN	01-DPC_FAIL_IN_TC
	ESD1-DPC-COLLIDE	ESD1-DPC-COLLIDE-CAN	
CRCF-ESD01-DSTD	ESD1-DSNF-DERAIL	ESD1-DSNF-DERAIL-CAN	01-DSNF_FAIL_IN_TC
	ESD1-DSNF-ROLLOVER	ESD1-DSNF-ROLLOVER-CAN	
	ESD1-DSNF-COLLIDE	ESD1-DSNF-COLLIDE-CAN	
CRCF-ESD01-HLW	ESD1-HLW-DERAIL	ESD1-HLW-DERAIL-CAN	01-HLW_FAIL_IN_TC
	ESD1-HLW-ROLLOVER	ESD1-HLW-ROLLOVER-CAN	
	ESD1-HLW-COLLIDE	ESD1-HLW-COLLIDE-CAN	
CRCF-ESD01-MCO	ESD1-MCO-DERAIL	ESD1-MCO-DERAIL-CAN	01-MCO_FAIL_IN_TC
	ESD1-MCO-ROLLOVER	ESD1-MCO-ROLLOVER-CAN	
	ESD1-MCO-COLLIDE	ESD1-MCO-COLLIDE-CAN	
CRCF-ESD01-TAD	ESD1-TAD-DERAIL	ESD1-TAD-DERAIL-CAN	01-TAD_FAIL_IN_TC
	ESD1-TAD-COLLIDE	ESD1-TAD-COLLIDE-CAN	

NOTE: ^a This column may contain fault trees and basic events. See Attachment B for fault trees and Attachment C for basic events.

Source: Original

SHIELDING. Table A4.1-5 indicates the basic event that is associated with this pivotal event for each initiating event.

Table A4.1-5. Basic Event Associated with the SHIELDING Pivotal Events of CRC-ESD-01

Initiator Event Tree	Initiating Event Name	Name Assigned to SHIELDING	Associated Fault Tree or Basic Event ^a
CRCF-ESD01-DPC	ESD1-DPC-DERAIL	ESD1-DPC-DERAIL-SHIELD	CASK-SHIELDING
	ESD1-DPC-COLLIDE	ESD1-DPC-COLLIDE-SHIELD	
CRCF-ESD01-DSTD	ESD1-DSNF-DERAIL	ESD1-DSNF-DERAIL-SHIELD	
	ESD1-DSNF-ROLLOVER	ESD1-DSNF-ROLLOVER-SHIELD	
	ESD1-DSNF-COLLIDE	ESD1-DSNF-COLLIDE-SHIELD	

Table A4.1-5. Basic Event Associated with the SHIELDING Pivotal Events of CRC-ESD-01 (Continued)

Initiator Event Tree	Initiating Event Name	Name Assigned to SHIELDING	Associated Fault Tree or Basic Event ^a
CRCF-ESD01-HLW	ESD1-HLW-DERAIL	ESD1-HLW-DERAIL-SHIELD	
	ESD1-HLW-ROLLOVER	ESD1-HLW-ROLLOVER-SHIELD	
	ESD1-HLW-COLLIDE	ESD1-HLW-COLLIDE-SHIELD	
CRCF-ESD01-MCO	ESD1-MCO-DERAIL	ESD1-MCO-DERAIL-SHIELD	
	ESD1-MCO-ROLLOVER	ESD1-MCO-ROLLOVER-SHIELD	
	ESD1-MCO-COLLIDE	ESD1-MCO-COLLIDE-SHIELD	
CRCF-ESD01-TAD	ESD1-TAD-DERAIL	ESD1-TAD-DERAIL-SHIELD	
	ESD1-TAD-COLLIDE	ESD1-TAD-COLLIDE-SHIELD	

NOTE: ^a This column may contain fault trees and basic events. See Attachment B for fault trees and Attachment C for basic events.

Source: Original

CONFINEMENT. Table A4.1-6 specifies the fault tree that is associated with this pivotal event for each initiating event.

Table A4.1-6. Basic Event Associated with the CONFINEMENT Pivotal Events of CRC-ESD-01

Initiator Event Tree	Initiating Event Name	Name Assigned to CONFINEMENT	Associated Fault Tree or Basic Event ^a
CRCF-ESD01-DPC	ESD1-DPC-DERAIL	ESD1-CONF ^b	060-DP-LOSS-CRCF
	ESD1-DPC-COLLIDE		
CRCF-ESD01-DSNF	ESD1-DSNF-DERAIL		
	ESD1-DSNF-ROLLOVER		
	ESD1-DSNF-COLLIDE		
CRCF-ESD01-HLW	ESD1-HLW-DERAIL		
	ESD1-HLW-ROLLOVER		
	ESD1-HLW-COLLIDE		
CRCF-ESD01-MCO	ESD1-MCO-DERAIL		
	ESD1-MCO-ROLLOVER		
	ESD1-MCO-COLLIDE		
CRCF-ESD01-TAD	ESD1-TAD-DERAIL		
	ESD1-TAD-COLLIDE		

NOTE: ^a This column may contain fault trees and basic events. See Attachment B for fault trees and Attachment C for basic events.

^b This passes through a transfer tree named CONFINEMENT.

Source: Original

MODERATOR. The conditional probability of failure (introduction of liquid moderator) is the same for all waste forms and all initiating events as shown in Table A4.1-7.

Table A4.1-7. Basic Event Associated with the MODERATOR Pivotal Events of CRC-ESD-01

Initiator Event Tree	Initiating Event Name	Name Assigned to MODERATOR	Associated Fault Tree or Basic Event ^a
CRCF-ESD01-DPC	ESD1-DPC-DETRAIL	ESD1-MOD	060-MODERATOR-SOURCE
	ESD1-DPC-COLLIDE		
CRCF-ESD01-DSNF	ESD1-DSNF-DETRAIL		
	ESD1-DSNF-ROLLOVER		
	ESD1-DSNF-COLLIDE		
CRCF-ESD01-HLW	ESD1-HLW-DETRAIL		
	ESD1-HLW-ROLLOVER		
	ESD1-HLW-COLLIDE		
CRCF-ESD01-MCO	ESD1-MCO-DETRAIL		060-MODERATOR-SOURCE
	ESD1-MCO-ROLLOVER		
	ESD1-MCO-COLLIDE		
CRCF-ESD01-TAD	ESD1-TAD-DETRAIL		
	ESD1-TAD-COLLIDE		

NOTE: ^a This column may contain fault trees and basic events. See Attachment B for fault trees and Attachment C for basic events.

Source: Original

A4.2 EVENT TREES FOR CRC-ESD-02

CRC-ESD-02 covers event sequences associated with receipt of a site transporter carrying a TAD canister in an aging overpack (Ref. 2.2.33, Figure F-2). An initiator event tree and a system response event tree represent the ESD (Table A4.2-1). The system response tree is customized within SAPHIRE for the initiator event tree by the use of basic rules. The assignments made in the rules files are indicated in this section.

Table A4.2-1. Summary of Event Trees for CRC-ESD-02

Waste Form Unit	Associated Event Trees	Number of Waste Form Units
Aging overpack holding a TAD canister	Initiator: CRCF-ESD02-TAD Response: RESPONSE-AO1	8,143

Source: Ref. 2.2.31 Table 4

A4.2.1 Initiating Events for CRC-ESD-02

The following initiating events are associated with CRC-ESD-02. The assignments made within SAPHIRE for quantification of these initiating events are indicated in Table A4.2-2.

Site Transporter Rollover. This initiating event accounts for the potential impact to the TAD canister due to a rollover of the site transporter or a drop of the aging overpack from the site transporter. For a site transporter to roll over, the center of mass would have to shift laterally. This could result from traversing a significantly uneven surface, running over a very large object

or failure of the site transporter tracks. There are no significantly uneven surfaces in the CRCF Entrance Vestibule or Cask Preparation Room; however, rollover may occur upon track failure. A drop may occur due to failure of the lifting/lowering system of the site transporter. The probability of rollover or drop per TAD canister received is modeled as a fault tree as described in Attachment B. The initiating event is specified as a probability of a rollover or drop per TAD canister.

Site Transporter Collision. This initiating event accounts for the potential impact to the TAD canister due to a collision involving the site transporter. The probability of collision per TAD canister received is modeled as a fault tree as described in Attachment B. The initiating event is specified as a probability of collision per TAD canister.

Table A4.2-2. Initiating Event Assignments for CRC-ESD-02

Initiating Event Description	Initiator Event Tree	SAPHIRE Assignment by Basic Rules	SAPHIRE Assignment at Fault Tree Level ^a
Site transporter rollover	CRCF-ESD02-TAD	ESD2-AO-ROLLOVER	060-16-ST-AO-DROP OR 060-2-ST-ROLLOVER ^b
Site transporter collision		ESD2-AO-COLLIDE	060-2-ST-COLLISION

NOTE: ^a This column may contain fault trees and basic events. See Attachment B for fault trees and Attachment C for basic events.

^b Fault trees connected by an OR gate.

Source: Original

A4.2.2 System Response Event Tree RESPONSE-AO1

The pivotal events that appear in RESPONSE-AO1 are indicated below and summarized in Section A3. The accompanying tables show the association of pivotal event names with basic event or fault tree names.

CANISTER. Table A4.2-3 indicates the basic event that is associated with this pivotal event for each initiating event.

Table A4.2-3. Basic Events Associated with the CANISTER Pivotal Events of CRC-ESD-02

Initiator Event Tree	Initiating Event Name	Name Assigned to CANISTER	Associated Fault Tree or Basic Event ^a
CRCF-ESD02-TAD	ESD2-AO-ROLLOVER	ESD2-AO-ROLLOVER-CAN	02-CAN-STAO_ROLL_DROP
	ESD2-AO-COLLIDE	ESD2-AO-COLLIDE-CAN	02-ST_AO_COLLIDE

NOTE: ^a This column may contain fault trees and basic events. See Attachment B for fault trees and Attachment C for basic events.

Source: Original

SHIELDING. Table A4.2-4 indicates the basic event that is associated with this pivotal event for each initiating event.

Table A4.2-4. Basic Event Associated with the SHIELDING Pivotal Events of CRC-ESD-02

Initiator Event Tree	Initiating Event Name	Name Assigned to SHIELDING	Associated Fault Tree or Basic Event ^a
CRCF-ESD02-TAD	ESD2-AO-ROLLOVER	ESD2-AO-ROLLOVER-SHIELD	AO_SHIELDING
	ESD2-AO-COLLIDE	ESD2-AO-COLLIDE-SHIELD	

NOTE: ^a This column may contain fault trees and basic events. See Attachment B for fault trees and Attachment C for basic events.

Source: Original

CONFINEMENT. Table A4.2-5 specifies the fault tree that is associated with this pivotal event for each initiating event.

Table A4.2-5. Basic Event Associated with the CONFINEMENT Pivotal Events of CRC-ESD-02

Initiator Event Tree	Initiating Event Name	Name Assigned to CONFINEMENT	Associated Fault Tree or Basic Event ^a
CRCF-ESD02-TAD	ESD2-AO-ROLLOVER	ESD2-CONF ^b	060-DP-LOSS-CRCF
	ESD2-AO-COLLIDE		

NOTE: ^a This column may contain fault trees and basic events. See Attachment B for fault trees and Attachment C for basic events.

^b This passes through a transfer tree named CONFINEMENT.

Source: Original

MODERATOR. The conditional probability of failure (introduction of liquid moderator) is the same for all waste forms and initiating events as shown in Table A4.2-6.

Table A4.2-6. Basic Event Associated with the MODERATOR Pivotal Events of CRC-ESD-02

Initiator Event Tree	Initiating Event Name	Name Assigned to MODERATOR	Associated Fault Tree or Basic Event ^a
CRCF-ESD02-TAD	ESD2-AO-ROLLOVER	ESD2-MOD	060-MODERATOR-SOURCE
	ESD2-AO-COLLIDE		

NOTE: ^a This column may contain fault trees and basic events. See Attachment B for fault trees and Attachment C for basic events.

Source: Original

A4.3 EVENT TREES FOR CRC-ESD-03

CRC-ESD-03 covers event sequences associated with removal of impact limiters from the transportation cask, upending the transportation cask, and transferring it to the CTT (Ref. 2.2.33, Figure F-3). This ESD covers five types of transportation casks. Corresponding to each type of cask is an initiator event tree (Table A4.3-1). Although the initiator event trees transfer to the same response tree, the response tree is customized within SAPHIRE for each initiator event tree by the use of basic rules. The rules instruct SAPHIRE where to look for the fault tree that models each pivotal event. The assignments made in the rules files are indicated in this section.

Table A4.3-1. Summary of Event Trees for CRC-ESD-03

Waste Form Unit	Associated Event Trees	Number of Waste Form Units
Transportation cask containing a DPC	Initiator: CRCF-ESD03-DPC Response: RESPONSE-TCASK1	346
Transportation cask containing DOE Standardized SNF canisters	Initiator: CRCF-ESD03-DSTD Response: RESPONSE-TCASK1	385
Rail-based Transportation cask containing HLW canisters	Initiator: CRCF-ESD03-HLW Response: RESPONSE-TCASK1	1,960
Transportation cask containing MCOs	Initiator: CRCF-ESD03-MCO Response: RESPONSE-TCASK1	113
Transportation cask containing a TAD canister	Initiator: CRCF-ESD03-TAD Response: RESPONSE-TCASK1	6,978

Source: Ref. 2.2.31, Table 4

A4.3.1 Initiating Events for CRCF-ESD-03

The following initiating events are associated with CRC-ESD-03. The assignments made within SAPHIRE for quantification of these initiating events are indicated in Table A4.3-2.

Cask Drop from Operational Height. This initiating event accounts for the potential impact to the transportation cask due to having been dropped from the normal operational height during transfer by the cask handling crane. The initiating event is specified as a probability of a drop per cask.

Cask Tipover. This initiating event covers the potential impact to the transportation cask due to a tipover. The initiating event is specified as a probability of tipover per cask.

Collision Involving Side Impact to Cask. This initiating event covers the potential impact to the transportation cask due to a collision of the cask due to various causes. The initiating event is specified as a probability of impact per cask.

Unplanned Carrier Movement. This initiating event covers the potential impact to the transportation cask due to an unplanned movement of the cask handling crane or cask transfer trolley. The initiating event is specified as a probability of movement per cask.

Object Dropped on Cask. This initiating event covers the potential impact to the transportation cask due to the drop of a heavy object, such as an impact limiter, on the cask by the cask handling crane. The initiating event is specified as a probability of object drop per cask.

Cask Drop from Above Operational Height. This initiating event accounts for the potential impact to the transportation cask due to having been dropped from above the normal operational height (for example, due to two-blocking) during transfer by the cask handling crane. The initiating event is specified as a probability of a drop per cask.

Table A4.3-2. Initiating Event Assignments for CRC-ESD-03

Initiating Event Description	Initiator Event Tree	SAPHIRE Assignment by Basic Rules	SAPHIRE Assignment at Fault Tree Level ^a
Cask drop from operational height	CRCF-ESD03-DPC	ESD3-DPC-DROP	060-3-DPC-CRANE-DROP OR 060-TILTFRAME-CSC-FOH ^b
	CRCF-ESD03-DSTD	ESD3-DSNF-DROP	060-3-DSNF-CRANE-DROP
	CRCF-ESD03-HLW	ESD3-HLW-DROP	060-3-HLW-CRANE-DROP
	CRCF-ESD03-MCO	ESD3-MCO-DROP	060-3-DSNF-CRANE-DROP
	CRCF-ESD03-TAD	ESD3-TAD-DROP	060-3-TAD-CRANE-DROP
Transportation cask tipover	CRCF-ESD03-DPC	ESD3-DPC-TIP	060-3-OP-TIPOVER
	CRCF-ESD03-DSTD	ESD3-DSNF-TIP	
	CRCF-ESD03-HLW	ESD3-HLW-TIP	
	CRCF-ESD03-MCO	ESD3-MCO-TIP	
	CRCF-ESD03-TAD	ESD3-TAD-TIP	
Side impact	CRCF-ESD03-DPC	ESD3-DPC-IMPACT	060-3-DPC-TC-IMPACT
	CRCF-ESD03-DSTD	ESD3-DSNF-IMPACT	060-3-DSNF-TC-IMPACT
	CRCF-ESD03-HLW	ESD3-HLW-IMPACT	060-3-HLW-TC-IMPACT
	CRCF-ESD03-MCO	ESD3-MCO-IMPACT	060-3-DSNF-TC-IMPACT
	CRCF-ESD03-TAD	ESD3-TAD-IMPACT	060-3-TAD-TC-IMPACT
Unplanned conveyance movement	CRCF-ESD03-DPC	ESD3-DPC-MOVE	060-3-DPC-TC-SPURMOVE
	CRCF-ESD03-DSTD	ESD3-DSNF-MOVE	060-3-DSNF-TC-SPURMOVE
	CRCF-ESD03-HLW	ESD3-HLW-MOVE	060-3-HLW-TC-SPURMOVE
	CRCF-ESD03-MCO	ESD3-MCO-MOVE	060-3-DSNF-TC-SPURMOVE
	CRCF-ESD03-TAD	ESD3-TAD-MOVE	060-3-TAD-TC-SPURMOVE
Object dropped on a cask	CRCF-ESD03-DPC	ESD3-DPC-DROPON	060-3-200T-CRANE-DROPON
	CRCF-ESD03-DSTD	ESD3-DSNF-DROPON	
	CRCF-ESD03-HLW	ESD3-HLW-DROPON	
	CRCF-ESD03-MCO	ESD3-MCO-DROPON	
	CRCF-ESD03-TAD	ESD3-TAD-DROPON	
Cask drop from above operational height	CRCF-ESD03-DPC	ESD3-DPC-2BLK	060-CRN2-2-BLOCK-CRN-TBK AND 060-TRANSCTTLIFTNUMBER ^c
	CRCF-ESD03-DSTD	ESD3-DSNF-2BLK	
	CRCF-ESD03-HLW	ESD3-HLW-2BLK	
	CRCF-ESD03-MCO	ESD3-MCO-2BLK	
	CRCF-ESD03-TAD	ESD3-TAD-2BLK	

NOTE: ^a This column may contain fault trees and basic events. See Attachment B for fault trees and Attachment C for basic events.

^b Basic event and fault tree connected by an OR gate.

^c Basic events connected by an AND gate.

Source: Original

A4.3.2 System Response Event Tree RESPONSE-TCASK1

The pivotal events that appear in RESPONSE-TCASK1 are indicated below and summarized in Section A3. The accompanying tables show the association of pivotal event names with basic event or fault tree names.

TRANSCASK. Table A4.3-3 indicates the basic event that is associated with this pivotal event for each initiating event.

Table A4.3-3. Basic Event Associated with the TRANSCASK Pivotal Events of CRC-ESD-03

Initiator Event Tree	Initiating Event	Name Assigned to TRANSCASK	Associated Fault Tree or Basic Event ^a
CRCF-ESD03-DPC	ESD3-DPC-DROP	ESD3-DPC-DROP-TCASK	03-TCASK-DROP
	ESD3-DPC-TIP	ESD3-DPC-TIP-TCASK	03-TCASK_TIPOVER
	ESD3-DPC-IMPACT	ESD3-DPC-IMPACT-TCASK	03-TCASK_SIMPACT
	ESD3-DPC-MOVE	ESD3-DPC-MOVE-TCASK	03-TCASK_IMPACT
	ESD3-DPC-DROPON	ESD3-DPC-DROPON-TCASK	03-TCASK-DROPON
	ESD3-DPC-2BLK	ESD3-DPC-2BLK-TCASK2	03-TCASK_2BLK
CRCF-ESD03-DSTD	ESD3-DSNF-DROP	ESD3-DSNF-DROP-TCASK	03-TCASK-DROP
	ESD3-DSNF-TIP	ESD3-DSNF-TIP-TCASK	03-TCASK_TIPOVER
	ESD3-DSNF-IMPACT	ESD3-DSNF-IMPACT-TCASK	03-TCASK_SIMPACT
	ESD3-DSNF-MOVE	ESD3-DSNF-MOVE-TCASK	03-TCASK_IMPACT
	ESD3-DSNF-DROPON	ESD3-DSNF-DROPON-TCASK	03-TCASK-DROPON
	ESD3-DSNF-2BLK	ESD3-DSNF-2BLK-TCASK2	03-TCASK_2BLK
CRCF-ESD03-HLW	ESD3-HLW-DROP	ESD3-HLW-DROP-TCASK	03-TCASK-DROP
	ESD3-HLW-TIP	ESD3-HLW-TIP-TCASK	03-TCASK_TIPOVER
	ESD3-HLW-IMPACT	ESD3-HLW-IMPACT-TCASK	03-TCASK_SIMPACT
	ESD3-HLW-MOVE	ESD3-HLW-MOVE-TCASK	03-TCASK_IMPACT
	ESD3-HLW-DROPON	ESD3-HLW-DROPON-TCASK	03-TCASK-DROPON
	ESD3-HLW-2BLK	ESD3-HLW-2BLK-TCASK2	03-TCASK_2BLK
CRCF-ESD03-MCO	ESD3-DSNF-DROP	ESD3-DSNF-DROP-TCASK	03-TCASK-DROP
	ESD3-DSNF-TIP	ESD3-DSNF-TIP-TCASK	03-TCASK_TIPOVER
	ESD3-DSNF-IMPACT	ESD3-DSNF-IMPACT-TCASK	03-TCASK_SIMPACT
	ESD3-DSNF-MOVE	ESD3-DSNF-MOVE-TCASK	03-TCASK_IMPACT
	ESD3-DSNF-DROPON	ESD3-DSNF-DROPON-TCASK	03-TCASK-DROPON
	ESD3-DSNF-2BLK	ESD3-DSNF-2BLK-TCASK2	03-TCASK_2BLK
CRCF-ESD03-TAD	ESD3-TAD-DROP	ESD3-TAD-DROP-TCASK	03-TCASK-DROP
	ESD3-TAD-TIP	ESD3-TAD-TIP-TCASK	03-TCASK_TIPOVER
	ESD3-TAD-IMPACT	ESD3-TAD-IMPACT-TCASK	03-TCASK_SIMPACT
	ESD3-TAD-MOVE	ESD3-TAD-MOVE-TCASK	03-TCASK_IMPACT
	ESD3-TAD-DROPON	ESD3-TAD-DROPON-TCASK	03-TCASK-DROPON
	ESD3-TAD-2BLK	ESD3-TAD-2BLK-TCASK2	03-TCASK_2BLK

NOTE: ^aThis column may contain fault trees and basic events. See Attachment B for fault trees and Attachment C for basic events.

Source: Original

CANISTER. Table A4.3-4 indicates the basic event that is associated with this pivotal event for each initiating event.

Table A4.3-4. Basic Events Associated with the CANISTER Pivotal Events of CRC-ESD-03

Initiator Event Tree	Initiating Event	Name Assigned to CANISTER	Associated Fault Tree or Basic Event ^a
CRCF-ESD03-DPC	ESD3-DPC-DROP	ESD3-DPC-DROP-CAN	03-DPC_FAIL_IN_TC
	ESD3-DPC-TIP	ESD3-DPC-TIP-CAN	
	ESD3-DPC-IMPACT	ESD3-DPC-IMPACT-CAN	
	ESD3-DPC-MOVE	ESD3-DPC-MOVE-CAN	
	ESD3-DPC-DROPON	ESD3-DPC-DROPON-CAN	
	ESD3-DPC-2BLK	ESD3-DPC-2BLK-CAN2	03-DPC_FAIL_IN_TC_2BL
CRCF-ESD03-DSTD	ESD3-DSNF-DROP	ESD3-DSNF-DROP-CAN	03-DSTD_FAIL_IN_TC
	ESD3-DSNF-TIP	ESD3-DSNF-TIP-CAN	
	ESD3-DSNF-IMPACT	ESD3-DSNF-IMPACT-CAN	
	ESD3-DSNF-MOVE	ESD3-DSNF-MOVE-CAN	
	ESD3-DSNF-DROPON	ESD3-DSNF-DROPON-CAN	
	ESD3-DSNF-2BLK	ESD3-DSNF-2BLK-CAN2	03-DSTD_FAIL_IN_TC_2BL
CRCF-ESD03-HLW	ESD3-HLW-DROP	ESD3-HLW-DROP-CAN	03-HLW_FAIL_IN_TC
	ESD3-HLW-TIP	ESD3-HLW-TIP-CAN	
	ESD3-HLW-IMPACT	ESD3-HLW-IMPACT-CAN	
	ESD3-HLW-MOVE	ESD3-HLW-MOVE-CAN	
	ESD3-HLW-DROPON	ESD3-HLW-DROPON-CAN	
	ESD3-HLW-2BLK	ESD3-HLW-2BLK-CAN2	03-HLW_FAIL_IN_TC_2BL
CRCF-ESD03-MCO	ESD3-DSNF-DROP	ESD3-DSNF-DROP-CAN	03-DSTD_FAIL_IN_TC
	ESD3-DSNF-TIP	ESD3-DSNF-TIP-CAN	
	ESD3-DSNF-IMPACT	ESD3-DSNF-IMPACT-CAN	
	ESD3-DSNF-MOVE	ESD3-DSNF-MOVE-CAN	
	ESD3-DSNF-DROPON	ESD3-DSNF-DROPON-CAN	
	ESD3-DSNF-2BLK	ESD3-DSNF-2BLK-CAN2	03-DSTD_FAIL_IN_TC_2BL
CRCF-ESD03-TAD	ESD3-TAD-DROP	ESD3-TAD-DROP-CAN	03-TAD_FAIL_IN_TC
	ESD3-TAD-TIP	ESD3-TAD-TIP-CAN	
	ESD3-TAD-IMPACT	ESD3-TAD-IMPACT-CAN	
	ESD3-TAD-MOVE	ESD3-TAD-MOVE-CAN	
	ESD3-TAD-DROPON	ESD3-TAD-DROPON-CAN	
	ESD3-TAD-2BLK	ESD3-TAD-2BLK-CAN2	03-TAD_FAIL_IN_TC_2BL

NOTE: ^a This column may contain fault trees and basic events. See Attachment B for fault trees and Attachment C for basic events.

Source: Original

SHIELDING. Table A4.3-5 indicates the basic event that is associated with this pivotal event for each initiating event.

Table A4.3-5. Basic Events Associated with the SHIELDING Pivotal Events of CRC-ESD-03

Initiator Event Tree	Initiating Event	Name Assigned to SHIELDING	Associated Fault Tree or Basic Event ^a
CRCF-ESD03-DPC	ESD3-DPC-DROP	ESD3-DPC-DROP-SHIELD	CASK-SHIELDING-DROP
	ESD3-DPC-TIP	ESD3-DPC-TIP-SHIELD	CASK-SHIELDING-DROP
	ESD3-DPC-IMPACT	ESD3-DPC-IMPACT-SHIELD	CASK-SHIELDING
	ESD3-DPC-MOVE	ESD3-DPC-MOVE-SHIELD	CASK-SHIELDING-DROP
	ESD3-DPC-DROPON	ESD3-DPC-DROPON-SHIELD	CASK-SHIELDING-DROP
	ESD3-DPC-2BLK	ESD3-DPC-2BLK-SHIELD2	CASK-SHIELDING-2BLK
CRCF-ESD03-DSTD	ESD3-DSNF-DROP	ESD3-DSNF-DROP-SHIELD	CASK-SHIELDING-DROP
	ESD3-DSNF-TIP	ESD3-DSNF-TIP-SHIELD	CASK-SHIELDING-DROP
	ESD3-DSNF-IMPACT	ESD3-DSNF-IMPACT-SHIELD	CASK-SHIELDING
	ESD3-DSNF-MOVE	ESD3-DSNF-MOVE-SHIELD	CASK-SHIELDING-DROP
	ESD3-DSNF-DROPON	ESD3-DSNF-DROPON-SHIELD	CASK-SHIELDING-DROP
	ESD3-DSNF-2BLK	ESD3-DSNF-2BLK-SHIELD2	CASK-SHIELDING-2BLK
CRCF-ESD03-HLW	ESD3-HLW-DROP	ESD3-HLW-DROP-SHIELD	CASK-SHIELDING-DROP
	ESD3-HLW-TIP	ESD3-HLW-TIP-SHIELD	CASK-SHIELDING-DROP
	ESD3-HLW-IMPACT	ESD3-HLW-IMPACT-SHIELD	CASK-SHIELDING
	ESD3-HLW-MOVE	ESD3-HLW-MOVE-SHIELD	CASK-SHIELDING-DROP
	ESD3-HLW-DROPON	ESD3-HLW-DROPON-SHIELD	CASK-SHIELDING-DROP
	ESD3-HLW-2BLK	ESD3-HLW-2BLK-SHIELD2	CASK-SHIELDING-2BLK
CRCF-ESD03-MCO	ESD3-DSNF-DROP	ESD3-DSNF-DROP-SHIELD	CASK-SHIELDING-DROP
	ESD3-DSNF-TIP	ESD3-DSNF-TIP-SHIELD	CASK-SHIELDING-DROP
	ESD3-DSNF-IMPACT	ESD3-DSNF-IMPACT-SHIELD	CASK-SHIELDING
	ESD3-DSNF-MOVE	ESD3-DSNF-MOVE-SHIELD	CASK-SHIELDING-DROP
	ESD3-DSNF-DROPON	ESD3-DSNF-DROPON-SHIELD	CASK-SHIELDING-DROP
	ESD3-DSNF-2BLK	ESD3-DSNF-2BLK-SHIELD2	CASK-SHIELDING-2BLK
CRCF-ESD03-TAD	ESD3-TAD-DROP	ESD3-TAD-DROP-SHIELD	CASK-SHIELDING-DROP
	ESD3-TAD-TIP	ESD3-TAD-TIP-SHIELD	CASK-SHIELDING-DROP
	ESD3-TAD-IMPACT	ESD3-TAD-IMPACT-SHIELD	CASK-SHIELDING
	ESD3-TAD-MOVE	ESD3-TAD-MOVE-SHIELD	CASK-SHIELDING-DROP
	ESD3-TAD-DROPON	ESD3-TAD-DROPON-SHIELD	CASK-SHIELDING-DROP
	ESD3-TAD-2BLK	ESD3-TAD-2BLK-SHIELD2	CASK-SHIELDING-2BLK

NOTE: ^a This column may contain fault trees and basic events. See Attachment B for fault trees and Attachment C for basic events.

Source: Original

CONFINEMENT. Table A4.3-6 specifies the fault tree that is associated with this pivotal event for each initiating event.

Table A4.3-6. Basic Event Associated with the CONFINEMENT Pivotal Events of CRC-ESD-03

Initiator Event Tree	Initiating Event	Name Assigned to CONFINEMENT	Associated Fault Tree or Basic Event ^a
CRCF-ESD03-DPC	ESD3-DPC-DROP	ESD3-CONF ^b	060-DP-LOSS-CRCF
	ESD3-DPC-TIP		
	ESD3-DPC-IMPACT		
	ESD3-DPC-MOVE		
	ESD3-DPC-DROPON		
	ESD3-DPC-2BLK		
CRCF-ESD03-DSTD	ESD3-DSNF-DROP		
	ESD3-DSNF-TIP		
	ESD3-DSNF-IMPACT		
	ESD3-DSNF-MOVE		
	ESD3-DSNF-DROPON		
	ESD3-DSNF-2BLK		
CRCF-ESD03-HLW	ESD3-HLW-DROP		
	ESD3-HLW-TIP		
	ESD3-HLW-IMPACT		
	ESD3-HLW-MOVE		
	ESD3-HLW-DROPON		
	ESD3-HLW-2BLK		
CRCF-ESD03-MCO	ESD3-DSNF-DROP		
	ESD3-DSNF-TIP		
	ESD3-DSNF-IMPACT		
	ESD3-DSNF-MOVE		
	ESD3-DSNF-DROPON		
	ESD3-DSNF-2BLK		
CRCF-ESD03-TAD	ESD3-TAD-DROP		
	ESD3-TAD-TIP		
	ESD3-TAD-IMPACT		
	ESD3-TAD-MOVE		
	ESD3-TAD-DROPON		
	ESD3-TAD-2BLK		

NOTE: ^aThis column may contain fault trees and basic events. See Attachment B for fault trees and Attachment C for basic events.

^bThis passes through a transfer tree named CONFINEMENT.

Source: Original

MODERATOR. The conditional probability of failure (introduction of liquid moderator) is the same for all waste forms and initiating events as shown in Table A4.3-7.

Table A4.3-7. Basic Event Associated with the MODERATOR Pivotal Events of CRC-ESD-03

Initiator Event Tree	Initiating Event	Name Assigned to MODERATOR	Associated Fault Tree or Basic Event ^a			
CRCF-ESD03-DPC	ESD3-DPC-DROP	ESD3-MOD	060-MODERATOR-SOURCE			
	ESD3-DPC-TIP					
	ESD3-DPC-IMPACT					
	ESD3-DPC-MOVE					
	ESD3-DPC-DROPON					
	ESD3-DPC-2BLK					
CRCF-ESD03-DSTD	ESD3-DSNF-DROP			ESD3-MOD	060-MODERATOR-SOURCE	
	ESD3-DSNF-TIP					
	ESD3-DSNF-IMPACT					
	ESD3-DSNF-MOVE					
	ESD3-DSNF-DROPON					
	ESD3-DSNF-2BLK					
CRCF-ESD03-HLW	ESD3-HLW-DROP		ESD3-MOD			HLW-MODERATOR
	ESD3-HLW-TIP					
	ESD3-HLW-IMPACT					
	ESD3-HLW-MOVE					
	ESD3-HLW-DROPON					
	ESD3-HLW-2BLK					
CRCF-ESD03-MCO	ESD3-DSNF-DROP				ESD3-MOD	060-MODERATOR-SOURCE
	ESD3-DSNF-TIP					
	ESD3-DSNF-IMPACT					
	ESD3-DSNF-MOVE					
	ESD3-DSNF-DROPON					
	ESD3-DSNF-2BLK					
CRCF-ESD03-TAD	ESD3-TAD-DROP	ESD3-MOD				060-MODERATOR-SOURCE
	ESD3-TAD-TIP					
	ESD3-TAD-IMPACT					
	ESD3-TAD-MOVE					
	ESD3-TAD-DROPON					
	ESD3-TAD-2BLK					

NOTE: ^a This column may contain fault trees and basic events. See Attachment B for fault trees and Attachment C for basic events.

Source: Original

A4.4 EVENT TREES FOR CRC-ESD-04

CRC-ESD-04 covers event sequences for cask preparation activities associated with unbolting and installation of the cask lid adaptor (Ref. 2.2.33, Figure F-4). This ESD covers five types of transportation casks. Corresponding to each type of cask is an initiator event tree (Table A4.4-1). Although the initiator event trees transfer to the same response tree, the response tree is customized within SAPHIRE for each initiator event tree by the use of basic

rules. The rules instruct SAPHIRE where to look for the fault tree that models each pivotal event. The assignments made in the rules files are indicated in this section.

Table A4.4-1. Summary of Event Trees for CRC-ESD-04

Waste Form Units	Associated Event Trees	Number of Waste Form Units
Transportation cask containing a DPC	Initiator: CRCF-ES04-DPC Response: RESPONSE-TCASK1	346
Transportation cask containing DOE Standardized SNF canisters	Initiator: CRCF-ESD04-DSTD Response: RESPONSE-TCASK1	385
Rail-Based Transportation cask containing HLW canisters	Initiator: CRCF-ESD04-HLW Response: RESPONSE-TCASK1	1,960
Transportation cask containing MCOs	Initiator: CRCF-ESD04-MCO Response: RESPONSE-TCASK1	113
Transportation cask containing a TAD canister	Initiator: CRCF-ESD04-TAD Response: RESPONSE-TCASK1	6,978

Source: Ref. 2.2.31, Table 4

A4.4.1 Initiating Events for CRC-ESD-04

The following initiating events are associated with CRC-ESD-04. The assignments made within SAPHIRE for quantification of these initiating events are indicated in Table A4.4-2.

Cask Drop. This initiating event represents a potential impact to the transportation cask due to having been dropped by the cask handling crane because of a failure to remove the lid bolts before attempting to lift off the lid. The probability of this initiating event per cask received is modeled as a human error basic event. The initiating event is specified as a probability of a drop per cask.

Cask Tipover. This initiating event covers a tipover of the unsealed transportation cask due to an improper interaction of the cask or cask transfer trolley with the cask handling crane or cask preparation crane. The probability of this initiating event per cask received is modeled as a fault tree and is discussed in Attachment B or a human error basic event. The initiating event is specified as a probability of a tipover per cask.

Side Impact to Cask. This initiating event covers an impact to the side of the cask due to various causes. The probability of this initiating event per cask received is modeled as a fault tree and is discussed in Attachment B. The initiating event is specified as a probability of a tipover per cask handled.

Drop of Heavy Load onto Cask. This initiating event covers the drop of a heavy object onto the cask by the cask preparation crane. The probability of this initiating event per cask received

is modeled as a fault tree and is discussed in Attachment B. The initiating event is specified as a probability of a drop per cask.

Table A4.4-2. Initiating Event Assignments for CRCF-ESD-04

Initiating Event Description	Initiator Event Tree	SAPHIRE Assignment by Basic Rules	SAPHIRE Assignment at Fault Tree Level ^a
Cask drop	CRCF-ESD04-DPC	ESD4-DPC-DROP	060-OPCASKDROP01-HFI-NOD
	CRCF-ESD04-DSTD	ESD4-DSNF-DROP	
	CRCF-ESD04-HLW	ESD4-HLW-DROP	
	CRCF-ESD04-MCO	ESD4-MCO-DROP	
	CRCF-ESD04-TAD	ESD4-TAD-DROP	
Transportation cask tipover	CRCF-ESD04-DPC	ESD4-DPC-TIP	060-3-CRANE-SPURMOVE ^b OR 060-4-OP-CRANE-TIP-TC
	CRCF-ESD04-DSTD	ESD4-DSNF-TIP	
	CRCF-ESD04-HLW	ESD4-HLW-TIP	
	CRCF-ESD04-MCO	ESD4-MCO-TIP	
	CRCF-ESD04-TAD	ESD4-TAD-TIP	
Side impact	CRCF-ESD04-DPC	ESD4-DPC-IMPACT	ESD4-DPC-IMPACT ^b
	CRCF-ESD04-DSTD	ESD4-DSNF-IMPACT	ESD4-DSNF-IMPACT ^b
	CRCF-ESD04-HLW	ESD4-HLW-IMPACT	ESD4-HLW-IMPACT ^b
	CRCF-ESD04-MCO	ESD4-MCO-IMPACT	ESD4-MCO-IMPACT ^b
	CRCF-ESD04-TAD	ESD4-TAD-IMPACT	ESD4-TAD-IMPACT ^b
Drop of heavy load onto cask	CRCF-ESD04-DPC	ESD4-DPC-DROPON	060-DPCPRELIFTNUMBER AND 060-4-CRANE-DROP-ON-DPC ^c
	CRCF-ESD04-DSTD	ESD4-DSNF-DROPON	060-CSKPRELIFTNUMBER AND 060-4A-CRANE-DROP-ON ^c
	CRCF-ESD04-HLW	ESD4-HLW-DROPON	060-CSKPRELIFTNUMBER AND 060-4B-CRANE-DROP-ON ^c
	CRCF-ESD04-MCO	ESD4-MCO-DROPON	060-CSKPRELIFTNUMBER AND 060-4AMCO-CRANE-DROP-ON ^c
	CRCF-ESD04-TAD	ESD4-TAD-DROPON	060-CSKPRELIFTNUMBER AND 060-4C-CRANE-DROP-ON ^c

NOTE: ^a This column may contain fault trees and basic events. See Attachment B for fault trees and Attachment C for basic events.

^b Fault trees described in Attachment B.

^c Basic event and fault tree connected by an AND gate.

Source: Original

A4.4.2 System Response Event Tree RESPONSE-TCASK1

The pivotal events that appear in RESPONSE-TCASK1 are listed below and summarized in Section A3. The accompanying tables show the association of pivotal event names with basic event or fault tree names.

TRANSCASK. Table A4.4-3 indicates the basic event that is associated with this pivotal event for each initiating event.

Table A4.4-3. Basic Event Associated with the TRANSCASK Pivotal Events of CRC-ESD-04

Initiator Event Tree	Initiating Event Name	Name Assigned to TRANSCASK	Associated Fault Tree or Basic Event ^a
CRCF-ESD04-DPC	ESD4-DPC-DROP	ESD4-DPC-DROP-TCASK	04-TCASK-DROP
	ESD4-DPC-TIP	ESD4-DPC-TIP-TCASK	04-TCASK_IMPACT_TIP
	ESD4-DPC-IMPACT	ESD4-DPC-IMPACT-TCASK	04-TCASK_SIMPACT
	ESD4-DPC-DROPON	ESD4-DPC-DROPON-TCASK	04-TCASK-DROPON
CRCF-ESD04-DSTD	ESD4-DSNF-DROP	ESD4-DSNF-DROP-TCASK	04-TCASK-DROP
	ESD4-DSNF-TIP	ESD4-DSNF-TIP-TCASK	04-TCASK_IMPACT_TIP
	ESD4-DSNF-IMPACT	ESD4-DSNF-IMPACT-TCASK	04-TCASK_SIMPACT
	ESD4-DSNF-DROPON	ESD4-DSNF-DROPON-TCASK	04-TCASK-DROPON
CRCF-ESD04-HLW	ESD4-HLW-DROP	ESD4-HLW-DROP-TCASK	04-TCASK-DROP
	ESD4-HLW-TIP	ESD4-HLW-TIP-TCASK	04-TCASK_IMPACT_TIP
	ESD4-HLW-IMPACT	ESD4-HLW-IMPACT-TCASK	04-TCASK_SIMPACT
	ESD4-HLW-DROPON	ESD4-HLW-DROPON-TCASK	04-TCASK-DROPON
CRCF-ESD04-MCO	ESD4-MCO-DROP	ESD4-MCO-DROP-TCASK	04-TCASK-DROP
	ESD4-MCO-TIP	ESD4-MCO-TIP-TCASK	04-TCASK_IMPACT_TIP
	ESD4-MCO-IMPACT	ESD4-MCO-IMPACT-TCASK	05-TCASK_SIMPACT
	ESD4-MCO-DROPON	ESD4-MCO-DROPON-TCASK	04-TCASK-DROPON
CRCF-ESD04-TAD	ESD4-TAD-DROP	ESD4-TAD-DROP-TCASK	04-TCASK-DROP
	ESD4-TAD-TIP	ESD4-TAD-TIP-TCASK	04-TCASK_IMPACT_TIP
	ESD4-TAD-IMPACT	ESD4-TAD-IMPACT-TCASK	04-TCASK_SIMPACT
	ESD4-TAD-DROPON	ESD4-TAD-DROPON-TCASK	04-TCASK-DROPON

NOTE: ^a This column may contain fault trees and basic events. See Attachment B for fault trees and Attachment C for basic events.

Source: Original

CANISTER. Table A4.4-4 indicates the basic events that are associated with this pivotal event for each initiating event.

Table A4.4-4. Basic Events Associated with the CANISTER Pivotal Events of CRC-ESD-04

Initiator Event Tree	Initiating Event Name	Name Assigned to	Associated Fault Tree
----------------------	-----------------------	------------------	-----------------------

		CANISTER	or Basic Event^a
CRCF-ESD04-DPC	ESD4-DPC-DROP	ESD4-DPC-DROP-CAN	04-DPC_FAIL_IN_TC
	ESD4-DPC-TIP	ESD4-DPC-TIP-CAN	
	ESD4-DPC-IMPACT	ESD4-DPC-IMPACT-CAN	
	ESD4-DPC-DROPON	ESD4-DPC-DROPON-CAN	
CRCF-ESD04-DSTD	ESD4-DSNF-DROP	ESD4-DSNF-DROP-CAN	04-DSNF_FAIL_IN_TC
	ESD4-DSNF-TIP	ESD4-DSNF-TIP-CAN	
	ESD4-DSNF-IMPACT	ESD4-DSNF-IMPACT-CAN	
	ESD4-DSNF-DROPON	ESD4-DSNF-DROPON-CAN	
CRCF-ESD04-HLW	ESD4-HLW-DROP	ESD4-HLW-DROP-CAN	04-HLW_FAIL_IN_TC
	ESD4-HLW-TIP	ESD4-HLW-TIP-CAN	
	ESD4-HLW-IMPACT	ESD4-HLW-IMPACT-CAN	
	ESD4-HLW-DROPON	ESD4-HLW-DROPON-CAN	
CRCF-ESD04-MCO	ESD4-MCO-DROP	ESD4-MCO-DROP-CAN	04-MCO_FAIL_IN_TC
	ESD4-MCO-TIP	ESD4-MCO-TIP-CAN	
	ESD4-MCO-IMPACT	ESD4-MCO-IMPACT-CAN	
	ESD4-MCO-DROPON	ESD4-MCO-DROPON-CAN	
CRCF-ESD04-TAD	ESD4-TAD-DROP	ESD4-TAD-DROP-CAN	04-TAD_FAIL_IN_TC
	ESD4-TAD-TIP	ESD4-TAD-TIP-CAN	
	ESD4-TAD-IMPACT	ESD4-TAD-IMPACT-CAN	
	ESD4-TAD-DROPON	ESD4-TAD-DROPON-CAN	

NOTE: ^aThis column may contain fault trees and basic events. See Attachment B for fault trees and Attachment C for basic events.

Source: Original

SHIELDING. Table A4.4-5 indicates the basic event that is associated with this pivotal event for each initiating event.

Table A4.4-5. Basic Event Associated with the SHIELDING Pivotal Events of CRC-ESD-04

Initiator Event Tree	Initiating Event Name	Name Assigned to SHIELDING	Associated Fault Tree or Basic Event^a
CRCF-ESD04-DPC	ESD4-DPC-DROP	ESD4-DPC-DROP-SHIELD	CASK-SHIELDING-DROP
	ESD4-DPC-TIP	ESD4-DPC-TIP-SHIELD	CASK-SHIELDING-DROP
	ESD4-DPC-IMPACT	ESD4-DPC-IMPACT-SHIELD	CASK-SHIELDING
	ESD4-DPC-DROPON	ESD4-DPC-DROPON-SHIELD	CASK-SHIELDING-DROP
CRCF-ESD04-DSTD	ESD4-DSNF-DROP	ESD4-DSNF-DROP-SHIELD	CASK-SHIELDING-DROP
	ESD4-DSNF-TIP	ESD4-DSNF-TIP-SHIELD	CASK-SHIELDING-DROP
	ESD4-DSNF-IMPACT	ESD4-DSNF-IMPACT-SHIELD	CASK-SHIELDING
	ESD4-DSNF-DROPON	ESD4-DSNF-DROPON-SHIELD	CASK-SHIELDING-DROP
CRCF-ESD04-HLW	ESD4-HLW-DROP	ESD4-HLW-DROP-SHIELD	CASK-SHIELDING-DROP

Table A4.4-5. Basic Event Associated with the SHIELDING Pivotal Events of CRC-ESD-04 (Continued)

	ESD4-HLW-TIP	ESD4-HLW-TIP-SHIELD	CASK-SHIELDING-DROP
	ESD4-HLW-IMPACT	ESD4-HLW-IMPACT-SHIELD	CASK-SHIELDING
	ESD4-HLW-DROPON	ESD4-HLW-DROPON-SHIELD	CASK-SHIELDING-DROP
CRCF-ESD04-MCO	ESD4-MCO-DROP	ESD4-MCO-DROP-SHIELD	CASK-SHIELDING-DROP
	ESD4-MCO-TIP	ESD4-MCO-TIP-SHIELD	CASK-SHIELDING-DROP
	ESD4-MCO-IMPACT	ESD4-MCO-IMPACT-SHIELD	CASK-SHIELDING
	ESD4-MCO-DROPON	ESD4-MCO-DROPON-SHIELD	CASK-SHIELDING-DROP
CRCF-ESD04-TAD	ESD4-TAD-DROP	ESD4-TAD-DROP-SHIELD	CASK-SHIELDING-DROP
	ESD4-TAD-TIP	ESD4-TAD-TIP-SHIELD	CASK-SHIELDING-DROP
	ESD4-TAD-IMPACT	ESD4-TAD-IMPACT-SHIELD	CASK-SHIELDING
	ESD4-TAD-DROPON	ESD4-TAD-DROPON-SHIELD	CASK-SHIELDING-DROP

NOTE: ^aThis column may contain fault trees and basic events. See Attachment B for fault trees and Attachment C for basic events.

Source: Original

CONFINEMENT. Table A4.4-6 specifies the fault tree that is associated with this pivotal event for each initiating event.

Table A4.4-6. Basic Event Associated with the CONFINEMENT Pivotal Events of CRC-ESD-04

Initiator Event Tree	Initiating Event Name	Name Assigned to CONFINEMENT	Associated Fault Tree or Basic Event ^a
CRCF-ESD04-DPC	ESD4-DPC-DROP	ESD4-CONF ^b	060-DP-LOSS-CRCF
	ESD4-DPC-TIP		
	ESD4-DPC-IMPACT		
	ESD4-DPC-DROPON		
CRCF-ESD04-DSTD	ESD4-DSNF-DROP		
	ESD4-DSNF-TIP		
	ESD4-DSNF-IMPACT		
	ESD4-DSNF-DROPON		
CRCF-ESD04-HLW	ESD4-HLW-DROP		
	ESD4-HLW-TIP		
	ESD4-HLW-IMPACT		
	ESD4-HLW-DROPON		
CRCF-ESD04-MCO	ESD4-MCO-DROP		
	ESD4-MCO-TIP		
	ESD4-MCO-IMPACT		
	ESD4-MCO-DROPON		
CRCF-ESD04-TAD	ESD4-TAD-DROP		
	ESD4-TAD-TIP		

Table A4.4-6. Basic Event Associated with the CONFINEMENT Pivotal Events of CRC-ESD-04
(Continued)

Initiator Event Tree	Initiating Event Name	Name Assigned to CONFINEMENT	Associated Fault Tree or Basic Event ^a
	ESD4-TAD-IMPACT		
	ESD4-TAD-DROPON		

NOTE: ^a This column may contain fault trees and basic events. See Attachment B for fault trees and Attachment C for basic events.

^b This passes through a transfer tree named CONFINEMENT.

Source: Original

MODERATOR. The conditional probability of failure (introduction of liquid moderator) is the same for all waste forms and initiating events as shown in Table A4.4-7.

Table A4.4-7. Basic Event Associated with the MODERATOR Pivotal Events of CRC-ESD-04

Initiator Event Tree	Initiating Event Name	Name Assigned to MODERATOR	Associated Fault Tree or Basic Event ^a	
CRCF-ESD04-DPC	ESD4-DPC-DROP	ESD4-MOD	060-MODERATOR-SOURCE	
	ESD4-DPC-TIP			
	ESD4-DPC-IMPACT			
	ESD4-DPC-DROPON			
CRCF-ESD04-DSTD	ESD4-DSNF-DROP			
	ESD4-DSNF-TIP			
	ESD4-DSNF-IMPACT			
	ESD4-DSNF-DROPON			
CRCF-ESD04-HLW	ESD4-HLW-DROP		HLW-MODERATOR	
	ESD4-HLW-TIP			
	ESD4-HLW-IMPACT			
	ESD4-HLW-DROPON			
CRCF-ESD04-MCO	ESD4-MCO-DROP		ESD4-MOD	060-MODERATOR-SOURCE
	ESD4-MCO-TIP			
	ESD4-MCO-IMPACT			
	ESD4-MCO-DROPON			
CRCF-ESD04-TAD	ESD4-TAD-DROP			
	ESD4-TAD-TIP			
	ESD4-TAD-IMPACT			
	ESD4-TAD-DROPON			

NOTE: ^a This column may contain fault trees and basic events. See Attachment B for fault trees and Attachment C for basic events.

Source: Original

A4.5 EVENT TREES FOR CRC-ESD-05

CRC-ESD-05 covers event sequences for aging overpack preparation activities associated with unbolting the aging overpack lid (Ref. 2.2.33, Figure F-5). Table A4.5-1 summarizes the event trees for CRC-ESD-05. Although all of the initiating events in the initiator event tree transfer to the same response tree, the response tree is customized within SAPHIRE for each initiating event by the use of basic rules. The rules instruct SAPHIRE where to look for the fault tree that models each pivotal event. The assignments made in the rules files are indicated in this section.

Table A4.5-1. Summary of Event Trees for CRC-ESD-05

Waste Form Units	Associated Event Trees	Number of Waste Form Units
Aging overpack containing a TAD canister	Initiator: CRCF-ESD05-TAD Response: RESPONSE-CANISTER1	8,143

Source: Ref. 2.2.31, Table 4

A4.5.1 Initiating Events for CRC-ESD-05

The following initiating events are associated with CRC-ESD-05. The assignments made within SAPHIRE for quantification of these initiating events are indicated in Table A4.5-2.

Impact to Aging Overpack. This initiating event represents a potential impact to the aging overpack due to a collision of the site transporter with another vehicle or improper operation of the cask handling crane. The fault tree is described in Attachment B. The initiating event is specified as a probability of an impact per cask.

Tipover of an Aging Overpack. This initiating event represents a potential impact to the aging overpack resulting in a tipover. The probability of tipover per transfer is modeled as a single-event fault tree described in Section 6.3. The initiating event is specified as a probability of a tipover per cask.

Table A4.5-2. Initiating Event Assignments for CRC-ESD-05

Initiating Event Description	Initiator Event Tree	SAPHIRE Assignment by Basic Rules	SAPHIRE Assignment at Fault Tree Level ^a
Side impact to the Aging Overpack	CRCF-ESD05-TAD	ESD5-TAD-IMPACT	060-5-ST-IMPACT
Tipover of an Aging Overpack		ESD5-TAD-TIP	060-OPTIPOVER003-HFI-NOD

NOTE: ^a This column may contain fault trees and basic events. See Attachment B for fault trees and Attachment C for basic events.

Source: Original

A4.5.2 System Response Event Tree RESPONSE-CANISTER1

The pivotal events that appear in RESPONSE-CANISTER1 are summarized below. The accompanying tables show the association of pivotal event names with basic event or fault tree names. The pivotal events are summarized in Section A3.

CANISTER. Table A4.5-3 indicates the basic event that is associated with this pivotal event for each initiating event.

Table A4.5-3. Basic Events Associated with the CANISTER Pivotal Events of CRC-ESD-05

Initiator Event Tree	Initiating Event Name	Name Assigned to CANISTER	Associated Fault Tree or Basic Event ^a
CRCF-ESD05-TAD	ESD5-TAD-IMPACT	ESD5-TAD-IMPACT-CAN	05-TAD_AO_IMPACT
	ESD5-TAD-TIP	ESD5-TAD-TIP-CAN	05-TAD_AO_TIP

NOTE: ^aThis column may contain fault trees and basic events. See Attachment B for fault trees and Attachment C for basic events.

Source: Original

SHIELDING. Table A4.5-4 indicates the basic event that is associated with this pivotal event for each initiating event.

Table A4.5-4. Basic Events Associated with the SHIELDING Pivotal Events of CRC-ESD-05

Initiator Event Tree	Initiating Event Name	Name Assigned to SHIELDING	Associated Fault Tree or Basic Event ^a
CRCF-ESD05-TAD	ESD5-TAD-IMPACT	ESD5-TAD-IMPACT-SHIELD	AO_SHIELDING
	ESD5-TAD-TIP	ESD5-TAD-TIP-SHIELD	

NOTE: ^aThis column may contain fault trees and basic events. See Attachment B for fault trees and Attachment C for basic events.

Source: Original

CONFINEMENT. Table A4.5-5 indicates the basic event that is associated with this pivotal event for each initiating event.

Table A4.5-5. Basic Events Associated with the CONFINEMENT Pivotal Events of CRC-ESD-05

Initiator Event Tree	Initiating Event Name	Name Assigned to CONFINEMENT	Associated Fault Tree or Basic Event ^a
CRCF-ESD05-TAD	ESD5-TAD-IMPACT	ESD5-CONF ^b	060-DP-LOSS-CRCF
	ESD5-TAD-TIP		

NOTE: ^aThis column may contain fault trees and basic events. See Attachment B for fault trees and Attachment C for basic events.

^bThis passes through a transfer tree named CONFINEMENT.

Source: Original

MODERATOR. The conditional probability of failure (introduction of liquid moderator) is the same for all waste forms and initiating events as shown in Table A4.5-6.

Table A4.5-6. Basic Events Associated with the MODERATOR Pivotal Events of CRC-ESD-05

Initiator Event Tree	Initiating Event Name	Name Assigned to MODERATOR	Associated Fault Tree or Basic Event ^a
CRCF-ESD05-TAD	ESD5-TAD-IMPACT	ESD5-MOD	060-MODERATOR-SOURCE
	ESD5-TAD-TIP		

NOTE: ^a This column may contain fault trees and basic events. See Attachment B for fault trees and Attachment C for basic events.

Source: Original

A4.6 EVENT TREES FOR CRC-ESD-06

CRC-ESD-06 covers event sequences for transferring either a cask or aging overpack from the cask preparation area to the cask unloading room (Ref. 2.2.33, Figure F-6). This ESD covers aging overpacks and five types of transportation casks. Corresponding to each type of cask or aging overpack is an initiator event tree (Table A4.6-1). Although the initiator event tree transfers to the same response tree, the response tree is customized within SAPHIRE for each initiator event tree by the use of basic rules. The rules instruct SAPHIRE where to look for the fault tree that models each pivotal event. The assignments made in the rules files are indicated in this section.

Table A4.6-1. Summary of Event Trees for CRC-ESD-06

Waste Form Unit	Associated Event Trees	Number of Waste Form Units
Transportation cask containing a DPC	Initiator: CRCF-ESD06-DPC Response: RESPONSE-TCASK2	346
Transportation cask containing DOE Standardized SNF canisters	Initiator: CRCF-ESD06-DSTD Response: RESPONSE-TCASK2	385
Rail-based Transportation cask containing HLW canisters	Initiator: CRCF-ESD06-HLW Response: RESPONSE-TCASK2	1,960
Transportation cask containing MCOs	Initiator: CRCF-ESD06-MCO Response: RESPONSE-TCASK2	113
Transportation cask or aging overpack containing a TAD canister	Initiator: CRCF-ESD06-TAD Response: RESPONSE-TCASK2	15,121

Source: Ref. 2.2.31, Table 4

A4.6.1 Initiating Events for CRC-ESD-06

The following initiating events are associated with CRC-ESD-06. The assignments made within SAPHIRE for quantification of these initiating events are indicated in Table A4.6-2.

Impact Affecting a Transportation Cask or Aging Overpack. This initiating event represents a potential impact to the cask or aging overpack. The probability of impact per transfer is a

human error described in Section 6.4. For TAD canisters the probability of impact is coupled with the fraction of casks containing TAD canisters carried on a CTT or site transporter. The initiating event is specified as a probability of an impact per cask.

Collision Involving the CTT or Site Transporter. This initiating event represents a potential collision involving the CTT or site transporter. The probability of a collision is modeled as a fault tree as described in Attachment B. For TAD canisters the probability of impact is coupled with the fraction of casks containing TAD canisters carried on a CTT or site transporter. The initiating event is specified as a probability of a drop per cask.

Table A4.6-2. Initiating Event Assignments for CRC-ESD-06

Initiating Event Description	Initiator Event Tree	SAPHIRE Assignment by Basic Rules	SAPHIRE Assignment at Fault Tree Level ^a
Impact affecting transportation cask or aging overpack	CRCF-ESD06-DPC	ESD6-DPC-IMPACT	060-6-OP-CTT-IMPACT
	CRCF-ESD06-DSTD	ESD6-DSNF-IMPACT	
	CRCF-ESD06-HLW	ESD6-HLW-IMPACT	
	CRCF-ESD06-MCO	ESD6-MCO-IMPACT	
	CRCF-ESD06-TAD	ESD6-TAD-IMPACT-CTT	060-PROB-CTT-TAD AND 060-6-OP-CTT-IMPACT ^b
		ESD6-TAD-IMPACT-ST	060-PROB-ST-TAD AND 060-6-OP-ST-IMPACT ^b
Collision of CTT or site transporter	CRCF-ESD06-DPC	ESD6-DPC-COLLIDE	060-6-CTT-COLLIDE
	CRCF-ESD06-DSTD	ESD6-DSNF-COLLIDE	
	CRCF-ESD06-HLW	ESD6-HLW-COLLIDE	
	CRCF-ESD06-MCO	ESD6-MCO-COLLIDE	
	CRCF-ESD06-TAD	ESD6-TAD-COLLIDE-CTT	060-PROB-CTT-TAD AND 060-6-CTT-COLLIDE ^c
		ESD6-TAD-COLLIDE-ST	060-PROB-ST-TAD AND 060-6-ST-COLLISION ^c

NOTE: ^a This column may contain fault trees and basic events. See Attachment B for fault trees and Attachment C for basic events.

^b These two basic events are combined with an AND gate.

^c These are a basic event and a fault tree combined by an AND gate.

Source: Original

A4.6.2 System Response Event Tree RESPONSE-TCASK2

The pivotal events that appear in RESPONSE-TCASK2 are listed below and summarized in Section A3. The accompanying tables show the association of pivotal event names with basic event or fault tree names.

CANISTER. Table A4.6-3 indicates the basic event that is associated with this pivotal event for each initiating event.

Table A4.6-3. Fault Trees Associated with the CANISTER Pivotal Events of CRC-ESD-06

Initiator Event Tree	Initiating Event Name	Name Assigned to CANISTER	Associated Fault Tree or Basic Event ^a
CRCF-ESD06-DPC	ESD6-DPC-IMPACT	ESD6-DPC-IMPACT-CAN	06-DPC-FAIL-CTT-IMPACT
	ESD6-DPC-COLLIDE	ESD6-DPC-COLLIDE-CAN	06-DPC-FAIL-CTT-COLLIDE
CRCF-ESD06-DSTD	ESD6-DSNF-IMPACT	ESD6-DSNF-IMPACT-CAN	06-DSNF-FAIL-CTT-IMPACT
	ESD6-DSNF-COLLIDE	ESD6-DSNF-COLLIDE-CAN	06-DSNF-FAIL-CTT-COLLIDE
CRCF-ESD06-HLW	ESD6-HLW-IMPACT	ESD6-HLW-IMPACT-CAN	06-HLW-FAIL-CTT-IMPACT
	ESD6-HLW-COLLIDE	ESD6-HLW-COLLIDE-CAN	06-HLW-FAIL-CTT-COLLIDE
CRCF-ESD06-MCO	ESD6-MCO-IMPACT	ESD6-MCO-IMPACT-CAN	06-MCO-FAIL-CTT-IMPACT
	ESD6-MCO-COLLIDE	ESD6-MCO-COLLIDE-CAN	06-MCO-FAIL-CTT-COLLIDE
CRCF-ESD06-TAD	ESD6-TAD-IMPACT-CTT	ESD6-TAD-IMPACT-CT-CAN	06-TAD-FAIL-CTT-IMPACT
	ESD6-TAD-IMPACT-ST	ESD6-TAD-IMPACT-ST-CAN	06-TAD_FAIL_ST_AO_IMPACT
	ESD6-TAD-COLLIDE-CTT	ESD6-TAD-COLLIDE-CT-CAN	06-TAD-FAIL-CTT-COLLIDE
	ESD6-TAD-COLLIDE-ST	ESD6-TAD-COLLIDE-ST-CAN	06-TAD_FAIL_STAO_COLLIDE

NOTE: ^a This column may contain fault trees and basic events. See Attachment B for fault trees and Attachment C for basic events.

Source: Original

SHIELDING. Table A4.6-4 indicates the fault trees or basic events that are associated with this pivotal event for each initiating event.

Table A4.6-4. Fault Trees Associated with the SHIELDING Pivotal Events of CRC-ESD-06

Initiator Event Tree	Initiating Event Name	Name Assigned to SHIELDING	Associated Fault Tree or Basic Event ^a
CRCF-ESD06-DPC	ESD6-DPC-IMPACT	ESD6-DPC-IMPACT-SHIELD	CASK-SHIELDING
	ESD6-DPC-COLLIDE	ESD6-DPC-COLLIDE-SHIELD	
CRCF-ESD06-DSTD	ESD6-DSNF-IMPACT	ESD6-DSNF-IMPACT-SHIELD	
	ESD6-DSNF-COLLIDE	ESD6-DSNF-COLLIDE-SHIELD	
CRCF-ESD06-HLW	ESD6-HLW-IMPACT	ESD6-HLW-IMPACT-SHIELD	
	ESD6-HLW-COLLIDE	ESD6-HLW-COLLIDE-SHIELD	
CRCF-ESD06-MCO	ESD6-MCO-IMPACT	ESD6-MCO-IMPACT-SHIELD	
	ESD6-MCO-COLLIDE	ESD6-MCO-COLLIDE-SHIELD	

Table A4.6-4. Fault Trees Associated with the SHIELDING Pivotal Events of CRC-ESD-06 (Continued)

Initiator Event Tree	Initiating Event Name	Name Assigned to SHIELDING	Associated Fault Tree or Basic Event ^a
CRCF-ESD06-TAD	ESD6-TAD-IMPACT-CTT	ESD6-TAD-IMPACT-CT-SHIE	CASK-SHIELDING
	ESD6-TAD-IMPACT-ST	ESD6-TAD-IMPACT-ST-SHIE	AO-SHIELDING
	ESD6-TAD-COLLIDE-CTT	ESD6-TAD-COLLIDE-CT-SHIE	CASK-SHIELDING
	ESD6-TAD-COLLIDE-ST	ESD6-TAD-COLLIDE-ST-SHIE	AO-SHIELDING

NOTE: ^a This column may contain fault trees and basic events. See Attachment B for fault trees and Attachment C for basic events.

Source: Original

CONFINEMENT. Table A4.6-5 indicates the fault trees or basic events that are associated with this pivotal event for each initiating event.

Table A4.6-5. Fault Trees Associated with the CONFINEMENT Pivotal Events of CRC-ESD-06

Initiator Event Tree	Initiating Event Name	Name Assigned to CONFINEMENT	Associated Fault Tree or Basic Event ^a
CRCF-ESD06-DPC	ESD6-DPC-IMPACT	ESD6-CONF ^b	060-DP-LOSS-CRCF
	ESD6-DPC-COLLIDE		
CRCF-ESD06-DSTD	ESD6-DSNF-IMPACT		
	ESD6-DSNF-COLLIDE		
CRCF-ESD06-HLW	ESD6-HLW-IMPACT		
	ESD6-HLW-COLLIDE		
CRCF-ESD06-MCO	ESD6-MCO-IMPACT		
	ESD6-MCO-COLLIDE		
CRCF-ESD06-TAD	ESD6-TAD-IMPACT-CTT		
	ESD6-TAD-IMPACT-ST		
	ESD6-TAD-COLLIDE-CTT		
	ESD6-TAD-COLLIDE-ST		

NOTE: ^a This column may contain fault trees and basic events. See Attachment B for fault trees and Attachment C for basic events.

^b This passes through a transfer tree named CONFINEMENT.

Source: Original

MODERATOR. The conditional probability of failure (introduction of liquid moderator) is the same for all waste forms and initiating events as shown in Table A4.6-6.

Table A4.6-6. Fault Trees Associated with the MODERATOR Pivotal Events of CRC-ESD-06

Initiator Event Tree	Initiating Event Name	Name Assigned to MODERATOR	Associated Fault Tree or Basic Event ^a
CRCF-ESD06-DPC	ESD6-DPC-IMPACT	ESD6-MOD	060-MODERATOR-SOURCE
	ESD6-DPC-COLLIDE		

Table A4.6-6. Fault Trees Associated with the MODERATOR Pivotal Events of CRC-ESD-06 (Continued)

Initiator Event Tree	Initiating Event Name	Name Assigned to MODERATOR	Associated Fault Tree or Basic Event ^a
CRCF-ESD06-DSTD	ESD6-DSNF-IMPACT		
	ESD6-DSNF-COLLIDE		
CRCF-ESD06-HLW	ESD6-HLW-IMPACT		HLW-MODERATOR
	ESD6-HLW-COLLIDE		
CRCF-ESD06-MCO	ESD6-MCO-IMPACT		060-MODERATOR-SOURCE
	ESD6-MCO-COLLIDE		
CRCF-ESD06-TAD	ESD6-TAD-IMPACT-CTT		
	ESD6-TAD-IMPACT-ST		
	ESD6-TAD-COLLIDE-CTT		
	ESD6-TAD-COLLIDE-ST		

NOTE: ^a This column may contain fault trees and basic events. See Attachment B for fault trees and Attachment C for basic events.

Source: Original

A4.7 EVENT TREES FOR CRC-ESD-07

CRC-ESD-07 covers event sequences associated with collision of the shield door into the CTT, site transporter, or WPTT (Ref. 2.2.33, Figure F-7). For the CTT, the shield door involved is the door from the Cask Preparation Room to the Cask Unloading Room. For the site transporter, this door and the shield door between the site transporter entrance vestibule and the Cask Preparation Room apply to this event. For the WPTT, the shield door involved is the shield door from the Waste Package Positioning Room (North or South) to the Waste Package Loadout Room. This ESD covers aging overpacks, transportation casks, and waste packages.

The conveyance could collide into a stationary shield door or a moving shield door could collide into the conveyance. Since the shield doors are designed in accordance with the applicable provisions of *American National Standard Specification for the Design, Fabrication, and Erection of Steel Safety-Related Structures for Nuclear Facilities* (Ref.2.2.4) to withstand the load and acceleration produced by a DBG-2 seismic event, it is reasonable to conclude that the shield doors would remain attached to their moorings in the event of a slow speed (maximum of 2.5 mph) collision of a conveyance with the shield door. Therefore the analysis only evaluates the impact of a moving shield door with the conveyance.

A4.7.1 Initiating Events for CRC-ESD-07

Collision of Shield Door into CTT, site transporter, or WPTT. This initiating event accounts for a collision of a moving shield door with the CTT, site transporter, or WPTT. Since normal operations would not include the movement of the conveyance through the doorway while the shield door is closing, it is postulated that the door closes due to inadvertent actuation of the door. The probability of impact per transfer is derived from empirical data in Section 6.3 and is

modeled as either a hardware failure or a human failure. The assignments made within SAPHIRE for quantification of this initiating event are indicated in Table A4.7-1.

Table A4.7-1. Initiating Event Assignments for CRC-ESD-07

Initiating Event Description	Initiator Event Tree	SAPHIRE Assignment by Basic Rules	SAPHIRE Assignment at Fault Tree Level
Collision of shield door with CTT, site transporter, or WPTT	CRCF-ESD07-DPC	ESD07-DPC-IMPACT	060-7-CTT-COLLIDE-SDR OR 060-7-ST-COLLIDE-SDR ^a
	CRCF-ESD07-DSTD	ESD07-DSNF-IMPACT	060-7-CTT-COLLIDE-SDR
	CRCF-ESD07-HLW	ESD07-HLW-IMPACT	060-7-CTT-COLLIDE-SDR
	CRCF-ESD07-MCO	ESD07-MCO-IMPACT	060-7-CTT-COLLIDE-SDR
	CRCF-ESD07-TAD	ESD07-TAD-IMPACT	060-CTT-TAD-IMPACT ^b OR 060-ST-TAD-IMPACT ^{a,b}
	CRCF-ESD07-WP-H&D	ESD07-WP-H&D-IMPACT	060-7-WPTT-COLLIDE-SDR
	CRCF-ESD07-WP-H&M	ESD07-WP-H&M-IMPACT	060-7-WPTT-COLLIDE-SDR
	CRCF-ESD07-WP-TAD	ESD07-WP-TAD-IMPACT	060-7-WPTT-COLLIDE-SDR

NOTE: ^a Result of this fault tree is multiplied by factor of two to account for two shield doors.

^b Split-fractions are used to account for percentage of operations involving the CTT and the site transporter.

Source: Original

A4.7.2 Pivotal Events

The pivotal events that appear in the event tree are listed below and summarized in Section A3. The accompanying tables show the association of pivotal event names with basic event or fault tree names.

CELL-DOOR. Table A4.7-2 indicates the fault trees or basic events that are associated with this pivotal event for each initiating event.

Table A4.7-2. Basic Events Associated with the CELL-DOOR Pivotal Events of CRC-ESD-07

Initiator Event Tree	Initiating Event Name	Name Assigned to CELL-DOOR	Associated Fault Tree or Basic Event ^a
CRCF-ESD07-DPC	ESD07-DPC-IMPACT	ESD7-DPC-IMPACT-DOOR	SHIELD_DOOR_FAILURE
CRCF-ESD07-DSTD	ESD07-DSTD-IMPACT	ESD7-DSTD-IMPACT-DOORFA	
CRCF-ESD07-HLW	ESD07-HLW-IMPACT	ESD7-HLW-IMPACT-DOORFAI	
CRCF-ESD07-MCO	ESD07-MCO-IMPACT	ESD7-MCO-IMPACT-DOORFA	
CRCF-ESD07-TAD	ESD07-TAD-IMPACT	ESD7-TAD-IMPACT-DOOR	
CRCF-ESD07-WP-H&D	ESD07-WP-H&D-IMPACT	ESD7-WP-H&D-IMPACT-DOOR	
CRCF-ESD07-WP-H&M	ESD07-WP-H&M-IMPACT	ESD7-WP-H&M-IMPACT-DOOR	SHIELD_DOOR_FAILURE
CRCF-ESD07-WP-TAD	ESD07-WP-TAD-IMPACT	ESD7-WP-TAD-IMPACT-DOOR	

NOTE: ^a This column may contain fault trees and basic events. See Attachment B for fault trees and Attachment C for basic events.

Source: Original

CONTAINMENT. Table A4.7-3 indicates the fault trees or basic events that are associated with this pivotal event for each initiating event.

Table A4.7-3. Basic Events Associated with the CONTAINMENT Pivotal Events of CRC-ESD-07

Initiator Event Tree	Initiating Event Name	Name Assigned to CONTAINMENT	Associated Fault Tree or Basic Event ^a
CRCF-ESD07-DPC	ESD07-DPC-IMPACT	ESD7-DPC-IMPACT-CONT	07-DPC-FAIL-SD-IMPACT
CRCF-ESD07-DSTD	ESD07-DSTD-IMPACT	ESD7-DSTD-IMPACT-CONTAI	07-DSTD-FAIL-CTT-IMPACT
CRCF-ESD07-HLW	ESD07-HLW-IMPACT	ESD7-HLW-IMPACT-CONTAIN	07-HLW-FAIL-CTT-IMPACT
CRCF-ESD07-MCO	ESD07-MCO-IMPACT	ESD7-MCO-IMPACT-CONTAI	07-MCO-FAIL-CTT-IMPACT
CRCF-ESD07-TAD	ESD07-TAD-IMPACT	ESD7-TAD-IMPACT-CONT	07-TAD-FAIL-SD-IMPACT
CRCF-ESD07-WP-H&D	ESD07-WP-H&D-IMPACT	ESD7-WP-H&D-IMPACT-CONT	07-WP_FAIL_IMPACT
CRCF-ESD07-WP-H&M	ESD07-WP-H&M-IMPACT	ESD7-WP-H&M-IMPACT-CONT	07-WP_FAIL_IMPACT
CRCF-ESD07-WP-TAD	ESD07-WP-TAD-IMPACT	ESD7-WP-TAD-IMPACT-CONT	07-WP_FAIL_IMPACT

NOTE: ^a This column may contain fault trees and basic events. See Attachment B for fault trees and Attachment C for basic events.

Source: Original

SHIELDING. Table A4.7-4 indicates the fault trees or basic events that are associated with this pivotal event for each initiating event.

Table A4.7-4. Basic Events Associated with the SHIELDING Pivotal Events of CRC-ESD-07

Initiator Event Tree	Initiating Event Name	Name Assigned to SHIELDING	Associated Fault Tree or Basic Event ^a
CRCF-ESD07-DPC	ESD07-DPC-IMPACT	ESD7-DPC-IMPACT-SHIELD	ESD7-DPC-IMPACT-SHIELD ^b
CRCF-ESD07-DSTD	ESD07-DSTD-IMPACT	ESD7-DSNF-IMPACT-SHIELD	CASK-SHIELDING ^b
CRCF-ESD07-HLW	ESD07-HLW-IMPACT	ESD7-HLW-IMPACT-SHIELD	CASK-SHIELDING ^b
CRCF-ESD07-MCO	ESD07-MCO-IMPACT	ESD7-MCO-IMPACT-SHIELD	CASK-SHIELDING ^b
CRCF-ESD07-TAD	ESD07-TAD-IMPACT	ESD7-TAD-IMPACT-SHI	ESD7-TAD-IMPACT-SHI ^b
CRCF-ESD07-WP-H&D	ESD07-WP-H&D-IMPACT	ESD7-WP-H&D-IMPACT-SHI	10-WP_SHIELDING
CRCF-ESD07-WP-H&M	ESD07-WP-H&M-IMPACT	ESD7-WP-H&M-IMPACT-SHI	10-WP_SHIELDING
CRCF-ESD07-WP-TAD	ESD07-WP-TAD-IMPACT	ESD7-WP-TAD-IMPACT-SHI	10-WP_SHIELDING

NOTE: ^a This column may contain fault trees and basic events. See Attachment B for fault trees and Attachment C for basic events.

^b Fault trees described in Attachment B, Section B9.

Source: Original

CONFINEMENT. Table A4.7-5 indicates the fault trees or basic events that are associated with this pivotal event for each initiating event.

Table A4.7-5. Basic Events Associated with the CONFINEMENT Pivotal Events of CRC-ESD-07

Initiator Event Tree	Initiating Event Name	Name Assigned to CONFINEMENT	Associated Fault Tree or Basic Event ^a
CRCF-ESD07-DPC	ESD07-DPC-IMPACT	ESD07-CONF	060-DP-LOSS-CRCF
CRCF-ESD07-DSTD	ESD07-DSTD-IMPACT		
CRCF-ESD07-HLW	ESD07-HLW-IMPACT		
CRCF-ESD07-MCO	ESD07-MCO-IMPACT		
CRCF-ESD07-TAD	ESD07-TAD-IMPACT		

NOTE: ^a This column may contain fault trees and basic events. See Attachment B for fault trees and Attachment C for basic events.

^b This passes through a transfer tree named CONFINEMENT.

Source: Original

MODERATOR. Table A4.7-6 indicates the fault trees or basic events that are associated with this pivotal event for each initiating event.

Table A4.7-6. Basic Events Associated with the MODERATOR Pivotal Events of CRC-ESD-07

Initiator Event Tree	Initiating Event Name	Name Assigned to MODERATOR	Associated Fault Tree or Basic Event ^a
CRCF-ESD07-DPC	ESD07-DPC-IMPACT	ESD07-MOD	060-MODERATOR-SOURCE
CRCF-ESD07-DSTD	ESD07-DSTD-IMPACT		HLW-MODERATOR
CRCF-ESD07-HLW	ESD07-HLW-IMPACT		060-MODERATOR-SOURCE
CRCF-ESD07-MCO	ESD07-MCO-IMPACT		
CRCF-ESD07-TAD	ESD07-TAD-IMPACT		

NOTE: ^a This column may contain fault trees and basic events. See Attachment B for fault trees and Attachment C for basic events.

Source: Original

A4.8 EVENT TREES FOR CRC-ESD-08

CRC-ESD-08 covers event sequences associated with collision of two CTMs (Ref. 2.2.33, Figure F-8). A single initiating event, collision of two CTMs, is associated with CRC-ESD-08. Because there is only one initiating event, the event trees are self contained (Table A4.8-1). Although the event trees for the different waste form units have the same pivotal event names, the pivotal events are customized within SAPHIRE for each event tree by the use of basic rules. The rules instruct SAPHIRE where to look for the fault tree that models each pivotal event. The assignments made in the rules files are indicated in this section.

Table A4.8-1. Summary of Event Trees for CRC-ESD-08

Waste Form Unit	Associated Event Trees	Number of Waste Form Units
DPC	CRCF-ESD08-DPC	346 ^a
DOE standardized SNF canister	CRCF-ESD08-DSTD	6,215 ^a
HLW canister	CRCF-ESD08-HLW	9,801 ^b
MCO	CRCF-ESD08-MCO	451 ^a
TAD canister	CRCF-ESD08-TAD	6,978 ^a

Source: ^{a,b} Ref. 2.2.31, ^aTable 4, ^bTable 3

A4.8.1 Initiating Events for CRC-ESD-08

Collision of Two CTMs. This initiating event accounts for the potential impact to the canisters from a collision of two CTMs. The probability of impact per transfer is derived from empirical data in Section 6.3 and is modeled as a single-event fault tree as described in Attachment B. The initiating event is specified as a probability of a collision per canister transferred. The assignments made within SAPHIRE for quantification of these initiating events are indicated in Table A4.8-2. Because there is only one initiating event, there is no separate initiator event tree.

Table A4.8-2. Initiating Event Assignments for CRC-ESD-08

Initiating Event Description	Initiator Event Tree	SAPHIRE Assignment by Basic Rules	SAPHIRE Assignment at Fault Tree Level ^a
Collision of two CTMs	CRCF-ESD08-DPC	ESD8-DPC-COLLIDE	060-8-TWO-CTMS-COLLIDE
	CRCF-ESD08-DSTD	ESD8-DSNF-COLLIDE	
	CRCF-ESD08-HLW	ESD8-HLW-COLLIDE	
	CRCF-ESD08-MCO	ESD8-MCO-COLLIDE	
	CRCF-ESD08-TAD	ESD8-TAD-COLLIDE	

NOTE: ^a This column may contain fault trees and basic events. See Attachment B for fault trees and Attachment C for basic events.

Source: Original

A4.82 System Response Event Tree RESPONSE-MULTI-CAN

The pivotal events that appear in RESPONSE-MULTI-CAN are listed below and summarized in Section A3. The accompanying tables show the association of pivotal event names with basic event or fault tree names.

CANISTER. Table A4.8-3 indicates the fault trees or basic events that are associated with this pivotal event for each initiating event.

Table A4.8-3. Basic Events Associated with the CANISTER Pivotal Events of CRC-ESD-08

Initiator Event Tree	Initiating Event Name	Name Assigned to CANISTER	Associated Fault Tree or Basic Event ^a
CRCF-ESD08-DPC	ESD8-DPC-COLLIDE	ESD8-DPC-COLLIDE-2CAN	08-2DPCS_BREACHED
CRCF-ESD08-DSTD	ESD8-DSNF-COLLIDE	ESD8-DSNF-COLLIDE-2CAN	08-2DSNFS_BREACHED
CRCF-ESD08-HLW	ESD8-HLW-COLLIDE	ESD8-HLW-COLLIDE-2CAN	08-2HLWS_BREACHED
CRCF-ESD08-MCO	ESD8-MCO-COLLIDE	ESD8-MCO-COLLIDE-2CAN	08-2MCOS_BREACHED
CRCF-ESD08-TAD	ESD8-TAD-COLLIDE	ESD8-TAD-COLLIDE-2CAN	08-2TADS_BREACHED

NOTE: ^a This column may contain fault trees and basic events. See Attachment B for fault trees and Attachment C for basic events.

Source: Original

SHIELDING. Table A4.8-4 indicates the fault trees or basic events that are associated with this pivotal event for each initiating event.

Table A4.8-4. Basic Events Associated with the SHIELDING Pivotal Events of CRC-ESD-08

Initiator Event Tree	Initiating Event Name	Name Assigned to SHIELDING	Associated Fault Tree or Basic Event ^a
CRCF-ESD08-DPC	ESD8-DPC-COLLIDE	ESD8-DPC-COLLIDE-SHIELD	CTM_SHIELDING
CRCF-ESD08-DSTD	ESD8-DSNF-COLLIDE	ESD8-DSNF-COLLIDE-SHIEL	
CRCF-ESD08-HLW	ESD8-HLW-COLLIDE	ESD8-HLW-COLLIDE-SHIELD	
CRCF-ESD08-MCO	ESD8-MCO-COLLIDE	ESD8-MCO-COLLIDE-SHIEL	
CRCF-ESD08-TAD	ESD8-TAD-COLLIDE	ESD8-TAD-COLLIDE-SHIELD	

NOTE: ^a This column may contain fault trees and basic events. See Attachment B for fault trees and Attachment C for basic events.

Source: Original

CONFINEMENT. Table A4.8-5 indicates the fault trees or basic events that are associated with this pivotal event for each initiating event.

Table A4.8-5. Basic Events Associated with the CONFINEMENT Pivotal Events of CRC-ESD-08

Initiator Event Tree	Initiating Event Name	Name Assigned to CONFINEMENT	Associated Fault Tree or Basic Event ^a
CRCF-ESD08-DPC	ESD8-DPC-COLLIDE	ESD8-CONF ^b	060-DP-LOSS-CRCF
CRCF-ESD08-DSTD	ESD8-DSNF-COLLIDE		
CRCF-ESD08-HLW	ESD8-HLW-COLLIDE		
CRCF-ESD08-MCO	ESD8-MCO-COLLIDE		
CRCF-ESD08-TAD	ESD8-TAD-COLLIDE		

NOTE: ^a This column may contain fault trees and basic events. See Attachment B for fault trees and Attachment C for basic events.

^b This passes through a transfer tree named CONFINEMENT.

Source: Original

MODERATOR. The conditional probability of failure (introduction of liquid moderator) is the same for all waste forms and initiating events as shown in Table A4.8-6.

Table A4.8-6. Basic Events Associated with the MODERATOR Pivotal Events of CRC-ESD-08

Initiator Event Tree	Initiating Event Name	Name Assigned to MODERATOR	Associated Fault Tree or Basic Event ^a
CRCF-ESD08-DPC	ESD8-DPC-COLLIDE	ESD8-MOD	060-MODERATOR-SOURCE
CRCF-ESD08-DSTD	ESD8-DSNF-COLLIDE		
CRCF-ESD08-HLW	ESD8-HLW-COLLIDE		HLW-MODERATOR
CRCF-ESD08-MCO	ESD8-MCO-COLLIDE		060-MODERATOR-SOURCE
CRCF-ESD08-TAD	ESD8-TAD-COLLIDE		

NOTE: ^a This column may contain fault trees and basic events. See Attachment B for fault trees and Attachment C for basic events.

Source: Original

A4.9 EVENT TREES FOR CRC-ESD-09

CRC-ESD-09 covers event sequences associated with CTM transfers (Ref. 2.2.33, Figure F-9). This ESD covers all canister types. Corresponding to each canister type is an initiator event tree (Table A4.9-1). Although the initiator event trees transfer to the same response tree, the response tree is customized within SAPHIRE for each initiator event tree by the use of basic rules. The rules instruct SAPHIRE where to look for the fault tree that models each pivotal event. The assignments made in the rules files are indicated in this section.

Table A4.9-1. Summary of Event Trees for CRC-ESD-09

Waste Form Unit	Associated Event Trees	Number of Waste Form Units
DPC	Initiator: CRCF-ESD09-DPC Response: RESPONSE-CANISTER1	346 ^a
DOE standardized SNF canister	Initiator: CRCF-ESD09-DSTD Response: RESPONSE-CANISTER1	6,215 ^a
HLW canister	Initiator: CRCF-ESD09-HLW Response: RESPONSE-CANISTER1	9,801 ^b
MCO	Initiator: CRCF-ESD09-MCO Response: RESPONSE-CANISTER1	451 ^a
TAD canister	Initiator: CRCF-ESD09-TAD Response: RESPONSE-CANISTER1	15,121 ^a

NOTE: Numbers of units given are the total numbers available because, from the perspective of a CTM collision involving a given type of waste form, it is not known what the waste form inside the other CTM might be.

Source: ^{a,b}Ref. 2.2.31, ^aTable 4, ^bTable 3

A4.9.1 Initiating Events for CRC-ESD-09

The following initiating events are associated with CRC-ESD-09. The assignments made within SAPHIRE for quantification of these initiating events are indicated in Table A4.9-2. The initiating events are specified as frequency of occurrence per canister.

Impact Associated with Lid Removal. This initiating event covers the potential impact during cask or aging overpack lid removal due to a human failure to remove all of the lid bolts.

Canister Drop from Operational Height. This initiating event accounts for the potential impact to the canister due to having been dropped from the normal operational height during transfer by the CTM.

Impact to Canister due to Conveyance Movement. This initiating event covers the potential impact to or shear of the canister due to untimely movement of the CTT, site transporter, or WPTT during loading or unloading of the canister.

Side Impact to Canister. This initiating event covers the potential impact to the canister due to a CTM collision.

Object Dropped on Canister. This initiating event covers the potential impact to the canister due to the drop of a heavy object (e.g., cask lid) by the CTM.

Canister Drop Inside Bell. This initiating event accounts for the potential impact to the canister due to having been dropped on the second floor during horizontal transfer by the CTM. This event has been subsumed within the canister drop from operational height event.

Canister Drop above Operational Height. This initiating event accounts for the potential impact to the canister due to having been dropped from above the normal operational height due to a two-blocking event during transfer by the CTM.

Table A4.9-2. Initiating Event Assignments for CRC-ESD-09

Initiating Event Description	Initiator Event Tree	SAPHIRE Assignment by Basic Rules	SAPHIRE Assignment at Fault Tree Level ^a
Impact with lid removal	CRCF-ESD09-DPC	ESD9-DPC-LIDIMP	060-OPNOUNBOLT00-HFI-NOD
	CRCF-ESD09-DSTD	ESD9-DSNF-LIDIMP	060-OPNOUNBOLT00-HFI-NOD AND 060-CTM--HOLDBRK-BRK-FOD ^b , 060-CTM--HOLDBRK-BRK-FOH ^b , 060-CTM--IMEC125-IEL-FOD ^b , 060-CTM--WT0125--SRP-FOD ^b , 060-CTM--WTSW125-ZS--FOD ^b
	CRCF-ESD09-HLW	ESD9-HLW-LIDIMP	060-OPNOUNBOLT00-HFI-NOD AND 060-CTM--HOLDBRK-BRK-FOD ^b , 060-CTM--HOLDBRK-BRK-FOH ^b , 060-CTM--IMEC125-IEL-FOD ^b , 060-CTM--WT0125--SRP-FOD ^b , 060-CTM--WTSW125-ZS--FOD ^b
	CRCF-ESD09-MCO	ESD9-MCO-LIDIMP	060-OPNOUNBOLT00-HFI-NOD AND 060-CTM--HOLDBRK-BRK-FOD ^b , 060-CTM--HOLDBRK-BRK-FOH ^b , 060-CTM--IMEC125-IEL-FOD ^b , 060-CTM--WT0125--SRP-FOD ^b , 060-CTM--WTSW125-ZS--FOD ^b
	CRCF-ESD09-TAD	ESD9-TAD-LIDIMP	060-OPNOUNBOLT00-HFI-NOD AND 060-CTM--HOLDBRK-BRK-FOD ^b , 060-CTM--HOLDBRK-BRK-FOH ^b , 060-CTM--IMEC125-IEL-FOD ^b , 060-CTM--WT0125--SRP-FOD ^b , 060-CTM--WTSW125-ZS--FOD ^b

Table A4.9-2. Initiating Event Assignments for CRC-ESD-09 (Continued)

Initiating Event Description	Initiator Event Tree	SAPHIRE Assignment by Basic Rules	SAPHIRE Assignment at Fault Tree Level ^a
Canister drop (from operational height)	CRCF-ESD09-DPC	ESD9-DPC-DROP	CTM-DROP---ALL-HEIGHTS AND 060-LIFTS-PER-DPC-CAN
	CRCF-ESD09-DSTD	ESD9-DSNF-DROP	CTM-DROP---ALL-HEIGHTS AND 060-LIFTS-PER-DSNF-CAN
	CRCF-ESD09-HLW	ESD9-HLW-DROP	CTM-DROP---ALL-HEIGHTS AND 060-LIFTS-PER-HLW-CAN
	CRCF-ESD09-MCO	ESD9-MCO-DROP	CTM-DROP---ALL-HEIGHTS AND 060-LIFTS-PER-MCO-CAN
	CRCF-ESD09-TAD	ESD9-TAD-DROP	CTM-DROP---ALL-HEIGHTS AND 060-LIFTS-PER-TAD-CAN
Spurious movement	CRCF-ESD09-DPC	ESD9-DPC-SPUR	CTM-SHEAR, 060-9-ST-SPURMOVE, 060-9-CTT-SPUR-MOVE ^c
	CRCF-ESD09-DSTD	ESD9-DSNF-SPUR	CTM-SHEAR, 060-9-WPTT-SPURMOVE, 060-9-CTT-SPUR-MOVE ^c
	CRCF-ESD09-HLW	ESD9-HLW-SPUR	CTM-SHEAR, 060-9-WPTT-SPURMOVE, 060-9-CTT-SPUR-MOVE ^c
	CRCF-ESD09-MCO	ESD9-MCO-SPUR	CTM-SHEAR, 060-9-WPTT-SPURMOVE, 060-9-CTT-SPUR-MOVE ^{c,d}
	CRCF-ESD09-TAD	ESD9-TAD-SPUR	CTM-SHEAR, 060-9-WPTT-SPURMOVE, 060-9-ST-SPURMOVE 060-9-CTT-SPUR-MOVE ^{c,d}
Side impact	CRCF-ESD09-DPC	ESD9-DPC-SIMPACT	CTM-COLLISION OR 060-SLIDEGATECLOSES-CAN AND 060-LIFTS-PER-DPC-CAN
	CRCF-ESD09-DSTD	ESD9-DSNF-SIMPACT	CTM-COLLISION OR 060-SLIDEGATECLOSES-CAN AND 060-LIFTS-PER-DSNF-CAN

Table A4.9-2. Initiating Event Assignments for CRC-ESD-09 (Continued)

Initiating Event Description	Initiator Event Tree	SAPHIRE Assignment by Basic Rules	SAPHIRE Assignment at Fault Tree Level ^a
	CRCF-ESD09-HLW	ESD9-HLW-SIMPACT	CTM-COLLISION OR 060-SLIDEGATECLOSES-CAN AND 060-LIFTS-PER-HLW-CAN
	CRCF-ESD09-MCO	ESD9-MCO-SIMPACT	CTM-COLLISION OR 060-SLIDEGATECLOSES-CAN AND 060-LIFTS-PER-MCO-CAN
	CRCF-ESD09-TAD	ESD9-TAD-SIMPACT	CTM-COLLISION OR 060-SLIDEGATECLOSES-CAN AND 060-LIFTS-PER-TAD-CAN
Object drop on canister	CRCF-ESD09-DPC	ESD9-DPC-DROPON	CTM-DROP-ONTO-CASK AND 060-CTMOBJLIFTNUMBERD
	CRCF-ESD09-DSTD	ESD9-DSNF-DROPON	CTM-DROP-ONTO-CASK AND 060-CTMOBJLIFTNUMBER
	CRCF-ESD09-HLW	ESD9-HLW-DROPON	CTM-DROP-ONTO-CASK AND 060-CTMOBJLIFTNUMBER
	CRCF-ESD09-MCO	ESD9-MCO-DROPON	CTM-DROP-ONTO-CASK AND 060-CTMOBJLIFTNUMBER
	CRCF-ESD09-TAD	ESD9-TAD-DROPON	CTM-DROP-ONTO-CASK AND 060-CTMOBJLIFTNUMBER
Canister drop inside bell	CRCF-ESD09-DPC	ESD9-DPC-CTMBELL	CTM-DROP-IN-SHIELD-BELL AND 060-LIFTS-PER-DPC-CAN
	CRCF-ESD09-DSTD	ESD9-DSNF-CTMBELL	CTM-DROP-IN-SHIELD-BELL AND 060-LIFTS-PER-DSTD-CAN
	CRCF-ESD09-HLW	ESD9-HLW-CTMBELL	CTM-DROP-IN-SHIELD-BELL AND 060-LIFTS-PER-HLW-CAN
	CRCF-ESD09-MCO	ESD9-MCO-CTMBELL	CTM-DROP-IN-SHIELD-BELL AND 060-LIFTS-PER-MCO-CAN

Table A4.9-2. Initiating Event Assignments for CRC-ESD-09 (Continued)

Initiating Event Description	Initiator Event Tree	SAPHIRE Assignment by Basic Rules	SAPHIRE Assignment at Fault Tree Level ^a
	CRCF-ESD09-TAD	ESD9-TAD-CTMBELL	CTM-DROP-IN-SHIELD-BELL AND 060-LIFTS-PER-TAD-CAN
Canister drop (above operational height)	CRCF-ESD09-DPC	ESD9-DPC-2BLK	060-LIFTS-PER-DPC-CAN AND CTM-2-BLOCK
	CRCF-ESD09-DSTD	ESD9-DSNF-2BLK	060-LIFTS-PER-DSTD-CAN AND CTM-2-BLOCK
	CRCF-ESD09-HLW	ESD9-HLW-2BLK	060-LIFTS-PER-HLW-CAN AND CTM-2-BLOCK
	CRCF-ESD09-MCO	ESD9-MCO-2BLK	060-LIFTS-PER-MCO-CAN AND CTM-2-BLOCK
	CRCF-ESD09-TAD	ESD9-TAD-2BLK	060-LIFTS-PER-TAD-CAN AND CTM-2-BLOCK

NOTE: ^a This column may contain fault trees and basic events. See Attachment B for fault trees and Attachment C for basic events.

^b Basic events connected to top level through an OR gate.

^c Fault trees connected to top level through an OR gate.

^d Fault tree includes split fraction for fraction of TADs on CTT or ST

Source: Original

A4.9.2 System Response Event Tree RESPONSE-CANISTER1

The pivotal events that appear in RESPONSE-CANISTER1 are listed below and summarized in Section A3. The accompanying tables show the association of pivotal event names with basic event or fault tree names.

CANISTER. Table A4.9-3 indicates the fault trees or basic events that are associated with this pivotal event for each initiating event.

Table A4.9-3. Basic Events Associated with the CANISTER Pivotal Events of CRC-ESD-09

Initiator Event Tree	Initiating Event Name	Name Assigned to CANISTER	Associated Fault Tree or Basic Event ^a
CRCF-ESD09-DPC	ESD9-DPC-LIDIMP	ESD9-DPC-LIDIMP-CAN	09-CAN-FAIL-LID-IMPACT
	ESD9-DPC-DROP	ESD9-DPC-DROP-CAN	09-CAN-FAIL-DROP
	ESD9-DPC-SPUR	ESD9-DPC-SPUR-CAN	09-CAN-FAIL-SPURMOVE
	ESD9-DPC-SIMPACT	ESD9-DPC-SIMPACT-CAN	09-CAN-FAIL-SIMPACT
	ESD9-DPC-DROPON	ESD9-DPC-DROPON-CAN	09-CAN-FAIL-DROPON
	ESD9-DPC-CTMBELL	ESD9-DPC-CTMBELL-CAN	09-CAN-FAIL-IN-BELL
	ESD9-DPC-2BLK	ESD9-DPC-2BLK-CAN2	09-CAN_FAIL_IN_CTM_2BL
CRCF-ESD09-DSTD	ESD9-DSNF-LIDIMP	ESD9-DSNF-LIDIMP-CAN	09-DSTD-FAIL-LID-IMPACT
	ESD9-DSNF-DROP	ESD9-DSNF-DROP-CAN	09-DSTD-FAIL-DROP
	ESD9-DSNF-SPUR	ESD9-DSNF-SPUR-CAN	09-CAN-FAIL-SPURMOVE
	ESD9-DSNF-SIMPACT	ESD9-DSNF-SIMPACT-CAN	09-DSTD-FAIL-SIMPACT
	ESD9-DSNF-DROPON	ESD9-DSNF-DROPON-CAN	09-DSTD-FAIL-DROPON
	ESD9-DSNF-CTMBELL	ESD9-DSNF-CTMBELL-CAN	09-DSTD-FAIL-IN-BELL
	ESD9-DSNF-2BLK	ESD9-DSNF-2BLK-CAN2	09-DSTD_FAIL_IN_CTM_2BL
CRCF-ESD09-HLW	ESD9-HLW-LIDIMP	ESD9-HLW-LIDIMP-CAN	09-HLW-FAIL-LID-IMPACT
	ESD9-HLW-DROP	ESD9-HLW-DROP-CAN	09-HLW-FAIL-DROP
	ESD9-HLW-SPUR	ESD9-HLW-SPUR-CAN	09-HLW-FAIL-SPURMOVE
	ESD9-HLW-SIMPACT	ESD9-HLW-SIMPACT-CAN	09-HLW-FAIL-SIMPACT
	ESD9-HLW-DROPON	ESD9-HLW-DROPON-CAN	09-HLW-FAIL-DROPON
	ESD9-HLW-CTMBELL	ESD9-HLW-CTMBELL-CAN	09-HLW-FAIL-IN-BELL
	ESD9-HLW-2BLK	ESD9-HLW-2BLK-CAN2	09-HLW_FAIL_IN_CTM_2BL
CRCF-ESD09-MCO	ESD9-MCO-LIDIMP	ESD9-MCO-LIDIMP-CAN	09-MCO-FAIL-LID-IMPACT
	ESD9-MCO-DROP	ESD9-MCO-DROP-CAN	09-MCO-FAIL-DROP
	ESD9-MCO-SPUR	ESD9-MCO-SPUR-CAN	09-MCO-FAIL-SPURMOVE
	ESD9-MCO-SIMPACT	ESD9-MCO-SIMPACT-CAN	09-MCO-FAIL-SIMPACT
	ESD9-MCO-DROPON	ESD9-MCO-DROPON-CAN	09-MCO-FAIL-DROPON
	ESD9-MCO-CTMBELL	ESD9-MCO-CTMBELL-CAN	09-MCO-FAIL-IN-BELL
	ESD9-MCO-2BLK	ESD9-MCO-2BLK-CAN2	09-MCO_FAIL_IN_CTM_2BL
CRCF-ESD09-TAD	ESD9-TAD-LIDIMP	ESD9-TAD-LIDIMP-CAN	09-CAN-FAIL-LID-IMPACT
	ESD9-TAD-DROP	ESD9-TAD-DROP-CAN	09-CAN-FAIL-DROP

Table A4.9-3. Basic Events Associated with the CANISTER Pivotal Events of CRC-ESD-09 (Continued)

Initiator Event Tree	Initiating Event Name	Name Assigned to CANISTER	Associated Fault Tree or Basic Event ^a
	ESD9-TAD-SPUR	ESD9-TAD-SPUR-CAN	09-CAN-FAIL-SPURMOVE
	ESD9-TAD-SIMPACT	ESD9-TAD-SIMPACT-CAN	09-CAN-FAIL-SIMPACT
	ESD9-TAD-DROPON	ESD9-TAD-DROPON-CAN	09-CAN-FAIL-DROPON
	ESD9-TAD-CTMBELL	ESD9-TAD-CTMBELL-CAN	09-CAN-FAIL-IN-BELL
	ESD9-TAD-2BLK	ESD9-TAD-2BLK-CAN2	09-CAN FAIL IN CTM_2BL

NOTE: ^aThis column may contain fault trees and basic events. See Attachment B for fault trees and Attachment C for basic events.

Source: Original

SHIELDING. Table A4.9-4 indicates the fault trees or basic events that are associated with this pivotal event for each initiating event.

Table A4.9-4. Basic Events Associated with the SHIELDING Pivotal Events of CRC-ESD-09

Initiator Event Tree	Initiating Event Name	Name Assigned to SHIELDING	Associated Fault Tree or Basic Event ^a
CRCF-ESD09-DPC	ESD9-DPC-LIDIMP	ESD9-DPC-LIDIMP-SHIELD	CTM_SHIELDING
	ESD9-DPC-DROP	ESD9-DPC-DROP-SHIELD	
	ESD9-DPC-SPUR	ESD9-DPC-SPUR-SHIELD	
	ESD9-DPC-SIMPACT	ESD9-DPC-SIMPACT-SHIELD	
	ESD9-DPC-DROPON	ESD9-DPC-DROPON-SHIELD	
	ESD9-DPC-CTMBELL	ESD9-DPC-CTMBELL-SHIELD	
	ESD9-DPC-2BLK	ESD9-DPC-2BLK-SHIELD	
CRCF-ESD09-DSTD	ESD9-DSNF-LIDIMP	ESD9-DSNF-LIDIMP-SHIELD	
	ESD9-DSNF-DROP	ESD9-DSNF-DROP-SHIELD	
	ESD9-DSNF-SPUR	ESD9-DSNF-SPUR-SHIELD	
	ESD9-DSNF-SIMPACT	ESD9-DSNF-SIMPACT-SHIELD	
	ESD9-DSNF-DROPON	ESD9-DSNF-DROPON-SHIELD	
	ESD9-DSNF-CTMBELL	ESD9-DSNF-CTMBELL-SHIELD	
	ESD9-DSNF-2BLK	ESD9-DSNF-2BLK-SHIELD	
CRCF-ESD09-HLW	ESD9-HLW-LIDIMP	ESD9-HLW-LIDIMP-SHIELD	
	ESD9-HLW-DROP	ESD9-HLW-DROP-SHIELD	
	ESD9-HLW-SPUR	ESD9-HLW-SPUR-SHIELD	
	ESD9-HLW-SIMPACT	ESD9-HLW-SIMPACT-SHIELD	
	ESD9-HLW-DROPON	ESD9-HLW-DROPON-SHIELD	

Table A4.9-4. Basic Events Associated with the SHIELDING Pivotal Events of CRC-ESD-09
(Continued)

Initiator Event Tree	Initiating Event Name	Name Assigned to SHIELDING	Associated Fault Tree or Basic Event ^a
	ESD9-HLW-CTMBELL	ESD9-HLW-CTMBELL-SHIELD	
	ESD9-HLW-2BLK	ESD9-HLW-2BLK-SHIELD	
CRCF-ESD09-MCO	ESD9-MCO-LIDIMP	ESD9-MCO-LIDIMP-SHIELD	
	ESD9-MCO-DROP	ESD9-MCO-DROP-SHIELD	
	ESD9-MCO-SPUR	ESD9-MCO-SPUR-SHIELD	
	ESD9-MCO-SIMPACT	ESD9-MCO-SIMPACT-SHIELD	
	ESD9-MCO-DROPON	ESD9-MCO-DROPON-SHIELD	
	ESD9-MCO-CTMBELL	ESD9-MCO-CTMBELL-SHIELD	
	ESD9-MCO-2BLK	ESD9-MCO-2BLK-SHIELD	
CRCF-ESD09-TAD	ESD9-TAD-LIDIMP	ESD9-TAD-LIDIMP-SHIELD	
	ESD9-TAD-DROP	ESD9-TAD-DROP-SHIELD	
	ESD9-TAD-SPUR	ESD9-TAD-SPUR-SHIELD	
	ESD9-TAD-SIMPACT	ESD9-TAD-SIMPACT-SHIELD	
	ESD9-TAD-DROPON	ESD9-TAD-DROPON-SHIELD	
	ESD9-TAD-CTMBELL	ESD9-TAD-CTMBELL-SHIELD	
	ESD9-TAD-2BLK	ESD9-TAD-2BLK-SHIELD	

NOTE: ^aThis column may contain fault trees and basic events. See Attachment B for fault trees and Attachment C for basic events.

Source: Original

CONFINEMENT. Table A4.9-5 indicates the fault trees or basic events that are associated with this pivotal event for each initiating event.

Table A4.9-5. Basic Event Associated with the CONFINEMENT Pivotal Events of CRC-ESD-09

Initiator Event Tree	Initiating Event Name	Name Assigned to CONFINEMENT	Associated Fault Tree or Basic Event ^a
CRCF-ESD09-DPC	ESD9-DPC-LIDIMP	ESD9-CONF ^b	060-DP-LOSS-CRCF
	ESD9-DPC-DROP		
	ESD9-DPC-SPUR		
	ESD9-DPC-SIMPACT		
	ESD9-DPC-DROPON		
	ESD9-DPC-CTMBELL		
	ESD9-DPC-2BLK		
CRCF-ESD09-DSTD	ESD9-DSNF-LIDIMP		
	ESD9-DSNF-DROP		
	ESD9-DSNF-SPUR		

Table A4.9-5. Basic Event Associated with the CONFINEMENT Pivotal Events of CRC-ESD-09
(Continued)

Initiator Event Tree	Initiating Event Name	Name Assigned to CONFINEMENT	Associated Fault Tree or Basic Event ^a
	ESD9-DSNF-SIMPACT		
	ESD9-DSNF-DROPON		
	ESD9-DSNF-CTMBELL		
	ESD9-DSNF-2BLK		
CRCF-ESD09-HLW	ESD9-HLW-LIDIMP		
	ESD9-HLW-DROP		
	ESD9-HLW-SPUR		
	ESD9-HLW-SIMPACT		
	ESD9-HLW-DROPON		
	ESD9-HLW-CTMBELL		
	ESD9-HLW-2BLK		
CRCF-ESD09-MCO	ESD9-MCO-LIDIMP		
	ESD9-MCO-DROP		
	ESD9-MCO-SPUR		
	ESD9-MCO-SIMPACT		
	ESD9-MCO-DROPON		
	ESD9-MCO-CTMBELL		
	ESD9-MCO-2BLK		
CRCF-ESD09-TAD	ESD9-TAD-LIDIMP		
	ESD9-TAD-DROP		
	ESD9-TAD-SPUR		
	ESD9-TAD-SIMPACT		
	ESD9-TAD-DROPON		
	ESD9-TAD-CTMBELL		
	ESD9-TAD-2BLK		

NOTE: ^aThis column may contain fault trees and basic events. See Attachment B for fault trees and Attachment C for basic events.

^bThis passes through a transfer tree named CONFINEMENT.

Source: Original

MODERATOR. The conditional probability of failure (introduction of liquid moderator) is the same for all waste forms and all initiating events as shown in Table A4.9-6.

Table A4.9-6. Basic Event Associated with the MODERATOR Pivotal Events of CRC-ESD-09

Initiator Event Tree	Initiating Event Name	Name Assigned to MODERATOR	Associated Fault Tree or Basic Event ^a
CRCF-ESD09-DPC	ESD9-DPC-LIDIMP	ESD9-MOD	060-MODERATOR-SOURCE
	ESD9-DPC-DROP		
	ESD9-DPC-SPUR		
	ESD9-DPC-SIMPACT		
	ESD9-DPC-DROPON		
	ESD9-DPC-CTMBELL		
CRCF-ESD09-DSTD	ESD9-DPC-2BLK		
	ESD9-DSNF-LIDIMP		
	ESD9-DSNF-DROP		
	ESD9-DSNF-SPUR		
	ESD9-DSNF-SIMPACT		
	ESD9-DSNF-DROPON		
	ESD9-DSNF-CTMBELL		
CRCF-ESD09-HLW	ESD9-DSNF-2BLK		
	ESD9-HLW-LIDIMP		
	ESD9-HLW-DROP		
	ESD9-HLW-SPUR		
	ESD9-HLW-SIMPACT		
	ESD9-HLW-DROPON		
	ESD9-HLW-CTMBELL		
CRCF-ESD09-MCO	ESD9-HLW-2BLK		HLW-MODERATOR
	ESD9-MCO-LIDIMP		
	ESD9-MCO-DROP		
	ESD9-MCO-SPUR		
	ESD9-MCO-SIMPACT		
	ESD9-MCO-DROPON		
	ESD9-MCO-CTMBELL		
CRCF-ESD09-TAD	ESD9-MCO-2BLK		060-MODERATOR-SOURCE
	ESD9-TAD-LIDIMP		
	ESD9-TAD-DROP		
	ESD9-TAD-SPUR		
	ESD9-TAD-SIMPACT		
	ESD9-TAD-DROPON		
	ESD9-TAD-CTMBELL		
ESD9-TAD-2BLK			

NOTE: ^a This column may contain fault trees and basic events. See Attachment B for fault trees and Attachment C for basic events.

Source: Original

A4.10 EVENT TREES FOR CRC-ESD-10

CRC-ESD-10 covers event sequences associated with movement of the WPTT within the Waste Package Positioning Room from the waste package loading position to the waste package closure position (Ref. 2.2.33, Figure F-10). This ESD covers all canister types that are loaded into waste packages in the CRCF. Corresponding to each waste form unit is an initiator event tree (Table A4.10-1). Although the initiator event trees transfer to the same response tree, the response tree is customized within SAPHIRE for each initiator event tree by the use of basic rules. The rules instruct SAPHIRE where to look for the fault tree that models each pivotal event. The assignments made in the rules files are indicated in this section.

Table A4.10-1. Summary of Event Trees for CRC-ESD-10

Waste Form Unit	Associated Event Trees	Number of Waste Form Units
Waste package containing 1 DOE standardized canister and 4 to 5 HLW canisters	Initiator: CRCF-ESD10-WP-H&D Response: RESPONSE-WP1	3,300
Waste package containing 2 HLW canisters and 2 MCOs	Initiator: CRCF-ESD10-WP-H&M Response: RESPONSE-WP1	225
Waste package loaded with a TAD canister	Initiator: CRCF-ESD10-WP-TAD Response: RESPONSE-WP1	8,143

Source: *Waste Form Throughputs for Preclosure Safety Analysis*, (Ref. 2.2.31, Table 4)

A4.10.1 Initiating Events for CRC-ESD-10

The following initiating events are associated with CRC-ESD-10. The assignments made within SAPHIRE for quantification of these initiating events are indicated in Table A4.10-2.

WPTT Derailment. This initiating event accounts for the potential derailment of the WPTT.

WPTT Collision with Facility Structures or Facility Equipment. This initiating event accounts for the potential impact to the waste package due to a WPTT collision with facility structures or facility equipment.

Premature Tilt-down of the WPTT. This initiating event accounts for the potential impact to the waste package due to a premature tilt-down of the WPTT.

Table A4.10-2. Initiating Event Assignments for CRC-ESD-10

Initiating Event Description	Initiator Event Tree	SAPHIRE Assignment by Basic Rules	SAPHIRE Assignment at Fault Tree Level ^a
WPTT derailment	CRCF-ESD10-WP-H&D	ESD10-WP-H&D-DERAIL	060-WPTT-DERAIL
	CRCF-ESD10-WP-H&M	ESD10-WP-H&M-DERAIL	
	CRCF-ESD10-WP-TAD	ESD10-WP-TAD-DERAIL	
WPTT collision	CRCF-ESD10-WP-H&D	ESD10-WP-H&D-COLLIDE	060-WPTT-IMPACT
	CRCF-ESD10-WP-H&M	ESD10-WP-H&M-COLLIDE	
	CRCF-ESD10-WP-TAD	ESD10-WP-TAD-COLLIDE	
Premature tilt-down	CRCF-ESD10-WP-H&D	ESD10-WP-H&D-TILT	060-WPTT-PRE-TIL
	CRCF-ESD10-WP-H&M	ESD10-WP-H&M-TILT	
	CRCF-ESD10-WP-TAD	ESD10-WP-TAD-TILT	

NOTE: ^a This column may contain fault trees and basic events. See Attachment B for fault trees and Attachment C for basic events.

Source: Original

A4.10.2 System Response Event Tree RESPONSE-WP1

The pivotal events that appear in RESPONSE-WP1 are listed below and summarized in Section A3. The accompanying tables show the association of pivotal event names with basic event or fault tree names.

CANISTER. Table A4.10-3 indicates the fault trees or basic events that are associated with this pivotal event for each initiating event.

Table A4.10-3. Basic Events Associated with the CANISTER Pivotal Events of CRC-ESD-10

Initiator Event Tree	Initiating Event Name	Name Assigned to CANISTER	Associated Fault Tree or Basic Event ^a
CRCF-ESD10-WP-H&D	ESD10-WP-H&D-DERAIL	ESD10-WP-H&D-DERAIL-CAN	10-H&D-FAIL-WPTT-DERAIL
	ESD10-WP-H&D-COLLIDE	ESD10-WP-H&D-COLLIDE-CAN	10-H&D-FAIL-WPTT-COLLIDE
	ESD10-WP-H&D-TILT	ESD10-WP-H&D-TILT-CAN	10-H&D-FAIL-WPTT-TILT
CRCF-ESD10-WP-H&M	ESD10-WP-H&M-DERAIL	ESD10-WP-H&M-DERAIL-CAN	10-H&M-FAIL-WPTT-DERAIL
	ESD10-WP-H&M-COLLIDE	ESD10-WP-H&M-COLLIDE-CAN	10-H&M-FAIL-WPTT-COLLIDE
	ESD10-WP-H&M-TILT	ESD10-WP-H&M-TILT-CAN	10-H&M-FAIL-WPTT-TILT
CRCF-ESD10-WP-TAD	ESD10-WP-TAD-DERAIL	ESD10-WP-TAD-DERAIL-CAN	10-CAN-FAIL-WPTT-DERAIL
	ESD10-WP-TAD-COLLIDE	ESD10-WP-TAD-COLLIDE-CAN	10-CAN-FAIL-WPTT-COLLIDE
	ESD10-WP-TAD-TILT	ESD10-WP-TAD-TILT-CAN	10-CAN-FAIL-WPTT-TILT

NOTE: ^a This column may contain fault trees and basic events. See Attachment B for fault trees and Attachment C for basic events.

Source: Original

SHIELDING. This pivotal event represents the success or failure of the shielding (waste package lid, shield ring, and WPTT shielding) to provide its shielding function after the impact caused by the initiating event. Failure of shielding in this instance refers to an unspecified degree of shielding degradation due to the impact. Table A4.10-4 indicates the fault trees or basic events that are associated with this pivotal event for each initiating event.

Table A4.10-4. Basic Events Associated with the SHIELDING Pivotal Events of CRC-ESD-10

Initiator Event Tree	Initiating Event Name	Name Assigned to SHIELDING	Associated Fault Tree or Basic Event ^a
CRCF-ESD10-WP-H&D	ESD10-WP-H&D-DETRAIL	ESD10-WP-H&D-DETRAIL-SHIE	10-WPTT_SHIELDING
	ESD10-WP-H&D-COLLIDE	ESD10-WP-H&D-COLLIDE-SHI	10-WPTT_SHIELDING
	ESD10-WP-H&D-TILT	ESD10-WP-H&D-TILT-SHIELD	10-WP_SHIELDING
CRCF-ESD10-WP-H&M	ESD10-WP-H&M-DETRAIL	ESD10-WP-H&M-DETRAIL-SHIE	10-WPTT_SHIELDING
	ESD10-WP-H&M-COLLIDE	ESD10-WP-H&M-COLLIDE-SHI	10-WPTT_SHIELDING
	ESD10-WP-H&M-TILT	ESD10-WP-H&M-TILT-SHIELD	10-WP_SHIELDING
CRCF-ESD10-WP-TAD	ESD10-WP-TAD-DETRAIL	ESD10-WP-TAD-DETRAIL-SHI	10-WPTT_SHIELDING
	ESD10-WP-TAD-COLLIDE	ESD10-WP-TAD-COLLIDE-SH	10-WPTT_SHIELDING
	ESD10-WP-TAD-TILT	ESD10-WP-TAD-TILT-SHIEL	10-WP_SHIELDING

NOTE: ^a This column may contain fault trees and basic events. See Attachment B for fault trees and Attachment C for basic events.

Source: Original

CONFINEMENT. Table A4.10-5 indicates the fault trees or basic events that are associated with this pivotal event for each initiating event.

Table A4.10-5. Basic Event Associated with the CONFINEMENT Pivotal Events of CRC-ESD-10

Initiator Event Tree	Initiating Event	Name Assigned to CONFINEMENT	Associated Fault Tree or Basic Event ^a
CRCF-ESD10-WP-H&D	ESD10-WP-H&D-DETRAIL	ESD10-CONF ^b	060-DP-LOSS-CRCF
	ESD10-WP-H&D-COLLIDE		
	ESD10-WP-H&D-TILT		
CRCF-ESD10-WP-H&M	ESD10-WP-H&M-DETRAIL		
	ESD10-WP-H&M-COLLIDE		
	ESD10-WP-H&M-TILT		
CRCF-ESD10-WP-TAD	ESD10-WP-TAD-DETRAIL		
	ESD10-WP-TAD-COLLIDE		
	ESD10-WP-TAD-TILT		

NOTE: ^a This column may contain fault trees and basic events. See Attachment B for fault trees and Attachment C for basic events.

^b This passes through a transfer tree named CONFINEMENT.

Source: Original

MODERATOR. The conditional probability of failure (introduction of liquid moderator) is the same for all waste forms and initiating events as shown in Table A4.10-6.

Table A4.10-6. Basic Event Associated with the MODERATOR Pivotal Events of CRC-ESD-10

Initiator Event Tree	Initiating Event	Name Assigned to MODERATOR	Associated Fault Tree or Basic Event ^a
CRCF-ESD10-WP-H&D	ESD10-WP-H&D-DERAIL	ESD10-MOD	060-MODERATOR-SOURCE
	ESD10-WP-H&D-COLLIDE		
	ESD10-WP-H&D-TILT		
CRCF-ESD10-WP-H&M	ESD10-WP-H&M-DERAIL	ESD10-MOD	060-MODERATOR-SOURCE
	ESD10-WP-H&M-COLLIDE		
	ESD10-WP-H&M-TILT		
CRCF-ESD10-WP-TAD	ESD10-WP-TAD-DERAIL	ESD10-MOD	060-MODERATOR-SOURCE
	ESD10-WP-TAD-COLLIDE		
	ESD10-WP-TAD-TILT		

NOTE: ^a This column may contain fault trees and basic events. See Attachment B for fault trees and Attachment C for basic events.

Source: Original

A4.11 EVENT TREES FOR CRC-ESD-11

CRC-ESD-11 covers event sequences associated with the assembly and closure of the waste package (Ref. 2.2.33, Figure F-11). This ESD covers waste packages. Corresponding to each waste form unit is an initiator event tree (Table A4.11-1). Although the initiator event trees transfer to the same response tree, the response tree is customized within SAPHIRE for each initiator event tree by the use of basic rules. The rules instruct SAPHIRE where to look for the fault tree that models each pivotal event. The assignments made in the rules files are indicated in this section.

Table A4.11-1. Summary of Event Trees for CRC-ESD-11

Waste Form Unit	Associated Event Trees	Number of Waste Form Units
Waste package containing 1 DOE standardized canister and 4 to 5 HLW canisters	Initiator: CRCF-ESD11-WP-H&D Response: RESPONSE-WP1	3,300
Waste package containing 2 HLW canisters and 2 MCOs	Initiator: CRCF-ESD11-WP-H&M Response: RESPONSE-WP1	225
Waste package loaded with a TAD canister	Initiator: CRCF-ESD11-WP-TAD Response: RESPONSE-WP1	8,143

Source: Ref. 2.2.31 Table 4

A4.11.1 Initiating Events for CRC-ESD-11

The following initiating events are associated with CRC-ESD-11. The assignments made within SAPHIRE for quantification of these initiating events are indicated in Table A4.11-2.

Welding Damages Canister. This initiating event accounts for the potential impact to the waste package due to a thermal challenge from the welding equipment.

Remote Handling System Drops Object. This initiating event accounts for the potential impact to the waste package due to the drop of an object by the RHS.

Table A4.11-2. Initiating Event Assignments for CRC-ESD-11

Initiating Event Description	Initiator Event Tree	SAPHIRE Assignment by Basic Rules	SAPHIRE Assignment at Fault Tree Level ^a
Welding damages canister	CRCF-ESD11-WP-H&D	ESD11-WP-H&D-DAMAGE	WELD_DAMAGE
	CRCF-ESD11-WP-H&M	ESD11-WP-H&M-DAMAGE	
	CRCF-ESD11-WP-TAD	ESD11-WP-TAD-DAMAGE	
RHS drops object	CRCF-ESD11-WP-H&D	ESD11-WP-H&D-DROPON	060-11-RHS-H&D-DROP-ON AND 060-RHSLIFTNUMBER-000001 ^b
	CRCF-ESD11-WP-H&M	ESD11-WP-H&M-DROPON	060-11-RHS-H&M-DROP-ON AND 060-RHSLIFTNUMBER-000001 ^b
	CRCF-ESD11-WP-TAD	ESD11-WP-TAD-DROPON	060-11-RHS-TAD-DROP-ON AND 060-RHSLIFTNUMBER-000001 ^b

NOTE: ^aThis column may contain fault trees and basic events. See Attachment B for fault trees and Attachment C for basic events.

^bBasic event and fault tree connected by an AND gate are discussed in Attachment B, Section B9.

Source: Original

A4.11.2 System Response Event Tree RESPONSE-WP1

The pivotal events that appear in RESPONSE-WP1 are summarized below. The accompanying tables show the association of pivotal event names with basic event or fault tree names.

CANISTER. Table A4.11-3 indicates the fault trees or basic events that are associated with this pivotal event for each initiating event.

Table A4.11-3. Basic Events Associated with the CANISTER Pivotal Events of CRC-ESD-11

Initiator Event Tree	Initiating Event Name	Name Assigned to CANISTER	Associated Fault Tree or Basic Event ^a
CRCF-ESD11-WP-H&D	ESD11-WP-H&D-DAMAGE	ESD11-WP-H&D-DAMAGE-CAN	11-H&D-FAIL-WP-WELD
	ESD11-WP-H&D-DROPON	ESD11-WP-H&D-DROPON-CAN	11-H&D-FAIL-WP-DROPON
CRCF-ESD11-WP-H&M	ESD11-WP-H&M-DAMAGE	ESD11-WP-H&M-DAMAGE-CAN	11-H&M-FAIL-WP-WELD
	ESD11-WP-H&M-DROPON	ESD11-WP-H&M-DROPON-CAN	11-H&M-FAIL-WP-DROPON

Table A4.11-3. Basic Events Associated with the CANISTER Pivotal Events of CRC-ESD-11 (Continued)

Initiator Event Tree	Initiating Event Name	Name Assigned to CANISTER	Associated Fault Tree or Basic Event ^a
CRCF-ESD11-WP-TAD	ESD11-WP-TAD-DAMAGE	ESD11-WP-TAD-DAMAGE-CAN	11-CAN-FAIL-WP-WELD
	ESD11-WP-TAD-DROPON	ESD11-WP-TAD-DROPON-CAN	11-CAN-FAIL-WP-DROPON

NOTE: ^a This column may contain fault trees and basic events. See Attachment B for fault trees and Attachment C for basic events.

Source: Original

SHIELDING. Table A4.11-4 indicates the fault trees or basic events that are associated with this pivotal event for each initiating event.

Table A4.11-4. Basic Events Associated with the SHIELDING Pivotal Events of CRC-ESD-11

Initiator Event Tree	Initiating Event Name	Name Assigned to SHIELDING	Associated Fault Tree or Basic Event ^a
CRCF-ESD11-WP-H&D	ESD11-WP-H&D-DAMAGE	ESD11-WP-H&D-DAMAGE-SHI	WP_SHIELDING
	ESD11-WP-H&D-DROPON	ESD11-WP-H&D-DROPON-SHI	
CRCF-ESD11-WP-H&M	ESD11-WP-H&M-DAMAGE	ESD11-WP-H&M-DAMAGE-SHI	
	ESD11-WP-H&M-DROPON	ESD11-WP-H&M-DROPON-SHI	
CRCF-ESD11-WP-TAD	ESD11-WP-TAD-DAMAGE	ESD11-WP-TAD-DAMAGE-SHI	
	ESD11-WP-TAD-DROPON	ESD11-WP-TAD-DROPON-SHI	

NOTE: ^a This column may contain fault trees and basic events. See Attachment B for fault trees and Attachment C for basic events.

Source: Original

CONFINEMENT. Table A4.11-5 indicates the fault trees or basic events that are associated with this pivotal event for each initiating event.

Table A4.11-5. Basic Event Associated with the CONFINEMENT Pivotal Events of CRC-ESD-11

Initiator Event Tree	Initiating Event	Name Assigned to CONFINEMENT	Associated Fault Tree or Basic Event ^a
CRCF-ESD11-WP-H&D	ESD11-WP-H&D-DAMAGE	ESD11-CONF ^b	060-DP-LOSS-CRCF
	ESD11-WP-H&D-DROPON		
CRCF-ESD11-WP-H&M	ESD11-WP-H&M-DAMAGE		
	ESD11-WP-H&M-DROPON		
CRCF-ESD11-WP-TAD	ESD11-WP-TAD-DAMAGE		
	ESD11-WP-TAD-DROPON		

NOTE: ^a This column may contain fault trees and basic events. See Attachment B for fault trees and Attachment C for basic events.

^b This passes through a transfer tree named CONFINEMENT.

Source: Original

MODERATOR. The conditional probability of failure (introduction of liquid moderator) is the same for all waste forms and initiating events as shown in Table A4.11-6.

Table A4.11-6. Basic Event Associated with the MODERATOR Pivotal Events of CRC-ESD-11

Initiator Event Tree	Initiating Event	Name Assigned to MODERATOR	Associated Fault Tree or Basic Event ^a
CRCF-ESD11-WP-H&D	ESD11-WP-H&D-DAMAGE	ESD11-MOD	060-MODERATOR-SOURCE
	ESD11-WP-H&D-DROPON		
CRCF-ESD11-WP-H&M	ESD11-WP-H&M-DAMAGE		
	ESD11-WP-H&M-DROPON		
CRCF-ESD11-WP-TAD	ESD11-WP-TAD-DAMAGE		
	ESD11-WP-TAD-DROPON		

NOTE: ^a This column may contain fault trees and basic events. See Attachment B for fault trees and Attachment C for basic events.

Source: Original

A4.12 EVENT TREES FOR CRC-ESD-12

CRC-ESD-12 covers event sequences associated with assembly and closure of an aging overpack (Ref. 2.2.33, Figure F-12). This ESD covers the two waste forms that are placed in aging overpacks in the CRCF; TAD canisters and DPCs. Corresponding to each waste form unit is an initiator event tree (Table A4.12-1). Although the initiator event trees transfer to the same response tree, the response tree is customized within SAPHIRE for each initiator event tree by the use of basic rules. The rules instruct SAPHIRE where to look for the fault tree that models each pivotal event. The assignments made in the rules files are indicated in this section.

Table A4.12-1. Summary of Event Trees for CRC-ESD-12

Waste Form Unit	Associated Event Trees	Number of Waste Form Units
Aging overpack containing DPC	Initiator: CRCF-ESD12-DPC Response: RESPONSE-AO1	346
Aging overpack containing TAD canister	Initiator: CRCF-ESD12-TAD Response: RESPONSE-AO1	6,978

Source: Ref. 2.2.31, Table 4

A4.12.1 Initiating Events for CRC-ESD-12

The following initiating events are associated with CRC-ESD-12. The assignments made within SAPHIRE for quantification of these initiating events are indicated in Table A4.12-2.

Impact to an Aging Overpack. This initiating event accounts for the potential impact to the aging overpack during assembly and closure of the aging overpack.

Tipover of an Aging Overpack. This initiating event accounts for the potential tipover of the aging overpack.

Table A4.12-2. Initiating Event Assignments for CRC-ESD-12

Initiating Event Description	Initiator Event Tree	SAPHIRE Assignment by Basic Rules	SAPHIRE Assignment at Fault Tree Level ^a
Impact to an Aging Overpack.	CRCF-ESD12-DPC	ESD12-DPC-IMPACT	060-12-ST-IMPACT
	CRCF-ESD12-TAD	ESD12-TAD-IMPACT	
Tipover of an Aging Overpack	CRCF-ESD12-DPC	ESD12-DPC-TIP	060-OPTIPOVER003-HFI-NOD
	CRCF-ESD12-TAD	ESD12-TAD-TIP	

NOTE: ^a This column may contain fault trees and basic events. See Attachment B for fault trees and Attachment C for basic events.

Source: Original

A4.12.2 System Response Event Tree RESPONSE-AO1

The pivotal events that appear in RESPONSE-AO1 are listed below and summarized in Section A3. The accompanying tables show the association of pivotal event names with basic event or fault tree names.

CANISTER. Table A4.12-3 indicates the fault trees or basic events that are associated with this pivotal event for each initiating event.

Table A4.12-3. Basic Events Associated with the CANISTER Pivotal Events of CRC-ESD-12

Initiator Event Tree	Initiating Event Name	Name Assigned to CANISTER	Associated Fault Tree or Basic Event ^a
CRCF-ESD12-DPC	ESD12-DPC-IMPACT	ESD12-DPC-IMPACT-CAN	12-DPC_AO_IMPACT
	ESD12-DPC-TIP	ESD12-DPC-TIP-CAN	12-DPC_AO_TIPOVER
CRCF-ESD12-TAD	ESD12-TAD-IMPACT	ESD12-TAD-IMPACT-CAN	12-TAD_AO_IMPACT
	ESD12-TAD-TIP	ESD12-TAD-TIP-CAN	12-TAD_AO_TIP

NOTE: ^a This column may contain fault trees and basic events. See Attachment B for fault trees and Attachment C for basic events.

Source: Original

SHIELDING. Table A4.12-4 indicates the fault trees or basic events that are associated with this pivotal event for each initiating event.

Table A4.12-4. Basic Event Associated with the SHIELDING Pivotal Events of CRC-ESD-12

Initiator Event Tree	Initiating Event Name	Name Assigned to SHIELDING	Associated Fault Tree or Basic Event ^a
CRCF-ESD12-DPC	ESD12-DPC-IMPACT	ESD12-DPC-IMPACT-SHIELD	AO_SHIELDING
	ESD12-DPC-TIP	ESD12-DPC-TIP-SHIELD	
CRCF-ESD12-TAD	ESD12-TAD-IMPACT	ESD12-TAD-IMPACT-SHIELD	
	ESD12-TAD-TIP	ESD12-TAD-TIP-SHIELD	

NOTE: ^a This column may contain fault trees and basic events. See Attachment B for fault trees and Attachment C for basic events.

Source: Original

CONFINEMENT. Table A4.12-5 indicates the fault trees or basic events that are associated with this pivotal event for each initiating event.

Table A4.12-5. Basic Event Associated with the CONFINEMENT Pivotal Events of CRC-ESD-12

Initiator Event Tree	Initiating Event Name	Name Assigned to CONFINEMENT	Associated Fault Tree or Basic Event ^a
CRCF-ESD12-DPC	ESD12-DPC-IMPACT	ESD12-CONF ^b	060-DP-LOSS-CRCF
	ESD12-DPC-TIP		
CRCF-ESD12-TAD	ESD12-TAD-IMPACT		
	ESD12-TAD-TIP		

NOTE: ^a This column may contain fault trees and basic events. See Attachment B for fault trees and Attachment C for basic events.

^b This passes through a transfer tree named CONFINEMENT.

Source: Original

MODERATOR. The conditional probability of failure (introduction of liquid moderator) is the same for all waste forms and initiating events as shown in Table A4.12-6.

Table A4.12-6. Basic Event Associated with the MODERATOR Pivotal Events of CRC-ESD-12

Initiator Event Tree	Initiating Event Name	Name Assigned to MODERATOR	Associated Fault Tree or Basic Event ^a
CRCF-ESD12-DPC	ESD12-DPC-IMPACT	ESD12-MOD	060-MODERATOR-SOURCE
	ESD12-DPC-TIP		
CRCF-ESD12-TAD	ESD12-TAD-IMPACT		
	ESD12-TAD-TIP		

NOTE: ^a This column may contain fault trees and basic events. See Attachment B for fault trees and Attachment C for basic events.

Source: Original

A4.13 EVENT TREES FOR CRC-ESD-13

CRC-ESD-13 covers event sequences associated with the transfer of a waste package from the Waste Package Positioning Room to the WPTT docking station (Ref. 2.2.33, Figure F-13). This

ESD covers all waste forms that are loaded into waste packages. Corresponding to each waste form unit is an initiator event tree (Table A4.13-1). Although the initiator event trees transfer to the same response tree, the response tree is customized within SAPHIRE for each initiator event tree by the use of basic rules. The rules instruct SAPHIRE where to look for the fault tree that models each pivotal event. The assignments made in the rules files are indicated in this section.

Table A4.13-1. Summary of Event Trees for CRC-ESD-13

Waste Form Unit	Associated Event Trees	Number of Waste Form Units
Waste package containing HLW and Standardized DOE SNF canisters	CRCF-ESD13-WP-H&D	3,300
Waste package containing HLW and MCOs	CRCF-ESD13-WP-H&M	225
Waste package containing TAD canister	CRCF-ESD13-WP-TAD	8,143

Source: Ref. 2.2.31 Table 4

A4.13.1 Initiating Events for CRC-ESD-13

The following initiating events are associated with CRC-ESD-13. The assignments made within SAPHIRE for quantification of these initiating events are indicated in Table A4.13-2.

WPTT Derailment. This initiating event accounts for the potential derailment of the WPTT during movement.

WPTT Collision. This initiating event accounts for the potential impact to the transportation cask due to a WPTT collision.

WPTT Premature Tilt-down. This initiating event accounts for the potential tilt-down of the WPTT during movement.

Table A4.13-2. Initiating Event Assignments for CRC-ESD-13

Initiating Event Description	Initiator Event Tree	SAPHIRE Assignment by Basic Rules	SAPHIRE Assignment at Fault Tree Level ^a
WPTT derailment	CRCF-ESD13-WP-H&D	ESD13-WP-H&D-DERAIL	060-WPTT-DERAIL
	CRCF-ESD13-WP-H&M	ESD13-WP-H&M-DERAIL	
	CRCF-ESD13-WP-TAD	ESD13-WP-TAD-DERAIL	
WPTT collision	CRCF-ESD13-WP-H&D	ESD13-WP-H&D-SIMPACT	060-13-WPTT-IMPACT
	CRCF-ESD13-WP-H&M	ESD13-WP-H&M-SIMPACT	
	CRCF-ESD13-WP-TAD	ESD13-WP-TAD-SIMPACT	
Premature WPTT tilt-down	CRCF-ESD13-WP-H&D	ESD13-WP-H&D-TILT	060-WPTT-PRE-TIL

Table A4.13-2. Initiating Event Assignments for CRC-ESD-13 (Continued)

Initiating Event Description	Initiator Event Tree	SAPHIRE Assignment by Basic Rules	SAPHIRE Assignment at Fault Tree Level ^a
	CRCF-ESD13-WP-H&M	ESD13-WP-H&M-TILT	
	CRCF-ESD13-WP-TAD	ESD13-WP-TAD-TILT	

NOTE: ^a This column may contain fault trees and basic events. See Attachment B for fault trees and Attachment C for basic events.

Source: Original

A4.13.2 System Response Event Tree RESPONSE-WP2

The pivotal events that appear in RESPONSE-WP2 are listed below and summarized in Section A3. The accompanying tables show the association of pivotal event names with basic event or fault tree names.

WP. Table A4.13-3 indicates the fault trees or basic events that are associated with this pivotal event for each initiating event.

Table A4.13-3. Basic Event Associated with the Waste Package Pivotal Events of CRC-ESD-13

Initiator Event Tree	Initiating Event	Name Assigned to WP	Associated Fault Tree or Basic Event ^a
CRCF-ESD13-WP-H&D	ESD13-WP-H&D-DERAIL	ESD13-WP-H&D-DERAIL-WP	13-WP_FAILURE_DERAIL
	ESD13-WP-H&D-SIMPACT	ESD13-WP-H&D-SIMPACT-WP	13-WP_FAIL_COLLISION
	ESD13-WP-H&D-TILT	ESD13-WP-H&D-TILT-WP	13-WP_FAIL_TILT
CRCF-ESD13-WP-H&M	ESD13-WP-H&M-DERAIL	ESD13-WP-H&M-DERAIL-WP	13-WP_FAILURE_DERAIL
	ESD13-WP-H&M-SIMPACT	ESD13-WP-H&M-SIMPACT-WP	13-WP_FAIL_COLLISION
	ESD13-WP-H&M-TILT	ESD13-WP-H&M-TILT-WP	13-WP_FAIL_TILT
CRCF-ESD13-WP-TAD	ESD13-WP-TAD-DERAIL	ESD13-WP-TAD-DERAIL-WP	13-WP_FAILURE_DERAIL
	ESD13-WP-TAD-SIMPACT	ESD13-WP-TAD-SIMPACT-WP	13-WP_FAIL_COLLISION
	ESD13-WP-TAD-TILT	ESD13-WP-TAD-TILT-WP	13-WP_FAIL_TILT

NOTE: ^a This column may contain fault trees and basic events. See Attachment B for fault trees and Attachment C for basic events.

Source: Original

CANISTER. Table A4.13-4 indicates the fault trees or basic events that are associated with this pivotal event for each initiating event.

Table A4.13-4. Basic Events Associated with the CANISTER Pivotal Events of CRC-ESD-13

Initiator Event Tree	Initiating Event	Name Assigned to CANISTER	Associated Fault
----------------------	------------------	---------------------------	------------------

			Tree or Basic Event^a
CRCF-ESD13-WP-H&D	ESD13-WP-H&D-DERAIL	ESD13-WP-H&D-DERAIL-CAN	13-H&D-FAIL-IN-WP
	ESD13-WP-H&D-SIMPACT	ESD13-WP-H&D-SIMPACT-CAN	
	ESD13-WP-H&D-TILT	ESD13-WP-H&D-TILT-CAN	
CRCF-ESD13-WP-H&M	ESD13-WP-H&M-DERAIL	ESD13-WP-H&M-DERAIL-CAN	13-H&M-FAIL-IN-WP
	ESD13-WP-H&M-SIMPACT	ESD13-WP-H&M-SIMPACT-CAN	
	ESD13-WP-H&M-TILT	ESD13-WP-H&M-TILT-CAN	
CRCF-ESD13-WP-TAD	ESD13-WP-TAD-DERAIL	ESD13-WP-TAD-DERAIL-CAN	13-TAD-FAIL-IN-WP
	ESD13-WP-TAD-SIMPACT	ESD13-WP-TAD-SIMPACT-CAN	
	ESD13-WP-TAD-TILT	ESD13-WP-TAD-TILT-CAN	

NOTE: ^a This column may contain fault trees and basic events. See Attachment B for fault trees and Attachment C for basic events.

Source: Original

SHIELDING. Table A4.13-5 indicates the fault trees or basic events that are associated with this pivotal event for each initiating event.

Table A4.13-5. Basic Events Associated with the SHIELDING Pivotal Events of CRC-ESD-13

Initiator Event Tree	Initiating Event	Name Assigned to SHIELDING	Associated Fault Tree or Basic Event^a
CRCF-ESD13-WP-H&D	ESD13-WP-H&D-DERAIL	ESD13-WP-H&D-DERAIL-SHIELD	CASK-SHIELDING
	ESD13-WP-H&D-SIMPACT	ESD13-WP-H&D-SIMPACT-SHIELD	
	ESD13-WP-H&D-TILT	ESD13-WP-H&D-TILT-SHIELD	
CRCF-ESD13-WP-H&M	ESD13-WP-H&M-DERAIL	ESD13-WP-H&M-DERAIL-SHIELD	CASK-SHIELDING
	ESD13-WP-H&M-SIMPACT	ESD13-WP-H&M-SIMPACT-SHIELD	
	ESD13-WP-H&M-TILT	ESD13-WP-H&M-TILT-SHIELD	
CRCF-ESD13-WP-TAD	ESD13-WP-TAD-DERAIL	ESD13-WP-TAD-DERAIL-SHIELD	CASK-SHIELDING
	ESD13-WP-TAD-SIMPACT	ESD13-WP-TAD-SIMPACT-SHIELD	
	ESD13-WP-TAD-TILT	ESD13-WP-TAD-TILT-SHIELD	

NOTE: ^a This column may contain fault trees and basic events. See Attachment B for fault trees and Attachment C for basic events.

Source: Original

CONFINEMENT. Table A4.13-6 indicates the fault trees or basic events that are associated with this pivotal event for each initiating event.

Table A4.13-6. Basic Event Associated with the CONFINEMENT Pivotal Events of CRC-ESD-13

Initiator Event Tree	Initiating Event	Name Assigned to CONFINEMENT	Associated Fault Tree or Basic Event ^a
CRCF-ESD13-WP-H&D	ESD13-WP-H&D-DERAIL	ESD13-CONF ^b	060-DP-LOSS-CRCF
	ESD13-WP-H&D-SIMPACT		
	ESD13-WP-H&D-TILT		
CRCF-ESD13-WP-H&M	ESD13-WP-H&M-DERAIL		
	ESD13-WP-H&M-SIMPACT		
	ESD13-WP-H&M-TILT		
CRCF-ESD13-WP-TAD	ESD13-WP-TAD-DERAIL		
	ESD13-WP-TAD-SIMPACT		
	ESD13-WP-TAD-TILT		

NOTE: ^a This column may contain fault trees and basic events. See Attachment B for fault trees and Attachment C for basic events.

^b This passes through a transfer tree named CONFINEMENT.

Source: Original

MODERATOR. The conditional probability of failure (introduction of liquid moderator) is the same for all waste forms and initiating events as shown in Table A4.13-7.

Table A4.13-7. Basic Event Associated with the MODERATOR Pivotal Events of CRC-ESD-13

Initiator Event Tree	Initiating Event	Name Assigned to MODERATOR	Associated Fault Tree or Basic Event ^a
CRCF-ESD13-WP-H&D	ESD13-WP-H&D-DERAIL	ESD13-MOD	060-MODERATOR-SOURCE
	ESD13-WP-H&D-SIMPACT		
	ESD13-WP-H&D-TILT		
CRCF-ESD13-WP-H&M	ESD13-WP-H&M-DERAIL		
	ESD13-WP-H&M-SIMPACT		
	ESD13-WP-H&M-TILT		
CRCF-ESD13-WP-TAD	ESD13-WP-TAD-DERAIL		
	ESD13-WP-TAD-SIMPACT		
	ESD13-WP-TAD-TILT		

NOTE: ^a This column may contain fault trees and basic events. See Attachment B for fault trees and Attachment C for basic events.

Source: Original

A4.14 EVENT TREES FOR CRC-ESD-14

CRC-ESD-14 covers event sequences associated with the transfer of an aging overpack from the Cask Unloading Room to the Cask Preparation Room (Ref. 2.2.33, Figure F-14). This ESD covers both waste forms that are received in aging overpacks at CRCF; DPCs and TAD canisters. Corresponding to each waste form unit is an initiator event tree (Table A4.14-1). Although the initiator event trees transfer to the same response tree, the response tree is customized within SAPHIRE for each initiator event tree by the use of basic rules. The rules instruct SAPHIRE where to look for the fault tree that models each pivotal event. The assignments made in the rules files are indicated in this section.

Table A4.14-1. Summary of Event Trees for CRC-ESD-14

Waste Form Unit	Associated Event Trees	Number of Waste Form Units
Aging overpack containing DPC (outgoing)	Initiator: CRCF-ESD14-DPC Response: RESPONSE-AO1	346
Aging overpack containing TAD canister (outgoing)	Initiator: CRCF-ESD14-TAD Response: RESPONSE-AO1	8,143

Source: Ref. 2.2.31, Table 4

A4.14.1 Initiating Events for CRC-ESD-14

The following initiating events are associated with CRC-ESD-14. The assignments made within SAPHIRE for quantification of these initiating events are indicated in Table A4.14-2.

Impact due to Interaction with the Crane Hook or Rigging. This initiating event accounts for the potential impact to the canister due to an interaction between the crane hook or rigging and the site transporter.

Site Transporter Collision. This initiating event accounts for the potential impact to the canister due to a collision involving the site transporter.

Table A4.14-2. Initiating Event Assignments for CRC-ESD-14

Initiating Event Description	Initiator Event Tree	SAPHIRE Assignment by Basic Rules	SAPHIRE Assignment at Fault Tree Level ^a
Impact due to interaction with crane	CRCF-ESD14-DPC	ESD14-DPC-IMPACT	060-OPIMPACT0000-HFI-NOD
	CRCF-ESD14-TAD	ESD14-TAD-IMPACT	
Site transporter collision	CRCF-ESD14-DPC	ESD14-DPC-COLLIDE	060-14-ST-COLLISION
	CRCF-ESD14-TAD	ESD14-TAD-COLLIDE	

NOTE: ^a This column may contain fault trees and basic events. See Attachment B for fault trees and Attachment C for basic events.

Source: Original

A4.14.2 System Response Event Tree RESPONSE-AO1

The pivotal events that appear in RESPONSE-AO1 are summarized below. The accompanying tables show the association of pivotal event names with basic event or fault tree names.

CANISTER. Table A4.14-3 indicates the fault trees or basic events that are associated with this pivotal event for each initiating event.

Table A4.14-3. Basic Events Associated with the CANISTER Pivotal Events of CRC-ESD-14

Initiator Event Tree	Initiating Event Name	Name Assigned to CANISTER	Associated Fault Tree or Basic Event ^a
CRCF-ESD14-DPC	ESD14-DPC-COLLIDE	ESD14-DPC-COLLIDE-	14-DPC_ST_COLLISION

		CAN	
	ESD14-DPC-IMPACT	ESD14-DPC-IMPACT-CAN	14-DPC_AO_IMPACT
CRCF-ESD14-TAD	ESD14-TAD-COLLIDE	ESD14-TAD-COLLIDE-CAN	14-TAD_ST_COLLISION
	ESD14-TAD-IMPACT	ESD14-TAD-IMPACT-CAN	14-TAD_AO_IMPACT

NOTE: ^a This column may contain fault trees and basic events. See Attachment B for fault trees and Attachment C for basic events.

Source: Original

SHIELDING. Table A4.14-4 indicates the fault trees or basic events that are associated with this pivotal event for each initiating event.

Table A4.14-4. Basic Event Associated with the SHIELDING Pivotal Events of CRC-ESD-14

Initiator Event Tree	Initiating Event Name	Name Assigned to SHIELDING	Associated Fault Tree or Basic Event ^a
CRCF-ESD14-DPC	ESD14-DPC-COLLIDE	ESD14-DPC-COLLIDE-SHIELD	AO_SHIELDING
	ESD14-DPC-IMPACT	ESD14-DPC-IMPACT-SHIELD	
CRCF-ESD14-TAD	ESD14-TAD-COLLIDE	ESD14-TAD-COLLIDE-SHI	
	ESD14-TAD-IMPACT	ESD14-TAD-IMPACT-SHIELD	

NOTE: ^a This column may contain fault trees and basic events. See Attachment B for fault trees and Attachment C for basic events.

Source: Original

CONFINEMENT. Table A4.14-5 indicates the fault trees or basic events that are associated with this pivotal event for each initiating event.

Table A4.14-5. Basic Event Associated with the CONFINEMENT Pivotal Events of CRC-ESD-14

Initiator Event Tree	Initiating Event Name	Name Assigned to CONFINEMENT	Associated Fault Tree or Basic Event ^a
CRCF-ESD14-DPC	ESD14-DPC-COLLIDE	ESD14-CONF ^b	060-DP-LOSS-CRCF
	ESD14-DPC-IMPACT		
CRCF-ESD14-TAD	ESD14-TAD-COLLIDE		
	ESD14-TAD-IMPACT		

NOTE: ^a This column may contain fault trees and basic events. See Attachment B for fault trees and Attachment C for basic events.

^b This passes through a transfer tree named CONFINEMENT.

Source: Original

MODERATOR. The conditional probability of failure (introduction of liquid moderator) is the same for all waste forms and initiating events as shown in Table A4.14-6.

Table A4.14-6. Basic Event Associated with the MODERATOR Pivotal Events of CRC-ESD-14

Initiator Event Tree	Initiating Event Name	Name Assigned to MODERATOR	Associated Fault Tree or Basic Event ^a
----------------------	-----------------------	----------------------------	---

CRCF-ESD14-DPC	ESD14-DPC-COLLIDE	ESD14-MOD	060-MODERATOR-SOURCE
	ESD14-DPC-IMPACT		
CRCF-ESD14-TAD	ESD14-TAD-COLLIDE		
	ESD14-TAD-IMPACT		

NOTE: ^a This column may contain fault trees and basic events. See Attachment B for fault trees and Attachment C for basic events.

Source: Original

A4.15 EVENT TREES FOR CRC-ESD-15

CRC-ESD-15 covers event sequences associated with exporting a waste package from the CRCF (Ref. 2.2.33, Figure F-15). This ESD covers all waste forms that are loaded into waste packages. Corresponding to each waste form unit is an initiator event tree (Table A4.15-1). Although the initiator event trees transfer to the same response tree, the response tree is customized within SAPHIRE for each initiator event tree by the use of basic rules. The rules instruct SAPHIRE where to look for the fault tree that models each pivotal event. The assignments made in the rules files are indicated in this section.

Table A4.15-1. Summary of Event Trees for CRC-ESD-15

Waste Form Unit	Associated Event Trees	Number of Waste Form Units
Waste package containing HLW and DSNF	Initiator: CRCF-ESD15-WP-H&D Response: RESPONSE-WP2	3,300
Waste package containing HLW and MCO	Initiator: CRCF-ESD15-WP-H&M Response: RESPONSE-WP2	225
Waste package containing TAD	Initiator: CRCF-ESD15-WP-TAD Response: RESPONSE-WP2	8,143

Source: Ref. 2.2.31, Table 4

A4.15.1 Initiating Events for CRC-ESD-15

The following initiating events are associated with CRC-ESD-15. The assignments made within SAPHIRE for quantification of these initiating events are indicated in Table A4.15-2.

TEV Collision. This initiating event accounts for the potential impact to the waste package due to a TEV collision with a structure or door.

Object Dropped on Waste Package. This initiating event covers the potential impact to the waste package due to the drop of a heavy object (e.g., empty waste package) by the waste package handling crane.

Waste Package Handling Crane Interference with TEV or WPTT. This initiating event covers the potential impact to the TEV or WPTT from interference by the waste package handling crane.

Exposure due to Malfunction of WPTT or Waste Package Transfer Carriage. This initiating event covers the potential impact to a waste package from a malfunction of the WPTT or waste package transfer carriage.

Table A4.15-2. Initiating Event Assignments for CRC-ESD-15

Initiating Event Description	Initiator Event Tree	SAPHIRE Assignment by Basic Rules	SAPHIRE Assignment at Fault Tree Level ^a
TEV Collision	CRCF-ESD15-WP-H&D	ESD15-WP-H&D-COLLIDE	Screened out (Section 6.1)
	CRCF-ESD15-WP-H&M	ESD15-WP-H&M-COLLIDE	
	CRCF-ESD15-WP-TAD	ESD15-WP-TAD-COLLIDE	
Object Dropped onto WP	CRCF-ESD15-WP-H&D	ESD15-WP-H&D-DROPON	060-15-WP-CRANE-DROPON ^b
	CRCF-ESD15-WP-H&M	ESD15-WP-H&M-DROPON	
	CRCF-ESD15-WP-TAD	ESD15-WP-TAD-DROPON	
WP Crane Interference with TEV or WPTT	CRCF-ESD15-WP-H&D	ESD15-WP-H&D-CRANE	060-15-OP-CRANE-INTER
	CRCF-ESD15-WP-H&M	ESD15-WP-H&M-CRANE	
	CRCF-ESD15-WP-TAD	ESD15-WP-TAD-CRANE	
Exposure due to Malfunction of WPTT or WP Transfer Carriage	CRCF-ESD15-WP-H&D	ESD15-WP-H&D-WPTT	060-15-WP-EXPORT-MALFUNC ^b
	CRCF-ESD15-WP-H&M	ESD15-WP-H&M-WPTT	
	CRCF-ESD15-WP-TAD	ESD15-WP-TAD-WPTT	

NOTE: ^a This column may contain fault trees and basic events. See Attachment B for fault trees and Attachment C for basic events.

^b Fault tree discussed in Attachment B, Section B9.

Source: Original

A4.15.2 System Response Event Tree RESPONSE-WP2

The pivotal events that appear in RESPONSE-WP2 are listed below and summarized in Section A3. The accompanying tables show the association of pivotal event names with basic event or fault tree names.

WP. Table A4.15-3 indicates the fault trees or basic events that are associated with this pivotal event for each initiating event.

Table A4.15-3. Basic Event Associated with the Waste Package Pivotal Events of CRC-ESD-15

Initiator Event Tree	Initiating Event	Name Assigned to WP	Associated Fault Tree or Basic Event ^a
----------------------	------------------	---------------------	---

Table A4.15-3. Basic Event Associated with the Waste Package Pivotal Events of CRC-ESD-15
(Continued)

CRCF-ESD15-WP-H&D	ESD15-WP-H&D-COLLIDE	ESD15-WP-H&D-COLLIDE-WP	15-WP_FAILURE_COLL
	ESD15-WP-H&D-CRANE	ESD15-WP-H&D-CRANE-WP	15-WP_FAIL_CRANE_IMPACT
	ESD15-WP-H&D-DROPON	ESD15-WP-H&D-DROPON-WP	15-WP_FAIL_DROPON
	ESD15-WP-H&D-WPTT	ESD15-WP-H&D-WPTT-WP	15-WP_FAIL_IMPACT
CRCF-ESD15-WP-H&M	ESD15-WP-H&M-COLLIDE	ESD15-WP-H&M-COLLIDE-WP	15-WP_FAILURE_COLL
	ESD15-WP-H&M-CRANE	ESD15-WP-H&M-CRANE-WP	15-WP_FAIL_CRANE_IMPACT
	ESD15-WP-H&M-DROPON	ESD15-WP-H&M-DROPON-WP	15-WP_FAIL_DROPON
	ESD15-WP-H&M-WPTT	ESD15-WP-H&M-WPTT-WP	15-WP_FAIL_IMPACT
CRCF-ESD15-WP-TAD	ESD15-WP-TAD-COLLIDE	ESD15-WP-TAD-COLLIDE-WP	15-WP_FAILURE_COLL
	ESD15-WP-TAD-CRANE	ESD15-WP-TAD-CRANE-WP	15-WP_FAIL_CRANE_IMPACT
	ESD15-WP-TAD-DROPON	ESD15-WP-TAD-DROPON-WP	15-WP_FAIL_DROPON
	ESD15-WP-TAD-WPTT	ESD15-WP-TAD-WPTT-WP	15-WP_FAIL_IMPACT

NOTE: ^a This column may contain fault trees and basic events. See Attachment B for fault trees and Attachment C for basic events.

Source: Original

CANISTER. Table A4.15-4 indicates the fault trees or basic events that are associated with this pivotal event for each initiating event.

Table A4.15-4. Basic Events Associated with the CANISTER Pivotal Events of CRC-ESD-15

Initiator Event Tree	Initiating Event	Name Assigned to CANISTER	Associated Fault Tree or Basic Event ^a
CRCF-ESD15-WP-H&D	ESD15-WP-H&D-COLLIDE	ESD15-WP-H&D-COLLIDE-CAN	15-H&D-FAIL-IN-WP
	ESD15-WP-H&D-CRANE	ESD15-WP-H&D-CRANE-CAN	15-H&D-FAIL-IN-WP
	ESD15-WP-H&D-DROPON	ESD15-WP-H&D-DROPON-CAN	15-H&D-FAIL-IN-WP-DRPON
	ESD15-WP-H&D-WPTT	ESD15-WP-H&D-WPTT-CAN	15-H&D-FAIL-IN-WP
CRCF-ESD15-WP-H&M	ESD15-WP-H&M-COLLIDE	ESD15-WP-H&M-COLLIDE-CAN	15-H&M-FAIL-IN-WP
	ESD15-WP-H&M-CRANE	ESD15-WP-H&M-CRANE-CAN	15-H&M-FAIL-IN-WP
	ESD15-WP-H&M-DROPON	ESD15-WP-H&M-DROPON-CAN	15-H&M-FAIL-IN-WP-DRPON
	ESD15-WP-H&M-WPTT	ESD15-WP-H&M-WPTT-CAN	15-H&M-FAIL-IN-WP
CRCF-ESD15-WP-TAD	ESD15-WP-TAD-COLLIDE	ESD15-WP-TAD-COLLIDE-CA	15-TAD-FAIL-IN-WP
	ESD15-WP-TAD-CRANE	ESD15-WP-TAD-CRANE-CAN	15-TAD-FAIL-IN-WP
	ESD15-WP-TAD-	ESD15-WP-TAD-DROPON-	15-TAD-FAIL-IN-WP-DRPON

Table A4.15-4. Basic Events Associated with the CANISTER Pivotal Events of CRC-ESD-15 (Continued)

Initiator Event Tree	Initiating Event	Name Assigned to CANISTER	Associated Fault Tree or Basic Event ^a
		DROPON	CAN
	ESD15-WP-TAD-WPTT	ESD15-WP-TAD-WPTT	15-TAD-FAIL-IN-WP

NOTE: ^a This column may contain fault trees and basic events. See Attachment B for fault trees and Attachment C for basic events.

Source: Original

SHIELDING. This pivotal event represents the success or failure of the Waste Package Loadout Room shield door. The waste package shielding components (i.e., waste package lid, shield ring, and WPTT shielded enclosure) do not provide shielding during the loadout activity. Failure of shielding in this instance refers to an unspecified degree of shielding degradation due to the impact. Table A4.15-5 indicates the fault trees or basic events that are associated with this pivotal event for each initiating event.

Table A4.15-5. Basic Events Associated with the SHIELDING Pivotal Events of CRC-ESD-15

Initiator Event Tree	Initiating Event	Name Assigned to SHIELDING	Associated Fault Tree or Basic Event ^a
CRCF-ESD15-WP-H&D	ESD15-WP-H&D-COLLIDE	ESD15-WP-H&D-COLLIDE-SHI	Shielding failure set to zero As WP provides no shielding during loadout
	ESD15-WP-H&D-CRANE	ESD15-WP-H&D-CRANE-SHIEL	
	ESD15-WP-H&D-DROPON	ESD15-WP-H&D-DROPON-SHIE	
	ESD15-WP-H&D-WPTT	ESD15-WP-H&D-WPTT-SHIELD	
CRCF-ESD15-WP-H&M	ESD15-WP-H&M-COLLIDE	ESD15-WP-H&M-COLLIDE-SHI	
	ESD15-WP-H&M-CRANE	ESD15-WP-H&M-CRANE-SHIEL	
	ESD15-WP-H&M-DROPON	ESD15-WP-H&M-DROPON-SHIE	
	ESD15-WP-H&M-WPTT	ESD15-WP-H&M-WPTT-SHIELD	
CRCF-ESD15-WP-TAD	ESD15-WP-TAD-COLLIDE	ESD15-WP-TAD-COLLIDE-SHIELD	
	ESD15-WP-TAD-CRANE	ESD15-WP-TAD-CRANE-SHIELD	
	ESD15-WP-TAD-DROPON	ESD15-WP-TAD-DROPON-SHIELD	
	ESD15-WP-TAD-WPTT	ESD15-WP-TAD-WPTT	

NOTE: ^a This column may contain fault trees and basic events. See Attachment B for fault trees and Attachment C for basic events.

Source: Original

CONFINEMENT. Table A4.15-6 indicates the fault trees or basic events that are associated with this pivotal event for each initiating event.

Table A4.15-6. Basic Event Associated with the CONFINEMENT Pivotal Events of CRC-ESD-15

Initiator Event Tree	Initiating Event	Name Assigned to CONFINEMENT	Associated Fault Tree or Basic Event ^a
----------------------	------------------	------------------------------	---

Table A4.15-6. Basic Event Associated with the CONFINEMENT Pivotal Events of CRC-ESD-15
(Continued)

Initiator Event Tree	Initiating Event	Name Assigned to CONFINEMENT	Associated Fault Tree or Basic Event ^a
CRCF-ESD15-WP-H&D	ESD15-WP-H&D-COLLIDE	ESD15-CONF ^b	060-DP-LOSS-CRCF
	ESD15-WP-H&D-CRANE		
	ESD15-WP-H&D-DROPON		
	ESD15-WP-H&D-WPTT		
CRCF-ESD15-WP-H&M	ESD15-WP-H&M-COLLIDE		
	ESD15-WP-H&M-CRANE		
	ESD15-WP-H&M-DROPON		
	ESD15-WP-H&M-WPTT		
CRCF-ESD15-WP-TAD	ESD15-WP-TAD-COLLIDE		
	ESD15-WP-TAD-CRANE		
	ESD15-WP-TAD-DROPON		
	ESD15-WP-TAD-WPTT		

NOTE: ^a This column may contain fault trees and basic events. See Attachment B for fault trees and Attachment C for basic events.

^b This passes through a transfer tree named CONFINEMENT.

Source: Original

MODERATOR. The conditional probability of failure (introduction of liquid moderator) is the same for all waste forms and initiating events as shown in Table A4.15-7.

Table A4.15-7. Basic Event Associated with the MODERATOR Pivotal Events of CRC-ESD-15

Initiator Event Tree	Initiating Event	Name Assigned to MODERATOR	Associated Fault Tree or Basic Event ^a
CRCF-ESD15-WP-H&D	ESD15-WP-H&D-COLLIDE	ESD15-MOD	060-MODERATOR-SOURCE
	ESD15-WP-H&D-CRANE		
	ESD15-WP-H&D-DROPON		
	ESD15-WP-H&D-WPTT		
CRCF-ESD15-WP-H&M	ESD15-WP-H&M-COLLIDE		
	ESD15-WP-H&M-CRANE		
	ESD15-WP-H&M-DROPON		
	ESD15-WP-H&M-WPTT		

Table A4.15-7. Basic Event Associated with the MODERATOR Pivotal Events of CRC-ESD-15
(Continued)

Initiator Event Tree	Initiating Event	Name Assigned to MODERATOR	Associated Fault Tree or Basic Event ^a
CRCF-ESD15-WP-TAD	ESD15-WP-TAD-COLLIDE		
	ESD15-WP-TAD-CRANE		
	ESD15-WP-TAD-DROPON		
	ESD15-WP-TAD-WPTT		

NOTE: ^a This column may contain fault trees and basic events. See Attachment B for fault trees and Attachment C for basic events.

Source: Original

A4.16 EVENT TREES FOR CRC-ESD-16

CRC-ESD-16 covers event sequences associated with the export of an aging overpack from the CRCF (Ref. 2.2.33, Figure F-16). This ESD covers aging overpacks. Corresponding to each waste form unit within an aging overpack at the CRCF is an initiator event tree (Table A4.16-1). Although the initiator event trees transfer to the same response tree, the response tree is customized within SAPHIRE for each initiator event tree by the use of basic rules. The rules instruct SAPHIRE where to look for the fault tree that models each pivotal event. The assignments made in the rules files are indicated in this section.

Table A4.16-1. Summary of Event Trees for CRC-ESD-16

Waste Form Unit	Associated Event Trees	Number of Waste Form Units
Aging overpack containing DPC	Initiator: CRCF-ESD16-DPC Response: RESPONSE-AO1	346
Aging overpack containing TAD canister	Initiator: CRCF-ESD16-TAD Response: RESPONSE-AO1	6,978

Source: Ref. 2.2.31, Table 4

A4.16.1 Initiator Events for CRC-ESD-16

The following initiating events are associated with CRC-ESD-16. The assignments made within SAPHIRE for quantification of these initiating events are indicated in Table A4.16-2.

Aging Overpack Dropped. This initiating event accounts for the potential impact to aging overpack due to a malfunction of the site transporter. For a site transporter to roll over, the center of mass would have to shift laterally. This could result from traversing a significantly uneven surface or running over a very large object.

Site Transporter Collision. This initiating event accounts for the potential impact to the TAD canister due to a collision involving the site transporter. The probability of collision per TAD canister received is modeled as a fault tree as described in Attachment D. The initiating event is specified as a probability of collision per DPC or TAD canister.

Table A4.16-2. Initiating Event Assignments for CRC-ESD-16

Initiating Event Description	Initiator Event Tree	SAPHIRE Assignment by Basic Rules	SAPHIRE Assignment at Fault Tree Level ^a
Aging overpack dropped	CRCF-ESD16-DPC	ESD16-DPC-DROP	060-2-ST-ROLLOVER OR 060-16-ST-AO-DROP ^b
	CRCF-ESD16-TAD	ESD16-TAD-DROP	060-2-ST-ROLLOVER OR 060-16-ST-AO-DROP ^b
Site transporter collision	CRCF-ESD16-DPC	ESD16-DPC-COLLIDE	060-16-ST-COLLISION
	CRCF-ESD16-TAD	ESD16-TAD-COLLIDE	060-16-ST-COLLISION

NOTE: ^a This column may contain fault trees and basic events. See Attachment B for fault trees and Attachment C for basic events.
^b Fault trees connected by an OR gate.

Source: Original

A4.16.2 System Response Event Tree RESPONSE-AO1

The pivotal events that appear in RESPONSE-AO1 are listed below and summarized in Section A3. The accompanying tables show the association of pivotal event names with basic event or fault tree names.

CANISTER. Table A4.16-3 indicates the fault trees or basic events that are associated with this pivotal event for each initiating event.

Table A4.16-3. Basic Events Associated with the CANISTER Pivotal Events of CRC-ESD-16

Initiator Event Tree	Initiating Event Name	Name Assigned to CANISTER	Associated Fault Tree or Basic Event ^a
CRCF-ESD16-DPC	ESD16-DPC-DROP	ESD16-DPC-DROP-CAN	16-DPC-STAO_ROLL_DROP
	ESD16-DPC-COLLIDE	ESD16-DPC-COLLIDE-CAN	16-DPC_ST_COLLISION
CRCF-ESD16-TAD	ESD16-TAD-DROP	ESD16-TAD-DROP-CAN	16-TAD-STAO_ROLL_DROP
	ESD16-TAD-COLLIDE	ESD16-TAD-COLLIDE-CAN	16-TAD_ST_COLLISION

NOTE: ^a This column may contain fault trees and basic events. See Attachment B for fault trees and Attachment C for basic events.

Source: Original

SHIELDING. Table A4.16-4 indicates the fault trees or basic events that are associated with this pivotal event for each initiating event.

Table A4.16-4. Basic Event Associated with the SHIELDING Pivotal Events of CRC-ESD-016

Initiator Event Tree	Initiating Event Name	Name Assigned to SHIELDING	Associated Fault Tree or Basic Event ^a
CRCF-ESD16-DPC	ESD16-DPC-DROP	ESD16-DPC-DROP-SHIELD	AO-SHIELDING
	ESD16-DPC-COLLIDE	ESD16-DPC-COLLIDE-SHIELD	
CRCF-ESD16-TAD	ESD16-TAD-DROP	ESD16-TAD-DROP-SHIELD	
	ESD16-TAD-COLLIDE	ESD16-TAD-COLLIDE-SHI	

NOTE: ^a This column may contain fault trees and basic events. See Attachment B for fault trees and Attachment C for basic events.

Source: Original

CONFINEMENT. Table A4.16-5 indicates the fault trees or basic events that are associated with this pivotal event for each initiating event.

Table A4.16-5. Basic Event Associated with the CONFINEMENT Pivotal Events of CRC-ESD-16

Initiator Event Tree	Initiating Event Name	Name Assigned to CONFINEMENT	Associated Fault Tree or Basic Event ^a
CRCF-ESD16-DPC	ESD16-DPC-DROP	ESD16-CONF ^b	060-DP-LOSS-CRCF
	ESD16-DPC-COLLIDE		
CRCF-ESD16-TAD	ESD16-TAD-DROP		
	ESD16-TAD-COLLIDE		

NOTE: ^a This column may contain fault trees and basic events. See Attachment B for fault trees and Attachment C for basic events.

^b This passes through a transfer tree named CONFINEMENT.

Source: Original

MODERATOR. The conditional probability of failure (introduction of liquid moderator) is the same for all waste forms and initiating events as shown in Table A4.16-6.

Table A4.16-6. Basic Event Associated with the MODERATOR Pivotal Events of CRC-ESD-016

Initiator Event Tree	Initiating Event Name	Name Assigned to MODERATOR	Associated Fault Tree or Basic Event ^a
CRCF-ESD16-DPC	ESD16-DPC-DROP	ESD16-MOD	060-MODERATOR-SOURCE
	ESD16-DPC-COLLIDE		
CRCF-ESD16-TAD	ESD16-TAD-DROP		
	ESD16-TAD-COLLIDE		

NOTE: ^a This column may contain fault trees and basic events. See Attachment B for fault trees and Attachment C for basic events.

Source: Original

A4.17 EVENT TREES FOR CRC-ESD-17

CRC-ESD-17 covers event sequences associated with direct exposure during cask preparation activities (Ref. 2.2.33, Figure F-17). This ESD covers all waste forms. Corresponding to each waste form unit is an initiator event tree (Table A4.17-1). Although the initiator event trees transfer to the same response tree, the response tree is customized within SAPHIRE for each initiator event tree by the use of basic rules. The rules instruct SAPHIRE where to look for the fault tree that models each pivotal event. The assignments made in the rules files are indicated in this section.

Table A4.17-1. Summary of Event Trees for CRC-ESD-17

Waste Form Unit	Associated Event Trees	Number of Waste Form Units
Transportation cask containing a DPC	CRCF-ESD17-DPC	346
Transportation cask containing DOE Standardized SNF canisters	CRCF-ESD17-DSTD	385
Rail-based Transportation cask containing HLW canisters	CRCF-ESD17-HLW	1,960
Transportation cask containing MCOs	CRCF-ESD17-MCO	113
Transportation cask or aging overpack containing a TAD canister	CRCF-ESD17-TAD	15,121

Source: Ref. 2.2.31, Table 4

A4.17.1 Initiating Events for CRCF-ESD-17

The following initiating events are associated with CRC-ESD-17. The assignments made within SAPHIRE for quantification of these initiating events are indicated in Table A4.17-2.

Temporary Shielding Loss During Cask Preparation Activities. This initiating event accounts for the loss of shielding during cask preparation activities. Loss of shielding could occur due to the failure to close the cask preparation platform shield plate or the inadvertent opening of the cask preparation platform shield plate. Table A4.17-2 shows the fault tree assignment for this initiating event.

Table A4.17-2. Initiating Event Assignments for CRC-ESD-17

Initiating Event Description	Initiator Event Tree	SAPHIRE Assignment by Basic Rules	SAPHIRE Assignment at Fault Tree Level ^a
Temporary loss of shielding during preparation activities	CRCF-ESD17-DPC	ESD17-SHIELD-LOSS-DPC	060-OPDPCSHIELD1-HFI-NOW OR 060-LIDDISPLACE1-HFI-NOD ^b Lid displacement screened (See Section 6.1)
	CRCF-ESD17-DSTD	ESD17-SHIELD-LOSS	060-LIDDISPLACE1-HFI-NOD Lid displacement screened (See Section 6.1)

Table A4.17-2. Initiating Event Assignments for CRC-ESD-17 (Continued)

Initiating Event Description	Initiator Event Tree	SAPHIRE Assignment by Basic Rules	SAPHIRE Assignment at Fault Tree Level ^a
	CRCF-ESD17-HLW	ESD17-SHIELD-LOSS	060-LIDDISPLACE1-HFI-NOD Lid displacement screened (See Section 6.1)
	CRCF-ESD17-MCO	ESD17-SHIELD-LOSS	060-LIDDISPLACE1-HFI-NOD Lid displacement screened (See Section 6.1)
	CRCF-ESD17-TAD	ESD17-SHIELD-LOSS	060-LIDDISPLACE1-HFI-NOD Lid displacement screened (See Section 6.1)

NOTE: ^a This column may contain fault trees and basic events. See Attachment B for fault trees and Attachment C for basic events.

^b Fault tree begins at basic-rules level.

Source: Original

There are no pivotal events associated with CRC-ESD-17.

A4.18 EVENT TREES FOR CRC-ESD-18

CRC-ESD-18 covers event sequences associated with direct exposure during cask preparation activities (Ref. 2.2.33, Figure F-18). This ESD covers all waste forms. Corresponding to each waste form unit is an initiator event tree (Table A4.18-1). Although the initiator event trees transfer to the same response tree, the response tree is customized within SAPHIRE for each initiator event tree by the use of basic rules. The rules instruct SAPHIRE where to look for the fault tree that models each pivotal event. The assignments made in the rules files are indicated in this section.

Table A4.18-1. Summary of Event Trees for CRC-ESD-18

Waste Form Unit	Associated Event Trees	Number of Waste Form Units
DPC	CRCF-ESD18-DPC	346 ^a
DOE standardized SNF canister	CRCF-ESD18-DSTD	3,300 ^a
HLW canister	CRCF-ESD18-HLW	9,801 ^b
MCO	CRCF-ESD18-MCO	451 ^a
TAD canister	CRCF-ESD18-TAD	6,978 ^a

Source: ^{a,b} Ref. 2.2.31, ^aTable 4, ^bTable 3

A4.18.1 Initiator Event Trees for CRCF-ESD-18

The following initiating events are associated with CRC-ESD-18. The assignments made within SAPHIRE for quantification of these initiating events are indicated in Table A4.18-2.

Temporary Shielding Loss During CTM Activities. This initiating event accounts for the loss of shielding during cask preparation activities. Loss of shielding could occur due to the failure of the shield bell or the inadvertent opening of a slide gate or shield skirt.

Table A4.18-2 shows the fault tree assignment for this initiating event.

Table A4.18-2. Initiating Event Assignments for CRC-ESD-18

Initiating Event Description	Initiator Event Tree	SAPHIRE Assignment by Basic Rules	SAPHIRE Assignment at Fault Tree Level ^a
Temporary loss of shielding during CTM activities	CRCF-ESD17-DPC	ESD18-TEMP-SHIELD-LOSS	ESD18-TEMP-SHIELD-LOSS
	CRCF-ESD17-DSTD		
	CRCF-ESD17-HLW		
	CRCF-ESD17-MCO		
	CRCF-ESD17-TAD		

NOTE: ^a This column may contain fault trees and basic events. See Attachment B for fault trees and Attachment C for basic events.

Source: Original

There are no pivotal events associated with CRC-ESD-18.

A4.19 EVENT TREES FOR CRC-ESD-19

CRC-ESD-19 covers event sequences associated with direct exposure during waste package closing and export activities (Ref. 2.2.33, Figure F-19). This ESD covers all waste forms. Corresponding to each waste form unit is an initiator event tree (Table A4.19-1). Although the initiator event trees transfer to the same response tree, the response tree is customized within SAPHIRE for each initiator event tree by the use of basic rules. The rules instruct SAPHIRE where to look for the fault tree that models each pivotal event. The assignments made in the rules files are indicated in this section.

Table A4.19-1. Summary of Event Trees for CRC-ESD-19

Waste Form Unit	Associated Event Trees	Number of Waste Form Units
Waste package containing HLW canisters and DOE Std Canister	CRCF-ESD19-WP-H&D	3,300
Waste package containing HLW canisters and MCO	CRCF-ESD19-WP-H&M	225
Waste package containing a TAD canister	CRCF-ESD19-WP-TAD	8,143

Source: Ref. 2.2.31, Table 4

A4.19.1 Initiator Event Trees for CRCF-ESD-19

The following initiating events are associated with CRC-ESD-19. The assignments made within SAPHIRE for quantification of these initiating events are indicated in Table A4.19-2.

Temporary Shielding Loss During Waste Package Closure and Export Activities. This initiating event accounts for the loss of shielding during waste package closure and export activities. Loss of shielding could occur due to improper installation of the waste package or due to inadvertent opening of the shield door during the loadout activity.

Table A4.19-2 shows the fault tree assignment for this initiating event.

Table A4.19-2. Initiating Event Assignments for CRC-ESD-19

Initiating Event Description	Initiator Event Tree	SAPHIRE Assignment by Basic Rules	SAPHIRE Assignment at Fault Tree Level ^a
Temporary loss of shielding during waste package closure activities	CRCF-ESD19-WP-H&D	ESD19-SHIELD-RING	ESD19-SHIELD-RING ^b
	CRCF-ESD19-WP-H&M		
	CRCF-ESD19-WP-TAD		
Temporary loss of shielding during waste package export activities	CRCF-ESD19-WP-H&D	ESD19-FACILITY-DR	060-OPDIREXPOSE3-HFI-NOD
	CRCF-ESD19-WP-H&M		
	CRCF-ESD19-WP-TAD		

NOTE: ^a This column may contain fault trees and basic events. See Attachment B for fault trees and Attachment C for basic events.

^b Fault trees described in Attachment B, Section B9.

Source: Original

There are no pivotal events associated with CRC-ESD-19.

A4.20 EVENT TREES FOR CRC-ESD-20

CRC-ESD-20 covers event sequences associated with fires in the CRCF (Ref. 2.2.33, Figure F-20). This ESD covers all waste forms (Table A4.20-1). Although the initiator event trees transfer to the same response tree, the response tree is customized within SAPHIRE for each initiator event tree by the use of basic rules. The rules instruct SAPHIRE where to look for the fault tree that models each pivotal event. The assignments made in the rules files are indicated in this section.

Table A4.20-1. Summary of Event Trees for CRC-ESD-20

Waste Form Unit	Associated Event Trees	Number of Waste Form Units
Transportation cask containing a DPC	Initiator: CRCF-ESD20-DPC Response: RESPONSE-FIRE	346
Transportation cask containing DOE standardized SNF canisters	Initiator: CRCF-ESD20-DSTD Response: RESPONSE-FIRE	385
Rail-based Transportation cask containing HLW canisters	Initiator: CRCF-ESD20-HLW Response: RESPONSE-FIRE	1,960
Transportation cask containing MCOs	Initiator: CRCF-ESD20-MCO Response: RESPONSE-FIRE	113
Transportation cask or waste package containing a TAD canister	Initiator: CRCF-ESD20-TAD Response: RESPONSE-FIRE	15,121
Waste package containing HLW canisters and a DOE standardized SNF canister	Initiator: CRCF-ESD20-WP-H&D Response: RESPONSE-FIRE	3,300
Waste package containing HLW canisters and MCOs	Initiator: CRCF-ESD20-WP-H&M Response: RESPONSE-FIRE	225

Source: Ref. 2.2.31, Table 4

A4.20.1 Initiating Events for CRC-ESD-20

The following initiating events are associated with CRC-ESD-20. The assignments made within SAPHIRE for quantification of these initiating events are indicated in Table A4.20-2.

Localized fire in Waste Package Loadout Room. This initiating event accounts for the potential impact from a fire in the Waste Package Loadout Room.

Localized fire in Cask Unloading Room. This initiating event accounts for the potential impact from a fire in the Cask Unloading Room.

Localized fire in Waste Package Positioning Room. This initiating event accounts for the potential impact from a fire in the Waste Package Positioning Room.

Localized fire in Cask Preparation Room. This initiating event accounts for the potential impact from a fire in the Cask Preparation Room.

Localized fire in Canister Transfer Room. This initiating event accounts for the potential impact from a fire in the Cask Transfer Room.

Large fire in CRCF. This initiating event accounts for the potential impact from a large fire in the CRCF.

Table A4.20-2. Initiating Event Assignments for CRC-ESD-20

Initiating Event Description	Initiator Event Tree	SAPHIRE Assignment by Basic Rules	SAPHIRE Assignment at Fault Tree Level ^a
Localized fire in Waste Package Loadout Room	CRCF-ESD20-DPC	N/A	N/A
	CRCF-ESD20-DSTD		
	CRCF-ESD20-HLW		
	CRCF-ESD20-MCO		
	CRCF-ESD20-TAD	ESD20-TAD-WP-LOR-FIRE	060-TAD-WP-LOADOUT-RM
	CRCF-ESD20-WP-H&D	ESD20-WP-H&D-LOR-FIRE	060-H&D-WP-LDOUT-RM
	CRCF-ESD20-WP-H&M	ESD20-WP-H&M-LOR-FIRE	060-H&M-WP-LDOUT-RM
Localized fire in Cask Unloading Room	CRCF-ESD20-DPC	ESD20-DPC-CSK-CUR-FIRE	060-DPC-CASK-UNLOAD-FIRE
	CRCF-ESD20-DSTD	ESD20-DSNF-CSK-CUR-FIRE	060-DSNF-CASK-CUR-FIRE
	CRCF-ESD20-HLW	ESD20-HLW-CSK-CUR-FIRE	060-HLW-CSK-UNLOAD-RM
	CRCF-ESD20-MCO	ESD20-MCO-CSK-CUR-FIRE	060-MCO-CASK-CUR-FIRE
	CRCF-ESD20-TAD	ESD20-TAD-CSK-CUR-FIRE	060-TADAO-CUR-DIESEL
	CRCF-ESD20-WP-H&D	N/A	N/A
	CRCF-ESD20-WP-H&M	N/A	N/A
Localized fire in Waste Package Positioning Room	CRCF-ESD20-DPC	N/A	N/A
	CRCF-ESD20-DSTD		
	CRCF-ESD20-HLW	ESD20-HLW-WP-PR-FIRE	060-FIRE-IN-POSITION-RM
	CRCF-ESD20-MCO	N/A	N/A
	CRCF-ESD20-TAD	ESD20-TAD-WP-PR-FIRE	060-TAD-WP-POSIT-RM-FIRE
	CRCF-ESD20-WP-H&D	ESD20-WP-H&D-PR-FIRE	060-H&D-WP-POSIT-RM-FIRE
	CRCF-ESD20-WP-H&M	ESD20-WP-H&M-PR-FIRE	060-H&M-WP-POSIT-RM-FIRE
Localized fire in Cask Preparation Room	CRCF-ESD20-DPC	ESD20-DPC-CSK-CPA-FIRE	060-DPC-CASK-PREP-FIRE
	CRCF-ESD20-DSTD	ESD20-DSNF-CSK-CPA-FIRE	060-DSNF-CSK-CPA-FIRE
	CRCF-ESD20-HLW	ESD20-HLW-CSK-CPA-FIRE	060-HLW-FIRE-PREPAREA
	CRCF-ESD20-MCO	ESD20-MCO-CSK-CPA-FIRE	060-MCO-CSK-CPA-FIRE
	CRCF-ESD20-TAD	ESD20-TAD-CSK-CPA-FIRE	060-TAD-FIRE-PREP-AREA
	CRCF-ESD20-WP-H&D	N/A	N/A
	CRCF-ESD20-WP-H&M		
Localized fire in Canister Transfer Room	CRCF-ESD20-DPC	ESD20-DPC-CAN-CTM-FIRE	060-DPC-CTM-FIRE
	CRCF-ESD20-DSTD	ESD20-DSNF-CAN-CTM-FIRE	060-DSNF-CAN-CTM-FIRE
	CRCF-ESD20-HLW	ESD20-HLW-CAN-CTM-FIRE	060-HLW-CAN-CTM-FIRE
	CRCF-ESD20-MCO	ESD20-MCO-CAN-CTM-FIRE	060-MCO-CAN-CTM-FIRE
	CRCF-ESD20-TAD	ESD20-TAD-CAN-CTM-FIRE	060-TAD-CAN-CTM-FIRE
	CRCF-ESD20-WP-H&D	N/A	N/A
	CRCF-ESD20-WP-H&M		

Table A4.20-2. Initiating Event Assignments for CRC-ESD-20 (Continued)

Initiating Event Description	Initiator Event Tree	SAPHIRE Assignment by Basic Rules	SAPHIRE Assignment at Fault Tree Level ^a
Large fire in CRCF	CRCF-ESD20-DPC	ESD20-DPC-LG-FIRE	060-DPC-LARGE-FIRE
	CRCF-ESD20-DSTD	ESD20-DSNF-LG-FIRE	060-DSNF-LARGE-FIRE
	CRCF-ESD20-HLW	ESD20-HLW-LG-FIRE	060-HLW-LARGE-FIRE
	CRCF-ESD20-MCO	ESD20-MCO-LG-FIRE	060-MCO-LARGE-FIRE
	CRCF-ESD20-TAD	ESD20-TAD-LG-FIRE	060-TAD-LARGE-FIRE
	CRCF-ESD20-WP-H&D	ESD20-H&D-LG-FIRE	060-H&D-LARGE-FIRE
	CRCF-ESD20-WP-H&M	ESD20-H&M-LG-FIRE	060-H&M-LARGE-FIRE

NOTE: ^a This column may contain fault trees and basic events. See Attachment B for fault trees and Attachment C for basic events.

Source: Original

A4.20.2 System Response Event Tree RESPONSE-FIRE

The pivotal events that appear in RESPONSE-FIRE are listed below and summarized in Section A3. The accompanying tables show the association of pivotal event names with basic event or fault tree names.

CANISTER. Table A4.20-3 indicates the fault trees or basic events that are associated with this pivotal event for each initiating event.

Table A4.20-3. Basic Events Associated with the CANISTER Pivotal Events of CRC-ESD-20

Initiator Event Tree	Initiating Event Name	Name Assigned to CANISTER	Associated Fault Tree or Basic Event ^{a,b}
CRCF-ESD20-DPC	ESD20-DPC-CSK-CUR-FIRE	ESD20-DPC-CUR-FIRE-CAN	060-DPC-TC-CUR-DIESEL OR 060-DPC-AO-CUR-DIESEL
	ESD20-DPC-CSK-CPA-FIRE	ESD20-DPC-CPA-FIRE-CAN	060-DPC-AO-PREP-DIESEL OR 060-DPC-TC-PREP-DIESEL OR 060-DPC-TC-PREP-NODIESEL
	ESD20-DPC-CAN-CTM-FIRE	ESD20-DPC-CTM-FIRE-CAN	060-DPC-CTM-CAN-FAIL
	ESD20-DPC-LG-FIRE	ESD20-DPC-LG-FIRE-CAN	060-DPC-AO-DIESEL OR 060-DPC-TC-FAIL-WDIESEL OR 060-DPC-TC-FAIL-WODIESEL
CRCF-ESD20-DSTD	ESD20-DSNF-CSK-CUR-FIRE	ESD20-DSNF-CUR-FIRE-CAN	060-DSNF-CUR-CAN-FAIL
	ESD20-DSNF-CSK-CPA-FIRE	ESD20-DSNF-CPA-FIRE-CAN	060-DNSF-SPLIT-WDIESEL OR 060-DNSF-SPLIT-WODIESEL
	ESD20-DSNF-CAN-CTM-FIRE	ESD20-DSNF-CTM-FIRE-CAN	060-DSNF-CTM-CAN-FAIL

Table A4.20-3. Basic Events Associated with the CANISTER Pivotal Events of CRC-ESD-20 (Continued)

Initiator Event Tree	Initiating Event Name	Name Assigned to CANISTER	Associated Fault Tree or Basic Event^{a,b}
	ESD20-DSNF-LG-FIRE	ESD20-DSNF-LG-FIRE-CAN	060-DSTD-STAGE-AREA, OR 060-DSTD-TC-DIESEL OR 060-DSTD-TC-NO-DIESEL OR 060-DSTD-CTM
CRCF-ESD20-HLW	ESD20-HLW-CSK-CUR-FIRE	ESD20-HLW-CUR-FIRE-CAN	060-HLW-CASK-FAIL
	ESD20-HLW-CSK-CPA-FIRE	ESD20-HLW-CPA-FIRE-CAN	060-HLW-SPLIT-WDIESEL OR 060-HLW-SPLIT-WODIESEL
	ESD20-HLW-CAN-CTM-FIRE	ESD20-HLW-CTM-FIRE-CAN	060-HLW-WP-CANISTER-FAIL
	ESD20-HLW-WP-PR-FIRE	ESD20-HLW-PR-FIRE-CAN	060-HLW-IN-WP-FAIL-IN-PR
	ESD20-HLW-LG-FIRE	ESD20-HLW-LG-FIRE-CAN	060-HLW-TC-CAN-FAIL-WD OR 060-HLW-TC-CAN-FAIL-WOD OR 060-HLW-WP-CAN-FAIL OR 060-HLW-CTM-CAN-FAIL
CRCF-ESD20-MCO	ESD20-MCO-CSK-CUR-FIRE	ESD20-MCO-CUR-FIRE-CAN	060-MCO-CUR-CAN-FAIL
	ESD20-MCO-CSK-CPA-FIRE	ESD20-MCO-CPA-FIRE-CAN	060-MCO-SPLIT-WDIESEL OR 060-MCO-SPLIT-WODIESEL
	ESD20-MCO-CAN-CTM-FIRE	ESD20-MCO-CTM-FIRE-CAN	060-MCO-CTM-CAN-FAIL
	ESD20-MCO-LG-FIRE	ESD20-MCO-LG-FIRE-CAN	060-MCO-CTM OR 060-MCO-TC-DIESEL OR 060-MCO-TC-NO-DIESEL
CRCF-ESD20-TAD	ESD20-TAD-WP-LOR-FIRE	ESD20-TAD-LOR-FIRE-CAN	060-TAD-WP-CAN-FAIL-LOR
	ESD20-TAD-CSK-CUR-FIRE	ESD20-TAD-CUR-FIRE-CAN	060-TAD-IN-TC-NODIES OR 060-TAD-IN-AO-DIES
	ESD20-TAD-WP-PR-FIRE	ESD20-TAD-PR-FIRE-CAN	060-TAD-WP-CAN-FAIL-PR
	ESD20-TAD-CSK-CPA-FIRE	ESD20-TAD-CPA-FIRE-CAN	060-20-TAD-TC-CAN-FAIL OR 060-TAD-AO-CAN-FAIL-PREP
	ESD20-TAD-CAN-CTM-FIRE	ESD20-TAD-CTM-FIRE-CAN	060-TAD-CTM-CAN-FAIL
	ESD20-TAD-LG-FIRE	ESD20-TAD-LG-FIRE-CAN	060-TAD-TC-LGF-DIESEL OR 060-TAD-TC-LGF-WODIESEL OR 060-TAD-AO-DIES-LGF OR 060-TAD-LGF-CTM OR

Table A4.20-3. Basic Events Associated with the CANISTER Pivotal Events of CRC-ESD-20 (Continued)

Initiator Event Tree	Initiating Event Name	Name Assigned to CANISTER	Associated Fault Tree or Basic Event ^{a,b}
CRCF-ESD20-WP-H&D	ESD20-H&D-WP-LOR-FIRE	ESD20-WP-H&D-LOR-FIRE-CA	060-H&D-WP-CAN-FAIL-LOR
	ESD20-H&D-WP-PR-FIRE	ESD20-WP-H&D-PR-FIRE-CAN	060-H&D-WP-CAN-FAIL-PR
	ESD20-H&D-LG-FIRE	ESD20-WP-H&D-LG-FIRE-CAN	060-H&D-WP-CAN-FAIL-LGF
CRCF-ESD20-WP-H&M	ESD20-WP-H&M-LOR-FIRE	ESD20-WP-H&M-LOR-FIRE-CA	060-H&M-WP-CAN-FAIL-LOR
	ESD20-WP-H&M-PR-FIRE	ESD20-WP-H&M-PR-FIRE-CAN	060-H&M-WP-CAN-FAIL-PR
	ESD20-H&M-LG-FIRE	ESD20-WP-H&M-LG-FIRE-CAN	060-H&M-WP-CAN-FAIL-LGF

NOTE: ^aThis column may contain fault trees and basic events. See Attachment C for basic events.
^bBasic events for probability of the waste canister in a transportation cask subjected to diesel fire or none-diesel fire, in an aging overpack, waste package, WPTT, or CTM are coupled with the probability of failure through an AND gate.

Source: Original

SHIELDING. This pivotal event represents the success or failure of the shielding provided by the transportation cask, CTM shield bell, WPTT shield compartment, TEV shield compartment, or shield doors as a result of the initiating event. Table A4.20-4 indicates the fault trees or basic events that are associated with this pivotal event for each initiating event.

Table A4.20-4. Fault Tree Associated with the SHIELDING Pivotal Events of CRC-ESD-20

Initiator Event Tree	Initiating Event Name	Name Assigned to SHIELDING	Associated Fault Tree or Basic Event ^{a,b}
CRCF-ESD20-DPC	ESD20-DPC-CSK-CUR-FIRE	ESD20-SHIELD-TC	SHIELD-FIRE-TC
	ESD20-DPC-CSK-CPA-FIRE		
	ESD20-DPC-CAN-CTM-FIRE	ESD20-SHIELD-CTM	CTM-FIRE-SHIELDING
	ESD20-DPC-LG-FIRE	ESD20-SHIELD-DPC-LF	060-DPC-SH-FAIL-TC-LF OR 060-DPC-SH-FAIL-AO-LF
CRCF-ESD20-DSTD	ESD20-DSNF-CSK-CUR-FIRE	ESD20-SHIELD-TC	SHIELD-FIRE-TC
	ESD20-DSNF-CSK-CPA-FIRE		
	ESD20-DSNF-CAN-CTM-FIRE	ESD20-SHIELD-CTM	CTM-FIRE-SHIELDING
	ESD20-DSNF-LG-FIRE	ESD20-SHIELD-DSTD-LF	060-DSTD-SH-FAIL-TC-LF OR 060-DSTD-SH-FAIL-CTM-LF OR 060-DSTD-SH-FAIL-STAGING

Table A4.20-4. Fault Tree Associated with the SHIELDING Pivotal Events of CRC-ESD-20 (Continued)

Initiator Event Tree	Initiating Event Name	Name Assigned to SHIELDING	Associated Fault Tree or Basic Event^{a, b}
CRCF-ESD20-HLW	ESD20-HLW-CSK-CUR-FIRE	ESD20-SHIELD-TC	SHIELD-FIRE-TC
	ESD20-HLW-CSK-CPA-FIRE		
	ESD20-HLW-CAN-CTM-FIRE	ESD20-SHIELD-CTM	CTM-FIRE-SHIELDING
	ESD20-HLW-WP-PR-FIRE	ESD20-SHIELD-WP	WP-FIRE-SHIELDING
	ESD20-HLW-LG-FIRE	ESD20-SHIELD-HLW-LF	060-HLW-SH-FAIL-TC-LF OR 060-HLW-SH-FAIL-CTM-LF OR 060-HLW-SH-FAIL-WP-LF
CRCF-ESD20-MCO	ESD20-MCO-CSK-CUR-FIRE	ESD20-SHIELD-TC	SHIELD-FIRE-TC
	ESD20-MCO-CSK-CPA-FIRE		
	ESD20-MCO-CAN-CTM-FIRE	ESD20-SHIELD-CTM	CTM-FIRE-SHIELDING
	ESD20-MCO-LG-FIRE	ESD20-SHIELD-MCO-LF	060-MCO-SH-FAIL-TC-LF OR 060-MCO-SH-FAIL-CTM-LF
CRCF-ESD20-TAD	ESD20-TAD-WP-LOR-FIRE	ESD20-SHIELD-WP	WP-FIRE-SHIELDING
	ESD20-TAD-CSK-CUR-FIRE	ESD20-SHIELD-TAD-TCAO1	060-TC-SHIELD-IN-CUR OR 060-AO-SHIELD-IN-CUR
	ESD20-TAD-WP-PR-FIRE	ESD20-SHIELD-WP	WP-FIRE-SHIELDING
	ESD20-TAD-CSK-CPA-FIRE	ESD20-SHIELD-TAD-TCAO2	060-TC-SHIELD-IN-PREP OR 060-AO-SHIELD-IN-PREP
	ESD20-TAD-CAN-CTM-FIRE	ESD20-SHIELD-CTM	CTM-FIRE-SHIELDING
	ESD20-TAD-LG-FIRE	ESD20-SHIELD-TAD-LF	060-TAD-SH-FAIL-TC-LF OR 060-TAD-SH-FAIL-CTM-LF OR 060-TAD-SH-FAIL-AO-LF OR 060-TAD-SH-FAIL-WP-LF

Table A4.20-4. Fault Tree Associated with the SHIELDING Pivotal Events of CRC-ESD-20 (Continued)

Initiator Event Tree	Initiating Event Name	Name Assigned to SHIELDING	Associated Fault Tree or Basic Event ^{a, b}
CRCF-ESD20-WP-H&D	ESD20-H&D-WP-LOR-FIRE	ESD20-SHIELD-WP	WP-FIRE-SHIELDING
	ESD20-H&D-WP-PR-FIRE		
	ESD20-H&D-LG-FIRE		
CRCF-ESD20-WP-H&M	ESD20-WP-H&M-LOR-FIRE	ESD20-SHIELD-WP	WP-FIRE-SHIELDING
	ESD20-WP-H&M-PR-FIRE		
	ESD20-H&M-LG-FIRE		

NOTE: ^a This column may contain fault trees and basic events. See Attachment B for fault trees and Attachment C for basic events.

^b Basic events for probability of the waste canister in a transportation cask, an aging overpack, a waste package, the WPTT or in the CTM are coupled with the probability of shield failure through an AND gate.

Source: Original

CONFINEMENT. Table A4.20-5 indicates the fault trees or basic events that are associated with this pivotal event for each initiating event.

Table A4.20-5. Fault Tree Associated with the CONFINEMENT Pivotal Events of CRC-ESD-20

Initiator Event Tree	Initiating Event Name	Name Assigned to CONFINEMENT	Associated Fault Tree or Basic Event ^a
CRCF-ESD20-DPC	ESD20-DPC-CSK-CUR-FIRE	ESD20-CONF ^b	060-DP-LOSS-CRCF
	ESD20-DPC-CSK-CPA-FIRE		
	ESD20-DPC-CAN-CTM-FIRE		
	ESD20-DPC-LG-FIRE	ESD20-CONF-LGF	This basic event is always 1.
CRCF-ESD20-DSTD	ESD20-DSNF-CSK-CUR-FIRE	ESD20-CONF ^b	060-DP-LOSS-CRCF
	ESD20-DSNF-CSK-CPA-FIRE		
	ESD20-DSNF-CAN-CTM-FIRE		
	ESD20-DSNF-LG-FIRE	ESD20-CONF-LGF	This basic event is always 1.
CRCF-ESD20-HLW	ESD20-HLW-CSK-CUR-FIRE	ESD20-CONF ^b	060-DP-LOSS-CRCF
	ESD20-HLW-CSK-CPA-FIRE		
	ESD20-HLW-CAN-CTM-FIRE		
	ESD20-HLW-WP-PR-FIRE		
	ESD20-HLW-LG-FIRE	ESD20-CONF-LGF	This basic event is always 1.
CRCF-ESD20-MCO	ESD20-MCO-CSK-CUR-FIRE	ESD20-CONF ^b	060-DP-LOSS-CRCF
	ESD20-MCO-CSK-CPA-FIRE		
	ESD20-MCO-CAN-CTM-FIRE		
	ESD20-MCO-LG-FIRE	ESD20-CONF-LGF	This basic event is always 1.

Table A4.20-5. Fault Tree Associated with the CONFINEMENT Pivotal Events of CRC-ESD-20
(Continued)

Initiator Event Tree	Initiating Event Name	Name Assigned to CONFINEMENT	Associated Fault Tree or Basic Event ^a
CRCF-ESD20-TAD	ESD20-TAD-WP-LOR-FIRE	ESD20-CONF ^b	060-DP-LOSS-CRCF
	ESD20-TAD-CSK-CUR-FIRE		
	ESD20-TAD-WP-PR-FIRE		
	ESD20-TAD-CSK-CPA-FIRE		
	ESD20-TAD-CAN-CTM-FIRE	ESD20-CONF-LGF	This basic event is always 1.
CRCF-ESD20-WP-H&D	ESD20-H&D-WP-LOR-FIRE	ESD20-CONF ^b	060-DP-LOSS-CRCF
	ESD20-H&D-WP-PR-FIRE		
	ESD20-H&D-LG-FIRE	ESD20-CONF-LGF	This basic event is always 1.
CRCF-ESD20-WP-H&M	ESD20-WP-H&M-LOR-FIRE		
	ESD20-WP-H&M-PR-FIRE		
	ESD20-H&M-LG-FIRE	ESD20-CONF-LGF	This basic event is always 1.

NOTE: ^a This column may contain fault trees and basic events. See Attachment B for fault trees and Attachment C for basic events.

^b This passes through a transfer tree named CONFINEMENT.

Source: Original

MODERATOR. The conditional probability of failure (introduction of liquid moderator) is the same for all waste forms and initiating events as shown in Table A4.20-6.

Table A4.20-6. Basic Event Associated with the MODERATOR Pivotal Events of CRC-ESD-020

Initiator Event Tree	Initiating Event Name	Name Assigned to MODERATOR	Associated Fault Tree or Basic Event ^a
CRCF-ESD20-DPC	ESD20-DPC-CSK-CUR-FIRE	ESD20-MOD-FIRE	060-MODERATOR-IN-FIRE
	ESD20-DPC-CSK-CPA-FIRE		
	ESD20-DPC-CAN-CTM-FIRE		
	ESD20-DPC-LG-FIRE		
CRCF-ESD20-DSTD	ESD20-DSNF-CSK-CUR-FIRE	ESD20-MOD-FIRE-DOE	060-MODERATOR-IN-FIREDOE
	ESD20-DSNF-CSK-CPA-FIRE		
	ESD20-DSNF-CAN-CTM-FIRE		
	ESD20-DSNF-LG-FIRE		
CRCF-ESD20-HLW	ESD20-HLW-CSK-CUR-FIRE	ESD20-MOD-FIRE	HLW-MODERATOR
	ESD20-HLW-CSK-CPA-FIRE		
	ESD20-HLW-CAN-CTM-FIRE		
	ESD20-HLW-WP-PR-FIRE		
	ESD20-HLW-LG-FIRE		

Table A4.20-6. Basic Event Associated with the MODERATOR Pivotal Events of CRC-ESD-020
(Continued)

Initiator Event Tree	Initiating Event Name	Name Assigned to MODERATOR	Associated Fault Tree or Basic Event ^a
CRCF-ESD20-MCO	ESD20-MCO-CSK-CUR-FIRE		060-MODERATOR-IN-FIRE
	ESD20-MCO-CSK-CPA-FIRE		
	ESD20-MCO-CAN-CTM-FIRE		
	ESD20-MCO-LG-FIRE		
CRCF-ESD20-TAD	ESD20-TAD-WP-LOR-FIRE		
	ESD20-TAD-CSK-CUR-FIRE		
	ESD20-TAD-WP-PR-FIRE		
	ESD20-TAD-CSK-CPA-FIRE		
	ESD20-TAD-CAN-CTM-FIRE		
	ESD20-TAD-LG-FIRE		
CRCF-ESD20-WP-H&D	ESD20-H&D-WP-LOR-FIRE		
	ESD20-H&D-WP-PR-FIRE		
	ESD20-H&D-LG-FIRE		
CRCF-ESD20-WP-H&M	ESD20-WP-H&M-LOR-FIRE		
	ESD20-WP-H&M-PR-FIRE		
	ESD20-H&M-LG-FIRE		

NOTE: ^a This column may contain fault trees and basic events. See Attachment B for fault trees and Attachment C for basic events.

Source: Original

A5. EVENT TREES

Navigation from an initiator event tree to the corresponding response event tree is assisted by the rightmost two columns on the initiator event trees as shown in Figure A5-1. The numbers under the “#” symbol may be used by the reader to refer to a particular branch of an event tree, but it is not used elsewhere in this analysis.

Number of waste forms processed over facility	Identify initiating events			
NUMBER-WAS	INIT-EVENT	#		XFER-TO-RESP-TREE
		1		
		2	T => 2	RESPONSE-SAMPLE
		3	T => 2	RESPONSE-SAMPLE
		4	T => 2	RESPONSE-SAMPLE

Indicates system response event tree title

Indicates system response event tree sheet number

Source: Original

Figure A5-1. Example Initiator Event Tree Showing Navigation Aids

Table A5-1. ESDs to Event Trees

ESD#	ESD Title	IE Event Tree Name	IE Event Tree Location	Response Tree Name	Response Tree Location
CRC-ESD-01	Event Sequences for Activities Associated with Receipt of TC in Transportation Cask Vestibule and Movement into Cask Preparation Room	CRCF-ESD01-DPC CRCF-ESD01-DSTD CRCF-ESD01-HLW CRCF-ESD01-MCO CRCF-ESD01-TAD	Figure A5-2 Figure A5-4 Figure A5-5 Figure A5-6 Figure A5-7	RESPONSE-TCASK1	Figure A5-3
CRC-ESD-02	Event Sequences for Activities Associated with Receipt of AO in Site Transporter Vestibule and Movement into Cask Preparation Room	CRCF-ESD02-TAD	Figure A5-8	RESPONSE-AO1	Figure A5-9
CRC-ESD-03	Event Sequences for Activities Associated with Removal of Impact Limiters, Upending and Transfer of TC to CTT	CRCF-ESD03-DPC CRCF-ESD03-DSTD CRCF-ESD03-HLW CRCF-ESD03-MCO CRCF-ESD03-TAD	Figure A5-10 Figure A5-11 Figure A5-12 Figure A5-13 Figure A5-14	RESPONSE-TCASK1	Figure A5-3
CRC-ESD-04	Event Sequences for Cask Preparation Activities Associated with Unbolting and Lid Adapter Installation	CRCF-ESD04-DPC CRCF-ESD04-DSTD CRCF-ESD04-HLW CRCF-ESD04-MCO CRCF-ESD04-TAD	Figure A5-15 Figure A5-16 Figure A5-17 Figure A5-18 Figure A5-19	RESPONSE-TCASK1	Figure A5-3
CRC-ESD-05	Event Sequences for AO Preparation Activities Associated with Unbolting and Lid Adapter Installation	CRCF-ESD05-TAD	Figure A5-20	RESPONSE-CANISTER1	Figure A5-21
CRC-ESD-06	Event Sequences Associated with Transfer of Cask on CTT or an AO on ST from Cask Preparation Room to Cask Unloading Room	CRCF-ESD06-DPC CRCF-ESD06-DSTD CRCF-ESD06-HLW CRCF-ESD06-MCO CRCF-ESD06-TAD	Figure A5-22 Figure A5-24 Figure A5-25 Figure A5-26 Figure A5-27	RESPONSE-TCASK2	Figure A5-23

Table A5-1. ESDs to Event Trees (Continued)

ESD#	ESD Title	IE Event Tree Name	IE Event Tree Location	Response Tree Name	Response Tree Location
CRC-ESD-07	Event Sequences Associated with Collision of CTT or ST with Cask Unloading Room Shield Door	CRCF-ESD07-DPC CRCF-ESD07-DSTD CRCF-ESD07-HLW CRCF-ESD07-MCO CRCF-ESD07-TAD CRCF-ESD07-WP-H&D CRCF-ESD07-WP-H&M CRCF-ESD07-WP-TAD	Figure A5-28 Figure A5-29 Figure A5-30 Figure A5-31 Figure A5-32 Figure A5-33 Figure A5-34 Figure A5-35	N/A	N/A
CRC-ESD-08	Event Sequences Associated with Collision of two CTMs Loaded with Canisters	CRCF-ESD08-DPC CRCF-ESD08-DSTD CRCF-ESD08-HLW CRCF-ESD08-MCO CRCF-ESD08-TAD	Figure A5-36 Figure A5-37 Figure A5-38 Figure A5-39 Figure A5-40	RESPONSE-CANISTER1	Figure A5-21
CRC-ESD-09	Event Sequences for Activities Associated with Lifting and Lowering a Canister during Transfer to or from Staging, TC, WP, or AO with CTM	CRCF-ESD09-DPC CRCF-ESD09-DSTD CRCF-ESD09-HLW CRCF-ESD09-MCO CRCF-ESD09-TAD	Figure A5-41 Figure A5-42 Figure A5-43 Figure A5-44 Figure A5-45	RESPONSE-CANISTER1	Figure A5-21
CRC-ESD-10	Event Sequences for Activities Associated with WP Transfer from WP Loading Room to Closing Position in WP Positioning Room below WP Closure Room	CRCF-ESD10-WP-H&D CRCF-ESD10-WP-H&M CRCF-ESD10-WP-TAD	Figure A5-46 Figure A5-48 Figure A5-49	RESPONSE-WP1	Figure A5-47
CRC-ESD-11	Event Sequences for Activities Associated with Assembly and Closure of WP	CRCF-ESD11-WP-H&D CRCF-ESD11-WP-H&M CRCF-ESD11-WP-TAD	Figure A5-50 Figure A5-51 Figure A5-52	RESPONSE-WP1	Figure A5-47
CRC-ESD-12	Event Sequences for Activities Associated with Assembly and Closure of AO	CRCF-ESD12-DPC CRCF-ESD12-TAD	Figure A5-53 Figure A5-54	RESPONSE-AO1	Figure A5-9

Table A5-1. ESDs to Event Trees (Continued)

ESD#	ESD Title	IE Event Tree Name	IE Event Tree Location	Response Tree Name	Response Tree Location
CRC-ESD-13	Event Sequences for Activities Associated with Transfer of WP from WP Closure Room to WPTT Docking Station	CRCF-ESD13-WP-H&D CRCF-ESD13-WP-H&M CRCF-ESD13-WP-TAD	Figure A5-55 Figure A5-57 Figure A5-58	RESPONSE-WP2	Figure A5-56
CRC-ESD-14	Event Sequences for Activities Associated with Transfer of AO from Cask Unloading Room to Cask Preparation Room	CRCF-ESD14-DPC CRCF-ESD14-TAD	Figure A5-59 Figure A5-60	RESPONSE-AO1	Figure A5-9
CRC-ESD-15	Event Sequences for Activities Associated with Exporting of WP from CRCF	CRCF-ESD15-WP-H&D CRCF-ESD15-WP-H&M CRCF-ESD15-WP-TAD	Figure A5-61 Figure A5-62 Figure A5-63	RESPONSE-WP2	Figure A5-56
CRC-ESD-16	Event Sequences for Activities Associated with Exporting of AO from CRCF	CRCF-ESD16-DPC CRCF-ESD16-TAD	Figure A5-64 Figure A5-65	RESPONSE-AO1	Figure A5-9
CRC-ESD-17	Event Sequences for Activities Associated with Direct Exposure During Cask Preparation Activities	CRCF-ESD17-DPC CRCF-ESD17-DSTD CRCF-ESD17-HLW CRCF-ESD17-MCO CRCF-ESD17-TAD	Figure A5-66 Figure A5-67 Figure A5-68 Figure A5-69 Figure A5-70	N/A	N/A
CRC-ESD-18	Event Sequences for Activities Associated with Direct Exposure During CTM Activities	CRCF-ESD18-DPC CRCF-ESD18-DSTD CRCF-ESD18-HLW CRCF-ESD18-MCO CRCF-ESD18-TAD	Figure A5-71 Figure A5-72 Figure A5-73 Figure A5-74 Figure A5-75	N/A	N/A
CRC-ESD-19	Event Sequences for Activities Associated with Direct Exposure During Closure and Exporting Loaded WP	CRCF-ESD19-WP H&D CRCF-ESD19- WP H&M CRCF-ESD19-WP-TAD	Figure A5-76 Figure A5-77 Figure A5-78	N/A	N/A

Table A5-1. ESDs to Event Trees (Continued)

ESD#	ESD Title	IE Event Tree Name	IE Event Tree Location	Response Tree Name	Response Tree Location
CRC-ESD-20	Event Sequences for Fire Occurring in Canister Receipt and Closure Facility	CRCF-ESD20-DPC CRCF-ESD20-DSTD CRCF-ESD20-HLW CRCF-ESD20-MCO CRCF-ESD20-TAD CRCF-ESD20-WP-H&D CRCF-ESD20-WP-H&M	Figure A5-79 Figure A5-81 Figure A5-82 Figure A5-83 Figure A5-84 Figure A5-85 Figure A5-86	RESPONSE-FIRE	Figure A5-80

NOTE: AO = aging overpack; CRCF = Canister Receipt and Closure Facility; CTM = canister transfer machine; CTT = cask transfer trolley; N/A = not applicable; ST = site transporter; TC = transportation cask; WP = waste package; WPTT = waste package transfer trolley.

Source: Original

Number of TCs containing DPCs received during preclosure period	Identify initiating events		
TC-DPC	INIT-EVENT	#	XFER-TO-RESP-TREE
		<p>1</p> <p>2 T=> 2</p> <p>3 T=> 2</p>	<p>OK</p> <p>RESPONSE-TCASK1</p> <p>RESPONSE-TCASK1</p>
CRCF-ESD01-DPC - Receipt of TC with DPC canister in the Cask Preparation Area			2007/10/11 Page 1

Source: Original

Figure A5-2. Event Tree CRCF-ESD01-DPC – Receipt of Transportation Cask with DPC Canister in the Cask Preparation Room

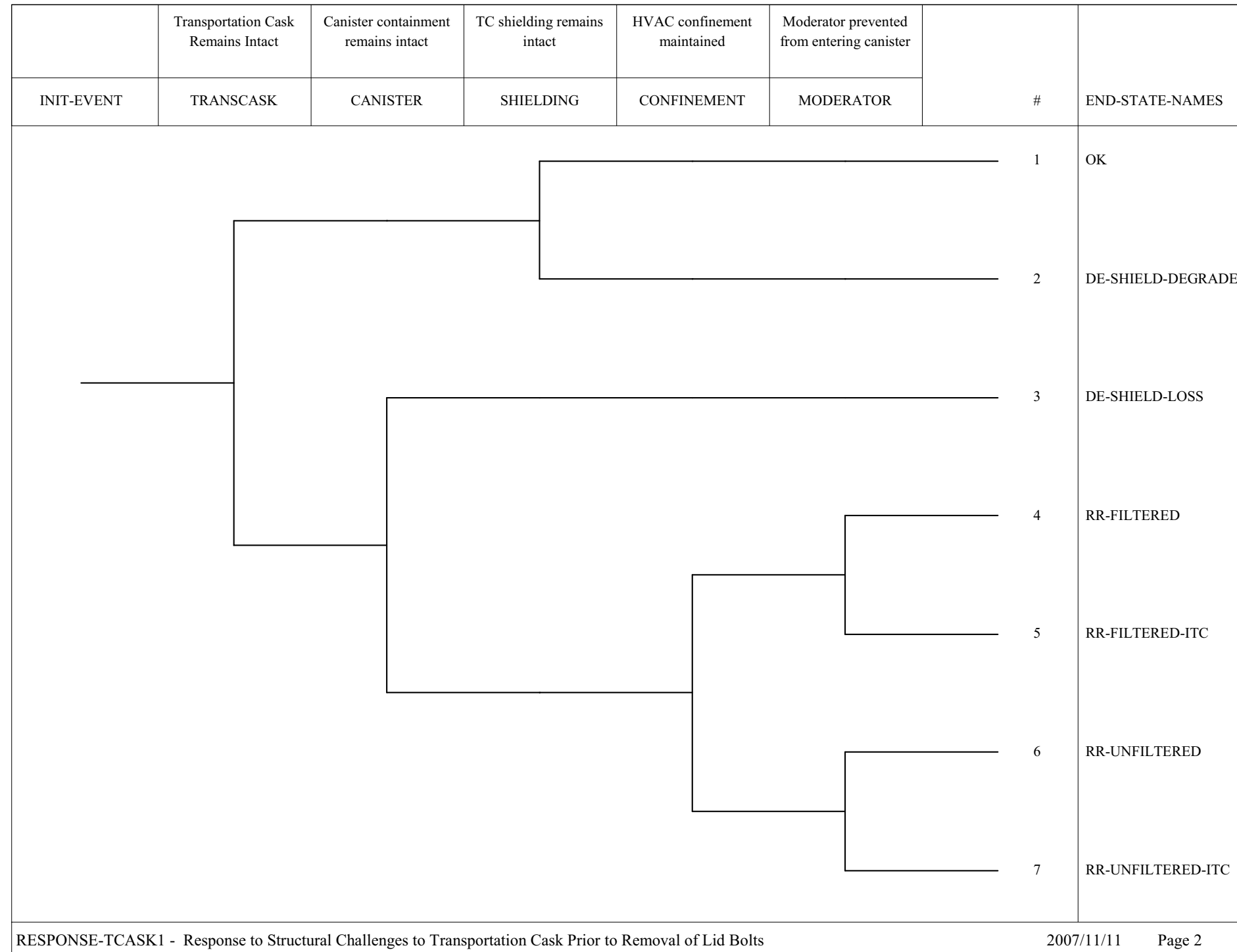

Source: Original

Figure A5-3. Event Tree RESPONSE-TCASK1
– Response to Structural
Challenges to Transportation Cask
Prior to Removal of Lid Bolts

Number of TCs containing DOE Std. Canisters received during preclosure period	Identify initiating events			
TC-DSTD	INIT-EVENT	#		XFER-TO-RESP-TREE
CRCF-ESD01-DSTD - Receipt of TC with DSTD in the Cask Preparation Area				2007/11/06 Page 3

Source: Original

Figure A5-4. Event Tree CRCF-ESD01-DSTD – Receipt of Transportation Cask with DOE Std. Canister in the Cask Preparation Room

Number of TCs containing HLW Canisters received during preclosure period	Identify initiating events			
TC-HLW	INIT-EVENT	#		XFER-TO-RESP-TREE
	Rail car derailment	1		OK
	Truck trailer rollover	2	T => 2	RESPONSE-TCASK1
	RC/TT collision	3	T => 2	RESPONSE-TCASK1
		4	T => 2	RESPONSE-TCASK1
CRCF-ESD01-HLW - Receipt of TC with HLW Canister in the Cask Preparation Area				2007/11/19 Page 4

Source: Original

Figure A5-5. Event Tree CRCF-ESD01-HLW - Receipt of Transportation Cask with HLW Canister in the Cask Preparation Room

Number of TCs containing MCOs received during preclosure period	Identify initiating events																							
TC-MCO	INIT-EVENT	#		XFER-TO-RESP-TREE																				
<table border="1" style="margin-left: auto; margin-right: auto;"> <tr> <td style="width: 150px;"></td> <td style="text-align: center;">1</td> <td></td> <td></td> <td style="text-align: center;">OK</td> </tr> <tr> <td style="text-align: center;">Rail Car Derailment</td> <td style="text-align: center;">2</td> <td style="text-align: center;">T =></td> <td style="text-align: center;">2</td> <td style="text-align: center;">RESPONSE-TCASK1</td> </tr> <tr> <td style="text-align: center;">Truck Trailer Rollover</td> <td style="text-align: center;">3</td> <td style="text-align: center;">T =></td> <td style="text-align: center;">2</td> <td style="text-align: center;">RESPONSE-TCASK1</td> </tr> <tr> <td style="text-align: center;">RC/TT Collision</td> <td style="text-align: center;">4</td> <td style="text-align: center;">T =></td> <td style="text-align: center;">2</td> <td style="text-align: center;">RESPONSE-TCASK1</td> </tr> </table>						1			OK	Rail Car Derailment	2	T =>	2	RESPONSE-TCASK1	Truck Trailer Rollover	3	T =>	2	RESPONSE-TCASK1	RC/TT Collision	4	T =>	2	RESPONSE-TCASK1
	1			OK																				
Rail Car Derailment	2	T =>	2	RESPONSE-TCASK1																				
Truck Trailer Rollover	3	T =>	2	RESPONSE-TCASK1																				
RC/TT Collision	4	T =>	2	RESPONSE-TCASK1																				
CRCF-ESD01-MCO - Receipt of TC with MCO in the Cask Preparation Area				2007/11/15 Page 5																				

Source: Original

Figure A5-6. Event Tree CRCF-ESD01-MCO - Receipt of Transportation Cask with MCO in the Cask Preparation Room

Number of TCs containing TADs received during preclosure period	Identify initiating events			
TC-TAD	INIT-EVENT	#		XFER-TO-RESP-TREE
	Rail car derailment	1		OK
	Rail car collision	2	T => 2	RESPONSE-TCASK1
	Rail car collision	3	T => 2	RESPONSE-TCASK1
CRCF-ESD01-TAD - Receipt of TC with TAD in the Cask Preparation Area				2007/11/06 Page 6

Source: Original

Figure A5-7. Event Tree CRCF-ESD01-TAD – Receipt of Transportation Cask with TAD Canister in the Cask Preparation Room

Number of AOs containing TADs received during preclosure period	Identify initiating events			
AO-TAD-IN	INIT-EVENT	#		XFER-TO-RESP-TREE
CRCF-ESD02-TAD - Receipt of AO with TAD in the Cask Preparation Area				2007/10/30 Page 7

Source: Original

Figure A5-8. Event Tree CRCF-ESD02-TAD –
Receipt of Aging Overpack with
TAD Canister in the Cask
Preparation Room

	Canister containment remains intact	Shielding remains intact	Confinement boundary intact	Moderator excluded from entering canister		
INIT-EVENT	CANISTER	SHIELDING	CONFINEMENT	MODERATOR	#	END-STATE-NAMES
					1	OK
					2	DE-SHIELD-LOSS
					3	RR-FILTERED
					4	RR-FILTERED-ITC
					5	RR-UNFILTERED
					6	RR-UNFILTERED-ITC
RESPONSE-AO1 - Response to Structural Challenges to AO					2008/02/12	Page 55

Source: Original

Figure A5-9. Event Tree RESPONSE-AO1 – Response to Structural Challenges to Aging Overpack

Number of TCs containing DPCs processed during preclosure period	Identify initiating events		
TC-DPC	INIT-EVENT	#	XFER-TO-RESP-TREE
	Drop of cask	1	OK
	Tipover	2 T => 2	RESPONSE-TCASK1
	Side impact	3 T => 2	RESPONSE-TCASK1
	Unplanned Carrier Movement	4 T => 2	RESPONSE-TCASK1
	Drop on cask	5 T => 2	RESPONSE-TCASK1
	Two Block Drop	6 T => 2	RESPONSE-TCASK1
		7 T => 2	RESPONSE-TCASK1

CRCF-ESD03-DPC - Upending and Transfer of TC with DPC to CTT

2007/10/16 Page 9

Source: Original

Figure A5-10. Event Tree CRCF-ESD03-DPC –
Upending and Transfer of
Transportation Cask with DPC to
CTT

Number of TCs containing DOE Std. Canister processed during preclosure period	Identify initiating events			
TC-DSTD	INIT-EVENT	#	XFER-TO-RESP-TREE	
		1		OK
	Drop of cask	2	T => 2	RESPONSE-TCASK1
	Tipover	3	T => 2	RESPONSE-TCASK1
	Side impact	4	T => 2	RESPONSE-TCASK1
	Unplanned Carrier Movement	5	T => 2	RESPONSE-TCASK1
	Drop on cask	6	T => 2	RESPONSE-TCASK1
	Two Block Drop	7	T => 2	RESPONSE-TCASK1

CRCF-ESD03-DSTD - Upending and Transfer of TC with DSTD to CTT

2007/11/06 Page 10

Source: Original

Figure A5-11. Event Tree CRCF-ESD03-DSTD – Upending and Transfer of Transportation Cask with DOE Std. Canister to CTT

Number of TCs containing HLW Canisters processed during preclosure period	Identify initiating events				
TC-HLW	INIT-EVENT	#		XFER-TO-RESP-TREE	
		1		OK	
	Drop of cask	2	T => 2	RESPONSE-TCASK1	
	Tipover	3	T => 2	RESPONSE-TCASK1	
	Side impact	4	T => 2	RESPONSE-TCASK1	
	Unplanned Carrier Movement	5	T => 2	RESPONSE-TCASK1	
	Drop on cask	6	T => 2	RESPONSE-TCASK1	
	Two Block Drop	7	T => 2	RESPONSE-TCASK1	

CRCF-ESD03-HLW - Upending and Transfer of TC with HLW Canister to the CTT

2007/10/16 Page 11

Source: Original

Figure A5-12. Event Tree CRCF-ESD03-HLW
– Upending and Transfer of
Transportation Cask with HLW
Canister to the CTT

Number of TCs containing MCOs processed during preclosure period	Identify initiating event		
TC-MCO	INIT-EVENT	#	XFER-TO-RESP-TREES
		1	OK
	Drop of Cask	2	T => 2
	Tipover	3	T => 2
	Side Impact	4	T => 2
	Unplanned Carrier Movement	5	T => 2
	Drop On Cask	6	T => 2
	Two Block Drop	7	T => 2
CRCF-ESD03-MCO - Upending and Transfer of TC with MCO to CTT			2008/02/20 Page 12

Source: Original

Figure A5-13. Event Tree CRCF-ESD03-MCO – Upending and Transfer of Transportation Cask with MCO to the CTT

Number of TCs containing TADs processed during preclosure period	Identify initiating events			
TC-TAD	INIT-EVENT	#		XFER-TO-RESP-TREE
		1		OK
	Drop of cask	2	T => 2	RESPONSE-TCASK1
	Tipover	3	T => 2	RESPONSE-TCASK1
	Side impact	4	T => 2	RESPONSE-TCASK1
	Unplanned Carrier Movement	5	T => 2	RESPONSE-TCASK1
	Drop on cask	6	T => 2	RESPONSE-TCASK1
	Two Block Drop	7	T => 2	RESPONSE-TCASK1

CRCF-ESD03-TAD - Upending and Transfer of TC with TAD to the CTT

2007/10/30 Page 13

Source: Original

Figure A5-14. Event Tree CRCF-ESD03-TAD – Upending and Transfer of Transportation Cask with TAD Canister to the CTT

Number of TCs containing DPCs processed during preclosure period	Identify initiating events		
TC-DPC	INIT-EVENT	#	XFER-TO-RESP-TREE
		<p>1</p> <p>2</p> <p>3</p> <p>4</p> <p>5</p>	<p>OK</p> <p>T => 2 RESPONSE-TCASK1</p> <p>T => 2 RESPONSE-TCASK1</p> <p>T => 2 RESPONSE-TCASK1</p> <p>T => 2 RESPONSE-TCASK1</p>
CRCF-ESD04-DPC - TC with DPC Preparation Activities		2007/10/11	Page 14

Source: Original

Figure A5-15. Event Tree CRCF-ESD04-DPC – Transportation Cask with DPC Preparation Activities

Number of TCs containing DOE Std. Canisters moved during preclosure period	Identify initiating events				
TC-DSTD	INIT-EVENT	#			XFER-TO-RESP-TREE
		1			OK
	Drop of cask	2	T =>	2	RESPONSE-TCASK1
	Cask tips over	3	T =>	2	RESPONSE-TCASK1
	Side impact	4	T =>	2	RESPONSE-TCASK1
	Drop on cask	5	T =>	2	RESPONSE-TCASK1

CRCF-ESD04-DSTD - TC with DSTD Preparation Activities

2007/12/17 Page 15

Source: Original

Figure A5-16. Event Tree CRCF-ESD04-DSTD
– Transportation Cask with DOE
Std. Canister Preparation
Activities

Number of TCs containing HLW Canisters moved during preclosure period	Identify initiating events			
TC-HLW	INIT-EVENT	#		XFER-TO-RESP-TREE
		1		OK
	Drop of cask	2	T => 2	RESPONSE-TCASK1
	Cask tips over	3	T => 2	RESPONSE-TCASK1
	Side impact	4	T => 2	RESPONSE-TCASK1
	Drop on cask	5	T => 2	RESPONSE-TCASK1

CRCF-ESD04-HLW - TC with HLW Canister Preparation Activities

2007/10/11 Page 16

Source: Original

Figure A5-17. Event Tree CRCF-ESD04-HLW
– Transportation Cask with HLW
Canister Preparation Activities

Number of TCs containing TADs moved during preclosure period	Identify initiating events		
TC-TAD	INIT-EVENT	#	XFER-TO-RESP-TREE
		1	OK
	Drop of cask	2	T => 2
	Cask tips over	3	T => 2
	Side impact	4	T => 2
	Drop on cask	5	T => 2
			RESPONSE-TCASK1
			RESPONSE-TCASK1
			RESPONSE-TCASK1
			RESPONSE-TCASK1
			RESPONSE-TCASK1

CRCF-ESD04-TAD - TC with TAD Preparation Activities

2007/10/30 Page 18

Source: Original

Figure A5-19. Event Tree CRCF-ESD04-TAD – Transportation Cask with TAD Canister Preparation Activities

Number of AOs containing TADs processed during preclosure period	Identify initiating events			
AO-TAD	INIT-EVENT	#		XFER-TO-RESP-TREE
CRCF-ESD05-TAD - AO with TAD Preparation Activities				2007/10/30 Page 19

Source: Original

Figure A5-20. Event Tree CRCF-ESD05-TAD – Aging Overpack with TAD Canister Preparation Activities

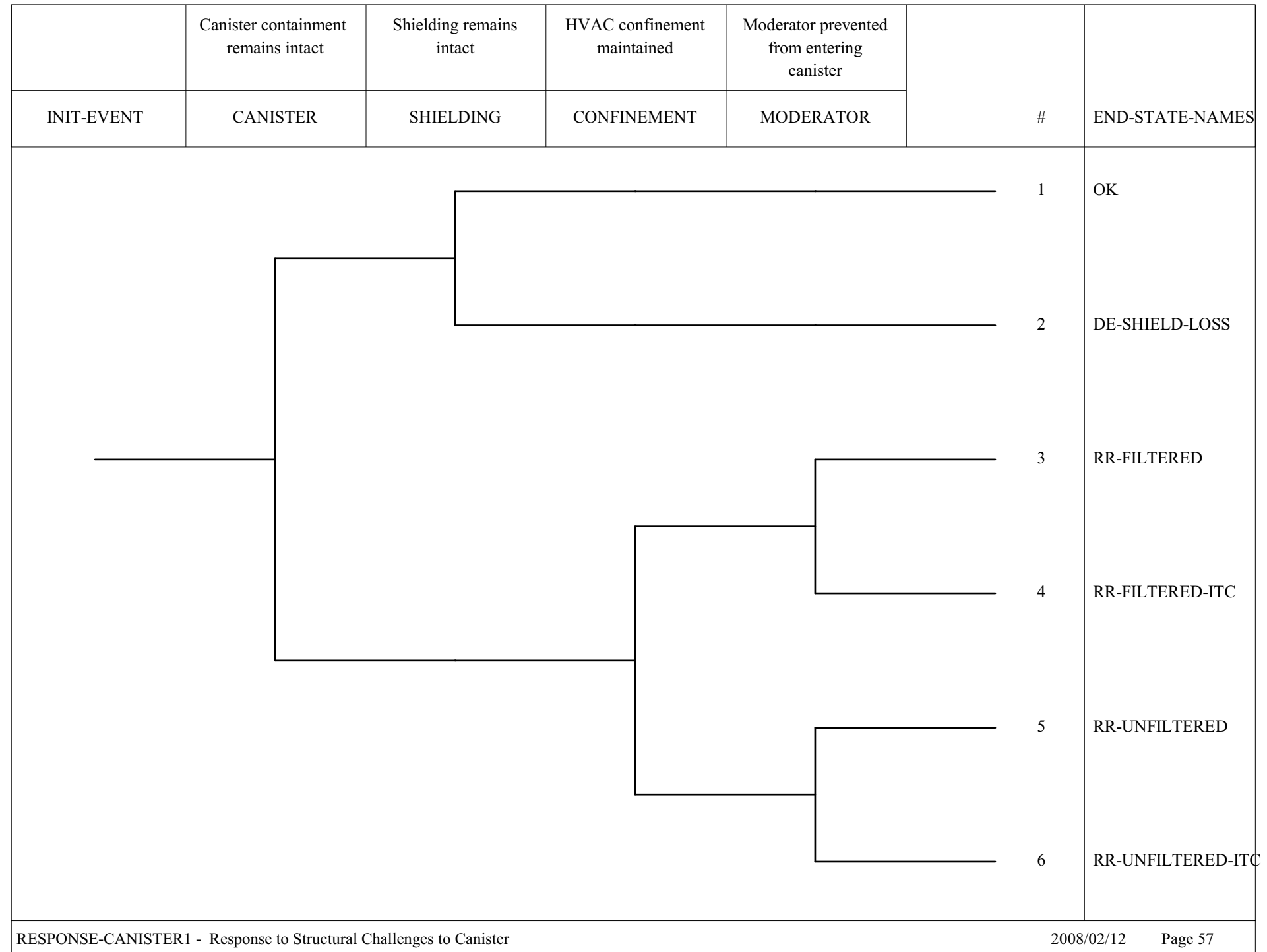

Source: Original

Figure A5-21. Event Tree RESPONSE-CANISTER1 – Response to Structural Challenges to Canister

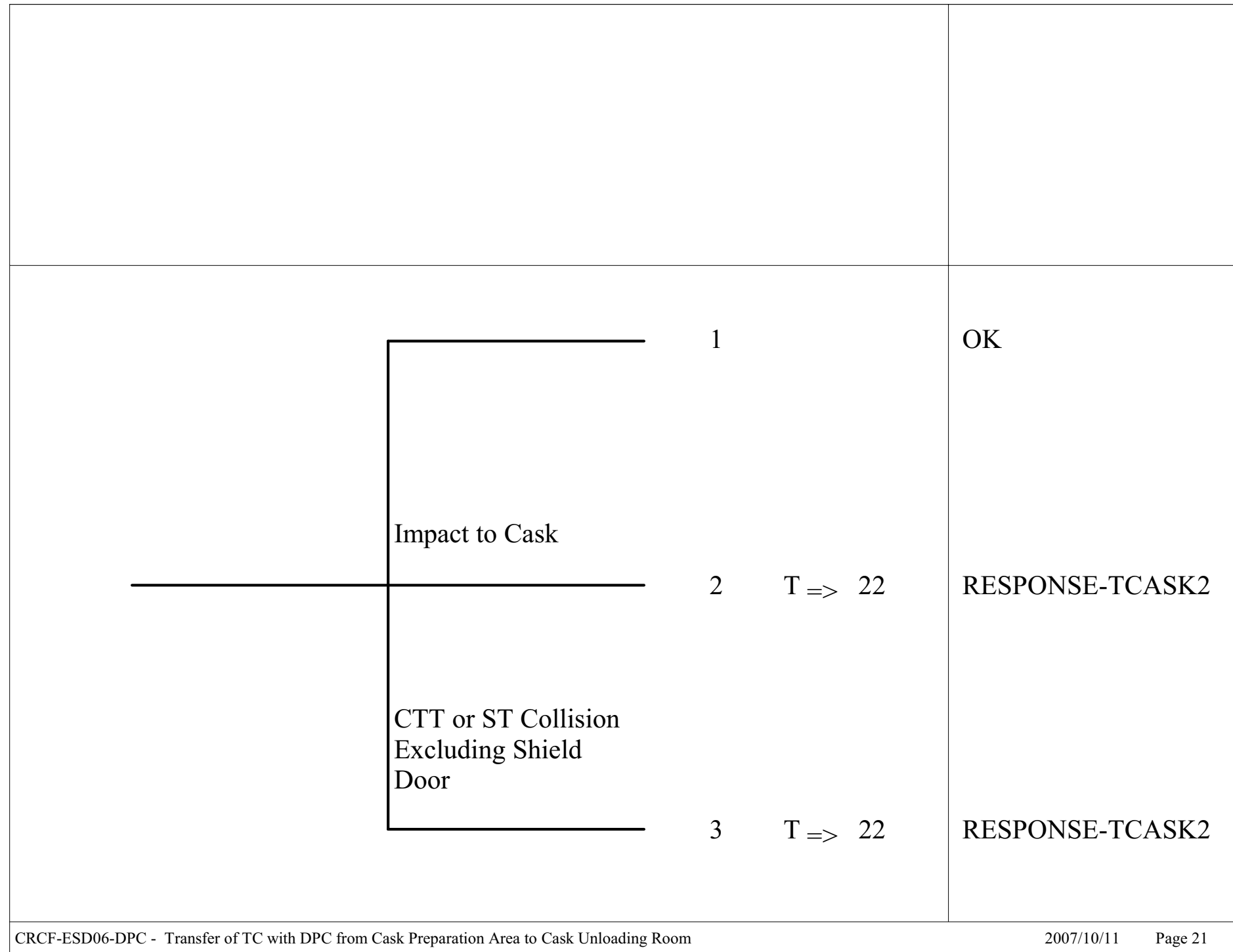

Source: Original

Figure A5-22. Event Tree CTRF-ESD06-DPC – Transfer of Transportation Cask with DPC from Cask Preparation Room to Cask Unloading Room

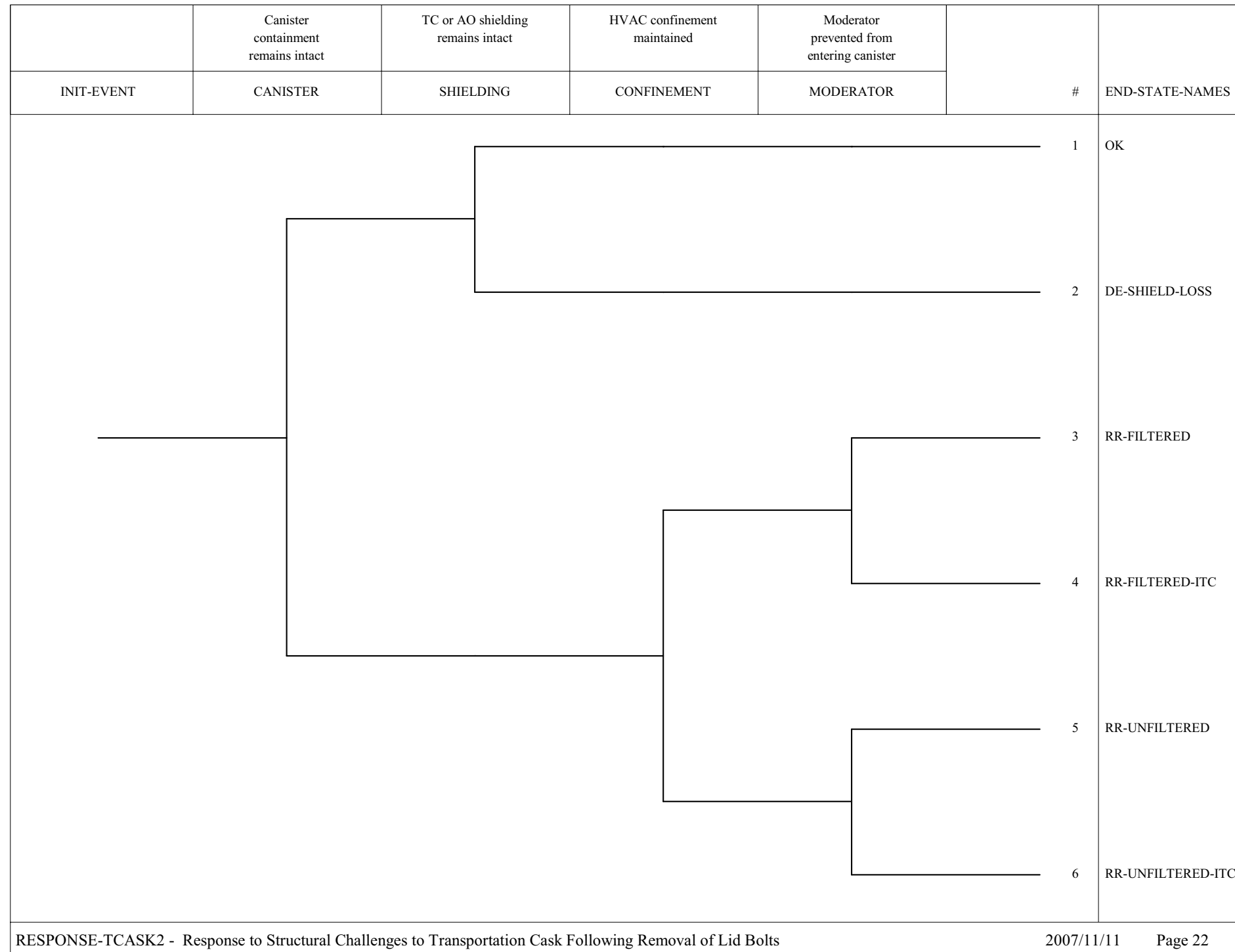

Source: Original

Figure A5-23. Event Tree RESPONSE-TCASK2 – Response to Structural Challenges to Transportation Cask Following Removal of Lid Bolts

Number of TCs containing DOE Std. Canisters moved during preclosure period	Identify initiating events			
TC-DSTD	INIT-EVENT	#		XFER-TO-RESP-TREE
		<p>1</p> <p>2</p> <p>3</p>	<p>T => 22</p> <p>T => 22</p>	<p>OK</p> <p>RESPONSE-TCASK2</p> <p>RESPONSE-TCASK2</p>
CRCF-ESD06-DSTD - Transfer of TC with DSNF from Cask Preparation Area to Cask Unloading Room				2007/11/15 Page 23

Source: Original

Figure A5-24. Event Tree CRCF-ESD06-DSTD – Transfer of Transportation Cask with DOE SNF from Cask Preparation Room to Cask Unloading Room

Number of TCs containing HLW Canisters moved during preclosure period	Identify initiating events			
TC-HLW	INIT-EVENT	#		XFER-TO-RESP-TREE
		1		OK
	Impact to Cask	2	T => 22	RESPONSE-TCASK2
	CTT Collision Excluding Shield Door	3	T => 22	RESPONSE-TCASK2

CRCF-ESD06-HLW - Transfer of TC with HLW Canister from Cask Preparation Area to Cask Unloading Room

2007/12/06 Page 24

Source: Original

Figure A5-25. Event Tree CRCF-ESD06-HLW –
Transfer of Transportation Cask
with HLW Canister from Cask
Preparation Room to Cask
Unloading Room

Number of TCs containing MCOs moved during preclosure period	Identify initiating events		
TC-MCO	INIT-EVENT	#	XFER-TO-RESP-TREES
CRCF-ESD06-MCO - Transfer of TC with MCO from Cask Preparation Area to Cask Unloading Room			2007/11/15 Page 25

Source: Original

Figure A5-26. Event Tree CRCF-ESD06-MCO – Transfer of Transportation Cask with MCO from Cask Preparation Room to Cask Unloading Room

Number of TCs and AOs containing TADs moved during preclosure period	Identify initiating events			
TC-AO-TAD	INIT-EVENT	#		XFER-TO-RESP-TREE
		1		OK
	Impact to Cask	2	T => 22	RESPONSE-TCASK2
	Impact to AO	3	T => 22	RESPONSE-TCASK2
	CTT Collision Excluding ShieldDoor	4	T => 22	RESPONSE-TCASK2
	ST Collision Excluding ShieldDoor	5	T => 22	RESPONSE-TCASK2

CRCF-ESD06-TAD - Transfer of TC or AO with TAD from Cask Preparation Area to Cask Unloading Room

2007/11/15 Page 26

Source: Original

Figure A5-27. Event Tree CRCF-ESD06-TAD – Transfer of Transportation Cask or Aging Overpack with TAD Canister from Cask Preparation Room to Cask Unloading Room

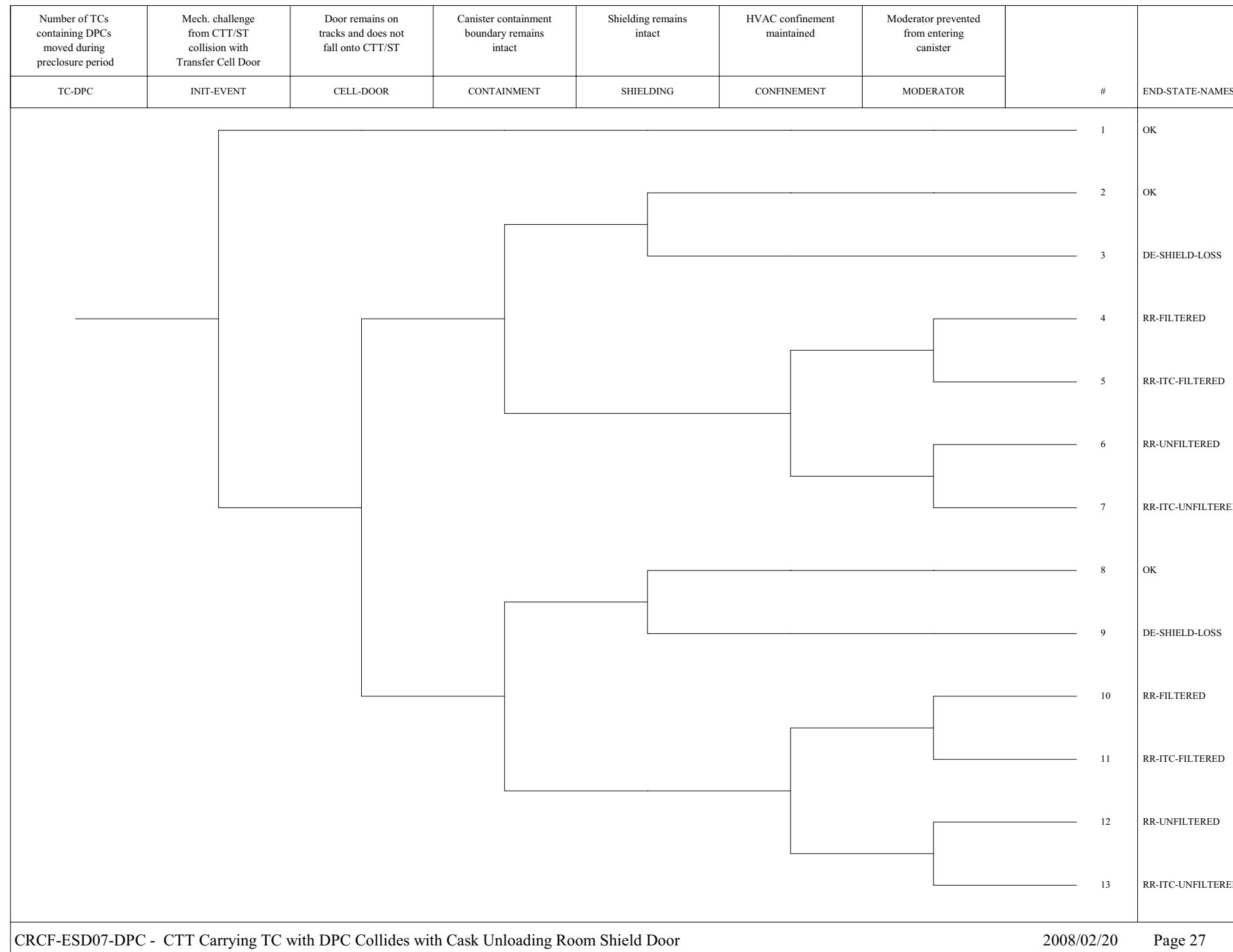

Source: Original

Figure A5-28. Event Tree CRCF-ESD07-DPC – CTT Carrying Transportation Cask with DPC Collides with Cask Unloading Room Shield Door

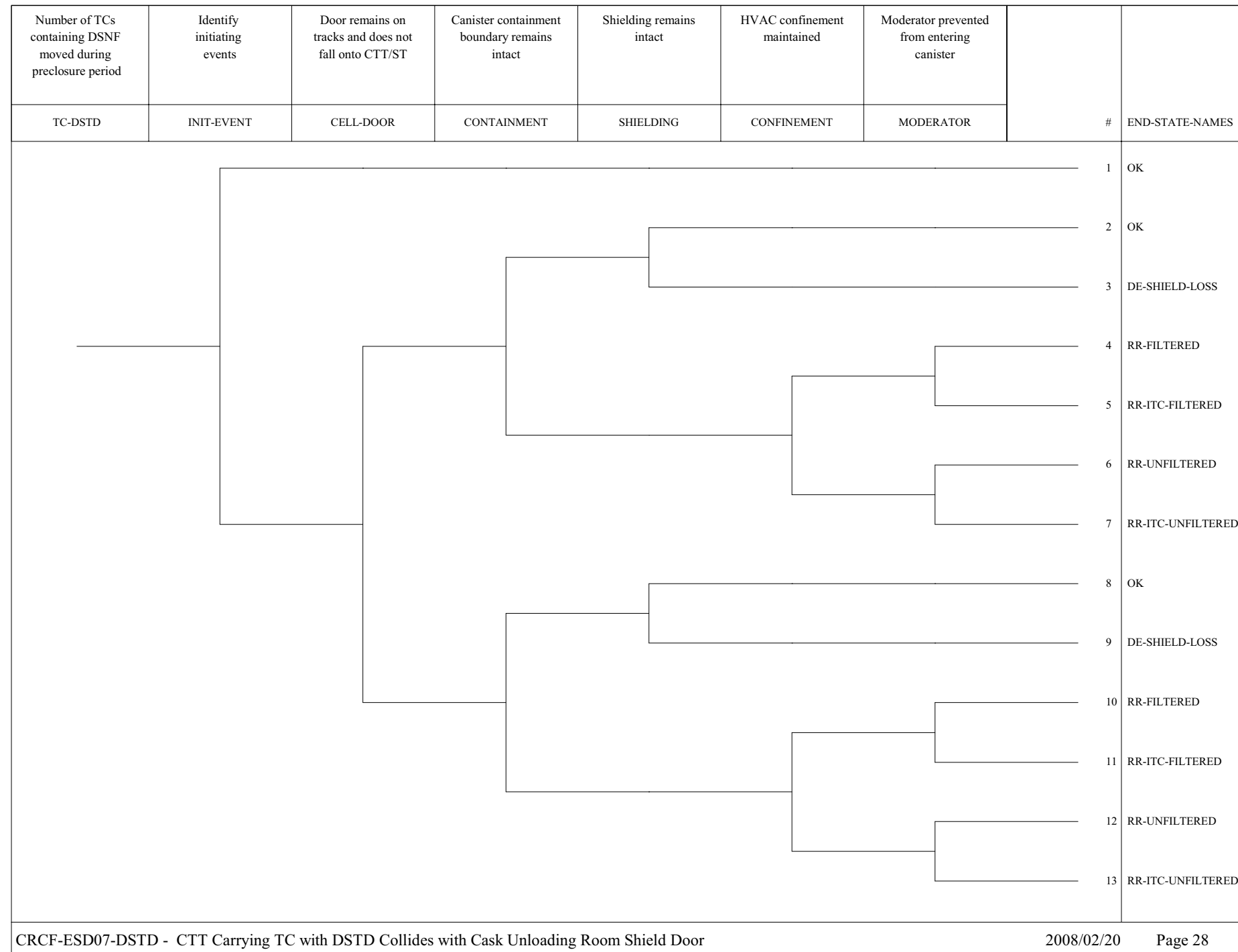

Source: Original

Figure A5-29. Event Tree CRCF-ESD07-DSTD – CTT Carrying Transportation Cask with DOE Std. Canister Collides with Cask Unloading Room Shield Door

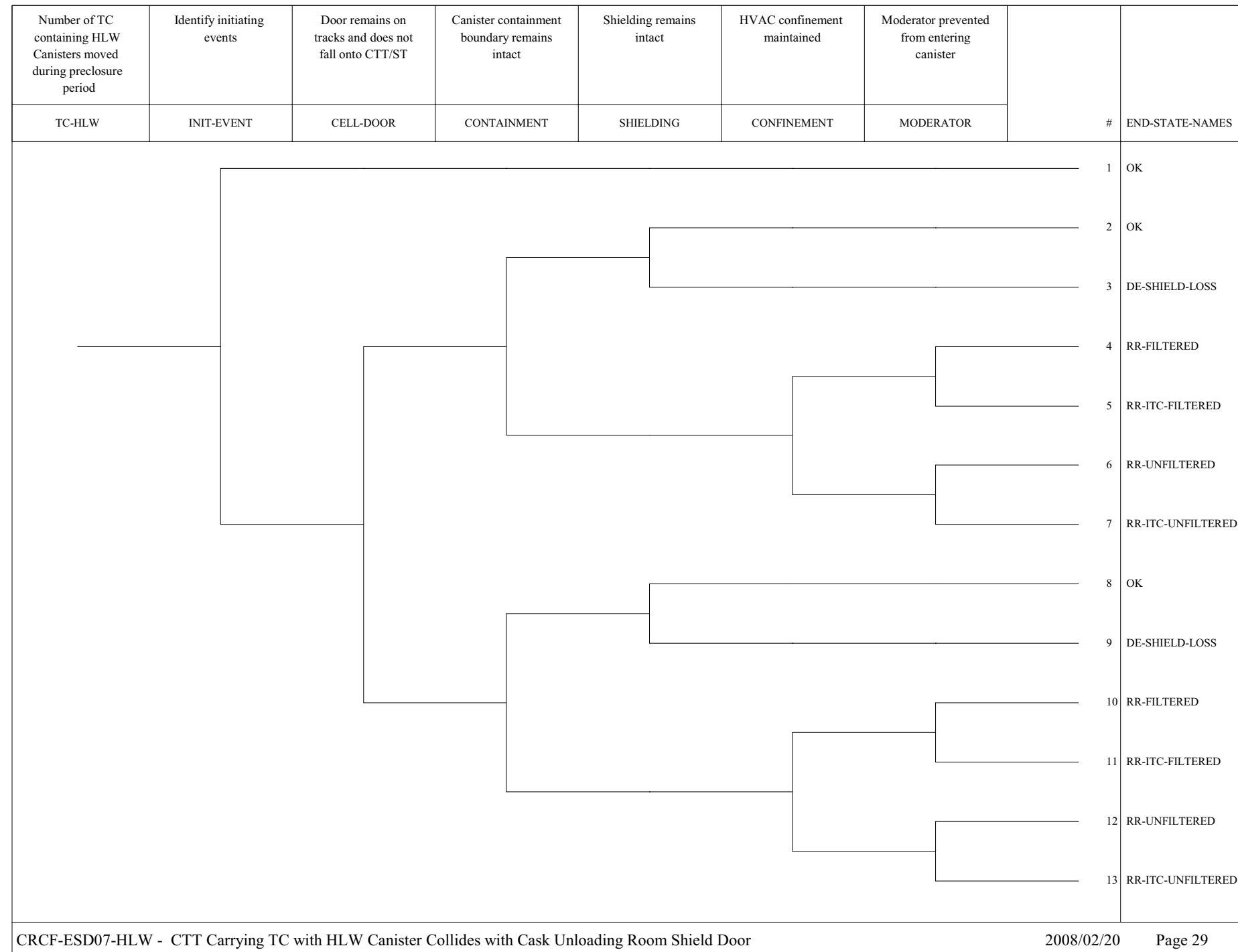

Source: Original

Figure A5-30. Event Tree CRCF-ESD07-HLW – CTT Carrying Transportation Cask with HLW Canister Collides with Cask Unloading Room Shield Door

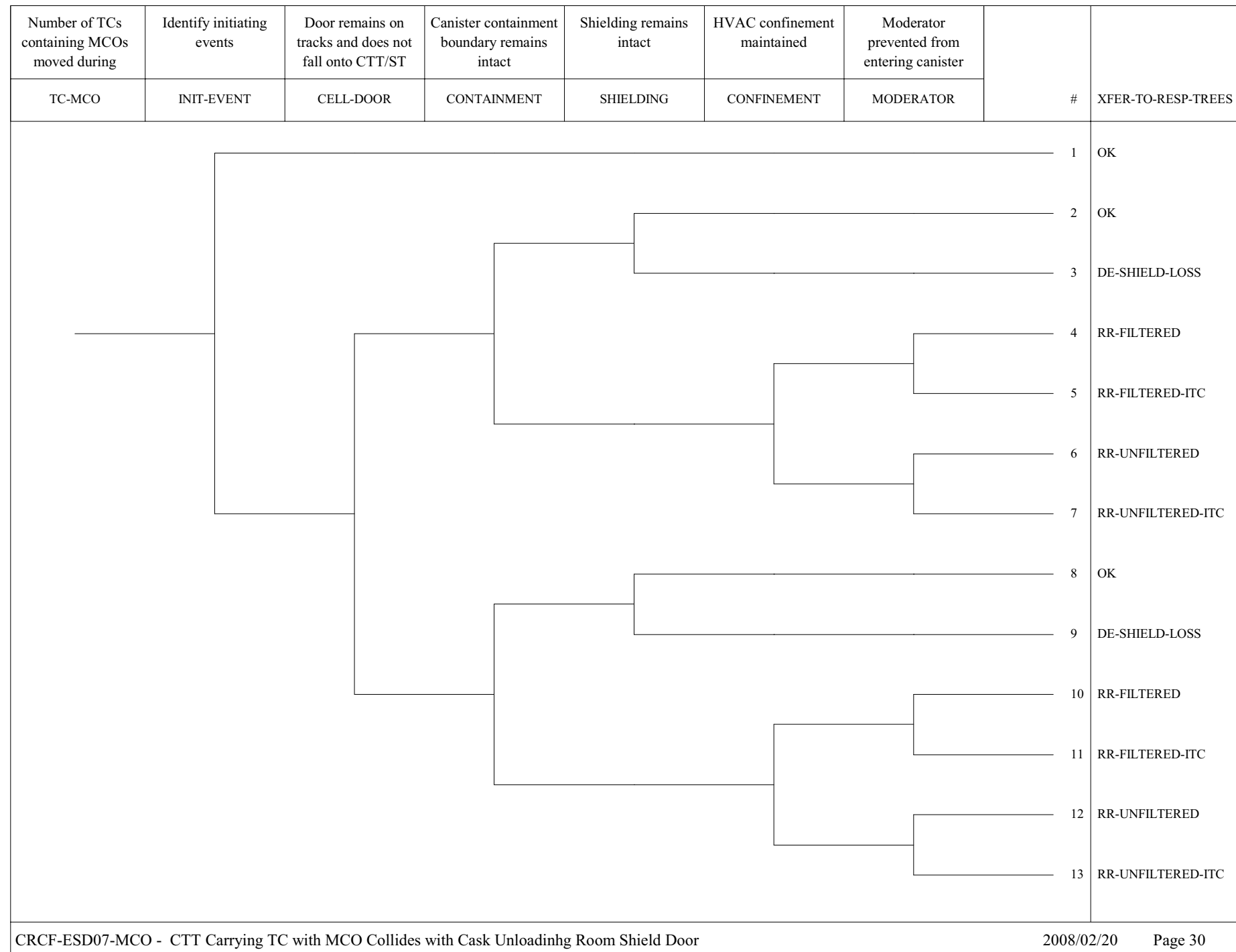

Source: Original

Figure A5-31. Event Tree CRCF-ESD07-MCO – CTT Carrying Transportation Cask with MCO Collides with Cask Unloading Room Shield Door

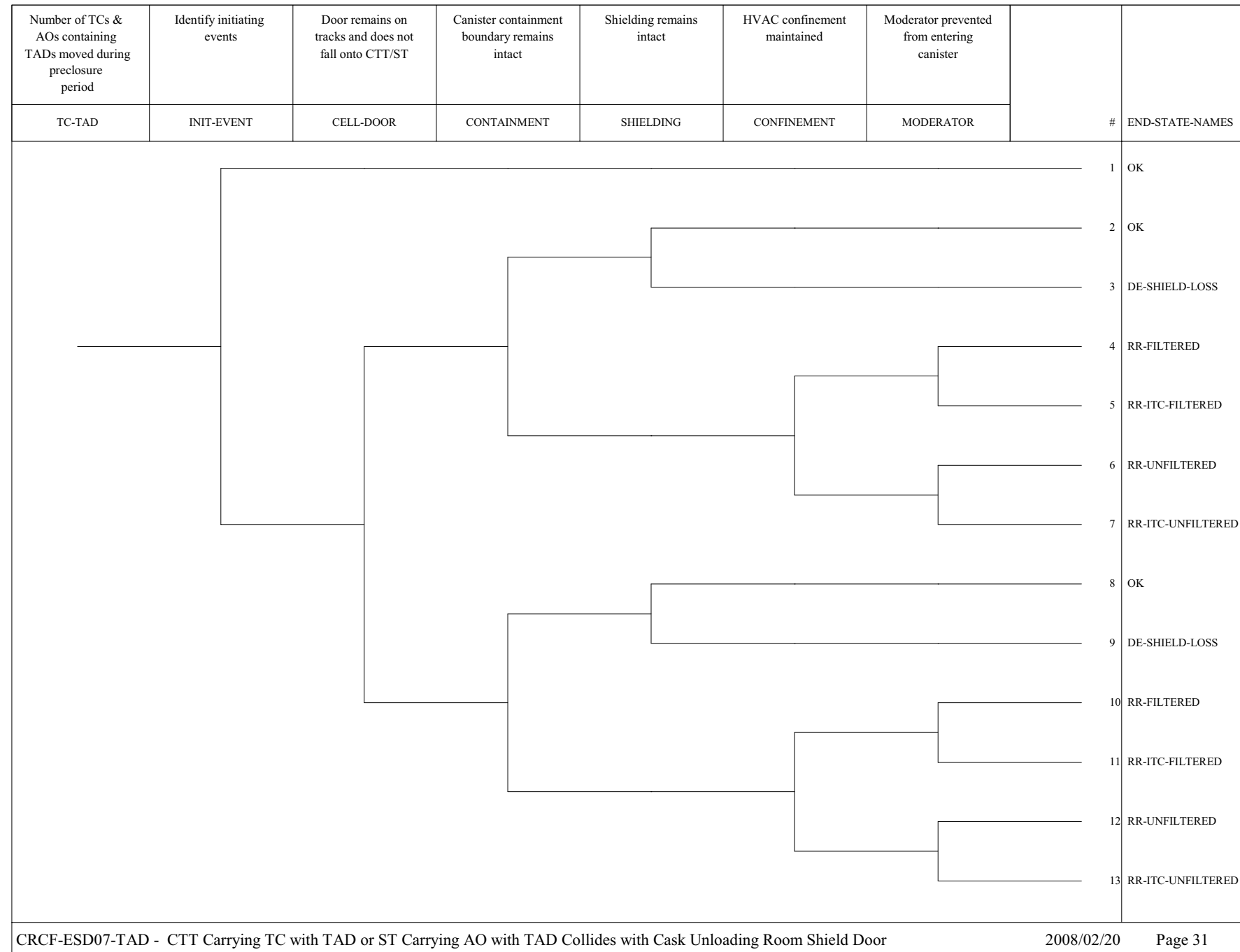

Source: Original

Figure A5-32. Event Tree CRCF-ESD07-TAD – CTT Carrying Transportation Cask with TAD Canister or Site Transporter Carrying Aging Overpack with TAD Canister Collides with Cask Unloading Room Shield Door

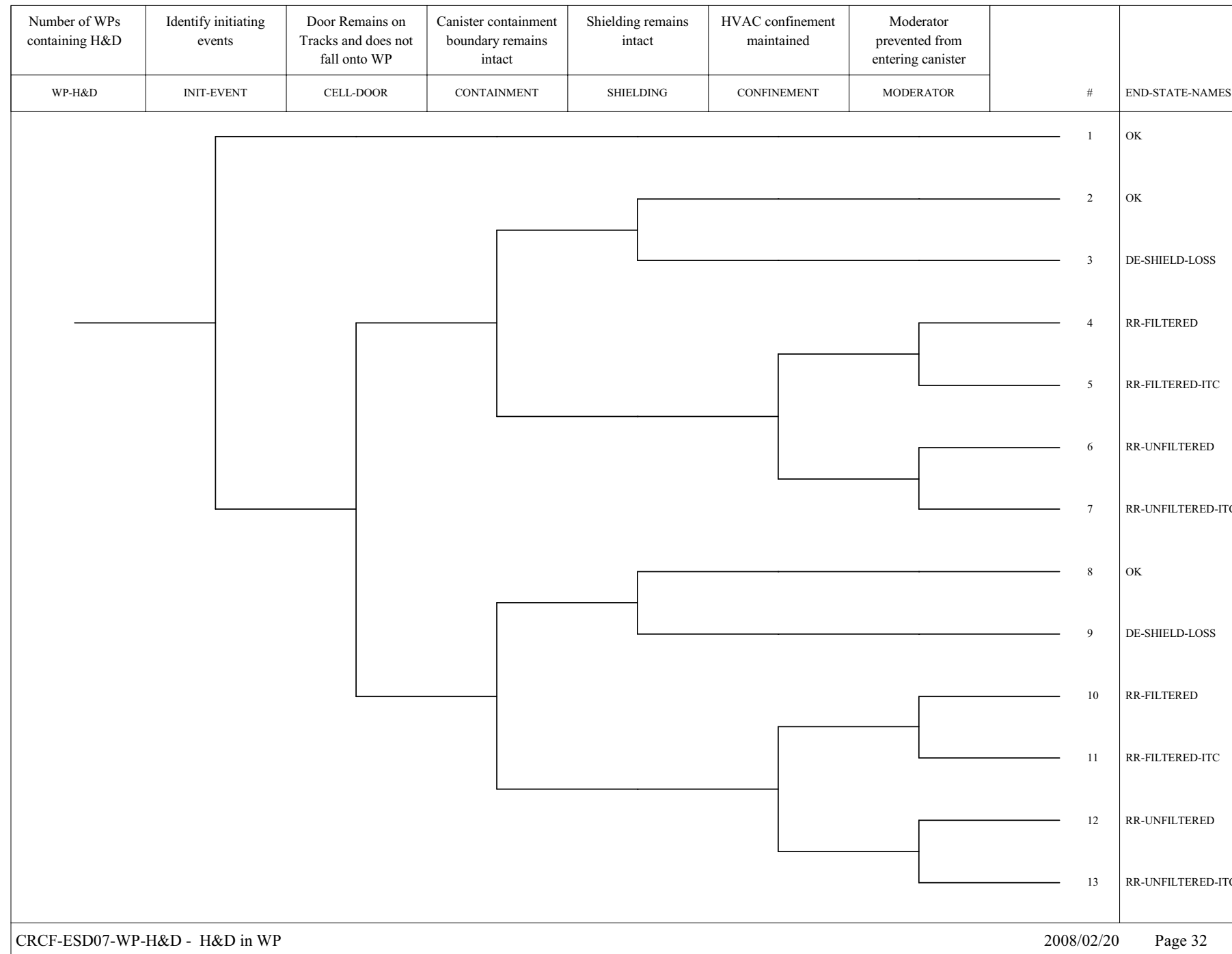

Source: Original

Figure A5-33. Event Tree CRCF-ESD07-WP-H&D – H&D in Waste Package

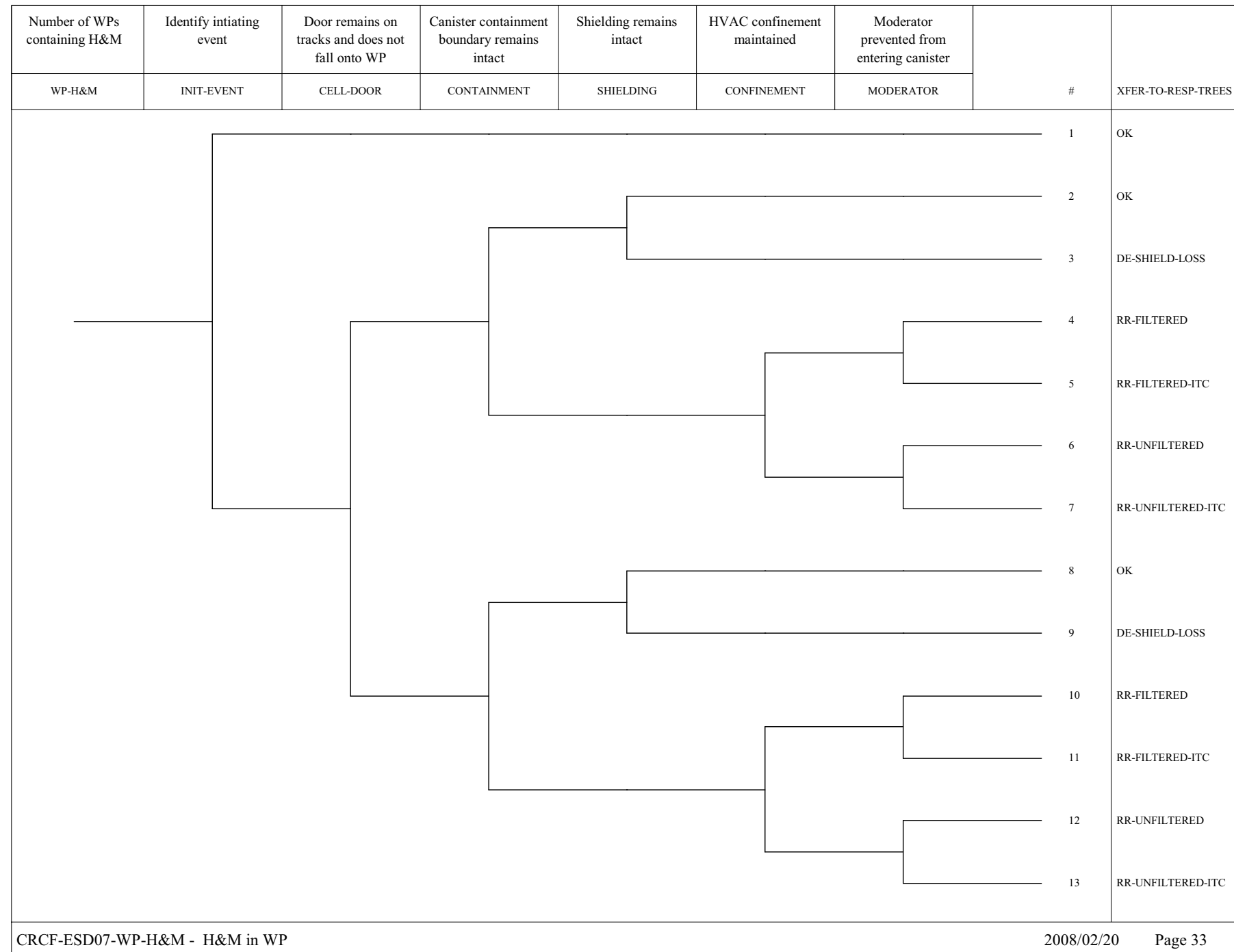

CRCF-ESD07-WP-H&M - H&M in WP

2008/02/20 Page 33

Source: Original

Figure A5-34. Event Tree CRCF-ESD07-WP-H&M – H&M in Waste Package

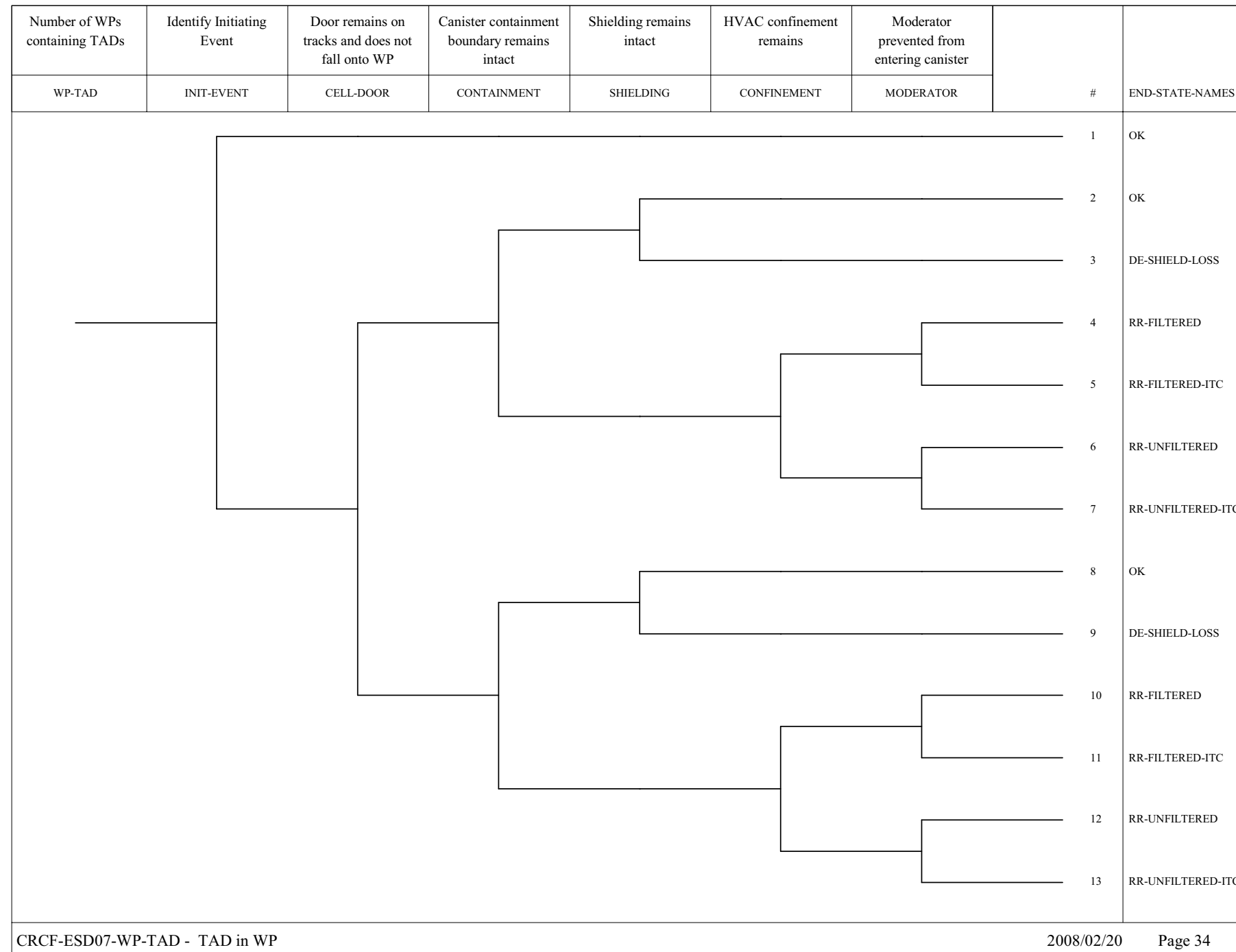

CRCF-ESD07-WP-TAD - TAD in WP

2008/02/20 Page 34

Source: Original

Figure A5-35. Event Tree CRCF-ESD07-WP-TAD – TAD Canister in Waste Package

Number of Std. canisters moved during preclosure period	Mechanical challenge when two CTMs collide		
DSTD	INIT-EVENT	#	XFER-TO-RESP-TREE
<p style="text-align: center;">Collision of Two Loaded CTMs</p>		1	OK
		2 T => 20	RESPONSE-CANISTER1
CRCF-ESD08-DSTD - Collision between 2 CTMs Carrying DSTD			2007/11/06 Page 36

Source: Original

Figure A5-37. Event Tree CRCF-ESD08-DSTD – Collision between 2 CTMs Carrying DOE Std. Canister

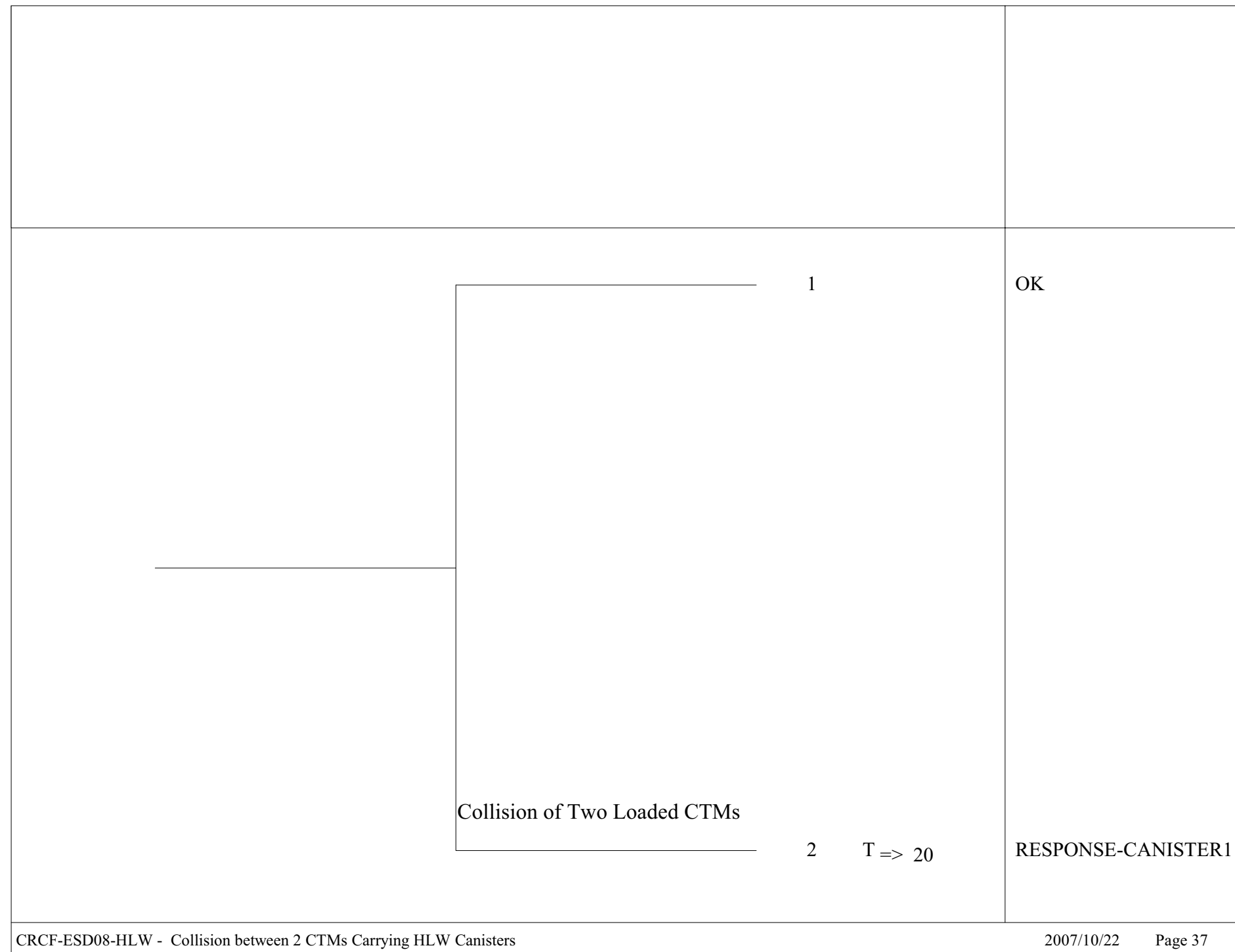

Source: Original

Figure A5-38 Event Tree CRCF-ESD08-HLW –
Collision between 2 CTMs
Carrying HLW Canister

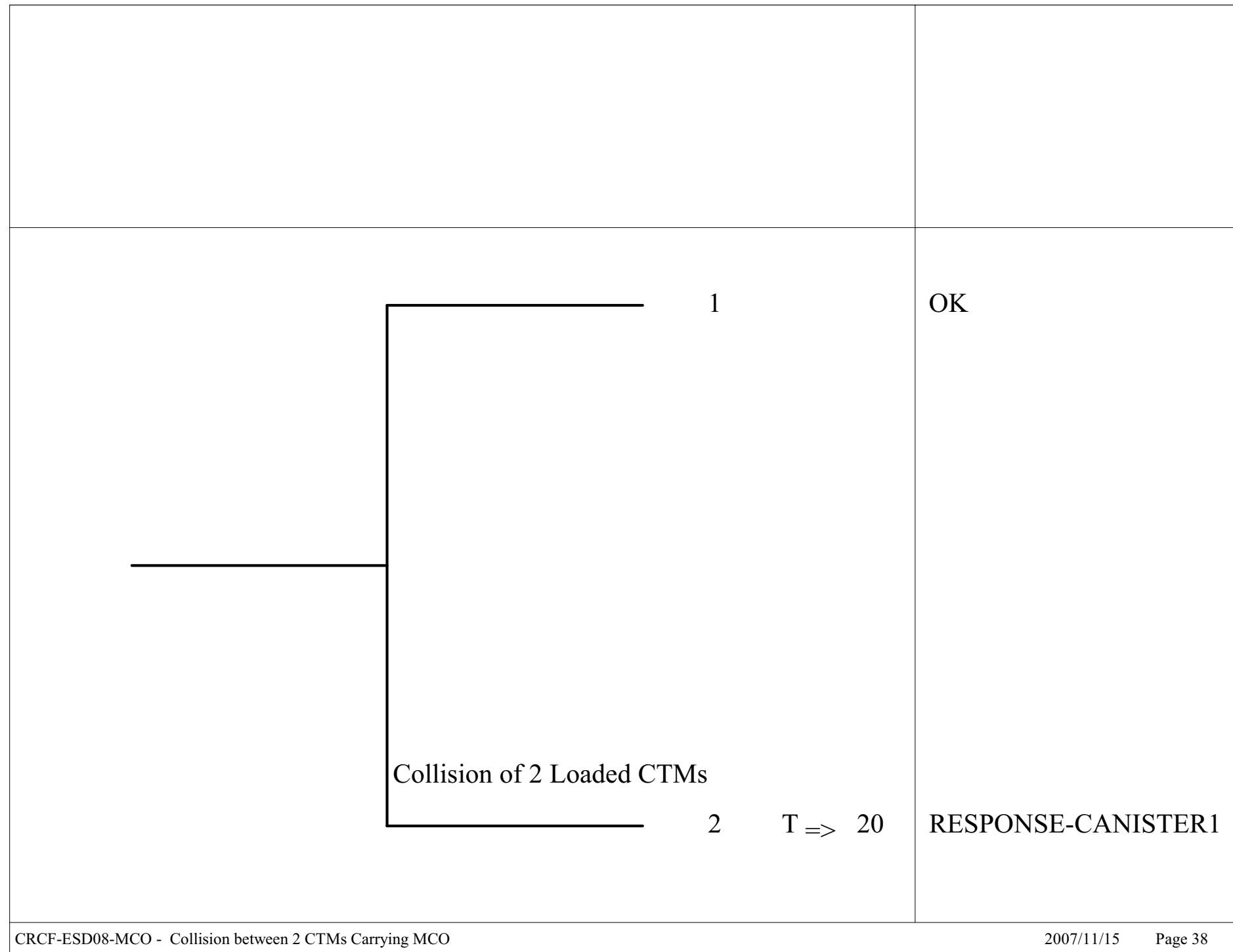

Source: Original

Figure A5-39. Event Tree CRCF-ESD08-MCO – Collision between 2 CTMs Carrying MCO

Number of DPCs moved during preclosure period	Identify initiating events		
DPC	INIT-EVENT	#	XFER-TO-RESP-TREE
	Impact with Lid Removal	1	OK
	Canister Drop at Operational Height	2	T => 20 RESPONSE-CANISTER1
	Spurious Movement	3	T => 20 RESPONSE-CANISTER1
	Side Impact	4	T => 20 RESPONSE-CANISTER1
	Object Dropped on Canister	5	T => 20 RESPONSE-CANISTER1
	Canister dropped inside bell	6	T => 20 RESPONSE-CANISTER1
	Canister Drop >Operational Height	7	T => 20 RESPONSE-CANISTER1
		8	T => 20 RESPONSE-CANISTER1

CRCF-ESD09-DPC - Transferring a DPC with the CTM

2008/02/20 Page 40

Source: Original

Figure A5-41. Event Tree CRCF-ESD09-DPC – Transferring a DPC with the CTM

Number of DOE Std. Canisters moved during preclosure period	Identify initiating events			
DSTD	INIT-EVENT	#		XFER-TO-RESP-TREE
		1		OK
	Impact with Lid Removal	2	T => 20	RESPONSE-CANISTER1
	Canister Drop atOperational Height	3	T => 20	RESPONSE-CANISTER1
	Spurious Movement	4	T => 20	RESPONSE-CANISTER1
	Side Impact	5	T => 20	RESPONSE-CANISTER1
	Object Dropped on Canister	6	T => 20	RESPONSE-CANISTER1
	Canister dropped inside bell	7	T => 20	RESPONSE-CANISTER1
	Canister Drop >Operational Height	8	T => 20	RESPONSE-CANISTER1

CRCF-ESD09-DSTD - Transferring DSTD with the CTM

2007/11/06 Page 41

Source: Original

Figure A5-42. Event Tree CRCF-ESD09-DSTD – Transferring DOE Std. Canister with the CTM

Number of HLW Canisters moved during preclosure period	Identify initiating events			
HLW	INIT-EVENT	#		XFER-TO-RESP-TREE
		1		OK
	Impact with Lid Removal	2	T => 20	RESPONSE-CANISTER1
	Canister Drop atOperational Height	3	T => 20	RESPONSE-CANISTER1
	Spurious Movement	4	T => 20	RESPONSE-CANISTER1
	Side Impact	5	T => 20	RESPONSE-CANISTER1
	Object Dropped on Canister	6	T => 20	RESPONSE-CANISTER1
	Canister dropped inside bell	7	T => 20	RESPONSE-CANISTER1
	Canister Drop >Operational Height	8	T => 20	RESPONSE-CANISTER1

CRCF-ESD09-HLW - Transferring a HLW Canister with the CTM

2008/02/20 Page 42

Source: Original

Figure A5-43. Event Tree CRCF-ESD09-HLW – Transferring a HLW Canister with the CTM

Number of MCOs moved during preclosure period	Identify initiating events		
MCO	INIT-EVENT	#	XFER-TO-RESP-TREES
		1	OK
	Impact with Lid Removal	2	T => 20
	Canister drop atoperational height	3	T => 20
	Spurious Movement	4	T => 20
	Side Impact	5	T => 20
	Object Dropped OnCanister	6	T => 20
	Canister dropped inside bell	7	T => 20
	Canister drop >operational height	8	T => 20
			RESPONSE-CANISTER1

CRCF-ESD09-MCO - Transferring MCO with the CTM

2008/02/20 Page 43

Source: Original

Figure A5-44. Event Tree CRCF-ESD09-MCO – Transferring MCO with the CTM

Number of TADs moved during preclosure period	Identify initiating events		
TAD	INIT-EVENT	#	XFER-TO-RESP-TREE
	Impact with Lid Removal	1	OK
	Canister Drop at Operational Height	2	T => 20 RESPONSE-CANISTER1
	Spurious Movement	3	T => 20 RESPONSE-CANISTER1
	Side Impact	4	T => 20 RESPONSE-CANISTER1
	Object Dropped on Canister	5	T => 20 RESPONSE-CANISTER1
	Canister dropped inside bell	6	T => 20 RESPONSE-CANISTER1
	Canister Drop >Operational Height	7	T => 20 RESPONSE-CANISTER1
		8	T => 20 RESPONSE-CANISTER1

CRCF-ESD09-TAD - Transferring a TAD with the CTM

2007/10/30 Page 44

Source: Original

Figure A5-45. Event Tree CRCF-ESD09-TAD – Transferring a TAD Canister with the CTM

Number of WPs with HLW and DOE SNF Canisters moved during preclosure period	Identify initiating events			
WP-H&D	INIT-EVENT	#	XFER-TO-RESP-TREE	
CRCF-ESD10-WP-H&D - Transfer of WP with HLW and either a DOE Std. Canister or MCO on WPTT from WP Loading Room to WP Positioning R... 2007/11/06 Page 45				

Source: Original

Figure A5-46. Event Tree CRCF-ESD10-WP-H&D – Transfer of Waste Package with HLW and either a DOE Std. Canister or MCO on WPTT from Waste Package Loading Room to Waste Package Positioning Room

	Canister containment remains intact	WP integral shielding and WPTT shielding remain in place	HVAC confinement maintained	Moderator prevented from entering container		
INIT-EVENT	CANISTER	SHIELDING	CONFINEMENT	MODERATOR	#	END-STATE-NAMES
					1	OK
					2	DE-SHIELD-LOSS
					3	RR-FILTERED
					4	RR-FILTERED-ITC
					5	RR-UNFILTERED
					6	RR-UNFILTERED-ITC
RESPONSE-WP1 - Response to Structural Challenges to WP Prior to Closure of WP					2008/02/12	Page 62

Source: Original

Figure A5-47. Event Tree RESPONSE-WP1 – Response to Structural Challenges to Waste Package Prior to Closure of Waste Package

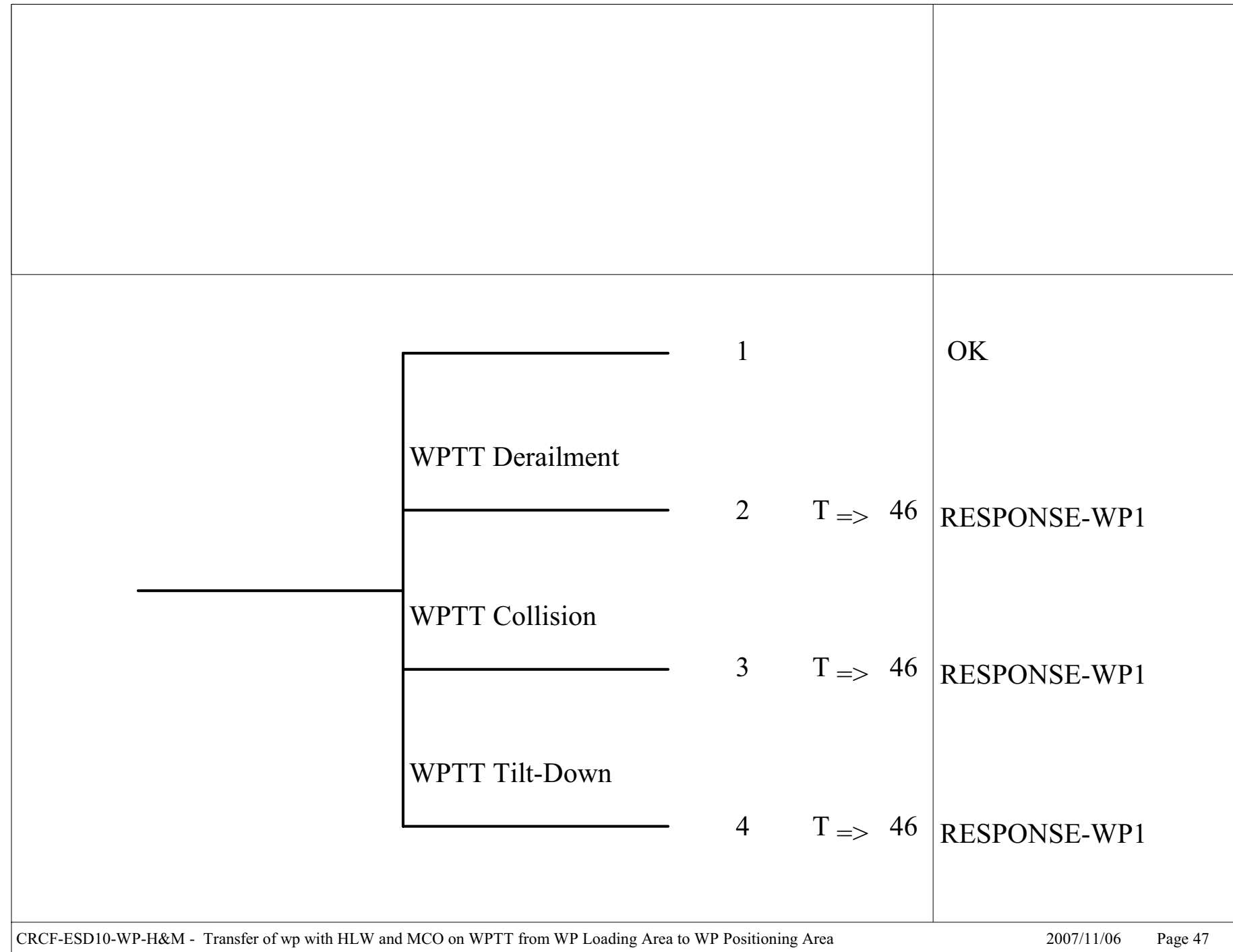

Source: Original

Figure A5-48. Event Tree CRCF-ESD10-WP-H&M – Transfer of Waste Package with HLW and MCO on WPTT from Waste Package Loading Room to Waste Package Positioning Room

Number of WPs with TADs moved during preclosure period	Identify initiating events			
WP-TAD	INIT-EVENT	#		XFER-TO-RESP-TREE
		1		OK
	WPTT derailment	2	T =>	46 RESPONSE-WP1
	WPTT collision	3	T =>	46 RESPONSE-WP1
	WPTT tilt-down	4	T =>	46 RESPONSE-WP1

CRCF-ESD10-WP-TAD - Transfer of WP with TAD on WPTT from WP Loading Room to WP Positioning Room

2007/12/15 Page 48

Source: Original

Figure A5-49. Event Tree CRCF-ESD10-WP-TAD – Transfer of Waste Package with TAD Canister on WPTT from Waste Package Loading Room to Waste Package Positioning Room

Number of WPs with HLW & Std. Canisters and WPs with HLWs and MCOs processed during preclosure period	Identify initiating events		
WP-H&D	INIT-EVENT	#	XFER-TO-RESP-TREE
		<p>1</p> <p>2 T => 46</p> <p>3 T => 46</p>	<p>OK</p> <p>RESPONSE-WP1</p> <p>RESPONSE-WP1</p>
CRCF-ESD11-WP-H&D - Assembly and Closure of WP with HLW and either a DOE Std. Canister or MCO			2007/11/19 Page 49

Source: Original

Figure A5-50. Event Tree CRCF-ESD11-WP-H&D – Assembly and Closure of Waste Package with HLW and either a DOE Std. Canister or MCO

Number of WPs with HLW & MCOs processed during preclosure period	Identify initiating events		
WP-H&M	INIT-EVENT	#	XFER-TO-RESP-TREES
		<p>1</p> <p>2</p> <p>3</p>	<p>OK</p> <p>T => 46 RESPONSE-WP1</p> <p>T => 46 RESPONSE-WP1</p>
CRCF-ESD11-WP-H&M - Assembly & Closure of WP with HLW and MCO		2007/11/19 Page 50	

Source: Original

Figure A5-51. Event Tree CRCF-ESD11-WP-H&M – Assembly and Closure of Waste Package with HLW and MCO

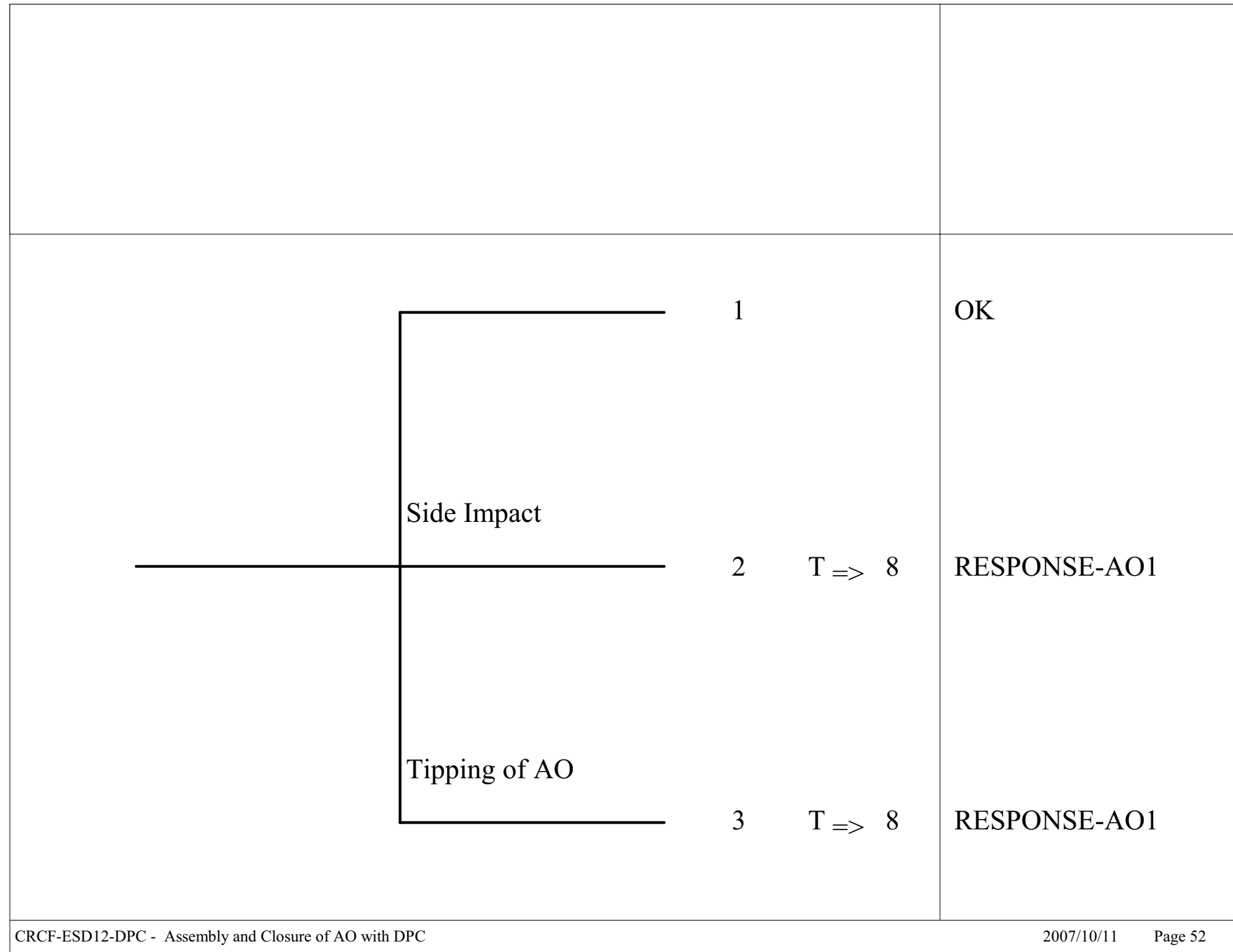

Source: Original

Figure A5-53. Event Tree CRCF-ESD12-DPC – Assembly and Closure of Aging Overpack with DPC

Number of TADs in AOs outgoing	Identify initiating events		
AO-TAD-OUT	INIT-EVENT	#	XFER-TO-RESP-TREE
		<p>1</p> <p>2 T => 8</p> <p>3 T => 8</p>	<p>OK</p> <p>RESPONSE-AO1</p> <p>RESPONSE-AO1</p>
CRCF-ESD12-TAD - Assembly and Closure of AO with TAD			2007/10/30 Page 53

Source: Original

Figure A5-54. Event Tree CRCF-ESD12-TAD –
Assembly and Closure of Aging
Overpack with TAD Canister

Number of WPs with HLW & DOE Std. Canisters moved during preclosure period	Identify initiating events			
WP-H&D	INIT-EVENT	#	XFER-TO-RESP-TREE	
		1	OK	
	WPTT derailment	2	T => 55	RESPONSE-WP2
	Side impact	3	T => 55	RESPONSE-WP2
	WPTT tilt-down	4	T => 55	RESPONSE-WP2
CRCF-ESD13-WP-H&D - Transfer of WP with HLW and either a DOE Std. Canister or MCO on WPTT from WP Positioning Room to WP Loadout R... 2007/11/06 Page 54				

Source: Original

Figure A5-55. Event Tree CRCF-ESD13-WP- H&D – Transfer of Waste Package with HLW and either a DOE Std. Canister or MCO on WPTT from Waste Package Positioning Room to Waste Package Loadout Room

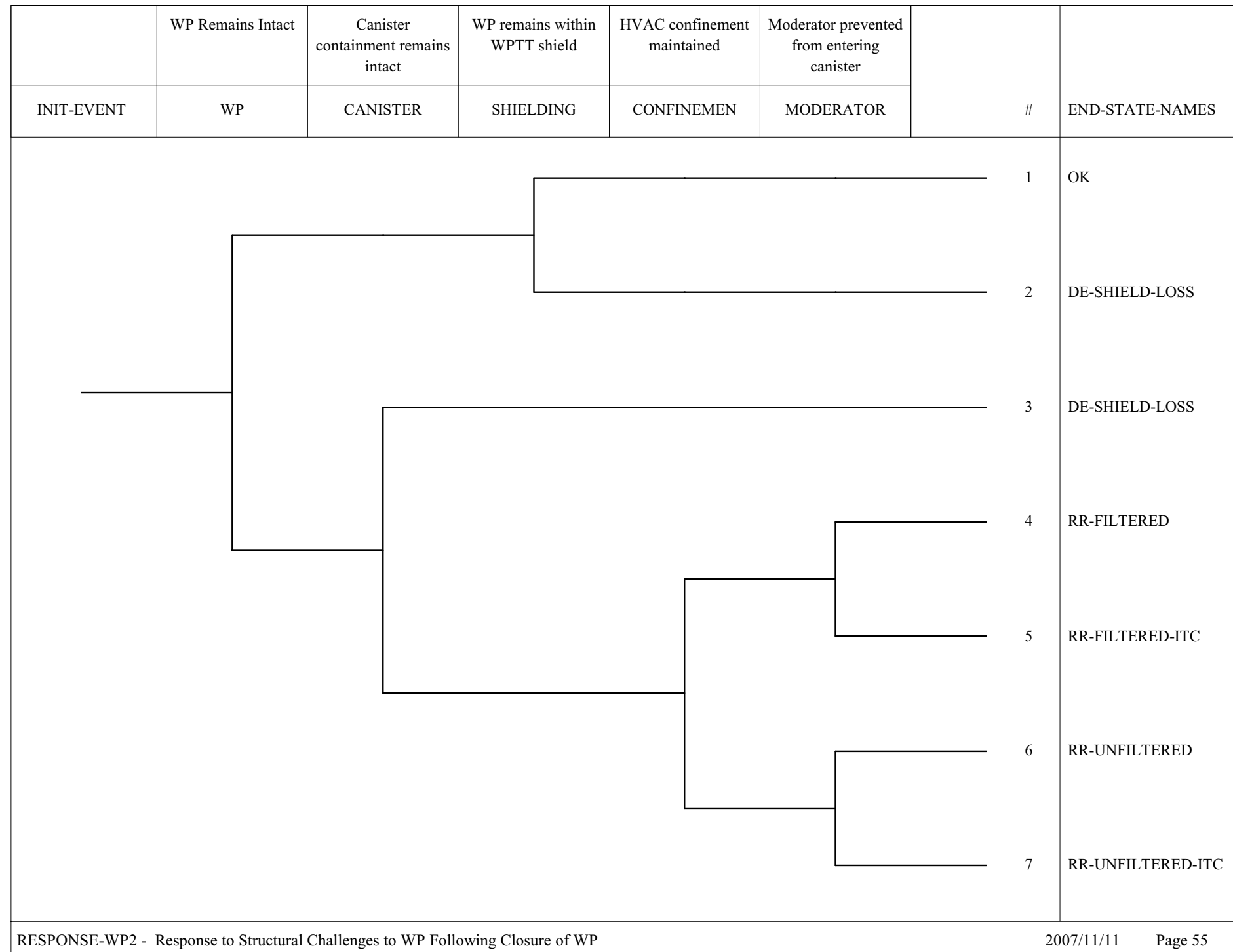

Source: Original

Figure A5-56. Event Tree RESPONSE-WP2 – Response to Structural Challenge to Waste Package Following Closure of Waste Package

Number of WPs with HLW & MCO moved during preclosure period	Identify initiating events			
WP-H&M	INIT-EVENT	#		XFER-TO-RESP-TREES
<p>CRCF-ESD13-WP-H&M - Transfer of WP with HLW and MCO on WPTT from WP Positioning Area to WP Loadout Room 2007/12/15 Page 56</p>				

Source: Original

Figure A5-57. Event Tree CRCF-ESD13-WP-H&M – Transfer of Waste Package with HLW and MCO on WPTT from Waste Package Positioning Room to Waste Package Loadout Room

Number of WPs with TADs processed during preclosure period	Identify initiating events			
WP-TAD	INIT-EVENT	#		XFER-TO-RESP-TREE
<p>CRCF-ESD13-WP-TAD - Transfer of WP with TAD on WPTT from WP Positioning Room to WP Loadout Room 2007/11/13 Page 57</p>				

Source: Original

Figure A5-58. Event Tree CRCF-ESD13-WP-TAD – Transfer of Waste Package with TAD Canister on WPTT from Waste Package Positioning Room to Waste Package Loadout Room

Number of DPCs moved during preclosure period	Identify initiating events		
DPC	INIT-EVENT	#	XFER-TO-RESP-TREE
		1	OK
	ST Collision	2	T => 8
	AO Impact	3	T => 8
CRCF-ESD14-DPC - Transfer of AO with DPC on ST from Cask Unloading Room to Cask Preparation Room		2007/11/06	Page 58

Source: Original

Figure A5-59. Event Tree CRCF-ESD14-DPC – Transfer of Aging Overpack with DPC on Site Transporter from Cask Unloading Room to Cask Preparation Room

Number of TADs in AOs outgoing	Identify initiating events		
AO-TAD-OUT	INIT-EVENT	#	XFER-TO-RESP-TREE
		1	OK
	ST Collision	2	T => 8
	AO Impact	3	T => 8
CRCF-ESD14-TAD - Transfer of AO with TAD on ST from Cask Unloading Room to Cask Preparation Room		2007/10/30	Page 59

Source: Original

Figure A5-60. Event Tree CRCF-ESD14-TAD – Transfer of Aging Overpack with TAD Canister on Site Transporter from Cask Unloading Room to Cask Preparation Room

Number of WPs with HLW & DOE Std. Canisters moved during preclosure period	Identify initiating events		
WP-H&D	INIT-EVENT	#	XFER-TO-RESP-TREE
		1	OK
	TEV Collision	2	T => 55 RESPONSE-WP2
	Object drop onto WP	3	T => 55 RESPONSE-WP2
	Crane interference	4	T => 55 RESPONSE-WP2
	WPTT/WPTC Malfunction	5	T => 55 RESPONSE-WP2
CRCF-ESD15-WP-H&D - Export WP with HLW and either a DOE Std. Canister or MCO from CRCF			2007/11/06 Page 60

Source: Original

Figure A5-61. Event Tree CRCF-ESD15-WP-H&D – Export Waste Package with HLW and either a DOE Std. Canister or MCO from CRCF

Number of WPs with MCOs moved during preclosure period	identify initiating events			
WP-H&M	INIT-EVENT	#		XFER-TO-RESP-TREES
		1		OK
		2	T => 55	RESPONSE-WP2
		3	T => 55	RESPONSE-WP2
		4	T => 55	RESPONSE-WP2
		5	T => 55	RESPONSE-WP2

CRCF-ESD15-WP-H&M - Export WP with HLW and MCO from CRCF

2007/11/06 Page 61

Source: Original

Figure A5-62. Event Tree CRCF-ESD15-WP-H&M – Export Waste Package with HLW and MCO from CRCF

Number of WPs with TADs moved during preclosure period	Identify initiating events			
WP-TAD	INIT-EVENT	#		XFER-TO-RESP-TREE
		1		OK
	TEV Collision	2	T => 55	RESPONSE-WP2
	Object drop onto WP	3	T => 55	RESPONSE-WP2
	Crane interference	4	T => 55	RESPONSE-WP2
	WPTT/WPTC Malfunction	5	T => 55	RESPONSE-WP2

CRCF-ESD15-WP-TAD - Export WP with TAD from CRCF 2007/10/30 Page 62

Source: Original

Figure A5-63. Event Tree CRCF-ESD15-WP-TAD – Export Waste Package with TAD Canister from CRCF

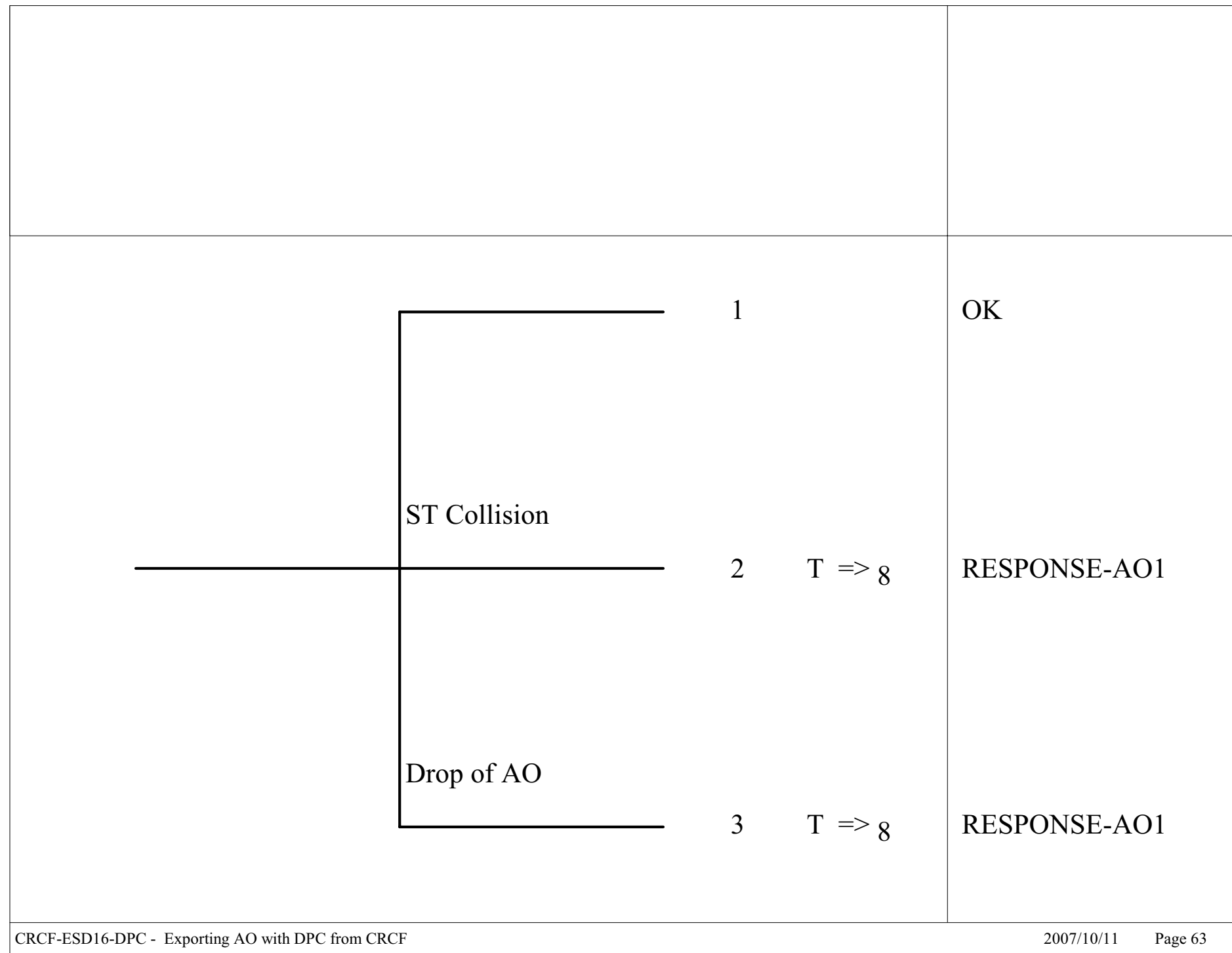

Source: Original

Figure A5-64. Event Tree CRCF-ESD16-DPC – Exporting Aging Overpack with DPC from CRCF

Number of TADs exported	Identify initiating events		
AO-TAD-OUT	INIT-EVENT	#	XFER-TO-RESP-TREE
		1	OK
		2	T => 8 RESPONSE-AO1
		3	T => 8 RESPONSE-AO1
CRCF-ESD16-TAD - Exporting AO with TAD from CRCF		2007/10/30 Page 64	

Source: Original

Figure A5-65. Event Tree CRCF-ESD16-TAD – Exporting Aging Overpack with TAD Canister from CRCF

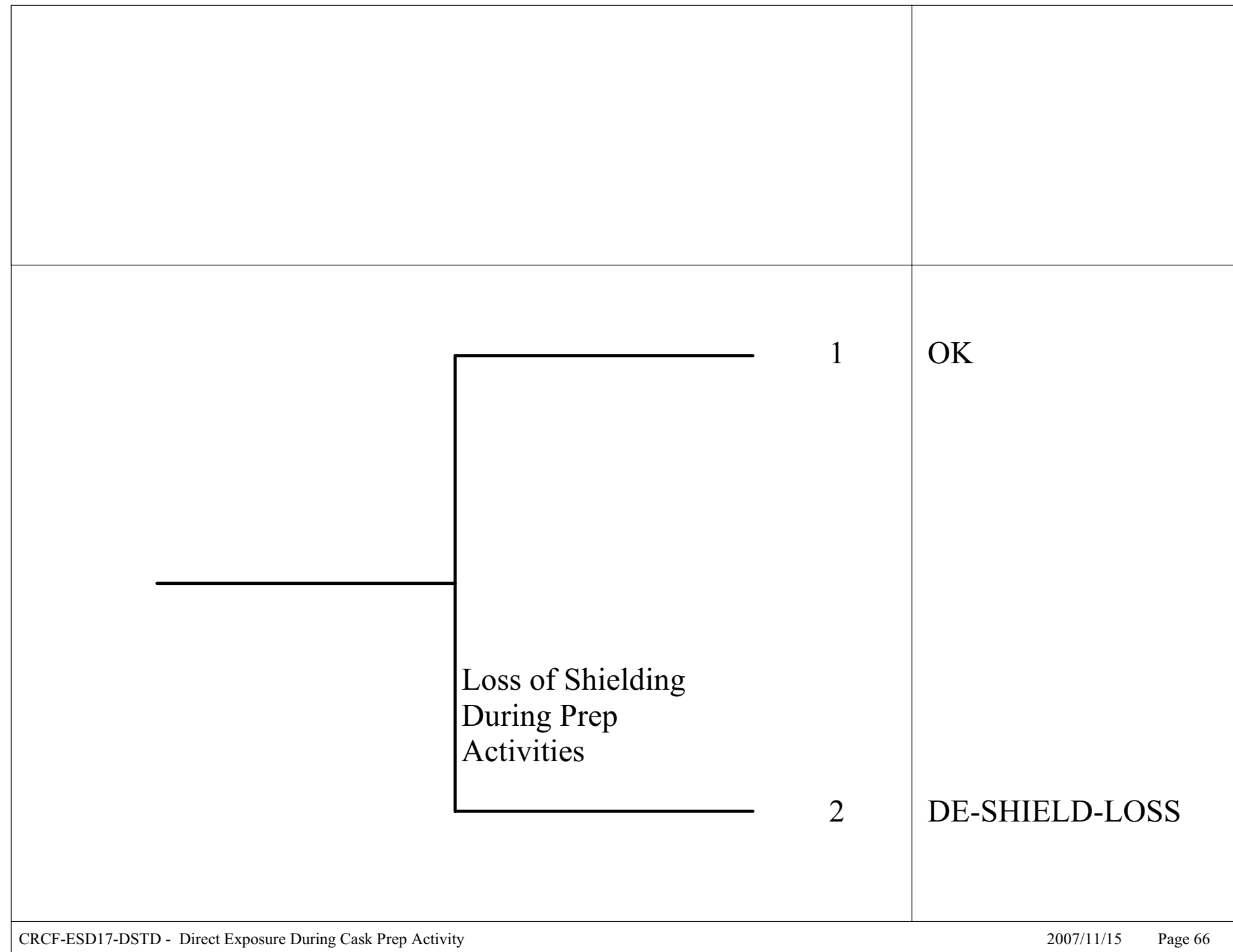

Source: Original

Figure A5-67. Event Tree CRCF-ESD17-DSTD
– Direct Exposure During Cask
Preparation Activities

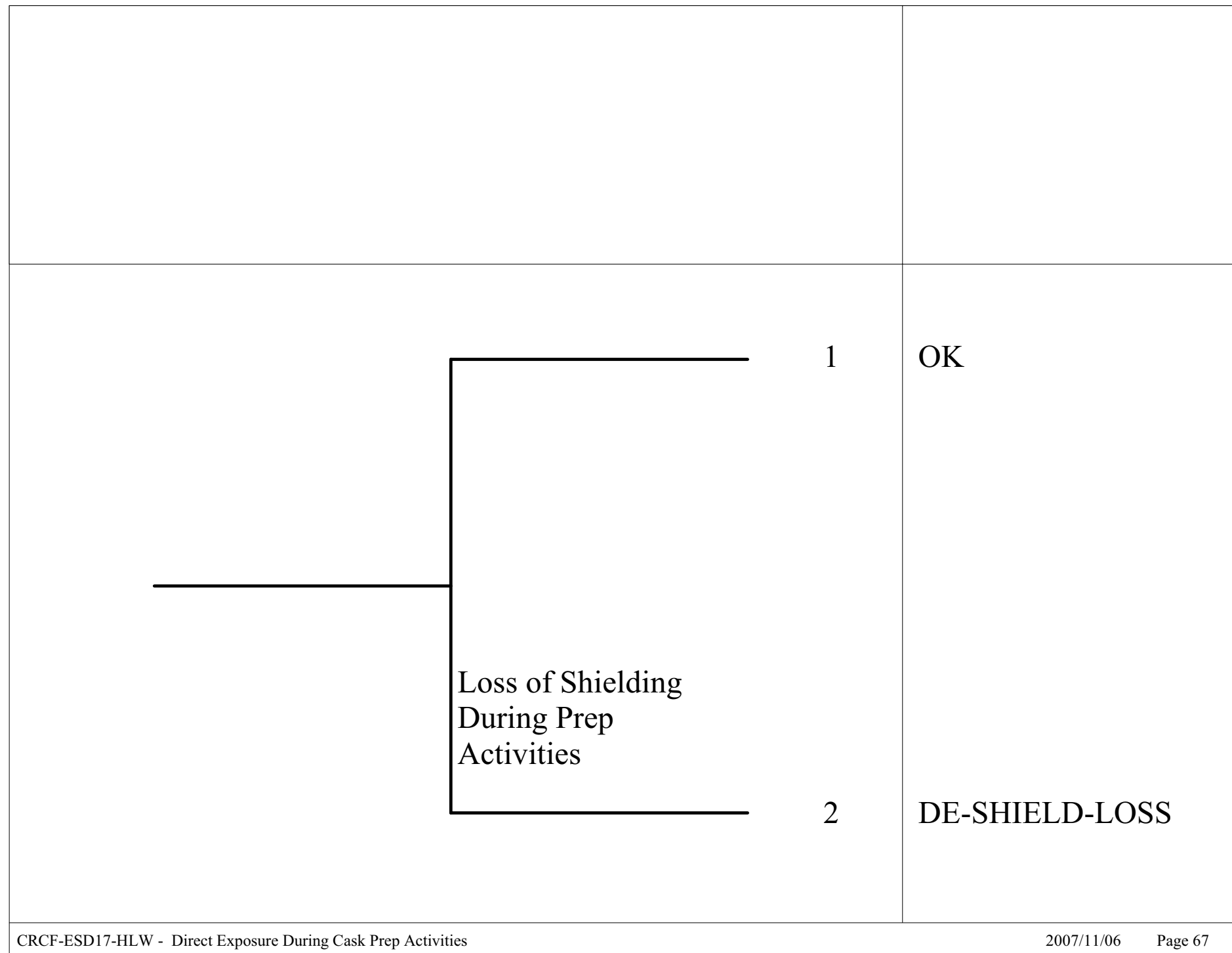

Source: Original

Figure A5-68. Event Tree CRCF-ESD17-HLW – Direct Exposure During Cask Preparation Activities

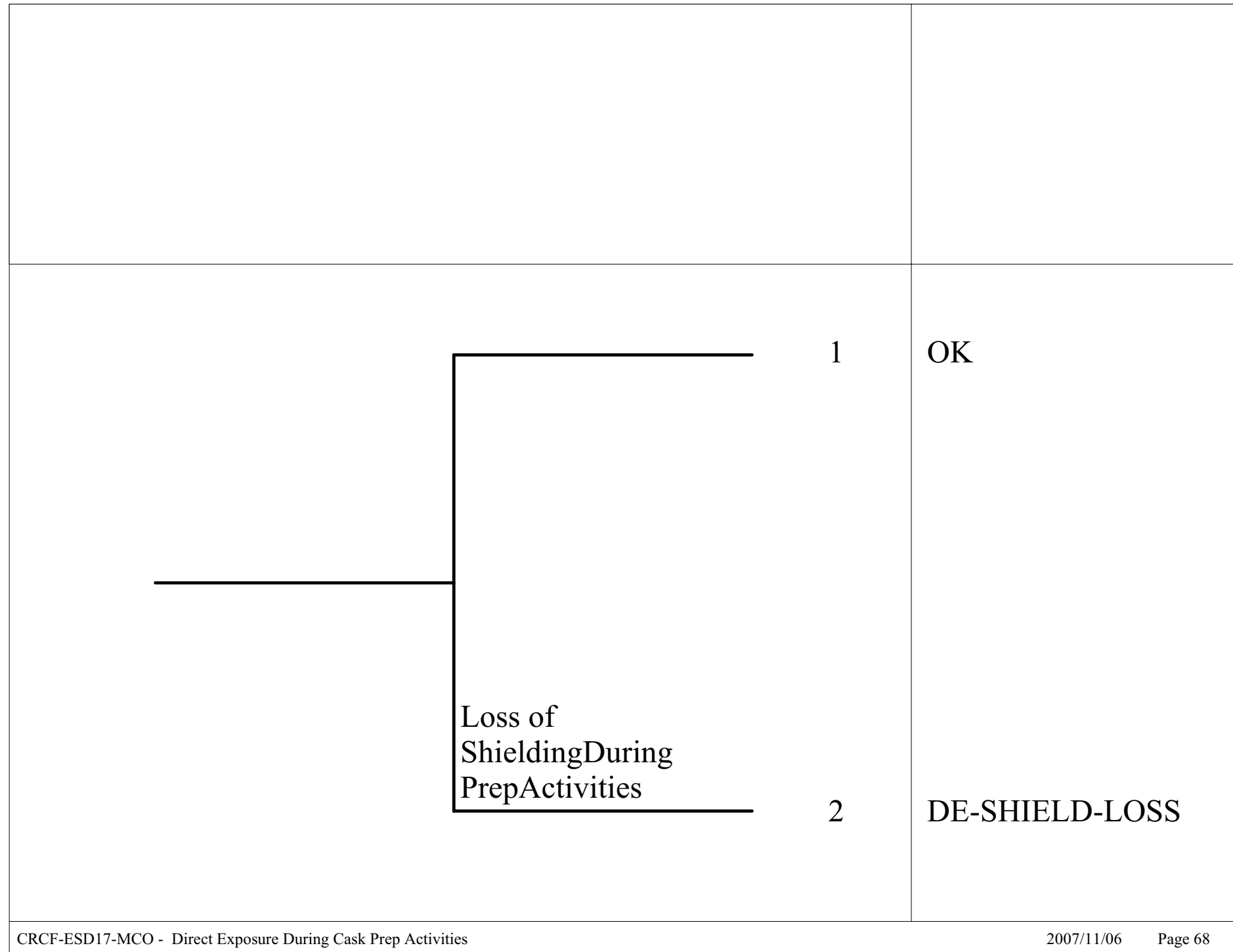

Source: Original

Figure A5-69. Event Tree CRCF-ESD17-MCO – Direct Exposure During Cask Preparation Activities

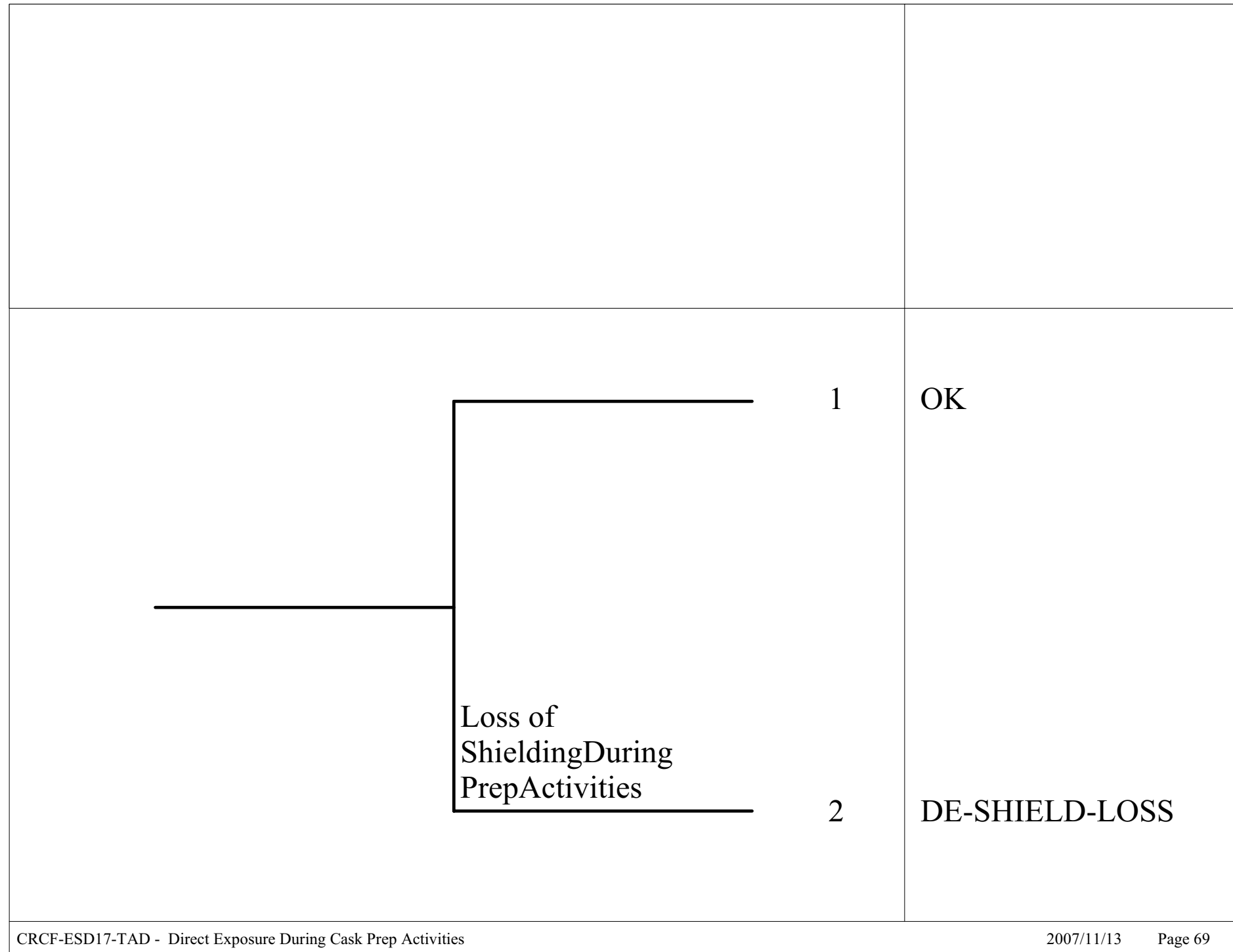

Source: Original

Figure A5-70. Event Tree CRCF-ESD17-TAD – Direct Exposure During Cask Preparation Activities

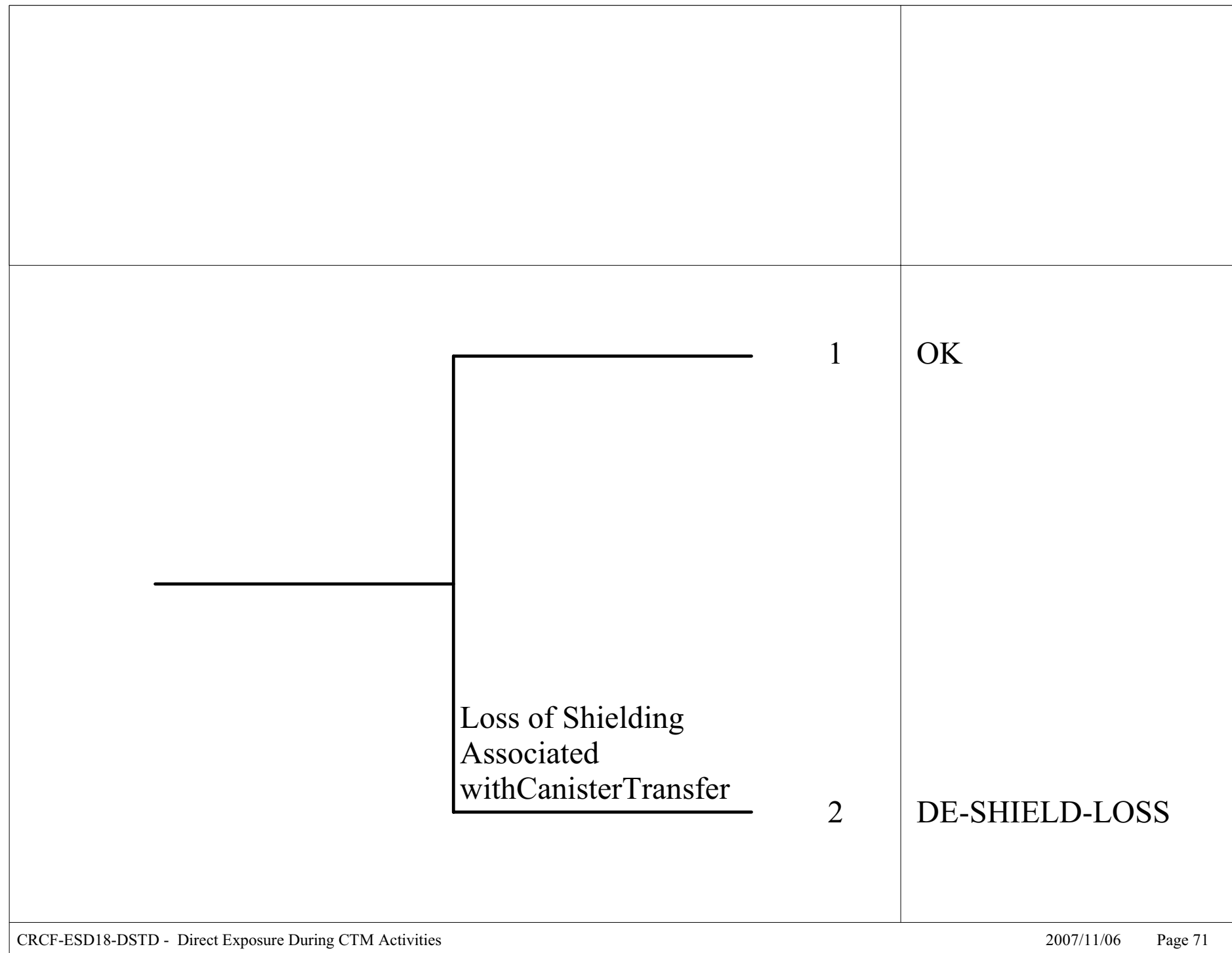

Source: Original

Figure A5-72. Event Tree CRCF-ESD18-DSTD –
Direct Exposure During CTM
Activities

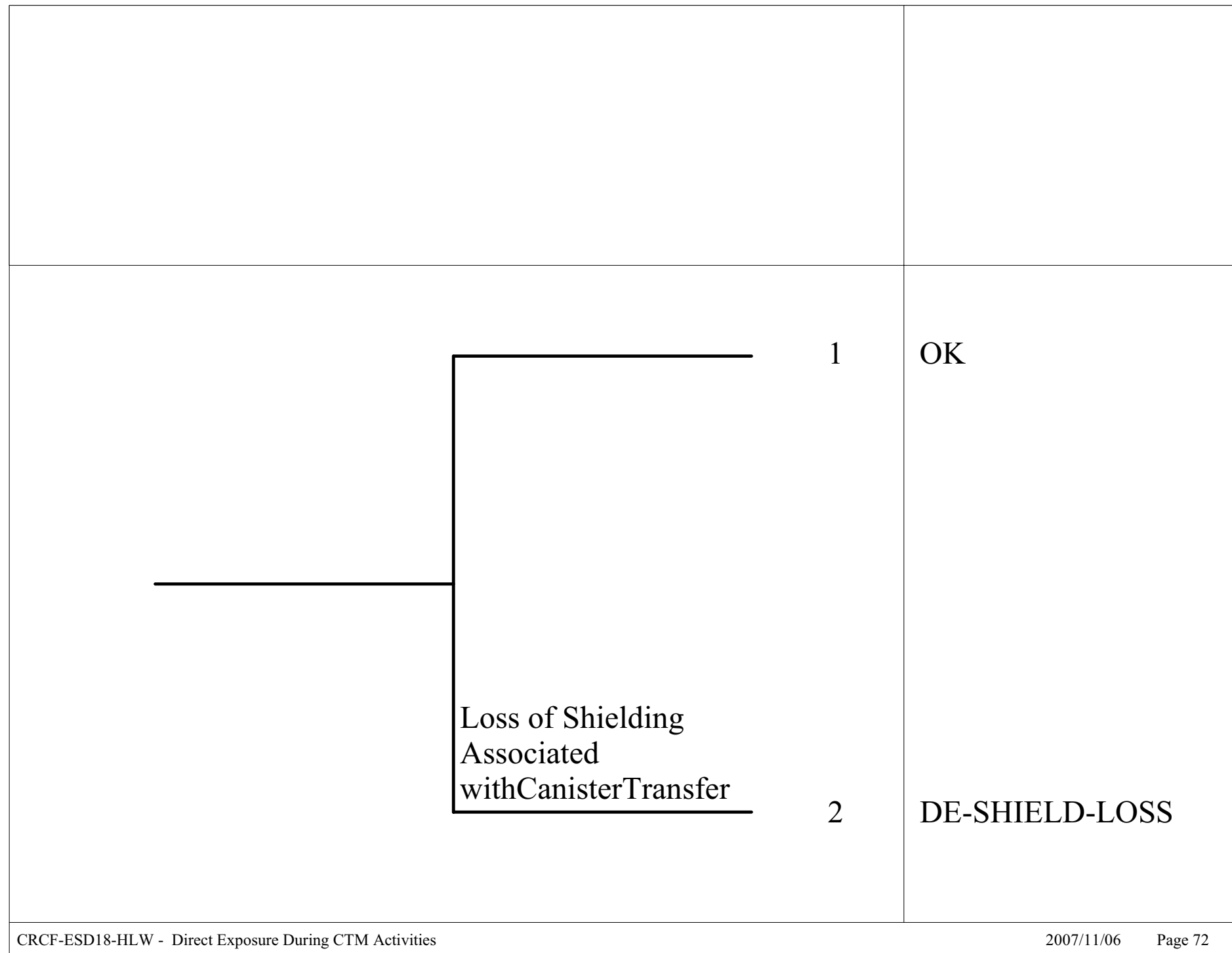

Source: Original

Figure A5-73. Event Tree CRCF-ESD18-HLW
– Direct Exposure During CTM
Activities

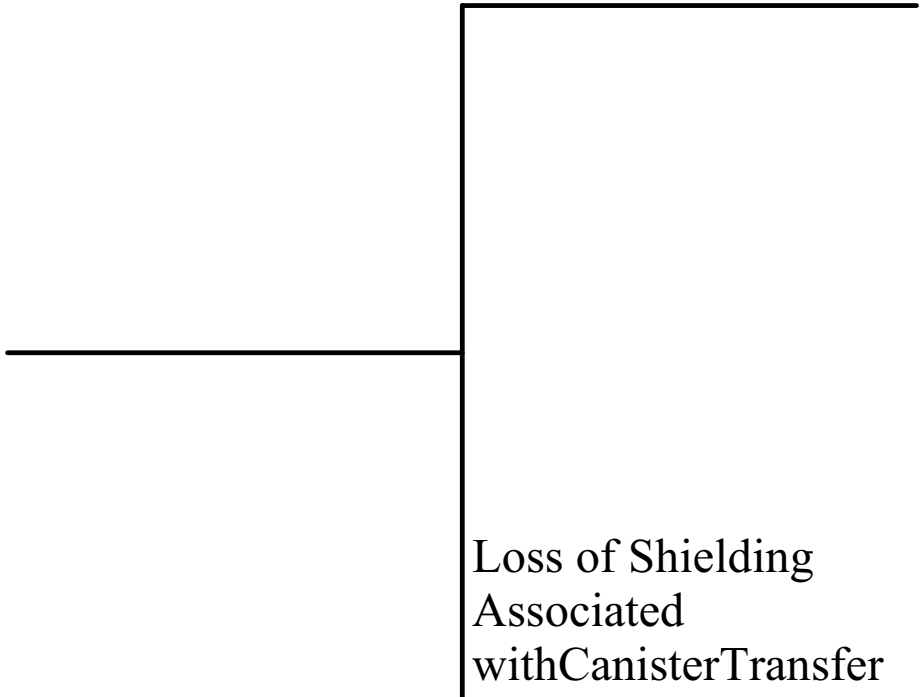
Number of MCOs moved during preclosure period	Identify initiating event		
MCO	INIT-EVENT	#	END-STATE-NAMES
		<p>1</p> <p>2</p>	<p>OK</p> <p>DE-SHIELD-LOSS</p>
CRCF-ESD18-MCO - Direct Exposure During CTM Activities		2007/11/06 Page 73	

Source: Original

Figure A5-74. Event Tree CRCF-ESD18-MCO – Direct Exposure During CTM Activities

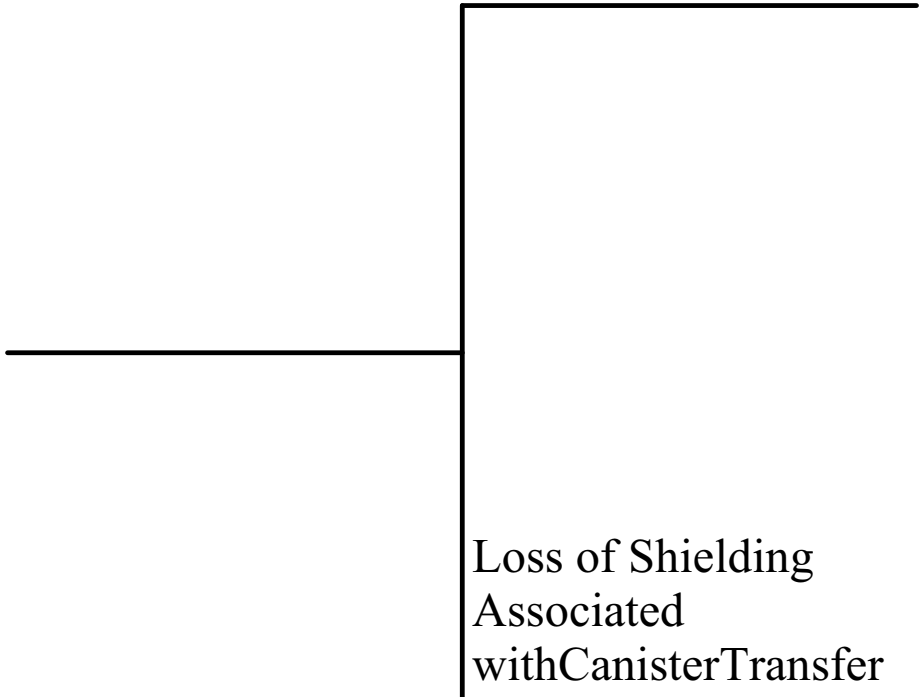
Number of TADs moved during preclosure period	Identify initiating event		
TAD	INIT-EVENT	#	END-STATE-NAMES
		<p>1</p> <p>2</p>	<p>OK</p> <p>DE-SHIELD-LOSS</p>
CRCF-ESD18-TAD - Direct Exposure During CTM Activities		2007/11/06 Page 74	

Source: Original

Figure A5-75. Event Tree CRCF-ESD18-TAD – Direct Exposure During CTM Activities

Number of WPs with HLW & DOE Std. Canisters,moved during preclosure period	Temporary loss of shielding		
WP-H&D	INIT-EVENT	#	END-STATE-NAMES
		1	OK
		2	DE-SHIELD-LOSS
		3	DE-SHIELD-LOSS

CRCF-ESD19-WP-H&D - Direct Exposure During WP Closure Activities

2008/02/20 Page 75

Source: Original

Figure A5-76. Event Tree CRCF-ESD19-WP-H&D – Direct Exposure During Waste Package Closure Activities

Number of WPs with HLW & MCOs moved during	Identify initiating event		
WP-H&M	INIT-EVENT	#	END-STATE-NAMES
			<p>OK</p> <p>DE-SHIELD-LOSS</p> <p>DE-SHIELD-LOSS</p>
<p>CRCF-ESD19-WP-H&M - Direct Exposure During WP Closure Activities</p>			<p>2007/11/06 Page 76</p>

Source: Original

Figure A5-77. Event Tree CRCF-ESD19-WP-H&M – Direct Exposure During Waste Package Closure Activities

Number of WPs with TADs moved during preclosure period	Identify initiating event		
WP-TAD	INIT-EVENT	#	END-STATE-NAMES
		1	OK
	Shield Ring Misplaced	2	DE-SHIELD-LOSS
	Facility Door Inadvert Open	3	DE-SHIELD-LOSS
CRCF-ESD19-WP-TAD - Direct Exposure During WP Closure Activities		2008/02/20	Page 77

Source: Original

Figure A5-78. Event Tree CRCF-ESD19 WP TAD – Direct Exposure During Waste Package Closure Activities

Number of DPCs processed during preclosure period	Identify Initiating Events		
DPC	INIT-EVENT	#	XFER-TO-RESP-TREE
		1	OK
	Local Fire in Cask Unload Room	2	T => 79
	Local Fire in Cask Prep Area	3	T => 79
	Local Fire Threatens Canister in CTM	4	T => 79
	Large Fire in CRCF	5	T => 79

CRCF-ESD20-DPC - Fire Occurring in the CRCF Involving DPCs

2007/12/17 Page 78

Source: Original

Figure A5-79. Event Tree CRCF-ESD20-DPC – Fire Occurring in the CRCF Involving DPCs

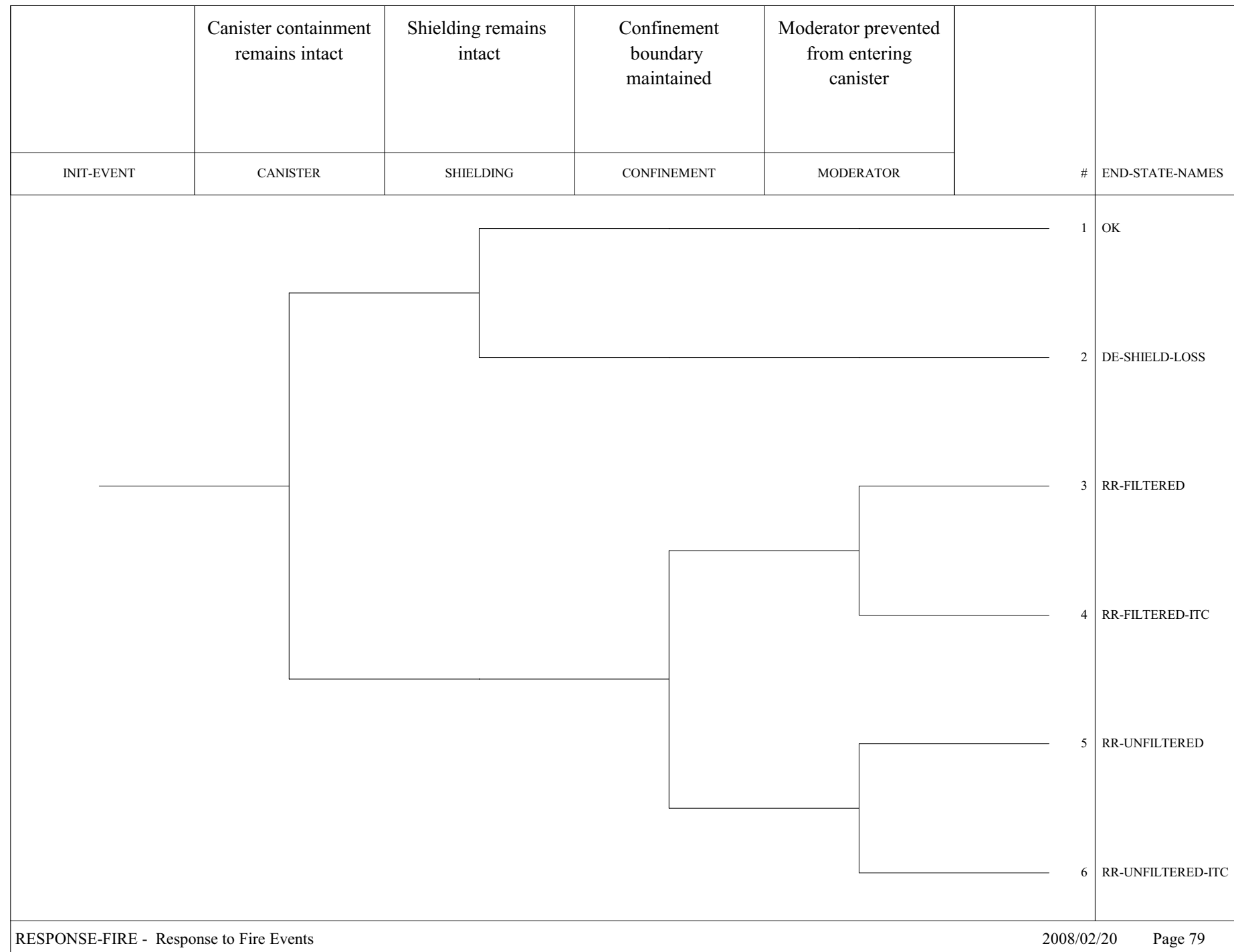

Source: Original

Figure A5-80. Event Tree RESPONSE-FIRE – Response to Fire Events

Number of DOE Std. Canisters moved during preclosure period	Identify initiating events			
DSTD	INIT-EVENT	#	XFER-TO-RESP-TREE	
		1		OK
	Fire in Cask Unloading Room	2	T => 79	RESPONSE-FIRE
	Fire in Cask Prep Area	3	T => 79	RESPONSE-FIRE
	Fire Threatens Canister in CTM	4	T => 79	RESPONSE-FIRE
	Large Fire in CRCF	5	T => 79	RESPONSE-FIRE

CRCF-ESD20-DSTD - Fire Occurring in the CRCF Involving DSNF

2007/11/06 Page 80

Source: Original

Figure A5-81. Event Tree CRCF-ESD20-DSTD – Fire Occurring in the CRCF Involving DOE SNF

Number of HLW Canisters moved during preclosure period	Identify initiating events		
HLW	INIT-EVENT	#	XFER-TO-RESP-TREE
		1	OK
	Local Fire in Cask Unloading Room	2	T => 79
	Local Fire in Cask Prep Area	3	T => 79
	Local Fire Threatens Canister in CTM	4	T => 79
	Local Fire in Positioning/Closure Room	5	T => 79
	Large Fire in CRCF	6	T => 79

CRCF-ESD20-HLW - Fire Occurring in the CRCF Involving HLW Canisters

2007/11/08 Page 81

Source: Original

Figure A5-82. Event Tree CRCF-ESD20-HLW – Fire Occurring in the CRCF Involving HLW Canisters

Number of MCOs moved during preclosure period	Identify initiating events		
MCO	INIT-EVENT	#	XFER-TO-RESP-TREES
		1	OK
	Fire in Cask Unloading Room	2	T => 79 RESPONSE-FIRE
	Fire in Cask Prep Area	3	T => 79 RESPONSE-FIRE
	Fire Threatens Canister in CTM	4	T => 79 RESPONSE-FIRE
	Large Fire in CRCF	5	T => 79 RESPONSE-FIRE

CRCF-ESD20-MCO - Fire Occurring in the CRCF Involving MCO

2008/02/20 Page 82

Source: Original

Figure A5-83. Event Tree CRCF-ESD20-MCO – Fire Occurring in the CRCF Involving MCO

Number of TADs processed during preclosure period	Identify initiating events		
TAD	INIT-EVENT	#	XFER-TO-RESP-TREE
		1	OK
	Local Fire in Cask Unloading Room	2	T => 79
	Local Fire in Cask Prep Area	3	T => 79
	Local Fire in Loadout Room	4	T => 79
	Local Fire in Positioning Room	5	T => 79
	Local Fire Threatens Canister in CTM	6	T => 79
	Large Fire in CRCF	7	T => 79

CRCF-ESD20-TAD - Fire Occurring in the CRCF Involving TADs

2007/10/31 Page 83

Source: Original

Figure A5-84. Event Tree CRCF-ESD20-TAD – Fire Occurring in the CRCF Involving TAD Canisters

Number of WPs with HLW & Std. Can. or with HLW & MCOs processed during preclosure period	Identify initiating events		
WP-H&D	INIT-EVENT	#	XFER-TO-RESP-TREE
CRCF-ESD20-WP-H&D - Fire Occurring in the CRCF Involving HLW & DSNF (in WP)			2007/10/31 Page 84

Source: Original

Figure A5-85. Event Tree CRCF-ESD20-WP-H&D – Fire Occurring in the CRCF Involving HLW and DOE SNF in Waste Package

Number of WPs with HLW and MCOs processed during preclosure period	Identify initiating events		
WP-H&M	INIT-EVENT	#	XFER-TO-RESP-TREES
<pre> graph LR A[Local Fire in Positioning Room 1] --> B[OK] C[Local Fire in Loadout Room 2] --> D[RESPONSE-FIRE T=> 79] E[Large Fire in CRCF 3] --> F[RESPONSE-FIRE T=> 79] G[Large Fire in CRCF 4] --> H[RESPONSE-FIRE T=> 79] </pre>			
CRCF-ESD20-WP-H&M - Fire Occurring in CRCF Involving HLW and MCO in WP			2007/11/15 Page 85

Source: Original

Figure A5-86. Event Tree CRCF-ESD20-WP-H&M – Fire Occurring in the CRCF Involving HLW and MCO in Waste Package

ATTACHMENT B
SYSTEM/PIVOTAL EVENT ANALYSIS – FAULT TREES

CONTENTS

	Page
B1 SITE PRIME MOVER FAULT TREES ANALYSIS	B1-20
B1.1 REFERENCES	B1-20
B1.2 SITE PRIME MOVER DESCRIPTION	B1-20
B1.3 DEPENDENCIES AND INTERACTIONS ANALYSIS	B1-24
B1.4 SITE PRIME MOVER RELATED FAILURE SCENARIOS	B1-24
B2 CASK TRANSFER TROLLEY ANALYSIS	B2-1
B2.1 REFERENCES	B2-1
B2.2 CASK TRANSFER TROLLEY DESCRIPTION	B2-1
B2.3 DEPENDENCIES AND INTERACTIONS ANALYSIS	B2-8
B2.4 CTT RELATED FAILURE SCENARIOS.....	B2-8
B3 LOADING/UNLOADING ROOM SHIELD DOOR AND SLIDE GATE FAULT TREE ANALYSIS.....	B3-1
B3.1 REFERENCES	B3-1
B3.2 SLIDE GATE AND SHIELD DOOR SYSTEM DESCRIPTION.....	B3-1
B3.3 DEPENDENCIES AND INTERACTIONS.....	B3-2
B3.4 SLIDE GATE AND SHIELD DOOR FAILURE SCENARIOS	B3-3
B4 CRCF CANISTER TRANSFER MACHINE FAULT TREE ANALYSIS.....	B4-1
B4.1 REFERENCES	B4-1
B4.2 CANISTER TRANSFER MACHINE DESCRIPTION.....	B4-1
B4.3 DEPENDENCIES AND INTERACTIONS.....	B4-12
B4.4 CTM RELATED FAILURE SCENARIOS.....	B4-13
B5 WASTE PACKAGE TRANSFER TROLLEY FAULT TREE ANALYSIS	B5-1
B5.1 REFERENCES	B5-1
B5.2 SYSTEM DESCRIPTION.....	B5-2
B5.3 DEPENDENCIES AND INTERACTIONS ANALYSIS	B5-8
B5.4 RELATED FAILURE SCENARIOS	B5-9
B6 SITE TRANSPORTER FAULT TREE ANALYSIS.....	B6-1
B6.1 REFERENCES	B6-1
B6.2 SITE TRANSPORTER DESCRIPTION.....	B6-1
B6.3 DEPENDENCIES AND INTERACTIONS ANALYSIS	B6-9
B6.4 SITE TRANSPORTER RELATED FAILURE SCENARIOS	B6-10
B7 HEATING VENTILATION AND AIR CONDITIONING FAULT TREE ANALYSIS.....	B7-1
B7.1 REFERENCES	B7-1
B7.2 IMPORTANT TO SAFETY HVAC DESCRIPTION	B7-1
B7.3 DEPENDENCIES AND INTERACTIONS.....	B7-6
B7.4 HVAC RELATED FAILURE SCENARIO	B7-7
B8 IMPORTANT TO SAFETY AC POWER FAULT TREE ANALYSIS	B8-1
B8.1 REFERENCES	B8-1
B8.2 ITS AC POWER DESCRIPTION.....	B8-3

CONTENTS (Continued)

	Page
B8.3 DEPENDENCIES AND INTERACTIONS	B8-19
B8.4 ITS AC POWER FAILURE SCENARIOS	B8-20
B9 PIVOTAL EVENT ANALYSIS	B9-1
B9.1 FAULT TREES INVOLVING DROPPING AN OBJECT.....	B9-1
B9.2 IMPACT TO A CASK BY ANOTHER VEHICLE OR OBJECT.....	B9-3
B9.3 IMPACT TO A CASK DUE TO SPURIOUS MOVEMENT.....	B9-8
B9.4 LOSS OF SHIELDING LEADING TO DIRECT EXPOSURE	B9-17
B9.5 MODERATOR SOURCE	B9-19
B9.6 IMPACT OF SHIELD DOOR INTO CONVEYANCE.....	B9-21
B9.7 SHIELDING FAILURE DUE TO IMPACT OF SHIELD DOOR INTO CONVEYANCE	B9-23
B9.8 CASK OR CANISTER FAILURE IN A FIRE	B9-26

FIGURES

	Page
B1.2-1. Site Prime Mover Simplified Block Diagram CRCF In-Facility.....	B1-23
B1.4-1. Uncertainty Results of the SPMRC Collides with CRCF Structures Fault Tree ...	B1-28
B1.4-2. Cut Set Generation Results for the SPMRC Collides with CRCF Structures Fault Tree	B1-29
B1.4-3. SPMRC Collision in CRCF	B1-31
B1.4-4. SPMRC Fail to Stop	B1-32
B1.4-5. SPMRC Exceeds Safe Speed	B1-33
B1.4-6. Uncertainty Results of the SPMTT Collides with CRCF Structures Fault Tree ...	B1-37
B1.4-7. Cut Set Generation Results for the SPMTT Collides with CRCF Structures Fault Tree	B1-38
B1.4-8. SPMRC Collision in CRCF	B1-40
B1.4-9. SPMTT Failure to Stop.....	B1-41
B1.4-10. SPMTT Exceeds Safe Speed	B1-42
B1.4-11. Uncertainty Results of the SPMRC Derailment Fault Tree.....	B1-45
B1.4-12. Cut Set Generation Results for SPMRC Derailment	B1-45
B1.4-13. SPMRC Derailment in CRCF.....	B1-47
B1.4-14. SPMTT Rollover in CRCF	B1-50
B2.2-1. Cask Transfer Trolley	B2-2
B2.2-2. Schematic of the CTT Control System	B2-5
B2.4-1. Uncertainty Results of for “Spurious Movement of the CTT in the Cask Preparation Area during Cask Loading”	B2-11
B2.4-2. Cut Set Generation Results for “Spurious Movement of the CTT in the Cask Preparation Area during Cask Loading”	B2-12
B2.4-3. Fault Tree for Spurious Movement of the CTT in the Preparation Area during Cask Loading	B2-14
B2.4-4. Fault Tree for CTT Air Supply Valve Failure	B2-15
B2.4-5. Uncertainty Results for the “Spurious Movement of the CTT in the Cask Preparation Area During Cask Preparation” Fault Tree	B2-18
B2.4-6. Cut Set Generation Results for the “Spurious Movement of the CTT in the Cask Preparation Area During Cask Preparation” Fault Tree	B2-18
B2.4-7. Fault Tree for Spurious Movement of the CTT in the during Cask Preparation ...	B2-20
B2.4-8. Uncertainty Results for the Collision of CTT during Cask Transfer Fault Tree ...	B2-23

FIGURES (Continued)

	Page
B2.4-9. Cut Set Generation Results for the Collision of CTT during Cask Transfer Fault Tree	B2-23
B2.4-10. Fault Tree for Collision of the CTT during Cask Transfer (Page 1)	B2-25
B2.4-11. Fault Tree for Collision of the CTT during Cask Transfer (Page 2)	B2-26
B2.4-12. Uncertainty Results for the Spurious Movement of the CTT in the Canister Transfer Room Fault Tree.....	B2-29
B2.4-13. Cut Set Generation Results for the Spurious Movement of the CTT in the Canister Transfer Room Fault Tree	B2-29
B2.4-14. Fault Tree for CTT Spurious Movement during Canister Transfer.....	B2-31
B3.4-1. Uncertainty Results for the Inadvertent Opening of the Shield Door Fault Tree	B3-5
B3.4-2. Cut Set Generation Results for Inadvertent Opening of the Shield Door.....	B3-6
B3.4-3. Fault Trees for Inadvertent Opening of the Shield Door	B3-8
B3.4-4. Uncertainty Results for the Inadvertent Opening of Slide Gate Causing Direct Exposure Fault Tree.....	B3-11
B3.4-5. Cut Set Generation Results for Inadvertent Opening of Slide Gate Causing Direct Exposure	B3-11
B3.4-6. Fault Trees for Inadvertent Opening of the Slide Gate Causing Direct Exposure	B3-13
B3.4-7. Uncertainty Results for the Shield Door Closes on Conveyance Fault Tree.....	B3-16
B3.4-8. Cut Set Generation Results for Shield Door Closes on Conveyance Fault Tree ...	B3-16
B3.4-9. Fault Trees for Shield Door Closes on Conveyance.....	B3-18
B4.2-1. Canister Transfer Machine Elevation	B4-2
B4.2-2. Canister Transfer Machine Cross Section.....	B4-3
B4.2-3. Canister Hoist Instrumentation	B4-5
B4.2-4. Shield Skirt and Slide Gate Instrumentation.....	B4-6
B4.2-5. Trolley Instrumentation	B4-7
B4.2-6. Bridge Instrumentation	B4-8
B4.4-1. Uncertainty Results of the “Canister Drop from Below the Canister Design- Limit Drop Height” Fault Tree	B4-21
B4.4-2. Cut Set Generation Results for the “Canister Drop from Below the Canister Design-Limit Drop Height” Fault Tree.....	B4-21
B4.4-3. CTM Drop Fault Tree Sheet 1	B4-24
B4.4-4. CTM Drop Fault Tree Sheet 2	B4-25

FIGURES (Continued)

	Page
B4.4-5. CTM Drop Fault Tree Sheet 3	B4-26
B4.4-6. CTM Drop Fault Tree Sheet 4	B4-27
B4.4-7. CTM Drop Fault Tree Sheet 5	B4-28
B4.4-8. CTM Drop Fault Tree Sheet 6	B4-29
B4.4-9. CTM Drop Fault Tree Sheet 7	B4-30
B4.4-10. CTM Drop Fault Tree Sheet 8	B4-31
B4.4-11. CTM Drop Fault Tree Sheet 9	B4-32
B4.4-12. CTM Drop Fault Tree Sheet 10	B4-33
B4.4-13. CTM Drop Fault Tree Sheet 11	B4-34
B4.4-14. Uncertainty Results of the “Canister Drop from Above the Canister Design Limit Drop Height” Fault Tree	B4-39
B4.4-15. Cut Set Generation Results for the “Canister Drop from Above the Canister Design Limit Drop Height” Fault Tree	B4-39
B4.4-16. CTM High Drops from Two Blocking Event Sheet 1	B4-41
B4.4-17. CTM High Drops from Two Blocking Event Sheet 2	B4-42
B4.4-18. CTM High Drops from Two Blocking Event Sheet 3	B4-43
B4.4-19. Uncertainty Results of the Drop of Object onto Canister Fault Tree	B4-49
B4.4-20. Cut Set Generation Results for the Drop of Object onto Canister Fault Tree	B4-49
B4.4-21. Drop of Object onto Cask Sheet 1	B4-52
B4.4-22. Drop of Object onto Cask Sheet 2	B4-53
B4.4-23. Drop of Object onto Cask Sheet 3	B4-54
B4.4-24. Drop of Object onto Cask Sheet 4	B4-55
B4.4-25. Drop of Object onto Cask Sheet 5	B4-56
B4.4-26. Drop of Object onto Cask Sheet 6	B4-57
B4.4-27. Drop of Object onto Cask Sheet 7	B4-58
B4.4-28. Drop of Object onto Cask Sheet 8	B4-59
B4.4-29. Drop of Object onto Cask Sheet 9	B4-60
B4.4-30. Drop of Object onto Cask Sheet 10	B4-61
B4.4-31. Drop of Object onto Cask Sheet 11	B4-62
B4.4-32. Drop of Object onto Cask Sheet 12	B4-63
B4.4-33. Uncertainty Results of the “Canister Impact” Fault Tree	B4-68

FIGURES (Continued)

	Page
B4.4-34. Cut Set Generation Results for the “Canister Impact” Fault Tree	B4-68
B4.4-35. Canister Impact—CTM Collision Sheet 1	B4-70
B4.4-36. CTM Collision Sheet 2	B4-71
B4.4-37. CTM Collision Sheet 3	B4-72
B4.4-38. CTM Collision Sheet 4	B4-73
B4.4-39. CTM Collision Sheet 5	B4-74
B4.4-40. Uncertainty Results of the CTM Movement Subjects Canister to Shearing Forces Fault Tree	B4-79
B4.4-41. Cut Set Generation Results for the CTM Movement Subjects Canister to Shearing Forces Fault Tree	B4-79
B4.4-42. CTM Shear Sheet 1	B4-81
B4.4-43. CTM Shear Sheet 2.....	B4-82
B4.4-44. CTM Shear Sheet 3.....	B4-83
B4.4-45. Uncertainty Results of the Collision Between Two CTMs Fault Tree.....	B4-87
B4.4-46. Cut Set Generation Results for the Collision Between Two CTMs Fault Tree.....	B4-87
B4.4-47. Collision Between Two CTMs Fault Tree.....	B4-89
B5.2-1. Waste Package Transfer Trolley.....	B5-3
B5.2-2. Waste Package Transfer Carriage.....	B5-4
B5.2-3. Schematic of the Waste Package Transfer Trolley Control System.....	B5-6
B5.4-1. Uncertainty Results for Spurious Movement of the WPTT in the Loading Area While Loading the Waste Package with Canisters Fault Tree.....	B5-13
B5.4-2. Cut Set Generation Results for Spurious Movement of the WPTT in the Loading Area While Loading the Waste Package with Canisters Fault Tree.....	B5-13
B5.4-3. Fault Tree for Spurious Movement of the WPTT During Canister Loading.....	B5-16
B5.4-4. Fault Tree for Spurious Movement of the WPTT in the Loading Area While Loading the Waste Package with Canisters (Continued).....	B5-17
B5.4-5. Fault Tree for Spurious Movement of the WPTT in the Loading Area While Loading the Waste Package with Canisters (Continued).....	B5-18
B5.4-6. Fault Tree for Spurious Movement of the WPTT in the Loading Area While Loading the Waste Package with Canisters (Continued).....	B5-19
B5.4-7. Uncertainty Results for the Impact of the WPTT with a Structure Fault Tree.....	B5-22
B5.4-8. Cut Set Generation Results for Impact of the WPTT with a Structure Fault Tree	B5-22

FIGURES (Continued)

	Page
B5.4-9. Fault Tree for Impact of the WPTT with a Structure during Waste Package Transfer.....	B5-24
B5.4-10. Fault Tree for Impact of the WPTT with a Structure during Waste Package Transfer (Continued).....	B5-25
B5.4-11. Uncertainty Results for the Derailment of the WPTT Fault Tree.....	B5-27
B5.4-12. Cut Set Generation Results for the Derailment of the WPTT Fault Tree.....	B5-27
B5.4-13. Fault Tree for Derailment of the WPTT during WP Transfer	B5-29
B5.4-14. Uncertainty Results for the for Premature Tilt-down of the WPTT Fault Tree.....	B5-31
B5.4-15. Cut Set Generation Results for the for Premature Tilt-down of the WPTT Fault Tree	B5-32
B5.4-16. Fault Tree for WPTT Premature Tilt-down During Waste Package Transfer	B5-33
B5.4-17. Uncertainty Results for the “Malfunction of WPTT or Waste Package Transfer Carriage” Fault Tree.....	B5-36
B5.4-18. Cut Set Generation Results for the “Malfunction of WPTT or Waste Package Transfer Carriage”	B5-36
B5.4-19. Fault Tree for WPTT or Carriage Malfunction during Export	B5-38
B5.4-20. Fault Tree for WPTT or Carriage Malfunction during Export (Continued).....	B5-39
B5.4-21. Fault Tree for WPTT or Carriage Malfunction during Export (Continued).....	B5-40
B6.2-1 Site Transporter.....	B6-2
B6.2-2. Simplified Block Diagram of the Site Transporter Subsystems	B6-4
B6.4-1. Uncertainty Results for Site Transporter Collides with CRCF Structures Fault Tree	B6-14
B6.4-2. Cut Set Generation Results for Site Transporter Collides with CRCF Structures Fault Tree.....	B6-14
B6.4-3. Site Transporter Collides with CRCF Structures Fault Tree	B6-16
B6.4-4. Site Transporter Collides with CRCF Structures – Failure to Stop.....	B6-17
B6.4-5. Site Transporter Collides with CRCF Structures – Site Transporter Exceeds Safe Speed.....	B6-18
B6.4-6. Uncertainty Results for Site Transporter Load Drop during Lift and Movement Fault Tree.....	B6-23
B6.4-7. Cut Set Generation Results for Site Transporter Load Drop during Lift/Movement Fault Tree.....	B6-23
B6.4-8. Site Transporter Drop Load During Lift/Movement	B6-27

FIGURES (Continued)

	Page
B6.4-9. Site Transporter Drop Axis Restraint Failure Lift/Lower.....	B6-28
B6.4-10. Failure of Cask Lifting/Lowering System on Site Transporter	B6-29
B6.4-11. Booms Fail During Cask Movement	B6-30
B6.4-12. Boom#2 Drops During Cask Movement	B6-31
B6.4-13. Site Transporter Lifting Boom #2 Fails During Lift/Lowering.....	B6-32
B6.4-14. Site Transporter Vehicle Control System Failure.....	B6-33
B6.4-15. Failure of Electrical System on Site Transporter	B6-34
B6.4-16. Cask Restraint Fails During Movement.....	B6-35
B6.4-17. Site Transporter Roll/Drop Restraint Failure During Movement of Cask.....	B6-36
B6.4-18. Site Transporter Drop Axis Restraint System Fails during Movement	B6-37
B6.4-19. Site Transporter Roll-Axis Actuator Electrical/Mechanical Failure Movement ...	B6-38
B6.4-20. Uncertainty Results for the Site Transporter Rollover (Tipover) Fault Tree.....	B6-41
B6.4-21. Cut Set Generation Transporter Rollover Results for the Site Transporter Rollover (Tipover) Fault Tree.....	B6-41
B6.4-22. Operator causes Site Transporter Tipover	B6-43
B6.4-23. Uncertainty Results Site Transporter Spurious Movement Fault Tree.....	B6-46
B6.4-24. Cut Set Generation Results for the Site Transporter Spurious Movement Fault Tree	B6-46
B6.4-25. Spurious Movement of Site Transporter.....	B6-48
B6.4-26. Uncertainty Results Site Transporter Spurious Movement	B6-51
B6.4-27. Cut Set Generation Results for the Site Transporter Spurious Movement Fault Tree	B6-51
B6.4-28. Impact to ST with AO.....	B6-53
B7.2-1. Block Diagram of the CRCF ITS HVAC System	B7-3
B7.4-1. Uncertainty Results of the Failure to Maintain Delta Pressure Fault Tree.....	B7-13
B7.4-2. Cut Set Generation Results for the Failure to Maintain Delta Pressure Fault Tree	B7-13
B7.4-3. Delta Pressure not Maintained in CRCF Facility	B7-19
B7.4-4. Loss of Normal and Degrade HVAC Trains.....	B7-20
B7.4-5. HVAC Trains Fail in Degraded Mode.....	B7-21
B7.4-6. Train A Failure with Supply Fan Down Reduced	B7-22

FIGURES (Continued)

	Page
B7.4-7. Exhaust Fan in Train A Fails Reduced	B7-23
B7.4-8. Exhaust HEPA Train A with Loss of Supply Fan Fails.....	B7-24
B7.4-9. HEPA Input/Output Manual Damper Fail Reduced	B7-25
B7.4-10. Moisture Separator/Demister HEPA Train A Fails Reduced	B7-26
B7.4-11. Loss of Delta Pressure Train B with InOp. Supply Fan Reduced	B7-27
B7.4-12. Exhaust Fan in Train B Fails	B7-28
B7.4-13. HEPA Filters in Train B Failed Reduced Operation	B7-29
B7.4-14. HEPA Input/Output Manual Damper Train B Fail Reduced.....	B7-30
B7.4-15. Moisture Separator/Demister HEPA Train B Fails Reduced	B7-31
B7.4-16. HVAC Train A is Inoperable.....	B7-32
B7.4-17. Exhaust HEPA Equipment in Train A Fails	B7-33
B7.4-18. HEPA Input/Output Manual Damper Fail	B7-34
B7.4-19. Moisture Separator/Demister HEPA Train A Fails	B7-35
B7.4-20. HVAC Train B is Inoperable	B7-36
B7.4-21. Exhaust HEPA Equipment in Train B Fails	B7-37
B7.4-22. HEPA Input/Output Manual Damper Train B Fail.....	B7-38
B7.4-23. Moisture Separator/Demister HEPA Train B Fails	B7-39
B8.2-1. AC Power – Main Electrical Distribution.....	B8-4
B8.2-2. AC Power – 13.8 kV ITS Switchgear Train A	B8-5
B8.2-3. AC Power – 13.8 kV ITS Switchgear Train B.....	B8-6
B8.2-4. Emergency Diesel Generator Facility – 480V ITS Motor Control Center Train A	B8-7
B8.2-5. ITS 125 V DC System Train A.....	B8-8
B8.2-6. AC Power – 480V ITS Motor Control Center Train B.....	B8-9
B8.2-7. ITS DC Panel Train B.....	B8-10
B8.2-8. CRCF ITS Load Center Train A.....	B8-11
B8.2-9. CRCF ITS Load Center Train B	B8-12
B8.2-10. CRCF ITS MCC Train A.....	B8-13
B8.2-11. CRCF ITS MCC Train B	B8-14
B8.2-12. ITS Diesel Generator Fuel Oil System	B8-16

FIGURES (Continued)

	Page
B8.2-13. Simplified Diagram of Representative Train of CRCF ITS Electrical and ITS Battery Rooms Ventilation System.....	B8-17
B8.4-1. Uncertainty Results of the Loss of AC Power to CRCF ITS Load Center Train A Fault Tree	B8-29
B8.4-2. Cut Set Generation Results for Loss of AC Power to CRCF ITS Load Center Train A	B8-29
B8.4-3. Uncertainty Results of the Loss of AC Power to CRCF ITS Load Center Train B Fault Tree	B8-41
B8.4-4. Cut Set Generation Results for Loss of AC Power to CRCF ITS Load Center Train B	B8-41
B8.4-5. Loss of Power to CRCF ITS Load Center Train A Sheet 1	B8-45
B8.4-6. Loss of Power to CRCF ITS Load Center Train A Sheet 2.....	B8-46
B8.4-7. Loss of Power to CRCF ITS Load Center Train A Sheet 3.....	B8-47
B8.4-8. Loss of Power to CRCF ITS Load Center Train A Sheet 4.....	B8-48
B8.4-9. Loss of Power to CRCF ITS Load Center Train A Sheet 5.....	B8-49
B8.4-10. Loss of Power to CRCF ITS Load Center Train A Sheet 6.....	B8-50
B8.4-11. Loss of Power to CRCF ITS Load Center Train A Sheet 7.....	B8-51
B8.4-12. Loss of Power to CRCF ITS Load Center Train A Sheet 8.....	B8-52
B8.4-13. Loss of Power to CRCF ITS Load Center Train A Sheet 9.....	B8-53
B8.4-14. Loss of Power to CRCF ITS Load Center Train A Sheet 10.....	B8-54
B8.4-15. Loss of Power to CRCF ITS Load Center Train A Sheet 11.....	B8-55
B8.4-16. Loss of Power to CRCF ITS Load Center Train A Sheet 12.....	B8-56
B8.4-17. Loss of Power to CRCF ITS Load Center Train B Sheet 1	B8-57
B8.4-18. Loss of Power to CRCF ITS Load Center Train B Sheet 2	B8-58
B8.4-19. Loss of Power to CRCF ITS Load Center Train B Sheet 3	B8-59
B8.4-20. Loss of Power to CRCF ITS Load Center Train B Sheet 4.....	B8-60
B8.4-21. Loss of AC Power to CRCF ITS Load Center Train B Sheet 5	B8-61
B8.4-22. Loss of AC Power to CRCF ITS Load Center Train B Sheet 6	B8-62
B8.4-23. Loss of AC Power to CRCF ITS Load Center Train B Sheet 7	B8-63
B8.4-24. Loss of AC Power to CRCF ITS Load Center Train B Sheet 8	B8-64
B8.4-25. Loss of AC Power to CRCF ITS Load Center Train B Sheet 9	B8-65
B8.4-26. Loss of AC Power to CRCF ITS Load Center Train B Sheet 10	B8-66

FIGURES (Continued)

	Page
B8.4-27. Loss of AC Power to CRCF ITS Load Center Train B Sheet 11	B8-67
B8.4-28. Loss of AC Power to CRCF ITS Load Center Train B Sheet 12	B8-68
B9.1-1. Typical 200-Ton Crane Drop-On Fault Tree	B9-2
B9.1-2. Typical RHS Crane Drop-On Fault Tree	B9-3
B9.2-1. Typical Side Impact Fault Tree.....	B9-5
B9.2-2. Typical Side Impact with Spurious Movement of CTT Fault Tree	B9-6
B9.2-3. Typical Side Impact with Spurious Movement of Site Transporter Fault Tree.....	B9-7
B9.2-4. Typical Side Impact to Canister with CTM Collision Fault Tree.....	B9-8
B9.3-1. Impact due to Site Transporter Rollover or Aging Overpack Drop.....	B9-10
B9.3-2. Spurious Movement of the Crane or CTT Fault Tree.....	B9-11
B9.3-3. Spurious Movement of the Crane Fault Tree.....	B9-12
B9.3-4. Typical Tipover Fault Tree	B9-13
B9.3-5. Fault Tree for Impact to a Canister due to Spurious Movement of the CTT, Site Transporter or CTM.....	B9-14
B9.3-6. Fault Tree for Impact to a Canister due to Spurious Movement of the CTT, WPTT or CTM.....	B9-15
B9.3-7. Fault Tree for Impact to a Canister due to Spurious Movement of the CTT, Site Transporter, WPTT or CTM during TAD Canister Transfer	B9-16
B9.4-1. Typical Direct Exposure Fault Tree due to Shield Door or Slide Gate Opening ..	B9-18
B9.4-2. Typical Direct Exposure Fault Tree due to Improper Shielding of the Waste Package	B9-19
B9.5-1. Moderator Source (no fire)	B9-20
B9.5-2. Moderator Source (fire)	B9-21
B9.6-1. Impact of Shield Door into Conveyance with DPC.....	B9-22
B9.6-2. Impact of Shield Door into Conveyance with TAD canister.....	B9-23
B9.7-1. Shielding Failure due to Impact of Shield Door into Conveyance with DPC	B9-24
B9.7-2. Shielding Failure due to Impact of Shield Door into Conveyance with TAD Canister	B9-25
B9.7-3. Cask Shielding Failure.....	B9-26
B9.8-1. DPC Failure in a Fire in the Cask Preparation Room.....	B9-28
B9.8-2. DPC Failure in a Large Fire.....	B9-29
B9.8-3. DSNF Failure in a Large Fire	B9-30

FIGURES (Continued)

	Page
B9.8-4. HLW Failure in a Large Fire	B9-31
B9.8-5. MCO Failure in a Large Fire	B9-32
B9.8-6. TAD Failure in a Fire in the Cask Preparation Room	B9-33
B9.8-7. TAD Failure in a Large Fire	B9-34

TABLES

	Page
B1.3-1. Dependencies and Interactions Analysis	B1-24
B1.4-1. ESD Cross Reference with SPMRC/SPMTT Fault Trees	B1-25
B1.4-2. Basic Event Probability for SPMRC Collides with CRCF Structures.....	B1-27
B1.4-3. Cut Sets for SPMRC Collides with CRCF Structures	B1-29
B1.4-4. Basic Event Probability for SPMTT Collides with CRCF Structures	B1-36
B1.4-5. Cut Sets for SPMTT Collides with CRCF Structures.....	B1-38
B1.4-6. Basic Event Probability for SPMRC Derailment.....	B1-44
B1.4-7. Cut Sets for SPMRC Derailment	B1-46
B2.3-1. Dependencies and Interactions Analysis	B2-8
B2.4-1. Basic Event Probabilities for Spurious Movement of the CTT in the Cask Preparation Area during Cask Loading.....	B2-10
B2.4-2. Cut Sets for Spurious Movement of the CTT in the Cask Preparation Room during Cask Loading.....	B2-12
B2.4-3. Basic Event Probabilities for Spurious Movement of the CTT in the Cask Preparation Area During Cask Preparation.....	B2-17
B2.4-4. Cut Sets for Spurious Movement of the CTT in the Cask Preparation Area during Cask Preparation.....	B2-19
B2.4-5. Basic Event Probability for Collision of CTT during Cask Transfer	B2-22
B2.4-6. Cut Sets for 060-6-CTT-COLLIDE, Collision of the CTT During Cask Transfer	B2-24
B2.4-7. Basic Event Probability for Spurious Movement of the CTT in the Canister Transfer Room	B2-28
B2.4-8. Cut Sets for CTT Spurious Movement During Cask Unloading	B2-30
B3.3-1. Dependencies and Interactions Analysis	B3-3
B3.4-1. Basic Event Probabilities for Inadvertent Opening of Shield Door.....	B3-4
B3.4-2. Cut Sets for Inadvertent Opening of Shield Door.....	B3-7
B3.4-3. Basic Event Probabilities for Inadvertent Opening of Slide Gate Causing Direct Exposure	B3-10
B3.4-4. Cut Sets for Inadvertent Opening of Slide Gate Causing Direct Exposure	B3-12
B3.4-5. Basic Event Probabilities for Shield Door Closes on Conveyance.....	B3-15
B3.4-6. Cut Sets for Shield Door Closes on Conveyance.....	B3-17

TABLES (Continued)

	Page
B4.3-1. Dependencies and Interactions Analysis	B4-12
B4.4-1. Basic Event Probability for the Canister Drop from Below Canister Drop Height Limit Fault Tree	B4-18
B4.4-2. Human Failure Events.....	B4-20
B4.4-3. Dominant Cut Sets for Canister Drop from Below the Canister Design-Limit Drop Height	B4-22
B4.4-4. Basic Event Probability for the Canister Drop from Above the Canister Design Limit Drop Height Fault Tree.....	B4-37
B4.4-5. Dominant Cut Sets for the CTM Canister Drop from Above the Canister Design Height Limit	B4-40
B4.4-6. Basic Event Probability for the Drop of Object onto Canister Fault Tree.....	B4-46
B4.4-7. Human Failure Events.....	B4-48
B4.4-8. Dominant Cut Sets for the CTM Drop onto Canister Fault Tree.....	B4-50
B4.4-9. Basic Event Probability for the CTM Fault Trees	B4-66
B4.4-10. Human Failure Events.....	B4-67
B4.4-11. Dominant Cut Sets for the CTM Collision Fault Tree.....	B4-69
B4.4-12. Basic Event Probability for the CTM Movement Subjects Canister to Shearing Forces Fault Tree	B4-77
B4.4-13. Dominant Cut Sets for the “CTM Movement Subjects Canister to Shearing Forces” Fault Tree.....	B4-80
B4.4-14. Basic Event Probability for the Collision Between Two CTMs Fault Trees.....	B4-86
B4.4-15. Dominant Cut Sets for the Collision Between Two CTMs Fault Tree.....	B4-88
B5.3-1. Dependencies and Interactions Analysis	B5-9
B5.4-2. Basic Event Probabilities for Spurious Movement of the WPTT During Loading	B5-12
B5.4-3. Cut Sets for the Spurious Movement of the WPTT in the Loading Area While Loading the Waste Package with Canisters Fault Tree	B5-14
B5.4-4. Basic Event Probabilities for Impact of the WPTT with a Structure.....	B5-21
B5.4-5. Cut Sets for Impact of the WPTT with a Structure Fault Tree	B5-23
B5.4-6. Basic Event Probabilities for Derailment of the WPTT During Waste Package Transfer	B5-26
B5.4-7. Cut Sets for the Derailment of the WPTT	B5-28
B5.4-8. Basic Event Probabilities for Premature Tilt-down of the WPTT	B5-31

TABLES (Continued)

	Page
B5.4-9. Cut Sets for WPTT Premature Tilt-down During Waste Package Transfer	B5-32
B5.4-10. Basic Event Probabilities for WPTT or Carriage Malfunction During Export	B5-35
B5.4-11. Cut Sets for Malfunction of WPTT or Waste Package Transfer Carriage Malfunction During Waste Package Export	B5-37
B6.2-1. Site Transporter Remote or Pendant Controls	B6-6
B6.2-2. Site Transporter Initiating Events by ESD.....	B6-8
B6.3-1. Dependencies and Interactions Analysis	B6-9
B6.4-1. ESD Cross Reference with Site Transporter Fault Trees.....	B6-10
B6.4-2. Basic Event Probability for Site Transporter Collides with CRCF Structures	B6-13
B6.4-3. Cut Sets for the Site Transporter Collides with CRCF Structures.....	B6-15
B6.4-4. Basic Event Probability for the Site Transporter Load Drop during Lift and Movement Fault Tree.....	B6-20
B6.4-5. Cut Sets for Site Transporter Load Drop during Lift/Movement	B6-24
B6.4-6. Basic Event Probability for the Site Transporter Rollover	B6-40
B6.4-7. Cut Sets for the Site Transporter Rollover (Tipover)	B6-42
B6.4-8. Basic Event Probability for Site Transporter Spurious Movement	B6-45
B6.4-9. Cut Sets for the Site Transporter Spurious Movement	B6-47
B6.4-10. Basic Event Probability for Site Transporter Spurious Movement	B6-50
B6.4-11. Cut Sets for Site Transporter Spurious Movement.....	B6-52
B7.2-1. ASD Response to Variations in Delta Pressure and Flow Rates	B7-5
B7.3-1. Dependencies and Interactions Analysis	B7-7
B7.4-1. Basic Event Probability for the Failure to Maintain Delta Pressure in the CRCF Fault Tree.....	B7-10
B7.4-2. Human Failure Events.....	B7-12
B7.4-3. Dominant Cut Sets for the Failure to Maintain Delta Pressure Fault Tree.....	B7-14
B8.3-1. Dependencies and Interactions Analysis	B8-19
B8.4-1. Basic Event Probability for the Loss of AC Power to CRCF ITS Load Center Train A Fault Tree	B8-23
B8.4-2. Human Failure Events.....	B8-27
B8.4-3. Common-Cause Basic Events.....	B8-28
B8.4-4. Dominant Cut Sets for the Loss of AC Power to CRCF ITS Load Center Train A	B8-30

TABLES (Continued)

	Page
B8.4-5. Basic Event Probability for The Loss of AC Power to CRCF ITS Load Center Train B Fault Trees	B8-35
B8.4-6. Human Failure Events.....	B8-39
B8.4-7 Common-Cause Basic Events.....	B8-40
B8.4-8. Dominant Cut Sets for the Loss of AC Power to CRCF ITS Load Center Train B	B8-42
B9.1-1. Drop-On Fault Trees	B9-1
B9.2-1. Transportation Cask Impact Fault Trees.....	B9-4
B9.3-1. Transportation Cask Impact or Tipover Fault Trees.....	B9-9
B9.4-1. Direct Exposure Fault Trees	B9-17
B9.5-1. Moderator Fault Trees.....	B9-20
B9.6-1. Impact of Shield Door Fault Trees.....	B9-22
B9.8-1. Fault Trees for Canister Failure in a Fire.....	B9-26

ACRONYMS AND ABBREVIATIONS

Acronyms

AAR	Association of American Railroads
ASD	adjustable speed drive
AHU	air handling unit
CCF	common-cause failure
CRCF	Canister Receipt and Closure Facility
CTT	cask transfer trolley
CTM	canister transfer machine
DOE	U.S. Department of Energy
EDGF	Emergency Diesel Generator Facility
ESD	event sequence diagram
FRA	Federal Railroad Administration
HEP	human error probability
HEPA	high-efficiency particulate air (filter)
HLW	high-level radioactive waste
HVAC	heating, ventilation and air-conditioning
IHF	Initial Handling Facility
ITS	important to safety
LOSP	loss of offsite power
MCO	multicanister overpack
NHTSA	National Highway Traffic Safety Administration
OOS	out of service
PLC	programmable logic controller
QA	quality assurance
RF	Receipt Facility
RHS	remote handling system
SFP	single failure point
SNF	spent nuclear fuel
SPM	site prime mover
SPMRC	site prime mover railcar
SPMTT	site prime mover truck trailer

ACRONYMS AND ABBREVIATIONS (Continued)

TAD	transportation, aging, and disposal
TEV	transport and emplacement vehicle
WHF	Wet Handling Facility
WPTT	waste package transfer trolley

Abbreviations

AC	alternating current
Cfm	cubic foot per minute
DC	direct current
fpm	foot per minute
fps	foot per second
Hz	hertz
mph	mile per hour
psi	pound per square inch
rpm	revolution per minute
scfm	standard cubic foot per minute
V	volt

ATTACHMENT B

SYSTEM/PIVOTAL EVENT ANALYSIS – FAULT TREES

This attachment presents system and pivotal event fault trees that are used in the event trees described in Attachment A. The system fault trees are presented and described in Section B1 through B8, on a system basis. The pivotal event fault trees are presented in Section B9. For the most part, the pivotal events link to a basic event and these are presented in tables. In a few cases, the assignment is not straightforward and a supplemental fault tree provides a link to the generic fault tree or basic event level. These supplemental fault trees are presented and described below.

B1 SITE PRIME MOVER FAULT TREES ANALYSIS

B1.1 REFERENCES

Design Inputs

The PCSA is based on a snapshot of the design. The reference design documents are appropriately documented as design inputs in this section. Since the safety analysis is based on a snapshot of the design, referencing subsequent revisions to the design documents (as described in EG-PRO-3DP-G04B-00037, *Calculations and Analyses* (Ref. 2.1.1, Section 3.2.2.F)) that implement PCSA requirements flowing from the safety analysis would not be appropriate for the purpose of the PCSA.

The inputs in this Section noted with an asterisk (*) indicate that they fall into one of the designated categories described in Section 4.1, relative to suitability for intended use.

B1.1.1 *AAR S-2043. 2003. *Performance Specification for Trains Used to Carry High-Level Radioactive Material*. [Washington, D.C.]: Association of American Railroads. TIC: 257585.

Design Constraints

B1.1.2 Motor Vehicle Safety. 49 U.S.C. 301. Internet accessible.

B1.1.3 49 CFR 571. 2007. Transportation: Federal Motor Vehicle Safety Standards. Internet accessible.

B1.2 SITE PRIME MOVER DESCRIPTION

B1.2.1 Overview

The site prime mover (SPM) is a diesel/electric self-propelled vehicle that is designed to move railcars or truck trailers loaded with transportation casks. The transport occurs both in the Intra-Site and within the Canister Receipt and Closure Facility (CRCF), the Wet Handling Facility (WHF), the Initial Handling Facility (IHF) and the Receipt Facility (RF).

Movement of the site prime mover railcar (SPMRC) or site prime mover truck trailer (SPMTT) within the CRCF is limited to the Entry Vestibule (Rooms 1036 and 1036A) and the Cask Preparation Room (Room 1026).

Transportation casks arriving at the CRCF on railcar or truck trailer can contain:

- High-level radioactive waste (HLW) canisters
- Department of Energy (DOE) standardized canisters
- Multicanister overpacks (MCO)
- Dual-purpose canisters (DPC)
- Transportation, aging, and disposal (TAD) canisters.

B1.2.2 System Description

B1.2.2.1 Site Prime Mover

The SPM is a commercially available vehicle that has the capability of moving both railcars and truck trailers loaded with transportation casks. Retractable railroad wheels attached to the front and rear axles of the SPM are used for rail operations.

The driving and braking power comes directly from the road tires, as they are in contact with the rails. Weight sharing between the flanged rail and regular road wheels is automatically varied to achieve the required power transmission needs. More weight can be distributed on the rail wheels when moving, or more on the road wheels when braking, accelerating, and negotiating inclines. The SPM has speed limiters that set the maximum speed of the vehicle to less than 9.0 mph.

During Intra-Site activities, the diesel engine drives the generator, which provides the required 480 V, 3-phase, 60 Hz power to the vehicle. During facility operations, the diesel engine is disabled and facility 480 V, 3-phase, 60 Hz power is supplied to the generator. The diesel engine is not used to move either the railcar or truck trailer inside a facility.

The SPM is equipped with both an automatic wagon coupling system for railcars and a fifth wheel coupling device for truck trailers. In addition, the SPM is equipped with high-performance compressors, a priority filling system, and an electronic regulating valve with filling speed adjustments.

B1.2.2.2 Railcars

Railcars used for movement of transportation casks are designed in accordance with the Federal Railroad Administration (FRA) requirements under authority delegated by the Secretary of Transportation. The FRA administers a safety program that oversees the movement of nuclear shipments throughout the national rail transportation system. Performance standards are addressed in the Association of American Railroads (AAR) Standard S-2043: (Ref. B1.1.1).

B1.2.2.3 Truck Trailers

The U.S. Department of Transportation (DOT) has the primary responsibility for regulating the safe transport of radioactive materials in the United States. It sets the standards for packaging, transporting, and handling radioactive materials, including labeling, shipping papers, loading, and unloading requirements.

Trailers used for the movement of transportation casks are designed in accordance with the National Highway Traffic Safety Administration (NHTSA) requirements as authorized by 49 USC Part 301 Motor Vehicle Safety: Standards and Compliance, Section 30111 (Ref. B1.1.2). The requirements are delineated in 49 CFR Part 571 Transportation: Federal Motor Vehicle Safety Standards (Ref. B1.1.3).

B1.2.2.4 Subsystems

The SPMRC and SPMTT systems are composed of four subsystems:

- Power plant—a diesel engine, generator, and diesel fuel tank are enclosed in the SPM. The SPM utilizes a diesel engine for all Intra-Site operations. For operations conducted inside facilities, the SPM is connected to facility 480 V, 3-phase, 60Hz power supply.
- Vehicle controls—during Intra-Site Operations, the operator controls the SPM at the operator's console inside the SPM. For all operations inside of a facility, the operator controls the SPM with either a remote (wireless) controller or through a pendant connected to the vehicle.
- Structural controls—these subsystems include restraints for securing the transportation casks to the railcar/truck trailer; automatic coupler hardware; cradles for supporting the transportation cask; and wheels/tires and axles.
- Brakes—for the railcar, brakes comply with FRA requirements; for the truck trailer, the braking system complies with 49 CFR Part 571 (Ref. B1.1.3).

A simplified block diagram of the functional components on the SPMRC/SPMTT is shown in Figure B1.2-1.

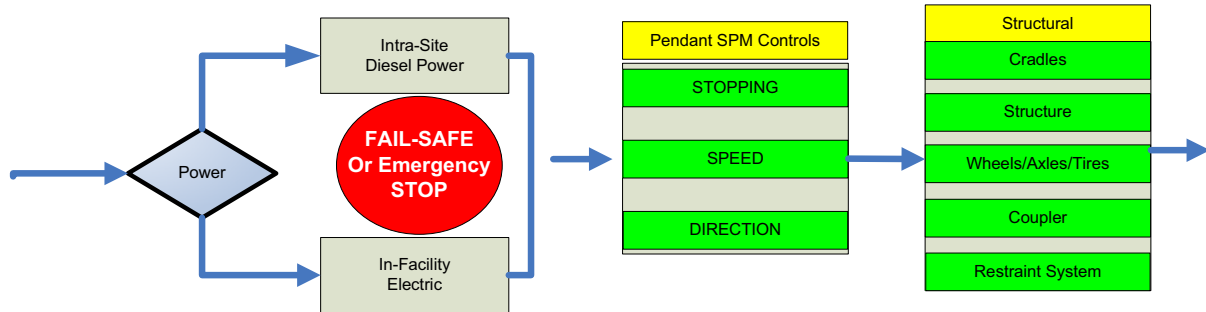

Source: Original

Figure B1.2-1. Site Prime Mover Simplified Block Diagram CRCF In-Facility

B1.2.3 Operations

B1.2.3.1 Normal Operations

In-facility SPM operations begin when the SPM has positioned the railcar or truck trailer carrying a transportation cask outside the Entry Vestibule at the facility. The SPM diesel engine is shut down and the inner and outer vestibule doors are opened. Facility 480 V, 3-phase, 60 Hz power is connected to the SPM for all operations inside the facility. The SPM is never operated inside a facility using the diesel engine.

The operator connects the pendant controller or a remote (wireless) controller to the SPM to control the movements of the railcar/truck trailer in the facility. Once inside the facility vestibule, the outer vestibule door is closed. The Cask Preparation Room vestibule door is then opened and the SPM backs the railcar/truck trailer into the Cask Preparation Room. Once in position, the SPM is disconnected from the railcar/truck trailer and the operators move the SPM to the inner vestibule area and the Cask Preparation Room vestibule door is then closed. The outer vestibule door can then be opened and the SPM exits the facility. Once outside, the SPM is shut down and the facility power is removed and the outer vestibule door is closed.

B1.2.3.2 Site Prime Mover Off-Normal Operations

In the event of loss of power, the SPM is designed to stop, retain control of the railcar/truck trailer, and enter a locked mode. Upon the restoration of power, the SPM stays in the locked mode until operator action is taken, to return to normal operations.

B1.2.3.3 Site Prime Mover Testing and Maintenance

Testing and maintenance of the SPM is done on a periodic basis and does not affect the normal operations of the SPM. Testing and/or maintenance are not performed on a SPM when it is coupled with a railcar or a truck trailer loaded with a transportation cask. A SPM that has malfunctioned or has a warning light lit is deemed to be unserviceable and turned in for maintenance. Unserviceable vehicles are not used.

If an unserviceable state is identified during movement, the SPM is placed into a safe state (as quickly as possible) and recovery actions for the SPM are invoked.

B1.3 DEPENDENCIES AND INTERACTIONS ANALYSIS

Dependencies are broken down into five categories with respect to their interactions with system, structures, and components. The five areas considered are addressed in Table B1.3-1 with the following dependencies:

1. Functional dependence
2. Environmental dependence
3. Spatial dependence
4. Human dependence
5. Failures based on external events.

Table B1.3-1. Dependencies and Interactions Analysis

Structures, Systems, and Components	Dependencies and Interactions				
	Functional	Environmental	Spatial	Human	External Events
Structural	—Material failure —Coupler —Wheels/tires/axle	—	—	—	—
Brakes	—Material failure	—	—	—Failure to engage (Set)	—
Power plant	—Overload protection fails —Safe state on	—	—	—Failure to stop	—
Remote control	—Spurious commands	—	—	—Improper command	- Collide end stops

Source: Original

B1.4 SITE PRIME MOVER RELATED FAILURE SCENARIOS

There are four top events for the SPM operating inside the CRCF.

1. SPMRC collides with CRCF structures
2. SPMTT collides with CRCF structures
3. SPMRC Derailment
4. SPMTT Rollover

Table B1.4-1 provides a cross reference between the event sequence diagram (ESD) and the SPM fault trees that support them. Potential fire scenarios associated with the SPM are discussed in Section 6.5 and Attachment F.

Table B1.4-1. ESD Cross Reference with SPMRC/SPMTT Fault Trees

CRCF ESD Number	SPMRC Collision	SPMTT Collision	SPMRC Derailment	SPMTT Rollover ^a
ESD01-DPC	x	—	x	—
ESD01-DSNF	x	x	x	x
ESD01-HLW	x	x	x	x
ESD01-MCO	x	x	x	x
ESD01-TAD	x	—	x	—

NOTE: ^a SPMTT rollover is addressed in Attachment A.
 CRCF = Canister Receipt and Closure Facility; DPC = dual-purpose canister; DSNF = DOE spent nuclear fuel; ESD = event sequence diagram; HLW = high-level radioactive waste; MCO = multicarrier overpack; SPMRC = site prime mover railcar; SPMTT = site prime mover truck trailer; TAD = transportation, aging, and disposal (canister).

Source: Original

The potential for fire involving the diesel fuel tank is discussed in Section 6.5 and Attachment F, and is evaluated in the fire scenarios discussed in Attachment B9.

B1.4.1 SPMRC Collides with CRCF Structures

B1.4.1.1 Description

The collision fault tree for SPMRC collision within the CRCF is identical for each type of transportation cask. Collision can occur as a result of human error or mechanical failures. Mechanical failures leading to a collision consist of the SPM failure to stop when commanded, the SPM exceeding a safe speed, or the SPM moving in a wrong direction.

B1.4.1.2 Success Criteria

The success criteria for preventing a collision includes safety design features incorporated in the SPM for mechanical failures and the SPM operator maintaining situational awareness and proper control of the movement of the SPM. To avoid collisions, the SPM must stop when commanded, be prevented from entering a runaway situation, and respond correctly to a SPM movement command.

The SPM is designed to stop whenever commanded to stop or when there is a loss of power. The operator can stop the SPM by either commanding a “stop” from the start/stop button or by releasing the palm switch which initiates an emergency stop. At anytime there is a loss of power detected, the SPM performs a controlled stop. Once stopped, the SPM enters into a “lock mode,” safe state. The SPM remains in this locked mode until power is returned and the operator restarts the SPM.

Runaway situations on the SPM are prevented by hardware constraints. The maximum speed of the SPM is controlled by a speed limiter on the diesel engine for outside movement. The speed control on the SPM for in-facility operations is controlled by the physical limitations of the drive system. The SPM gearing prevents the SPM from exceeding 9.0 miles per hour. SPM movements in the wrong direction are prevented by the limitations of the power plant that prevent simultaneous operations.

B1.4.1.3 Design Requirements and Features

Requirements

Since the dominant contributor to a SPMRC collision in the facility is human error, no priority is given to either the remote or the pendant controllers. The SPM is operated on electrical power when inside the building. The SPM is disconnected from the railcar in the Cask Preparation Room and moved out of the building before cask preparation activities begin.

Design Features

The SPM has two off-equipment control devices that have complete control over the SPMRC. The drive system limits the maximum speed of the SPM to 9.0 mph.

System Configuration and Operating Conditions

Requirements

Two means of stopping the SPM are incorporated in the controllers. One is the normal stop button and the other is an emergency stop that is the equivalent of a “deadman switch.” On the loss of AC power, the SPM performs a controlled stop. Once stopped, the SPM enters the lock mode state. The lock mode state is not reversible without specific operator action.

Design Features and Inputs

Stopping the SPM is accomplished by pushing the “stop” button or releasing the palm switch on the remote or pendant controller. The SPM, upon receiving a stop command from either control source, immediately responds by removing power from the propulsion system on the SPM.

Testing and Maintenance

Requirements

No maintenance or testing permitted on a SPM loaded with a transportation cask.

Design Feature

None.

B1.4.1.4 Fault Tree Model

The fault tree model for “SPMRC Collides with CRCF Structures” accounts for both human error and/or SPMRC mechanical problems that could result in a collision. There is only one movement within the CRCF. Once the SPMRC has been properly positioned within the Cask Preparation Room, the SPM is decoupled from the railcar and it is moved out of the facility.

The fault tree for SPMRC and SPMTT are identical and a split fraction is used to account for the number/type of transportation casks that arrive at the CRCF on either the railcar or truck trailer. The fault tree for the SPMTT is discussed in the next section.

The top event is a collision of the SPMRC in the CRCF and is shown in Figure B1.4-3. This may occur due to human error coupled with failure of the speed control or interlocks, or failure of the mechanical and/or control system including failure to stop (Figure B1.4-4) or exceeding a safe speed (Figure B1.4-5). Failure to stop may occur due to mechanical failure of brakes, or failure of the control system. Exceeding a safe speed may also occur due to failure of the control system.

B1.4.1.5 Basic Event Data

Table B1.4-2 contains a list of basic events used in the “SPMRC Collides with CRCF Structures” fault trees. The mission time has been set at one hour. This is a conservative estimate since it does not require one hour to move the rail car into the facility, disconnect the SPM from the railcar, and move the SPM back outside the facility.

Table B1.4-2. Basic Event Probability for SPMRC Collides with CRCF Structures

Name	Calc. Type ^a	Calc. Prob.	Fail. Prob.	Lambda	Miss. Time ^a
060-OPRCOLLIDE1-HFI-NOD	1	3.00E-03	3.00E-03	0.00E+00	0.00E+00
060-OPRCINTCOL01-HFI-NOD	1	1.00E+00	1.00E+00	0.00E+00	0.00E+00
060-OPRCINTCOL02-HFI-NOD	1	1.00E+00	1.00E+00	0.00E+00	0.00E+00
060-PWR-LOSS	1	4.10E-06	4.10E-06	0.00E+00	0.00E+00
060-SPMRC-STU001-STU-FOH	3	4.81E-08	0.00E+00	4.81E-08	1.00E+00
060-SPMRC-BRK001-BRP-FOD	1	5.02E-05	5.02E-05	0.00E+00	0.00E+00
060-SPMRC-BRP000-BRP-FOD	1	5.02E-05	5.02E-05	0.00E+00	0.00E+00
060-SPMRC-BRP001-BRP-FOD	1	5.02E-05	5.02E-05	0.00E+00	0.00E+00
060-SPMRC-CBP001-CBP-SHC	3	1.88E-08	0.00E+00	1.88E-08	1.00E+00
060-SPMRC-CBP001-CBP-OPC	3	9.13E-08	0.00E+00	9.13E-08	1.00E+00
060-SPMRC-CPL000-CPL-FOH	3	1.91E-06	0.00E+00	1.91E-06	1.00E+00
060-SPMRC-CT000--CT--FOD	1	4.00E-06	4.00E-06	0.00E+00	0.00E+00
060-SPMRC--CT001-CT--FOD	1	4.00E-06	4.00E-06	0.00E+00	0.00E+00
060-SPMRC-CT002--CT--FOH	3	6.88E-05	0.00E+00	6.88E-05	1.00E+00
060-SPMRC--CT003-CT--SPO	3	2.27E-05	0.00E+00	2.27E-05	1.00E+00
060-SPMRC-G65000-G65-FOH	3	1.16E-05	0.00E+00	1.16E-05	1.00E+00
060-SPMRC-HC001--HC--SPO	3	5.23E-07	0.00E+00	5.23E-07	1.00E+00
060-SPMRC-HC001-HC--FOD	1	1.74E-03	1.74E-03	0.00E+00	0.00E+00
060-SPMRC-IEL011-IEL-FOD	1	2.75E-05	2.75E-05	0.00E+00	0.00E+00
060-SPMRC-MOE000-MOE-FSO	3	1.35E-08	0.00E+00	1.35E-08	0.00E+00
060-SPMRC-SC021--SC--FOH	3	1.28E-04	0.00E+00	1.28E-04	1.00E+00
060-SPMRC-SEL021-SEL-FOH	3	4.16E-06	0.00E+00	4.16E-06	1.00E+00

NOTE: ^a For Calc. Type 3 with a mission time of 0, SAPHIRE performs the quantification using the system mission time.

Calc. = calculation; Fail. = failure; Miss. = mission; Prob. = probability.

Source: Original

B1.4.1.5.1 Human Failure Events

Three human errors have been identified for this fault tree. Section 6.4 and Attachment E contain a detailed analysis on the derivation of the failure data.

1. Operator causes collision (060-OPRCCOLLIDE1-HFI-NOD)
2. Operator initiates runaway (060-OPRCINTCOL01-HFI-NOD)
3. Operator causes a collision with mobile platform (060-OPRCINTCOL02-HFI-NOD).

B1.4.1.5.2 Common-Cause Failures

There are no common-cause failures (CCFs) identified for this fault tree.

B1.4.1.6 Uncertainty and Cut Set Generation Results

Figure B1.4-1 contains the uncertainty results obtained from running the fault tree for “SPMRC Collides with CRCF Structures” using a cutoff probability of 1E-12. Figure B1.4-2 provides the cut set generation results for the “SPMRC Collides with CRCF Structures” fault tree.

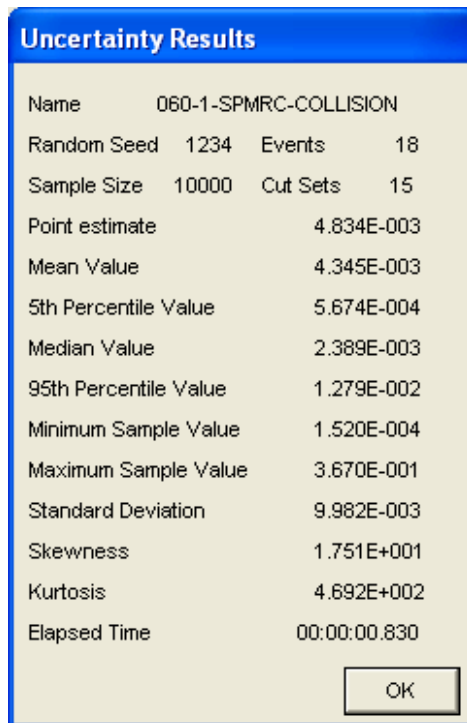

Source: Original

Figure B1.4-1. Uncertainty Results of the SPMRC Collides with CRCF Structures Fault Tree

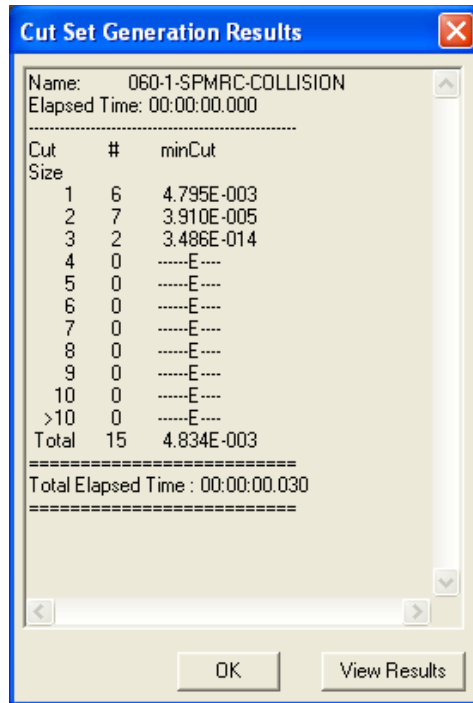

Source: Original

Figure B1.4-2. Cut Set Generation Results for the SPMRC Collides with CRCF Structures Fault Tree

B1.4.1.7 Cut Sets

Table B1.4-3 contains the cut sets for “SPMRC Collides with CRCF Structures.” The probability of failure is 4.83E-03.

Table B1.4-3. Cut Sets for SPMRC Collides with CRCF Structures

Fault Tree	Cut Set %	Prob./Freq.	Basic Event	Description	Probability
060-1-SPMRC-COLLISION	62.07	3.000E-003	060-OPRCOLLIDE1-HFI-NOD	Operator Causes Collision	3.0E-003
	36.00	1.740E-003	060-SPMRC-HC001-HC-FOD	Pendant Control Transmits Wrong Signal	1.7E-003
	1.04	5.020E-005	060-SPMRC-BRP000-BRP-FOD	Brake (Pneumatic) Failure on Demand	5.0E-005
	0.57	2.750E-005	060-OPRCINTCOL02-HFI-NOD	Operator Causes Collision with Mobile Platform	1.0E+000
			060-SPMRC-IEL011-IEL-FOD	Failure of Mobile Platform Anti-Collision Interlock	2.8E-005
	0.24	1.160E-005	060-OPRCINTCOL01-HFI-NOD	Operator Initiates Runaway	1.0E+000
			060-SPMRC-G65000-G65-FOH	SPMRC Speed Control (Governor) Fails	1.2E-005
	0.08	4.000E-006	060-SPMRC--CT001-CT-FOD	On-Board Controller Fails to Respond	4.0E-006

Table B1.4-3. Cut Sets for SPMRC Collides with CRCF Structures (Continued)

Fault Tree	Cut Set %	Prob./Freq.	Basic Event	Description	Probability
	0.08	4.000E-006	060-SPMRC-CT000--CT-FOD	SPMRC Primary Stop Switch Fails	4.0E-006
	0.04	1.910E-006	060-SPMRC-CPL000-CPL-FOH	Railcar Automatic Coupler System Fails	1.9E-006
	0.00	2.058E-010	060-PWR-LOSS	Loss of Site Power	4.1E-006
			060-SPMRC-BRP001-BRP-FOD	SPMRC Fails to Stop on Loss of Power	5.0E-005
	0.00	4.583E-012	060-SPMRC-BRP001-BRP-FOD	SPMRC Fails to Stop on Loss of Power	5.0E-005
			060-SPMRC-CBP001-CBP-OPC	Power Cable to SPMRC - Open Circuit	9.1E-008
	0.00	9.438E-013	060-SPMRC-BRP001-BRP-FOD	SPMRC Fails to Stop on Loss of Power	5.0E-005
			060-SPMRC-CBP001-CBP-SHC	SPMRC Power Cable - Short Circuit	1.9E-008
	0.00	5.535E-014	060-PWR-LOSS	Loss of Site Power	4.1E-006
			060-SPMRC-MOE000-MOE-FSO	Motor (Electric) Fails to Shut Off	1.4E-008
	0.00	3.370E-014	060-SPMRC--CT003-CT-SPO	On-Board Controller Initiates Spurious Signal	2.3E-005
			060-SPMRC-G65000-G65-FOH	SPMRC Speed Control (Governor) Fails	1.2E-005
			060-SPMRC-SC021--SC--FOH	Speed Controller on SPMRC Pendant Fails	1.3E-004
	0.00	1.233E-015	060-SPMRC-CBP001-CBP-OPC	Power Cable to SPMRC - Open Circuit	9.1E-008
			060-SPMRC-MOE000-MOE-FSO	Motor (Electric) Fails to Shut Off	1.4E-008
	0.00	1.095E-015	060-SPMRC--CT003-CT-SPO	On-Board Controller Initiates Spurious Signal	2.3E-005
			060-SPMRC-G65000-G65-FOH	SPMRC Speed Control (Governor) Fails	1.2E-005
			060-SPMRC-SEL021-SEL-FOH	Speed Selector on SPMRC Pendant Fails	4.2E-006
		4.834E-003	= Total		

NOTE: Freq. = frequency; Prob. = probability; SPMRC = site prime mover railcar.

Source: Original

B1.4.1.8 Fault Trees

The fault tree for SPMRC collision in the CRCF is shown in Figure B1.4-3.

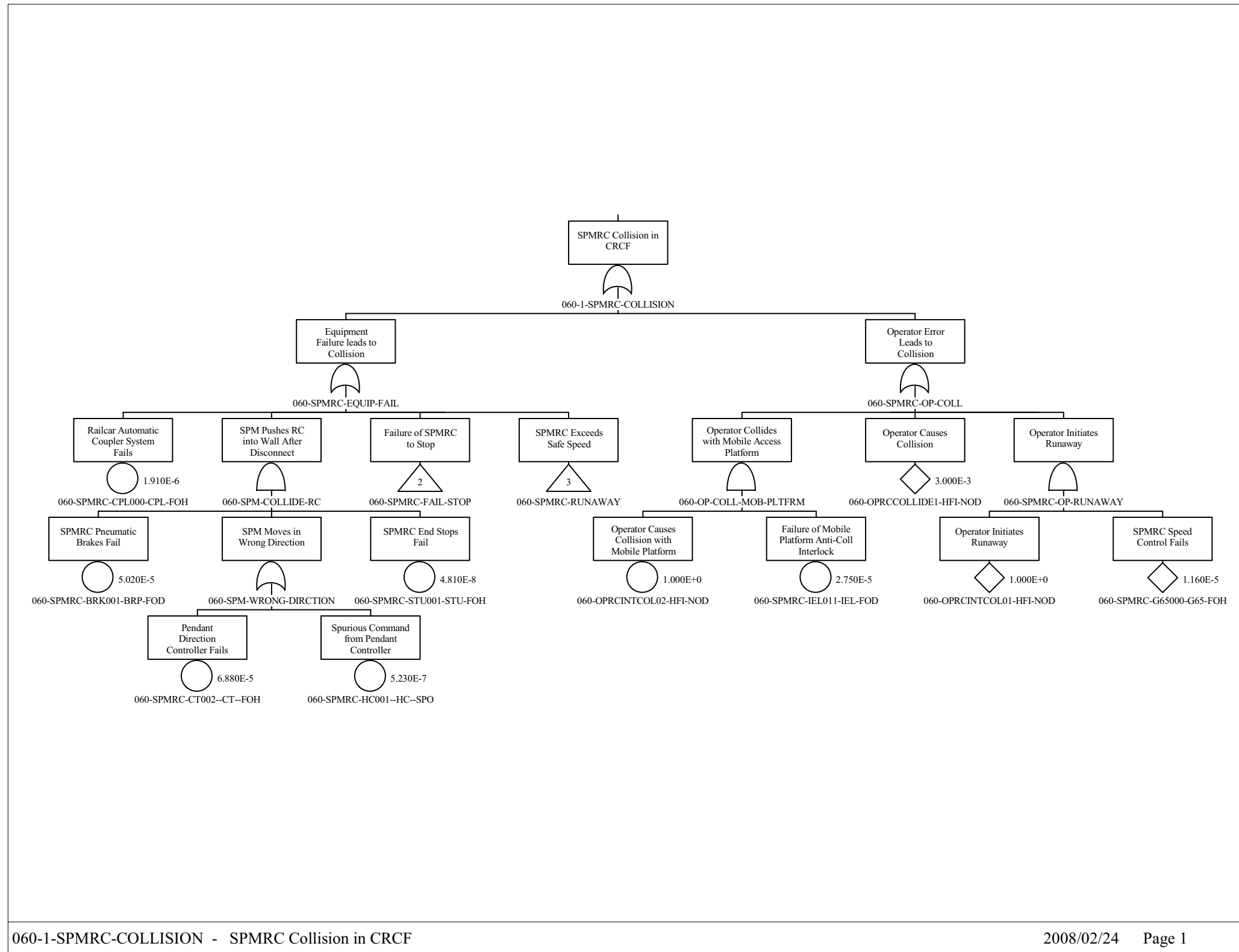

Source: Original

Figure B1.4-3. SPMRC Collision in CRCF

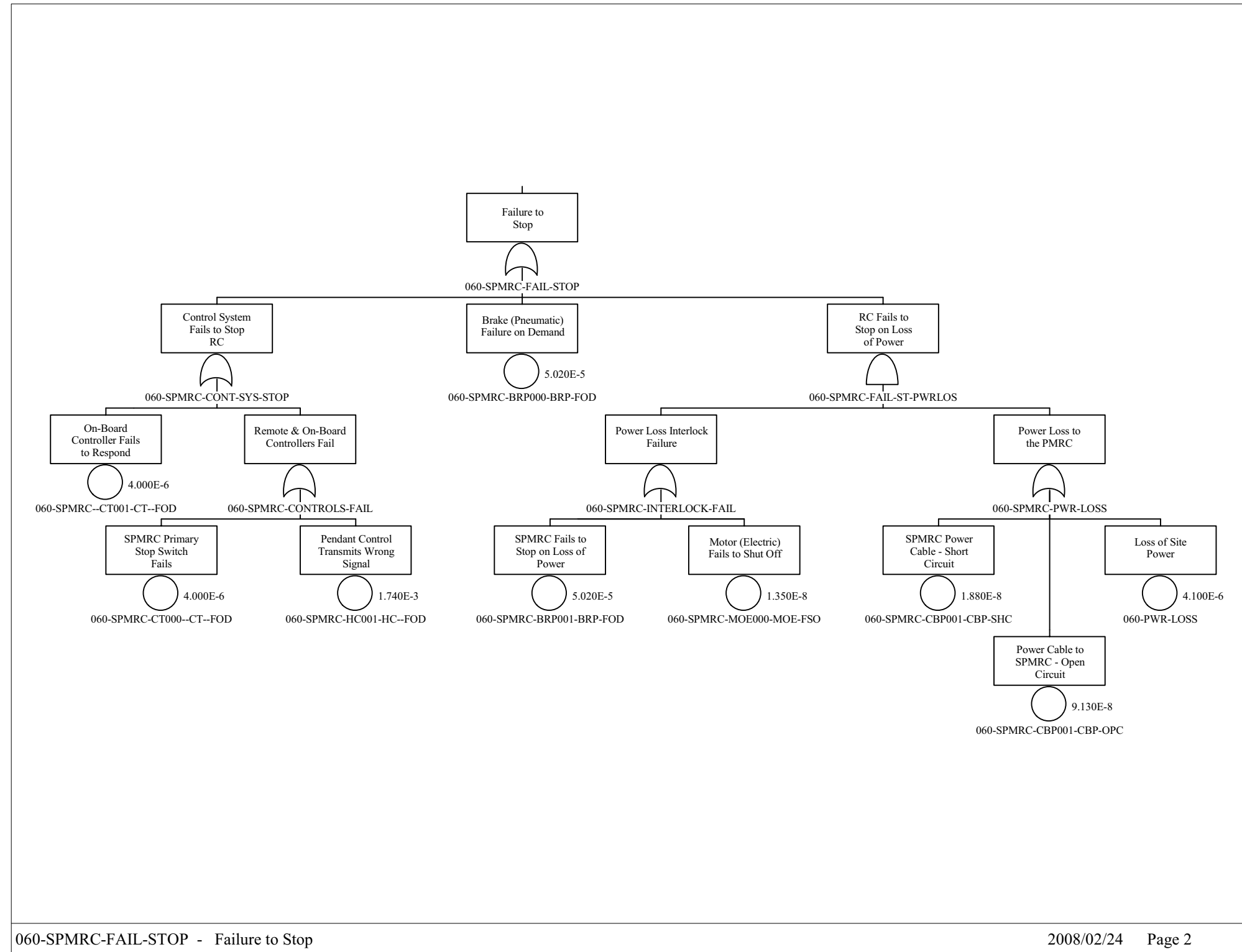

Source: Original

Figure B1.4-4. SPMRC Fail to Stop

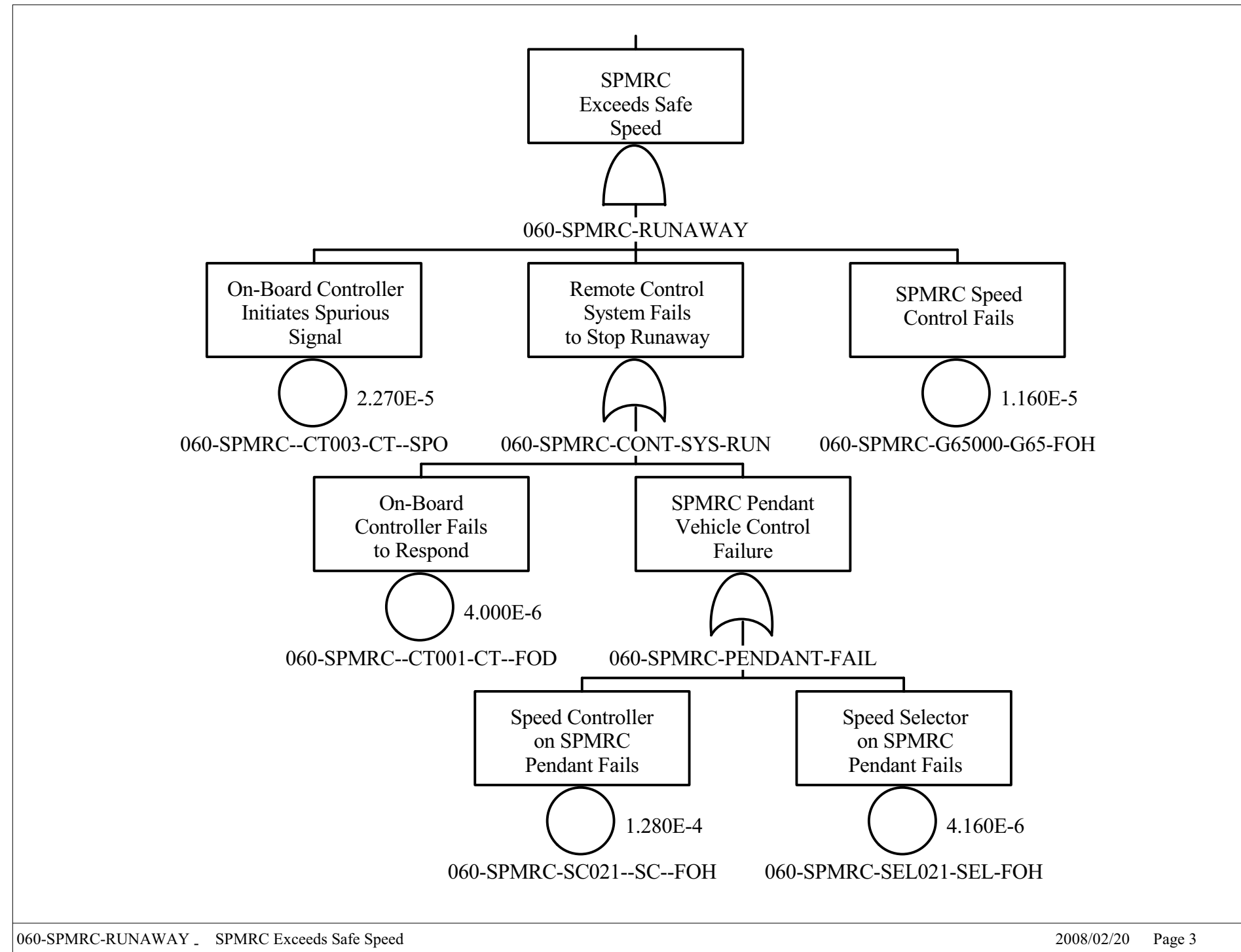

Source: Original

Figure B1.4-5. SPMRC Exceeds Safe Speed

B1.4.2 SPMTT Collides with CRCF Structures

B1.4.2.1 Description

The collision fault tree for SPMTT collision within the CRCF is identical for each type of transportation cask that is processed at the CRCF for each configuration. Collision can occur as a result of human error or mechanical failures. Mechanical failures leading to a collision consist of the SPM failure to stop when commanded, exceeding a safe speed or moving in a wrong direction.

B1.4.2.2 Success Criteria

The success criteria for preventing a collision include, safety design features incorporated in the SPM for mechanical failures, and the SPM operator maintaining situational awareness and proper control of the movement of the SPM. To avoid collisions, the SPM must stop when commanded, be prevented from entering a runaway situation, and respond correctly to a SPM movement command.

The SPM is designed to stop whenever commanded to stop or when there is a loss of power. The operator can stop the SPM by either commanding a “stop” from the start/stop button, or by releasing the palm switch which initiates an emergency stop. At anytime there is a loss of power detected, the SPM immediately stops all movement and enters into a “lock mode,” safe state. The SPM remains in this locked mode until power is returned and the operator restarts the SPM.

Runaway situations on the SPM are prevented by hardware constraints. The maximum speed of the SPM is controlled by a speed limiter on the diesel engine for outside movement. The speed control on the SPM for in-facility operations is controlled by the physical limitations of the drive system. The SPM gearing prevents the SPM from exceeding 9 mph. The prevention of SPM movements in the wrong direction is prevented by the limitations of the power plant that prevents simultaneous operations.

B1.4.2.3 Design Requirements and Features

Requirements

Two means of stopping the SPM are incorporated in the controllers. One is the normal stop button and the other consists of an emergency stop that has the equivalent of a “deadman switch.” On the loss of AC, the SPM performs a controlled stop. Once stopped, the SPM enters the “lock mode,” safe state. The “lock mode,” safe state is reversible without specific operator action. The SPM remains in this fail safe mode until power is returned and the operation restarts the SPM.

Since the dominant contributor to SPMTT collision in the facility is human error, no priority is given to either the remote or the pendant controllers. The SPM is operated on electrical power when inside the building. The SPM is disconnected from the railcar within the Cask Preparation Room and moved out of the building before cask preparation activities begin.

Design Features

Stopping the SPM is accomplished by pushing the “stop” button on the remote or pendant controller. The SPM, upon receiving a stop command from either control source, immediately responds by removing power from the propulsion system.

The SPM has two off-equipment control devices that have complete control over the SPMTT. The drive system contains both a governor and a transmission constraint which limits the maximum speed of the SPM to 9.0 miles per hour.

Testing and Maintenance

Requirements

No maintenance or testing permitted on a SPM loaded with a transportation cask.

Design Feature

None.

B1.4.2.4 Fault Tree Model

The fault tree model for “SPMTT Collides with CRCF Structures,” accounts for both human error and for SPMTT hardware problems that could result in collision. There is only one movement within the CRCF. Once the SPMTT has been properly positioned with the Cask Preparation Room, the SPM is decoupled from the truck trailer and it is moved out of the facility.

The fault trees for SPMRC and SPMTT are identical and a split fraction is used to account for the number/type of transportation casks that arrive at the CRCF on either the railcar or truck trailer.

The top event is a collision of the SPMTT in the CRCF and is shown in Figure B1.4-8. This may occur due to human error coupled with failure of the speed control or interlocks, or failure of the mechanical and/or control system including failure to stop (Figure B1.4-9) or exceeding a safe speed (Figure B1.4-10). Failure to stop may occur due to mechanical failure of brakes, or failure of the control system. Exceeding a safe speed may also occur due to failure of the control system.

B1.4.2.5 Basic Event Data

Table B1.4-4 contains a list of basic events used in the “SPMTT Collides with CRCF Structures” fault trees. The mission time has been set at one hour. This is a conservative estimate since it does not require one hour to move the truck trailer into the facility, disconnecting the SPM from the truck trailer and move the SPM back outside the facility.

Table B1.4-4. Basic Event Probability for SPMTT Collides with CRCF Structures

Name	Calc. Type ^a	Calc. Prob.	Fail. Prob.	Lambda	Miss. Time ^a
060-OPTTCOLLIDE1-HFI-NOD	1	3.00E-03	3.00E-03	0.00E+00	0.00E+00
060-OPTTINTCOL01-HFI-NOD	1	1.00E+00	1.00E+00	0.00E+00	0.00E+00
060-OPTTINTCOL02-HFI-NOD	1	1.00E+00	1.00E+00	0.00E+00	0.00E+00
060-PWR-LOSS-2	1	4.10E-06	4.10E-06	0.00E+00	1.00E+00
060-SPMTT-STU001-STU-FOH	3	4.81E-08	0.00E+00	4.81E-08	1.00E+00
060-SPMTT-BRK001-BRP-FOD	1	5.02E-05	5.02E-05	0.00E+00	0.00E+00
060-SPMTT-BRK000-BRP-FOD	1	5.02E-05	5.02E-05	0.00E+00	1.00E+00
060-SPMTT-CBP003-CBP-SHC	3	1.88E-08	0.00E+00	1.88E-08	1.00E+00
060-SPMTT-CBP002-CBP-OPC	3	9.13E-08	0.00E+00	9.13E-08	0.00E+00
060-SPMTT-CPL000-CPL-FOH	3	1.91E-06	0.00E+00	1.91E-06	1.00E+00
060-SPMTT-CT000--CT--FOD	1	4.00E-06	4.00E-06	0.00E+00	1.00E+00
060-SPMTT--CT001-CT--FOD	1	4.00E-06	4.00E-06	0.00E+00	1.00E+00
060-SPMTT-CT002--CT--FOH	3	6.88E-05	0.00E+00	6.88E-05	1.00E+00
060-SPMTT--CT001-CT--SPO	3	2.27E-05	0.00E+00	2.27E-05	1.00E+00
060-SPMTT-G65000-G65-FOH	3	1.16E-05	0.00E+00	1.16E-05	1.00E+00
060-SPMTT-HC002--HC--SPO	3	5.23E-07	0.00E+00	5.23E-07	1.00E+00
060-SPMTT-HC001-HC--FOD	1	1.74E-03	1.74E-03	0.00E+00	1.00E+00
060-SPMTT-IEL102-IEL-FOD	1	2.75E-05	2.75E-05	0.00E+00	1.00E+00
060-SPMTT-MOE000-MOE-FSO	3	1.35E-08	0.00E+00	1.35E-08	1.00E+00
060-SPMTT-SC021--SC--FOH	3	1.28E-04	0.00E+00	1.28E-04	1.00E+00
060-SPMTT-SEL021-SEL-FOH	3	4.16E-06	0.00E+00	4.16E-06	1.00E+00

NOTE: ^a For Calc. Type 3 with a mission time of 0, SAPHIRE performs the quantification using the system mission time.

Calc. = calculation; Fail. = failure; Miss. = mission; SPMTT = site prime mover truck trailer.

Source: Original

B1.4.2.5.1 Human Failure Events

Three human errors have been identified for this fault tree. Section 6.4 and Attachment E contain a detailed analysis on the derivation of the failure data.

1. Operator causes collision (060-OPTTCOLLIDE1-HFI-NOD).
2. Operator initiates runaway (060-OPTTINTCOL01-HFI-NOD).
3. Operator causes a collision with mobile platform (060-OPTTINTCOL02-HFI-NOD).

B1.4.2.5.2 Common-Cause Failures

There are no CCFs identified for this fault tree.

B1.4.2.6 Uncertainty and Cut Set Generation Results

Figure B1.4-6 contains the uncertainty results obtained from running the fault tree for “SPMTT Collides with CRCF Structures” using a cutoff probability of 1E-12. Figure B1.4-7 provides the cut set generation results for the “SPMTT Collides with CRCF Structures” fault tree.

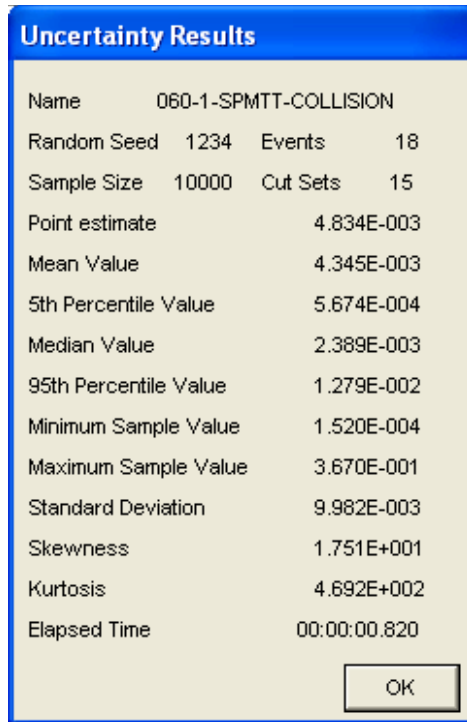

Source Original

Figure B1.4-6. Uncertainty Results of the SPMTT Collides with CRCF Structures Fault Tree

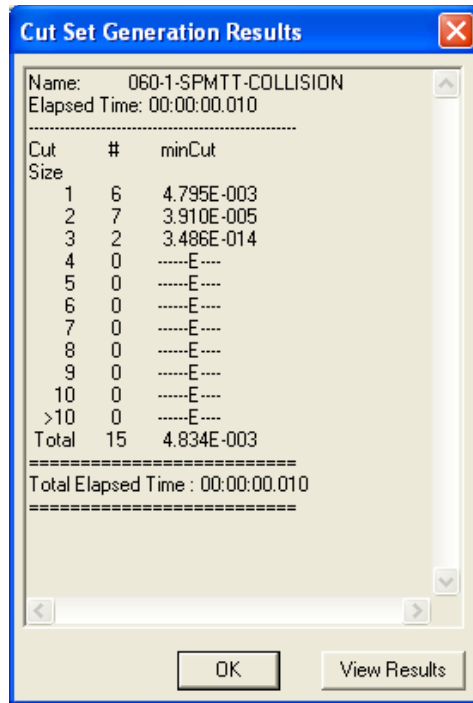

Source: Original

Figure B1.4-7. Cut Set Generation Results for the SPMTT Collides with CRCF Structures Fault Tree

B1.4.2.7 Cut Sets

Table B1.4-5 contains the cut sets for “SPMTT Collides with CRCF Structures.” The probability of failure is 4.83E-03.

Table B1.4-5. Cut Sets for SPMTT Collides with CRCF Structures

Fault Tree	Cut Set %	Prob./Freq.	Basic Event	Description	Probability
060-1-SPMTT-COLLISION	62.07	3.000E-003	060-OPTTCOLLIDE1-HFI-NOD	Operator Causes Collision of TT	3.0E-003
	36.00	1.740E-003	060-SPMTT-HC001-HC--FOD	Remote Control Transmits Wrong Signal	1.7E-003
	1.04	5.020E-005	060-SPMTT-BRK000-BRP-FOD	Pneumatic Brakes on SPMTT Fail on Demand	5.0E-005
	0.57	2.750E-005	060-OPTTINTCOL02-HFI-NOD	Operator Causes Collision with Mobile Platform	1.0E+000
			060-SPMTT-IEL102-IEL-FOD	Failure of Mobile Platform Anti-Collision Interlock	2.8E-005
	0.24	1.160E-005	060-OPTTINTCOL01-HFI-NOD	Operator Initiates Runaway	1.0E+000

Table B1.4-5. Cut Sets for SPMTT Collides with CRCF Structures (Continued)

Fault Tree	Cut Set %	Prob./Freq.	Basic Event	Description	Probability
			060-SPMTT-G65000-G65-FOH	SPMTT Speed Control Fails	1.2E-005
	0.08	4.000E-006	060-SPMTT--CT001-CT--FOD	On-Board Controller Fails to Respond	4.0E-006
	0.08	4.000E-006	060-SPMTT-CT000--CT--FOD	SPMTT Primary Stop Switch Fails	4.0E-006
	0.04	1.910E-006	060-SPMTT-CPL000-CPL-FOH	Truck Trailer Automatic Coupler System Fails	1.9E-006
	0.00	2.058E-010	060-PWR-LOSS-2	Loss of Power	4.1E-006
			060-SPMTT-BRK001-BRP-FOD	SPMTT Pneumatic Brakes Fail	5.0E-005
	0.00	4.583E-012	060-SPMTT-BRK001-BRP-FOD	SPMTT Pneumatic Brakes Fail	5.0E-005
			060-SPMTT-CBP002-CBP-OPC	SPMTT Power Cable - Open Circuit	9.1E-008
	0.00	9.438E-013	060-SPMTT-BRK001-BRP-FOD	SPMTT Pneumatic Brakes Fail	5.0E-005
			060-SPMTT-CBP003-CBP-SHC	SPMTT Power Cable - Short Circuit	1.9E-008
	0.00	5.535E-014	060-PWR-LOSS-2	Loss of Power	4.1E-006
			060-SPMTT-MOE000-MOE-FSO	Motor (Electric) Fails to Shut Off	1.4E-008
	0.00	3.370E-014	060-SPMTT--CT001-CT--SPO	On-Board Controller Spurious Operation	2.3E-005
			060-SPMTT-G65000-G65-FOH	SPMTT Speed Control Fails	1.2E-005
			060-SPMTT-SC021--SC--FOH	Speed Controller on SPMTT Pendant Fails	1.3E-004
	0.00	1.233E-015	060-SPMTT-CBP002-CBP-OPC	SPMTT Power Cable - Open Circuit	9.1E-008
			060-SPMTT-MOE000-MOE-FSO	Motor (Electric) Fails to Shut Off	1.4E-008
	0.00	1.095E-015	060-SPMTT--CT001-CT--SPO	On-Board Controller Spurious Operation	2.3E-005
			060-SPMTT-G65000-G65-FOH	SPMTT Speed Control Fails	1.2E-005
			060-SPMTT-SEL021-SEL-FOH	Speed Selector on SPMTT Pendant Fails	4.2E-006
		4.834E-003	= Total		

NOTE: Freq. = frequency; Prob. = probability; SPMTT = site prime mover truck trailer; TT = truck trailer.

Source: Original

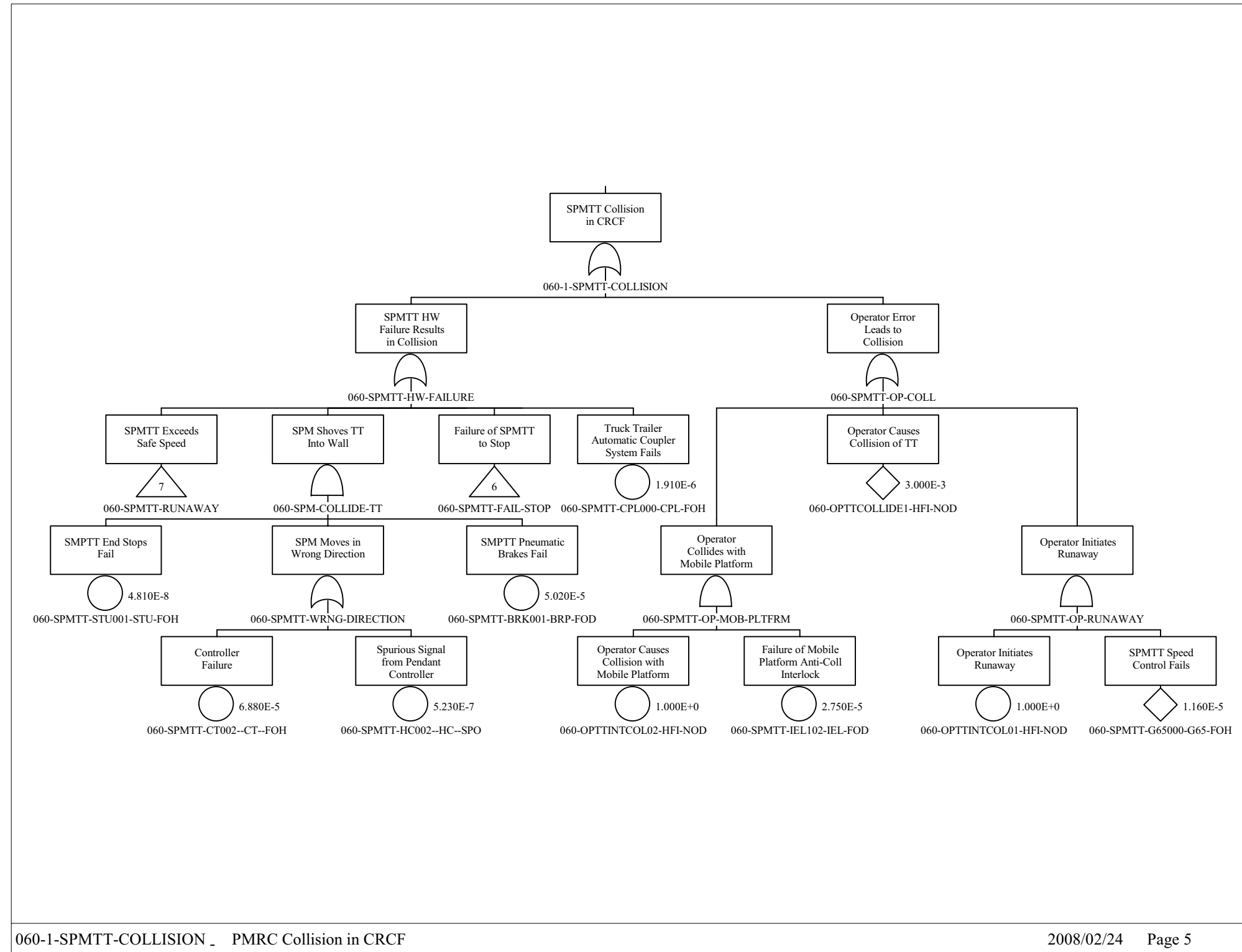

Source: Original

Figure B1.4-8. SPMRC Collision in CRCF

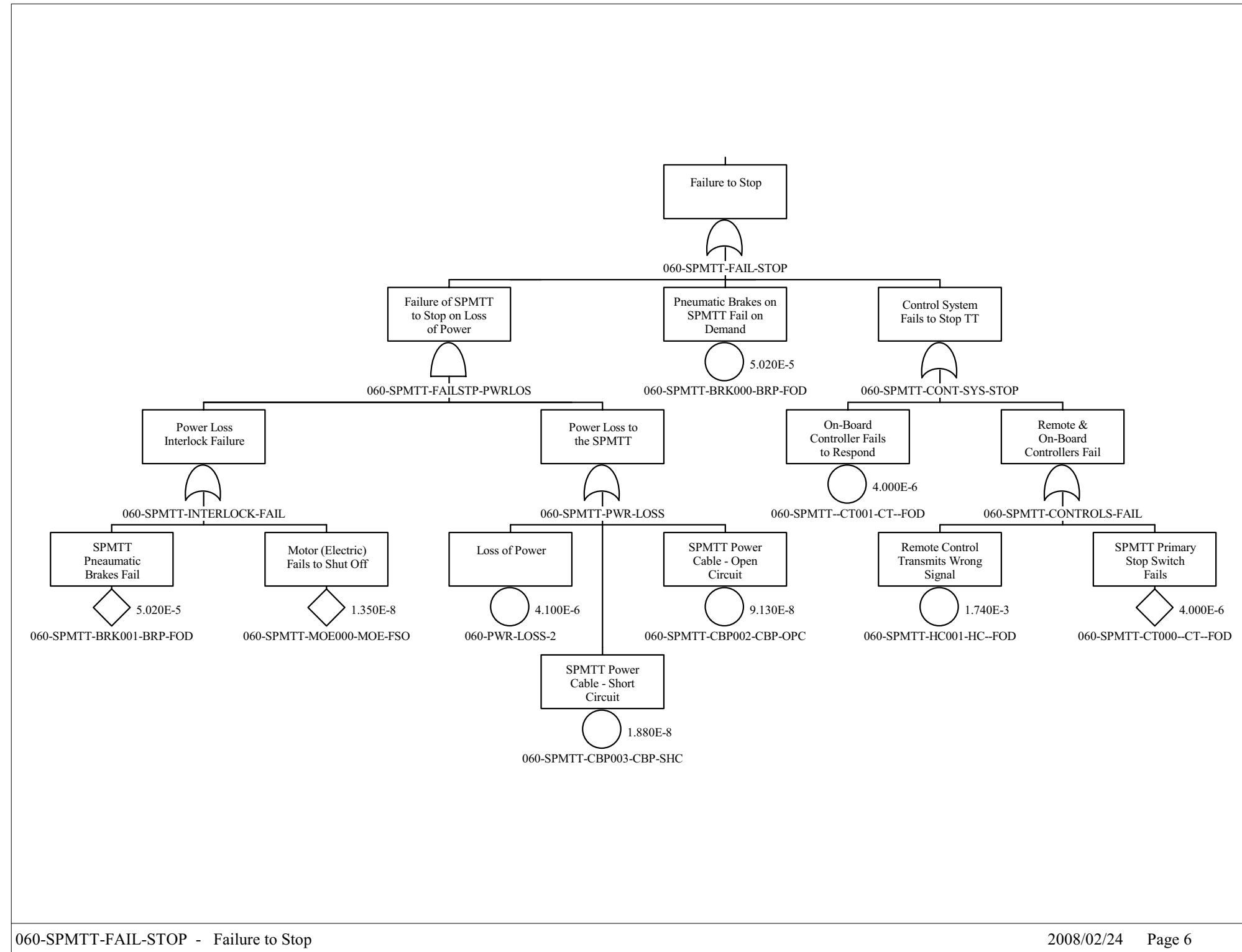

Source: Original

Figure B1.4-9. SPMTT Failure to Stop

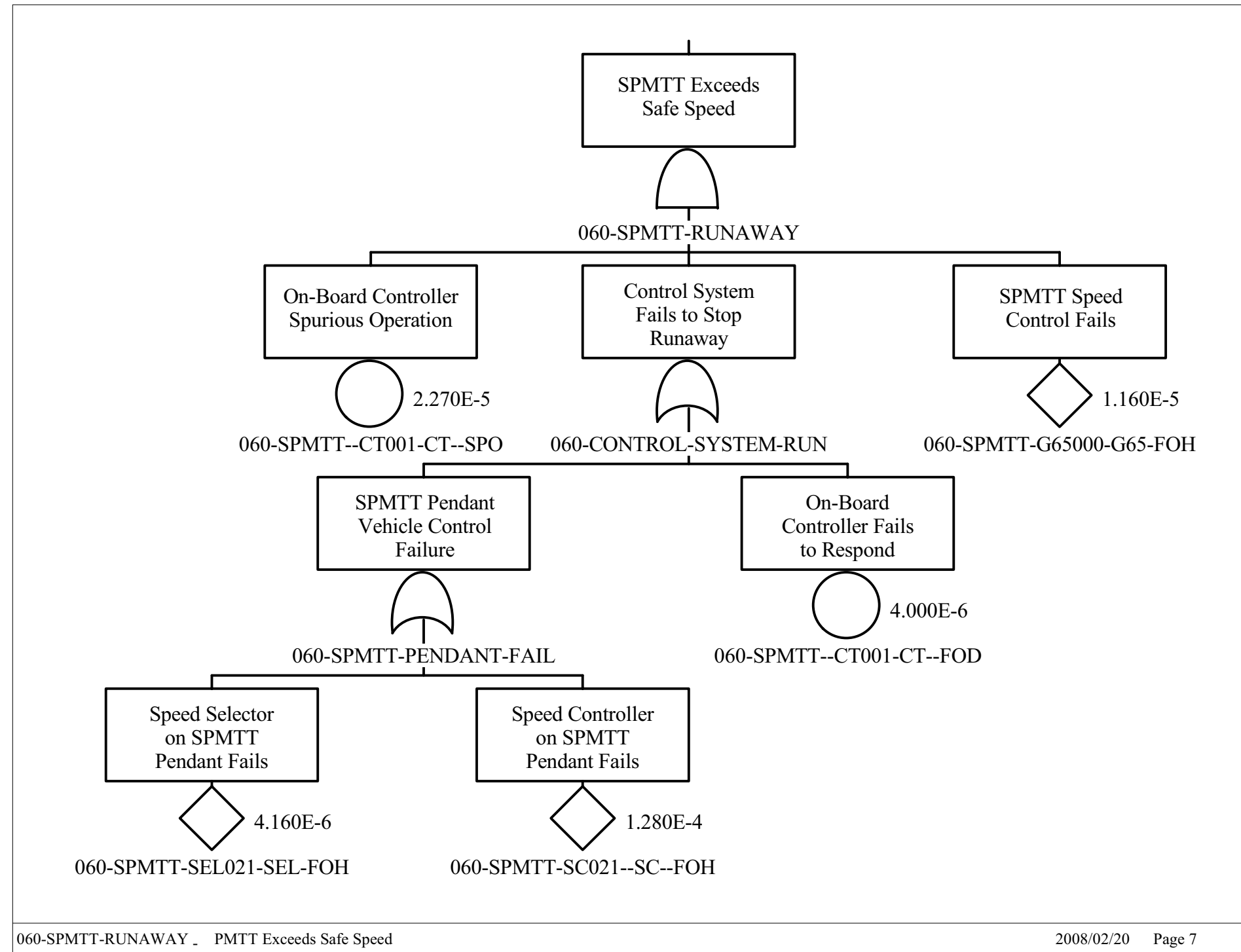

Source: Original

Figure B1.4-10. SPMTT Exceeds Safe Speed

B1.4.3 SPMRC Derailment

B1.4.3.1 Description

The fault trees for SPMRC derailment within the CRCF are identical for each type of transportation cask. Derailment is characterized by a basic event that accounts for the probability of a railcar derailment per mile of travel within the CRCF.

This fault tree considers the potential for the SPM to derail during movement of the railcar to the preparation area. The top event is “SPMRC Derails Causing Impact to Transportation Cask.” This fault tree is shown in Figure B1.4-14.

The probability of derailment is based on historical data for train derailment at low speeds and is discussed in the section on data development. The probability of derailment per mile is multiplied by the number of miles the SPM travels from the vestibule to the Cask Preparation Room (approximately 4E-2 miles). Detailed analysis for this basic event is contained in Attachment C.

B1.4.3.2 Success Criteria

The success criterion is that the SPMRC does not derail during the transport process.

B1.4.3.3 Design Requirements and Features

System Configuration and Operating Conditions

Requirements

The railcar design requirements comply with AAR Standard S-2043 (Ref. B1.1.1)

Features

The design features of the railcar are in compliance with AAR Standard S-2043 (Ref. B1.1.1).

Testing and Maintenance

Requirements

No maintenance or testing permitted on a railcar loaded with a transportation cask.

Features

None

B1.4.3.4 Fault Tree Model

The fault tree model for “SPMRC Derailment” consists of the probability for a railcar derailment per mile of travel time multiplied by the number of occurrences for each type of transportation cask. The fault tree model is shown in Figure B1.4-13.

B1.4.3.5 Basic Event Data

Table B1.4-6 contains a list of basic events used in the “SPMRC Derailment” fault tree.

Table B1.4-6. Basic Event Probability for SPMRC Derailment

Name	Calc. Type ^a	Calc. Prob.	Fail. Prob.	Lambda	Miss. Time ^a
060-SPMRC-DERAIL-DER-FOM	1	1.180E-005	1.180E-005	0.000E+000	0.000E+000
060-SPMRC-MILES-IN-CRCF	1	4.000E-002	4.000E-002	0.000E+000	0.000E+000

NOTE: ^a For Calc. Type 3 with a mission time of 0, SAPHIRE performs the quantification using the system mission time.

Calc. = calculation; Fail. = failure; Miss. = mission; Prob. = probabilities; SPMRC = site prime mover railcar.

Source: Original

The calculated probability of a derailment inside the CRCF is the probability of a railcar derailing per mile of travel, times the distance travelled within the facility.

B1.4.3.5.1 Human Failure Events

There are no human errors identified for this fault tree.

B1.4.3.5.2 Common-Cause Failures

There are no CCFs identified for this fault tree.

B1.4.3.6 Uncertainty and Cut Set Generation Results

Figure B1.4-11 contains the uncertainty results obtained from running the fault tree for “SPMRC Derailment” using a cutoff probability of 1E-12. Figure B1.4-12 provides the cut set generation results for the “SPMRC Derailment” fault tree.

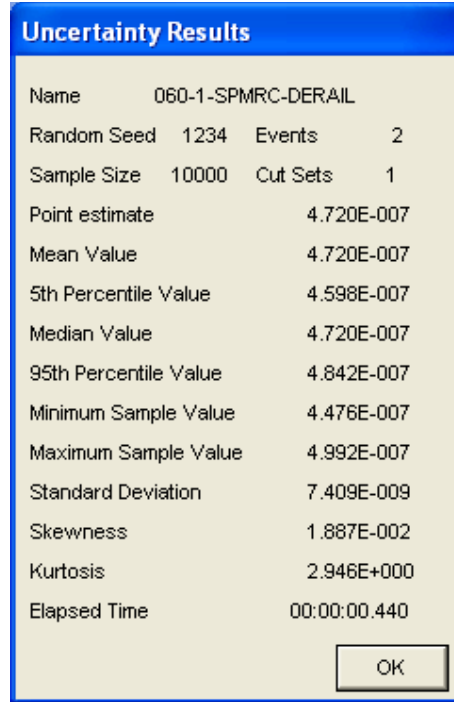

Source: Original

Figure B1.4-11. Uncertainty Results of the SPMRC Derailment Fault Tree

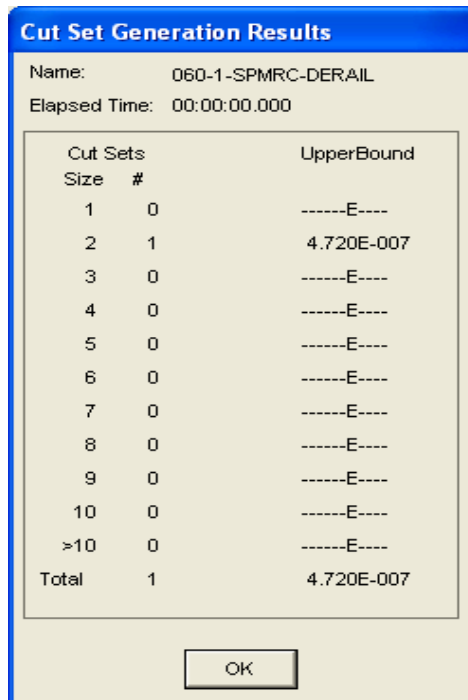

Source: Original

Figure B1.4-12. Cut Set Generation Results for SPMRC Derailment

B1.4.3.7 Cut Sets

Table B1.4-7 contains the cut sets for “SPMRC Derailment.” The probability of derailment per cask is 4.72E-7.

Table B1.4-7. Cut Sets for SPMRC Derailment

Fault Tree	Cut Set %	Prob./Freq.	Basic Event	Description	Probability
060-1-SPMRC- DERAIL	100.00	4.720E-007	060-SPMRC-DERAIL--DER-FOM	Derailment of a railcar per mile	1.2E-005
			060-SPMRC-MILES-IN-CRCF	Miles Traveled in CRCF	4.0E-002
		4.720E-007	= Total		

NOTE: CRCF = Canister Receipt and Closure Facility; Freq. = frequency; Prob. = probability; SPMRC = site prime mover railcar.

Source: Original

B1.4.3.8 Fault Trees

The fault tree for SPMRC derailment in the CRCF is shown in Figure B1.4-13

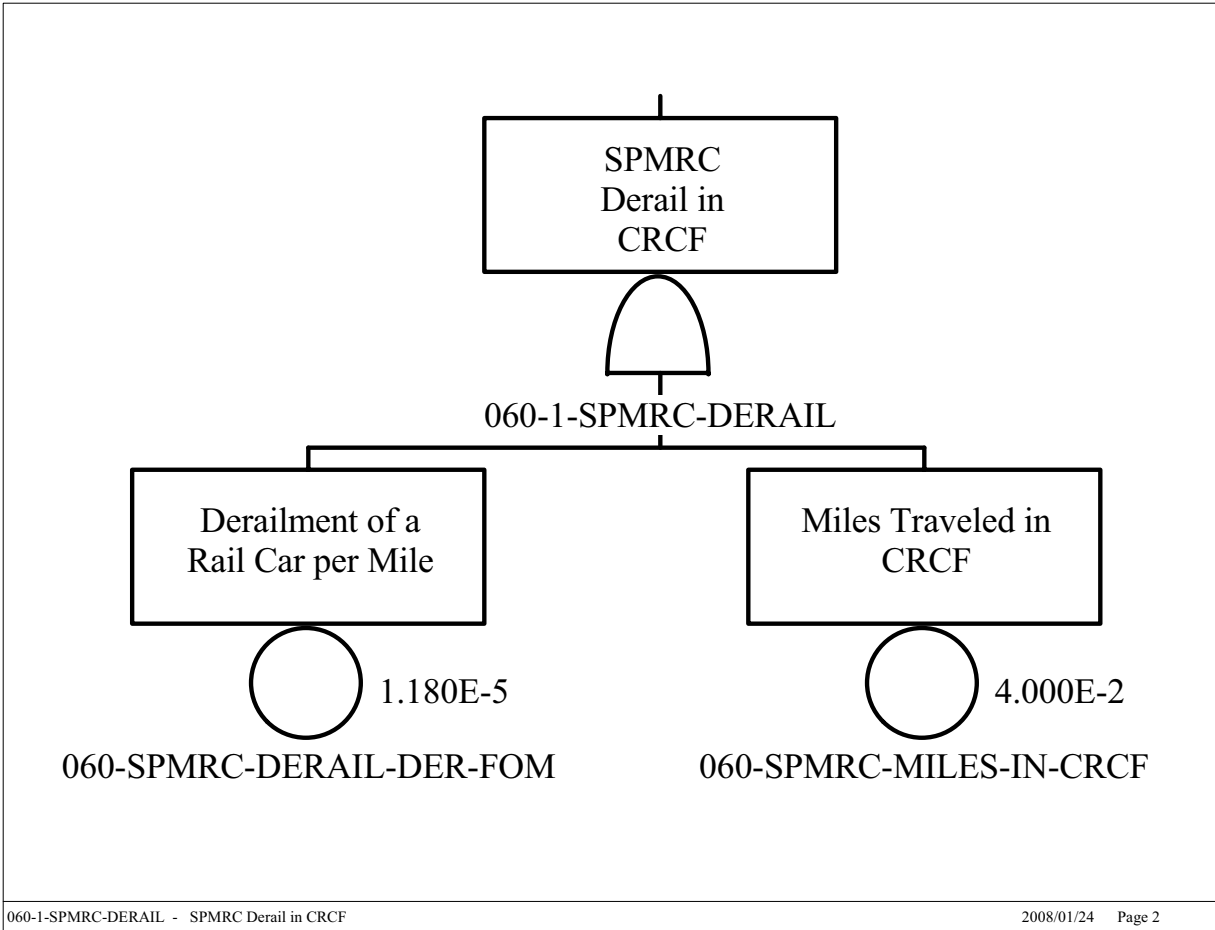

Source: Original

Figure B1.4-13. SPMRC Derailment in CRCF

B1.4.4 SPMTT Rollover in CRCF

B1.4.4.1 Description

The fault trees for “SPMTT Rollover in the CRCF” are identical for each type of transportation cask. Rollover is characterized by a human error basic event that accounts for the probability of an operator jackknifing the truck trailer while backing through the CRCF vestibule areas into the Cask Preparation Room.

During movement, a rail track failure, obstacle on the track, or a structural failure on the railcar could potentially lead to a rollover. For the truck trailer, an obstacle on the road or a structural failure on the trailer could potentially lead to a rollover. There are no design constraints for these types of failures; to prevent this situation relies on an operator response to initiate an emergency stop command. Since this is a recovery action, no credit is taken for the operator response.

B1.4.4.2 Success Criterion

The design of the SPM prevents the majority of scenarios that could potentially cause a SPM rollover. A low center of gravity and a wide footprint of the railcar/truck trailer results in a stable platform during movements. In addition, the CRCF vestibule is too small in length and width for a jackknife to occur resulting in a roll over

The success criterion is that no rollover occurs while transferring the trailer into the CRCF with the SPM.

B1.4.4.3 Design Requirements and Features

System Configuration and Operating Conditions

The design of the SPM prevents the majority of scenarios that could potentially cause a SPM rollover. A low center of gravity and a wide footprint of the railcar/truck trailer results in a stable platform during movements.

Requirements

Trailers used for the movement of transportation casks are designed in accordance with the requirements contained in NHTSA requirements as authorized by 49 USC Part 301 Motor Vehicle Safety: Standards and Compliance, Section 30111 (Ref. B1.1.2). The requirements are delineated in 49 CFR Part 571 Transportation: Federal Motor Vehicle Safety Standards (Ref. B1.1.3).

While backing the SPMTT through the Entry Vestibule and to the Cask Preparation Room, at a minimum one walker-spotter is required to ensure no objects are in the path of the SPMTT and to stop the driver from continuing to back up if a jackknife situation with the trailer begins to occur.

Design Features

Not applicable.

TESTING AND MAINTENANCE

Requirements

There is no maintenance or testing permitted on a truck trailer loaded with a transportation cask.

Design Feature

None.

B1.4.4.4 Fault Tree Model

The fault tree model for SPMTT rollover (Figure B1.4-14) consists of a single human error associated with the operator jackknifing the truck trailer when positioning it into the CRCF.

B1.4.4.5 Basic Event Data

A rollover within the CRCF can only occur if the driver of the SPMTT jackknifes the truck trailer.

There is only one basic event consisting of a human error causing a jackknife of the trailer shown in Figure B1.4-14. The human reliability analysis assesses a 0.000E+00 probability of this occurring.

B1.4.4.5.1 Human Failure Events

The human error probability of causing a jackknife of the trailer has been assessed as zero due to presence of a walker/spotter (see Section 6.4 and Attachment E).

B1.4.4.5.2 Common -Cause Failures

There are no CCFs identified for this fault tree.

B1.4.4.6 Uncertainty and Cut Set Generation Results

Because there is only a single basic event assessed as having zero probability of occurrence, there is no uncertainty or cut set to be calculated.

B1.4.4.7 Fault Tree

The fault tree model for SPMTT rollover is shown in B1.4-14.

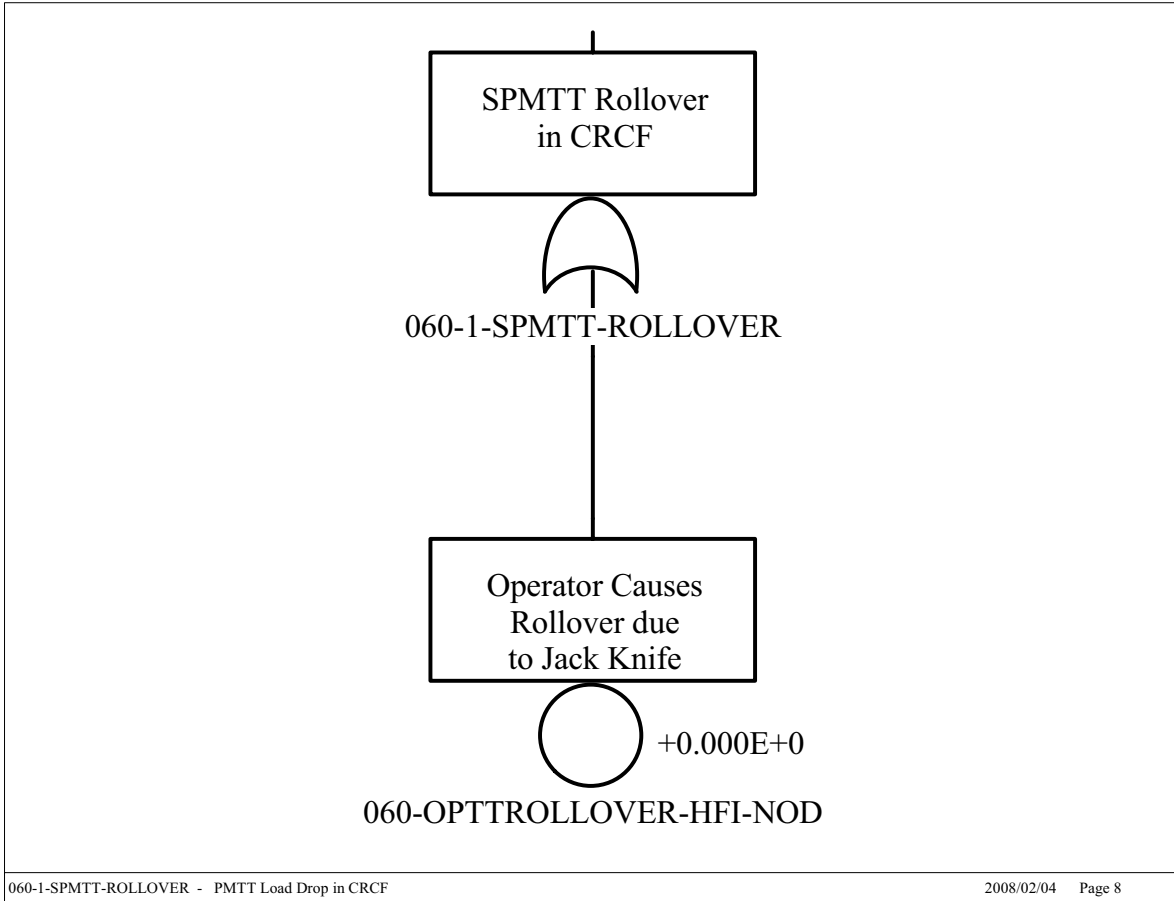

Source: Original

Figure B1.4-14. SPMTT Rollover in CRCF

B2 CASK TRANSFER TROLLEY ANALYSIS

B2.1 REFERENCES

Design Inputs

The PCSA is based on a snapshot of the design. The reference design documents are appropriately documented as design inputs in this section. Since the safety analysis is based on a snapshot of the design, referencing subsequent revisions to the design documents (as described in EG-PRO-3DP-G04B-00037, *Calculations and Analyses* (Ref. 2.1.1, Section 3.2.2.F)) that implement PCSA requirements flowing from the safety analysis would not be appropriate for the purpose of the PCSA.

The inputs in the Section noted with an asterisk (*) indicate that they fall into one of the designated categories described in Section 4.1, relative to suitability for intended use.

- B2.1.1 BSC (Bechtel SAIC Company) 2007. *Mechanical Handling Design Report for Cask Transfer Trolley*. 000-30R-HM00-00200-000-001. Las Vegas, Nevada: Bechtel SAIC Company. ACC: ENG.20071219.0001.
- B2.1.2 *BSC 2007. *Preliminary Throughput Study for the Canister Receipt and Closure Facility*. 060-30R-CR00-00100-000-001. Las Vegas, Nevada: Bechtel SAIC Company. ACC: ENG.20071101.0001.
- B2.1.3 *Morris Material Handling 2007. *P&ID – Cask Transfer Trolley*. V0-CY05-QHC4-00459-00029-001 Rev. 005. Oak Creek, Wisconsin: Morris Material Handling. ACC: ENG.20071019.0003.

B2.2 CASK TRANSFER TROLLEY DESCRIPTION

B2.2.1 Overview

The cask transfer trolley (CTT) is an air powered machine that is used to transport various vertically oriented transportation casks from the Cask Preparation Room to the Cask Unloading Room. The trolley consists of a platform, a cask support assembly, a pedestal assembly, a seismic restraint system, and an air system as illustrated in Figure B2.2-1.

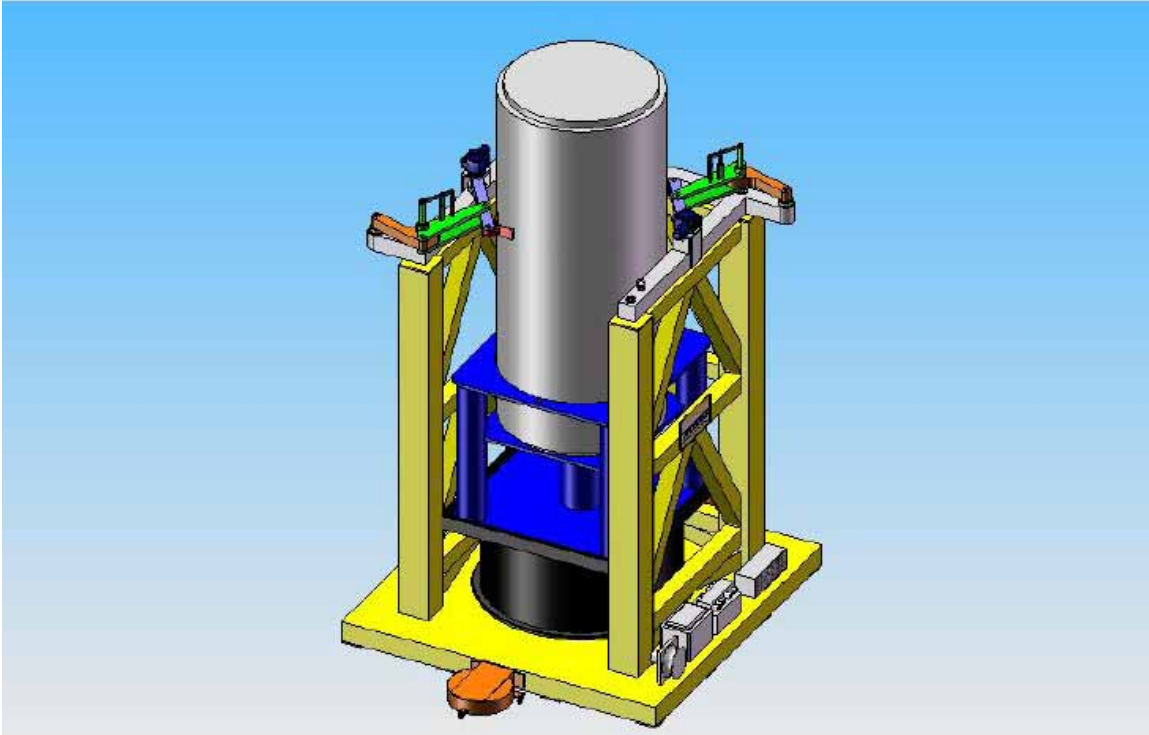

Source: Modified from Ref. B2.1.1

Figure B2.2-1. Cask Transfer Trolley

The platform, or main deck, is the main support structure for the trolley. The structure is designed to hold the air bearings under the deck and simultaneously support the cask support assembly and cask. The cask support assembly is the truss work that is welded to the platform and cradles three sides of the cask. The cask support assembly provides the structural support for the seismic restraint system and pedestal assembly to hold the cask during an earthquake or collision event.

The CTT must handle a number of different types of casks; consequently, several different pedestals are used to properly position the top of the cask at the appropriate height above the floor. Each pedestal sub-component is designed for its respective cask to sit down in a “cavity.” The depth of the cavity is a minimum of 6 in. which is sufficient to prevent the cask from exiting from the pedestal due to uplift during the worst case seismic event. In addition, the cask is restrained in the longitudinal and transverse directions by the cavity walls and restrained in the vertical down direction by the pedestal itself.

This design also ensures the cask is positioned in the correct position in the trolley. The trolley is positioned within a set tolerance under the cask transfer port in the Canister Transfer Room using bumpers and stops that are bolted to the floor with bolts that shear to allow the CTT to slide during a significant seismic event.

In addition to the cask being restrained at the bottom by the pedestal assembly, the upper section of the cask is restrained to prevent side motions during a seismic event. The system is made up of two linkage systems that are mounted on opposite corners of the cask support assembly. An electric motor extends and retracts the restraint brackets to predetermined positions. Different cask diameters are handled by bolting unique interface clamps onto the seismic restraints.

When the restraint system is properly positioned next to the cask, a locking pin is air actuated to secure the system. This solid, high strength, alloy, locking pin can withstand the shear stresses that would be experienced during a seismic event. Both locking pins are monitored by proximity switches (or limit switches) that are hard wired to the control system to verify the pins are in place. If the locking pins are not secured properly, the CTT is not able to power up and move/levitate.

The facility compressed air supply inflates nine 54 inch diameter air casters beneath the trolley platform. Each air caster consists of a urethane, torus-shaped bag with a chamber inside the torus. The air film is produced when air is distributed to each air caster causing the air bags to inflate. The inflated bags create a seal against the floor surface and confine the air within the chambers of the bags until the air pressure is sufficient to offset the weight of the loaded trolley. The air bearings allow the CTT to rise above the steel floor approximately 1/2 inch to 7/8 inch. The air bearings are supplied with facility air (between 75-100 psi optimal) and consume from 500 to 700 scfm. A hose reel for the 1-1/2-inch diameter air hose is mounted on the platform. The reel is equipped with an air-powered return, a ball valve shut-off, quick disconnect fittings, and a safety air fuse.

A main “off/on” control valve and separate flow control/monitoring valves for each air bearing allows adjustment and verification of pressure/flow for each individual bearing. There are two interlocks for the air; one pressure monitor verifies the main incoming pressure is not too high, and a second set of monitors verifies that all bearings have sufficient air pressure. This air monitoring system for the air bearings is not important to safety and therefore, has not been analyzed.

End mounted turtle-style drive units that are 360-degrees steerable, are used to steer the CTT. Traction is produced by down-pressure on the wheels provided by a small air bag on each drive unit. Air is supplied from facility air to a high speed pneumatic motor in combination with a reducer to limit the wheel speed of the turtle drives. The maximum speed of the system is less than or equal to 10 fpm at the maximum air pressure available from the facility compressed air supply.

The CTT speed is controlled in two ways. First, the electrical control system is designed to provide a control signal to the air valve that produces a speed range of 0-10 fpm. In the event this control system fails, a factory set mechanical throttle valve, in line with each motor drive, restricts the air flow to prevent a “run-away” condition.

B2.2.2 Control System

The control system is relay-based and includes a pendant station for its operator interface.

No programmable logic controllers are used—all interlocks are hard wired. The pendant is a standard crane pendant that has all of the controls for the unit including:

- Deadman handle—The operator must press both handles to allow air to flow to the CTT to levitate and move horizontally.
- Emergency stop button— The operator presses the emergency stop button on the pendant control or on the CTT to stop the CTT
- Clockwise/counterclockwise momentary switch— The operator turns this switch to turn the drive units for horizontal movement. This rotational characteristic is used to move the CTT to the storage or maintenance location after it leaves the Cask Preparation Area.
- Forward/reverse switch— The operator uses the forward/reverse switch to determine the direction of the drive units
- Variable speed control switch—The operator uses the variable speed control switch to adjust the CTT drive speed
- Cask Restraint— The operator uses the selector switch to actuate the motor to close the restraints and automatically engage the locking pin.

During normal operations, the controls operate off a battery system contained on the CTT. Only one operator is needed to move the CTT since it only travels in one direction when it is carrying a cask. The CTT moves forward and reverse between the Canister Transfer Room and the Cask Preparation Room and is restrained from side to side by removable barriers that are mounted to the building floor.

A schematic of the control system is shown in Figure B2.2-2.

The main air supply valve is a solenoid operated pilot valve that is fail safe (i.e., it is a spring valve that closes upon loss of electrical power or loss of air pressure). The air supply valve opens when the locking restraint pins actuate the limit switches and the pendant, deadman switches are actuated.

The controls on the pendant are clockwise/counterclockwise, forward/reverse and drive speed to control the valves for the motor drives. These valves are also fail safe solenoid operated pilot valves.

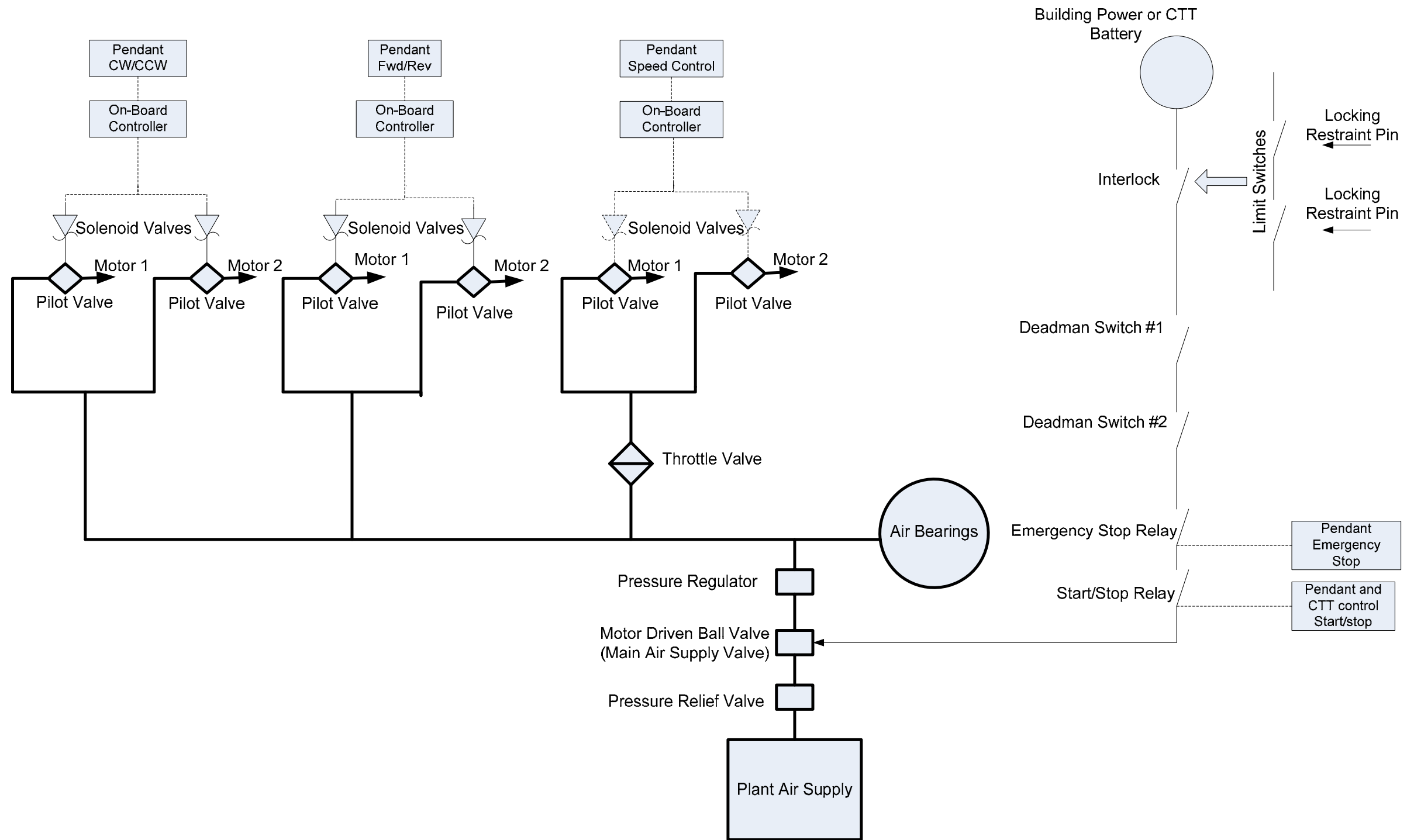

Source: Modified from Ref. B2.1.3

Figure B2.2-2. Schematic of the CTT Control System

Releasing the deadman switches or depressing the emergency-stop or start/stop buttons on the pendant control or the emergency-stop button on the CTT opens a relay to interrupt power to the main air supply valve, causing it to close. Upon closing the main supply valve, the air pressure levitating the CTT and driving the motors is reduced and the CTT lowers to the floor.

B2.2.3 Operation

B2.2.3.1 Initial Conditions

The CTT is initially located in the Cask Preparation Room, with the battery fully charged, the seismic restraints retracted, and with no air connected. Based on the next planned cask to be loaded onto the trolley, the corresponding pedestal components are installed into the base and bumpers are bolted onto the seismic restraints and supports. The air hose is then connected to the CTT.

The overhead crane moves a cask onto the pedestal. With the cask still attached to the crane, the operator remotely operates the seismic restraints and secures the cask to the CTT by extending the electric motor driven actuators. When the restraints are in place, the locking pins are pneumatically inserted. With the cask secured to the trolley, the overhead crane is disengaged from the cask.

When the locking pins are inserted properly (thus locking the seismic restraints in place), a pair of proximity switches (limit switches) de-activates the interlock, and the main air supply valve can be opened to allow the air bearings and drive motors can be operated. Once all preparations of the cask are complete, the trolley can be moved to the Canister Transfer Room using the pendant controls.

B2.2.3.2 Cask Movement

When all steps are properly completed, air is introduced to the CTT. The operator actuates the air bearings, levitating the CTT with the load. The system continuously and automatically checks the flow and pressure to each air bearing; if a problem is detected, the air supply to all bearings is stopped and the system lowers to the ground.

Once the trolley is raised, the operator drives the CTT into the Cask Unloading Room. By moving forward and reverse, the CTT is driven through the door way. Guides bolted to the floor ensure that the CTT can only move forward and back, and in addition, will ensure that the CTT is properly positioned directly below the transfer port. Once in position, the air flow to the bearings is stopped and the CTT lowers to the ground and rests in position. The operator disconnects the quick-disconnect air hose and rewinds the hose onto the trolley. The shield doors that separate the Cask Preparation Room from the Cask Unloading Room are then closed.

B2.2.3.3 System/Pivotal Event Success Criteria

Success criteria for loading a cask onto the CTT at the Cask Preparation Room, and unloading the canisters from the cask in the Cask Unloading Room, require the CTT remain stationary during these operations with no spurious movement. Success criteria for moving the CTT with

cask from the preparation area to the transfer area requires the CTT to travel at an allowable speed, and the operator is able to control the CTT movement.

During cask loading at the preparation area, compressed air must be available to the CTT to remotely insert the locking pins into the restraint system. Both pin interlocks must function before the main air supply valve can be opened thereby preventing movement of the CTT until the cask has been loaded and restrained. Once the locking pins are in place the crane is removed from the cask. During the time the crane is being removed from the cask, the air supply valve is closed and the valves that control the air to the air bags and motors are closed. Movement is not initiated until both deadman switches on the remote pendant control are pressed to allow air to the air bags to levitate the CTT.

Upon the CTT reaching the Cask Unloading Room, procedures require that the air supply hose be disconnected and removed from the CTT to prevent any movement while unloading the canisters from the cask. This is accomplished by locating the air supply unit outside the Cask Unloading Room. An interlock prevents the transfer port slide gate from opening until the shield door to the transfer room is closed. Thus, because the air supply unit is external to the Cask Unloading Room, the air hose must be removed from the CTT before the shield door can be closed, and the shield door must be closed before the port slide gate can be opened allowing canister transfer from the cask. Therefore, the location of the air supply unit and the shield door interlock requires removal of the air supply from the CTT before canister transfer can begin.

When moving the cask between the Cask Preparation Room and the Cask Unloading Room, movement in the wrong direction is prevented by the guide rails bolted to the floor along the path of the CTT. This forces the CTT to move only in a straight line forward and back between the two areas. Runaway of the CTT is prevented by the throttle valve which is set at the factory such that the maximum speed is 10 fpm at the maximum facility air pressure.

The CTT is stopped to prevent a collision into a closed shield door or the end stops in the transfer room by the operator speed controls on the pendant, by the deadman switches on the pendant or the CTT, or by the emergency stop buttons on the pendant and on the CTT. The speed controls slow down and stop the CTT by controlling the drive speed valve, and the deadman switches and emergency stop buttons remove power to the main air supply valve causing it to close. Because the emergency stop function is a recovery action performed by the operator and requires operator intervention, these functions were not modeled in the analysis.

On loss of electrical power from the battery, the air valves all fail closed, and no air will pass through to the air bearings or drive units and the CTT settles to the floor. If the air pressure and flow is lost, the unit can not levitate or move horizontally and the CTT again lowers to the floor and no other action occurs. A separate sustained signal is needed to actuate the air valves to raise the load (positive operator action). Thus, although a spurious signal may cause air to flow momentarily, additional controls need to actuate to cause the unit to levitate or move horizontally.

B2.3 DEPENDENCIES AND INTERACTIONS ANALYSIS

Dependencies are broken down into five categories with respect to their interactions with structure, systems, and components. The five areas considered are addressed in Table B2.3-1 with the following dependencies:

1. Functional dependence
2. Environmental dependencies
3. Spatial dependence
4. Human dependence
5. Failures based on external events.

Table B2.3-1. Dependencies and Interactions Analysis

Structures, Systems, and Components	Dependencies and Interactions				
	Functional	Environmental	Spatial	Human	External Events
Air supply	Provides levitation & motive force	—	—	Fail to disconnect air hose	—
Locking pin limit switches	Prevents spurious movement	—	—	—	—
Guide rails	Prevents movement in wrong direction	—	—	—	Shear during seismic event allows CTT to slide
Pendant control	Controls direction and speed and initiates movement	—	—	Wrong instructions	—
Deadman switch	Allows operation	—	—	Fail to release	—
Emergency stop	Stops CTT	—	—	Fail to energize	—
Throttle valve	Limits maximum speed	—	—	—	—
Structure	Constrains and supports cask	—	—	—	Seismic causes impact
Shield door	Opens for CTT to pass through	—	—	Close door inadvertently	Closes on CTT

NOTE: CTT = cask transfer trolley.

Source: Original

B2.4 CTT RELATED FAILURE SCENARIOS

There are four fault trees associated with the CTT:

1. Spurious movement of the CTT in the Cask Preparation Room during cask loading
2. Spurious movement of the CTT in the Cask Preparation Room during cask preparation
3. Collision of CTT during cask transfer
4. Spurious Movement of the CTT in the Canister Transfer Room.

An additional fault tree involving the CTT, is closing of the shield door on the CTT as the CTT moves a cask from the Cask Preparation Room to the Canister Transfer Room. This fault tree is described in a separate section involving inadvertent shield door closure that satisfies ESD-7, pivotal event “Collision with Cask Unloading Room Shield Door.”

In all cases a conservative mission time of one hour per cask transfer was used for each fault tree. The time required to move a cask to the trolley and disconnect the crane is approximately 55 minutes, while the time required moving the trolley from the Cask Preparation Room to the Cask Unloading Room is approximately 15 minutes. The time required to extract the canister from the cask is approximately 20 minutes (Ref. B2.1.2). Therefore, a one hour mission time is considered a conservative value.

B2.4.1 Spurious Movement of the CTT in the Cask Preparation Room during Cask Loading

B2.4.1.1 Description

This fault tree describes spurious movement of the CTT during cask loading to satisfy ESD-3, initiating event “Unplanned Carrier Movement Causes Transportation Cask Impact.” The top event is “Spurious Movement of the CTT in the Cask Preparation Room during Loading” which is defined as unplanned movement of the CTT while the cask is being loaded onto the CTT. This fault tree is shown in Figures B2.4-3 and B2.4-4.

Spurious movement can be caused by equipment failures, or by a combination of equipment failure and operator error. For equipment failures to cause spurious movement the main air supply valve must open to supply air to the air bags to levitate the CTT. This can occur if the main air supply valve fails open or the locking pin limit switches and control system fail causing the valve to open (Figure B2.4-4). For the operator to initiate spurious movement, the locking pin limit switches must fail allowing the operator to open the main air supply valve.

B2.4.1.2 Success Criteria

A success criterion is that the CTT remains motionless during loading of the transportation cask. Movement of the CTT during this operation could cause an impact to occur resulting in damage to the transportation cask.

B2.4.1.3 Design Requirements and Features

Requirements

There are no additional design requirements.

Features

The design feature is the locking restraint pin system that prevents power to the main air supply valve until both pins are in place and the limit switches are activated to allow power to the air supply valve.

B2.4.1.4 Fault Tree Model

The top event is “Spurious Movement of the CTT during Cask Loading in the Cask Preparation Room” (Figure B2.4-3). This can occur if the control system initiates a spurious signal and both of the pin limit switches fail, or the operator initiates a command to move the CTT and both of the pin limit switches fail. A third failure mode is the mechanical failure of the main supply valve in conjunction with a spurious signal from the control system to initiate movement or failures of the control valves or the valve to the air bags.

A conservative mission time for this operation has been set at one hour.

B2.4.1.5 Basic Event Data

Table B2.4-1 contains a list of basic events used in the fault tree (Figures B2.4-3 and B2.4-4) for “Spurious Movement of the CTT in the Cask Preparation Area during Cask Loading”.

Table B2.4-1. Basic Event Probabilities for Spurious Movement of the CTT in the Cask Preparation Area during Cask Loading

Name	Calc. Type ^a	Calc. Prob.	Fail. Prob.	Lambda	Miss. Time ^a
060--CTT--SV401--SV--FOH	3	4.870E-005	0.000E+000	4.870E-005	1.000E+000
060-CTT--CT001---CT--SPO	3	2.270E-005	0.000E+000	2.270E-005	1.000E+000
060-CTT--HC001---HC--SPO	3	5.230E-007	0.000E+000	5.230E-007	1.000E+000
060-CTT--SV301---SV--SPO	3	4.090E-007	0.000E+000	4.090E-007	1.000E+000
060-CTT--ZS301---ZS--FOD	1	2.930E-004	2.930E-004	0.000E+000	0.000E+000
060-CTT--ZS302---ZS--FOD	1	2.930E-004	2.930E-004	0.000E+000	0.000E+000
060-CTT-FWDREVM1-SV--FOH	3	4.870E-005	0.000E+000	4.870E-005	1.000E+000
060-CTT-FWDREVM2-SV--FOH	3	4.870E-005	0.000E+000	4.870E-005	1.000E+000
060-CTT-SVROTM1--SV--FOH	3	4.870E-005	0.000E+000	4.870E-005	1.000E+000
060-CTT-SVROTM2--SV--FOH	3	4.870E-005	0.000E+000	4.870E-005	1.000E+000
060-OPSPURMOV-HFI-NOD	1	1.000E-004	1.000E-004	0.000E+000	0.000E+000
060-PIN-LIMIT-ZS-CCF	1	1.380E-005	1.380E-005	0.000E+000	0.000E+000

NOTE: ^a For Calc. Type 3 with a mission time of 0, SAPHIRE performs the quantification using the system mission time.

Calc. = calculation; Fail. = failure; Miss. = mission; Prob. = probability.

Source: Original

B2.4.1.5.1 Human Failure Events

One operator error, (060-OPSPURMOV-HFI-NOD) involves initiation of spurious movement.

B2.4.1.5.2 Common-Cause Failures

One common-cause failure (CCF) was added to the tree to account for failure of both restraint pin limit switches. An alpha factor of 0.047 was used to determine the CCF value using two of two as the failure criteria (Table C3-1, CCCG = 2). The CCF is 060-PIN-LIMIT-ZS-CCF.

B2.4.1.6 Uncertainty and Cut Set Generation Results

Figure B2.4-1 contains the uncertainty results obtained from running the fault tree for “Spurious Movement of the CTT in the Cask Preparation Area during Cask Loading” using a cutoff probability of 1E-12. Figure B2.4-2 provides the cut set generation results for “Spurious Movement of the CTT in the Cask Preparation Area during Cask Loading.”



Uncertainty Results			
Name	060-3-CTT-SPURMOVE		
Random Seed	1234	Events	12
Sample Size	10000	Cut Sets	11
Point estimate	1.811E-009		
Mean Value	1.800E-009		
5th Percentile Value	6.667E-011		
Median Value	5.789E-010		
95th Percentile Value	6.435E-009		
Minimum Sample Value	5.410E-012		
Maximum Sample Value	2.452E-007		
Standard Deviation	5.645E-009		
Skewness	1.669E+001		
Kurtosis	4.866E+002		
Elapsed Time	00:00:00.870		
<input type="button" value="OK"/>			

Source: Original

Figure B2.4-1. Uncertainty Results of for “Spurious Movement of the CTT in the Cask Preparation Area during Cask Loading”

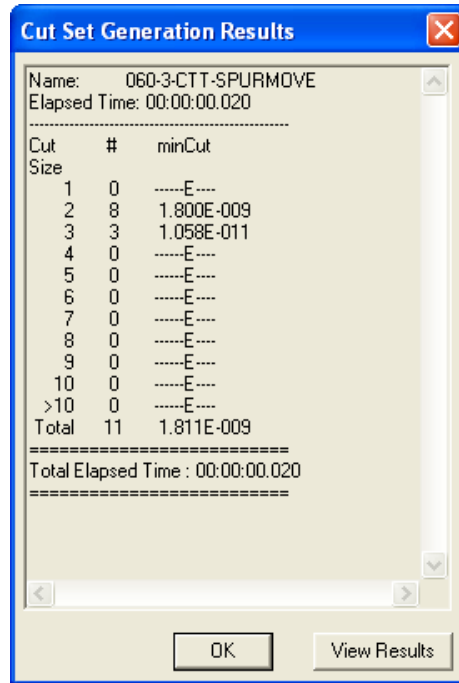

Source: Original

Figure B2.4-2. Cut Set Generation Results for “Spurious Movement of the CTT in the Cask Preparation Area during Cask Loading”

B2.4.1.7 Cut Sets

Table B2.4-2 contains the cut sets for “Spurious Movement of the CTT in the Cask Preparation Area during Cask Loading”. The total probability per cask loading is 1.81E-9.

Table B2.4-2. Cut Sets for Spurious Movement of the CTT in the Cask Preparation Room during Cask Loading

Fault Tree	Cut Set %	Prob./Freq.	Basic Event	Description	Probability
060-3-CTT-SPURMOVE	76.22	1.380E-009	060-OPSPURMOVE01-HFI-NOD	Operator Initiates Spurious Movement of Conveyance	1.0E-004
			060-PIN-LIMIT-ZS-CCF	Common Cause Failure of Limit Switches	1.4E-005
	17.30	3.133E-010	060-CTT--CT001---CT--SPO	On-Board Controller Initiates Spurious Signal	2.3E-005
			060-PIN-LIMIT-ZS-CCF	Common Cause Failure of Limit Switches	1.4E-005
	1.10	1.992E-011	060--CTT--SV401--SV--FOH	Failure of Air Supply Solenoid Valve for Air Bags	4.9E-005
			060-CTT--SV301---SV--SPO	Air Supply Solenoid Valve Spurious Operation	4.1E-007
	1.10	1.992E-011	060-CTT--SV301---SV--SPO	Air Supply Solenoid Valve Spurious Operation	4.1E-007

Table B2.4-2. Cut Sets for Spurious Movement of the CTT in the Cask Preparation Room during Cask Loading (Continued)

Fault Tree	Cut Set %	Prob./Freq.	Basic Event	Description	Probability
			060-CTT-FWDREVM1-SV--FOH	Failure of SV Providing Fwd/Rev to Motor 1	4.9E-005
	1.10	1.992E-011	060-CTT--SV301---SV--SPO	Air Supply Solenoid Valve Spurious Operation	4.1E-007
			060-CTT-FWDREVM2-SV--FOH	Failure of SV Providing Fwd/Rev to Motor 2	4.9E-005
	1.10	1.992E-011	060-CTT--SV301---SV--SPO	Air Supply Solenoid Valve Spurious Operation	4.1E-007
			060-CTT-SVROTM1--SV--FOH	Failure of SV Providing Rotation to Motor 1	4.9E-005
	1.10	1.992E-011	060-CTT--SV301---SV--SPO	Air Supply Solenoid Valve Spurious Operation	4.1E-007
			060-CTT-SVROTM2--SV--FOH	Failure of SV Providing Rotation to Motor 2	4.9E-005
	0.47	8.585E-012	060-CTT--ZS301---ZS--FOD	Pin Limit Switch #1 Fails	2.9E-004
			060-CTT--ZS302---ZS--FOD	Restraint Locking Pin Limit Switch #2 Fails	2.9E-004
			060-OPSPURMOVE01-HFI-NOD	Operator Initiates Spurious Movement of Conveyance	1.0E-004
	0.40	7.217E-012	060-CTT--HC001---HC--SPO	Hand Held Controller Initiates Spurious Signal	5.2E-007
			060-PIN-LIMIT-ZS-CCF	Common Cause Failure of Limit Switches	1.4E-005
	0.11	1.949E-012	060-CTT--CT001---CT--SPO	On-Board Controller Initiates Spurious Signal	2.3E-005
			060-CTT--ZS301---ZS--FOD	Pin Limit Switch #1 Fails	2.9E-004
			060-CTT--ZS302---ZS--FOD	Restraint Locking Pin Limit Switch #2 Fails	2.9E-004
	0.00	4.490E-014	060-CTT--HC001---HC--SPO	Hand Held Controller Initiates Spurious Signal	5.2E-007
			060-CTT--ZS301---ZS--FOD	Pin Limit Switch #1 Fails	2.9E-004
			060-CTT--ZS302---ZS--FOD	Restraint Locking Pin Limit Switch #2 Fails	2.9E-004
		1.811E-009	= Total		

NOTE: Freq. = frequency; Fwd = forward; Prob. Probability; Rev = reverse; SV = solenoid valve

Source: Original

B2.4.1.8 Fault Trees

The fault trees for “Spurious Movement of the CTT in the Cask Preparation Area during Cask Loading” are shown in Figures B2.4-3 and B2.4-4.

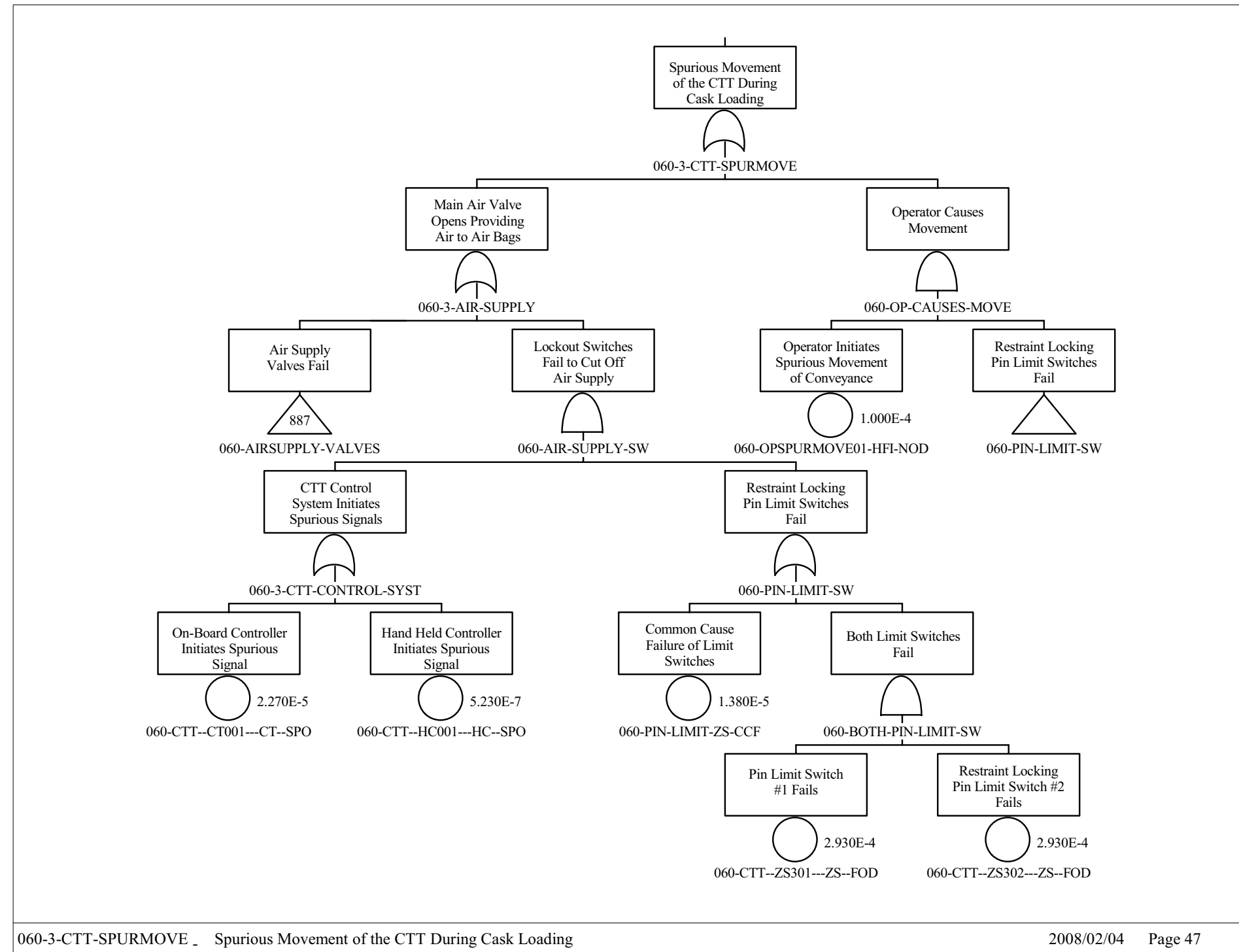

Source: Original

Figure B2.4-3. Fault Tree for Spurious Movement of the CTT in the Preparation Area during Cask Loading

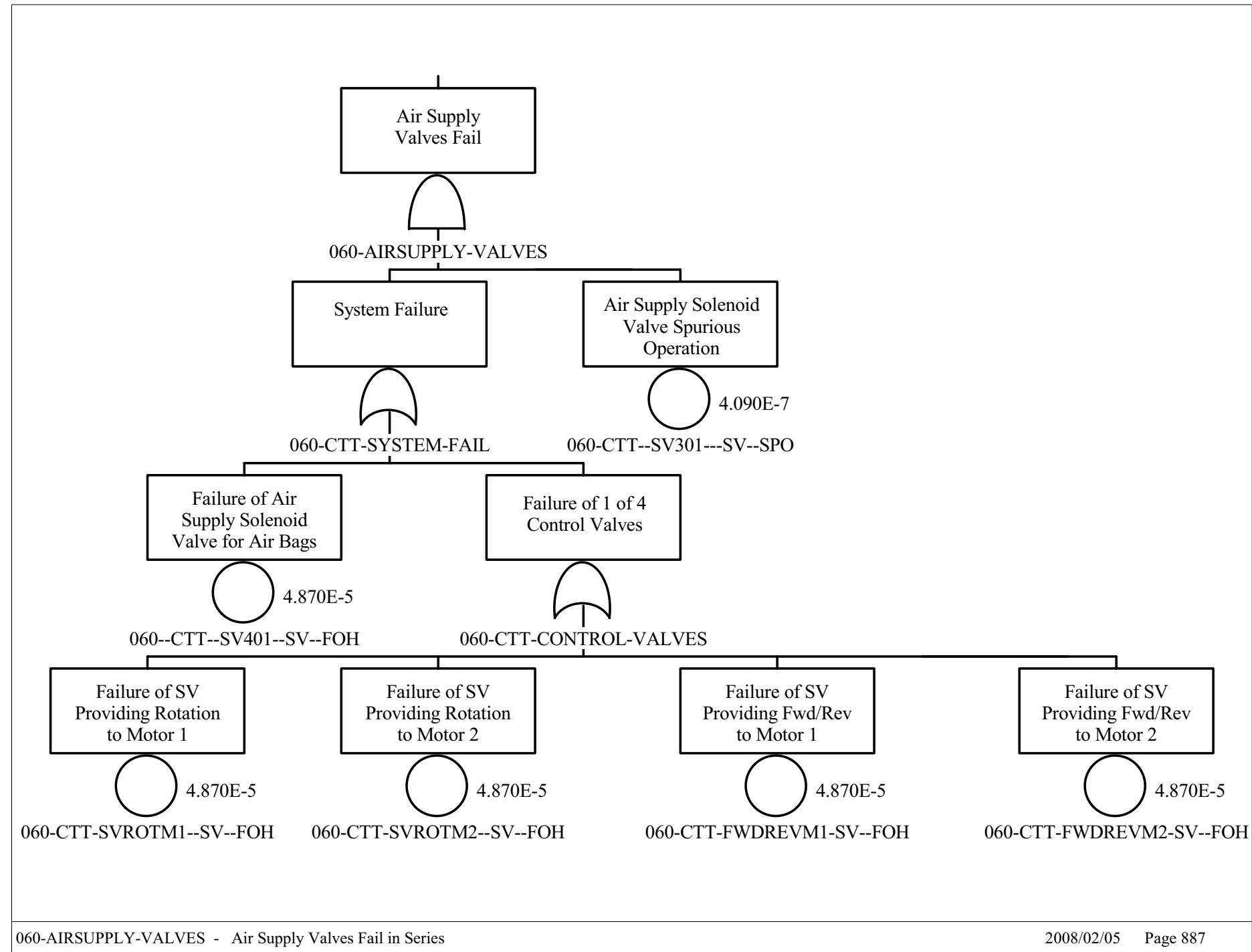

Source: Original

Figure B2.4-4. Fault Tree for CTT Air Supply Valve Failure

B2.4.2 Spurious Movement of the CTT in the Preparation Area During Cask Preparation

B2.4.2.1 Description

This fault tree describes spurious movement of the CTT during cask preparation to satisfy ESD-4, pivotal event “Impact into DPC Cask.” The top event is “Spurious Movement of the CTT in the Preparation Area during Cask Prep” which is defined as unplanned movement of the CTT while the cask is being prepared for movement to the transfer area by unbolting the lid and installing the lid adapter. This fault tree is shown in Figure B2.4-7.

During this operation, the locking pins have been installed and the limit switches are closed. Spurious movement can be caused by multiple equipment failures, or by operator error. For equipment failures to cause spurious movement, the main air supply valve must open to supply air to the air bags to levitate the CTT. This can occur through failure of the main air supply valve couples with spurious commands from the control system or failure of the control valves. Alternatively, the operator can initiate spurious movement since at this stage of the operation there are no preventive interlocks.

B2.4.2.2 Success Criteria

The success criterion is that the CTT remain motionless during cask preparation. Movement of the CTT during this operation could cause an impact to occur resulting in damage to the transportation cask.

B2.4.2.3 Design Requirements and Features

There are no design features or requirements for this operation.

B2.4.2.4 Fault Tree Model

The top event in this fault tree is “Spurious Movement of the CTT in the Cask Preparation Area during Cask Preparation” (Figure B2.4-7). This can occur through spurious signals from the control system, spurious operation of the main air supply valve, failure of the control valves, or operator error initiating CTT movement.

B2.4.2.5 Basic Event Data

Table B2.4-3 contains a list of basic events used in the fault tree (Figure B2.4-7) for “Spurious Movement of the CTT in the Cask Preparation Area during Cask Preparation.”

Table B2.4-3. Basic Event Probabilities for Spurious Movement of the CTT in the Cask Preparation Area During Cask Preparation

Name	Calc. Type ^a	Calc. Prob.	Fail. Prob.	Lambda	Miss. Time ^a
060-CTT--CT001---CT--SPO	3	2.270E-005	0.000E+000	2.270E-005	1.000E+000
060-CTT--HC001---HC--SPO	3	5.230E-007	0.000E+000	5.230E-007	1.000E+000
060-OPSPURMOVE01-HFI-NOD	1	1.000E-004	1.000E-004	0.000E+000	0.000E+000
060--CTT--SV401--SV--FOH	3	4.870E-005	0.000E+000	4.870E-005	1.000E+000
060-CTT--SV301---SV--SPO	3	4.090E-007	0.000E+000	4.090E-007	1.000E+000
060-CTT-FWDREVM1-SV--FOH	3	4.870E-005	0.000E+000	4.870E-005	1.000E+000
060-CTT-FWDREVM2-SV--FOH	3	4.870E-005	0.000E+000	4.870E-005	1.000E+000
060-CTT-SVROTM1--SV--FOH	3	4.870E-005	0.000E+000	4.870E-005	1.000E+000
060-CTT-SVROTM2--SV--FOH	3	4.870E-005	0.000E+000	4.870E-005	1.000E+000

NOTE: ^a For Calc. Type 3 with a mission time of 0, SAPHIRE performs the quantification using the system mission time.

Calc. = calculation; Fail. = failure; Miss. = mission; Prob. = probability.

Source: Original

B2.4.2.5.1 Human Failure Events

One operator error (060-OPSPURMOVE01-HFI-NOD) involves initiation of spurious movement.

B2.4.2.5.2 Common-Cause Failures

There is no CCF associated with this fault tree.

B2.4.2.6 Uncertainty and Cut Set Generation Results

Figure B2.4-5 contains the uncertainty results obtained from running the fault tree for spurious movement of the CTT in the preparation area during cask preparation. Figure B2.4-6 provides the cut set generation results for spurious movement of the CTT in the Cask Preparation Room during cask preparation.

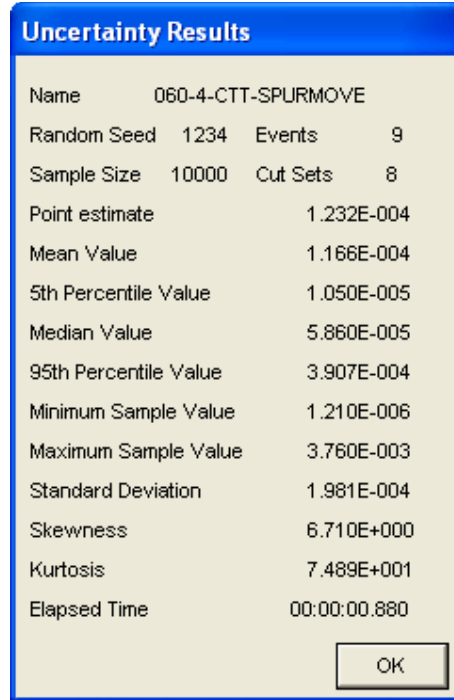

Source: Original

Figure B2.4-5. Uncertainty Results for the “Spurious Movement of the CTT in the Cask Preparation Area During Cask Preparation” Fault Tree

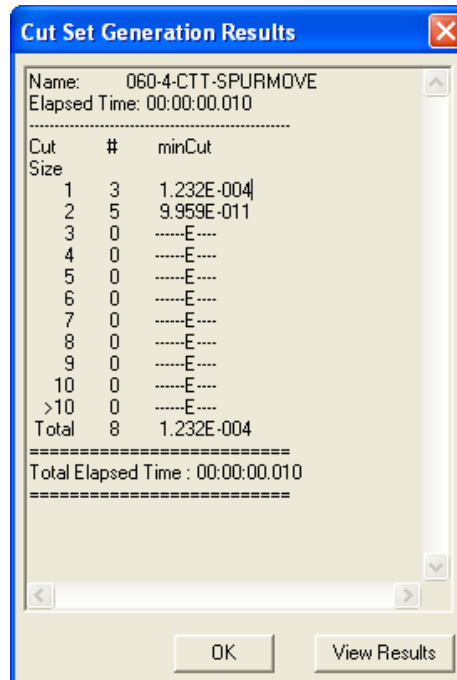

Source: Original

Figure B2.4-6. Cut Set Generation Results for the “Spurious Movement of the CTT in the Cask Preparation Area During Cask Preparation” Fault Tree

B2.4.2.7 Cut Sets

Table B2.4-4 contains the cut sets for spurious movement of the CTT in the Cask Preparation Room during cask preparation. The total probability per cask is 1.23E-4 with the operator initiation of a spurious movement the dominant cause of movement during cask preparation.

Table B2.4-4. Cut Sets for Spurious Movement of the CTT in the Cask Preparation Area during Cask Preparation

Fault Tree	Cut Set %	Prob./Freq.	Basic Event	Description	Probability
060-4-CTT-SPURMOVE	81.16	1.000E-004	060-OPSPURMOVE01-HFI-NOD	Operator Initiates Spurious Movement of Conveyance	1.0E-004
	18.42	2.270E-005	060-CTT--CT001---CT--SPO	On-Board Controller Initiates Spurious Signal	2.3E-005
	0.42	5.230E-007	060-CTT--HC001---HC--SPO	Hand Held Controller Initiates Spurious Signal	5.2E-007
	0.00	1.992E-011	060--CTT--SV401--SV--FOH	Failure of Air Supply Solenoid Valve for Air Bags	4.9E-005
			060-CTT--SV301---SV--SPO	Air Supply Solenoid Valve Spurious Operation	4.1E-007
	0.00	1.992E-011	060-CTT--SV301---SV--SPO	Air Supply Solenoid Valve Spurious Operation	4.1E-007
			060-CTT-FWDREVM1-SV--FOH	Failure of SV Providing Fwd/Rev to Motor 1	4.9E-005
	0.00	1.992E-011	060-CTT--SV301---SV--SPO	Air Supply Solenoid Valve Spurious Operation	4.1E-007
			060-CTT-FWDREVM2-SV--FOH	Failure of SV Providing Fwd/Rev to Motor 2	4.9E-005
	0.00	1.992E-011	060-CTT--SV301---SV--SPO	Air Supply Solenoid Valve Spurious Operation	4.1E-007
			060-CTT-SVROTM1--SV--FOH	Failure of SV Providing Rotation to Motor 1	4.9E-005
	0.00	1.992E-011	060-CTT--SV301---SV--SPO	Air Supply Solenoid Valve Spurious Operation	4.1E-007
			060-CTT-SVROTM2--SV--FOH	Failure of SV Providing Rotation to Motor 2	4.9E-005
		1.232E-004	= Total		

NOTE: Freq. = frequency; Prob. = probability.

Source: Original

B2.4.2.8 Fault Trees

The fault tree for “Spurious Movement of the CTT in the Cask Preparation Area During Cask Preparation” is shown in Figure B2.4-7. Note that the transfer gate 887 in Figure B2.4-7 refers to the fault tree in Figure B2.4-4.

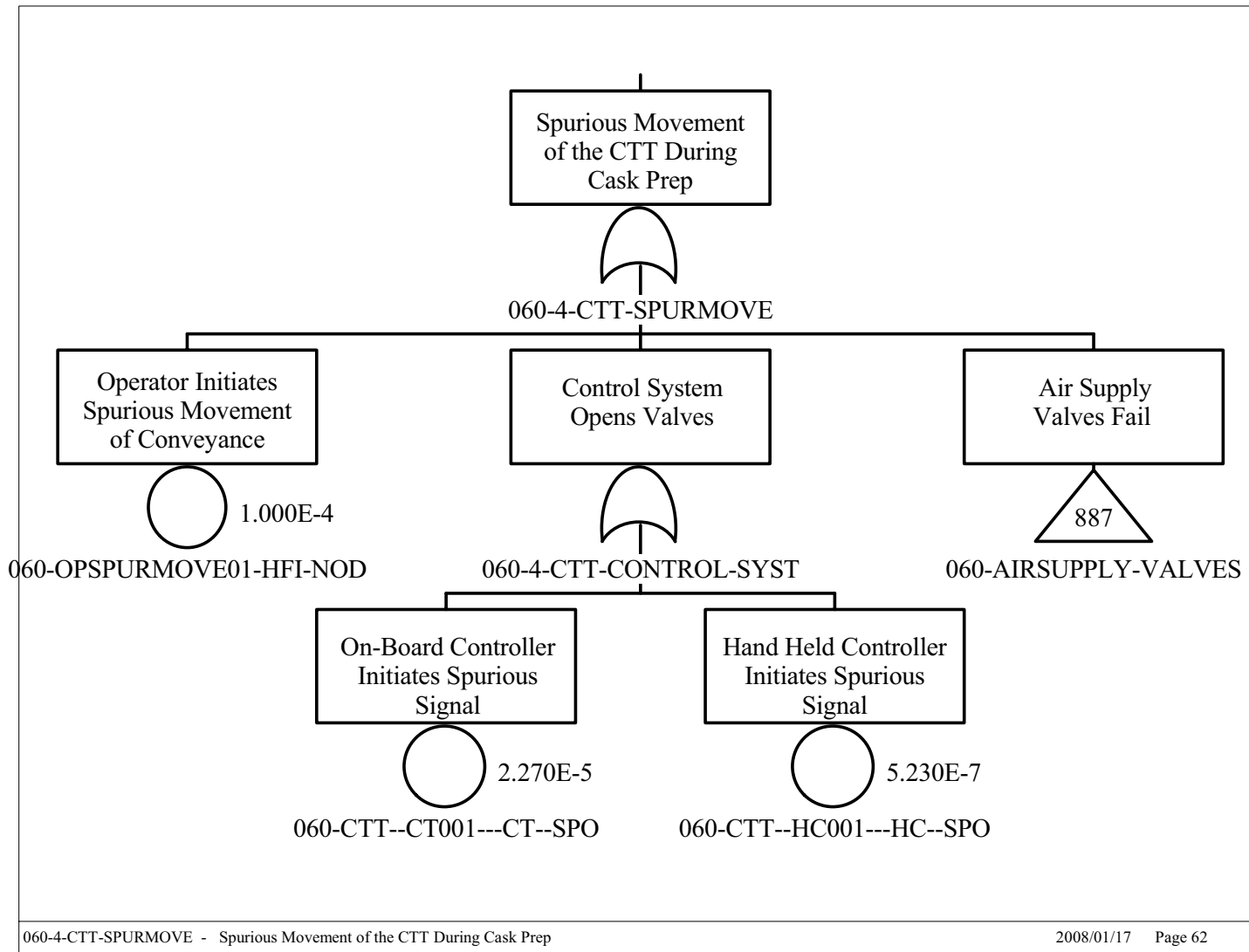

B2-20

March 2008

Source: Original

Figure B2.4-7. Fault Tree for Spurious Movement of the CTT in the during Cask Preparation

B2.4.3 Collision of CTT During Cask Transfer

B2.4.3.1 Description

This fault tree considers the potential for the CTT to collide with a structure or object while moving a cask from the Cask Preparation Room to the Cask Unloading Room. This satisfies ESD-6, pivotal event “Site Transporter or CTT Impact Collision with Another Vehicle, Facility, Structure, or Equipment.” The top event is “CTT Collision into Structure.” This fault tree is shown in Figure B2.4-10 and Figure B2.4-11.

Two primary causes of a collision are operator initiated (possibly through inattention) or failure of the CTT to stop. Movement in the wrong direction as a contributing factor is negated by the use of guide rails forcing the CTT to only move forward and backwards. A runaway condition is prevented by the control system, designed to give a proportional signal to the air valve that produces a speed range of only 0-10 fpm, and an in-line factory set mechanical throttle valve that limits the speed to 10 fpm in the event the control system fails. In the event both of these devices fail, the stop functions must also fail. Since all three functions must fail for a runaway condition, the primary events leading to a collision are operator error or failure to stop.

Failure to stop the CTT requires that failure of the normal stop function, deadman switches, and the air supply valve to all fail to close on demand. The emergency stop buttons, one on the pendant and one on the CTT, must also fail; however, because these are recovery actions to be taken by the operator, the emergency stop functions are not credited in the fault tree.

B2.4.3.2 Success Criteria

The success criterion for this event is that the CTT does not experience a collision with any object, including the shield door, during transfer of a cask from the Cask Preparation Room to the Cask Unloading Room. A collision of the CTT could cause damage to the transportation cask.

B2.4.3.3 Design Requirements and Features

The design feature is the deadman switches on the pendant control that must be pressed for air to be supplied to the CTT to provide motive power. There are no requirements for this operation.

B2.4.3.4 Fault Tree Model

The top event of the fault tree is for a collision of the CTT into an object or structure during transfer of a cask from the Cask Preparation Room to the Cask Unloading Room (Figures B2.4-10 and B2.4-11). This may occur through operator error or equipment failure of the normal or emergency stop functions. A conservative mission time for this operation has been set at one hour.

B2.4.3.5 Basic Event Data

Table B2.4-5 contains a list of basic events used in the CTT collision fault tree (Figures B2.4-10 and B2.4-11) for “Collision of the CTT during Cask Transfer”.

Table B2.4-5. Basic Event Probability for Collision of CTT during Cask Transfer

Name	Calc. Type ^a	Calc. Prob.	Fail. Prob.	Lambda	Miss. Time ^a
060-CTT--DSW000--ESC-CCF	1	1.180E-005	1.180E-005	0.000E+000	0.000E+000
060-CTT--DSW001--ESC-FOD	1	2.500E-004	2.500E-004	0.000E+000	0.000E+000
060-CTT--DSW002--ESC-FOD	1	2.500E-004	2.500E-004	0.000E+000	0.000E+000
060-CTT--HC021---HC--FOD	1	1.740E-003	1.740E-003	0.000E+000	0.000E+000
060-CTT--SV601---SV--FOD	1	6.280E-004	6.280E-004	0.000E+000	0.000E+000
060-CTT--SV602---SV--FOD	1	6.280E-004	6.280E-004	0.000E+000	0.000E+000
060-OPCTTCOLLID2-HFI-NOD	1	1.000E-003	1.000E-003	0.000E+000	0.000E+000

NOTE: ^a For Calc. Type 3 with a mission time of 0, SAPHIRE performs the quantification using the system mission time.

Calc. = calculation; Fail. = failure; Miss. = mission; Prob. = probability.

Source: Original

B2.4.3.5.1 Human Failure Events

A collision may be caused by an operator error (060-OPCTTCOLLID2-HFI-NOD) failing to stop the CTT.

B2.4.3.5.2 Common-Cause Failures

One CCF (060-CTT--DSW000--ESC-CCF) involves failure of both deadman switches, both of which must be pressed for the main air supply valve to open. An alpha factor of 0.047 was used to determine the CCF value using two of two as the failure criteria (Table C3-1, CCCG = 2).

B2.4.3.6 Uncertainty and Cut Set Generation Results

Figure B2.4-8 contains the uncertainty results obtaining from running the fault trees for “Collision of CTT during Cask Transfer” using a cutoff probability of 1E-12. Figure B2.4-9 provides the cut set generation results for the “Collision of CTT during Cask Transfer” fault trees.

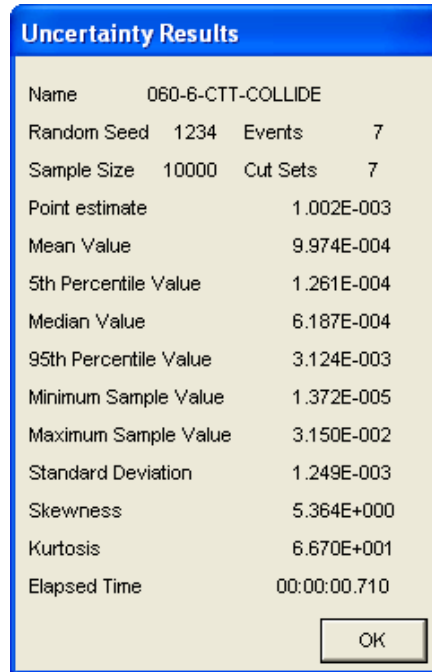

Source: Original

Figure B2.4-8. Uncertainty Results for the Collision of CTT during Cask Transfer Fault Tree

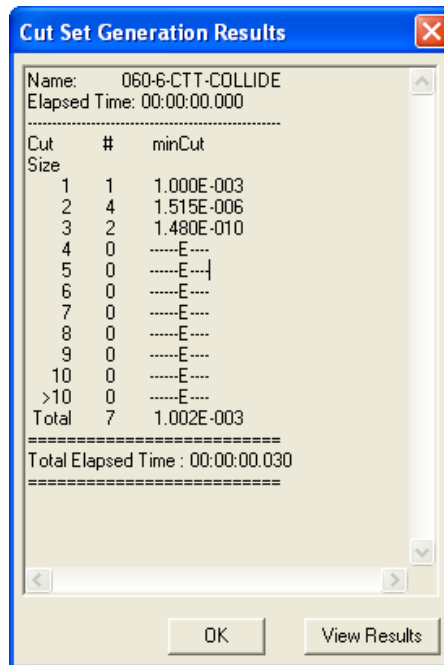

Source: Original

Figure B2.4-9. Cut Set Generation Results for the Collision of CTT during Cask Transfer Fault Tree

B2.4.3.7 Cut Sets

Table B2.4-6 contains the cut sets for the collision of the CTT during cask movement from the Cask Preparation Room to the Canister Transfer Room. The total frequency per cask is 1.002E-003 with operator error the dominant cause of collision.

Table B2.4-6. Cut Sets for 060-6-CTT-COLLIDE, Collision of the CTT During Cask Transfer

Cut No.	% Total	% Cut Set	Prob./ Frequency	Basic Event	Description	Event Prob.
1	99.85	99.85	1.000E-003	060-OPCTCOLLIDE2-HFI-NOD	Operator Causes CTT Collision	1.000E-003
2	99.96	0.11	1.093E-006	060-CTT--HC021---HC--FOD	Remote Stop Control Transmits Wrong Instruction	1.740E-003
				060-CTT--SV601---SV--FOD	Main Air Supply Valve on CTT Fails to Close	6.280E-004
3	100.00	0.04	3.944E-007	060-CTT--SV601---SV--FOD	Main Air Supply Valve on CTT Fails to Close	6.280E-004
				060-CTT--SV602---SV--FOD	Solenoid Valve Fails to Close	6.280E-004
4	100.00	0.00	2.053E-008	060-CTT--DSW000--ESC-CCF	Common Cause Failure of Deadman Switches	1.180E-005
				060-CTT--HC021---HC--FOD	Remote Stop Control Transmits Wrong Instruction	1.740E-003
5	100.00	0.00	7.410E-009	060-CTT--DSW000--ESC-CCF	Common Cause Failure of Deadman Switches	1.180E-005
				060-CTT--SV602---SV--FOD	Solenoid Valve Fails to Close	6.280E-004
6	100.00	0.00	1.088E-010	060-CTT--DSW001--ESC-FOD	Deadman Switch #1 Fails Closed	2.500E-004
				060-CTT--DSW002--ESC-FOD	Deadman Switch #2 Fails Closed	2.500E-004
				060-CTT--HC021---HC--FOD	Remote Stop Control Transmits Wrong Instruction	1.740E-003
7	100.00	0.00	3.925E-011	060-CTT--DSW001--ESC-FOD	Deadman Switch #1 Fails Closed	2.500E-004
				060-CTT--DSW002--ESC-FOD	Deadman Switch #2 Fails Closed	2.500E-004
				060-CTT--SV602---SV--FOD	Solenoid Valve Fails to Close	6.280E-004
1.002E-3 = Total						

NOTE: No. = number; Prob. = probability

Source: Original

B2.4.3.8 Fault Trees

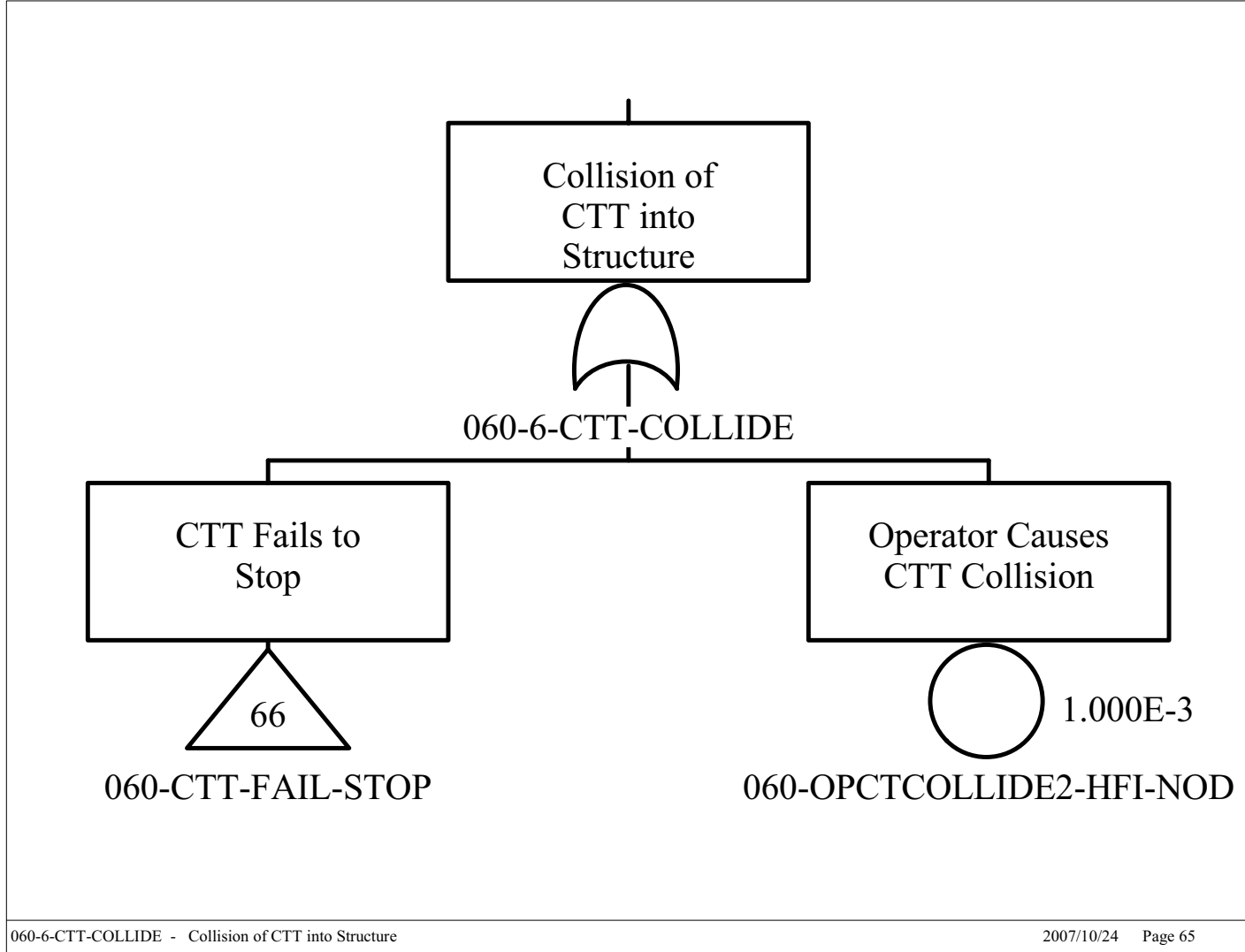

B2-25

March 2008

Source: Original

Figure B2.4-10. Fault Tree for Collision of the CTT during Cask Transfer (Page 1)

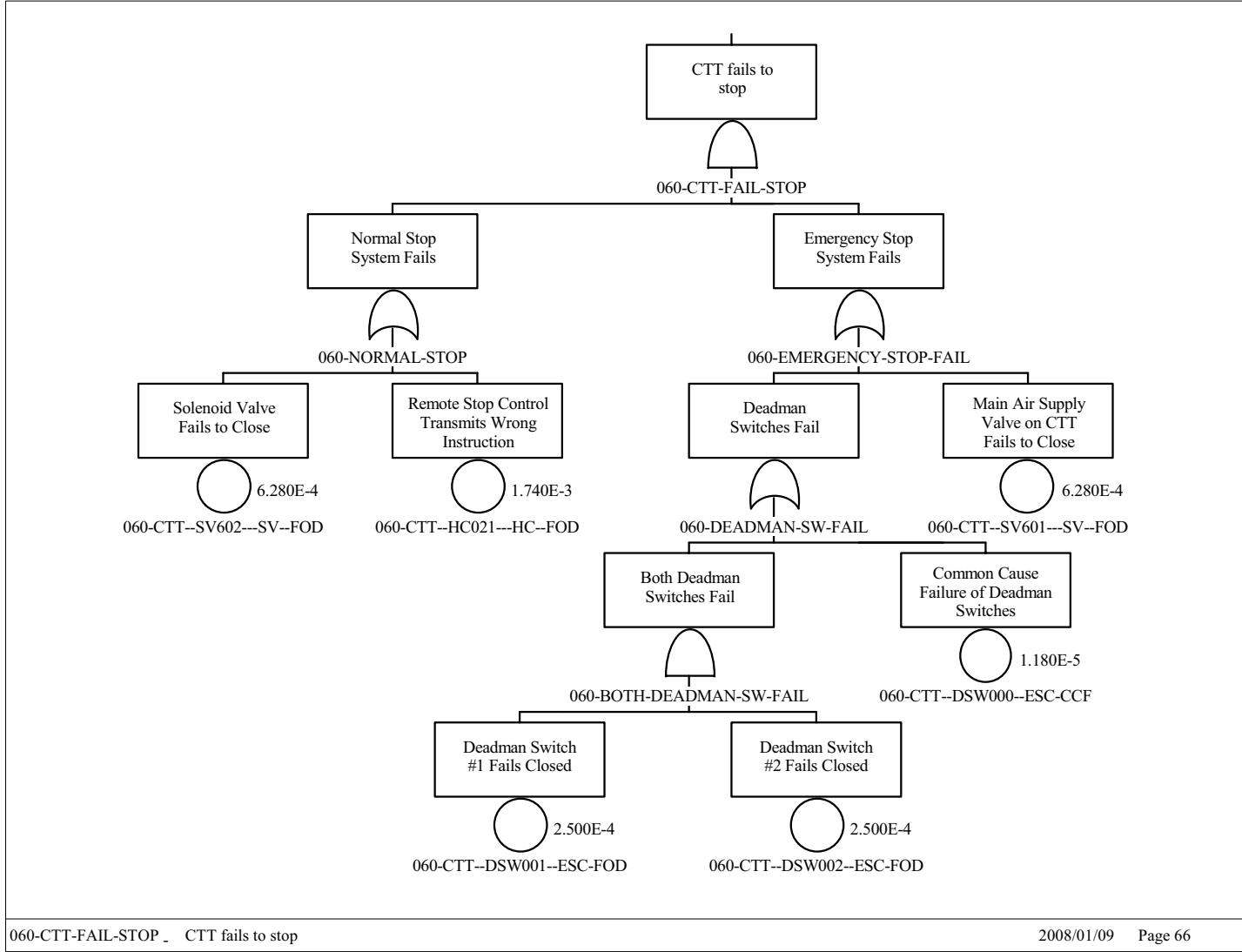

B2-26

March 2008

Source: Original

Figure B2.4-11. Fault Tree for Collision of the CTT during Cask Transfer (Page 2)

B2.4.4 Spurious Movement of the CTT in the Canister Transfer Room

B2.4.4.1 Description

This fault tree describes spurious movement of the CTT during extraction, or unloading, of the canister from the transportation cask on the CTT to satisfy ESD-9, the initiating event “Canister Impact due to Movement of CTT during Lift.” The top event is “Spurious Movement during Canister Transfer” which is defined as unplanned movement of the CTT while the canister is extracted from the transportation cask. This fault tree is shown in Figure B2.4-14.

Spurious movement is prevented in the Canister Transfer Room by disconnecting the air supply hose from the CTT. The shield door interlock (external to the CTT) must be closed to allow the port slide gate to open and canister extraction to begin. Thus, if the shield door is not closed the slide gate cannot open and extraction of the canister cannot begin. With the air supply located outside the Canister Transfer Room, the operator must disconnect the air supply hose to the CTT for the shield door to be closed, or the shield door cuts through the hose upon closing. If the operator fails to disconnect the hose, movement may be initiated by failure of the door interlocks and the control system causing the main air supply valve to open, or the main air supply valve to “fail open” in conjunction with failure of the controls or the control valves. During this transfer process the operator is not in the Canister Transfer Room and cannot access the controls to initiate spurious movement.

B2.4.4.2 Success Criteria

Success criterion is that the CTT remain motionless during canister extraction from the transportation cask. Movement of the CTT during this operation could cause an impact and/or shear resulting in damage to the canister.

B2.4.4.3 Design Features and Requirements

The design feature is the shield door interlocks that prevent the extraction operation until the shield door is closed. Requirements include, locating the air supply outside the Canister Transfer Room, and for the operator to disconnect the air supply to the CTT prior to unloading.

B2.4.4.4 Fault Tree Model

The top event is for the spurious movement of the CTT during extraction of the canister from the transportation cask on the CTT (Figure B2.4-14). This may occur through failure to disconnect the air supply resulting in operation of the main air supply valve. The air supply valve may fail through spurious operation of the valve or spurious signals generated by the control system. Compressed air may be available to the CTT through failure of the operator to disconnect the air hose, or failure of the shield door interlocks. A conservative mission time for this operation has been set at one hour.

B2.4.4.5 Basic Event Data

Table B2.4-7 contains a list of basic events used in the fault tree for “Spurious Movement of the CTT in the Canister Transfer Room”.

Table B2.4-7. Basic Event Probability for Spurious Movement of the CTT in the Canister Transfer Room

Name	Calc. Type ^a	Calc. Prob.	Fail. Prob.	Lambda	Miss. Time ^a
060-CR---IEL00A--IEL-FOD	1	2.750E-005	2.750E-005	0.000E+000	0.000E+000
060-CR---IEL00B--IEL-FOD	1	2.750E-005	2.750E-005	0.000E+000	0.000E+000
060-CR---IELCCF--IEL-FOD	1	1.290E-006	1.290E-006	0.000E+000	0.000E+000
060-CTT--CT001---CT--SPO	3	2.270E-005	0.000E+000	2.270E-005	1.000E+000
060-CTT--HC001---HC--SPO	3	5.230E-007	0.000E+000	5.230E-007	1.000E+000
060-OPNODISCOAIR-HFI-NOD	1	1.000E-003	1.000E-003	0.000E+000	0.000E+000
060-CTT--SV301---SV--SPO	3	4.090E-007	0.000E+000	4.090E-007	1.000E+000
060--CTT--SV401--SV--FOH	3	4.870E-005	0.000E+000	4.870E-005	1.000E+000
060-CTT-FWDREVM1-SV--FOH	3	4.870E-005	0.000E+000	4.870E-005	1.000E+000
060-CTT-FWDREVM2-SV--FOH	3	4.870E-005	0.000E+000	4.870E-005	1.000E+000
060-CTT-SVROTM1--SV--FOH	3	4.870E-005	0.000E+000	4.870E-005	1.000E+000
060-CTT-SVROTM2--SV--FOH	3	4.870E-005	0.000E+000	4.870E-005	1.000E+000

NOTE: ^a For Calc. Type 3 with a mission time of 0, SAPHIRE performs the quantification using the system mission time.

Calc. = calculation; Fail. = failure; Miss. = mission; Prob. = probability.

Source: Original

B2.4.4.5.1 Human Failure Events

One operator error (060-OPNODISCOAIR-HFI-NOD) involves failure to disconnect the air supply.

B2.4.4.5.2 Common-Cause Failures

One CCF involves failure of both shield door interlocks allowing the shield door to close and the slide port gate to open. An alpha factor of 0.047 was used to determine the CCF value using two of two as the failure criteria (Table C3-1, CCCG = 2).

B2.4.4.6 Uncertainty and Cut Set Generation Results

Figure B2.4-12 contains the uncertainty results obtained from running the fault trees for “Spurious Movement of the CTT in the Canister Transfer Room” while extracting the canister from the transportation cask in the Cask Unloading Room. Figure B2.4-13 provides the cut set generation results for “Spurious Movement of the CTT in the Canister Transfer Room”.

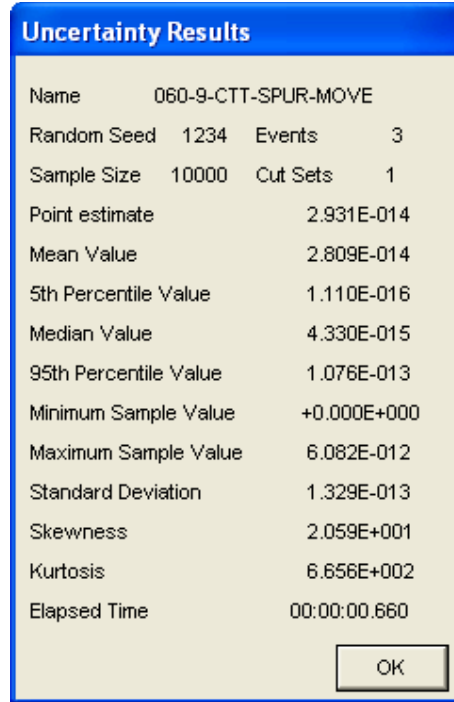

Source: Original

Figure B2.4-12. Uncertainty Results for the Spurious Movement of the CTT in the Canister Transfer Room Fault Tree

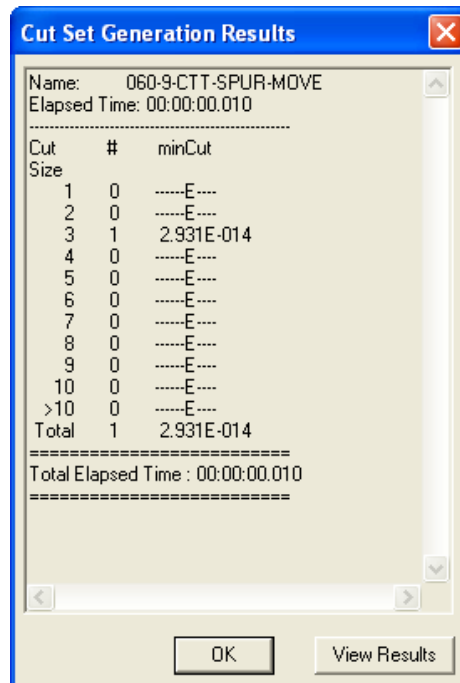

Source: Original

Figure B2.4-13. Cut Set Generation Results for the Spurious Movement of the CTT in the Canister Transfer Room Fault Tree

B2.4.4.7 Cut Sets

Table B2.4-8 contains the cut sets for spurious movement of the CTT in the Cask Unloading Room. The total frequency per cask is 2.93E-14.

Table B2.4-8. Cut Sets for CTT Spurious Movement During Cask Unloading

Fault Tree	Cut Set %	Prob./Freq.	Basic Event	Description	Probability
060-9-CTT-SPUR-MOVE	99.91	2.928E-014	060-CR---IELCCF--IEL-CCF	Common Cause Failure of Interlocks From Slide Gate	1.3E-006
			060-CTT--CT001---CT--SPO	On-Board Controller Initiates Spurious Signal	2.3E-005
			060-OPNODISCOAIR-HFI-NOD	Operator Fails to Disconnect Air Supply to CTT	1.0E-003
		2.931E-014	= Total		

NOTE: CTT = cask transfer trolley; Prob. = probability; Freq. = frequency

Source: Original

B2.4.4.8 Fault Trees

The fault tree for “Spurious Movement of the CTT in the Canister Transfer Room” is shown in Figure B2.4-14. Note that the transfer gate 887 in Figure B2.4-14 refers to the fault tree in Figure B2.4-4.

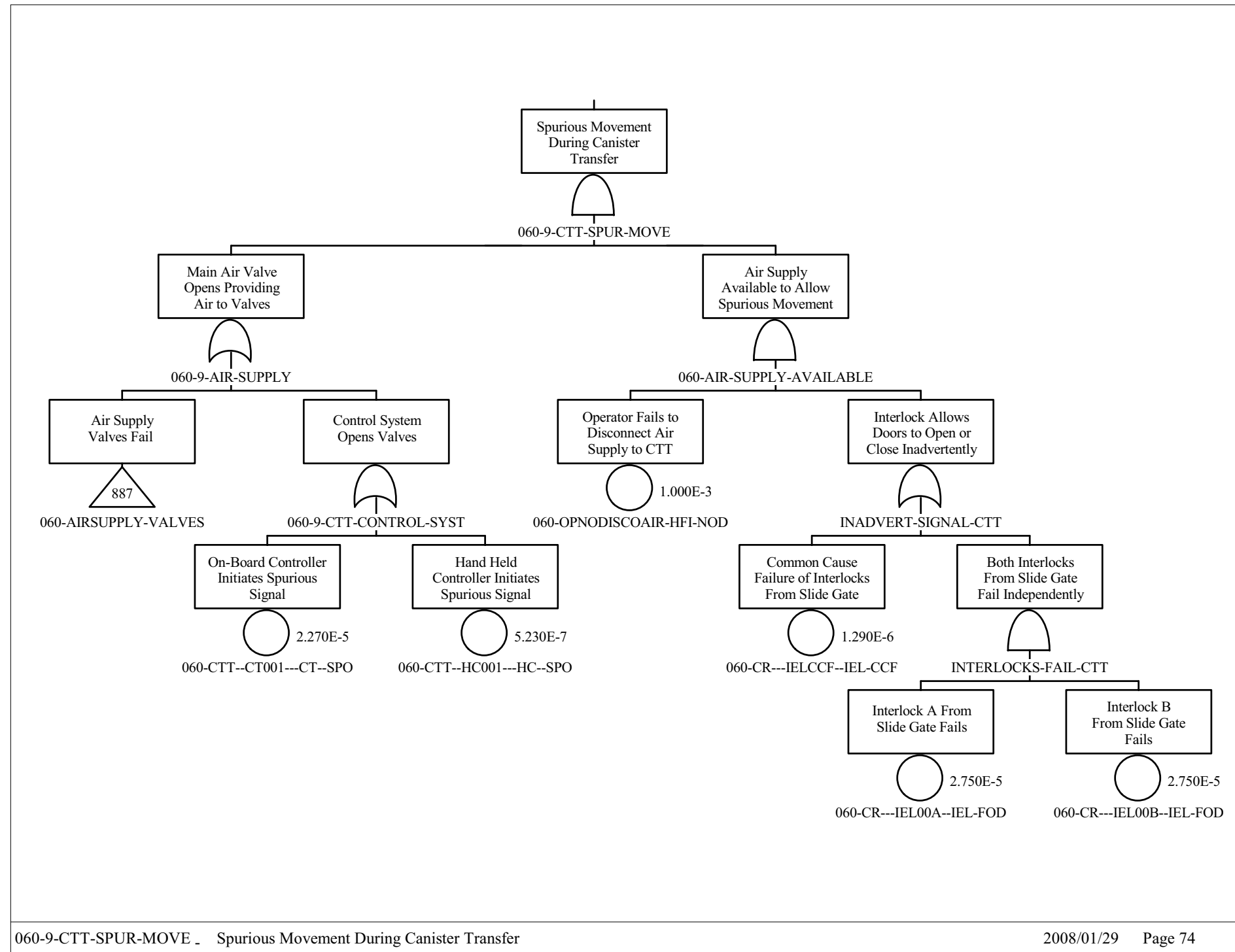

Source: Original

Figure B2.4-14. Fault Tree for CTT Spurious Movement during Canister Transfer

B3 LOADING/UNLOADING ROOM SHIELD DOOR AND SLIDE GATE FAULT TREE ANALYSIS

B3.1 REFERENCES

Design Inputs

The PCSA is based on a snapshot of the design. The reference design documents are appropriately documented as design inputs in this section. Since the safety analysis is based on a snapshot of the design, referencing subsequent revisions to the design documents (as described in EG-PRO-3DP-G04B-00037, *Calculations and Analyses* (Ref. 2.1.1, Section 3.2.2.F)) that implement PCSA requirements flowing from the safety analysis would not be appropriate for the purpose of the PCSA.

The inputs in this section noted with an asterisk (*), if any, fall into one of the designated categories described in Section 4.1, relative to suitability for intended use.

- B3.1.1 BSC (Bechtel SAIC Company) 2008. *Nuclear Facilities Slide Gate Process and Instrumentation Diagram*. 000-M60-H000-00201-000 REV 00E. Las Vegas, Nevada: Bechtel SAIC Company. ACC: ENG.20080123.0025.
- B3.1.2 BSC 2007. *Nuclear Facilities Equipment Shield Door Process and Instrumentation Diagram*. 000-M60-H000-00101-000 REV 00D. Las Vegas, Nevada: Bechtel SAIC Company. ACC: ENG.20071220.0024.
- B3.1.3 BSC 2008. *Canister Receipt and Closure Facility 1 General Arrangement Ground Floor Plan*. 060-P10-CR00-00102-000 REV 00C. Las Vegas, Nevada: Bechtel SAIC Company. ACC: ENG.20080122.0013.
- B3.1.4 BSC 2007. *Canister Receipt and Closure Facility 1 General Arrangement Second Floor Plan*. 060-P10-CR00-00103-000 REV 00C. Las Vegas, Nevada: Bechtel SAIC Company. ACC: ENG.20080122.0014.

B3.2 SLIDE GATE AND SHIELD DOOR SYSTEM DESCRIPTION

B3.2.1 Overview

Each of the CRCF Cask Unloading Rooms (room numbers 1023, 1024) and Waste Package Positioning Rooms (room numbers 1018, 1019) have a slide gate providing access to the Canister Transfer Room (room number 2004) (Ref. B3.1.4) and a shield door providing access to either the Cask Preparation Room (room number 1026) or the Waste Package Loadout Room (room number 1015) (Ref. B3.1.3). The shield doors and slide gates provide shielding during canister unloading and loading. The slide gates and shield doors are ITS, protecting workers from the hazardous operations that go on inside the Waste Package Loadout Room and Cask Unloading Rooms.

B3.2.2 Operations Description

The Cask Unloading Room shield doors are opened to allow cask-carrying equipment, such as the site transporter, to enter the room. Once equipment is positioned properly in a Cask Unloading Room, shield doors are closed in preparation for removing canisters from the cask. Once the shield doors are shut, the slide gate is opened, to allow the CTM to perform cask unloading operations. Waste package loading operations in the Waste Package Positioning Rooms are analogous to cask unloading operations. The slide gate is opened to allow waste package loading access if the shield doors are closed. Once loading is complete and the slide gate is closed, the shield doors are opened to allow waste package removal.

B3.2.3 Physical Description

The shield doors consist of pairs of large heavy doors that are operated by individual motors with over-torque sensors to prevent crushing of an object. Each door has two position sensors to indicate either a closed or open door and an obstruction sensor prevents the doors from closing on an object. The obstruction sensor is also alarmed to provide operators indication when an object is between the shield doors. The shield doors and slide gate are interlocked to prevent one another from opening if the other is open. The shield doors are opened and closed via a hand lever that must be enabled by an enable/disable switch. An emergency open switch exists enabling the doors to be opened in case of an emergency situation.

Similar to the shield doors, the slide gates consist of two gates that close together between the Waste Package Loadout Room/Cask Unloading Rooms and the Canister Transfer Room. The gates are operated by individual motors that also have over-torque sensors. Each gate has limit switches to indicate open or closed gates. A CTM skirt-in-place switch is interlocked to the slide gate to prevent the gates from opening without the CTM in place. Slide gate operation is controlled by a hand switch coupled with an enable/disable switch and shield door interlocks prevent the slide gate from opening when the shield door is open. Open/closed and CTM in-place indicators exist to assist operators in their activities.

B3.2.3 Schematics

Schematics for the shield door and slide gate are available separately for review (Ref. B3.1.1 and Ref. B3.1.2).

Additional shield door details are available in *Nuclear Facilities Slide Gate Process and Instrumentation Diagram* (Ref. B3.1.1), including slide gate instrumentation.

B3.3 DEPENDENCIES AND INTERACTIONS

Dependencies are broken down into five categories with respect to their interactions with SSCs. The five areas considered are addressed in Table B3.3-1 with the following dependencies:

1. Functional dependence
2. Environmental dependencies
3. Spatial dependence

4. Human dependence
5. Failures based on external events.

Table B3.3-1. Dependencies and Interactions Analysis

Structures, Systems, and Components	Dependencies and Interactions				
	Functional	Environmental	Spatial	Human	External Events
Door/gate motors	—	—	—	Inadvertent operation	—
Door/gate position limit switches	CTM	—	—	—	—
CTM	Gate position switches, obstruction sensor	—	—	—	—
Obstruction sensor	CTM	—	—	—	—

NOTE: CTM = canister transfer machine

Source: Original

B3.4 SLIDE GATE AND SHIELD DOOR FAILURE SCENARIOS

The slide gate and shield door system has three credible failure scenarios as follows:

1. Inadvertent opening of the shield door
2. Inadvertent opening of the slide gate causing direct exposure
3. Shield door closes on conveyance.

B3.4.1 Inadvertent Opening of the Shield Door

B3.4.1.1 Description

Inadvertent opening of the shield door while a canister is being unloaded from a cask or loaded into a waste package can cause an exposure. For this situation to occur, the slide gate must be open for the CTM to be unloading/loading a canister. Interlocks between the slide gate and shield door prevent an operator from being able to open the shield door during canister loading or unloading. However, this situation can occur if the interlocks fail and an operator attempts to open the door, or a spurious open signal is received.

B3.4.1.2 Success Criteria

The success criterion for this failure scenario requires that the interlocks between the slide gate and shield door prevent the shield door from opening.

B3.4.1.3 Design Features and Requirements

Redundant hardwire interlocks prevent the shield door from opening while the slide gate is open and vice versa. The shield door system does not have any test, maintenance, or other modes/settings that allow the bypass of interlocks.

B3.4.1.4 Fault Tree Model

The top event in this fault tree is “Shield Door Inadvertently Opened While Unloading Cask.” This is defined as an opening of the shield door during unloading operations while the cask is in a position that would result in a direct exposure to personnel outside of the Cask Unloading Room. Faults considered in the evaluation of this top event include: failure of components in the control circuitry of the slide door and a human event that could contribute to the inadvertent door opening. The fault tree is shown in Figure B3.4-3.

B3.4.1.5 Basic Event Data

Six basic events, as shown in Table B3.4-1, are used to model this failure scenario, including one HFE, one common-cause failure, and one situational event.

The basic event, “Canister is Exposed During Mid-Unloading” represents the probability that the canister is removed from the cask, but has not reached the CTM skirt yet. The screening value of 1.0 is used for this event.

Table B3.4-1. Basic Event Probabilities for Inadvertent Opening of Shield Door

Basic Event	Description	Calc. Type ^a	Calc. Prob.	Fail. Prob.	Lambda	Miss. Time ^a
060-CR---IELCCF- -IEL-CCF	Common-cause failure of interlocks from slide gate	1	1.290E-06	1.290E-06	0.000E+00	0.000E+00
060-CR--- IEL00A - IEL-FOD	Interlock A from slide gate fails	1	2.750E-05	2.750E-05	0.000E+00	0.000E+00
060-CR--- IEL00B- IEL-FOD	Interlock B from slide gate fails	1	2.750E-05	2.750E-05	0.000E+00	0.000E+00
060-CR---PLC001- -PLC-SPO	Inadvertent signal sent due to PLC failure	3	3.650E-07	0.000E+00	3.650E-07	1.000E+00
060-CR-CASK- UNLOADING	Canister is exposed during mid-unloading	1	1.000E+00	1.000E+00	0.000E+00	0.000E+00
060- OPDIREXPOSE1- HFI-NOD	Operator mistakenly opens door	1	1.000E-01	1.000E-01	0.000E+00	0.000E+00

NOTE: ^a For Calc. Type 3 with a mission time of 0, SAPHIRE performs the quantification using the system mission time.

Calc. = calculation; Fail. = failure; Miss. = mission; PLC = programmable logic controller;
Prob. = probability.

Source: Original

B3.4.1.5.1 Human Failure Events

One HFE is modeled in the fault tree as an operator attempting to open the shield doors during a CTM loading or unloading operation. However, for the operator to open the shield door while the slide gate is open the interlock must fail. The screening value used for this HFE has a probability of 1.0E-01 (Table E.7-1).

B3.4.1.5.2 Common-Cause Failures

One common-cause failure (CCF) scenario is modeled in the fault tree. The redundant interlocks that prevent the shield door from opening while the slide gate is open can both fail to a common-cause. The common-cause alpha factor for two of two successes is 0.047 (Attachment C) which is multiplied with the probability of failure of the component to establish the failure probability of the common-cause event associated with the two common-cause elements.

B3.4.1.6 Uncertainty and Cut Set Generation Results

Figure B3.4-1 contains the uncertainty results obtained from running the fault trees for “Inadvertent Opening of the Shield Door” while unloading cask, using a cutoff probability of 1E-15. Figure B3.4-2 provides the cut set generation results for the “Inadvertent Opening of the Shield Door” fault tree.

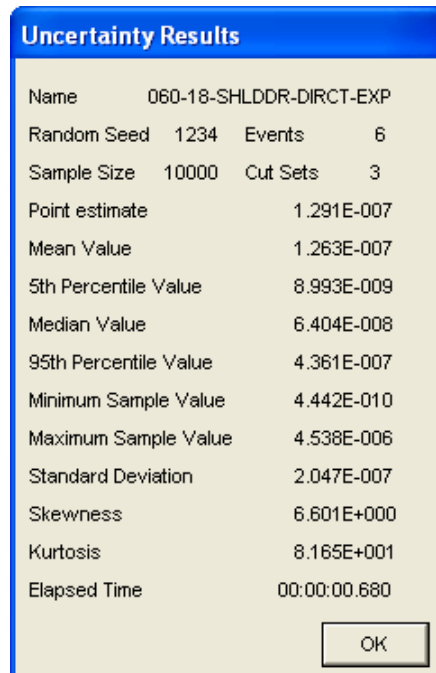

Source: Original

Figure B3.4-1. Uncertainty Results for the Inadvertent Opening of the Shield Door Fault Tree

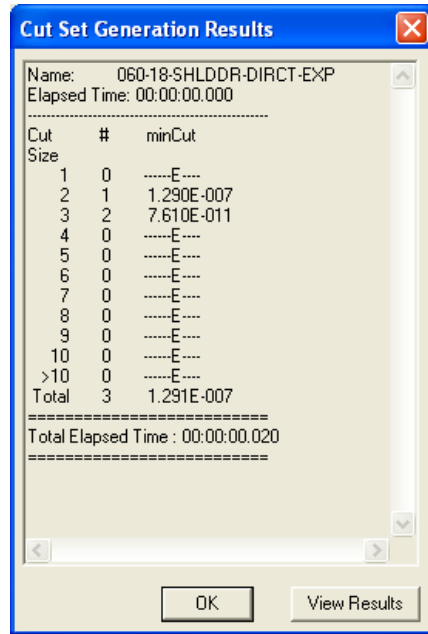

Source: Original

Figure B3.4-2. Cut Set Generation Results for Inadvertent Opening of the Shield Door

B3.4.1.7 Cut Sets

Given the small size of this fault tree, all cut sets are displayed in Table B3.4-2.

Table B3.4-2. Cut Sets for Inadvertent Opening of Shield Door

Fault Tree	Cut Set %	Prob./Freq.	Basic Event	Description	Probability
060-18-SHLDDR-DIRCT-EXP	99.94	1.290E-007	060-CR---IELCCF--IEL-CCF	Common-Cause Failure of Interlocks From Slide Gate	1.3E-006
			060-OPDIREXPOSE1-HFI-NOD	Operator Mistakenly Opens Door	1.0E-001
	0.06	7.563E-011	060-CR---IEL00A--IEL-FOD	Interlock A From Slide Gate Fails	2.8E-005
			060-CR---IEL00B--IEL-FOD	Interlock B From Slide Gate Fails	2.8E-005
			060-OPDIREXPOSE1-HFI-NOD	Operator Mistakenly Opens Door	1.0E-001
	0.00	4.709E-013	060-CR---IELCCF--IEL-CCF	Common Cause Failure of Interlocks From Slide Gate	1.3E-006
			060-CR---PLC001--PLC-SPO	Inadvertent Signal Sent due to PLC Failure	3.6E-007
			060-CR-CASK-UNLOADING	Canister is Exposed During Mid-Unloading	1.0E+000
		1.291E-007	= Total		

NOTE: Freq. = frequency; PLC = programmable logic controller; Prob. = probability.

Source: Original

B3.4.1.8 Fault Trees

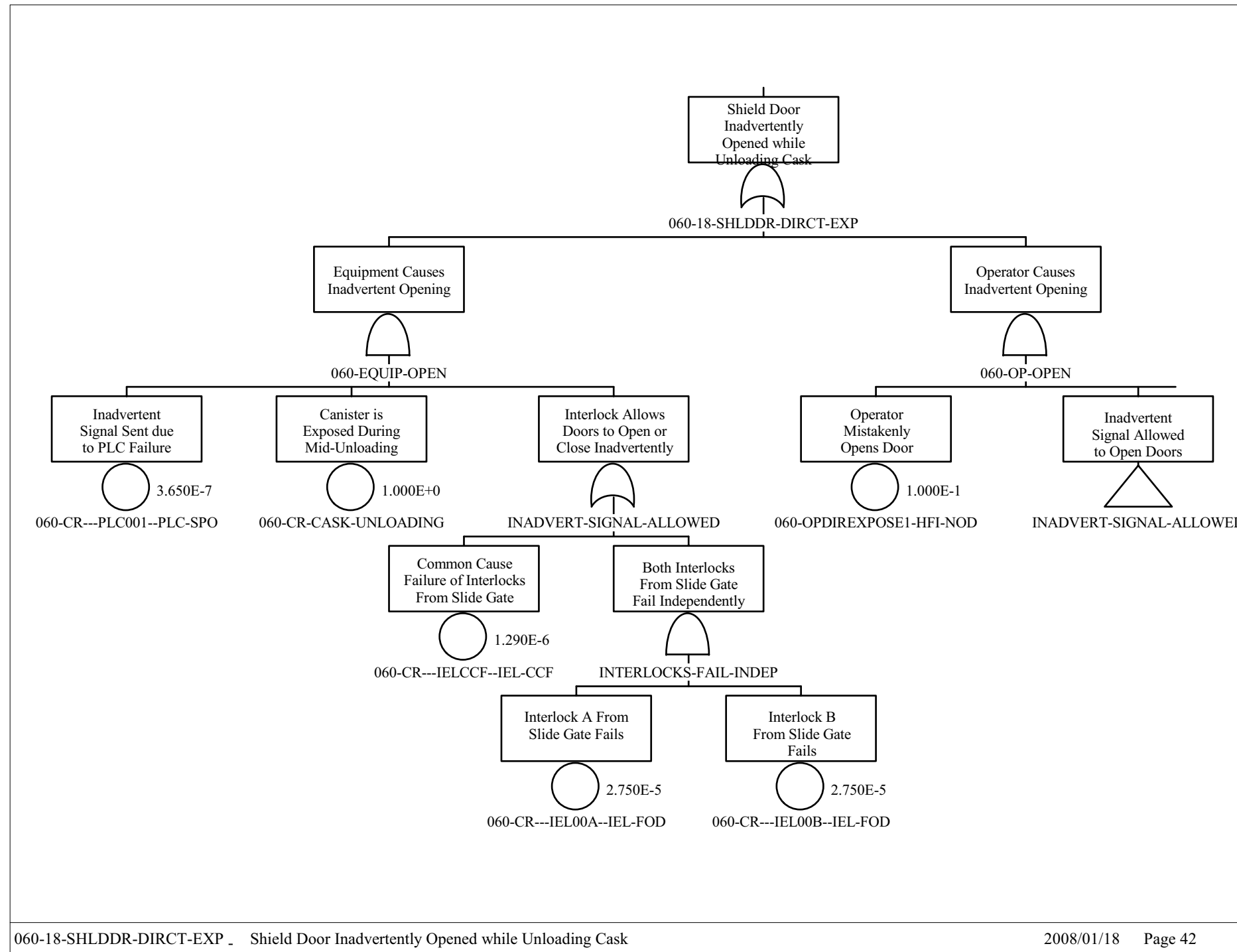

Source: Original

Figure B3.4-3. Fault Trees for Inadvertent Opening of the Shield Door

B3.4.2 Inadvertent Opening of Slide Gate Causing Direct Exposure

B3.4.2.1 Description

Inadvertent opening of a slide gate can result in exposure if personnel are present in the Canister Transfer Room and a radiation source is exposed in a loading or unloading room. There are two ways that a slide gate may be inadvertently opened: (1) an operator mistakenly opens the slide gate or, (2) the control electronics spuriously opens the slide gate. Additionally, an interlock that prevents the slide gate from opening unless CTM skirt is in place must also fail or be disabled. In this situation, the shield door may be closed; therefore the interlocks that prevent the slide gate from opening while the shield door is open do not prevent the slide gate from opening.

B3.4.2.2 Success Criteria

The success criteria for this failure scenario require that the shield bell slide gate not open during canister transfer operations unless the shield skirt is lowered.

B3.4.2.3 Design Features and Requirement

A single interlock shall prevent the slide gate from opening when the CTM skirt is not in place.

B3.4.2.4 Fault Tree Model

The top event in this fault tree is “Slide Gate Inadvertently Opens Causing Direct Exposure.” This is defined as an opening of the slide gate during unloading operations while the cask is in a position that would result in a direct exposure to personnel in the Canister Transfer Room. Faults considered in the evaluation of this top event include: failure of components in the control circuitry of the slide gate and a human event that could contribute to the inadvertent gate opening. The fault tree is shown in Figure B3.4-6.

B3.4.2.5 Basic Event Data

Three basic events, as shown in Table B3.4-3, are used to model this failure scenario, including one human failure event and two hardware events.

Table B3.4-3. Basic Event Probabilities for Inadvertent Opening of Slide Gate Causing Direct Exposure

Name	Description	Calc. Type ^a	Calc. Prob.	Fail. Prob.	Lambda	Miss. Time ^a
060-CR---IELSKT--IEL-FOD	Skirt Interlock Failed	1	2.750E-05	2.750E-05	0.000E+00	0.000E+00
060-CR---PLC001--PLC-SPO	Inadvertent Signal Sent due to PLC Failure	3	3.650E-07	0.000E+00	3.650E-07	0.000E+00
060-OPFAILRSTINT-HFI-NOM	Operator fails to reset interlock after maintenance	1	1.000E-02	1.000E-02	0.000E+00	0.000E+00

NOTE: ^a For Calc. Type 3 with a mission time of 0, SAPHIRE performs the quantification using the system mission time.

Calc. = calculation; Fail. = failure; Miss. = mission; PLC = programmable logic controller; Prob. =probability.

Source: Original

B3.4.2.5.1 Human Failure Events

One HFE is modeled in the fault tree. This HFE is a combination of operator actions and interlock failures that can result in the slide gate being opened when the shield skirt is raised. The development of this event is presented in detail as part of the Human Reliability Analysis in Section 6.4 (Table 6.4-1) and Attachment E.

B3.4.2.5.2 Common-cause Failures

No CCFs have been identified for this fault tree.

B3.4.2.6 Uncertainty and Cut Set Generation

Figure B3.4-4 contains the uncertainty results obtaining from running the fault tree for, “Inadvertent Opening of Slide Gate Causing Direct Exposure” using a cutoff probability of 1E-15. Figure B3.4-5 provides the cut set generation results for. “Inadvertent Opening of Slide Gate Causing Direct Exposure” fault tree.

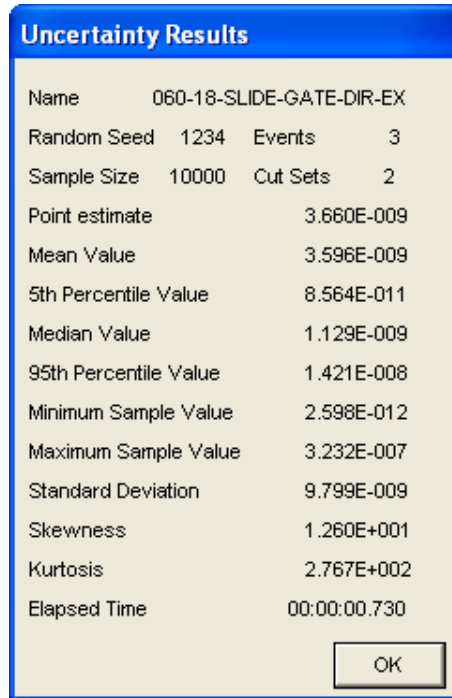

Source: Original

Figure B3.4-4. Uncertainty Results for the Inadvertent Opening of Slide Gate Causing Direct Exposure Fault Tree

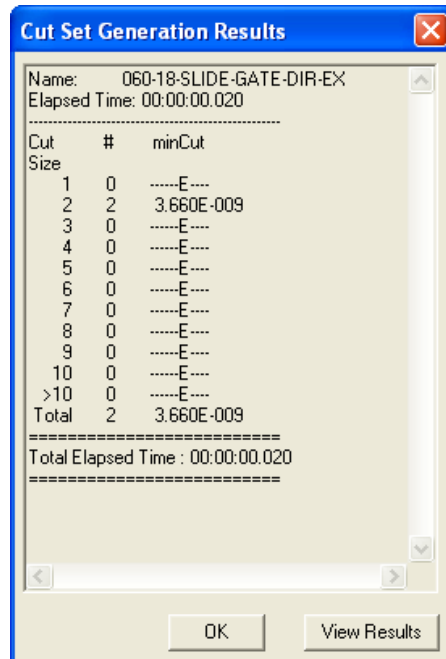

Source: Original

Figure B3.4-5. Cut Set Generation Results for Inadvertent Opening of Slide Gate Causing Direct Exposure

B3.4.2.7 Cut Sets

Table B3.4-4 cut sets for “Inadvertent Opening of Slide Gate Causing Direct Exposure”.

Table B3.4-4. Cut Sets for Inadvertent Opening of Slide Gate Causing Direct Exposure

Fault Tree	Cut Set %	Prob./Freq.	Basic Event	Description	Probability
060-18-SLIDE-GATE-DIR-EX	99.73	3.650E-009	060-CR---PLC001-- PLC-SPO	Inadvertent signal sent due to PLC failure	3.6E-007
			060-OPFAILRSTINT- HFI-NOM	Operator fails to reset interlock after maintenance	1.0E-002
	0.27	1.000E-011	060-CR---IELSKT--IEL- FOD	Skirt interlock fails	2.7E-005
			060-CR---PLC001-- PLC-SPO	Inadvertent signal sent due to PLC failure	3.6E-007
		3.660E-009	= Total		

NOTE: No. = number; PLC = programmable logic controller; Prob. = probability.

Source: Original

B3.4.2.8 Fault Trees

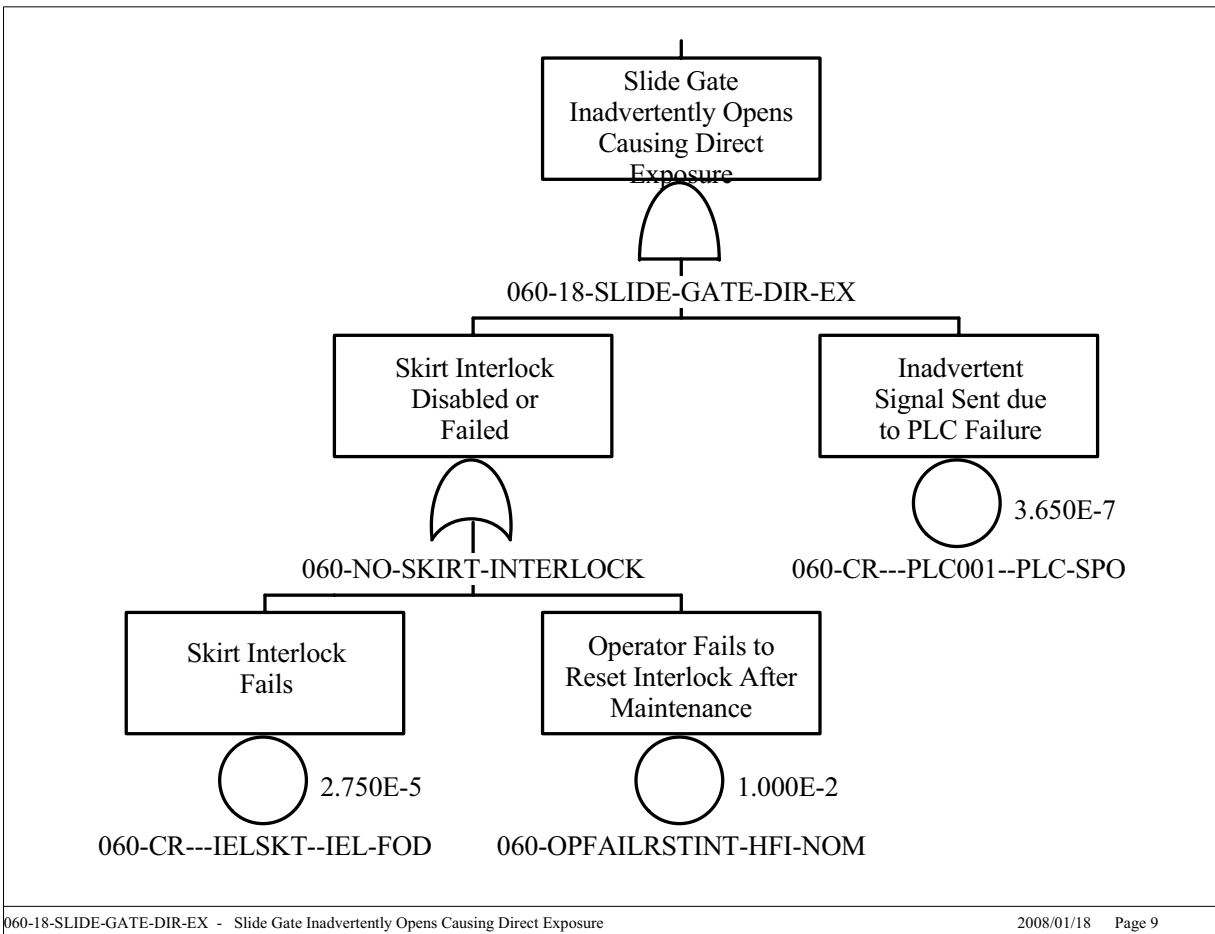

Source: Original

Figure B3.4-6. Fault Trees for Inadvertent Opening of the Slide Gate Causing Direct Exposure

B3.4.3 Shield Door Closes on Conveyance

B3.4.3.1 Description

If the shield doors to the Waste Package Loadout Room/Cask Unloading Room are closed as casks or waste packages are transferred to/from the Cask Unloading Room/Waste Package Loadout Room, a release may occur as a result. Measures are in place to ensure this situation does not occur, including the presence of an obstruction sensor and motor over-torque sensors.

B3.4.3.2 Success Criteria

A success criterion for this scenario is defined as the shield doors not causing a release due to closure on the conveyance. Specifically, success criteria are defined as follows:

- Obstruction sensor prohibits the initiation of shield door closure
- In the event that the obstruction sensor fails and the shield doors do close on a conveyance, the motor over-torque sensors prevent excessive closure force ensuring no release.

B3.4.3.3 Design Features and Requirements

Objects or obstructions shall be detected between the shield doors to prevent door closure initiation. Motor over-torque sensors shall prevent shield doors from causing damage to casks or waste packages in the event of closure on a conveyance.

B3.4.3.4 Fault Tree Model

The top event in this fault tree is “Shield Door Closes on Conveyance.” This is defined as an inadvertent closure of the shield doors due to either operator action or component failure while the conveyance is in position to be hit by the doors. Faults considered in the evaluation of this top event include: failure of components in the control circuitry of the shield doors and human events that could contribute to the inadvertent shield door closing. The fault tree is shown in Figure B3.4-9.

B3.4.3.5 Basic Event Data

Six basic events listed in Table B3.4-5 are used to model this failure scenario, including one human failure event and one common-cause failure.

Table B3.4-5. Basic Event Probabilities for Shield Door Closes on Conveyance

Name	Description	Calc. Type ^a	Calc. Prob.	Fail. Prob.	Lambda	Miss. Time ^a
060-OPSDCLOSE001-HFI-NOD	Operator initiates shield door closure on ST	1	1.000E+00	1.000E+00	0.000E+00	0.000E+00
060-SD---PLC001--PLC-SPO	Spurious signal from PLC closes door	3	3.650E-07	0.000E+00	3.650E-07	1.000E+00
060-SD---SRU001--SRU-FOH	Ultrasonic obstruction sensor fails	7	2.161E-03 ^c	0.000E+00	2.161E-03	1.000E+00
060-SD---TL000---TL--CCF	Common-cause failure of over-torque sensors	3	6.801E-04 ^b	0.000E+00	3.780E-06	1.000E+00
060-SD---TL001---TL--FOH	Motor #1 over-torque sensor fails	3	1.435E-02 ^b	0.000E+00	8.050E-05	1.000E+00
060-SD---TL002---TL--FOH	Motor #2 over-torque sensor fails	3	1.435E-02 ^b	0.000E+00	8.050E-05	1.000E+00

NOTE: ^a For Calc. Type 3 with a mission time of 0, SAPHIRE performs the quantification using the system mission time.

^bTau = 360 hours; ^cTau = 45 hours.

PLC = programmable logic controller; Prob. = probability; ST = site transporter.

Source: Original

B3.4.3.5.1 Human Failure Events

One human failure event (060-OPSDCLOSE001-HFI-NOD) is modeled in the fault tree as an operator attempting to close the shield doors while a conveyance is between the doors. The screening value used for this HFE has a probability of 1.0E+00. The development of this event is presented in detail as part of the Human Reliability Analysis in Attachment E.

B3.4.3.5.2 Common-Cause Failures

One CCF, failure of the shield door over-torque sensors, is considered. This CCF allows the shield doors to continue to attempt to close once an obstruction is encountered, in this case the conveyance.

B3.4.3.6 Uncertainty and Cut Set Generation

Figure B3.4-7 contains the uncertainty results obtained from running the fault tree, “Shield Door Closes on Conveyance” using a cutoff probability of 1E-15. Figure B3.4-8 provides the cut set generation results for the “Shield Door Closes on Conveyance” fault tree.

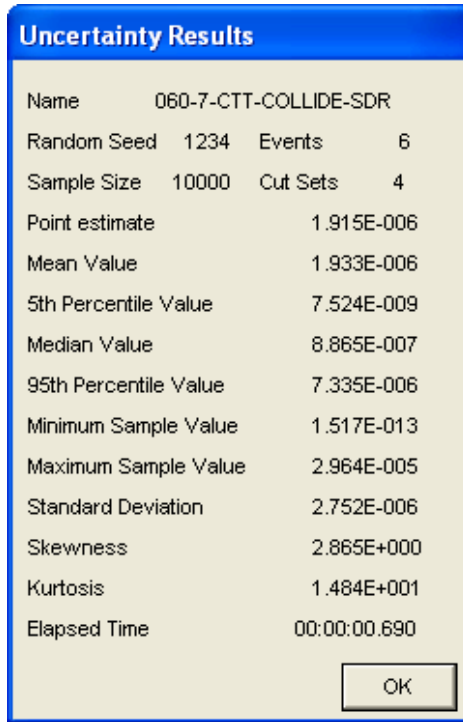

Source: Original

Figure B3.4-7. Uncertainty Results for the Shield Door Closes on Conveyance Fault Tree

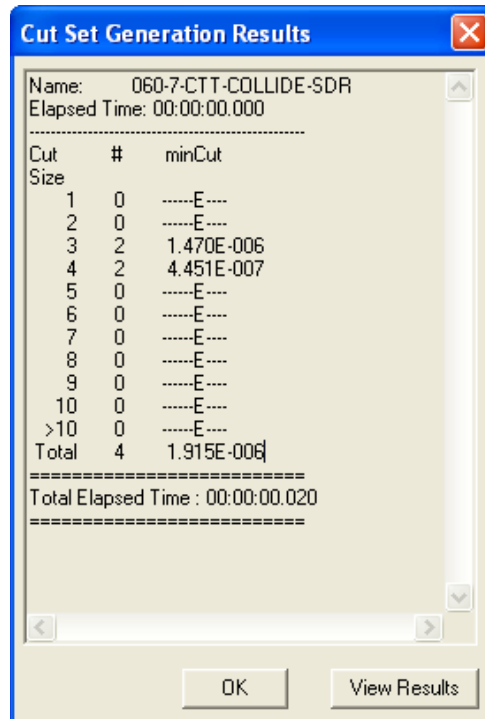

Source: Original

Figure B3.4-8. Cut Set Generation Results for Shield Door Closes on Conveyance Fault Tree

B3.4.3.7 Cut Sets

Table B3.4-6 contains the cut sets for “Shield Door Closes on Conveyance” on the threshold.

Table B3.4-6. Cut Sets for Shield Door Closes on Conveyance

Fault Tree	% Cut Set	Prob./Frequency	Basic Event	Description	Event Prob.
060-7-CTT-COLLIDE-SDR	76.76	1.470E-006	060-OPSDCLOSE001-HFI-NOD	Operator Initiates Shield Door Closure on CTT	1.000E+000
			060-SD---SRU001--SRU-FOH	Ultrasonic Obstruction Sensor Fails	2.161E-003
			060-SD---TL000---TL--CCF	Common Cause Failure of Over Torque Sensors	6.801E-004
	23.24	4.451E-007	060-OPSDCLOSE001-HFI-NOD	Operator Initiates Shield Door Closure on CTT	1.000E+000
			060-SD---SRU001--SRU-FOH	Ultrasonic Obstruction Sensor Fails	2.161E-003
			060-SD---TL001---TL--FOH	Motor #1 over Torque Sensor Fails	1.435E-002
			060-SD---TL002---TL--FOH	Motor #2 Over Torque Sensor Fails	1.435E-002
	0.00	5.365E-013	060-SD---PLC001--PLC-SPO	Spurious Signal from PLC Closes Door	3.650E-007
			060-SD---SRU001--SRU-FOH	Ultrasonic Obstruction Sensor Fails	2.161E-003
			060-SD---TL000---TL--CCF	Common Cause Failure of Over Torque Sensors	6.801E-004
	0.00	1.625E-013	060-SD---PLC001--PLC-SPO	Spurious Signal from PLC Closes Door	3.650E-007
			060-SD---SRU001--SRU-FOH	Ultrasonic Obstruction Sensor Fails	2.161E-003
			060-SD---TL001---TL--FOH	Motor #1 over Torque Sensor Fails	1.435E-002
			060-SD---TL002---TL--FOH	Motor #2 Over Torque Sensor Fails	1.435E-002

NOTE: CTT = cask transfer trolley; Fail. = failure; PLC = programmable logic controller; Prob. = probability.

Source: Original

B3.4.3.8 Fault Trees

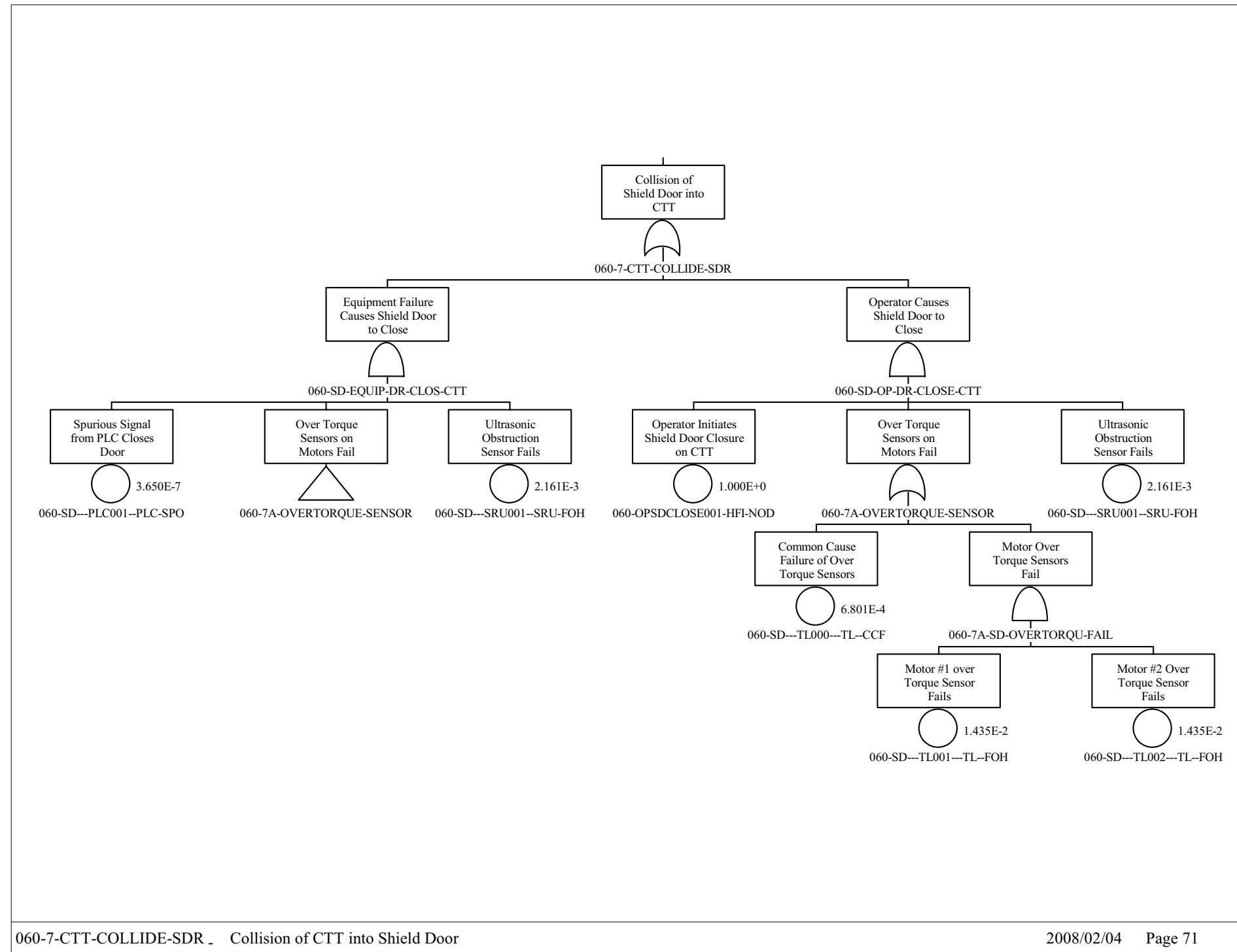

Source: Original

Figure B3.4-9. Fault Trees for Shield Door Closes on Conveyance

B4 CRCF CANISTER TRANSFER MACHINE FAULT TREE ANALYSIS

B4.1 REFERENCES

Design Inputs

The PCSA is based on a snapshot of the design. The reference design documents are appropriately documented as design inputs in this section. Since the safety analysis is based on a snapshot of the design, referencing subsequent revisions to the design documents (as described in EG-PRO-3DP-G04B-00037, *Calculations and Analyses* (Ref. 2.1.1, Section 3.2.2.F)) that implement PCSA requirements flowing from the safety analysis would not be appropriate for the purpose of the PCSA.

- B4.1.1 ASME NOG-1-2004. 2005. *Rules for Construction of Overhead and Gantry Cranes (Top Running Bridge, Multiple Girder)*. New York, New York: American Society of Mechanical Engineers. TIC: 257672. ISBN: 0-7918-2939-1.
- B4.1.2 BSC (Bechtel SAIC Company) 2007. *CRCF, RF, WHF and IHF Canister Transfer Machine Process and Instrumentation Diagram Sheet 1 of 4*. 000-M60-HTC0-00101-000 REV 00C. Las Vegas, Nevada: Bechtel SAIC Company. ACC: ENG.20071218.0028.
- B4.1.3 BSC 2007. *CRCF, RF, WHF and IHF Canister Transfer Machine Process and Instrumentation Diagram Sheet 2*. 000-M60-HTC0-00102-000 REV 00B. Las Vegas, Nevada: Bechtel SAIC Company. ACC: ENG.20071030.0022.
- B4.1.4 BSC 2008. *CRCF, RF, WHF and IHF Canister Transfer Machine Process and Instrumentation Diagram Sheet 3*. 000-M60-HTC0-00103-000 REV 00D. Las Vegas, Nevada: Bechtel SAIC Company. ACC: ENG.20080103.0011.
- B4.1.5 BSC 2008. *Mechanical Handling Design Report - Canister Transfer Machine*. 000-30R-WHS0-01900-000 REV 002. Las Vegas, Nevada: Bechtel SAIC Company. ACC: ENG.20080109.0022.

B4.2 CANISTER TRANSFER MACHINE DESCRIPTION

B4.2.1 Overview

Two identical canister transfer machines (CTMs) operate in the Canister Transfer Room of the CRCF. Their function is to transfer waste canisters from a cask on a canister transfer trolley (CTT) or from an aging overpack on a site transporter to an aging overpack, or to a waste package supported by a waste package transfer trolley (WPTT). The CTMs also have the capability of transferring canisters to a temporary staging area for a later transfer to a waste package. The ports in the floor of the Canister Transfer Room provide access to the Cask Unloading Room, Waste Package Loadout Room, and access to the Canister Staging Areas. There are four Canister Staging Areas in the CRCF. Two areas have staging capacities for two TAD canisters. The other two have staging capacities for 10 DOE canisters.

The CTM is an overhead crane bridge with two trolleys as shown in Figure B4.2-1. The first is a canister hoist trolley with a grapple attachment and a hoisting capacity of 70 tons. The second is a shield bell trolley that supports the shield bell. The shield bell is approximately 25-feet tall with an inside diameter of about 6 feet. The bottom end of the shield bell is attached to a larger chamber to accommodate cask lids with a diameter of up to 84 inches. The CTM bottom plate assembly supports a 12-inch thick motorized slide gate. The slide gate, when closed, provides bottom shielding of the canister once the canister is inside the shield bell.

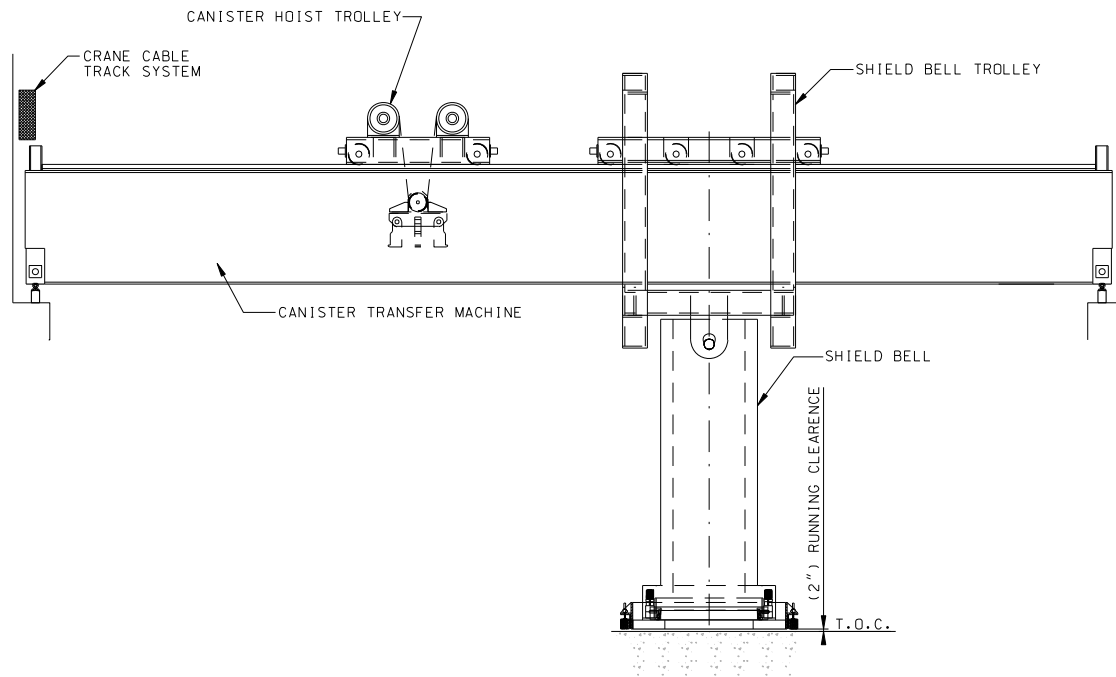

Source: Ref B4.1.5

Figure B4.2-1. Canister Transfer Machine Elevation

Around the perimeter of the bottom plate, a 9-inch thick shield skirt is provided which can be raised and lowered. The shield skirt is used to close any gap between the CTM bottom plate and floor surface to prevent lateral radiation shine during a canister transfer operation. The shield skirt in its lowered position is the only part of the CTM that touches the floor.

The CTM bridge is very similar to a typical crane bridge, with end trucks riding rails supported by wall corbels. Each bridge girder supports two sets of trolley rails; the two inner rails are for the canister hoist trolley and the two outer rails are for the shield bell trolley.

The CTM design allows for the two trolleys to move independently when required for maintenance but they are normally mechanically locked together and operate as a unit when performing a canister transfer operation. The hoist trolley with grapple is positioned over the shield bell and grapple center is aligned with the shield bell center as depicted in Figure B4.2-2.

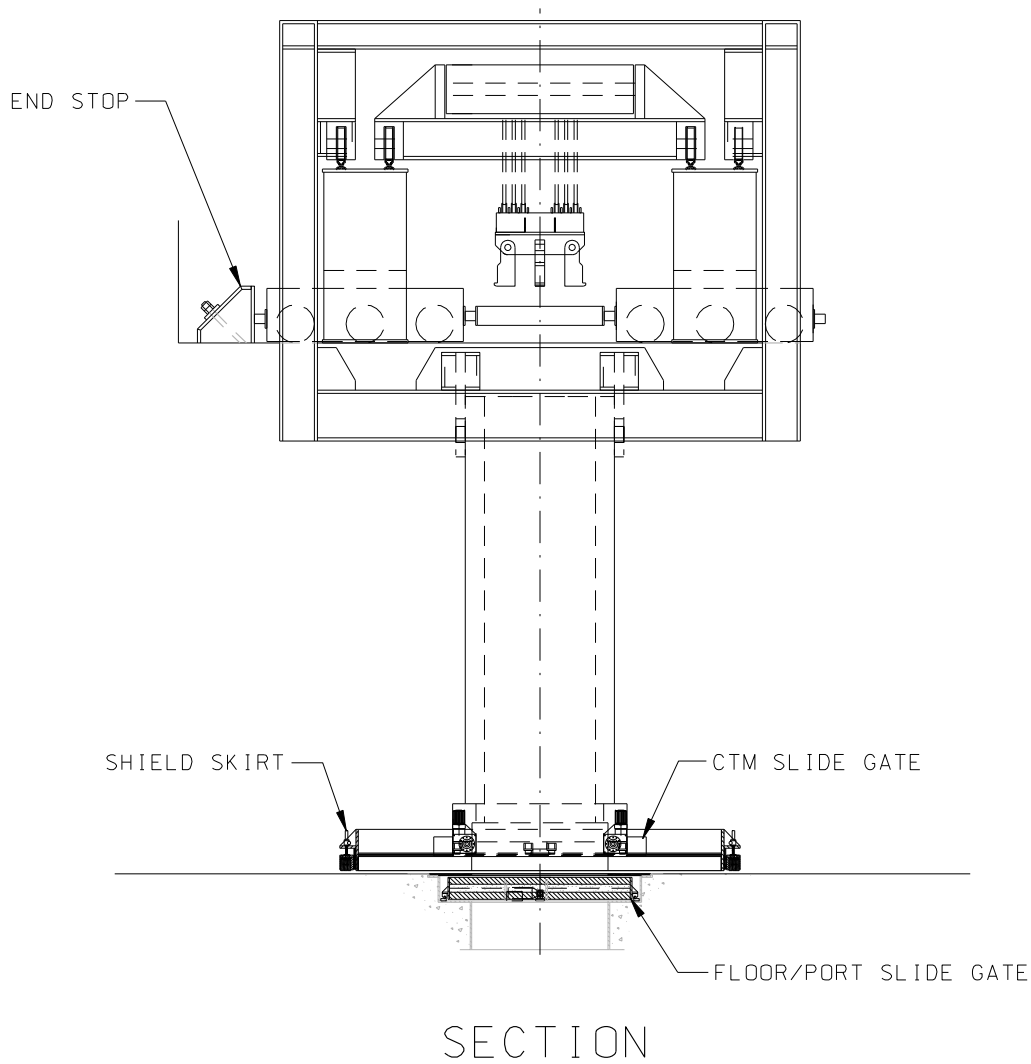

NOTE: CTM = canister transfer machine.

Source: Ref B4.1.5

Figure B4.2-2. Canister Transfer Machine Cross Section

Figures B4.2-3 through B4.2-6 show the ITS related instrumentation and controls incorporated into the CTM (Ref. B4.1.2, Ref. B4.1.3, and Ref. B4.1.4). Hard-wired interlocks are provided to limit the possibility of operator error resulting in a CTM drop (of either a canister or any other object) or collision. While much of the operational controls are provided by programmable logic controllers (PLCs), the operation of these non-important to safety (ITS) devices is not credited in the system analysis. However, spurious operation of the PLCs is considered when such operation may contribute to a drop or collision event. Hard-wired interlocks are provided to:

- Prevent bridge and trolley movement when the shield bell skirt is lowered
- Prevent raising the shield bell skirt when the slide gate is open
- Prevent hoist movement unless the grapple is fully engaged or disengage
- Stop the hoist and erase the lift command when a canister clears the shield bell slide gate
- Stop a lift before upper lift heights are reached (two interlocks are provided for this function)
- Prevent opening of the port gate unless the shield bell skirt is lowered and in position
- Prevent hoist movement unless the shield bell skirt is lowered
- Prevent a collision between the two CRCF CTMs
- Prevent lifting of a load beyond the operational limit of the CTM (load cells).

Some of these interlocks can be bypassed during maintenance. The most significant of these interlocks that can be bypassed is the interlock between the shield skirt position and the position of the slide gate (shield skirt cannot be raised unless the slide gate is closed or the maintenance bypass is engaged.) The design of the grapple interlock ensures that this interlock cannot be bypassed when the CTM is being used during operation.

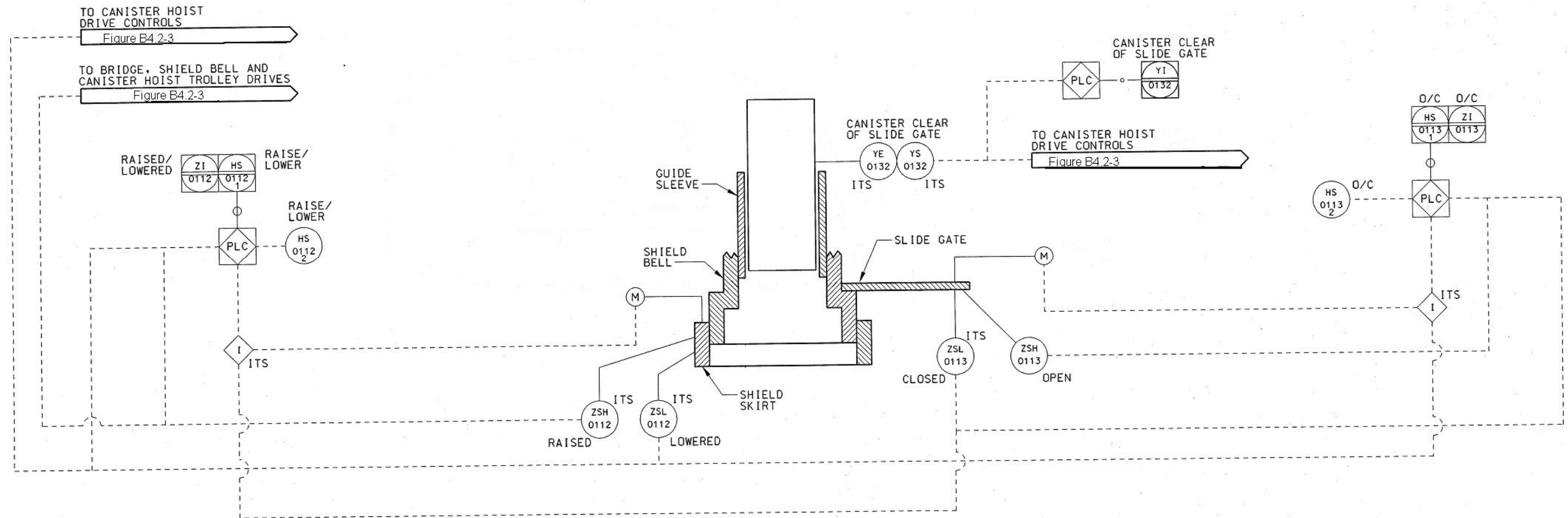

Source: Ref. B4.1.4

Figure B4.2-4. Shield Skirt and Slide Gate Instrumentation

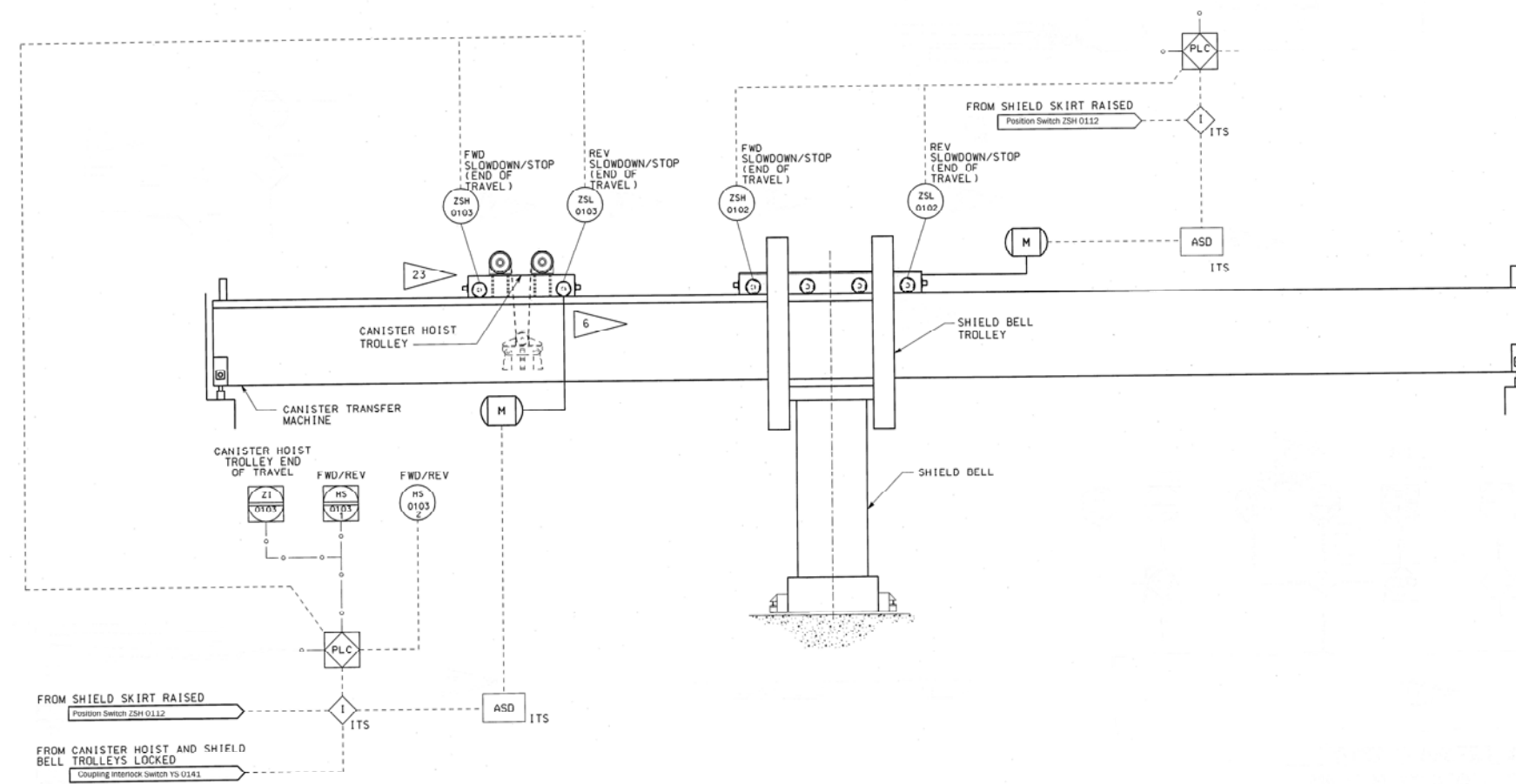

Source: Ref. B4.1.3

Figure B4.2-5. Trolley Instrumentation

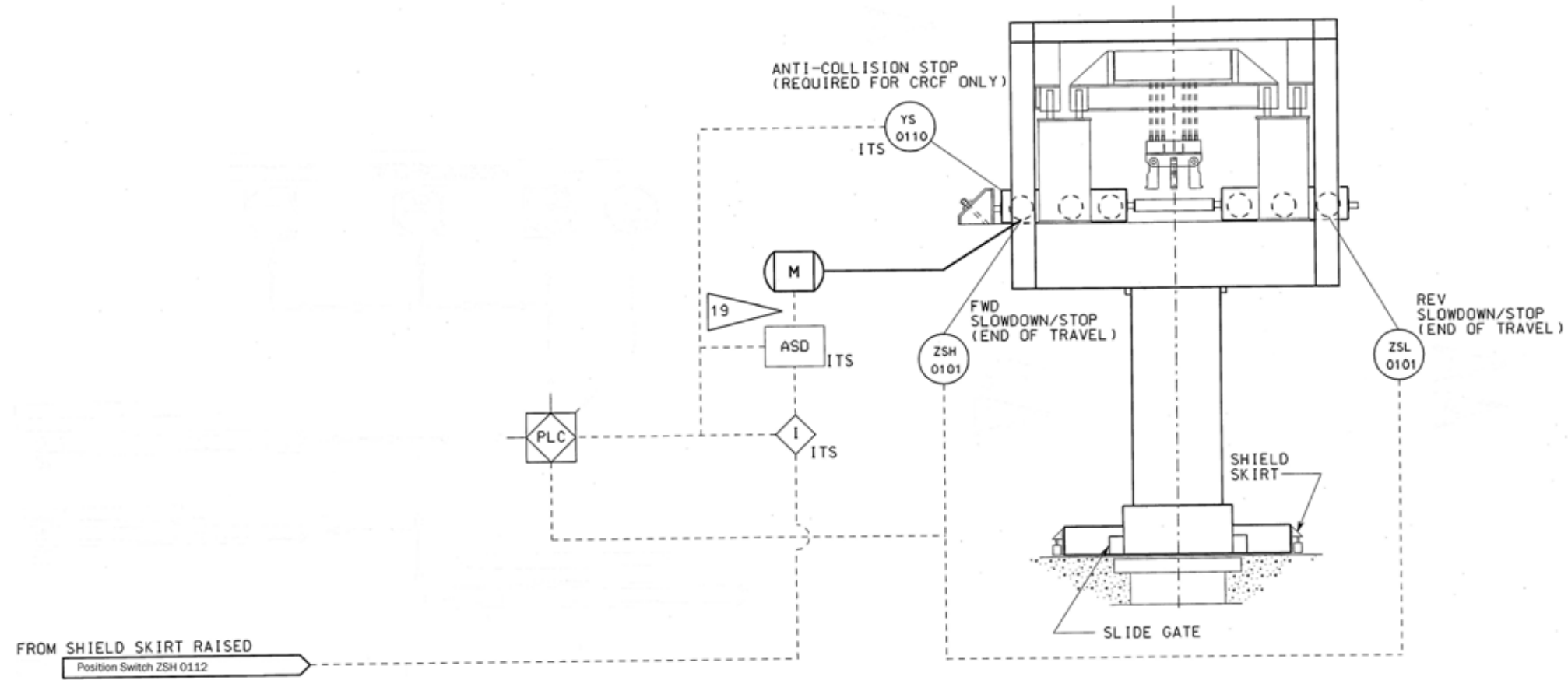

Source: Ref. B4 .1.3

Figure B4.2-6. Bridge Instrumentation

B4.2.2 CTM Bridge

The bridge design meets the requirements of ASME NOG-1-2004 (Ref. B4.1.1) for a Type I crane. The girder design resists the compression, bending, shear, torsion, and buckling loads induced by the fully-loaded trolley, crane dead weight, and impact loads due to seismic events. The end trucks are box section and of high strength design, minimizing deflection and constraining horizontal crane skewing. The flame hardened wheels are attached to the end truck using wheel bearing capsules. Four seismic restraints are provided to prevent excessive horizontal and vertical uplifts.

Hoist, trolley, and bridge drive gearing are enclosed in sealed gear boxes and lubricated with oil of a high flash point, which will not support a flame and fire.

The electric power to the bridge is provided by a crane cable track system along the runway length and supported by the facility wall as shown in Figure B4.2-1.

B4.2.3 Shield Bell Trolley

The shield bell trolley design meets the requirements of ASME NOG-1-2004 (Ref. B4.1.1) for a Type I crane. During a seismic event, seismic restraints prevent the trolley from coming off the rails by limiting the amount of uplift. Electrical power to the trolley is provided through hard-wired connections using a cable track system.

B4.2.4 Canister Hoist Trolley

The hoist trolley design meets the requirements of ASME NOG-1-2004 (Ref. B4.1.1) for a type I crane and is also equipped with seismic restraints. The electrical power to the trolley is provided through hard-wired connections using a festoon system. The trolley incorporates a 70 ton hoist system that uses single-failure-proof technology. A canister grapple is supported by the lower block of the 70-ton hoist. The remotely operated grappling system utilizes limit switches to verify grapple engagement. The grapple utilizes a mechanism that includes a mechanical fail-safe drive that does not allow the grapple to disengage when a load is suspended from the canister grapple.

Additional grapples are required for handling DOE standard, MCO, and HLW canisters. The additional canister grapples are manually attached to the CTM canister grapple and limit switches ensure that a proper and complete connection is made.

The hoist motor is designed to lift and lower the load at a nominal speed of 5 feet per minute. The hoist motor is controlled by an adjustable speed drive (ASD).

B4.2.5 ITS CTM Nominal Operations

A typical CTM canister transfer operation is the transfer of a waste canister from a transportation cask to a waste package. For this operation a loaded transportation cask, secured in the CTT, is positioned below the transfer port in the Cask Unloading Room. The cask lid is in place but unbolted. Similarly, an empty waste package, secured by the WPTT is positioned under the adjacent transfer port in the Waste Package Loading Room.

The CTM is moved to a position over the center of the port above the loaded cask. The shield skirt is lowered to rest on the floor, and the port slide gate is opened. The CTM slide gate is opened and the canister grapple is lowered through the shield bell. The grapple engages a lift fixture on the cask lid. The cask lid is raised into the larger chamber of the CTM. The port slide gate is closed and the shield skirt is raised. The CTM is moved to a cask lid staging area, which is a recess in the floor of the Canister Transfer Room. The cask lid is lowered and placed in the staging area and the grapple is raised.

The CTM is moved over the port above the loaded cask, the CTM grapple is positioned and aligned for the canister pickup, and the shield skirt is lowered. The port slide gate is opened and the grapple is lowered to engage the canister lifting feature. The canister is raised into the shield bell and the hoist stops when a sensor detects that the bottom of the canister has cleared the CTM slide gate. The CTM slide gate and the port slide gate are closed, and the shield skirt is raised.

The CTM is moved to the port above the empty waste package and positioned for canister loading. The shield skirt is lowered and the port slide gate and CTM slide gate are opened. The canister is lowered and placed into the waste package and the grapple is disengaged from the canister.

For co-disposal waste packages, a waste package inner lid (shield plug) is also placed using the CTM after the waste package is loaded.

The CTM canister grapple is used for handling large diameter canisters such as TAD canisters and DPCs. Other grapples are needed to access the smaller diameter DOE SNF and HLW canisters and the MCOs. These grapples are attached to the CTM canister grapple by positioning the CTM over a hatch located in the Canister Transfer Room floor. The CTM hoist is lowered through the shield bell until the CTM grapple is accessible in the room below for canister grapple attachment.

Loading co-disposal waste packages may be moved from the loaded cask to a staging area as an interim step before the canister is placed into a waste package. Transfers of the canisters to be placed into co-disposal waste packages may require this interim step. Advance preparations are required for a co-disposal waste package. For example, for the 5-DHLW/DOE SNF waste package, preparations include availability of a staged DOE SNF canister and availability of five HLW canisters, in a transportation cask and/or in the staging areas. A transportation cask containing one or more HLW canisters is pre-positioned in the Cask Unloading Room. A waste package shield plug with a spreader ring is pre-placed in a lid staging area. An empty waste package is pre-positioned in the loading station of the Waste Package Positioning Room prior to starting the canister transfer operation.

The CTM machine with the correct grapple is used to pick a DOE SNF canister from the Canister Staging Area and place it in the assigned position of the waste package. A grapple change is made for handling the five HLW canisters and they are placed one by one into the waste package. After placement of all canisters in the waste package the last step is to place a shield plug in the waste package. This completes a typical loading operation for a co-disposal type waste package.

The CTM is normally controlled from the Facility Operations Room, but a local control station is also provided.

B4.2.6 ITS CTM Off Normal Operations

Generally, under off-normal conditions the CTM is not in operation. Following a loss of AC offsite power, all power to the CTM motors (hoist, bridge, trolley, and bell trolley) is lost. If a transfer is underway when power is lost, all of the CTM motors would stop and the hoist-holding brake engages. Operations would be suspended until power is restored and the load can be safely moved. Under other off-normal conditions, transfer operations would be suspended and the CTM would remain idle.

B4.2.7 ITS CTM Testing and Maintenance

The CTM is operated, if not on a continual basis, regularly (e.g., once a shift). Most component functionality is verified during CTM operation. For those components that are not exercised during routine operations (e.g., bridge and trolley end-of-travel end stops, hoist upper limit position switches) routine verification of functionality is required.

Testing and Maintenance

Requirements

Testing of components not exercised during routine operation of the CTM are tested annually at a minimum.

Design Features

Normal maintenance is performed in accordance with manufacturer's recommendations; maintenance is performed only when the CTM is not in use.

B4.2.8 Fault Trees

Requirements

The fault tree model for the CTM only includes those components that have been declared as ITS. There is an exception; the spurious operation of PLCs is included in the fault tree model. Spurious operation can result in inadvertent CTM movements.

The mission time for the ITS CTM is set to one hour. Most lifts/transfers require less than one hour. When a transfer consists of several separate activities (e.g., auxiliary equipment movements, lifts, and transfers) each of these activities require less than an hour, but all have been assigned a one-hour mission time.

Design Features

Common-cause failures have been included for three events. Three are associated with position indication sensors: the two upper limit switches on the CTM hoist used to prevent raising a load too high (a two-blocking event), and the port gate position sensors (two gates, one sensor for each gate). Common-cause failure of the hoist cables is also considered.

Seven human error conditions are incorporated into the model. These are for drops initiated by the operator's actions, inadvertent crane movements resulting in impacts, and a failure to restore interlocks allowing movement of the crane when the shield skirt is raised and the slide gates are open.

B4.3 DEPENDENCIES AND INTERACTIONS

Dependencies are broken down into five categories with respect to their interactions with SSCs. The five areas considered are addressed in Table B4.3-1 with the following dependencies:

1. Functional dependence
2. Environmental dependence
3. Spatial dependence
4. Human dependence
5. Failures based on external events.

Table B4.3-1. Dependencies and Interactions Analysis

Systems, Structures, and Components	Dependencies and Interactions				
	Functional	Environmental	Spatial	Human	External Events
ASDs	Position sensors	—	—	—	—
	CTM hoist, bridge, and trolley motors control	—	—	—	—
CTM Bridge	—	—	CTM bridge ^a	—	—
CTM Motors	ASDs, non-ITS power	—	—	Operational control	Off-site power
Port/Slide Gate Position Switches	ASDs	—	—	—	—
Grapple Position (Engaged /Disengaged)	ASDs	—	—	—	—
Shield Skirt Position	ASDs	—	—	—	—
Non ITS Power	CTM motors	—	—	—	—
Obstruction sensor	Hoist motor ASD	—	—	—	—

NOTE: ^a There are two CTMs in the CRCF. Both operate on the same set of bridge rails.
ASD = adjustable speed drive; CTM = canister transfer machine; ITS = important to safety.

Source: Original

B4.4 CTM RELATED FAILURE SCENARIOS

The CTM has six credible failure scenarios:

1. Canister drop from below the canister design-limit drop height. The CTM drops a canister from a height below the design basis height for canister damage (this includes canister drops within the shield bell once the bell slide gate has been closed and drops through the Canister Transfer Room ports to the loading/unloading areas that can occur before the bell slide gate is closed).
2. Canister drop from above the canister design-limit drop height
3. Drop of object onto canister
4. Canister impact. A collision between the canister and the shield bell or Canister Transfer Area floor from any cause during the lift, lateral movement, and lower portions of the canister transfer
5. CTM movement subjects canister to shearing forces. The CTM, while carrying a canister, moves in such a manner (e.g., spurious movements, exceeding bridge or trolley end of travel limits) as to cause an impact of the canister with the shield bell.
6. Collision Between Two CTMs

These six scenarios apply to operations in all three CRCFs. The facilities and operations within each of these facilities is identical; therefore, only one set of fault trees has been developed to address operations within all three facilities.

B4.4.1 Canister Drops from Below the Canister Design-Limit Drop Height

B4.4.1.1 Description

Transfer operations using the CTM entail the possibility of inadvertent drops of the canisters. These drops have been divided into two classes: drops from heights below the design basis drop height of the canister and drops from heights above the design basis drop height of the canister. The fault tree for canister drops addresses the first of these two scenarios.

B4.4.1.2 Success Criteria

Success criterion for the CTM is the prevention of a canister drop from any cause, during the lift, lateral movement, and lower portions of the canister transfer.

B4.4.1.3 Design Features and Requirements

Requirements

Hard-wired interlocks are used to prevent inadvertent actions during CTM transfer operations. These include the following:

- An optical sensor at the bottom of the shield bell that, once it is cleared, stops the hoist and erases the lift command (can only lower hoist). This interlock is used only when lifting a canister.
- Above the ASD stop point is an upper limit switch which, when reached, stops the hoist from lifting. This first limit switch (first hoist upper limit) effectively erases the lift command (the hoist still has power) and the operator can only lower the hoist. Roughly a foot above that limit switch is another limit switch (final hoist upper limit) that, when reached, cuts off the power to the CTM hoist.
- An interlock between the shield skirt and port gate which requires the shield skirt to be lowered in order for the port gate to open. There is a maintenance bypass for this interlock.
- An interlock between the CTM bridge/trolley travel and shield skirt position. Neither the CTM bridge nor the trolley can travel while the skirt is lowered.
- An interlock between the slide gate and shield skirt—the shield skirt cannot be raised unless the slide gate is closed. This interlock can be bypassed, to allow the CTM to move with the slide gate open during lid removal.
- Interlocks preventing improper hoist movement. The hoist cannot move unless the shield skirt is lowered. This interlock is based on hoist movement, not position, so movement with the hoist too low is not precluded.
- Anti-collision interlocks (position driven) for the two CTMs.
- The load cells cut off power to the hoist when the crane capacity is exceeded.
- An interlock between the grapple position (fully engaged or fully disengaged) and hoist movement. The grapple automatically engages/disengages with a given object. The grapple must be positively engaged for the grapple engagement indicator to give a positive indication.

Design Features

- Bridge and trolley motors are sized to limit lateral travel to less than 20 feet per minute, sufficient to ensure that in the event of an impact, impact forces are below the design limits of the canister.
- The shield bell slide gate motors are sized so that they are incapable of exerting sufficient force to damage any canister given an inadvertent closure of the gate when a canister is suspended in the gate closure path.
- The floor port gate motors are sized so that they are incapable of exerting sufficient force to damage any canister given an inadvertent closure of the gate when a canister is suspended in the gate closure path.
- Hard-wired interlocks used to prevent inadvertent actions during CTM transfer operations are ITS; PLCs are not ITS equipment.
- The end stops for both the bridge and trolley end of travel end stops are capable of stopping the bridge/trolley at their maximum speed and preclude impact with any permanent structure.
- The interlock between the grapple position and the operation of the hoist motor cannot be bypassed during CTM canister transfer operations.

B4.4.1.4 Fault Tree Model

The top event in this fault tree is “CTM Drop All Heights.” This is defined as a drop of a canister during transfer operations. Faults considered in the evaluation of this top event include: human events that contribute to a drop (considered in conjunction with the interlocks intended to prevent the erroneous human action) and mechanical (structural) failures of the CTM components. The interlocks and safety features (position controls, load cells, and drum and holding brakes) intended to either prevent CTM failure or given failure of the CTM to prevent a load drop are included in the model.

Structural failures of components including the hoist cables, sheaves, drum, and grapples can result in canister drops. Operator events are addressed for actions including improper grapple connections, misalignments of the hoist and the canister, improper hoist activities and improper lateral movement of the CTM. Protection from these actions are provided by hard-wired interlocks keyed to the position of the CTM (both hoist position and CTM lateral position), slide and port gate doors, and the shield bell skirt. Also considered in the analysis is a canister drop initiated by improper operation of the shield bell slide gates and the port slide gates. While the gate motors are sized to prevent damage to the canister in the event of an inadvertent closure of the gates, the possibility that the gates would close above the canister during a lift, blocking the lift, and causing a canister drop was considered.

Failures specifically considered are:

- Electro-mechanical failures that occur as a result of the random catastrophic failure of hoisting components, such as the grapple of the CTM, or the redundant wire ropes failing independently or by common-cause.
- Electro-mechanical failures that occur as a result of the conveyance, from which the canister is being extracted, moving spuriously during the transfer. In response, a misalignment can develop that may result in the canister getting caught on the edge of the shield bell; tension can develop in the wire ropes, conceivably leading to their failure. A load control safety system is capable of detecting such abnormal tension and reacts by stopping the transfer operations and applying brakes to retain the canister in a safe position. Failure of this system is considered to cause the drop of the canister.
- Electro-mechanical failures that occur as a result of a slide gate spuriously closing during transfer of a canister. There are two types of slide gates: one that closes the port between the lower and the upper floor in the Canister Transfer Room, and another that closes the bottom part of the shield transfer bell. When the canister is lifted from its container, a spurious slide gate closure can result in the canister getting caught up against the gate; tension can develop in the wire ropes, conceivably leading to their failure. The load control safety system detects such abnormal tension and reacts by stopping the transfer operations and applying brakes to retain the canister in a safe position. Failure of this system is considered to cause the drop of the canister.
- Electro-mechanical failures that occur as a result of a spurious movement of the CTM. The CTM has several trolleys that govern lateral movements: one trolley is used for bridge movement, one for the movement of the shield bell, while another one is used for the lateral movement of the load being transferred inside the shield bell. These last two are physically interlocked during transfer operations to ensure coordination between the trolley movements. Spurious actuation of a trolley motor while a canister is below the Canister Transfer Room floor and is attached to the CTM can result in tension developing in the wire ropes, conceivably leading to their failure. Because the load control safety system does not control lateral movements of the CTM, it is not capable of stopping operations in this case.
- Human-related actions associated with the operator inappropriately closing a slide gate during vertical canister movement. As for the spurious electro-mechanical slide gate closure discussed previously, tension in the wire ropes can develop as a result of this event, conceivably leading to their failure. The load control safety system detects such abnormal tension and reacts by stopping the transfer operations and applying brakes to retain the canister in a safe position. Failure of this system is considered to cause the drop of the canister. The human error probability assigned to this HFE is a screening value of 0.001, (i.e., it is a conservative estimate based upon predetermined characteristics of the HFE) (Table 6.4-1).

- Human-related actions associated with the operator causing a drop of a canister, from a low height, during its extraction from its container. The human error probability for this event required a detailed analysis, entailing an examination of human failure scenarios that account for interactions and error-forcing context resulting from the combination of equipment conditions and human factor. The result of this analysis was condensed into a single basic event whose probability embeds the combination of both human and equipment failures necessary to cause a drop, which explains its relatively low value (5×10^{-7}) (Table 6.4-1).

B4.4.1.5 Basic Event Data

Table B4.4-1 contains a list of basic events used in the “Canister Drop from Below the Canister Design-Limit Drop Height” fault trees. Included are the HFEs and the common-cause failure events identified in the previous two sections. There are no maintenance failures associated with the CTM. The CTMs are not in service while they are undergoing maintenance. Sensor failures that could be associated with the failure to restore from maintenance are not expected to contribute significantly to the overall sensor availability.

The canister drop probability modeled by the fault tree is evaluated over a mission time of one hour. This mission time encompasses vertical lifting, lateral movement, and vertical lowering of the canister by the CTM. A longer mission time is also considered for specific components. For example, the fault tree accounts for the failure of standby components whose potential malfunction would remain hidden until they are put into operation. They are consequently evaluated over the interval of time between their actuation, considered to be the duration of a shift, i.e., eight hours. In another example, brakes are also analyzed over a mission time of twenty-four hours. This duration is deemed sufficient to encompass the time required to revert to normal transfer operations, after a malfunction that would have caused a safety system of the CTM to cease transfer activities.

Table B4.4-1. Basic Event Probability for the Canister Drop from Below Canister Drop Height Limit Fault Tree

Name	Description	Calc. Type ^a	Calc. Prob.	Fail. Prob.	Lambda	Miss. Time ^a
060-CTM-#ZSH0112-1ZS-FOH	CTM shield skirt position switch 0112 fails	3	7.230E-06	0.000E+00	7.230E-06	1.000E+00
060-CTM--CBL0001-WNE-BRK	CTM hoist wire rope breaks	1	2.000E-06	2.000E-06	0.000E+00	0.000E+00
060-CTM--CBL0002-WNE-BRK	CTM hoist wire rope breaks	1	2.000E-06	2.000E-06	0.000E+00	1.000E+00
060-CTM--CBL0102-WNE-CCF	CCF CTM hoist wire ropes	1	9.400E-08	9.400E-08	0.000E+00	0.000E+00
060-CTM--DRTRN-CT--FOD	CTM drive train protection and fail detector. Controller failure	1	4.000E-06	4.000E-06	0.000E+00	0.000E+00
060-CTM--DRUM001-DM--FOD	CTM drum failure on demand	1	4.000E-08	4.000E-08	0.000E+00	0.000E+00
060-CTM--DRUMBRK-BRP-FOD	CTM drum brake (pneumatic) failure on demand	1	5.020E-05	5.020E-05	0.000E+00	0.000E+00
060-CTM--DRUMBRK-BRP-FOH	CTM drum brake (pneumatic) failure to hold	3	2.011E-04	0.000E+00	8.380E-06	2.400E+01
060-CTM--EQL-SHV-BLK-FOD	CTM sheaves failure on demand	1	1.150E-06	1.150E-06	0.000E+00	0.000E+00
060-CTM--GRAPPLE-GPL-FOD	CTM grapple failure on demand	1	1.150E-06	1.150E-06	0.000E+00	0.000E+00
060-CTM--HOISTMT-MOE-FTR	CTM hoist motor (electric) fails to run	3	6.500E-06	0.000E+00	6.500E-06	1.000E+00
060-CTM--HOLDBRK-BRK-FOD	Brake failure on demand	1	1.460E-06	1.460E-06	0.000E+00	0.000E+00
060-CTM--HOLDBRK-BRK-FOH	CTM holding brake (electric) failure to hold	3	3.520E-05	0.000E+00	4.400E-06	8.000E+00
060-CTM--IMEC125-IEL-FOD	CTM hoist motor control interlock failure on demand	1	2.750E-05	2.750E-05	0.000E+00	0.000E+00
060-CTM--LOWERBL-BLK-FOD	CTM lower sheaves failure on demand	1	1.150E-06	1.150E-06	0.000E+00	0.000E+00
060-CTM--OVERSP--ZS--FOD	CTM hoist motor speed limit switch failure on demand	1	2.930E-04	2.930E-04	0.000E+00	0.000E+00
060-CTM--PORTGT1-MOE-SPO	Spurious port gate1 motor operation	3	6.740E-07	0.000E+00	6.740E-07	1.000E+00
060-CTM--PORTGT1-PLC-SPO	Port gage PLC spurious operation	3	3.650E-07	0.000E+00	3.650E-07	1.000E+00
060-CTM--PORTGT2-MOE-SPO	Port gate motor (electric) spurious operation	3	6.740E-07	0.000E+00	6.740E-07	1.000E+00
060-CTM--PORTGT2-PLC-SPO	Port gate 2 PLC spurious operation	3	3.650E-07	0.000E+00	3.650E-07	1.000E+00
060-CTM--SLIDEGT-MOE-SPO	CTM slide gate motor (electric) spurious operation	3	6.740E-07	0.000E+00	6.740E-07	1.000E+00
060-CTM--SLIDEGT-PLC-SPO	CTM slide gate PLC spurious operation	3	3.650E-07	0.000E+00	3.650E-07	1.000E+00
060-CTM--SLIDGT2-IEL-FOD	CTM slide gate interlock failure	1	2.750E-05	2.750E-05	0.000E+00	0.000E+00
060-CTM--TROLLY-MOE-SPO	Conveyance motor (electric) spurious operation	3	6.740E-07	0.000E+00	6.740E-07	1.000E+00
060-CTM--UPPERBL-BLK-FOD	CTM upper sheaves failure	1	1.150E-06	1.150E-06	0.000E+00	0.000E+00
060-CTM--WT0125--SRP-FOD	CTM load cell pressure sensor fails on demand	1	3.990E-03	3.990E-03	0.000E+00	0.000E+00
060-CTM--WTSW125-ZS--FOD	CTM load cell limit switch failure on demand	1	2.930E-04	2.930E-04	0.000E+00	0.000E+00

B4-18

March 2008

Table B4.4-1. Basic Event Probability for the Canister Drop from Below Canister Drop Height Limit Fault Tree (Continued)

Name	Description	Calc. Type ^a	Calc. Prob.	Fail. Prob.	Lambda	Miss. Time ^a
060-CTM--YS01129-ZS--FOD	CTM drum brake control circuit limit switch 1129 failure	1	2.930E-04	2.930E-04	0.000E+00	0.000E+00
060-CTM--ZSH0111-ZS--SPO	CTM grapple engaged limit switch spurious Operation	3	1.280E-06	0.000E+00	1.280E-06	1.000E+00
060-CTM-ASD0122#-CTL-FOD	CTM Hoist ASD controller fails	1	2.030E-03	2.030E-03	0.000E+00	8.000E+00
060-CTM-BRIDGMTR-MOE-SPO	CTM bridge motor (electric) spurious operation	3	6.740E-07	0.000E+00	6.740E-07	1.000E+00
060-CTM-HSTTRLLY-MOE-SPO	CTM hoist trolley motor spurious operation	3	6.740E-07	0.000E+00	6.740E-07	1.000E+00
060-CTM-MISSPOOL--DM-MSP	CTM Mis-spool event	3	6.860E-07	0.000E+00	6.860E-07	0.000E+00
060-CTM-PLC0101#-PLC-SPO	CTM bridge motor PLC spurious operation	3	3.650E-07	0.000E+00	3.650E-07	1.000E+00
060-CTM-PLC0102#-PLC-SPO	CTM shield bell trolley PLC spurious operation	3	3.650E-07	0.000E+00	3.650E-07	1.000E+00
060-CTM-PLC0103#-PLC-SPO	CTM hoist trolley PLC spurious operation	3	3.650E-07	0.000E+00	3.650E-07	1.000E+00
060-CTM-SBELTRLY-MOE-SPO	CTM shield bell trolley motor spurious operation	3	6.740E-07	0.000E+00	6.740E-07	1.000E+00
060-CTM-SLIDGT2-SRX-FOD	CTM slide gate position sensor fails on demand	1	1.100E-03	1.100E-03	0.000E+00	0.000E+00
060-CTM-ZSL0111-ZS--SPO	CTM grapple disengaged limit switch spurious operation	3	1.280E-06	0.000E+00	1.280E-06	1.000E+00
060-OPCLCTMGATE1-HFI-NOD	Operator commands doors close	1	1.000E-03	1.000E-03	0.000E+00	0.000E+00
060-OPCTMDROP002-HFI-COD	Operator causes drop of less than design height limit	1	5.000E-07	5.000E-07	0.000E+00	0.000E+00

NOTE: ^a For Calc. Type 3 with a mission time of 0, SAPHIRE performs the quantification using the system mission time.

ASD = adjustable speed drive; CCF = common-cause failure; CTM = canister transfer machine; PLC = programmable logic controller.

Source: Original

B4.4.1.5.1 Human Failure Events

Two basic events are associated with human error (Table B4.4-2). The first of these is for drops initiated by the operator. This event was addressed through a detailed human reliability analysis (Attachment E). The second addresses the inadvertent closure of the port or slide gates during the lift of a canister. A screening evaluation value was used for this event.

Table B4.4-2. Human Failure Events

Name	Description
060-OPCTMDROP002-HFI-COD	Operator causes drop of less than design height limit
060-OPCLCTMGATE1-HFI-NOD	Operator commands doors close

Source: Original

B4.4.1.5.2 Common-cause Failures

One common-cause failure event was considered in the evaluation of this top event. The common-cause event considered is the common-cause failure of the hoist cables. An alpha factor of 0.047 was used to determine the CCF value using two of two as the failure criteria (Table C3-1, CCCG = 2).

B4.4.1.6 Uncertainty and Cut Set Generation

Figure B4.4-1 contains the uncertainty results obtained from running the fault trees for the “Canister Drop from Below the Canister Design-Limit Drop Height” using a cutoff at 1E-15. Figure B4.4-2 provides the cutset generation results for the “Canister Drop from Below the Canister Design-Limit Drop Height”.

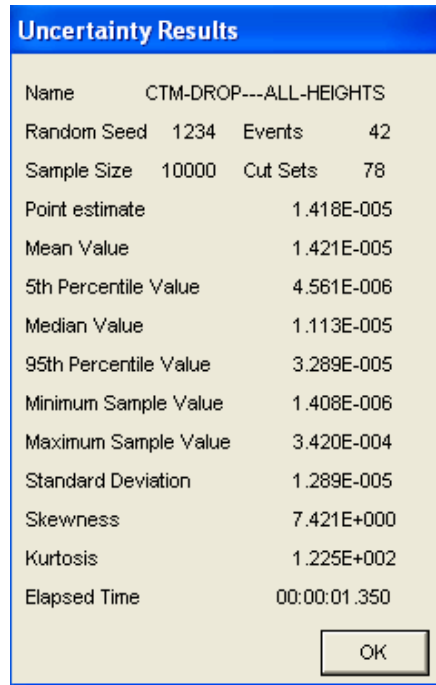

Source: Original

Figure B4.4-1. Uncertainty Results of the “Canister Drop from Below the Canister Design-Limit Drop Height” Fault Tree

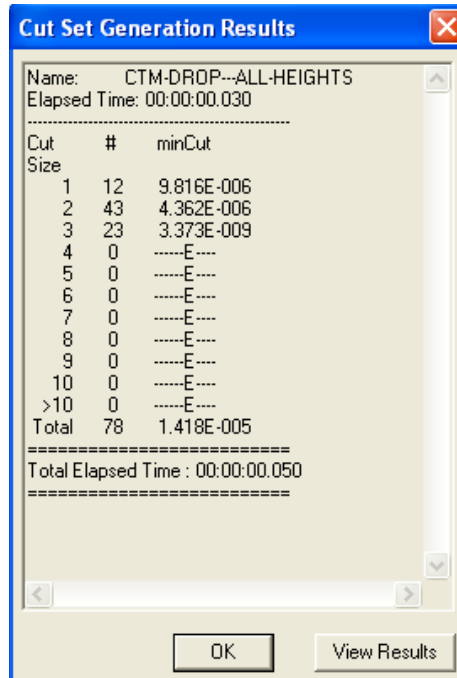

Source: Original

Figure B4.4-2. Cut Set Generation Results for the “Canister Drop from Below the Canister Design-Limit Drop Height” Fault Tree

B4.4.1.7 Cut Sets

Table B4.4-3 contains the top 20 cutsets for the “Canister Drop from Below the Canister Design-Limit Drop Height” fault tree.

Table B4.4-3. Dominant Cut Sets for Canister Drop from Below the Canister Design-Limit Drop Height

% Total	% Cut Set	Probability/Frequency	Basic Event	Description	Event Probability
28.13	28.13	3.990E-06	060-CTM--WT0125--SRP-FOD	CTM load cell pressure sensor fails on demand	3.990E-03
			060-OPCLCTMGATE1-HFI-NOD	Operator commands doors close	1.000E-03
37.16	9.03	1.280E-06	060-CTM--ZSH0111-ZS--SPO	CTM grapple engaged limit switch spurious operation	1.280E-06
46.19	9.03	1.280E-06	060-CTM-ZSL0111-ZS--SPO	CTM grapple disengaged limit switch spurious operation	1.280E-06
54.30	8.11	1.150E-06	060-CTM--LOWERBL-BLK-FOD	CTM lower sheaves failure on demand	1.150E-06
62.41	8.11	1.150E-06	060-CTM--UPPERBL-BLK-FOD	CTM upper sheaves failure	1.150E-06
70.52	8.11	1.150E-06	060-CTM--EQL-SHV-BLK-FOD	CTM sheaves failure on demand	1.150E-06
78.63	8.11	1.150E-06	060-CTM--GRAPPLE-GPL-FOD	CTM grapple failure on demand	1.150E-06
83.38	4.75	6.740E-07	060-CTM-HSTTRLLY-MOE-SPO	CTM hoist trolley motor spurious operation	6.740e-07
88.13	4.75	6.740E-07	060-CTM-SBELTRLY-MOE-SPO	CTM shield bell trolley motor spurious operation	6.740e-07
92.88	4.75	6.740E-07	060-CTM-BRIDGMTR-MOE-SPO	CTM bridge motor (electric) spurious operation	6.740e-07
96.41	3.53	5.000E-07	060-OPCTMDROP002-HFI-COD	Operator causes drop of less than design height limit	5.000E-07
98.48	2.07	2.930E-07	060-CTM--WTSW125-ZS--FOD	CTM load cell limit switch failure on demand	2.930E-04
			060-OPCLCTMGATE1-HFI-NOD	Operator commands doors close	1.000E-03
99.14	0.66	9.400E-08	060-CTM--CBL0102-WNE-CCF	CCF CTM hoist wire ropes	9.400E-08
99.42	0.28	4.000E-08	060-CTM--DRUM001-DM--FOD	CTM drum failure on demand	4.000E-08
99.67	0.25	3.520E-08	060-CTM--HOLDBRK-BRK-FOH	CTM holding brake (electric) failure to hold	3.520E-05
			060-OPCLCTMGATE1-HFI-NOD	Operator commands doors close	1.000E-03
99.86	0.19	2.750E-08	060-CTM--IMEC125-IEL-FOD	CTM hoist motor control interlock failure on demand	2.750E-05
			060-OPCLCTMGATE1-HFI-NOD	Operator commands doors close	1.000E-03
99.88	0.02	2.689E-09	060-CTM--PORTGT2-MOE-SPO	Port gate motor (electric) spurious operation	6.740e-07
			060-CTM--WT0125--SRP-FOD	CTM load cell pressure sensor fails on demand	3.990E-03
99.90	0.02	2.689E-09	060-CTM--SLIDEGT-MOE-SPO	CTM slide gate motor (electric) spurious operation	6.740e-07

Table B4.4-3. Dominant Cut Sets for Canister Drop from Below the Canister Design-Limit Drop Height (Continued)

% Total	% Cut Set	Probability/Frequency	Basic Event	Description	Event Probability
			060-CTM--WT0125--SRP-FOD	CTM load cell pressure sensor fails on demand	3.990E-03
99.92	0.02	2.689E-09	060-CTM--TROLLY-MOE-SPO	Conveyance motor (electric) spurious operation	6.740e-07
			060-CTM--WT0125--SRP-FOD	CTM load cell pressure sensor fails on demand	3.990E-03
99.94	0.02	2.689E-09	060-CTM--PORTGT1-MOE-SPO	Spurious port gate1 motor operation	6.740E-07
			060-CTM--WT0125--SRP-FOD	CTM load cell pressure sensor fails on demand	3.990E-03

NOTE: CCF = common-cause failure; CTM = canister transfer machine.

Source: Original

B4.4.1.8 Fault Trees

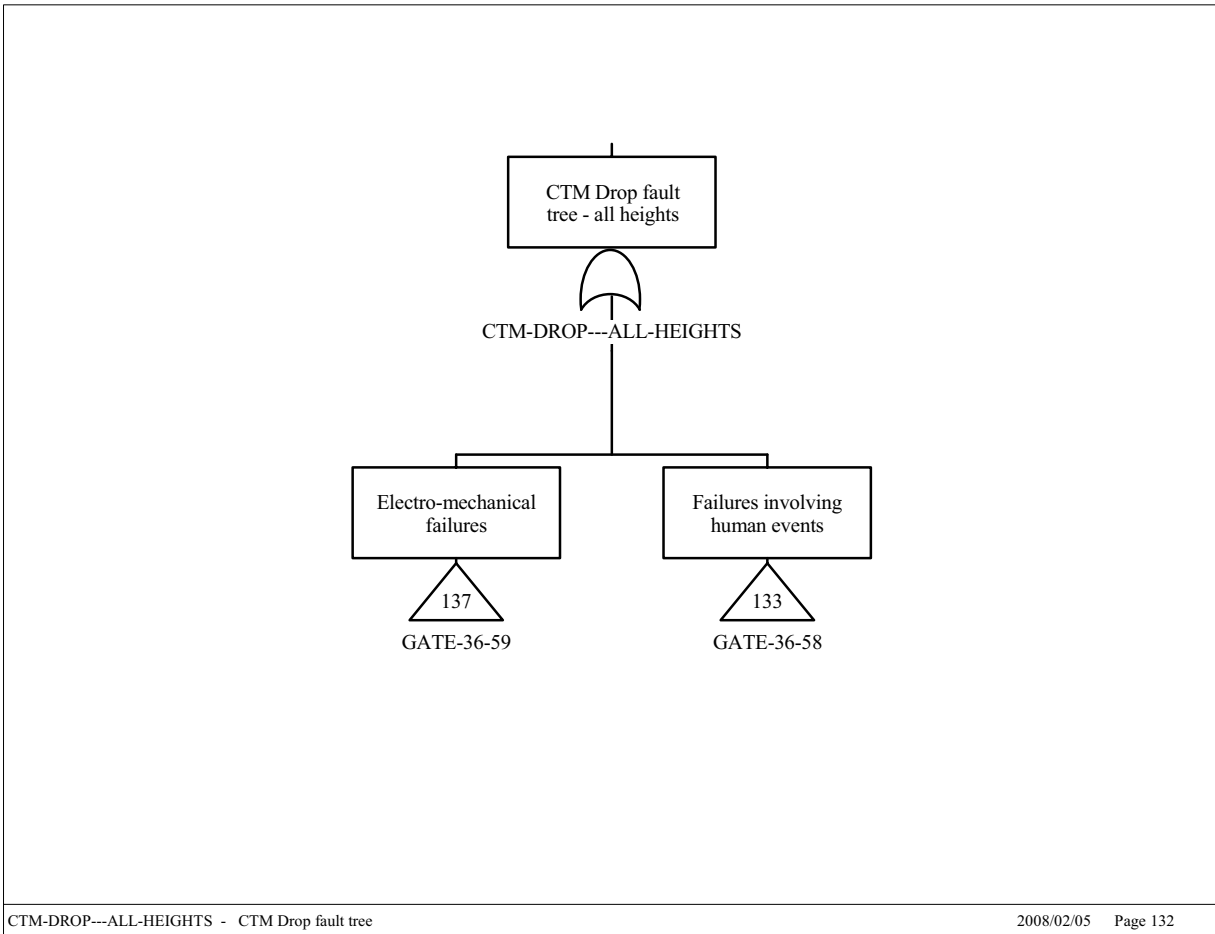

Source: Original

Figure B4.4-3. CTM Drop Fault Tree Sheet 1

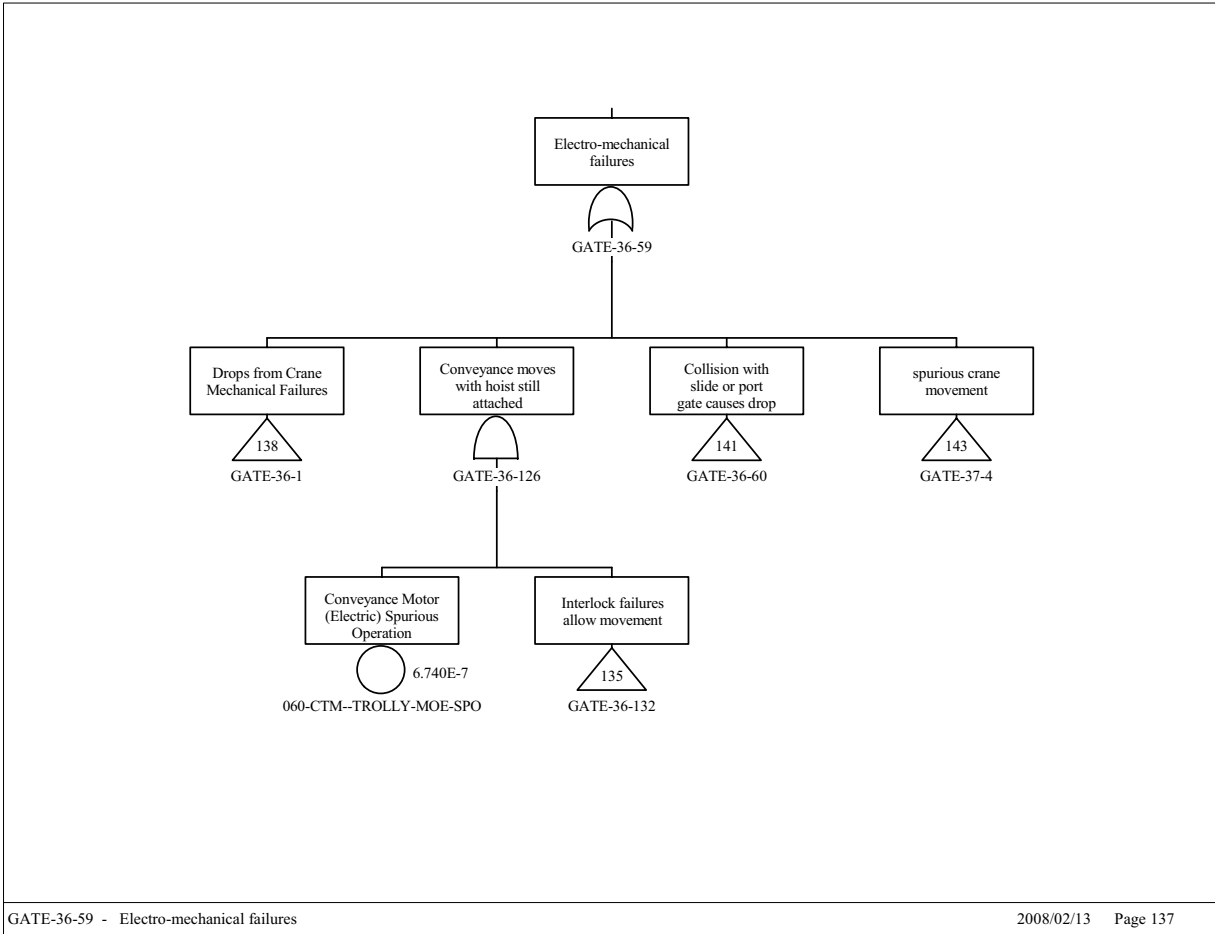

Source: Original

Figure B4.4-4. CTM Drop Fault Tree Sheet 2

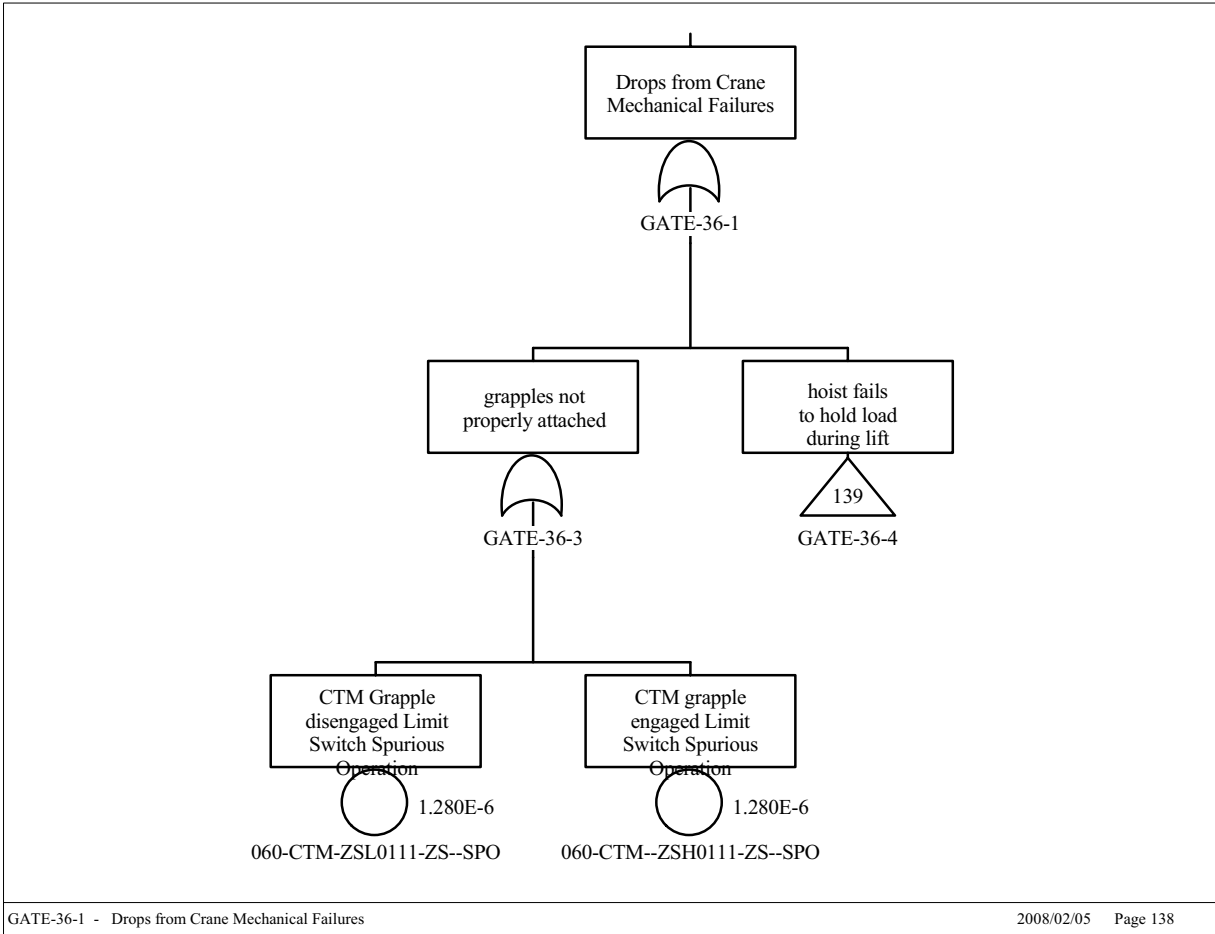

Source: Original

Figure B4.4-5. CTM Drop Fault Tree Sheet 3

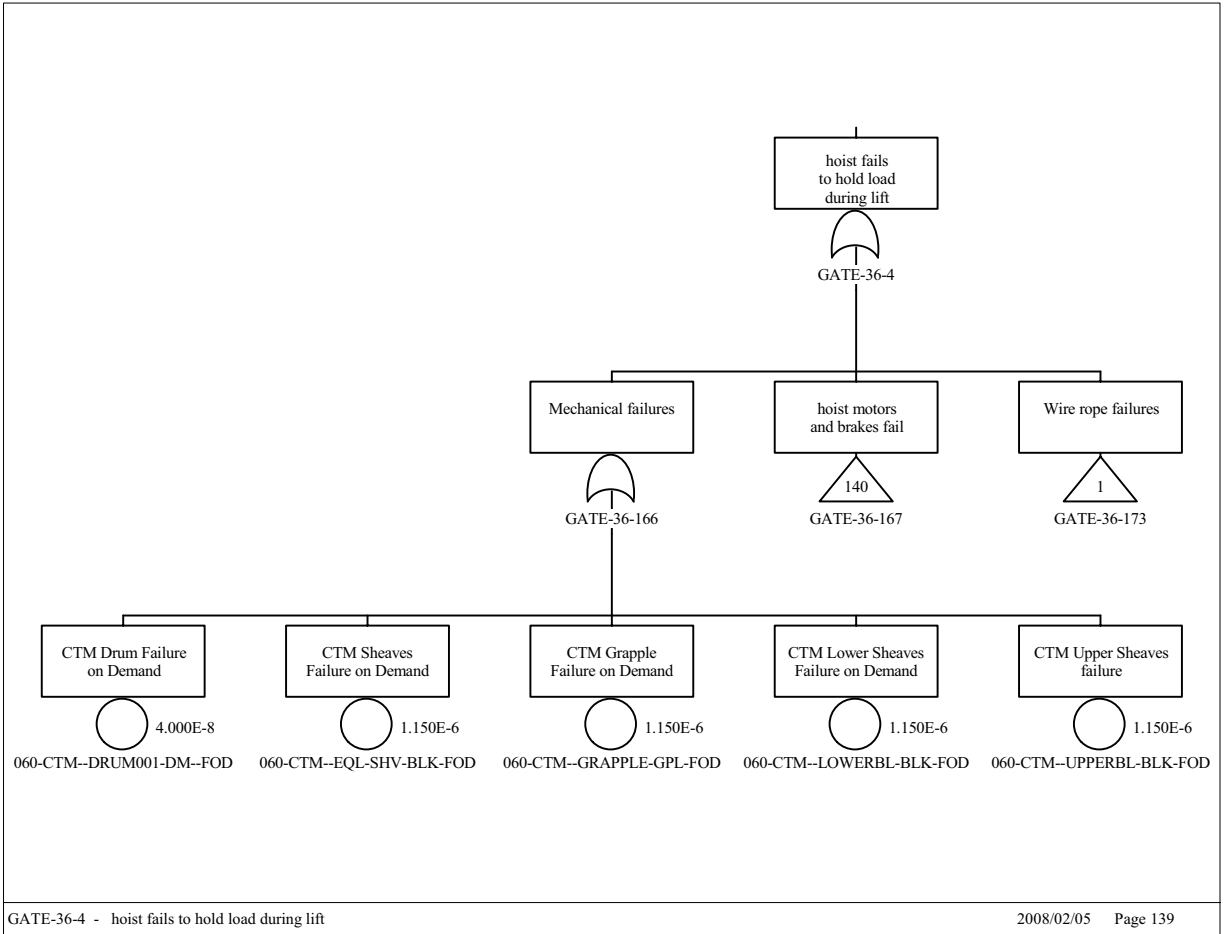

Source: Original

Figure B4.4-6. CTM Drop Fault Tree Sheet 4

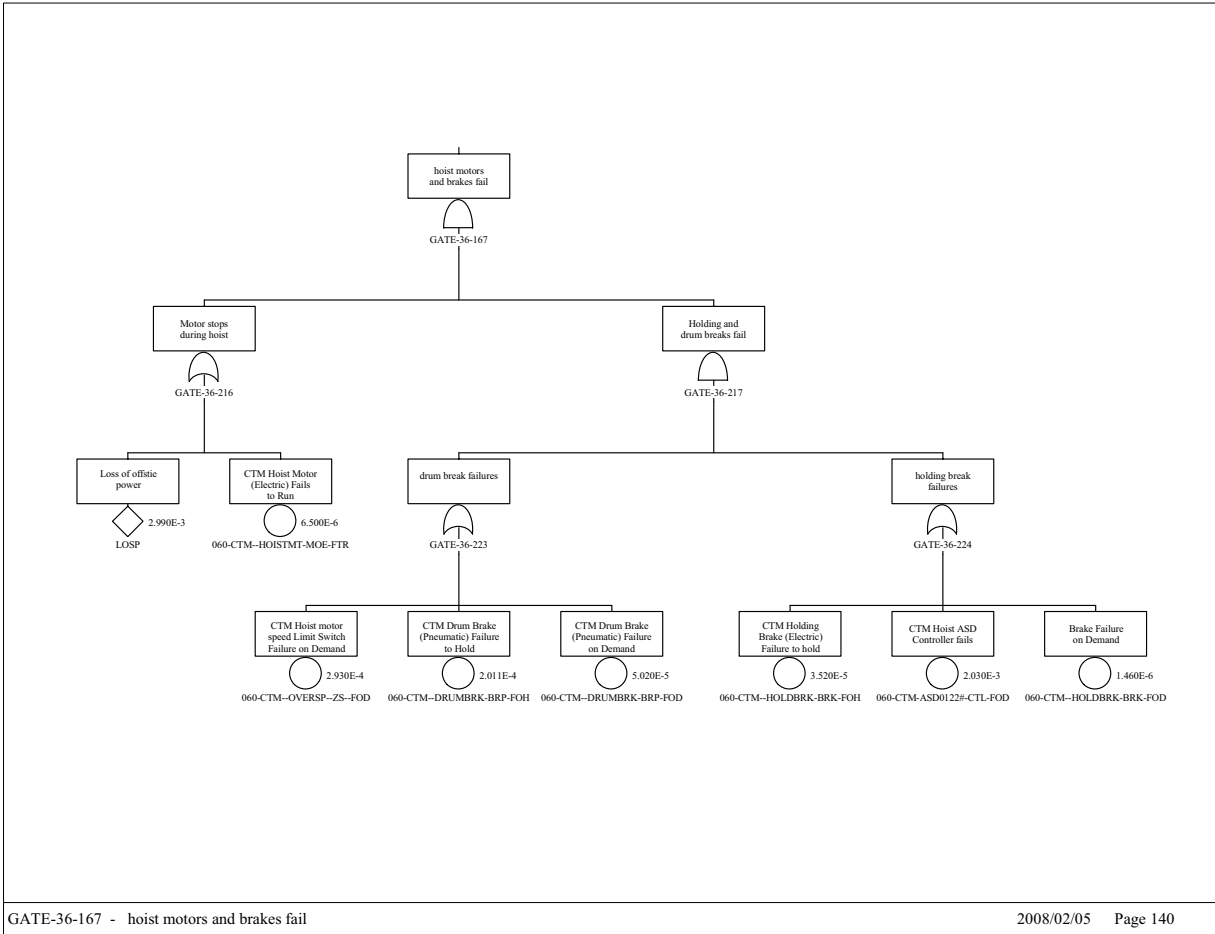

Source: Original

Figure B4.4-7. CTM Drop Fault Tree Sheet 5

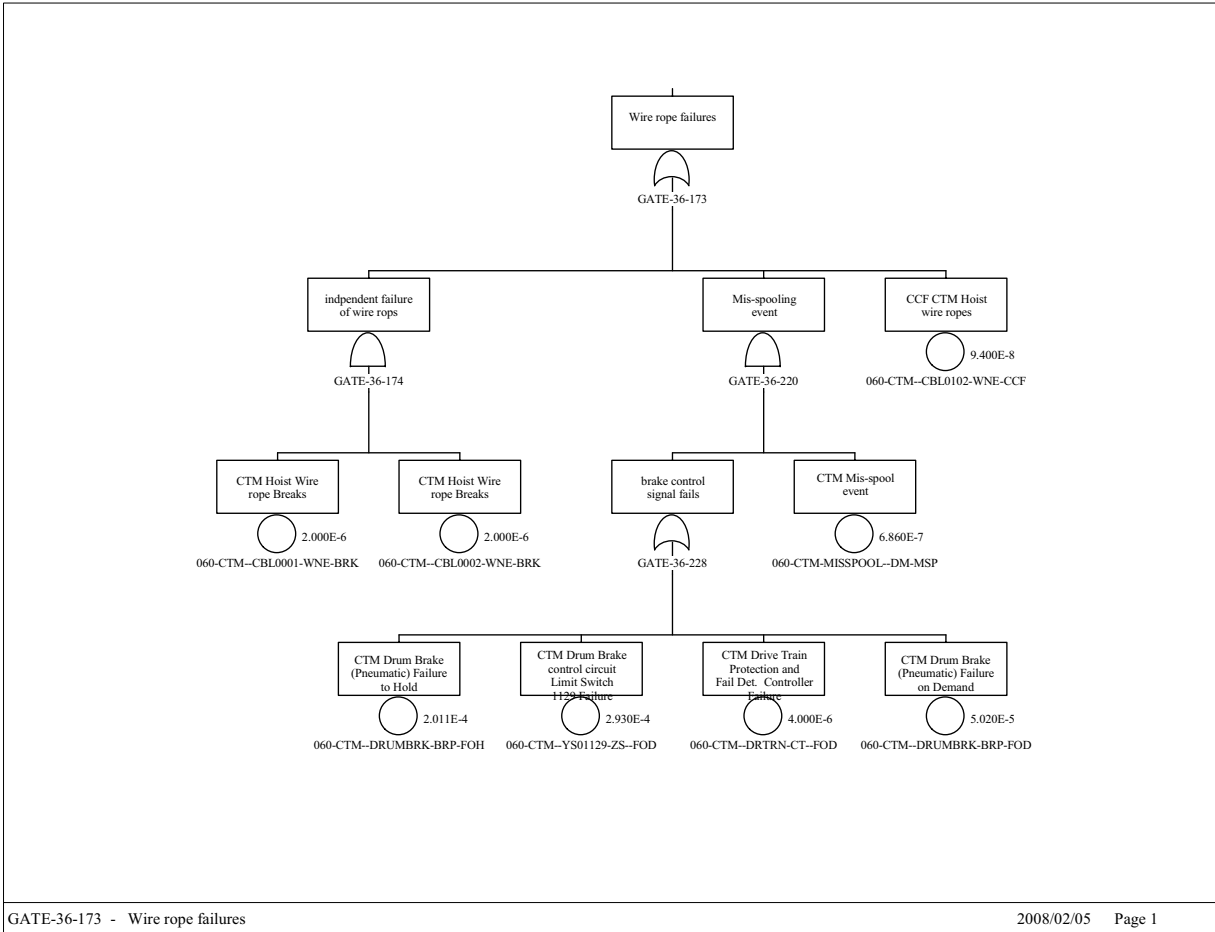

Source: Original

Figure B4.4-8. CTM Drop Fault Tree Sheet 6

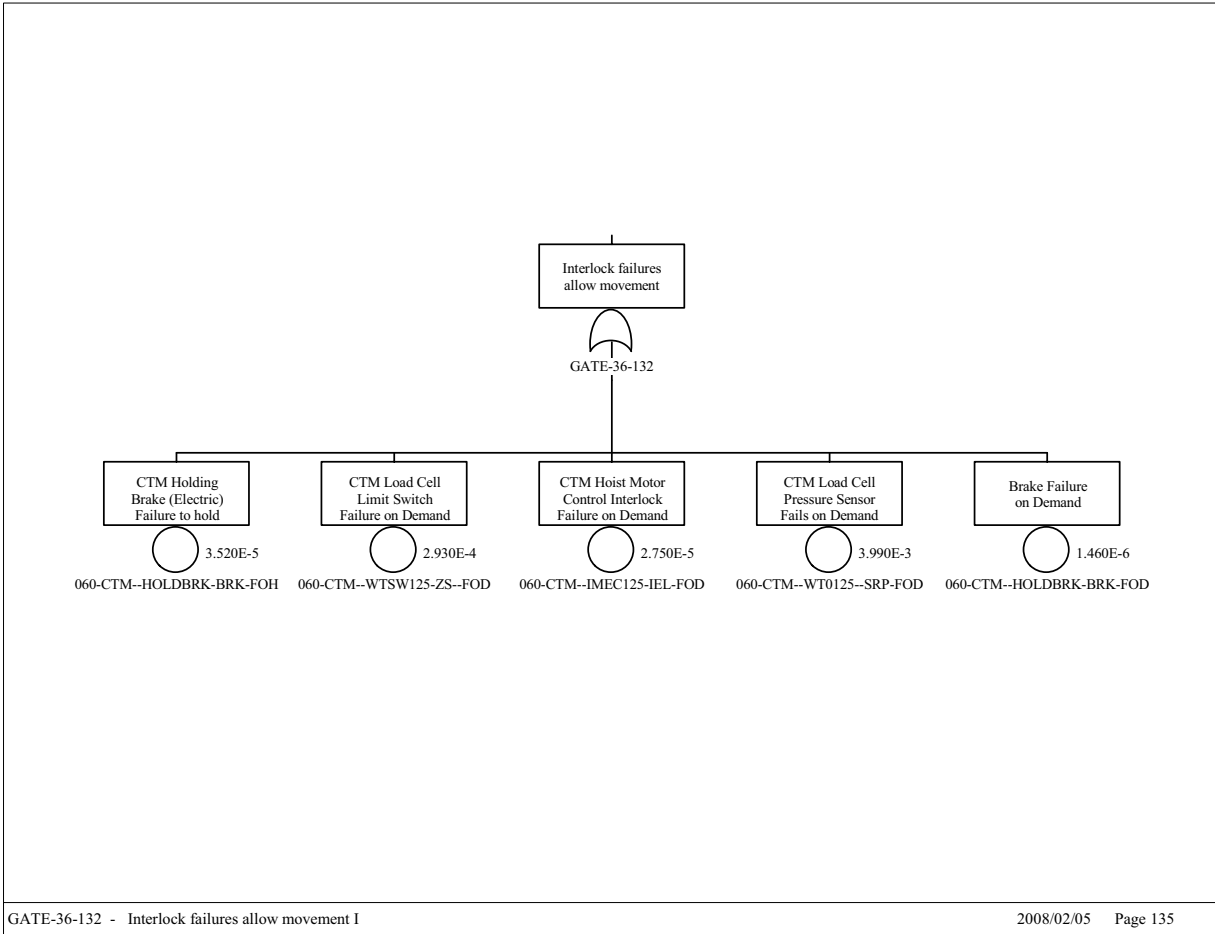

Source: Original

Figure B4.4-9. CTM Drop Fault Tree Sheet 7

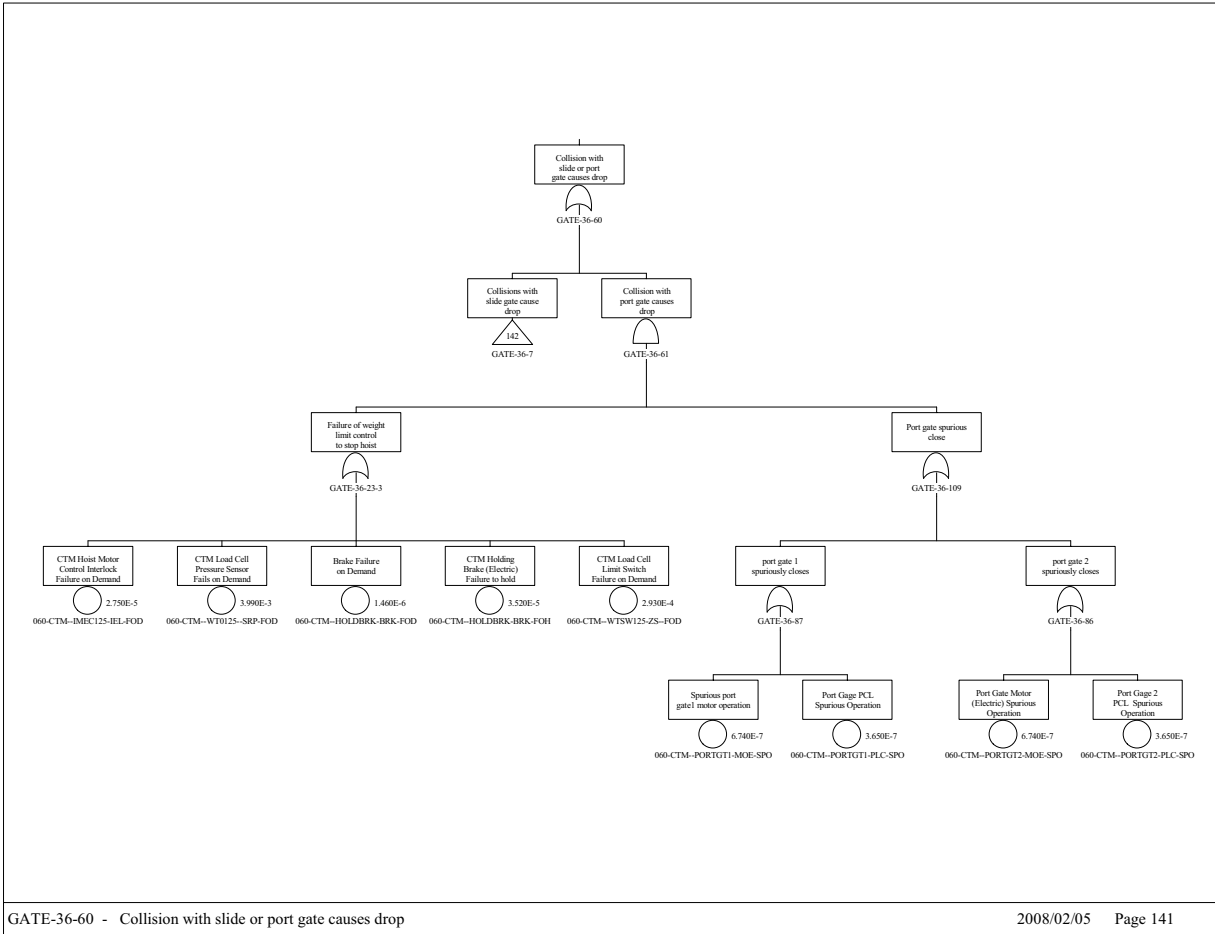

Source: Original

Figure B4.4-10. CTM Drop Fault Tree Sheet 8

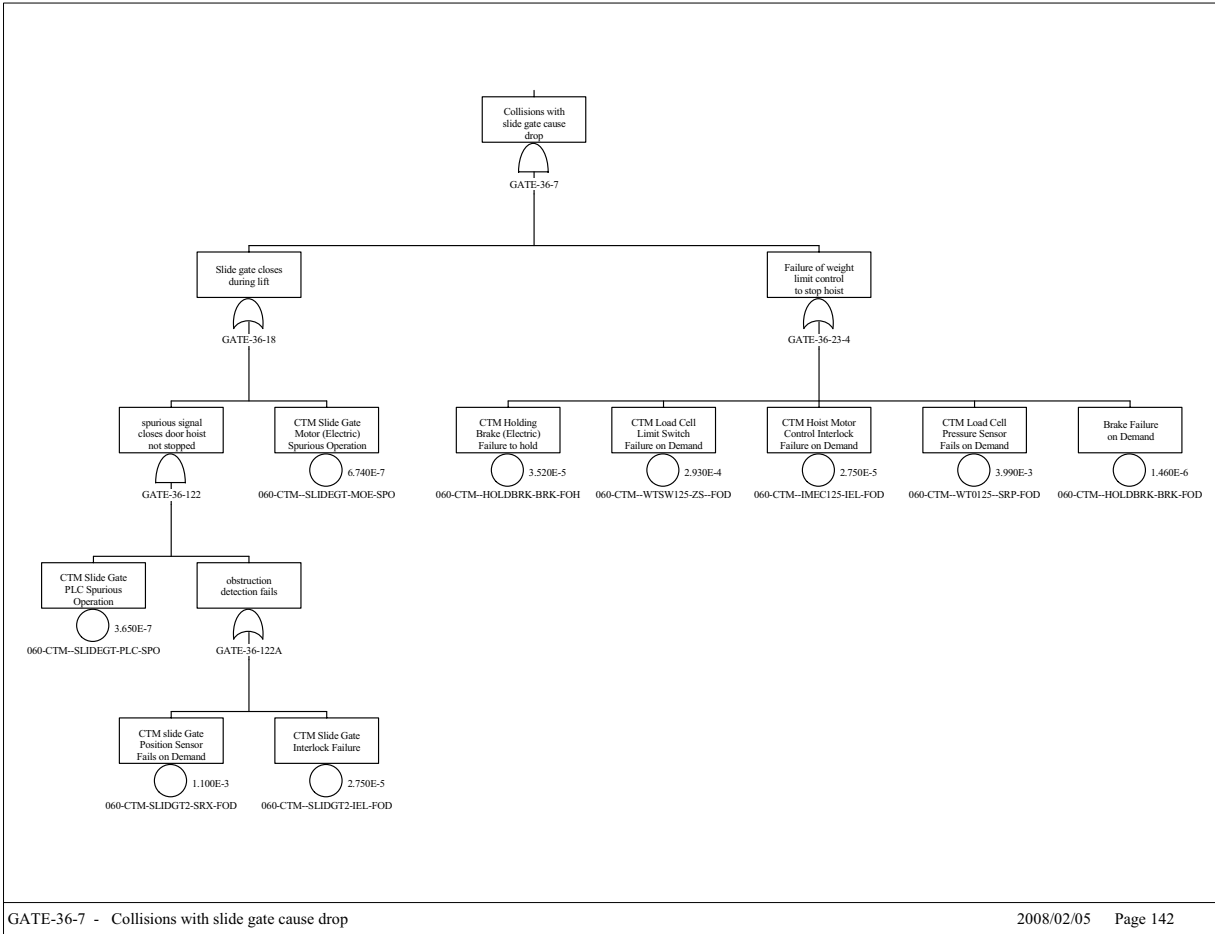

Source: Original

Figure B4.4-11. CTM Drop Fault Tree Sheet 9

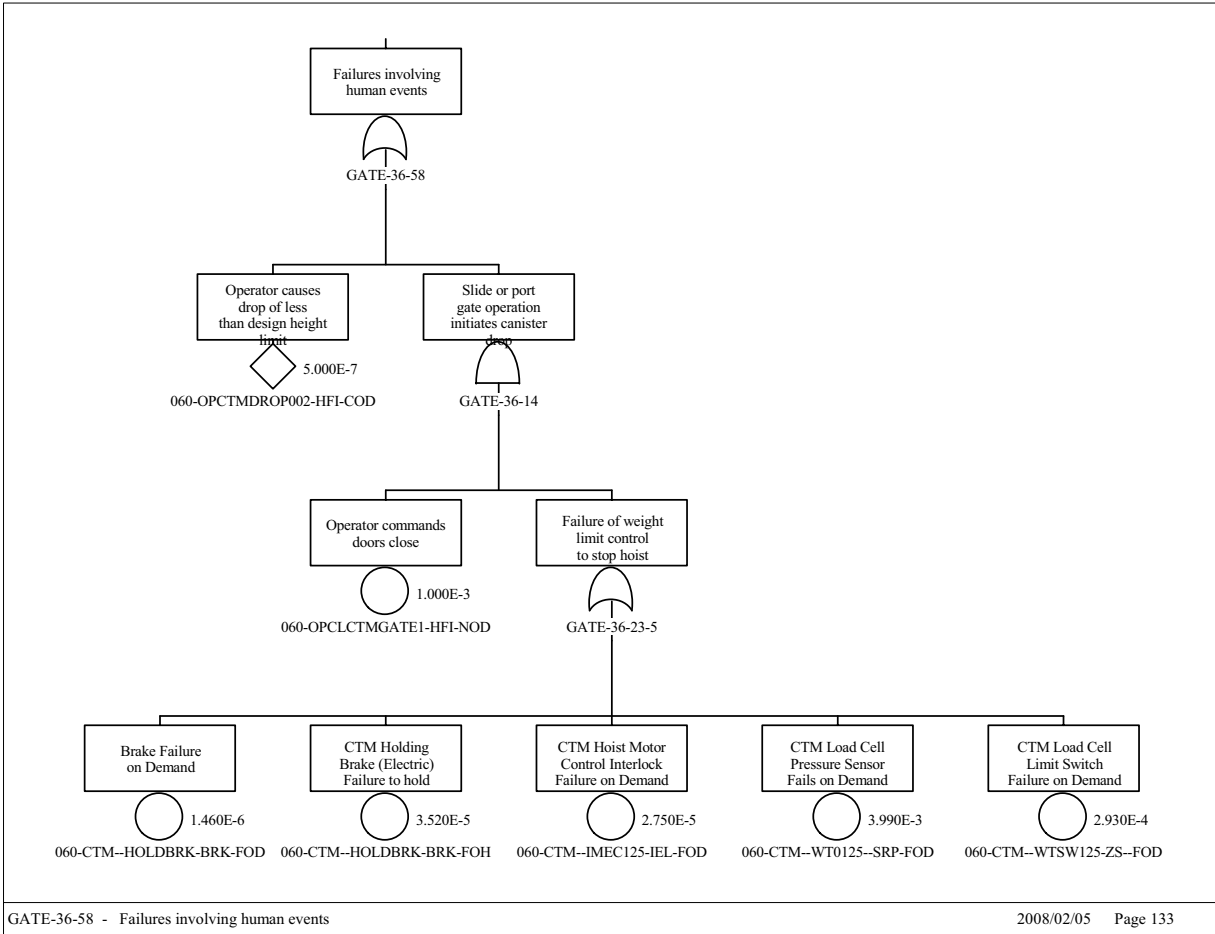

Source: Original

Figure B4.4-12. CTM Drop Fault Tree Sheet 10

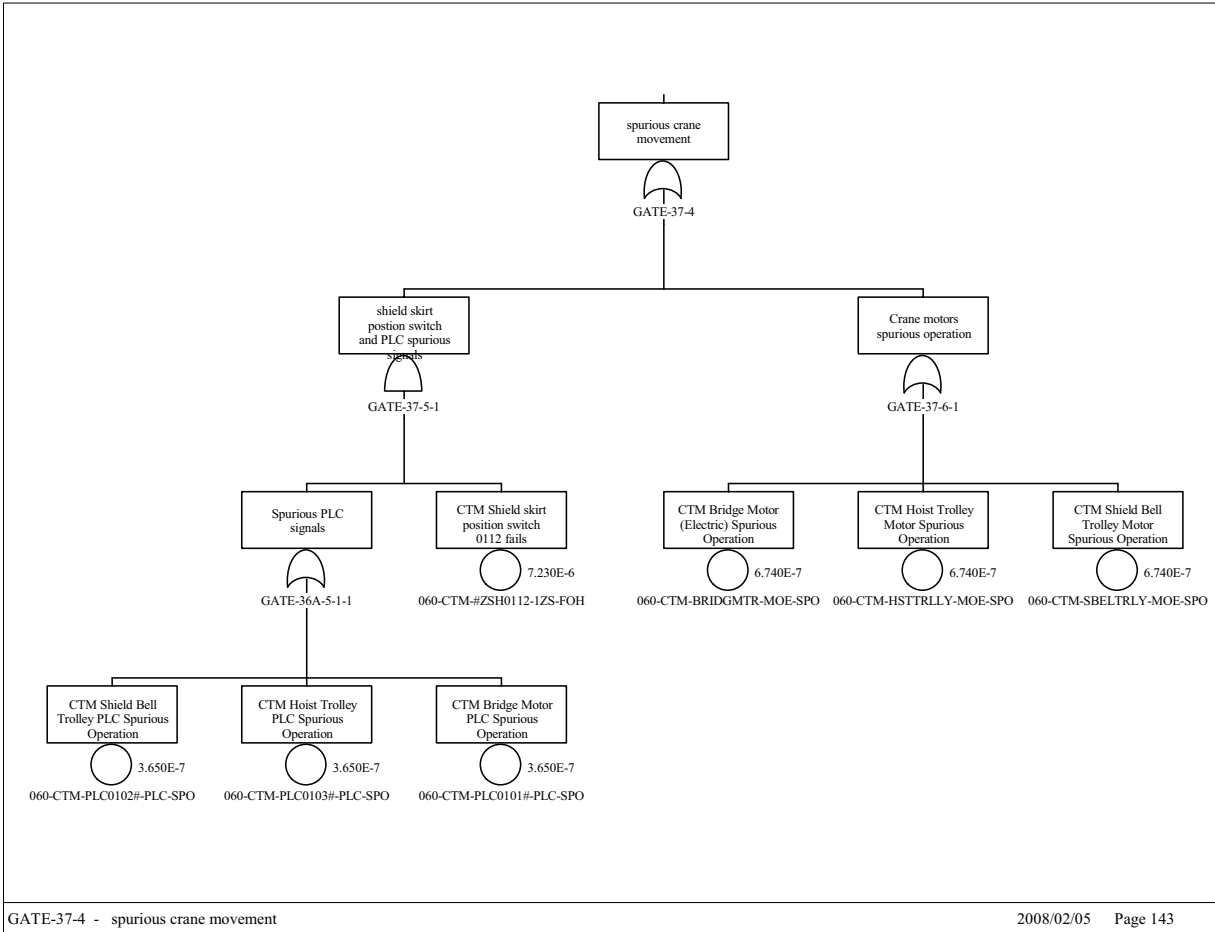

Source: Original

Figure B4.4-13. CTM Drop Fault Tree Sheet 11

B4.4.2 Canister Drops from Above the Canister Design Limit Drop Height

B4.4.2.1 Description

Transfer operations using the CTM entail the possibility of inadvertent drops of the canisters. These drops have been divided into two classes: drops from heights below the design basis drop height of the canister and drops from heights above the design basis drop height of the canister. This fault tree for canister drops addresses the second of these two scenarios.

B4.4.2.2 Success Criteria

Success criteria for the CTM is the prevention of a canister drop from above the canister design limit drop height from any cause during the lift, lateral movement, and lower portions of the canister transfer.

B4.4.2.3 Design Features and Requirements

Requirements

Hard-wired interlocks are used to prevent inadvertent actions during CTM transfer operations. These include the following:

- An optical sensor at the bottom of the shield bell that, once it is cleared, stops the hoist and erases the lift command (can only lower hoist). This interlock is used only when lifting a canister.
- Above the ASD stop point is an upper limit switch which, when reached, stops the hoist from lifting. This first limit switch (first hoist upper limit) effectively erases the lift command (the hoist still has power) and the operator can only lower the hoist. Roughly a foot above that limit switch is another limit switch (final hoist upper limit) that, when reached, cuts off the power to the CTM hoist.
- An interlock between the shield skirt and port gate which requires the shield skirt to be lowered in order for the port gate to open. There is a maintenance bypass for this interlock.
- An interlock between the CTM bridge/trolley travel and shield skirt position. Neither the CTM bridge nor the trolley can travel while the skirt is lowered.
- An interlock between the slide gate and shield skirt – the shield skirt cannot be raised unless the slide gate is closed. This interlock can be bypassed, to allow the CTM to move with the slide gate open during lid removal.
- Interlocks preventing improper hoist movement. The hoist cannot move unless the shield skirt is lowered. This interlock is based on hoist movement, not position, so movement with the hoist too low is not precluded.
- Anti-collision interlocks (position driven) for the two CTMs.
- The load cells which cut off power to the hoist when the crane capacity is exceeded.
- An interlock between the grapple position (fully engaged or fully disengaged) and hoist movement. The grapple automatically engages/disengages with a given object. The grapple must be positively engaged for the grapple engagement indicator to give a positive indication.

Design Features

Bridge and trolley motors are sized to limit lateral travel to less than 20 feet per minute, sufficient to ensure that in the event of an impact, impact forces are below the design limits of the canister.

The shield bell slide gate motors are sized so that they are incapable of exerting sufficient force to damage any canister given an inadvertent closure of the gate when a canister is suspended in the gate closure path.

The floor port gate motors are sized so that they are incapable of exerting sufficient force to damage any canister given an inadvertent closure of the gate when a canister is suspended in the gate closure path.

Hard-wired interlocks used to prevent inadvertent actions during CTM transfer operations are ITS; PLCs are not ITS equipment.

The end stops for both the bridge and trolley end of travel are capable of stopping the bridge/trolley at their maximum speed and preclude impact with any permanent structure.

The interlock between the grapple position and the operation of the hoist motor cannot be bypassed during CTM canister transfer operations.

B4.4.2.4 Fault Tree Model

The top event in this fault tree is “CTM High Drops from Two Blocking Events.” This is defined as a drop of a canister from a height above the design limit height for the canister during transfer operations. (The two block designation refers to the condition where the object being lifted is raised to the point where the upper and lower blocks of the crane come into contact. Attempts to continue to lift the load, at this point, place additional strains on the CTM components.) For this event to occur, the canister must be lifted above the normal heights associated with a lift, and the features designed to limit the drop height must fail. During normal operation, once the canister clears the optical sensor in the shield bell, the shield bell slide gate is closed. Provided the gate is closed at this time, the potential drop height for the canister never exceeds the canister design limit drop height. Faults considered in the evaluation of this top event include: component and human events (considered in conjunction with the interlocks intended to prevent the erroneous human action) that contribute to raising the canister too high. The model does not credit CTM features that could mitigate the consequences of a two-block event. All two-block events are modeled to result in a drop.

B4.4.2.5 Basic Event Data

Table B4.4-4 contains a list of basic events used in the “Canister Drop from Above the Canister Design Limit Drop Height” fault tree. Included are the HFEs and the common-cause failure events identified in the following two sections. There are no maintenance failures associated with the CTM. The CTMs are not in service while they are undergoing maintenance. Sensor failures that could be associated with the failure to restore from maintenance are not expected to contribute significantly to the overall sensor availability.

Table B4.4-4. Basic Event Probability for the Canister Drop from Above the Canister Design Limit Drop Height Fault Tree

Name	Description	Calc. Type ^a	Calc. Prob.	Fail. Prob.	Lambda	Miss. Time ^a
060-CTM--121122-ZS--CCF	CCF CTM upper limit position switches	1	1.380E-005	1.100E-005	0.000E+000	0.000E+000
060-CTM--330121--ZS--FOD	CTM hoist first upper limit switch 0121 failure on demand	1	2.930E-004	2.930E-004	0.000E+000	0.000E+000
060-CTM--330122--ZS--FOD	CTM final hoist upper limit switch 0122 failure on demand	1	2.930E-004	2.930E-004	0.000E+000	0.000E+000
060-CTM-ASD0122#-CTL-FOD	CTM hoist ASD controller fails	1	2.030E-003	2.030E-003	0.000E+000	8.000E+000
060-CTM-HOISTMTR-MOE-FSO	CTM hoist motor (electric) fails to shut off	3	1.350E-008	0.000E+000	1.350E-008	1.000E+000
060-CTM-OPSENSOR-SRX-FOH	Canister above CTM slide gate optical sensor fails	3	4.700E-006	0.000E+000	4.700E-006	1.000E+000
060-OPCTMDRINT01-HFI-COD	Operator raises load too high - two block	1	1.000E+000	1.000E+000	0.000E+000	0.000E+000

NOTE: ^a For Calc. Type 3 with a mission time of 0, SAPHIRE performs the quantification using the system mission time.

ASD = adjustable speed controller; CCF = common cause failure; CTM = canister transfer machine.

Source: Original

The canister drop probability modeled by the fault tree is evaluated over a mission time of one hour. This mission time encompasses vertical lifting, lateral movement, and vertical lowering of the canister by the CTM. A longer mission time is also considered for specific components. For example, the fault tree accounts for the failure of standby components whose potential malfunction would remain hidden until they are put into operation. They are consequently evaluated over the interval of time between their actuation, considered to be the duration of a shift (i.e., eight hours activities).

B4.4.2.5.1 Human Failure Events

One basic event is associated with human error: 060-OPCTMDRINT01-HFI-COD (Operator raises load too high - two block). This event models the combination of operator actions and interlock failures required to allow the operator to raise a load above design limits, an action that can lead to a two blocking failure.

B4.4.2.5.2 Common-Cause Failures

One common-cause event was considered in the evaluation of this fault tree. There are two upper limit switches intended to prevent raising a load too high. The common-cause failure of these switches was considered. An alpha factor of 0.047 was used to determine the CCF value using two of two as the failure criteria (Table C3-1, CCCG = 2).

B4.4.2.6 Uncertainty and Cut Set Generation Results

Figure B4.4-14 contains the uncertainty results obtained from running the fault tree for “Canister Drop from Above the Canister Design Limit Drop Height” with a cutoff probability of 1E-15. Figure B4.4-15 provides the cutset generation results for the “Canister Drop from Above the Canister Design Limit Drop Height” fault tree.



Source: Original

Figure B4.4-14. Uncertainty Results of the “Canister Drop from Above the Canister Design Limit Drop Height” Fault Tree

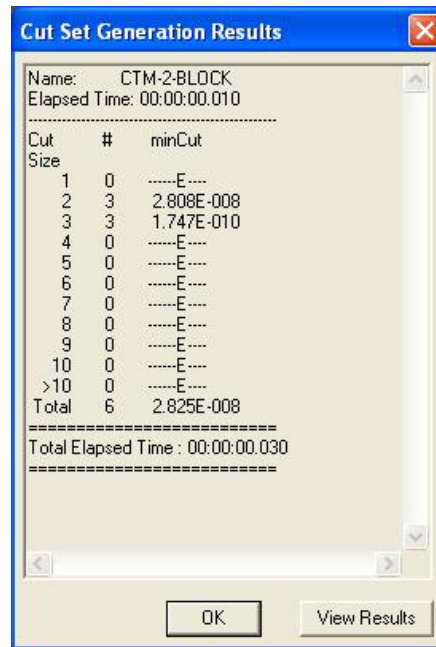

Source: Original

Figure B4.4-15. Cut Set Generation Results for the “Canister Drop from Above the Canister Design Limit Drop Height” Fault Tree

B4.4.2.7 Cut Sets

Table B4.4-5 contains the top six cutsets for the “Canister Drop from Above the Canister Design Limit Drop Height” fault tree.

Table B4.4-5. Dominant Cut Sets for the CTM Canister Drop from Above the Canister Design Height Limit

% Total	% Cut Set	Prob./ Frequency	Basic Event	Description	Event Prob.
99.15	99.15	2.801E-008	060-CTM--121122-ZS--CCF	CCF CTM upper limit position switches	1.380E-005
			060-CTM-ASD0122#-CTL-FOD	CTM Hoist ASD Controller fails	2.030E-003
99.77	0.62	1.743E-010	060-CTM--330121--ZS--FOD	CTM Hoist First Upper Limit Switch 0121 Failure on Demand	2.930E-004
			060-CTM--330122--ZS--FOD	CTM Final Hoist Upper Limit Switch 0122 Failure on Demand	2.930E-004
			060-CTM-ASD0122#-CTL-FOD	CTM Hoist ASD Controller fails	2.030E-003
100.00	0.23	6.486E-011	060-CTM--121122-ZS--CCF	CCF CTM upper limit position switches	1.380E-005
			060-CTM-OPSENSOR-SRX-FOH	Canister above CTM slide gate optical sensor fails	4.700E-006
100.00	0.00	4.035E-013	060-CTM--330121--ZS--FOD	CTM Hoist First Upper Limit Switch 0121 Failure on Demand	2.930E-004
			060-CTM--330122--ZS--FOD	CTM Final Hoist Upper Limit Switch 0122 Failure on Demand	2.930E-004
			060-CTM-OPSENSOR-SRX-FOH	Canister above CTM slide gate optical sensor fails	4.700E-006
100.00	0.00	1.863E-013	060-CTM--121122-ZS--CCF	CCF CTM upper limit position switches	1.380E-005
			060-CTM-HOISTMTR-MOE-FSO	CTM Hoist Motor (Electric) Fails to Shut Off	1.350E-008
100.00	0.00	1.159E-015	060-CTM--330121--ZS--FOD	CTM Hoist First Upper Limit Switch 0121 Failure on Demand	2.930E-004
			060-CTM--330122--ZS--FOD	CTM Final Hoist Upper Limit Switch 0122 Failure on Demand	2.930E-004
			060-CTM-HOISTMTR-MOE-FSO	CTM Hoist Motor (Electric) Fails to Shut Off	1.350E-008

NOTE: ASD = adjustable speed drive; CCF = common-cause failure; CTM = canister transfer machine.

Source: Original

B4.4.2.8 Fault Trees

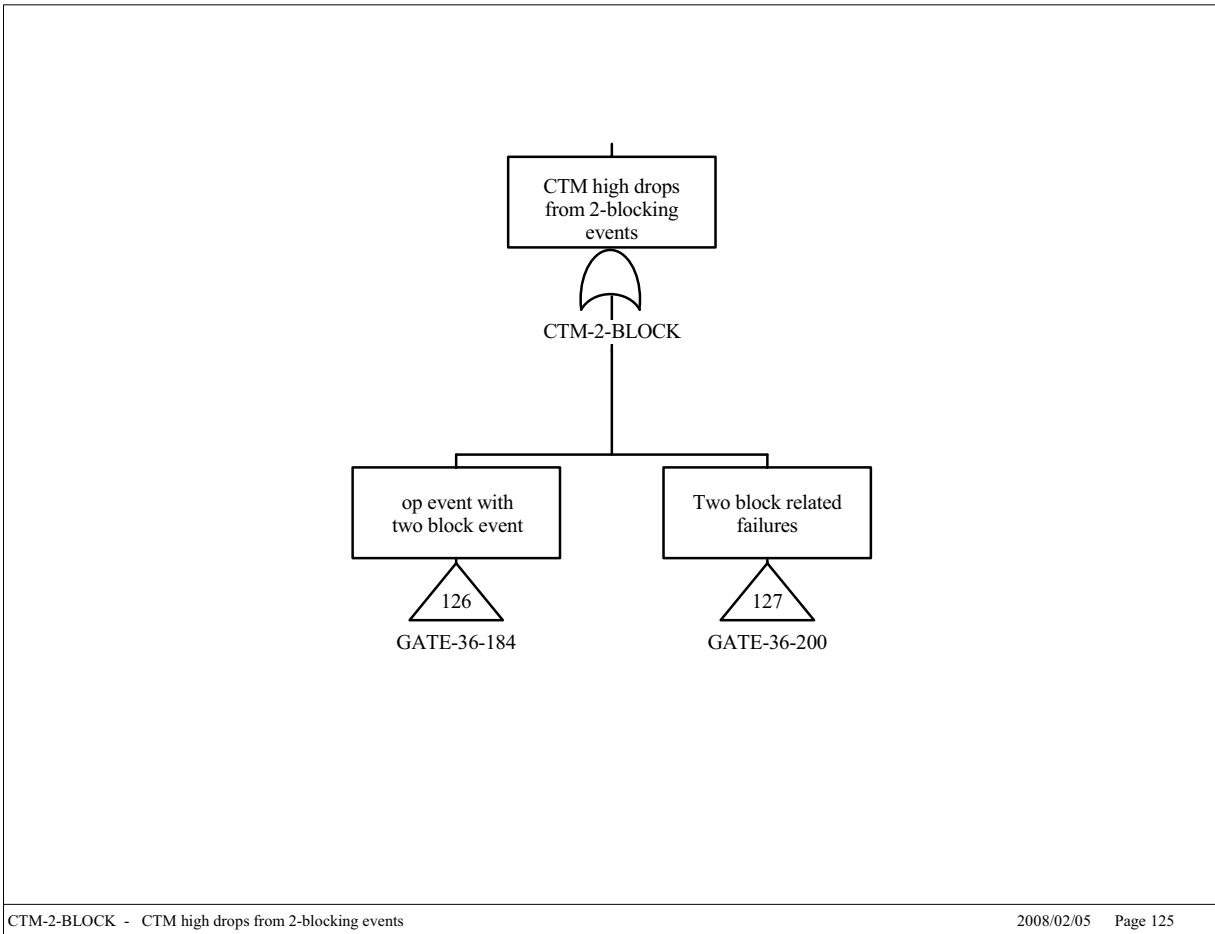

Source: Original

Figure B4.4-16. CTM High Drops from Two Blocking Event Sheet 1

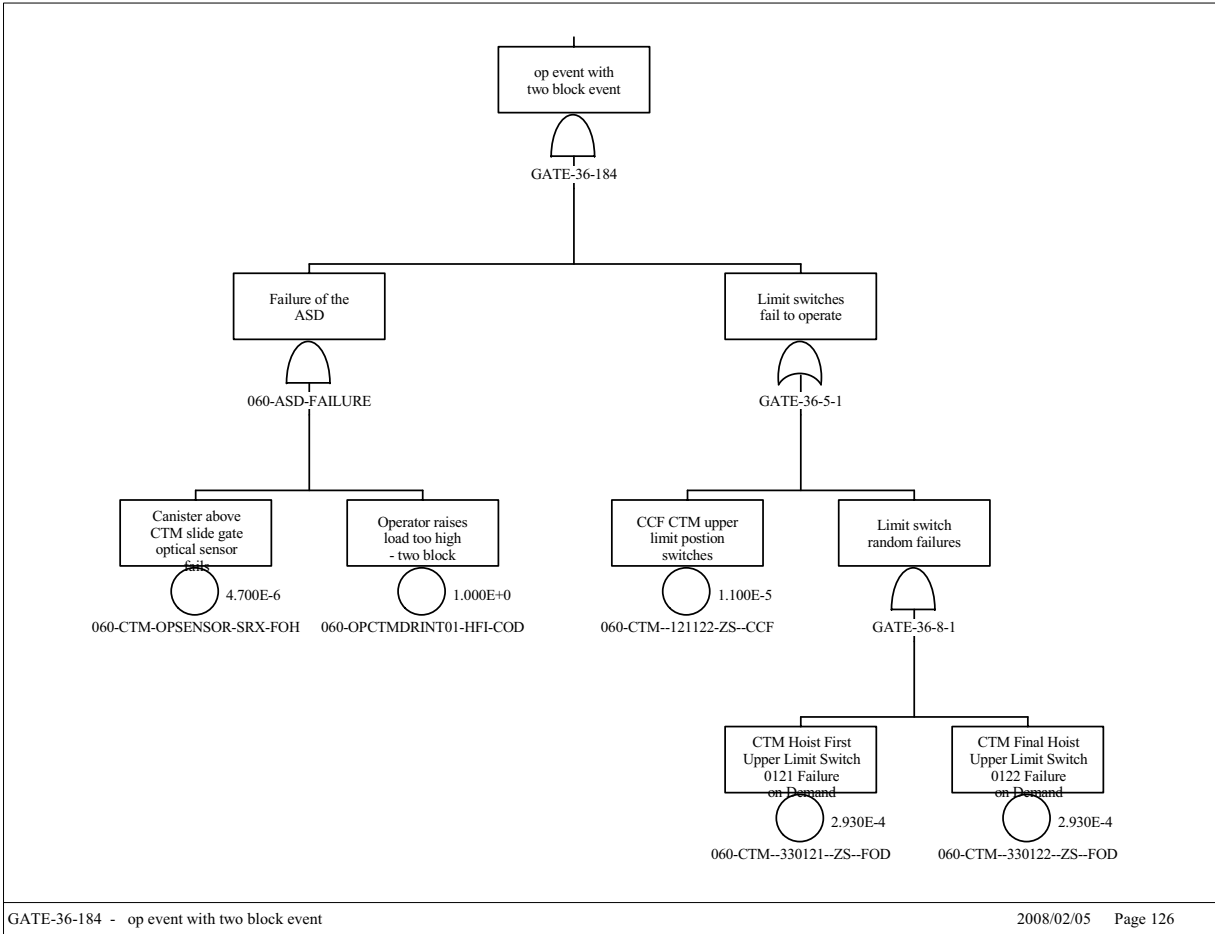

Source: Original

Figure B4.4-17. CTM High Drops from Two Blocking Event Sheet 2

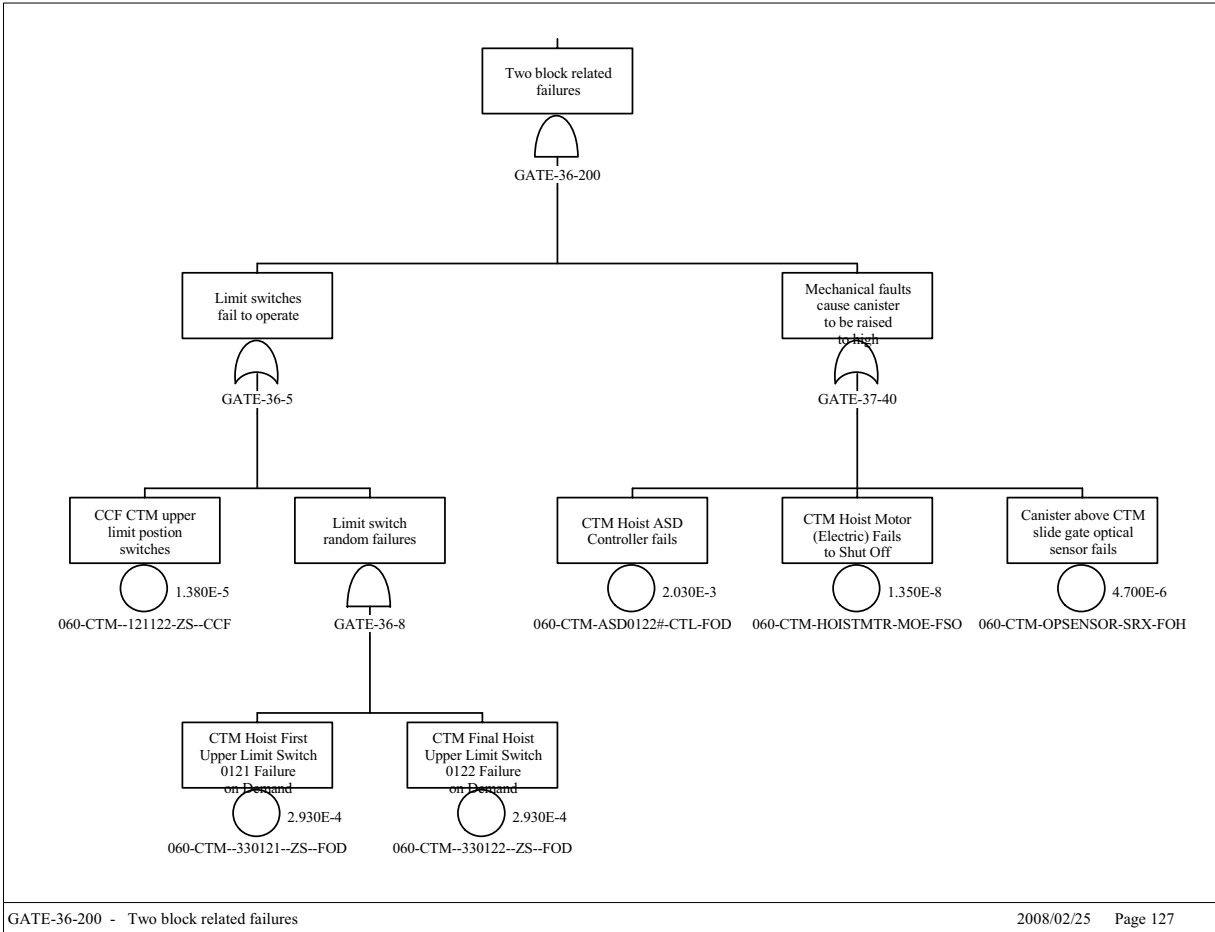

Source: Original

Figure B4.4-18. CTM High Drops from Two Blocking Event Sheet 3

B4.4.3 Drop of Object onto Canister

B4.4.3.1 Description

Transfer operations using the CTM entail the possibility of inadvertent drops of objects onto canisters. Cask lids, handling equipment, and auxiliary grapples are handled during the canister transfer process. At times these objects are over the canister and could be dropped onto the canister.

B4.4.3.2 Success Criteria

The success criterion for the CTM is the prevention of a drop of any object onto the canister from any cause during the lift, lateral movement, and lower portions of the canister transfer.

B4.4.3.3 Design Requirements and Features

Requirements

Hard-wired interlocks are used to prevent inadvertent actions during CTM transfer operations. These include the following:

- An optical sensor at the bottom of the shield bell that, once it is cleared, stops the hoist and erases the lift command (can only lower hoist). This interlock is used only when lifting a canister.
- Above the ASD stop point is an upper limit switch which, when reached, stops the hoist from lifting. This first limit switch (first hoist upper limit) effectively erases the lift command (the hoist still has power) and the operator can only lower the hoist. Roughly a foot above that limit switch is another limit switch (final hoist upper limit) that, when reached, cuts off the power to the CTM hoist.
- An interlock between the shield skirt and port gate which requires the shield skirt to be lowered in order for the port gate to open. There is a maintenance bypass for this interlock.
- An interlock between the CTM bridge/trolley travel and shield skirt position. Neither the CTM bridge or the trolley can travel while the skirt is lowered.
- An interlock between the slide gate and shield skirt – the shield skirt cannot be raised unless the slide gate is closed. This interlock can be bypassed, to allow the CTM to move with the slide gate open during lid removal.
- Interlocks preventing improper hoist movement. The hoist cannot move unless the shield skirt is lowered. This interlock is based on hoist movement, not position, so movement with the hoist too low is not precluded.
- Anti-collision interlocks (position driven) for the two CTMs.
- The load cells cut off power to the hoist when the crane capacity is exceeded.
- An interlock between the grapple position (fully engaged or fully disengaged) and hoist movement. The grapple automatically engages/disengages with a given object. The grapple must be positively engaged for the grapple engagement indicator to give a positive indication.

Design Features

Bridge and trolley motors are sized to limit lateral travel to less than 20 feet per minute, sufficient to ensure that in the event of an impact, impact forces are below the design limits of the canister.

The shield bell slide gate motors are sized so that they are incapable of exerting sufficient force to damage any canister given an inadvertent closure of the gate when a canister is suspended in the gate closure path.

The floor port gate motors are sized so that they are incapable of exerting sufficient force to damage any canister given an inadvertent closure of the gate when a canister is suspended in the gate closure path.

Hard-wired interlocks used to prevent inadvertent actions during CTM transfer operations are ITS; PLCs are not ITS equipment.

The end stops for both the bridge and trolley end of travel end stops are capable of stopping the bridge/trolley at their maximum speed and preclude impact with any permanent structure.

The interlock between the grapple position and the operation of the hoist motor cannot be bypassed during CTM canister transfer operations.

B4.4.3.4 Fault Tree Model

The top event in this fault tree is “Drop of Object onto Canister.” This is defined as a drop of an object onto a canister during transfer operations. Faults considered in the evaluation of this top event include: human events that contribute to a drop (considered in conjunction with the interlocks intended to prevent the erroneous human action) and mechanical (structural) failures of the CTM components. The interlocks and safety features (position controls, load cells, and drum and holding brakes) intended to either prevent CTM failure or given failure of the CTM to prevent a load drop are included in the model.

Structural failures of components including the hoist cables, sheaves, drum, and grapples can result in canister drops. Operator events are addressed for actions including improper grapple connections, misalignments of the hoist and the canister, improper hoist activities and improper lateral movement of the CTM. Protection from these actions are provided by hard-wired interlocks keyed to the position of the CTM (both hoist position and CTM lateral position), slide and port gate doors, and the shield bell skirt. Also considered in the analysis is a canister drop initiated by improper operation of the shield bell slide gates and the port slide gates. While the gate motors are sized to prevent damage to the canister in the event of an inadvertent closure of the gates, the possibility that the gates would close above the canister during a lift blocking the lift and causing a canister drop was considered.

B4.4.3.5 Basic Event Data

Table B4.4-6 contains a list of basic events used in the CTM Drop of Object onto Canister fault tree. Included are the human failure events and the common-cause failure events identified in the previous two sections. There are no maintenance failures associated with the CTM. The CTMs are not in service while undergoing maintenance. Sensor failures that could be associated with the failure to restore from maintenance are not expected to contribute significantly to the overall sensor availability.

Table B4.4-6. Basic Event Probability for the Drop of Object onto Canister Fault Tree

Name	Description	Calc Type	Calculation Probability	Failure Probability	Lambda	Mission time
060-CTM-#ZSH0112-1ZS-FOH	CTM shield skirt position switch 0112 fails	3	7.230E-06	0.000E+00	7.230E-06	1.000E+00
060-CTM--121122-ZS--CCF	CCF CTM upper limit position switches	1	1.100E-05	1.100E-05	0.000E+00	0.000E+00
060-CTM--330121--ZS--FOD	CTM hoist first upper limit switch 0121 failure on demand	1	1.080E-03	2.930E-04	0.000E+00	0.000E+00
060-CTM--330122--ZS--FOD	CTM final hoist upper limit switch 0122 failure on demand	1	1.080E-03	2.930E-04	0.000E+00	0.000E+00
060-CTM--CBL0001-WNE-BRK	CTM hoist wire rope breaks	1	2.000E-06	2.000E-06	0.000E+00	0.000E+00
060-CTM--CBL0002-WNE-BRK	CTM hoist wire rope breaks	1	2.000E-06	2.000E-06	0.000E+00	1.000E+00
060-CTM--CBL0102-WNE-CCF	CCF CTM hoist wire ropes	1	9.400E-08	9.400E-08	0.000E+00	0.000E+00
060-CTM--DRTRN-CT--FOD	CTM drive train protection and fail det. Controller failure	1	4.000E-06	4.000E-06	0.000E+00	0.000E+00
060-CTM--DRUM001-DM--FOD	CTM drum failure on demand	1	4.000E-08	4.000E-08	0.000E+00	0.000E+00
060-CTM--DRUMBRK-BRP-FOD	CTM drum brake (pneumatic) failure on demand	1	5.020E-05	5.020E-05	0.000E+00	0.000E+00
060-CTM--DRUMBRK-BRP-FOH	CTM drum brake (pneumatic) failure to hold	3	2.011E-04	0.000E+00	8.380E-06	2.400E+01
060-CTM--EQL-SHV-BLK-FOD	CTM sheaves failure on demand	1	1.150E-06	1.150E-06	0.000E+00	0.000E+00
060-CTM--GRAPPLE-GPL-FOD	CTM grapple failure on demand	1	1.150E-06	1.150E-06	0.000E+00	0.000E+00
060-CTM--HOISTMT-MOE-FTR	CTM hoist motor (electric) fails to run	3	6.500E-06	0.000E+00	6.500E-06	1.000E+00
060-CTM--HOLDBRK-BRK-FOD	Brake failure on demand	1	1.460E-06	1.460E-06	0.000E+00	0.000E+00
060-CTM--HOLDBRK-BRK-FOH	CTM holding brake (electric) failure to hold	3	3.520E-05	0.000E+00	4.400E-06	8.000E+00
060-CTM--IMEC125-IEL-FOD	CTM hoist motor control interlock failure on demand	1	2.740E-05	2.750E-05	0.000E+00	0.000E+00
060-CTM--LOWERBL-BLK-FOD	CTM lower sheaves failure on demand	1	1.150E-06	1.150E-06	0.000E+00	0.000E+00
060-CTM--OVERSP--ZS--FOD	CTM hoist motor speed limit switch failure on demand	1	1.080E-03	2.930E-04	0.000E+00	0.000E+00
060-CTM--PORTGT1-MOE-SPO	Spurious port gate1 motor operation	3	6.740E-07	0.000E+00	6.740E-07	1.000E+00
060-CTM--PORTGT1-PLC-SPO	Port gage PLC spurious operation	3	3.650E-07	0.000E+00	3.650E-07	1.000E+00
060-CTM--PORTGT2-MOE-SPO	Port gate motor (electric) spurious operation	3	6.740E-07	0.000E+00	6.740E-07	1.000E+00
060-CTM--PORTGT2-PLC-SPO	Port gage 2 PLC spurious operation	3	3.650E-07	0.000E+00	3.650E-07	1.000E+00
060-CTM--SLIDEGT-MOE-SPO	CTM slide gate motor (electric) spurious operation	3	6.740E-07	0.000E+00	6.740E-07	1.000E+00
060-CTM--SLIDEGT-PLC-SPO	CTM slide gate PLC spurious operation	3	3.650E-07	0.000E+00	3.650E-07	1.000E+00
060-CTM--SLIDGT2-IEL-FOD	CTM slide gate interlock failure	1	2.740E-05	2.750E-05	0.000E+00	0.000E+00

B4-46

March 2008

Table B4.4-6. Basic Event Probability for the Drop of Object onto Canister Fault Tree (Continued)

Name	Description	Calc Type	Calculation Probability	Failure Probability	Lambda	Mission time
060-CTM--UPPERBL-BLK-FOD	CTM upper sheaves failure	1	1.150E-06	1.150E-06	0.000E+00	0.000E+00
060-CTM--WT0125--SRP-FOD	CTM load cell pressure sensor fails on demand	1	4.000E-03	3.990E-03	0.000E+00	0.000E+00
060-CTM--WTSW125-ZS--FOD	CTM load cell limit switch failure on demand	1	1.080E-03	2.930E-04	0.000E+00	0.000E+00
060-CTM--YS01129-ZS--FOD	CTM drum brake control circuit limit switch 1129 failure	1	1.080E-03	2.930E-04	0.000E+00	0.000E+00
060-CTM--ZSH0111-ZS--SPO	CTM grapple engaged limit switch spurious operation	3	1.280E-06	0.000E+00	1.280E-06	1.000E+00
060-CTM-ASD0122#-CTL-FOD	CTM hoist ASD controller fails	1	2.030E-03	2.030E-03	0.000E+00	8.000E+00
060-CTM-BRIDGMTR-IEL-FOD	CTM shield skirt-bridge motor interlock failure	1	2.740E-05	2.750E-05	0.000E+00	0.000E+00
060-CTM-BRIDGMTR-MOE-SPO	CTM bridge motor (electric) spurious operation	3	6.740E-07	0.000E+00	6.740E-07	1.000E+00
060-CTM-HOISTMTR-MOE-FSO	CTM hoist motor (electric) fails to shut off	3	1.350E-08	0.000E+00	1.350E-08	1.000E+00
060-CTM-HSTTRLLY-IEL-FOD	CTM shield skirt hoist trolley motor interlock failure	1	2.740E-05	2.750E-05	0.000E+00	0.000E+00
060-CTM-HSTTRLLY-MOE-SPO	CTM hoist trolley motor spurious operation	3	6.740E-07	0.000E+00	6.740E-07	1.000E+00
060-CTM-MISSPOOL--DM-MSP	CTM mis-spool event	3	6.860E-07	0.000E+00	6.860E-07	1.000E+00
060-CTM-OPSENSOR-SRX-FOH	Canister above CTM slide gate optical sensor fails	3	4.700E-06	0.000E+00	4.700E-06	1.000E+00
060-CTM-PLC0101#-PLC-SPO	CTM bridge motor PLC spurious operation	3	3.650E-07	0.000E+00	3.650E-07	1.000E+00
060-CTM-PLC0102#-PLC-SPO	CTM shield bell trolley PLC spurious operation	3	3.650E-07	0.000E+00	3.650E-07	1.000E+00
060-CTM-PLC0103#-PLC-SPO	CTM hoist trolley PLC spurious operation	3	3.650E-07	0.000E+00	3.650E-07	1.000E+00
060-CTM-SBELTRLY-IEL-FOD	CTM shield bell trolley interlock failure	1	2.740E-05	2.750E-05	0.000E+00	0.000E+00
060-CTM-SBELTRLY-MOE-SPO	CTM shield bell trolley motor spurious operation	3	6.740E-07	0.000E+00	6.740E-07	0.000E+00
060-CTM-SLIDGT2-SRX-FOD	CTM slide gate position sensor fails on demand	1	1.100E-03	1.100E-03	0.000E+00	0.000E+00
060-CTM-ZSL0111-ZS--SPO	CTM grapple disengaged limit switch spurious operation	3	1.280E-06	0.000E+00	1.280E-06	1.000E+00
060-OPCLCTMGATE1-HFI-NOD	Operator commands doors close	1	1.000E-03	1.000E-03	0.000E+00	0.000E+00
060-OPCTMDRINT01-HFI-COD	Operator raises load too high--two block	1	1.000E+00	1.000E+00	0.000E+00	0.000E+00
060-OPCTMDROP001-HFI-COD	Operator causes drop of object onto canister	1	4.000E-07	4.000E-07	0.000E+00	0.000E+00
060-OPCTMIMPACT1-HFI-COD	Operator moves trolley/crane with canister below floor	1	4.000E-08	4.000E-08	0.000E+00	0.000E+00

NOTE: ASD = adjustable speed drive; CCF= common cause failure; CTM = canister transfer machine; Calc = calculation.

Source: Original

B4-47

March 2008

The object drop probability modeled by the fault tree is evaluated over a mission time of one hour. This mission time encompasses vertical lifting, lateral movement, and vertical lowering of the canister by the CTM. A longer mission time is also considered for specific components. For example, the fault tree accounts for the failure of standby components whose potential malfunction would remain hidden until they are put into operation. They are consequently evaluated over the interval of time between their actuation, considered to be the duration of a shift (i.e., eight hours). In another example, brakes are also analyzed over a mission time of twenty-four hours. This duration is deemed sufficient to encompass the time required to revert to normal transfer operations, after a malfunction that would have caused a safety system of the CTM to cease transfer activities.

B4.4.3.5.1 Human Failure Events

Four basic events are associated with human error (Table B4.4-7). These are for drops initiated by operator actions, drops caused by the operator initiating a two-block event, a failure to restore interlocks allowing movement of the crane when the shield skirt is raised and the slide gates are open and the operator closing the slide or port gates during a lift. The quantification of these events includes operator actions and the failures of interlocks intended to prevent such operator action (Attachment E).

Table B4.4-7. Human Failure Events

Name	Description
060-OPCTMDRINT01-HFI-COD	Operator raises load too high—two block
060-OPCTMDROP001-HFI-COD	Operator causes drop of object onto canister
060-OPCLCTMGATE1-HFI-NOD	Operator commands doors close
060-OPCTMIMPACT1-HFI-COD	Operator moves trolley/crane with canister below floor

Source: Original

B4.4.3.5.2 Common-Cause Failures

Two common-cause events were considered in the evaluation of this fault tree. One is associated with pairs of sensors used to limit CTM movement. The two upper limit sensors on the hoist are used to prevent a two-block event. The second common-cause event considered is the common-cause failure of the hoist cables.

B4.4.3.6 Uncertainty and Cut Set Generation

Figure B4.4-19 contains the uncertainty results obtained from running the fault trees for the “Drop of Object onto Canister” using a cutoff probability of 1E-15. Figure B4.4-20 provides the cutset generation results for the “Drop of Object onto Canister” fault tree.

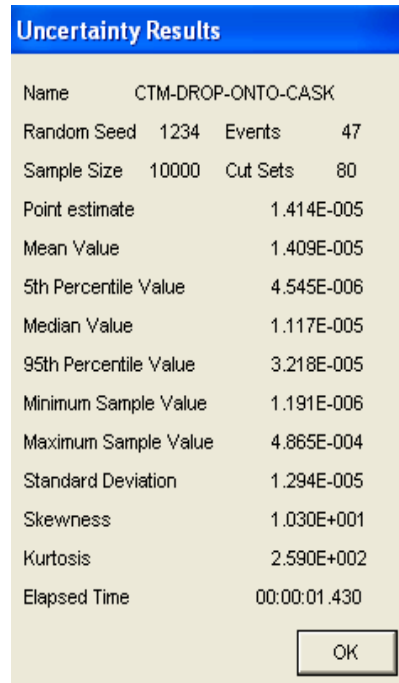

Source: Original

Figure B4.4-19. Uncertainty Results of the Drop of Object onto Canister Fault Tree

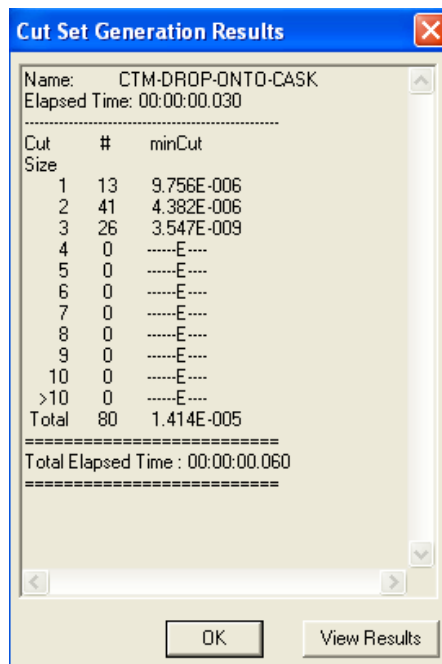

Source: Original

Figure B4.4-20. Cut Set Generation Results for the Drop of Object onto Canister Fault Tree

B4.4.3.7 Cut Sets

Table B4.4-8 contains the top 20 cutsets for the CTM Drop onto Canister fault tree.

Table B4.4-8. Dominant Cut Sets for the CTM Drop onto Canister Fault Tree

% Total	% Cut Set	Probability/Frequency	Basic Event	Description	Event Probability
28.22	28.22	3.990E-06	060-CTM--WT0125--SRP-FOD	CTM Load Cell Pressure Sensor Fails on Demand	3.990E-03
			060-OPCLCTMGATE1-HFI-NOD	Operator commands doors close	1.000E-03
37.27	9.05	1.280E-06	060-CTM--ZSH0111-ZS--SPO	CTM grapple engaged Limit Switch Spurious Operation	1.280E-06
46.32	9.05	1.280E-06	060-CTM-ZSL0111-ZS--SPO	CTM Grapple disengaged Limit Switch Spurious Operation	1.280E-06
54.45	8.13	1.150E-06	060-CTM--LOWERBL-BLK-FOD	CTM Lower Sheaves Failure on Demand	1.150E-06
62.58	8.13	1.150E-06	060-CTM--UPPERBL-BLK-FOD	CTM Upper Sheaves failure	1.150E-06
70.71	8.13	1.150E-06	060-CTM--EQL-SHV-BLK-FOD	CTM Sheaves Failure on Demand	1.150E-06
78.84	8.13	1.150E-06	060-CTM--GRAPPLE-GPL-FOD	CTM Grapple Failure on Demand	1.150E-06
83.61	4.77	6.740E-07	060-CTM-HSTTRLLY-MOE-SPO	CTM hoist trolley motor spurious operation	6.740E-07
88.38	4.77	6.740E-07	060-CTM-SBELTRLY-MOE-SPO	CTM shield bell trolley motor spurious operation	6.740E-07
93.15	4.77	6.740E-07	060-CTM-BRIDGMTR-MOE-SPO	CTM bridge motor (electric) spurious operation	6.740E-07
95.98	2.83	4.000E-07	060-OPCTMDROP001-HFI-COD	Operator causes drop of object onto canister	4.000E-07
98.05	2.07	2.930E-07	060-CTM--WTSW125-ZS--FOD	CTM Load Cell Limit Switch Failure on Demand	2.930E-04
			060-OPCLCTMGATE1-HFI-NOD	Operator commands doors close	1.000E-03
98.71	0.66	9.400E-08	060-CTM--CBL0102-WNE-CCF	CCF CTM Hoist wire ropes	9.400E-08
98.99	0.28	4.000E-08	060-OPCTMIMPACT1-HFI-COD	Operator moves trolley/crane with canister below floor	4.000E-08
99.27	0.28	4.000E-08	060-CTM--DRUM001-DM--FOD	CTM Drum Failure on Demand	4.000E-08
99.52	0.25	3.520E-08	060-CTM--HOLDBRK-BRK-FOH	CTM Holding Brake (Electric) Failure to hold	3.520E-05
			060-OPCLCTMGATE1-HFI-NOD	Operator commands doors close	1.000E-03
99.71	0.19	2.750E-08	060-CTM--IMEC125-IEL-FOD	CTM Hoist Motor Control Interlock Failure on Demand	2.750E-05
			060-OPCLCTMGATE1-HFI-NOD	Operator commands doors close	1.000E-03

Table B4.4-8. Dominant Cut Sets for the CTM Drop onto Canister Fault Tree (Continued)

% Total	% Cut Set	Probability/ Frequency	Basic Event	Description	Event Probability
99.87	0.16	2.233E-08	060-CTM--121122-ZS--CCF	CCF CTM upper limit position switches	1.100E-05
			060-CTM-ASD0122#-CTL-FOD	CTM Hoist ASD Controller fails	2.030E-03
99.89	0.02	2.689E-09	060-CTM--PORTGT2-MOE-SPO	Port gate motor (electric) spurious operation	6.740E-07
			060-CTM--WT0125--SRP-FOD	CTM Load Cell Pressure Sensor Fails on Demand	3.990E-03
99.91	0.02	2.689E-09	060-CTM--SLIDEGT-MOE-SPO	CTM slide gate motor (electric) spurious operation	6.740E-07
			060-CTM--WT0125--SRP-FOD	CTM Load Cell Pressure Sensor Fails on Demand	3.990E-03

NOTE: ASD = adjustable speed drive; CCF = common-cause failure; CTM = canister transfer machine.

Source: Original

B4.4.3.8 Fault Trees

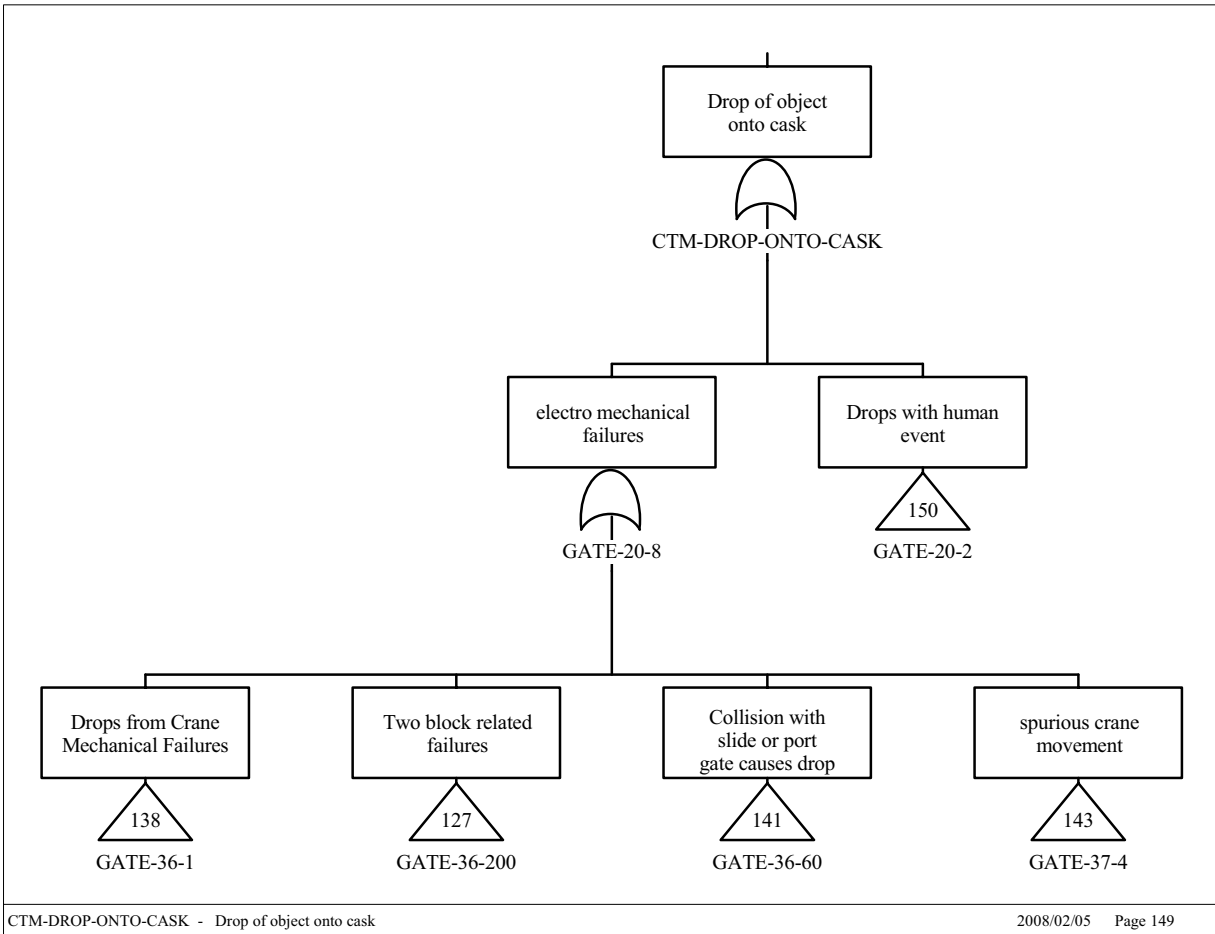

Source: Original

Figure B4.4-21. Drop of Object onto Cask Sheet 1

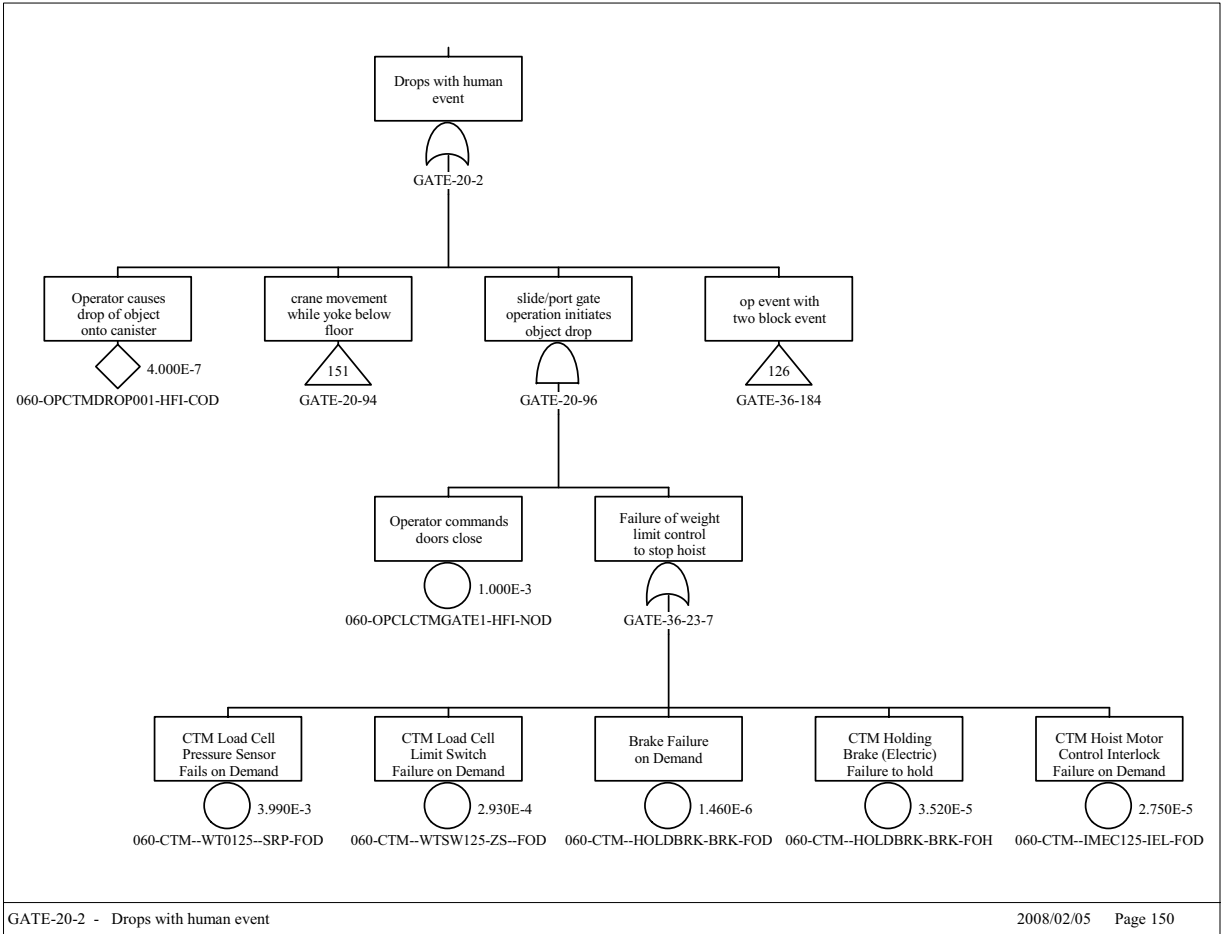

Source: Original

Figure B4.4-22. Drop of Object onto Cask Sheet 2

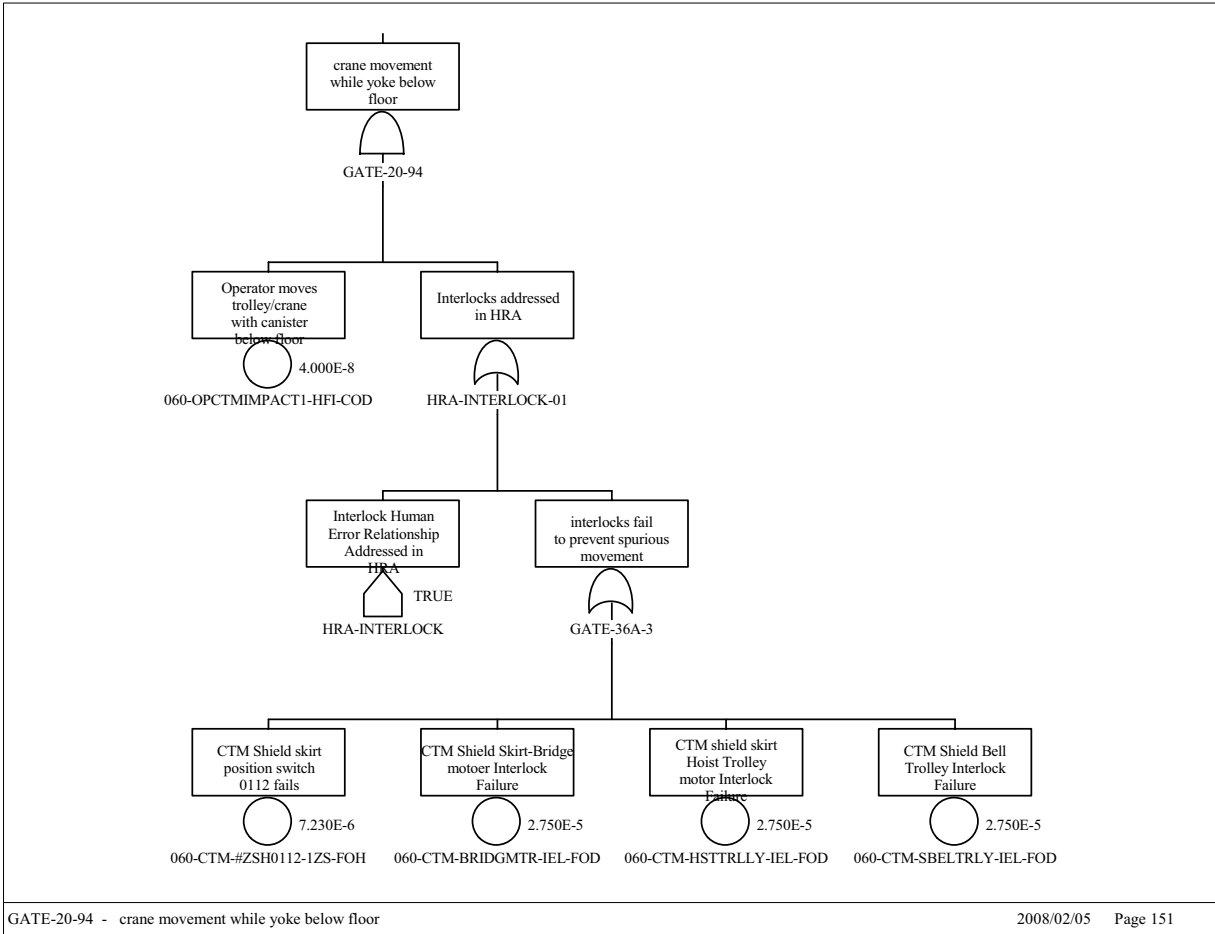

Source: Original

Figure B4.4-23. Drop of Object onto Cask Sheet 3

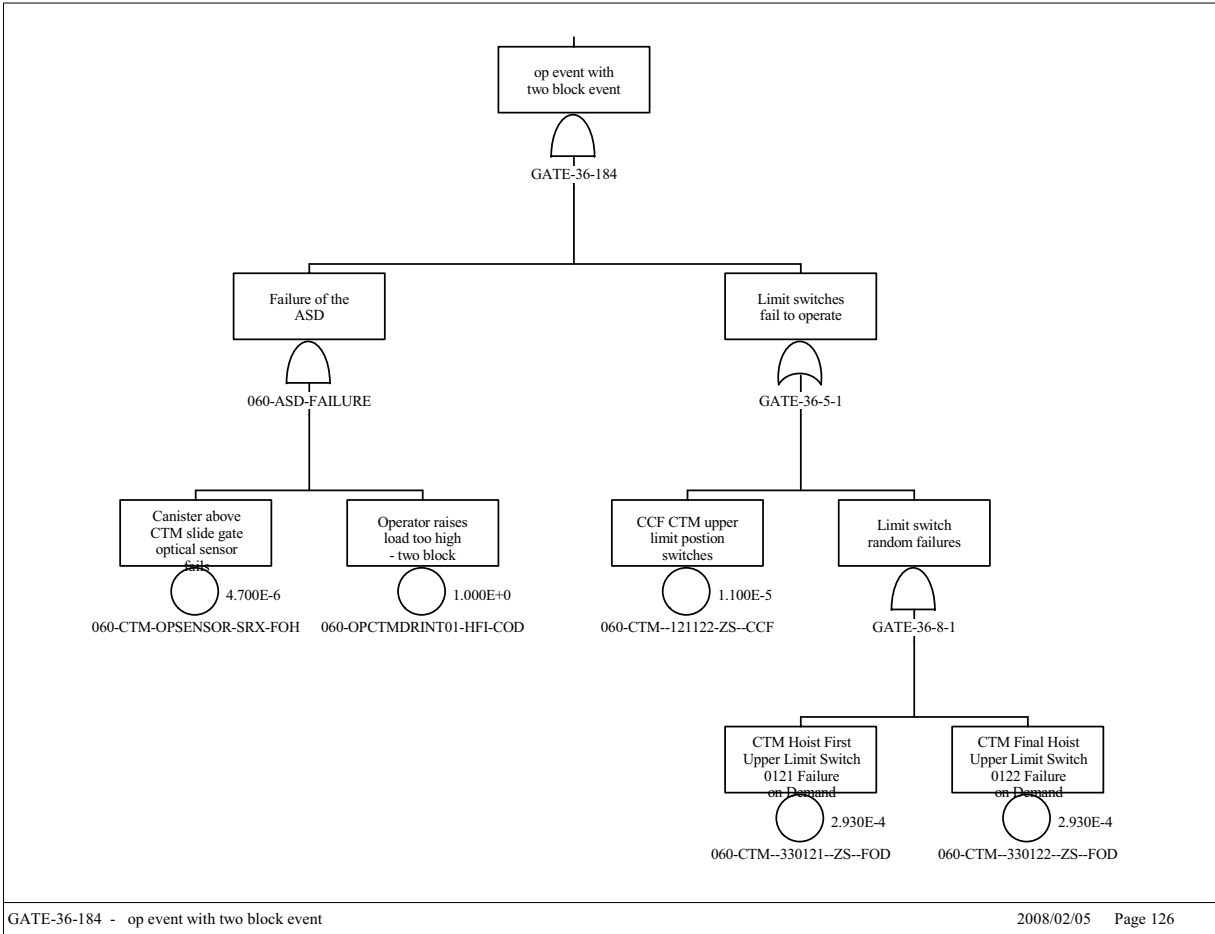

Source: Original

Figure B4.4-24. Drop of Object onto Cask Sheet 4

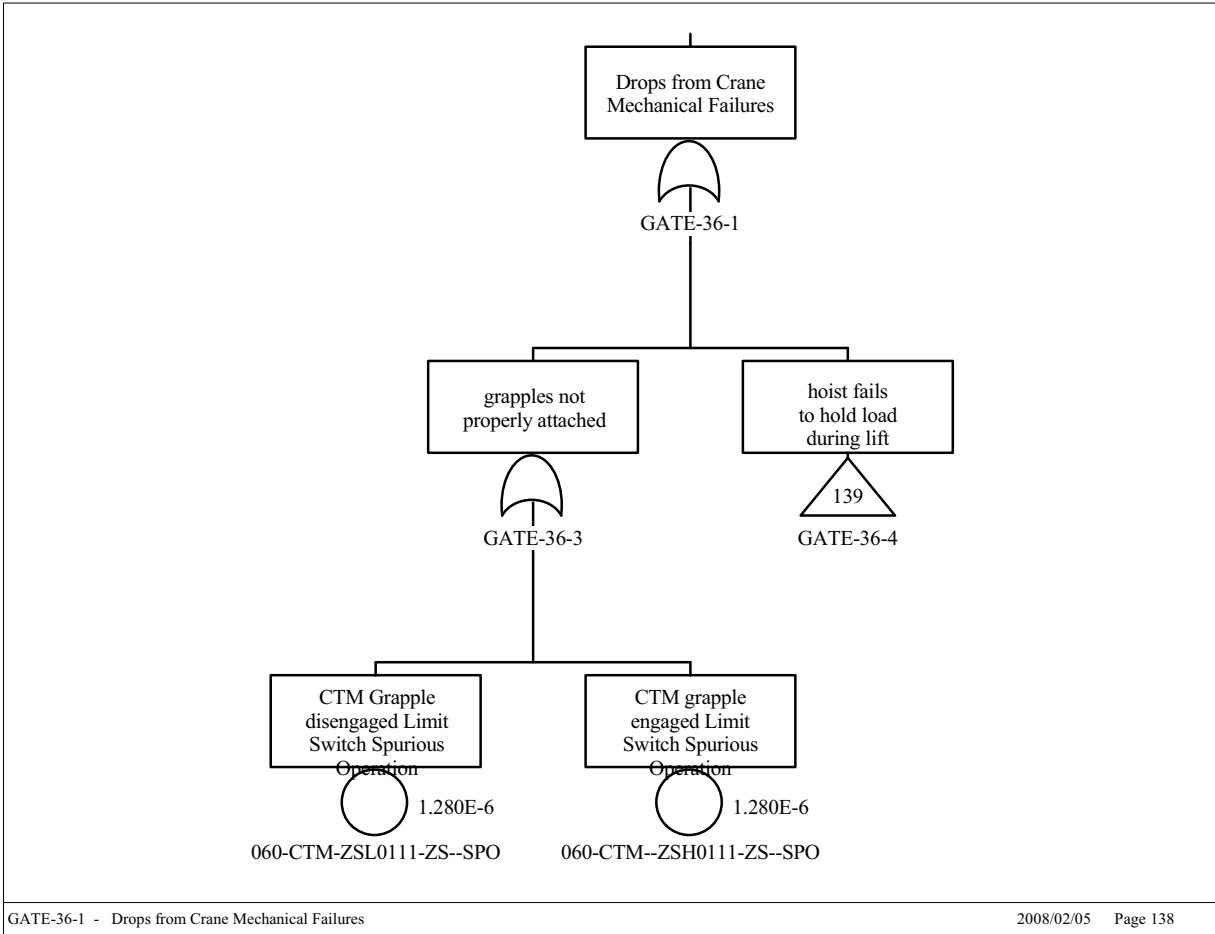

Source: Original

Figure B4.4-25. Drop of Object onto Cask Sheet 5

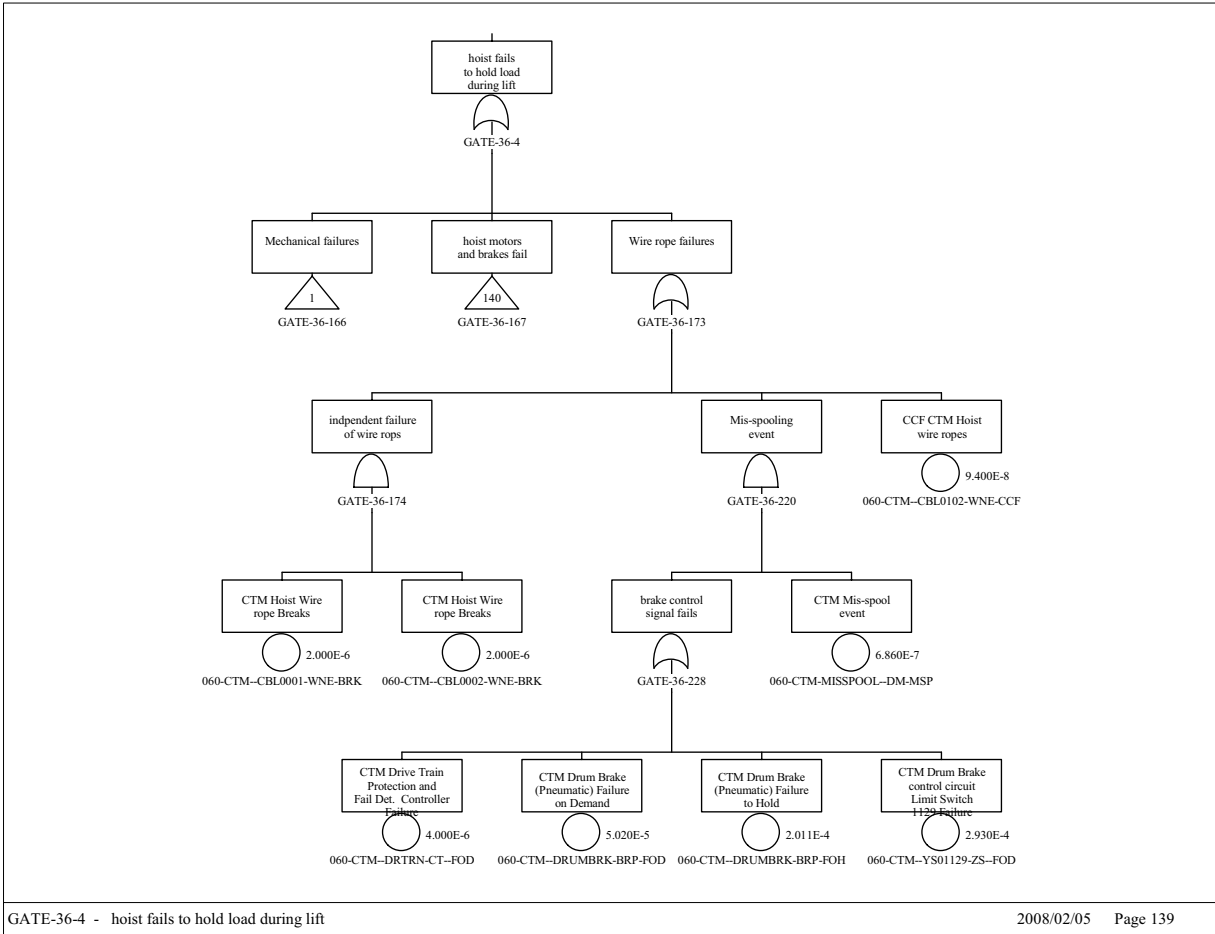

Source: Original

Figure B4.4-26. Drop of Object onto Cask Sheet 6

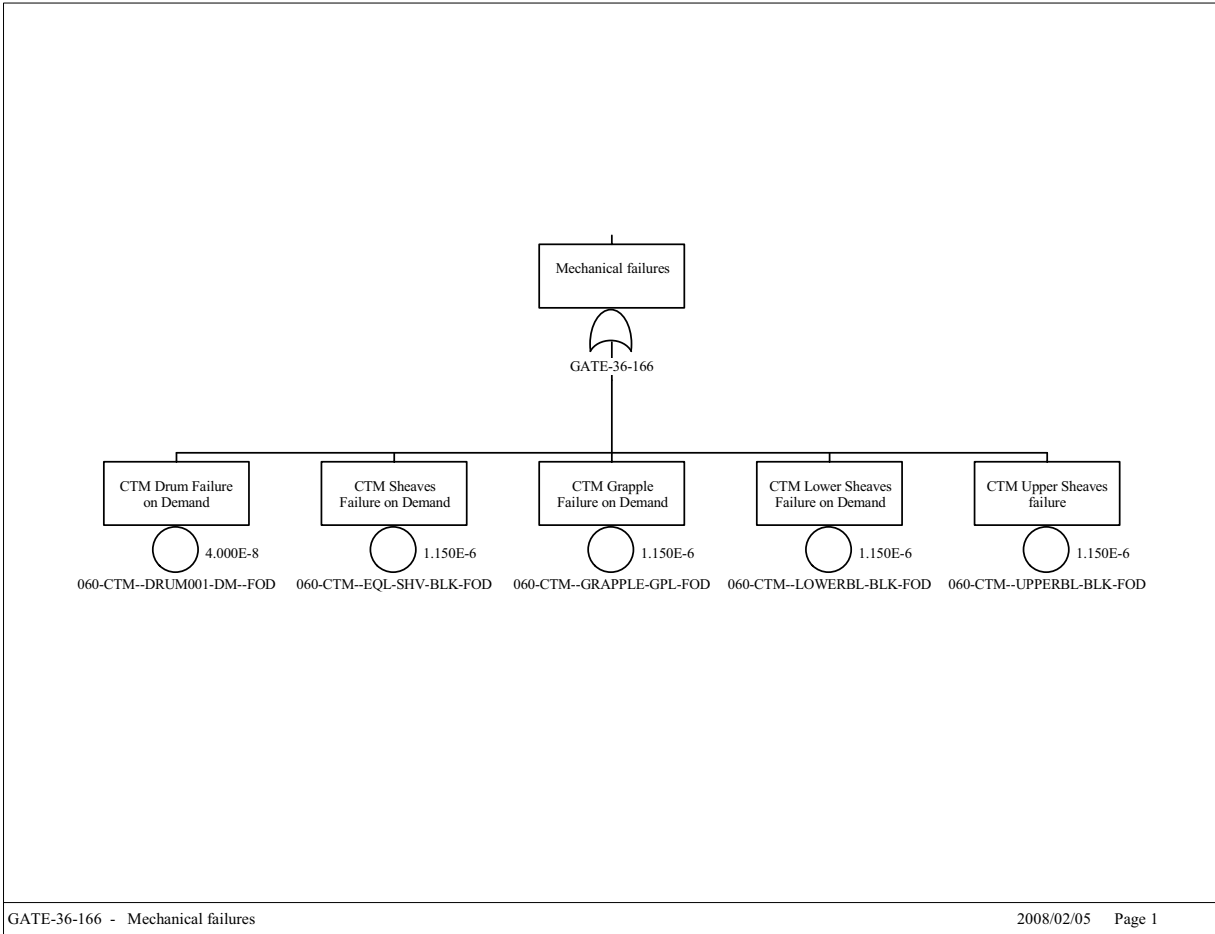

Source: Original

Figure B4.4-27. Drop of Object onto Cask Sheet 7

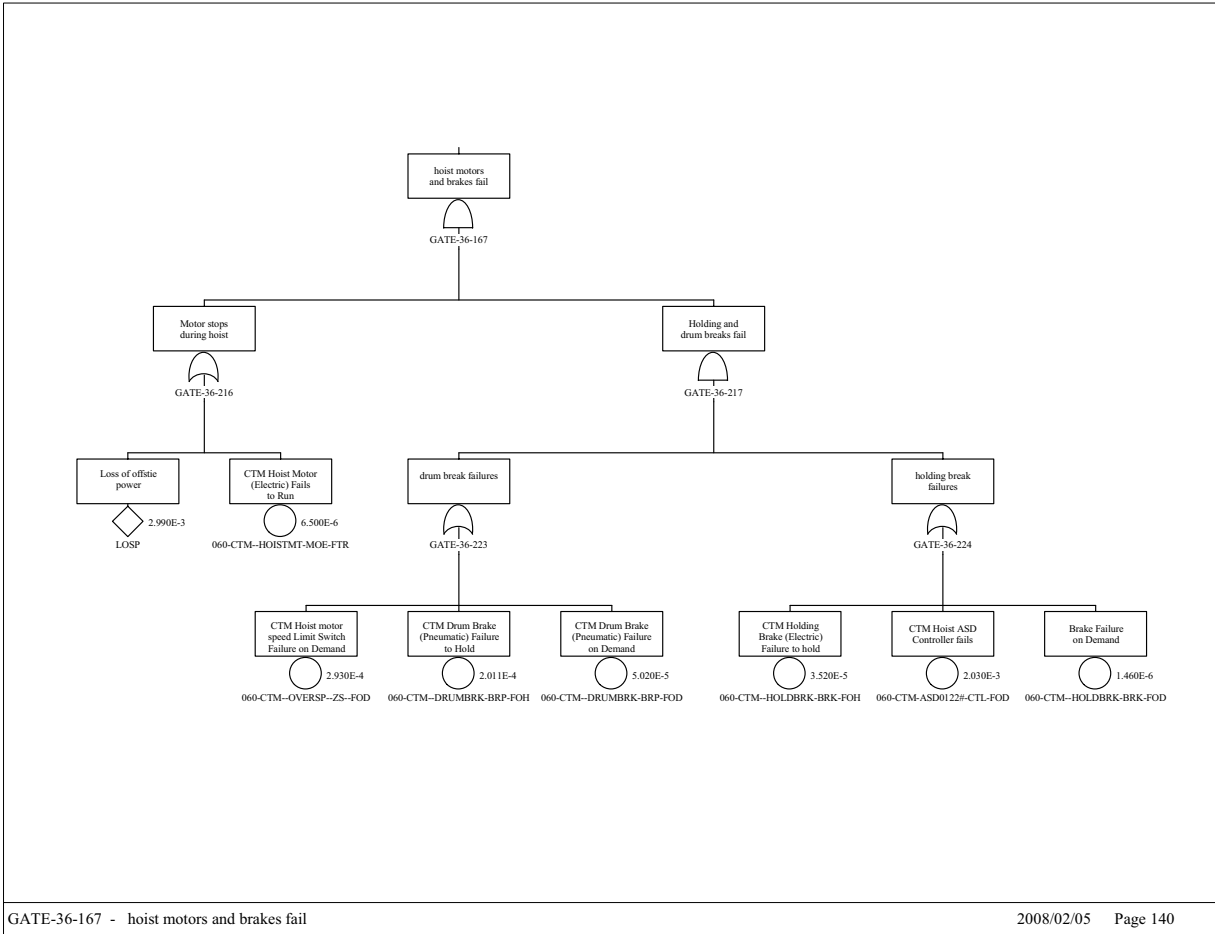

Source: Original

Figure B4.4-28. Drop of Object onto Cask Sheet 8

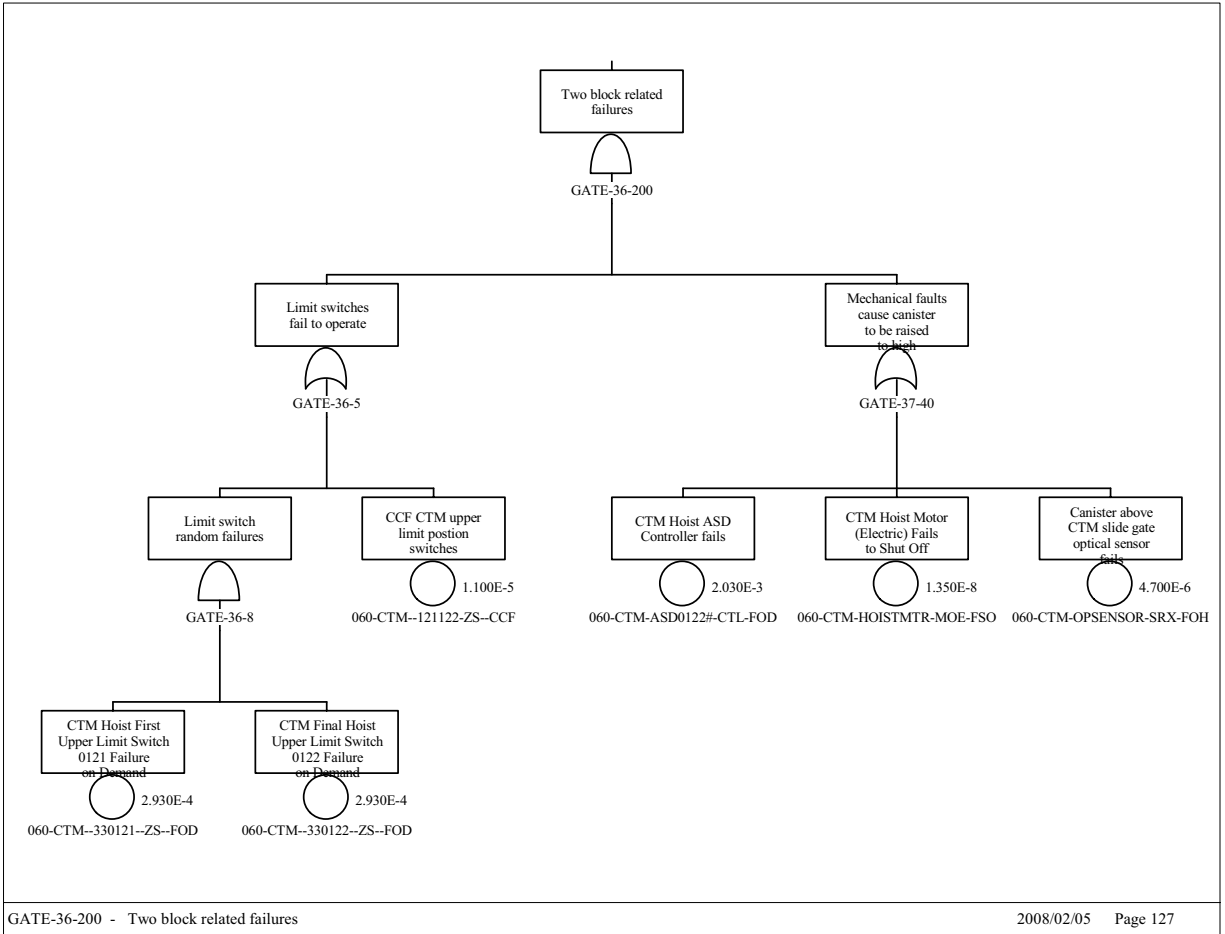

Source: Original

Figure B4.4-29. Drop of Object onto Cask Sheet 9

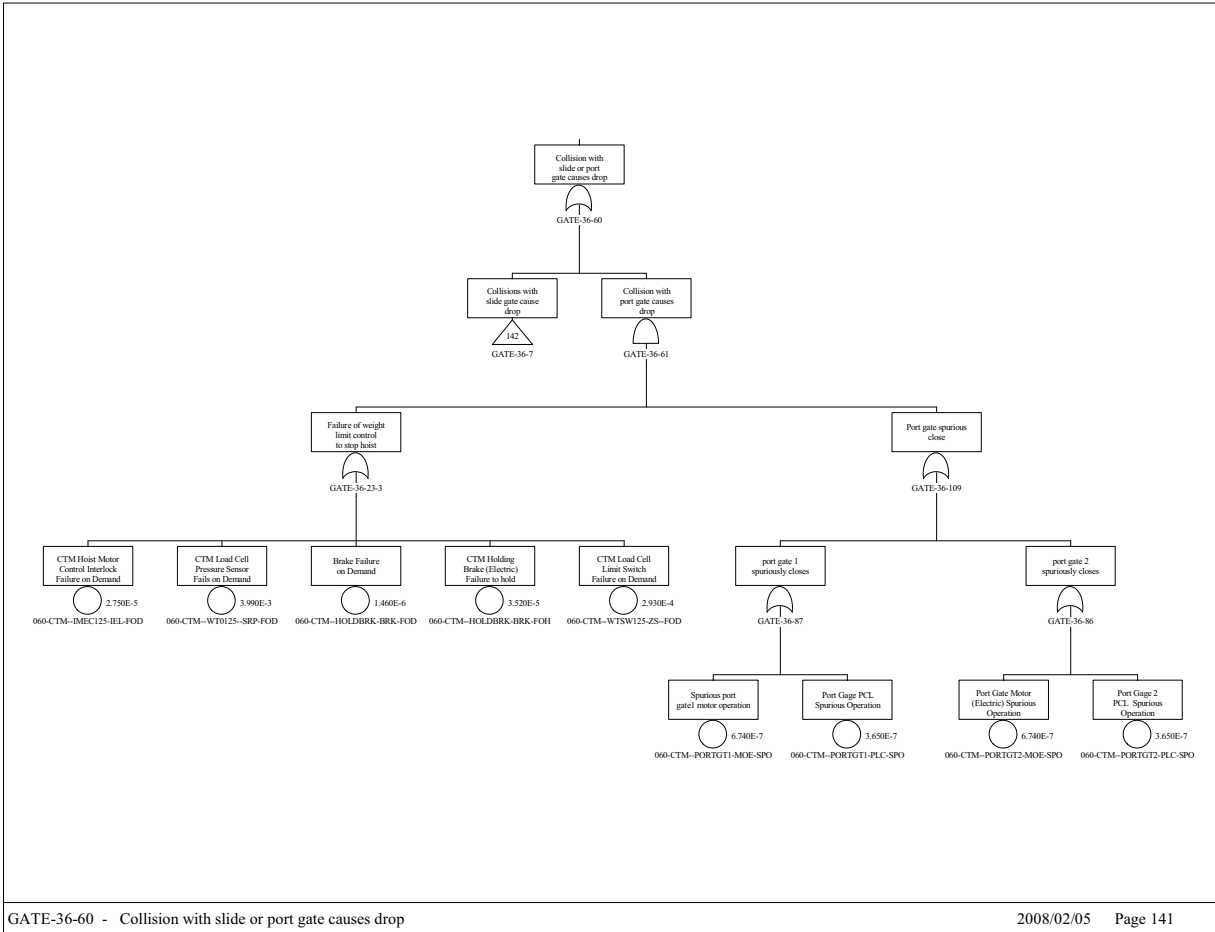

Source: Original

Figure B4.4-30. Drop of Object onto Cask Sheet 10

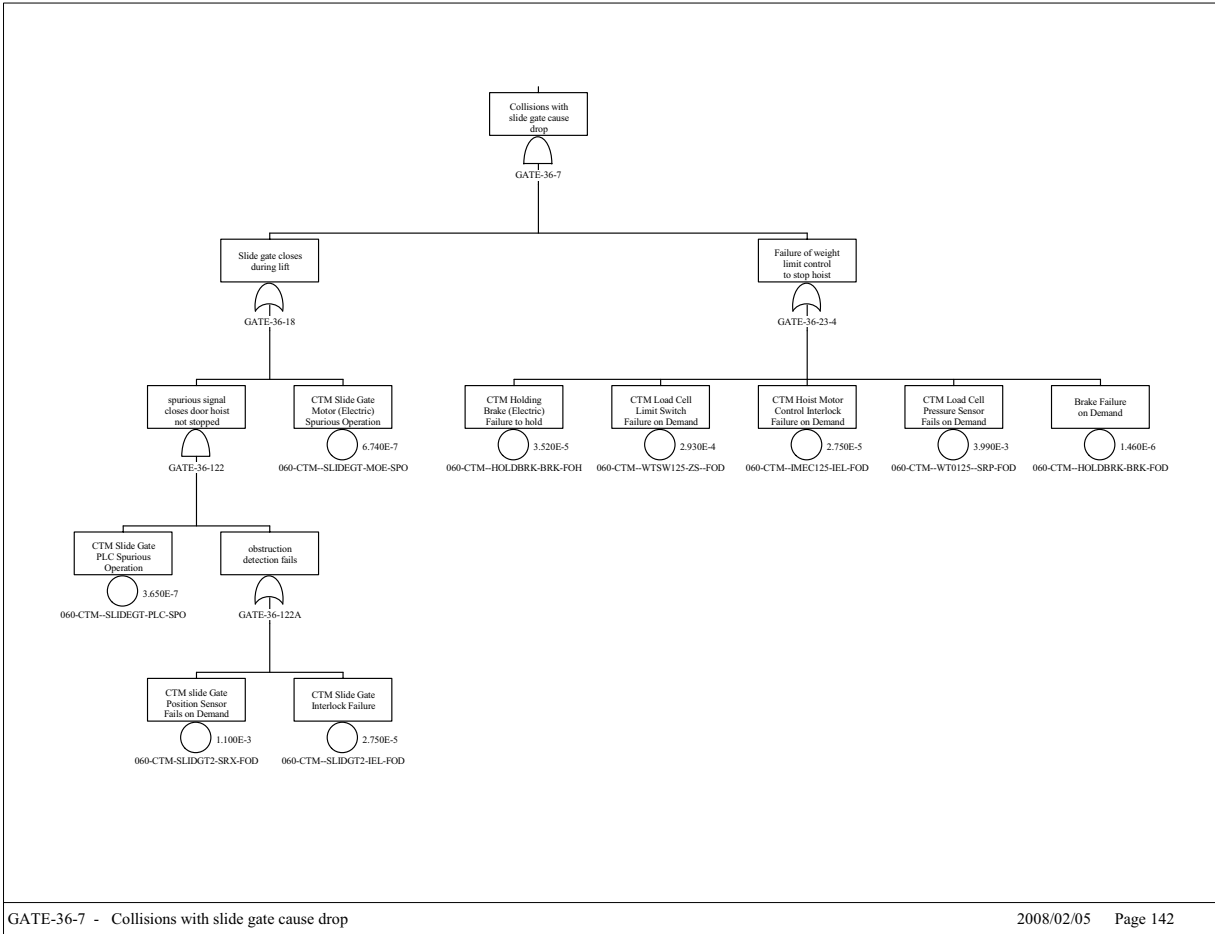

Source: Original

Figure B4.4-31. Drop of Object onto Cask Sheet 11

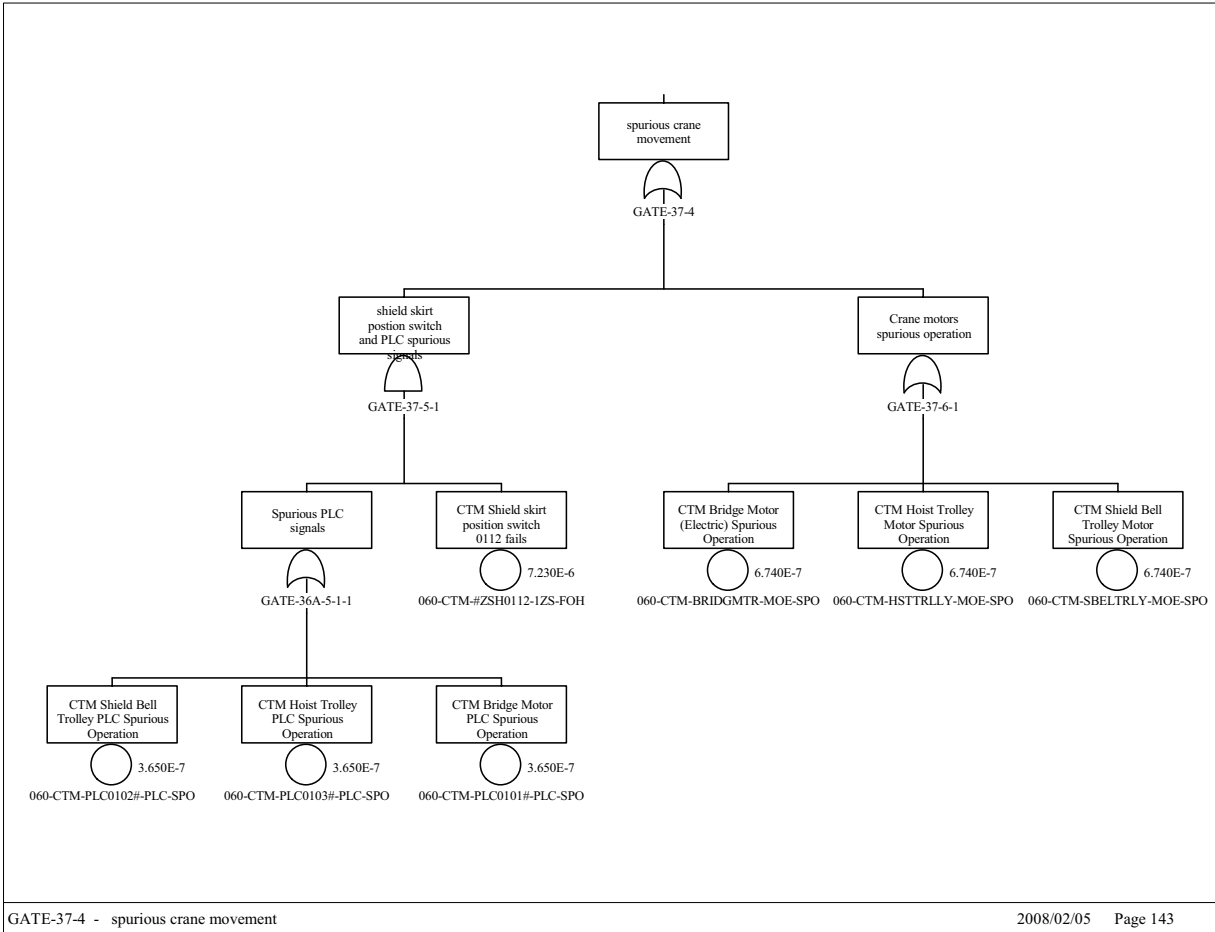

Source: Original

Figure B4.4-32. Drop of Object onto Cask Sheet 12

B4.4.4 Canister Impact

B4.4.4.1 Description

A fault tree was developed to address the potential for impacts to the canister. CTM movements that could result in collisions between the CTM, shield bell, floor, and a permanent structure were considered.

B4.4.4.2 Success Criteria

Success criteria for the “Canister Impact” is the prevention of a collision between the canister and any structures in Canister Transfer Room from any cause during the lift, lateral movement, and lower portions of the canister transfer.

B4.4.4.3 Design Requirements and Features

Requirements

Hard-wired interlocks are used to prevent inadvertent actions during CTM transfer operations. These include the following:

- An optical sensor at the bottom of the shield bell that, once it is cleared, stops the hoist and erases the lift command (can only lower hoist). This interlock is used only when lifting a canister.
- Above the ASD stop point is an upper limit switch which, when reached, stops the hoist from lifting. This first limit switch (first hoist upper limit) effectively erases the lift command (the hoist still has power) and the operator can only lower the hoist. Roughly a foot above that limit switch is another limit switch (final hoist upper limit) that, when reached, cuts off the power to the CTM hoist.
- An interlock between the shield skirt and port gate which requires the shield skirt to be lowered in order for the port gate to open. There is a maintenance bypass for this interlock.
- An interlock between the CTM bridge/trolley travel and shield skirt position. Neither the CTM bridge nor the trolley can travel while the skirt is lowered
- An interlock between the slide gate and shield skirt – the shield skirt cannot be raised unless the slide gate is closed. This interlock can be bypassed, to allow the CTM to move with the slide gate open during lid removal.
- Interlocks preventing improper hoist movement. The hoist cannot move unless the shield skirt is lowered. This interlock is based on hoist movement, not position, so movement with the hoist too low is not precluded.
- Anti-collision interlocks (position driven) for the two CTMs.
- The load cells cut off power to the hoist when the crane capacity is exceeded.
- An interlock between the grapple position (fully engaged or fully disengaged) and hoist movement. The grapple automatically engages/disengages with a given object. The grapple must be positively engaged for the grapple engagement indicator to give a positive indication.

Design Features

Bridge and trolley motors are sized to limit lateral travel to less than 20 feet per minute, sufficient to ensure that in the event of an impact, impact forces are below the design limits of the canister.

The shield bell slide gate motors are sized so that they are incapable of exerting sufficient force to damage any canister given an inadvertent closure of the gate when a canister is suspended in the gate closure path.

The floor port gate motors are sized so that they are incapable of exerting sufficient force to damage any canister given an inadvertent closure of the gate when a canister is suspended in the gate closure path.

Hard-wired interlocks used to prevent inadvertent actions during CTM transfer operations ITS; PLCs are not ITS equipment.

The end stops for both the bridge and trolley end of travel are capable of stopping the bridge/trolley at their maximum speed and preclude impact with any permanent structure.

The interlock between the grapple position and the operation of the hoist motor cannot be bypassed during CTM canister transfer operations.

B4.4.4.4 Fault Tree Model

The top event in the fault tree is “Canister Impact”. The CTM collision fault tree addresses potential end of run over travel events and collisions between the two CTMs. Faults considered in the evaluation of this top event include: human events that contribute to a collision and mechanical (structural) failures of the CTM components. The interlocks intended to prevent improper CTM movement are included in the model.

B4.4.4.5 Basic Event Data

Table B4.4-9 contains a list of basic events used in the “Canister Impact” fault tree. Included are the human failure events and the common-cause failure events identified in the previous two sections. There are no maintenance failures associated with the CTM. The CTMs are in service while they are undergoing maintenance. Sensor failures that could be associated with the failure to restore from maintenance are not expected to contribute significantly to the overall sensor availability.

The canister impact probability modeled by the fault tree is evaluated over a mission time of one hour. This mission time encompasses vertical lifting, lateral movement, and vertical lowering of the canister by the CTM. A longer mission time is also considered for specific components. For example, the fault tree accounts for the failure of standby components whose potential malfunction would remain hidden until they are tested. They are consequently evaluated over the interval of time between their test (mission time set to the average fault exposure time, one-half the test interval).

Table B4.4-9. Basic Event Probability for the CTM Fault Trees

Name	Description	Calc. Type ^a	Calculation Probability	Failure Probability	Lambda	Mission time ^a
060-CTM-BREDGMTR-#CT-FOD	CTM bridge motor controller fails	1	4.000E-06	4.000E-06	0.000E+00	0.000E+00
060-CTM-BRIDGETR-#PR-FOH	CTM bridge passive restraint (end stops) failure	3	1.949E-06	0.000E+00	4.450E-10	4.380E+03
060-CTM-BRIDGETR-MOE-FSO	CTM bridge motor fails to stop	3	1.350E-08	0.000E+00	1.350E-08	1.000E+00
060-CTM-BRIDGMTR-IEL-FOD	CTM shield skirt-bridge motor interlock failure	1	2.740E-05	2.750E-05	0.000E+00	0.000E+00
060-CTM-HSTTRLLY-IEL-FOD	CTM shield skirt hoist trolley motor interlock failure	1	2.740E-05	2.750E-05	0.000E+00	0.000E+00
060-CTM-SBELTRLY-IEL-FOD	CTM shield bell trolley interlock failure	1	2.740E-05	2.750E-05	0.000E+00	0.000E+00
060-CTM-SKRTCTCT-SRP-FOD	CTM skirt floor contact sensors fail	1	4.000E-03	3.990E-03	0.000E+00	0.000E+00
060-CTM-TROLLEYT-MOE-FSO	CTM trolley motor fails to stop	3	1.350E-08	0.000E+00	1.350E-08	1.000E+00
060-CTM-TROLLYTR-#PR-FOH	CTM trolley passive restraint (end stop) failure	3	1.949E-06	0.000E+00	4.450E-10	4.380E+03
060-CTM-TROLYCNT-#HC-FOD	CTM trolley motor hand controller fails	1	1.740E-03	1.740E-03	0.000E+00	0.000E+00
060-OPCTMIMPACT1-HFI-COD	operator moves trolley/crane with canister below floor	1	4.000E-08	4.000E-08	0.000E+00	0.000E+00
060-OPCTMIMPACT5-HFI-COD	operator over runs travel-collides into end stop	1	1.000E+00	1.000E+00	0.000E+00	0.000E+00

NOTE: ^a For Calc. Type 3 with a mission time of 0, SAPHIRE performs the quantification using the system mission time.

CTM = canister transfer machine; Calc = calculation

Source: Original

B4.4.4.5.1 Human Failure Events

Two basic events are associated with human error (Table B4.4-10). One addresses the movement of the CTM during a lift and the second addresses the potential overrun of the CTM (either the bridge trolley or the hoist/shield skirt trolley). The quantification of 060-OPCTMIMPACT1-HCI-COD includes the probability of operator actions and the failure of ITS related interlocks intended to prevent such operator actions (Attachment E.) A preliminary screening value was used for quantification of 060-OPCTMIMPACT5-HFI-COD.

Table B4.4-10. Human Failure Events

Name	Description
060-OPCTMIMPACT1-HFI-COD	Operator moves trolley/crane with canister below floor
060-OPCTMIMPACT5-HFI-COD	Operator over runs travel - collides into end stop

Source: Original

B4.4.4.5.2 Common-cause Failures

There are no common-cause failures modeled in the “Canister Impact” fault tree.

B4.4.4.6 Uncertainty and Cut Set Generation

Figure B4.4-33 contains the uncertainty results obtained from running the fault tree for the “Canister Impact” using a cutoff probability of 1E-15. Figure B4.4-34 provides the cutset generation results for the “Canister Impact” fault tree.

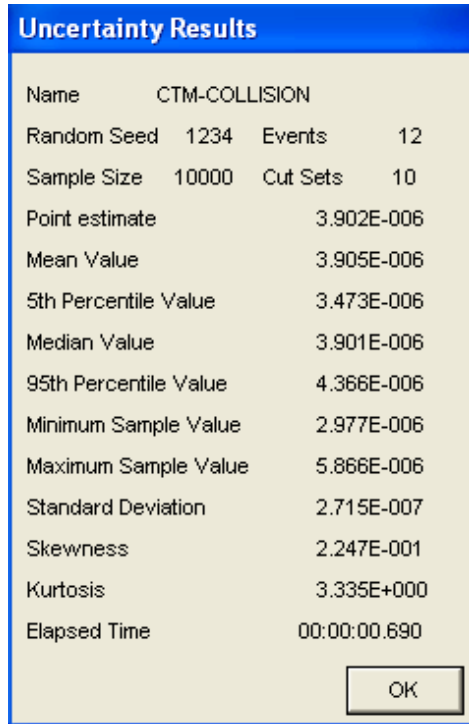

Source: Original

Figure B4.4-33. Uncertainty Results of the “Canister Impact” Fault Tree

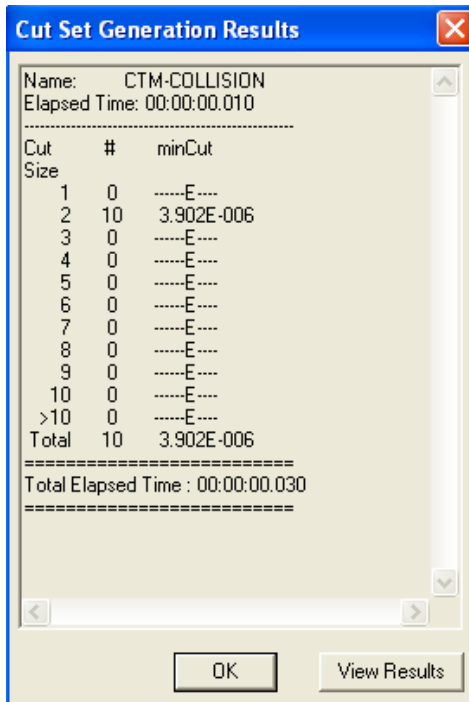

Source: Original

Figure B4.4-34. Cut Set Generation Results for the “Canister Impact” Fault Tree

B4.4.4.7 Cut Sets

Table B4.4-11 contains the cutsets for the “Canister Impact” fault tree.

Table B4.4-11. Dominant Cut Sets for the CTM Collision Fault Tree

% Total	% Cut Set	Probability/ Frequency	Basic Event	Description	Event Probability
49.95	49.95	1.949E-06	060-CTM-TROLLYTR-#PR-FOH	CTM trolley passive restraint (end stop) failure	1.949E-06
			060-OPCTMIMPACT5-HFI-COD	operator over runs travel - collides into end stop	1.000E+00
99.90	49.95	1.949E-06	060-CTM-BRIDGETR-#PR-FOH	CTM bridge passive restraint (end stops) failure	1.949E-06
			060-OPCTMIMPACT5-HFI-COD	operator over runs travel - collides into end stop	1.000E+00
99.99	0.09	3.391E-09	060-CTM-TROLLYTR-#PR-FOH	CTM trolley passive restraint (end stop) failure	1.949E-06
			060-CTM-TROLYCNT-#HC-FOD	CTM trolley motor hand controller fails	1.740E-03
99.99	0.00	1.596E-10	060-CTM-SKRTCTCT-SRP-FOD	CTM skirt floor contact sensors fail	3.990E-03
			060-OPCTMIMPACT1-HFI-COD	operator moves trolley/crane with canister below floor	4.000E-08
99.99	0.00	7.796E-12	060-CTM-BREDGMTR-#CT-FOD	CTM bridge motor controller fails	4.000E-06
			060-CTM-BRIDGETR-#PR-FOH	CTM bridge passive restraint (end stops) failure	1.949E-06
99.99	0.00	1.100E-12	060-CTM-SBELTRLY-IEL-FOD	CTM shield bell trolley interlock failure	2.750E-05
			060-OPCTMIMPACT1-HFI-COD	operator moves trolley/crane with canister below floor	4.000E-08
99.99	0.00	1.100E-12	060-CTM-BRIDGMTR-IEL-FOD	CTM shield skirt-bridge motor interlock failure	2.750E-05
			060-OPCTMIMPACT1-HFI-COD	operator moves trolley/crane with canister below floor	4.000E-08
99.99	0.00	1.100E-12	060-CTM-HSTRLLY-IEL-FOD	CTM shield skirt hoist trolley motor interlock failure	2.750E-05
			060-OPCTMIMPACT1-HFI-COD	operator moves trolley/crane with canister below floor	4.000E-08
99.99	0.00	2.631E-14	060-CTM-TROLLEYT-MOE-FSO	CTM trolley motor fails to stop	1.350E-08
			060-CTM-TROLLYTR-#PR-FOH	CTM trolley passive restraint (end stop) failure	1.949E-06
99.99	0.00	2.631E-14	060-CTM-BRIDGETR-#PR-FOH	CTM bridge passive restraint (end stops) failure	1.949E-06
			060-CTM-BRIDGETR-MOE-FSO	CTM bridge motor fails to stop	1.350E-08

NOTE: CCF = common-cause failure; Ctl = control; CTM = canister transfer machine; PLC = programmable logic controller.

Source: Original

B4.4.4.8 Fault Trees

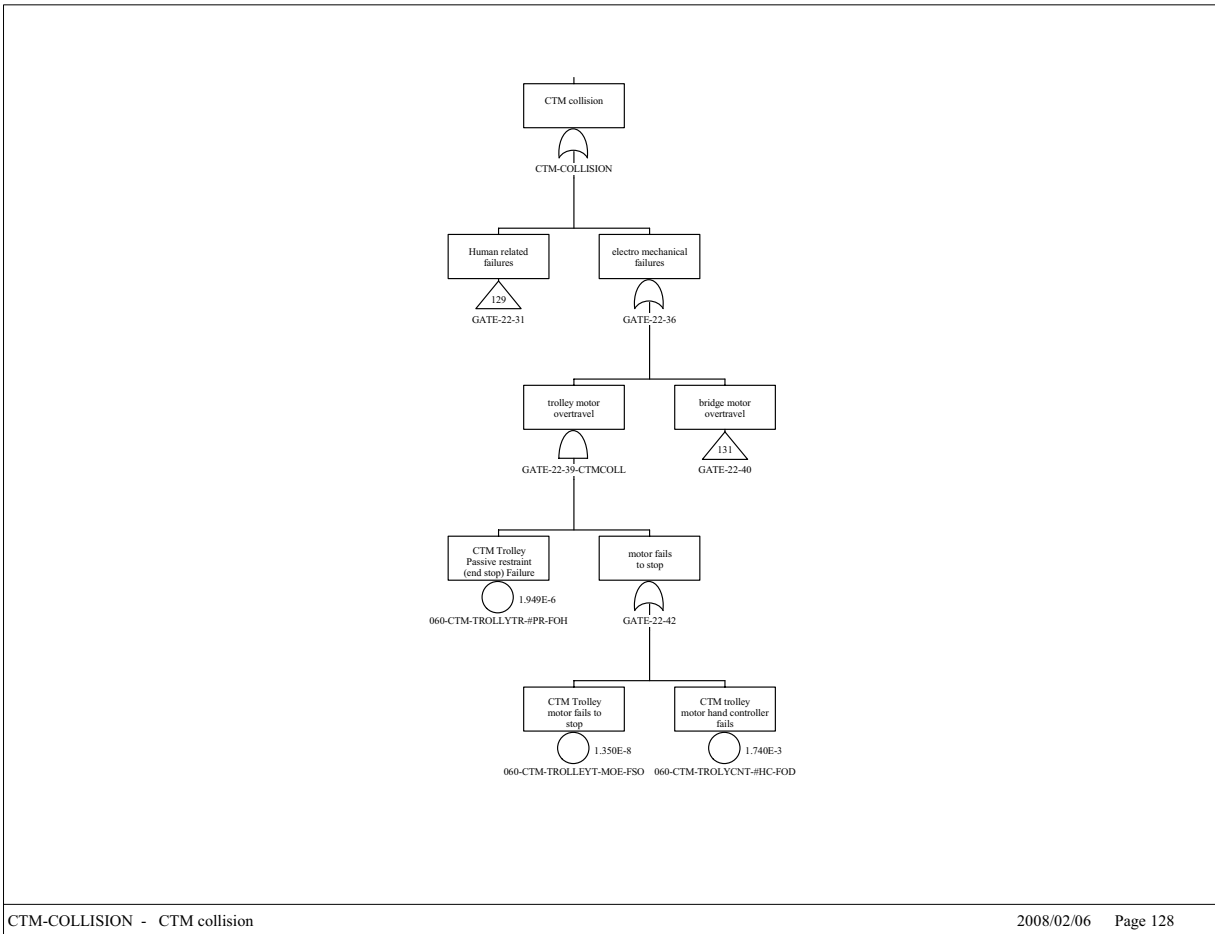

Source: Original

Figure B4.4-35. Canister Impact—CTM Collision Sheet 1

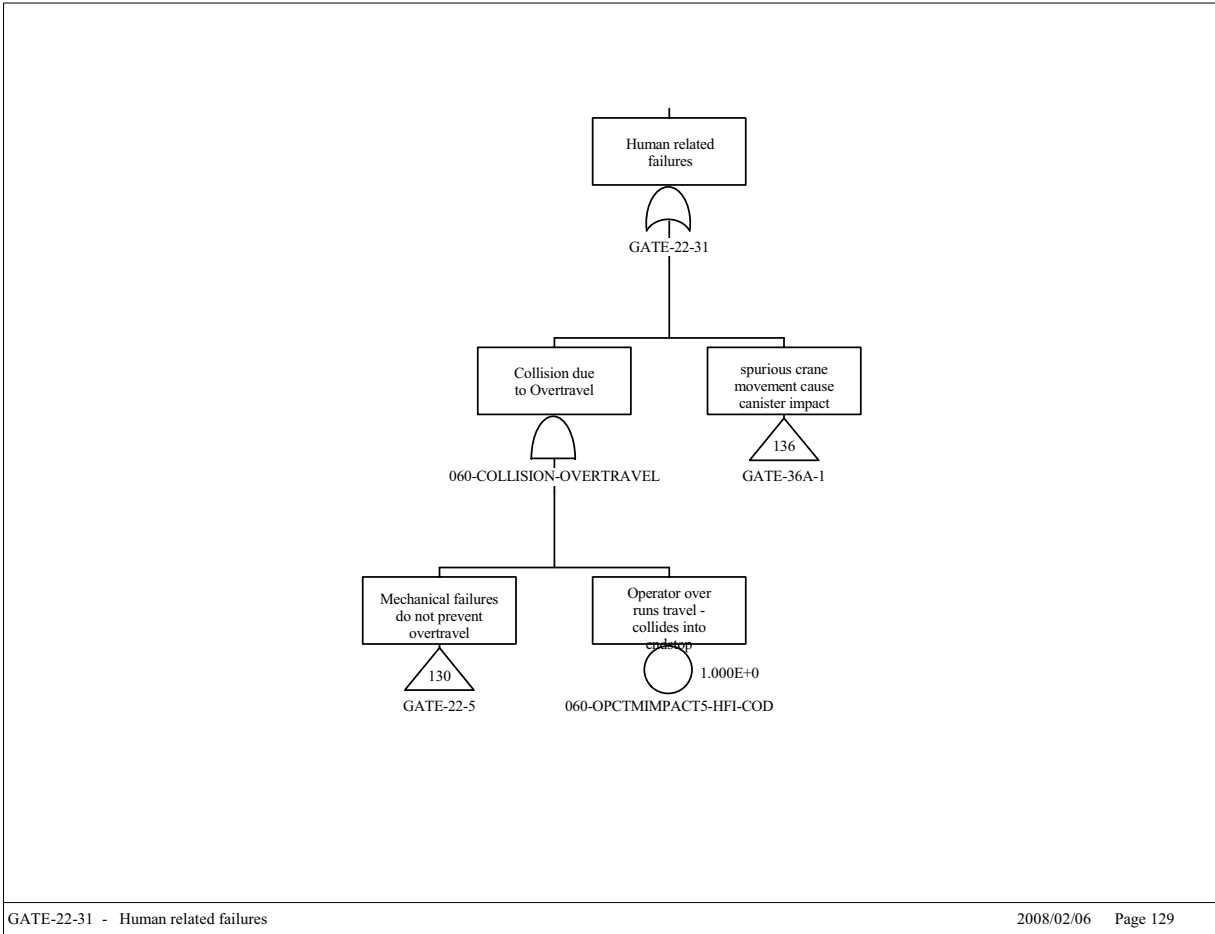

Source: Original

Figure B4.4-36. CTM Collision Sheet 2

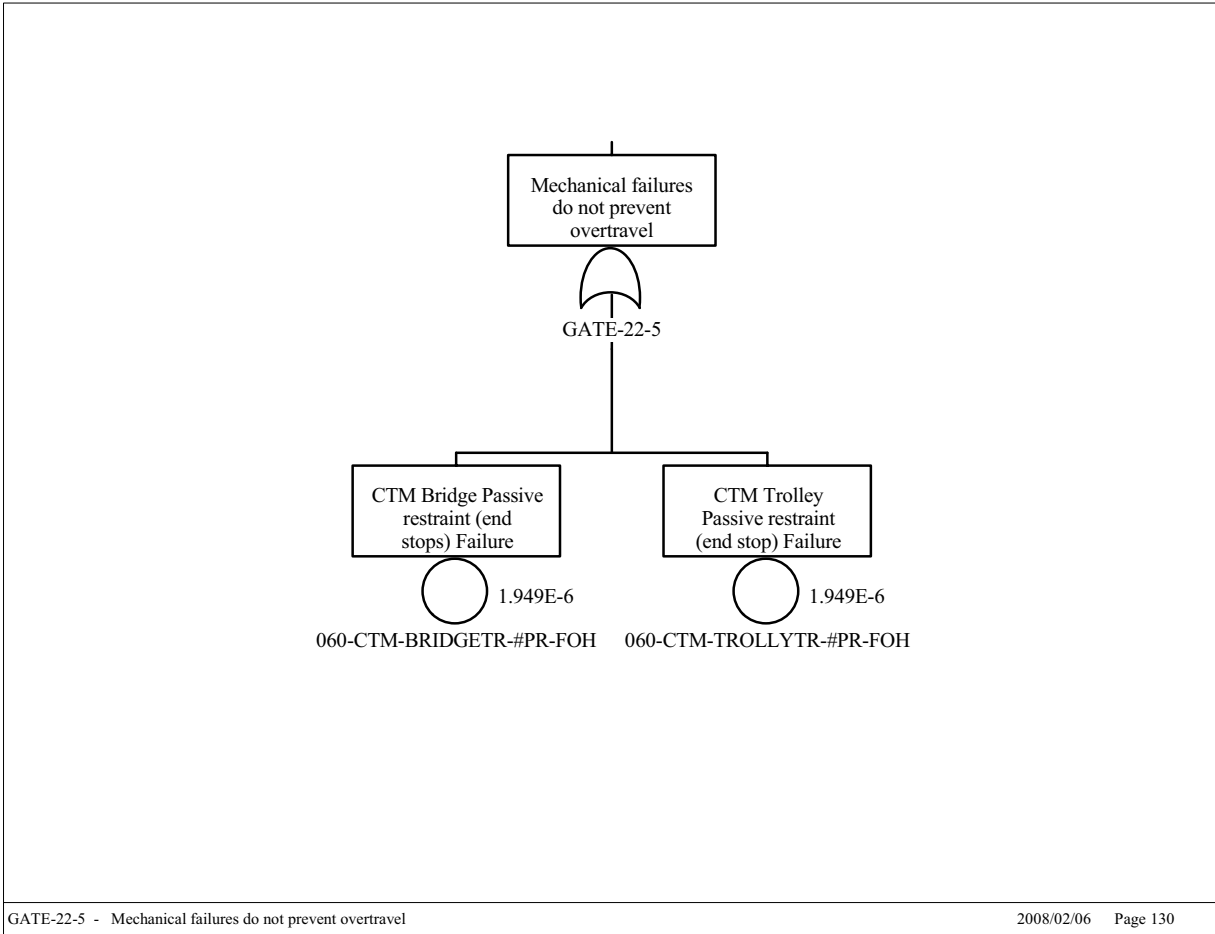

Source: Original

Figure B4.4-37. CTM Collision Sheet 3

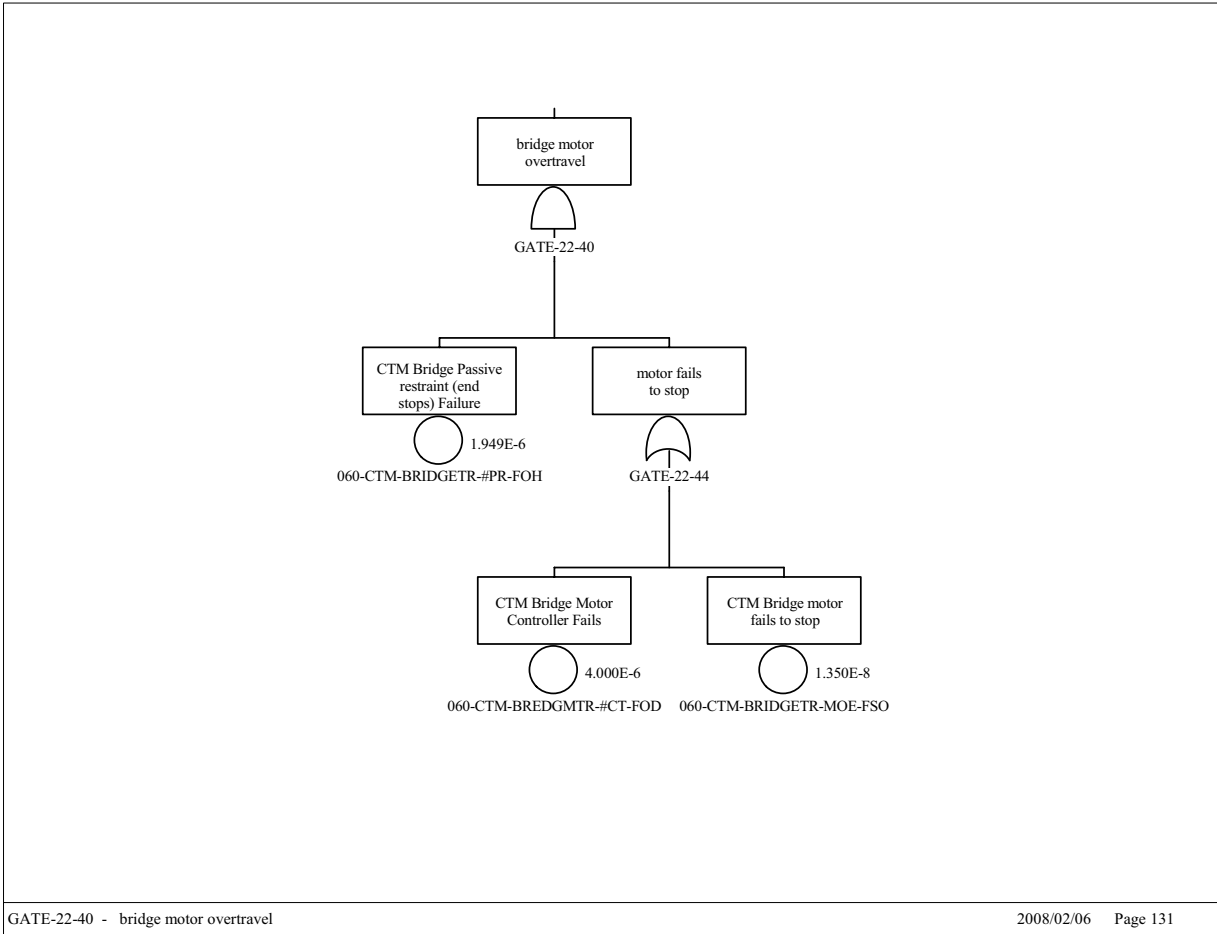

Source: Original

Figure B4.4-38. CTM Collision Sheet 4

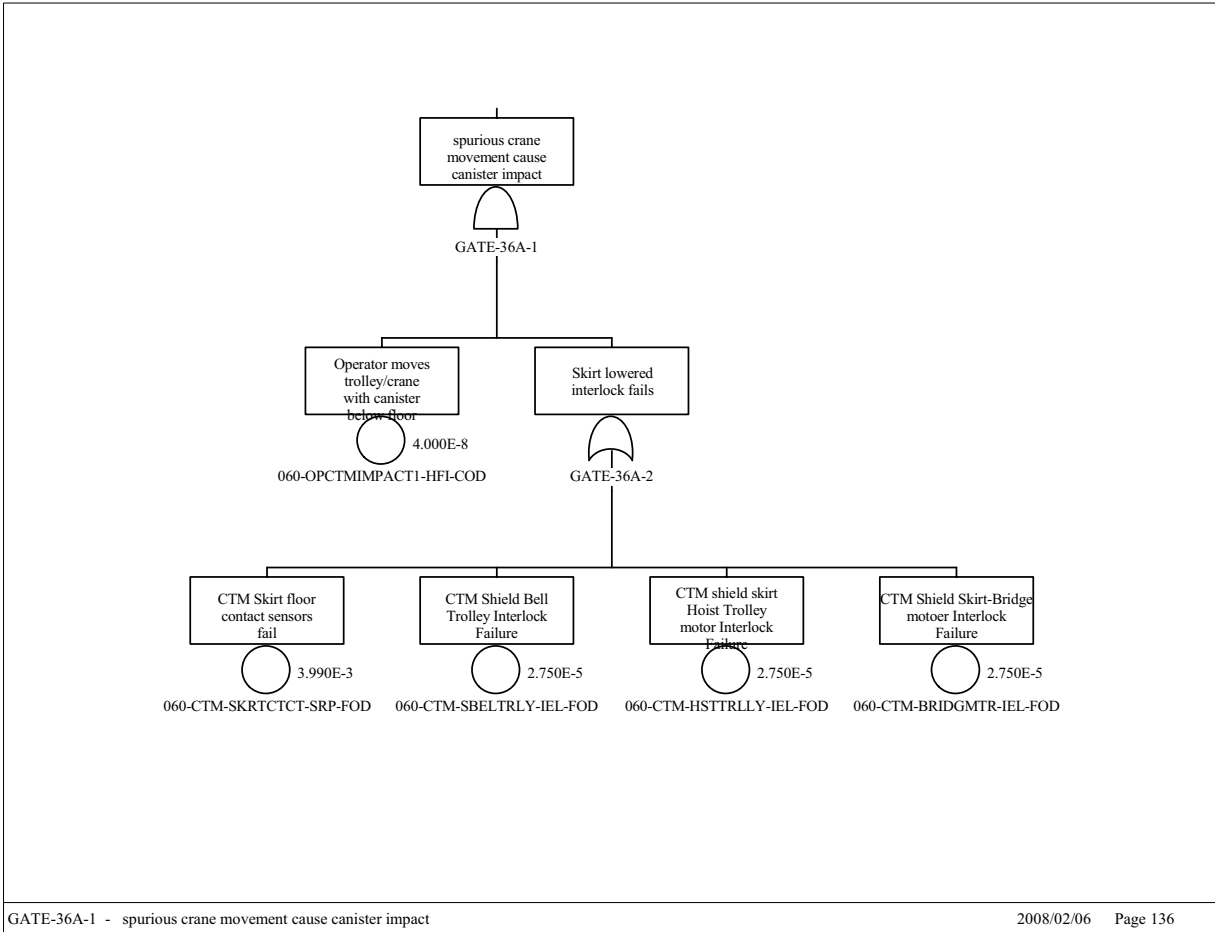

Source: Original

Figure B4.4-39. CTM Collision Sheet 5

B4.4.5 CTM Movement Subjects Canister to Shearing Forces

B4.4.5.1 Description

A fault tree was developed to address the potential for movement of the CTM when the canister being transferred is being lifted and is between the CRCF floors. Movement initiated by the bridge or trolley motors could result in shear forces being applied to the canister should it be lifted when the CTM moves away from the floor port opening.

B4.4.5.2 Success Criteria

Success criteria for the CTM is the prevention of CTM movement that could result in a shearing force being applied to the canister when the canister is being lifted and is between the first and second floors of the CRCF during the lift portions of the canister transfer.

B4.4.5.3 Design Features and Inputs

Requirements

Hard-wired interlocks are used to prevent inadvertent actions during CTM transfer operations. These include the following:

- An optical sensor at the bottom of the shield bell that, once it is cleared, stops the hoist and erases the lift command (can only lower hoist). This interlock is used only when lifting a canister.
- Above the ASD stop point is an upper limit switch which, when reached, stops the hoist from lifting. This first limit switch (first hoist upper limit) effectively erases the lift command (the hoist still has power) and the operator can only lower the hoist. Roughly a foot above that limit switch is another limit switch (final hoist upper limit) that, when reached, cuts off the power to the CTM hoist.
- An interlock between the shield skirt and port gate which requires the shield skirt to be lowered in order for the port gate to open. There is a maintenance bypass for this interlock.
- An interlock between the CTM bridge/trolley travel and shield skirt position. Neither the CTM bridge nor the trolley can travel while the skirt is lowered.
- An interlock between the slide gate and shield skirt—the shield skirt cannot be raised unless the slide gate is closed. This interlock can be bypassed, to allow the CTM to move with the slide gate open during lid removal.
- Interlocks preventing improper hoist movement. The hoist cannot move unless the shield skirt is lowered. This interlock is based on hoist movement, not position, so movement with the hoist too low is not precluded.
- Anti-collision interlocks (position driven) for the two CTMs.
- The load cells cut off power to the hoist when the crane capacity is exceeded.
- An interlock between the grapple position (fully engaged or fully disengaged) and hoist movement. The grapple automatically engages/disengages with a given object. The grapple must be positively engaged for the grapple engagement indicator to give a positive indication.

Design Features

Bridge and trolley motors are sized to limit lateral travel to less than 20 feet per minute, sufficient to ensure that in the event of an impact, impact forces are below the design limits of the canister.

The shield bell slide gate motors are sized so that they are incapable of exerting sufficient force to damage any canister given an inadvertent closure of the gate when a canister is suspended in the gate closure path.

The floor port gate motors are sized so that they are incapable of exerting sufficient force to damage any canister given an inadvertent closure of the gate when a canister is suspended in the gate closure path.

Hard-wired interlocks used to prevent inadvertent actions during CTM transfer operations are ITS; PLCs are not ITS equipment.

The end stops for both the bridge and trolley end of travel end stops are capable of stopping the bridge/trolley at their maximum speed and preclude impact with any permanent structure.

The interlock between the grapple position and the operation of the hoist motor cannot be bypassed during CTM canister transfer operations.

B4.4.5.4 Fault Tree Model

The top event in this fault tree is “CTM Movement Subjects Canister to Shearing Forces”. The fault tree includes events (mechanical control failures and human actions, considered in conjunction with the interlocks intended to prevent the erroneous human action) that can initiate a spurious movement of the CTM trolley or bridge while the canister is between the first and second floors of the CRCF.

B4.4.5.5 Basic Event Data

Table B4.4-12 contains a list of basic events used in the “CTM Movement Subjects Canister to Shearing Forces” fault tree. Included are the human failure events and the common-cause failure events identified in the following two sections. There are no maintenance failures associated with the CTM. The CTMs are not in service while they are undergoing maintenance. Sensor failures that could be associated with the failure to restore from maintenance are not expected to contribute significantly to the overall sensor availability.

Table B4.4-12. Basic Event Probability for the CTM Movement Subjects Canister to Shearing Forces Fault Tree

Name	Description	Calc. Type ^a	Calc. Prob.	Fail. Prob.	Lambda	Miss. Time ^a
060-CTM-#ZSH0112-1ZS-FOH	CTM shield skirt position switch 0112 fails	3	7.230E-06	0.000E+0	7.230E-06	1.000E+0
060-CTM-BIDGMTR-#TL-FOH	CTM bridge motor torque limiter failure	3	2.856E-02	0.000E+0	8.050E-05	3.600E+2
060-CTM-BRIDGMS-MOE-SPO	CTM bridge motor (electric) spurious operation - shear	3	6.740E-08	0.000E+00	6.740E-07	1.000E-01
060-CTM-HSTRLLS-MOE-SPO	CTM hoist trolley motor (electric) spurious operation m- shear	3	6.740E-08	0.000E+00	6.740E-07	1.000E-01
060-CTM-HSTRLLY-#TL-FOH	CTM hoist motor torque limiter failure	3	2.856E-02	0.000E+0	8.050E-05	3.600E+02
060-CTM-PLC0101S-PLC-SPO	CTM bridge motor PLC spurious operation -shear	3	3.650E-08	0.000E+0	3.650E-07	1.000E-01
060-CTM-PLC0102S-PLC-SPO	CTM shield bell trolley PLC spurious operation – shear	3	3.650E-08	0.000E+0	3.650E-07	1.000E-01
060-CTM-PLC0103S-PLC-SPO	CTM hoist trolley PLC spurious operation -shear	3	3.650E-08	0.000E+0	3.650E-07	1.000E-01
060-CTM-SBELTRLS-MOE-SPO	CTM shield bell trolley motor (Electric) spurious operation-shear	3	6.740E-08	0.000E+00	6.740E-07	1.000E-01
060-CTM-SBELTRLY-#TL-FOH	CTM shield bell motor torque limiter failure	3	2.856E-02	0.000E+0	8.050E-05	3.600E+02
060-OPCTMIMPACT1-HFI-COD	Operator moves trolley/crane with canister below floor	1	4.000E-08	4.000E-08	0.000E+0	0.000E+0

NOTE: CTM = canister transfer machine; PLC = programmable logic controller.

^a For Calc. Type 3 with a mission time of 0, SAPHIRE performs the quantification using the system mission time.

Source: Original

The impact shear probability modeled by the fault tree is evaluated over a mission time of one-tenth of an hour (limited to the time the canister is being lifted and is between the first and second floors). A longer mission time is also considered for specific components. For example, the fault tree accounts for the failure of standby components whose potential malfunction would remain hidden until they are tested. They are consequently evaluated over the interval of time between their tests, and the mission time is assigned a value of the average fault exposure time, half the test interval.

B4.4.5.5.1 Human Failure Events

One basic event is associated with human error: 060-OPCTMIMPACT1-HFI-COD (Operator moves trolley/crane with canister below floor). This event addresses the possible operator initiated movement of the bridge or trolleys while a canister is being lifted and is between CRCF floors.

B4.4.5.5.2 Common-Cause Failures

No CCFs apply to this fault tree.

B4.4.5.6 Uncertainty and Cut Set Generation

Figure B4.4-40 contains the uncertainty results obtained from running the fault trees for “CTM Movement Subjects Canister to Shearing Forces” using a cutoff probability of 1E-15. Figure B4.4-41 provides the cutset generation results for the “CTM Movement Subjects Canister to Shearing Forces” fault tree.

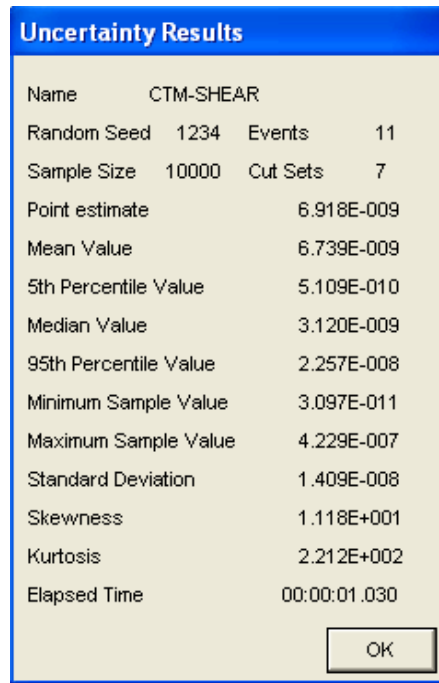

Source: Original

Figure B4.4-40. Uncertainty Results of the CTM Movement Subjects Canister to Shearing Forces Fault Tree

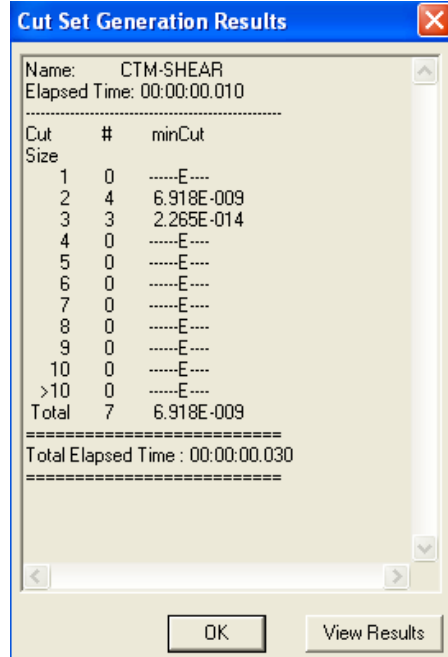

Source: Original

Figure B4.4-41. Cut Set Generation Results for the CTM Movement Subjects Canister to Shearing Forces Fault Tree

B4.4.5.7 Cut Sets

Table B4.4-13 contains the cutsets for the “CTM Movement Subjects Canister to Shearing Forces” fault tree.

Table B4.4-13. Dominant Cut Sets for the “CTM Movement Subjects Canister to Shearing Forces” Fault Tree

% Total	% Cut Set	Probability/ Frequency	Basic Event	Description	Event Probability
27.83	27.83	1.925E-09	060-CTM-SBELTRLS-MOE-SPO	CTM shield bell trolley motor (electric) spurious operation-shear	6.740E-08
			060-CTM-SBELTRLY-#TL-FOH	CTM shield bell motor torque limiter failure	2.856E-02
55.66	27.83	1.925E-09	060-CTM-HSTTRLLS-MOE-SPO	CTM hoist trolley motor (electric) spurious operation	6.740E-08
			060-CTM-HSTTRLLY-#TL-FOH	CTM hoist motor torque limiter failure	2.856E-02
83.49	27.83	1.925E-09	060-CTM-BIDGMTR-#TL-FOH	CTM bridge motor torque limiter failure	2.856E-02
			060-CTM-BRIDGMTS-MOE-SPO	CTM bridge motor (electric) spurious operation -shear	6.740E-08
100.00	16.52	1.143E-09	060-CTM-HSTTRLLY-#TL-FOH	CTM hoist motor torque limiter failure	2.856E-02
			060-OPCTMIMPACT1-HFI-COD	operator moves trolley/crane with canister below floor	4.000E-08
100.00	0.00	7.538E-15	060-CTM-#ZSH0112-1ZS-FOH	CTM shield skirt position switch 0112 fails	7.230E-06
			060-CTM-BIDGMTR-#TL-FOH	CTM bridge motor torque limiter failure	2.856E-02
			060-CTM-PLC0101S-PLC-SPO	CTM bridge motor PLC spurious operation -shear	3.650E-08
100.00	0.00	7.538E-15	060-CTM-#ZSH0112-1ZS-FOH	CTM shield skirt position switch 0112 fails	7.230E-06
			060-CTM-HSTTRLLY-#TL-FOH	CTM hoist motor torque limiter failure	2.856E-02
			060-CTM-PLC0103S-PLC-SPO	CTM hoist trolley PLC spurious operation -shear	3.650E-08
100.00	0.00	7.538E-15	060-CTM-#ZSH0112-1ZS-FOH	CTM shield skirt position switch 0112 fails	7.230E-06
			060-CTM-PLC0102S-PLC-SPO	CTM shield bell trolley PLC spurious operation -shear	3.650E-08
			060-CTM-SBELTRLY-#TL-FOH	CTM shield bell motor torque limiter failure	2.856E-02

NOTE: CTM = canister transfer machine; PLC = programmable logic controller.

Source: Original

B4.4.5.8 Fault Tree

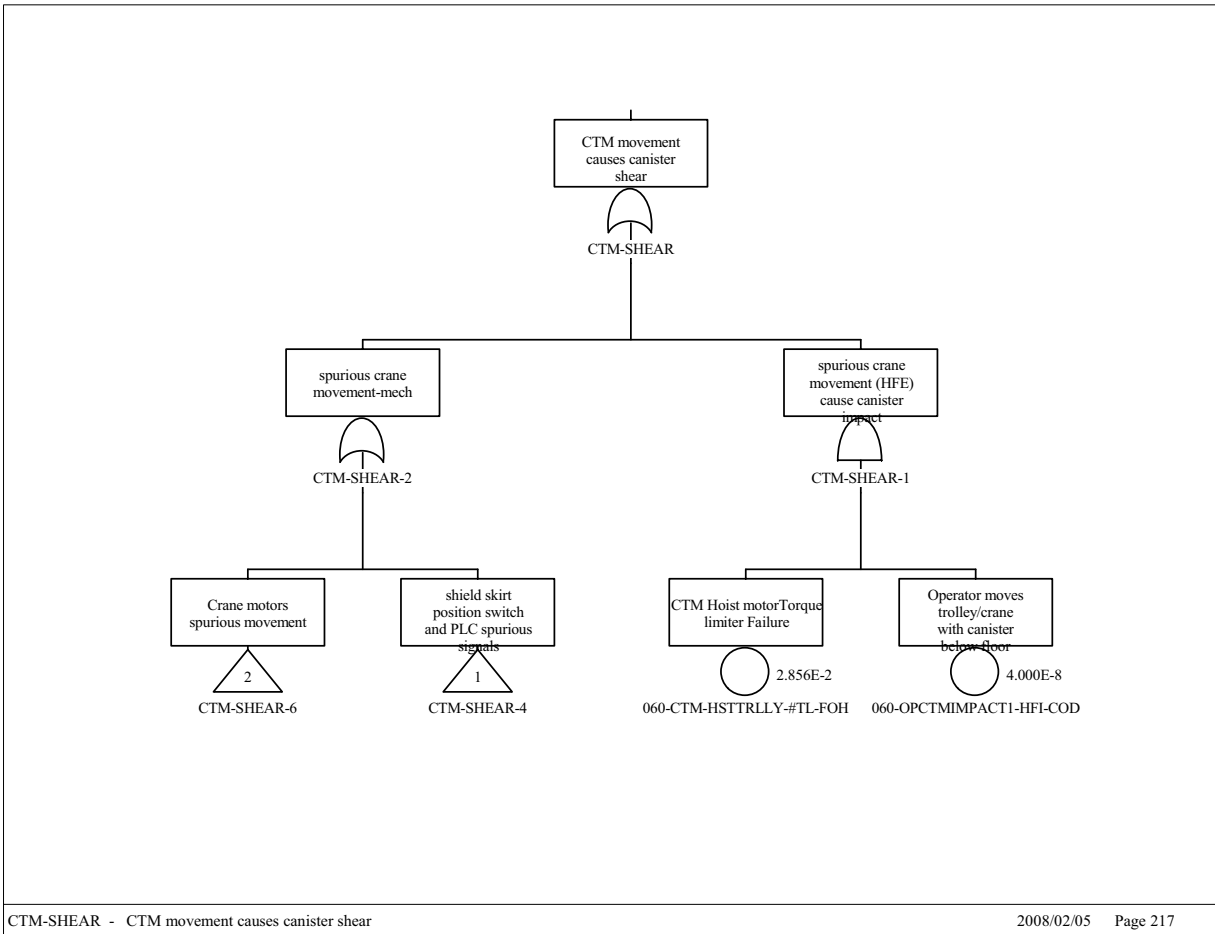

Source: Original

Figure B4.4-42. CTM Shear Sheet 1

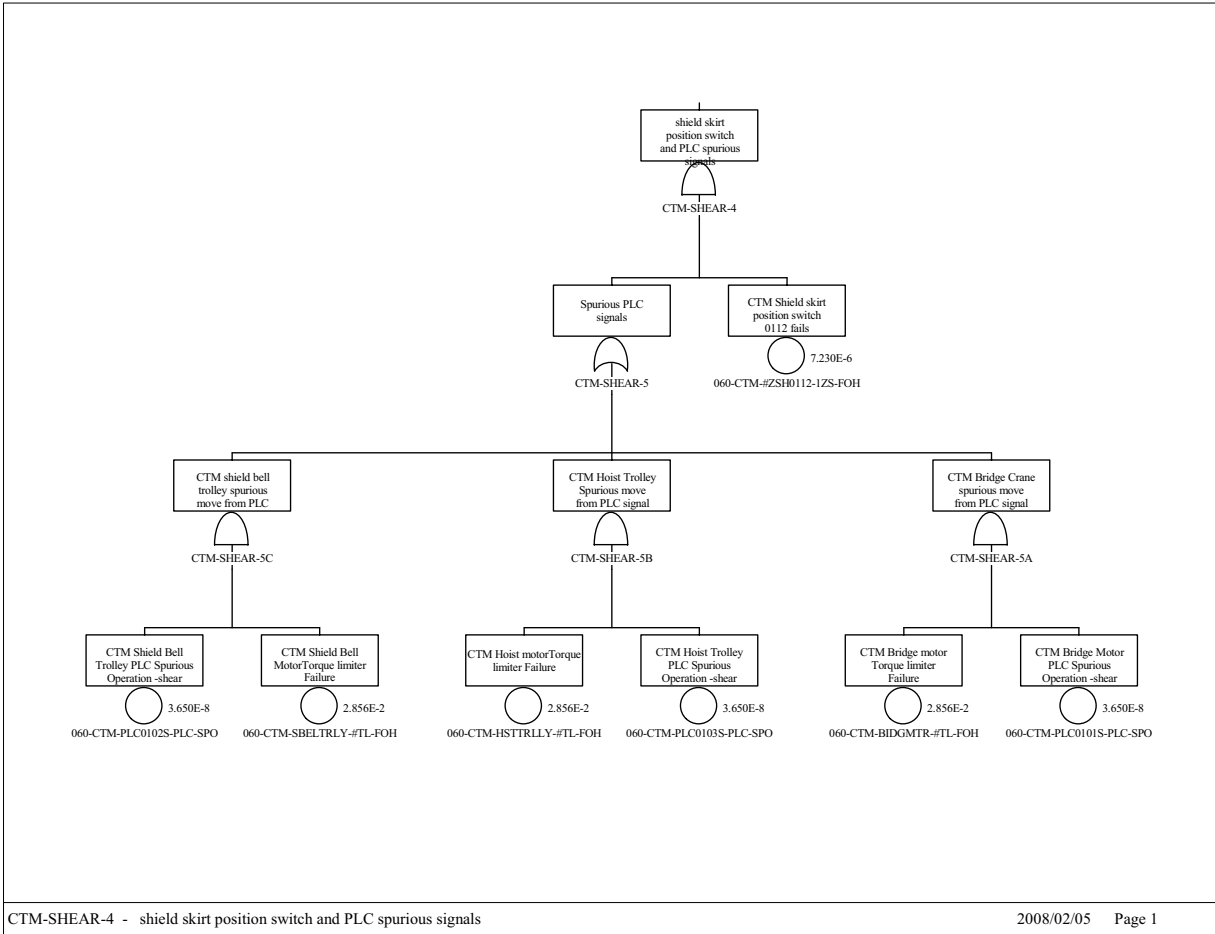

Source: Original

Figure B4.4-43. CTM Shear Sheet 2

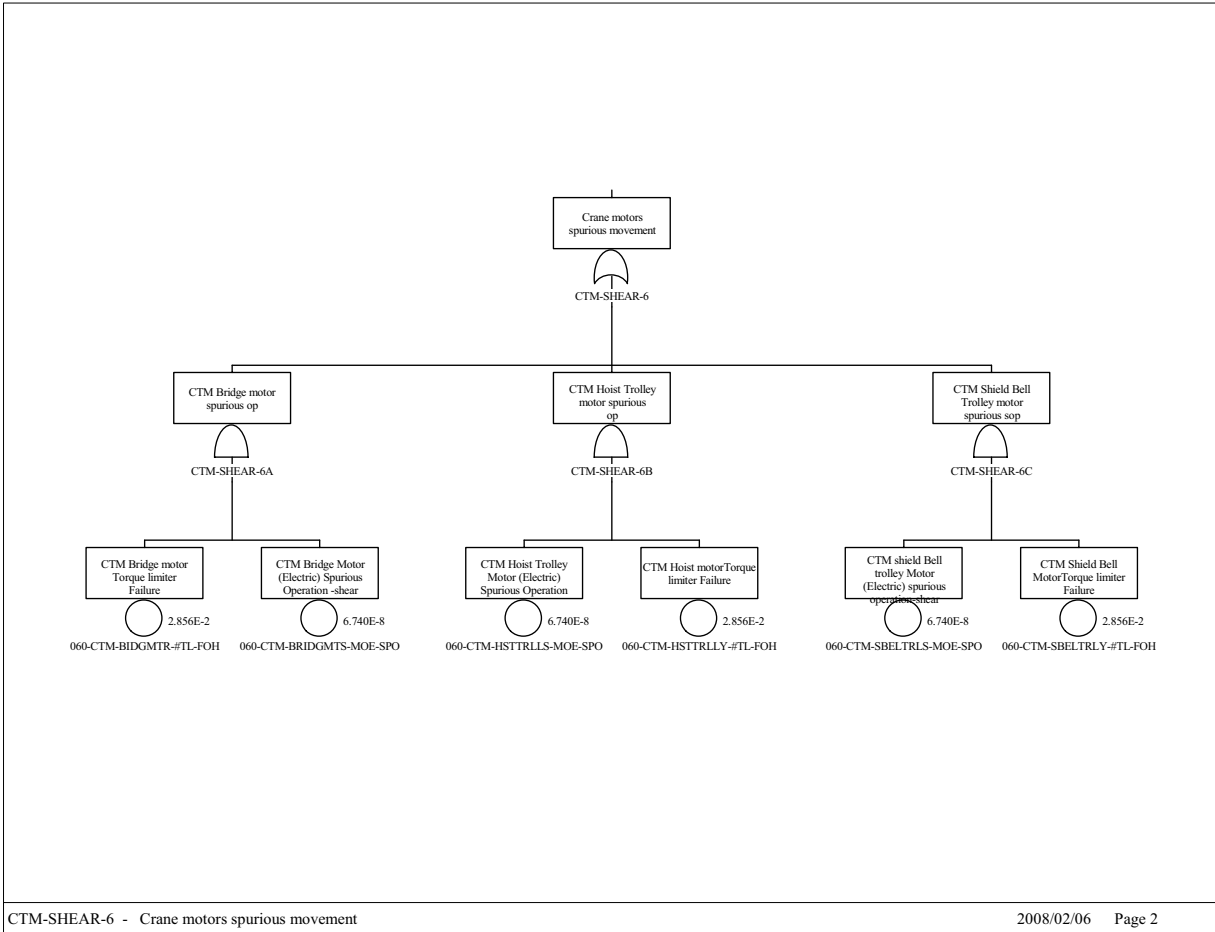

Source: Original

Figure B4.4-44. CTM Shear Sheet 3

B4.4.6 Collision Between Two CTMs

B4.4.6.1 Description

A fault tree was developed to address the potential for impacts to the canister from the collision of the two CTMs in the CRCF. Because the two CTMS operate on the same rails, anti-collision devices are mounted on the end trucks to cut off power and prevent a collision between the two CTMs.

B4.4.6.2 Success Criteria

The success criterion for the CTM is the prevention of a collision between the two CTMs while either one is transferring a canister.

B4.4.6.3 Design Requirements and Features

Requirements

Hard-wired interlocks are used to prevent inadvertent actions during CTM transfer operations. These include the following:

- An optical sensor at the bottom of the shield bell that, once it is cleared, stops the hoist and erases the lift command (can only lower hoist). This interlock is used only when lifting a canister.
- Above the ASD stop point is an upper limit switch which, when reached, stops the hoist from lifting. This first limit switch (first hoist upper limit) effectively erases the lift command (the hoist still has power) and the operator can only lower the hoist. Roughly a foot above that limit switch is another limit switch (final hoist upper limit) that, when reached, cuts off the power to the CTM hoist.
- An interlock between the shield skirt and port gate which requires the shield skirt to be lowered in order for the port gate to open. There is a maintenance bypass for this interlock.
- An interlock between the CTM bridge/trolley travel and shield skirt position. Neither the CTM bridge nor the trolley can travel while the skirt is lowered
- An interlock between the slide gate and shield skirt – the shield skirt cannot be raised unless the slide gate is closed. This interlock can be bypassed, to allow the CTM to move with the slide gate open during lid removal.
- Interlocks preventing improper hoist movement. The hoist cannot move unless the shield skirt is lowered. This interlock is based on hoist movement, not position, so movement with the hoist too low is not precluded.
- Anti-collision interlocks (position driven) for the two CTMs.
- The load cells cut off power to the hoist when the crane capacity is exceeded.
- An interlock between the grapple position (fully engaged or fully disengaged) and hoist movement. The grapple automatically engages/disengages with a given object. The grapple must be positively engaged for the grapple engagement indicator to give a positive indication.

Design Features

Bridge and trolley motors are sized to limit lateral travel to less than 20 feet per minute, sufficient to ensure that in the event of an impact, impact forces are below the design limits of the canister.

The shield bell slide gate motors are sized so that they are incapable of exerting sufficient force to damage any canister given an inadvertent closure of the gate when a canister is suspended in the gate closure path.

The floor port gate motors are sized so that they are incapable of exerting sufficient force to damage any canister given an inadvertent closure of the gate when a canister is suspended in the gate closure path.

Hard-wired interlocks used to prevent inadvertent actions during CTM transfer operations are ITS; PLCs are not ITS equipment.

The end stops for both the bridge and trolley end of travel are capable of stopping the bridge/trolley at their maximum speed and preclude impact with any permanent structure.

The interlock between the grapple position and the operation of the hoist motor cannot be bypassed during CTM canister transfer operations.

B4.4.6.4 Fault Tree Model

The top event in the fault tree is “Collision Between Two CTMs.” This fault tree addresses collisions between the two CTMs (other collision events were addressed in Section B4.4.4). Faults considered in the evaluation of this top event include: human events that contribute to a collision and mechanical failures of the CTM components intended to prevent a collision should the operator act in a way that could cause the two CTMs to collide.

B4.4.6.5 Basic Event Data

Table B4.4-14 contains a list of basic events used in the “Collision Between Two CTMs” fault tree. Included is the human failure event. There are no maintenance failures associated with the CTM. The CTMs are not in service while they are undergoing maintenance. Sensor failures that could be associated with the failure to restore from maintenance are not expected to contribute significantly to the overall sensor availability. All components are modeled using demand failure probabilities.

The canister impact due to CTM collisions modeled by the fault tree is evaluated over a mission time of one hour. This mission time encompasses lateral movement of the canister by the CTM.

Table B4.4-14. Basic Event Probability for the Collision Between Two CTMs Fault Trees

Name	Description	Calc. Type ^a	Calculation Probability	Failure Probability	Lambda	Mission Time ^a
060-CTM-BRIDGETR-IEL-FOD	Bridge over travel interlock fails	1	2.750E-05	2.750E-05	0.000E+00	0.000E+00
060-CTM-ZS##0110--ZS-FOD	CTM position switch (anti-collision) 0110 fails	1	2.930E-04	2.930E-04	0.000E+00	0.000E+00
060-OPCTMIMPACT3-HFI-COD	Operator collides two CTMs	1	1.000E-01	1.000E-01	0.000E+00	0.000E+00

NOTE: ^a For Calc. Type 3 with a mission time of 0, SAPHIRE performs the quantification using the system mission time.

CTM = canister transfer machine.

Source: Original

B4.4.6.5.1 Human Failure Events

One basic event is associated with human error. The event, 060-OPCTMIMPACT3-HFI-COD, addresses the operator movement of the CTM in a manner that could result in a collision between the two CTMs during a lift. The quantification of this event was performed by using a screening value (Attachment E.).

B4.4.6.5.2 Common-cause Failures

There are no common-cause failures modeled in the “Collision Between Two CTMs” fault tree.

B4.4.6.6 Uncertainty and Cut Set Generation

Figure B4.4-45 contains the uncertainty results obtained from running the fault tree for the “Collision Between Two CTMs” using a cutoff probability of 1E-15. Figure B4.4-46 provides the cutset generation results for the “Collision Between Two CTMs” fault tree.

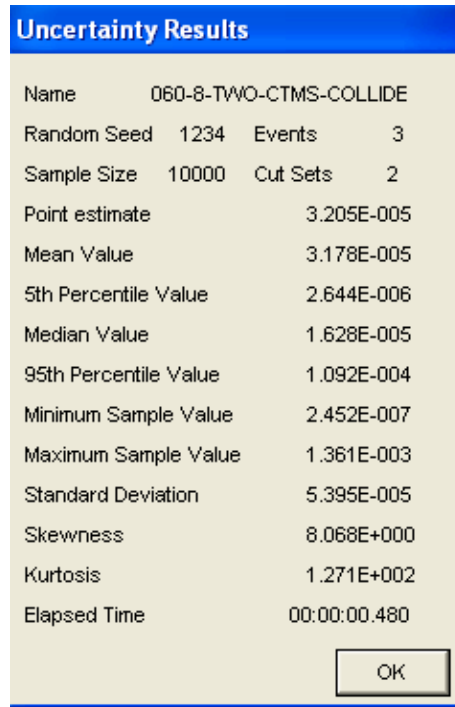

Source: Original

Figure B4.4-45. Uncertainty Results of the Collision Between Two CTMs Fault Tree

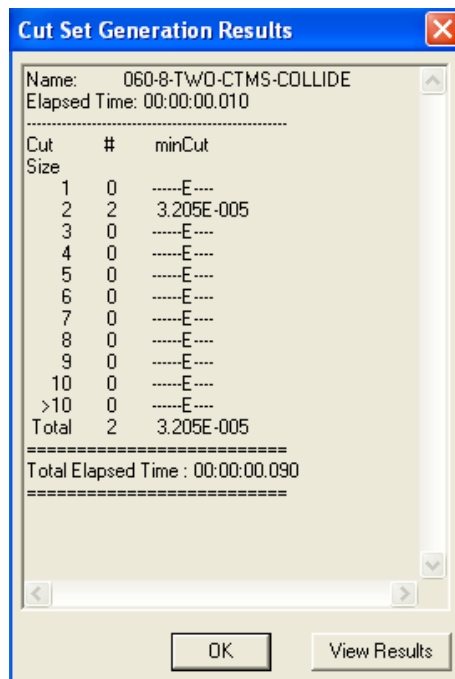

Source: Original

Figure B4.4-46. Cut Set Generation Results for the Collision Between Two CTMs Fault Tree

B4.4.6.7 Cut Sets

Table B4.4-15 contains the cutsets for the “Collision Between Two CTMs” fault tree.

Table B4.4-15. Dominant Cut Sets for the Collision Between Two CTMs Fault Tree

% Total	% Cut Set	Probability/ Frequency	Basic Event	Description	Event Probability
91.42	91.42	2.930E-05	060-CTM-ZS##0110--ZS-FOD	CTM position switch (anti-collision) 0110 fails	2.930E-04
			060-OPCTMIMPACT3-HFI-COD	Operator collides two CTMs	1.000E-01
100.00	8.58	2.750E-06	060-CTM-BRIDGETR-IEL-FOD	Bridge over travel interlock fails	2.750E-05
			060-OPCTMIMPACT3-HFI-COD	Operator collides two CTMs	1.000E-01

NOTE: CTM = canister transfer machine.

Source: Original

B4.4.6.8 Fault Trees

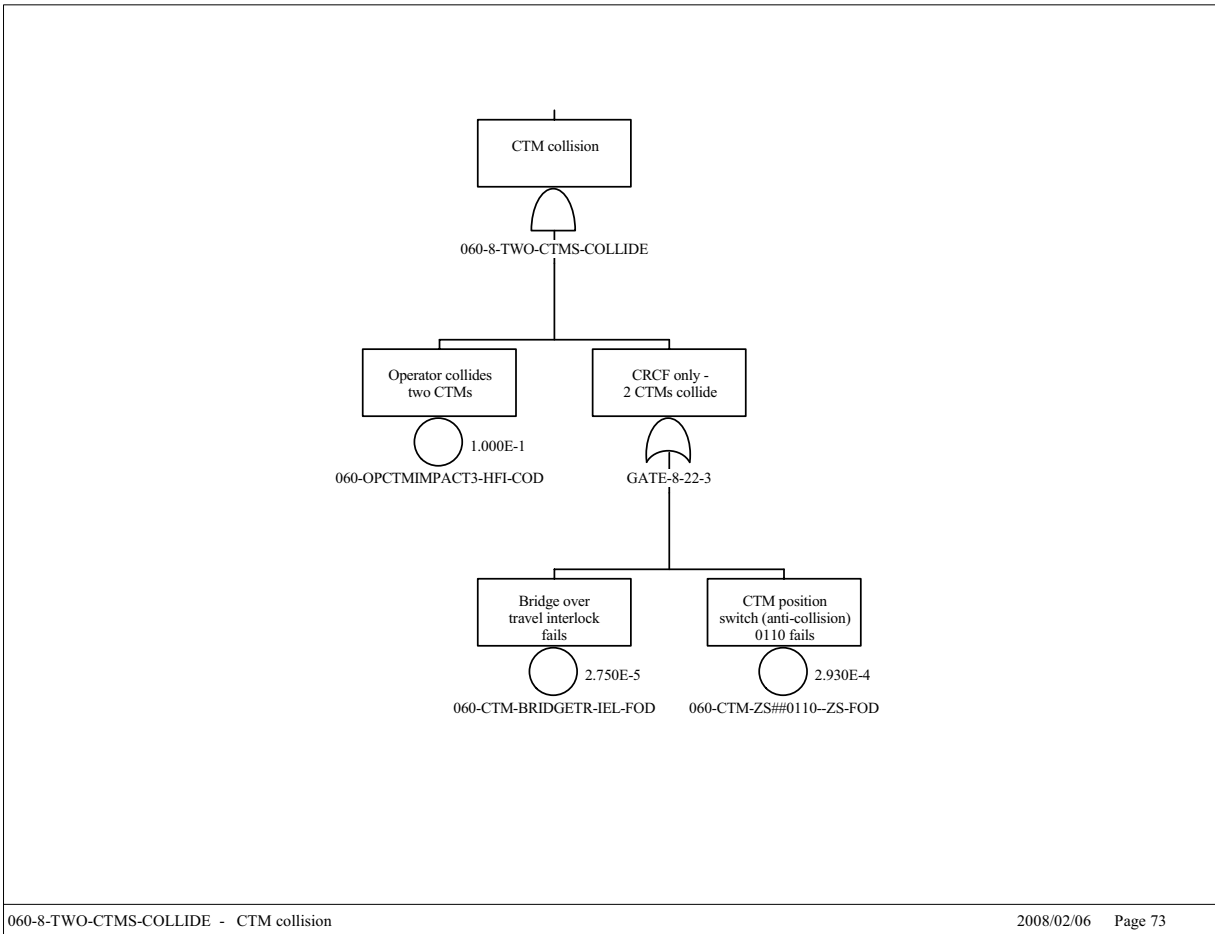

Source: Original

Figure B4.4-47. Collision Between Two CTMs Fault Tree

B5 WASTE PACKAGE TRANSFER TROLLEY FAULT TREE ANALYSIS

B5.1 REFERENCES

Design Inputs

The PCSA is based on a snapshot of the design. The reference design documents are appropriately documented as design inputs in this section. Since the safety analysis is based on a snapshot of the design, referencing subsequent revisions to the design documents (as described in EG-PRO-3DP-G04B-00037, *Calculations and Analyses* (Ref. 2.1.1, Section 3.2.2.F)) that implement PCSA requirements flowing from the safety analysis would not be appropriate for the purpose of the PCSA.

The inputs in this Section noted with an asterisk (*) indicate that they fall into one of the designated categories described in Section 4.1, relative to suitability for intended use.

- B5.1.1 *BSC (Bechtel SAIC Company) 2007. *CRCF and IHF WP XFR Carriage Docking Sta Process & Instrumentation Diagram*. 000-M60-HL00-00301-000 REV 00B. Las Vegas, Nevada: Bechtel SAIC Company. ACC: ENG.20071027.0014.
- B5.1.2 *BSC 2007. *CRCF-1 and IHF WP XFR Carriage Docking Sta Mechanical Equipment Envelope Plan, Elevation, & Section*. 000-MJ0-HL00-00201-000 REV 00B. Las Vegas, Nevada: Bechtel SAIC Company. ACC: ENG.20071027.0018.
- B5.1.3 BSC 2008. *Nuclear Facilities Slide Gate Process and Instrumentation Diagram*. 000-M60-H000-00201-000 REV 00E. Las Vegas, Nevada: Bechtel SAIC Company. ACC: ENG.2080123.0025.
- B5.1.4 BSC 2007. *CRCF and IHF WP Transfer Trolley Process & Instrumentation Diagram*. 000-M60-HL00-00201-000 REV 00B. Las Vegas, Nevada: Bechtel SAIC Company. ACC: ENG.20071027.0013.
- B5.1.5 *BSC 2007. *Preliminary Throughput Study for the Canister Receipt and Closure Facility*. 060-30R-CR00-00100-000-001. Las Vegas, Nevada: Bechtel SAIC Company. ACC: ENG.20071101.0001.
- B5.1.6 Not Used.
- B5.1.7 Not Used.
- B5.1.8 ASME NOG-1-2004. 2005. *Rules for Construction of Overhead and Gantry Cranes (Top Running Bridge, Multiple Girder)*. New York, New York: American Society of Mechanical Engineers. TIC: 257672. ISBN: 0-7918-2939-1.

- B5.1.9 BSC 2007. *Mechanical Handling Design Report – Waste Package Transfer Trolley*. 000-30R-WHS0-01200-000 REV 000. Las Vegas, Nevada: Bechtel SAIC Company. ACC: ENG.20071006.0001.
- B5.1.10 BSC 2008. *Waste Package Transfer Trolley Calculation*. 000-M0C-HL00-00100-000-00A. Las Vegas, Nevada: Bechtel SAIC Company. ACC: ENG.20080207.0002.

Design Constraints

B5.2 SYSTEM DESCRIPTION

B5.2.1 Overview

This system description is derived from *CRCF and IHF WP XFR Carriage Docking Sta Process & Instrumentation Diagram* (Ref. B5.1.1), *CRCF-1 and IHF WP XFR Carriage Docking Sta Mechanical Equipment Envelope Plan, Elevation, & Section* (Ref. B5.1.2), *CRCF and IHF WP Transfer Trolley Process & Instrumentation Diagram* (Ref. B5.1.4), *Mechanical Handling Design Report – Waste Package Transfer Trolley* (Ref. B5.1.9) and *Waste Package Transfer Trolley Calculation* (Ref. B5.1.10). The waste package transfer trolley (WPTT), shown in Figure B5.2-1 is an electrically powered machine that is used to transport the waste package containing various waste canisters from the Waste Package Loading Room to the Waste Package Closure Room and then to the Waste Package Loadout Room. The WPTT consists of the trolley and the shield enclosure that holds the waste package, waste package pallet, waste package transfer carriage, and pedestal. The shield enclosure acts to minimize radiation to the surroundings. The enclosure pivots between a vertical and horizontal position for waste package loading and unloading. The center of gravity of the shield enclosure is positioned such that the vertical position is the most stable position.

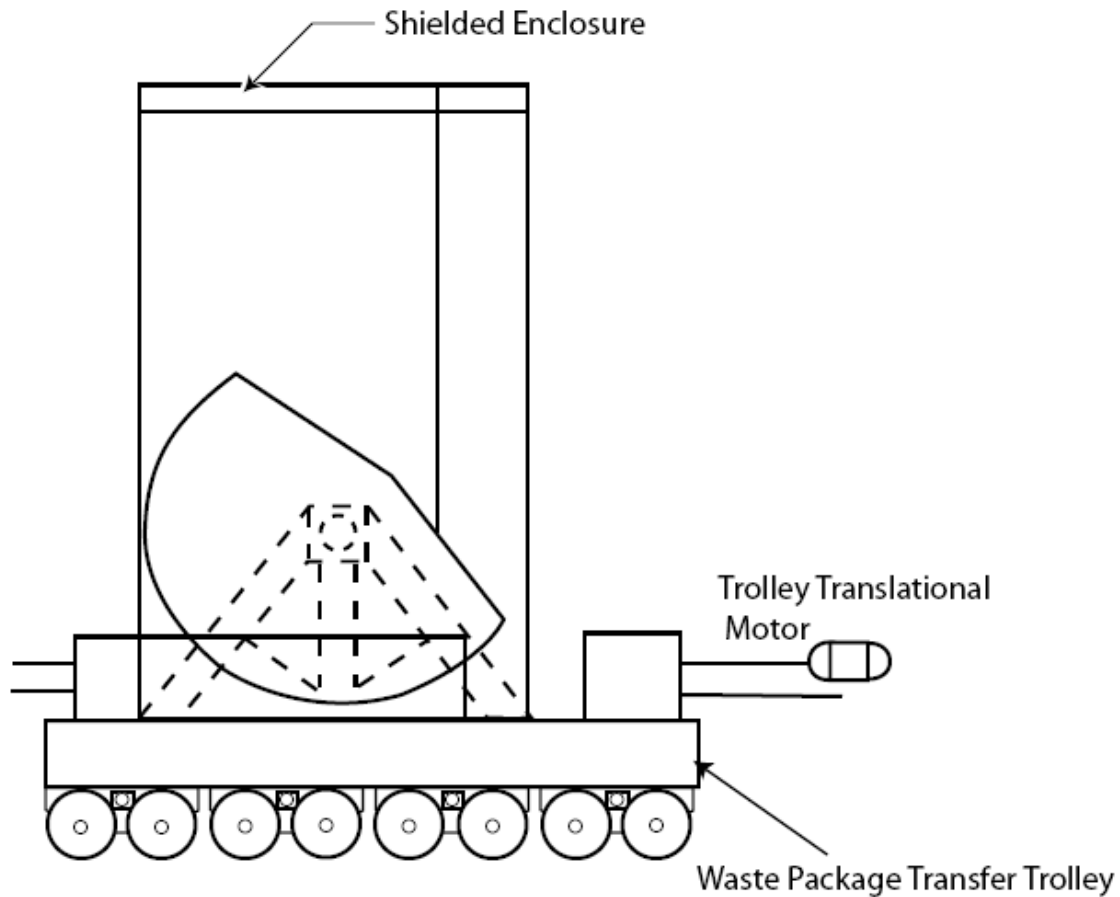

Source: Derived from Ref. B5.1.4.

Figure B5.2-1. Waste Package Transfer Trolley

The WPTT travels on rails between the Waste Package Loading Room and the docking station in the Waste Package Loadout Room using 24" double flange crane wheels. The total travel distance between these rooms is approximately 118 feet. Rail sweeps are used in front of each trolley wheel to brush away any object that might fall onto the trolley rails. The crane rails supporting the WPTT are gapped in multiple locations (as much as 16") to accommodate shield doors between rooms. Power is supplied to the motor by a third rail system and the maximum speed is less than 40 fpm (Ref. B5.1.9, Section 3.2.4) established by the size of the drive motor and the gear drive system. The WPTT includes seismic rail clamps and rails anchored to the floor to ensure the stability of the WPTT during a seismic event.

The rotation of the shield enclosure, which is also powered by the third rail system, is controlled by two rotation mechanisms, each consisting of a motor and a mechanical worm gear system. Each rotation mechanism is sized to rotate the full design load at a rate of 90-degrees per hour (Ref. B5.1.10, Section 6.15), and the worm gear mechanism has the inherent property to self lock to prevent uncontrolled tilt down. Within the shield enclosure is a pedestal where the waste

package sits during transfer operations and which allows the waste package to be at the correct height for loading and sealing operations. There are interchangeable pedestals of different sizes which are for the loading operations of different sized waste packages.

The motor power for the trolley and the shield enclosure is such that the canister cannot be breached through a shear failure in the event of spurious signals during canister transfer into the waste package. Either the drive train or rotational motors will trip off before the canister is breached.

The waste package transfer carriage shown in Figure B5.2-2 is a wheeled platform that carries the waste package pallet and waste package. The transfer carriage is moved by a mechanical screw driven carriage retrieval assembly which places the carriage with an empty waste package in the shield enclosure and retrieves the carriage with a loaded waste package in the Waste Package Loadout Room after the waste package has been loaded and sealed. Once removed from the shield enclosure the transport and emplacement vehicle (TEV) is able to pick up the loaded waste package and pallet by lifting features on the waste package pallet.

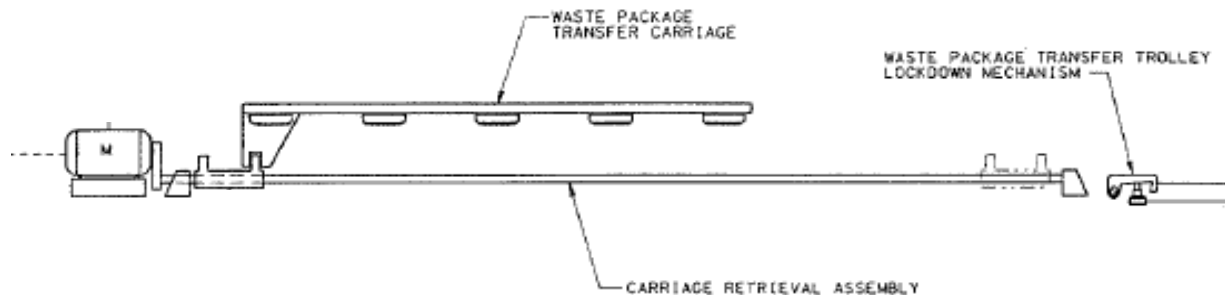

NOTE: Legibility of figure does not affect technical content of the document. Details are found in the source document.

Source: Derived from Ref. B5.1.1.

Figure B5.2-2. Waste Package Transfer Carriage

B5.2.2 Control System

Interlocks prevent translational or rotational motion of the WPTT while a canister is being loaded into the waste package (i.e., when the waste package slide gate is open) or while the waste package is being withdrawn from the shield enclosure on the transfer carriage (Ref. B5.1.1, Ref. B5.1.3, and Ref. B5.1.4). The shield enclosure is not able to rotate in either direction unless the WPTT is locked into the waste package transfer carriage docking station and the waste package carriage retrieval assembly is completely extended or retracted. Interlocks also prevent over-travel of the trolley and travel through portals when the shield doors are closed. Manually actuated, hardwired emergency stop buttons are available at all control locations to allow power to be removed from the drive motors. However, because the emergency stop function is a recovery action performed by the operator and requires operator intervention, these

functions were not modeled in the analysis. A schematic of the control system and interlocks is shown in Figure B5.2-3.

The following controls are incorporated in the design of the rotation mechanism of the shield enclosure:

- Rotation start and stop
- End of travel limit switches
- Motor amperage readout
- Interlocks to prevent movement of the shielded enclosure unless the trolley is locked down at the docking station and the waste package carriage retrieval assembly is completely extended or retracted.

The following controls are provided for operation of the trolley system:

- Trolley start (forward and reverse) and stop
- Forward and reverse, end of travel limit switches
- Motor amperage readout
- Forward and reverse range detectors, interlocked with the motors through a PLC
- Interlock to prevent movement of the trolley when the waste package slide gate is opened
- Position indication along the travel rail.

The following controls are provided for operation of the docking station system:

- waste package retrieval system start (forward and reverse) and stop
- Raise and lower motions for the WPTT locking mechanisms
- Interlock between the locking mechanisms and the shield enclosure to prevent unlocking the trolley from the docking station unless the enclosure is in the vertical position
- Interlock between the retrieval system and the power feed to the WPTT to prevent operation of the WPTT during waste package retrieval
- Motor amperage readout
- Position indication of the waste package as it is being retrieved from the WPTT.

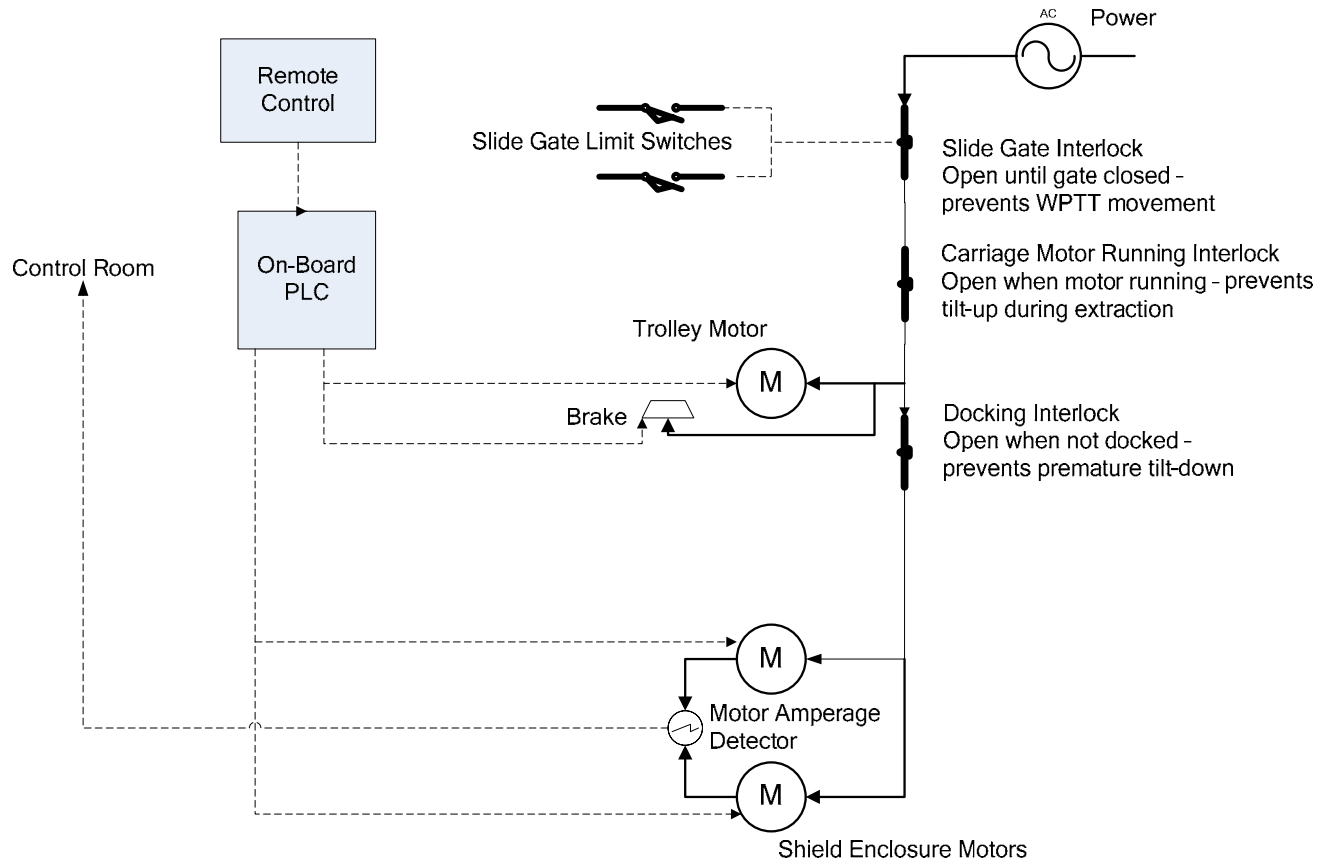

NOTE: AC = alternating current; M = motor; PLC – programmable logic controller; WPTT = waste package transfer trolley.

Source: Original

Figure B5.2-3. Schematic of the Waste Package Transfer Trolley Control System

B5.2.3 Initial Conditions

The waste package loadout operation begins with an empty waste package being loaded into the WPTT on the pallet while the WPTT is locked into the waste package transfer carriage docking station and in the horizontal position. The transfer carriage with an empty waste package and pallet is moved into the shield enclosure of the WPTT via the waste package transfer carriage docking station's waste package retrieval assembly. Once the retrieval assembly is fully extended and the carriage and empty waste package are positioned within the WPTT, the shield enclosure is rotated into the vertical position. A visual inspection of the waste package is then performed to ensure the positioning is correct within the shield enclosure. When the waste package is correctly placed in the vertically oriented shield enclosure the shield ring is lowered and locked into position on top of the shield enclosure by the waste package handling crane equipped with the shield ring lift beam. Again, a visual inspection is performed to ensure the shield ring is properly seated.

The WPTT is unlocked from the waste package transfer carriage docking station and is remotely driven into the Waste Package Loadout Room. The WPTT is situated so that the empty waste package is directly beneath the center of the slide gate which separates the Waste Package Loadout Room and Canister Transfer Room.

B5.2.4 Waste Package Loading

Once in position in the loadout room the slide gate is opened to allow the waste canister(s) to be lowered into the empty waste package using the canister transfer machine (CTM). The waste is contained in canisters during the entire process; these canisters are either: transport, aging, and disposal (TAD) canisters (CRCF only), Department of Energy (DOE) Standard canisters (CRCF only), HLW canisters, or naval canisters (IHF only).

B5.2.5 Waste Package Transfer

After the waste package is loaded and the slide gate closed, an operator in the control room provides power to the WPTT to move it to the Waste Package Positioning Room.

B5.2.6 Waste Package Closure

After the waste package is loaded and the slide gate closed, the WPTT moves to the Waste Package Positioning Room. The WPTT is positioned under the opening to the Waste Package Closure Room so that the top of the waste package is accessible through the opening. At this station, the inner lid is placed on the waste package, welded in place, and the weld's integrity inspected. The air within the waste package is replaced by helium with a helium purging operation. Once the inner lid is inspected for leakage, the outer lid is positioned and welded in place. The welds of the outer lid are inspected to ensure the waste package is properly sealed.

B5.2.7 Waste Package Transfer Trolley Loadout

After the waste package is sealed, the WPTT is moved into the Waste Package Loadout Room where it is locked into the waste package transfer carriage docking station. The shield ring is remotely removed with the waste package handling crane, and the shield enclosure is rotated into

the horizontal position. The waste package carriage retrieval assembly engages the carriage interface and retracts guiding the carriage and waste package out of the shield enclosure. During the transfer from the WPTT to the TEV, video cameras allow operators to inspect the waste package surface for damage. The waste package is positioned such that the TEV is able to lift the waste package and pallet off the carriage. From here, the TEV transports the waste package into the repository for emplacement.

Upon the WPTT reaching the loadout area, the TEV is in place and the carriage retrieval assembly is completely retracted. The WPTT links to the docking mechanism of the waste package retrieval system closing an interlock and allowing the shield enclosure to be rotated to the horizontal position. The retrieval system links with the carriage assembly within the shield enclosure. During extraction of the waste package carriage an interlock interrupts the power feed to the WPTT to prevent operation of the WPTT during the retrieval operation. When the carriage retrieval system is fully retracted the waste package has been removed from the shield enclosure, an interlock is closed, and the shield enclosure can now be raised to the vertical position. When the enclosure is vertical, the trolley can be unlocked from the docking station and moved back.

B5.3 DEPENDENCIES AND INTERACTIONS ANALYSIS

Dependencies are broken down into five categories with respect to their interactions with structures, systems, and components. The five areas considered are addressed in Table B5.3-1 with the following dependencies:

1. Functional dependence.
2. Environmental dependence.
3. Spatial dependence.
4. Human dependence.
5. Failures based on external events.

Table B5.3-1. Dependencies and Interactions Analysis

Structures, Systems, and Components	Dependencies & Interactions				
	Functional	Environmental	Spatial	Human	External Events
Electric power	Provides motive force	—	—	—	—
Trolley motor and gear drive	Limits maximum speed	—	—	—	—
Shield enclosure motor and gear drive	Limits rotational speed and prevents slapdown	—	—	—	—
Interlocks	Prevents spurious movement	—	—	—	Fire or explosion can cause loss of power
Rails	Prevents movement in wrong direction	—	—	—	—
Control room	Controls direction and speed and initiates movement	—	—	Wrong instructions	Fire or explosion can cause loss of power
Emergency Stop	Stops WPTT	—	—	Fail to energize	
Structure	Constrains and supports canisters and WP	—	—	—	Seismic causes impact
Shield door	Opens for WPTT to pass through	—	—	Close door inadvertently	Closes on WPTT

NOTE: WPTT = waste package transfer trolley.

Source: Original

B5.4 RELATED FAILURE SCENARIOS

There are five fault trees associated with the WPTT:

1. Spurious movement of the WPTT in the loading area while loading the waste package with canisters—while loading a cask onto the WPTT, and spurious movement into the Waste Package Loadout Room while extracting the waste package carriage from the shield enclosure.
2. Impact of the WPTT with a structure—while moving from the Waste Package Loading Room to the Waste Package Positioning Room and then to the Waste Package Loadout Room.
3. Derailment of the WPTT—while moving from the Waste Package Loading Room to the Waste Package Positioning Room and then to the Waste Package Loadout Room.

4. Premature tiltdown of the WPTT—premature tiltdown of the shield enclosure while moving from the Waste Package Loading Room to the Waste Package Positioning Room and then to the Waste Package Loadout Room.
5. Malfunction of WPTT or waste package transfer carriage—while extracting the carriage and waste package from the shield enclosure at the Waste Package Loadout Room.

An additional fault tree associated with damage to the waste package at the positioning and closure area satisfies ESD-09 and is also described in Attachment A and B9. These fault trees involve waste package failure due to the welding process or drop of an object on the WP.

In all cases a conservative mission time of 1 hour per canister was used for canister and waste package transfers through the process for each fault tree. The time required to lower a canister into the waste package by the CTM is approximately 20 minutes, the time required to move the trolley from the loading area to the positioning area and then to the Waste Package Loadout Room is approximately 35 minutes, and the time required to extract the carriage from the shield enclosure is approximately 15 minutes (Ref. B5.1.5, Appendix A). Therefore, a one hour mission time is considered a conservative value.

Although the time in the Waste Package Closure Room is approximately 40 hours, there are no failures that would damage the canister in this area.

B5.4.1 Spurious Movement of the WPTT in the Loading Area While Loading the Waste Package with Canisters

B5.4.1.1 Description

This fault tree describes spurious movement of the WPTT during canister loading of the waste package to satisfy ESD-09, pivotal event “Spurious Movement of CTT, WPTT, CTM During Transfer.” The top event is “Spurious Movement of the WPTT During Loading” which is defined as unplanned movement of the WPTT while canisters are being loaded into the waste package. This fault tree is shown in Figures B5.4-3, B5.4-4, B5.4-5, and B5.4-6.

Spurious movement may involve movement of the trolley or the shield enclosure and may be caused by multiple equipment failures, or by a combination of equipment failure and operator error. For equipment failures to cause spurious movement, the controls (remote or on-board) must emit a spurious signal, and the gate interlocks must fail for trolley movement, or the gate and docking interlocks must fail for shield enclosure movement. For the operator to initiate spurious movement, the interlocks must fail as described above for the trolley or shield enclosure to move.

B5.4.1.2 Success Criteria

Success criteria for loading a canister onto the shield enclosure on the WPTT at the loading area require that the WPTT remain stationary during these operations. Interlocks prevent rotational movement of the shield enclosure unless the trolley is locked down at the docking station in the

Waste Package Loadout Room, and port slide gate interlocks interrupt all power to the WPTT to prevent any movement of the trolley or shield enclosure when the slide gate is opened.

B5.4.1.3 Design Requirements and Features

Design features include the interlock that interrupts all power to the WPTT when it is in the loading area, and the slide gate interlocks that interrupt all power to the WPTT while the slide gate is open during the canister loading process. The docking interlock is another feature that prevents rotation of the shield enclosure unless the WPTT is at the docking station in the Waste Package Loadout Room.

Requirements include sizing of the motor and gearing system such that the canister cannot be breached through a shear failure in the event of spurious signals during canister transfer into the waste package. Either the drive train or rotational motors must trip before the canister is breached

B5.4.1.4 Fault Tree Model

The top event in Figure B5.4-3 is spurious movement of the WPTT during the canister loading process. This may occur due to initiation of a spurious signal due to equipment failure or operator error coupled with the failure of an interlock that interrupts all power to the WPTT while the WPTT is in the loading position. Power can be provided to the WPTT only through operator action to reset the interlock after loading is completed.

Spurious movement due to equipment failure, shown in Figures B5.4-3 and B5.4-4, may occur from initiation of spurious signals from the control system and failure of the gate and docking interlocks. Failure modes of the gate interlocks are shown in Figure B5.4-6.

B5.4.1.5 Basic Events

Basic events for “Spurious Movement of the WPTT During Loading” are shown in Table B5.4-2.

Table B5.4-2. Basic Event Probabilities for Spurious Movement of the WPTT During Loading

Name	Calc. Type ^a	Calc. Prob.	Fail. Prob.	Lambda	Miss. Time ^a
060-GATE-IEL001--IEL-FOD	1	2.750E-005	2.750E-005	0.000E+000	0.000E+000
060-GATE-ZS000—ZS--CCF	1	1.380E-005	5.080E-005	0.000E+000	0.000E+000
060-GATE-ZS001—ZS--FOD	1	2.930E-004	2.930E-004	0.000E+000	0.000E+000
060-GATE-ZS002—ZS--FOD	1	2.930E-004	2.930E-004	0.000E+000	0.000E+000
060-OPTILTDOWN01-HFI-NOD	1	1.000E+000	1.000E+000	0.000E+000	0.000E+000
060-PWRPRTGATINT-IEL-FOD	1	2.740E-005	2.740E-005	0.000E+000	0.000E+000
060-WPTT-HC001—HC--SPO	3	5.230E-007	0.000E+000	5.230E-007	1.000E+000
060-WPTT-HC002—HC--SPO	3	5.230E-007	0.000E+000	5.230E-007	1.000E+000
060-WPTT-IELDK3--IEL-FOD	1	2.750E-005	2.750E-005	0.000E+000	0.000E+000
060-WPTT-PLC001--PLC-SPO	3	3.650E-007	0.000E+000	3.650E-007	1.000E+000
060-WPTT-PLC002--PLC-SPO	3	3.650E-007	0.000E+000	3.650E-007	1.000E+000
060-OPWPTTSPUR01-HFI-NOD	1	1.000E-003	1.000E-003	0.000E+000	0.000E+000

NOTE: ^a For Calc. Type 3 with a mission time of 0, SAPHIRE performs the quantification using the system mission time.

Calc. = calculation; Fail. = failure; Miss. = mission; Prob. = probability.

Source: Original

B5.4.1.5.1 Human Failure Events

Two operator errors involve initiation of spurious movement of the trolley 060-OPWPTTSPUR01-HFI-NOD or shield enclosure 060-OPTILTDOWN01-HFI-NOD which involves initiation of a tiltdown.

B5.4.1.5.2 Common-Cause Failure

One common-cause failure (CCF) was added to the tree to account for failure of both gate closed limit switches. An alpha factor of 0.047 was used to determine the common-cause value using two of two as the failure criteria (Table C3-1, CCCG = 2).

B5.4.1.6 Uncertainty and Cut Set Generation

Figure B5.4-1 contains the uncertainty results obtained from running the fault trees for “Spurious Movement of the WPTT in the Loading Area While Loading the Waste Package with Canisters” using a cutoff probability of 1E-15. Figure B5.4-2 provides the cut set generation results for “Spurious Movement of the WPTT in the Loading Area While Loading the Waste Package with Canisters”.

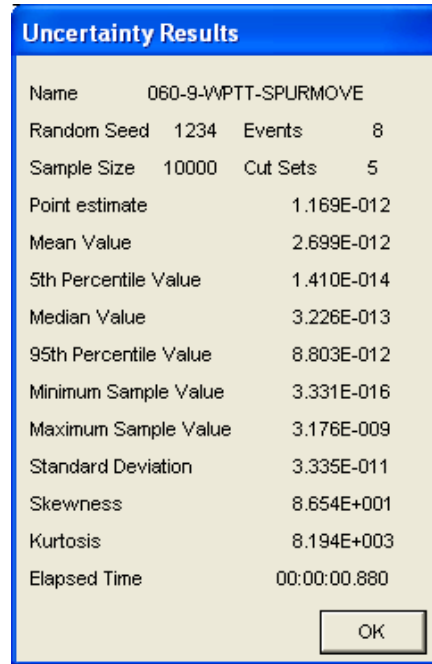

Source: Original

Figure B5.4-1. Uncertainty Results for Spurious Movement of the WPTT in the Loading Area While Loading the Waste Package with Canisters Fault Tree

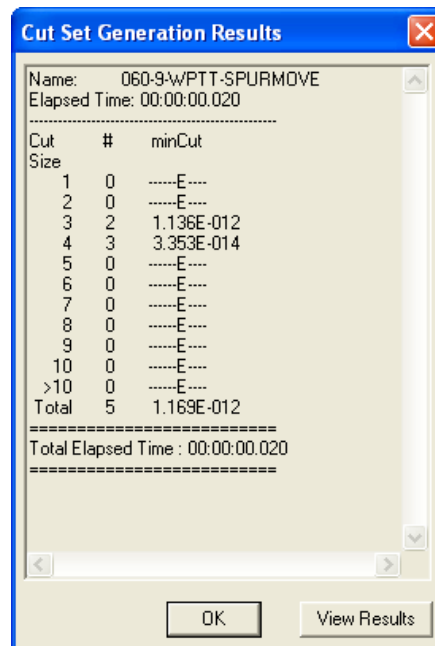

Source: Original

Figure B5.4-2. Cut Set Generation Results for Spurious Movement of the WPTT in the Loading Area While Loading the Waste Package with Canisters Fault Tree

B5.4.1.7 Cut Sets

Table B5.4-3 contains the cut sets for “Spurious Movement of the WPTT in the Loading Area While Loading the Waste Package with Canisters”. The total probability per cask loading is 1.17E -12.

Table B5.4-3. Cut Sets for the Spurious Movement of the WPTT in the Loading Area While Loading the Waste Package with Canisters Fault Tree

Fault Tree	Cut Set %	Prob./Freq.	Basic Event	Description	Probability
060-9-WPTT-SPURMOVE	64.68	7.563E-013	060-GATE-IEL001--IEL-FOD	Interlock Failure on Demand	2.8E-005
			060-OPWPTTSPUR01-HFI-NOD	Operator Initiates Spurious Movement of Trolley	1.0E-003
			060-PWRPRTGATINT-IEL-FOD	Power to WPTT Interruption Interlock Fails	2.8E-005
	32.46	3.795E-013	060-GATE-ZS000---ZS--CCF	CCF of Gate Closed Limit Switches	1.4E-005
			060-OPWPTTSPUR01-HFI-NOD	Operator Initiates Spurious Movement of Trolley	1.0E-003
			060-PWRPRTGATINT-IEL-FOD	Power to WPTT Interruption Interlock Fails	2.8E-005
	1.78	2.080E-014	060-GATE-IEL001--IEL-FOD	Interlock Failure on Demand	2.8E-005
			060-OPTILTDOWN01-HFI-NOD	Operator Initiates Spurious Movement of Shield Enc	1.0E+000
			060-PWRPRTGATINT-IEL-FOD	Power to WPTT Interruption Interlock Fails	2.8E-005
			060-WPTT-IELDK3--IEL-FOD	WPTT Dock Interlock Fails	2.8E-005
	0.89	1.044E-014	060-GATE-ZS000---ZS--CCF	CCF of Gate Closed Limit Switches	1.4E-005
			060-OPTILTDOWN01-HFI-NOD	Operator Initiates Spurious Movement of Shield Enc	1.0E+000
			060-PWRPRTGATINT-IEL-FOD	Power to WPTT Interruption Interlock Fails	2.8E-005
			060-WPTT-IELDK3--IEL-FOD	WPTT Dock Interlock Fails	2.8E-005
	0.20	2.361E-015	060-GATE-ZS001---ZS--FOD	Gate Closed Limit Switch #1 Spurious Transfer	2.9E-004
			060-GATE-ZS002---ZS--FOD	Gate Closed Limit Switch #2 Spurious Transfer	2.9E-004

Table B5.4-3. Cut Sets for the Spurious Movement of the WPTT in the Loading Area While Loading the Waste Package with Canisters Fault Tree (Continued)

Fault Tree	Cut Set %	Prob./Freq.	Basic Event	Description	Probability
			060-OPWPTTSPUR01-HFI-NOD	Operator Initiates Spurious Movement of Trolley	1.0E-003
			060-PWRPRTGATINT-IEL-FOD	Power to WPTT Interruption Interlock Fails	2.8E-005
		1.169E-012	= Total		

NOTE: CCF = common-cause failure; enc = enclosure; Freq. = frequency; Prob. = probability; WPTT = waste package transfer trolley.

Source: Original

B5.4.1.8 Fault Tree

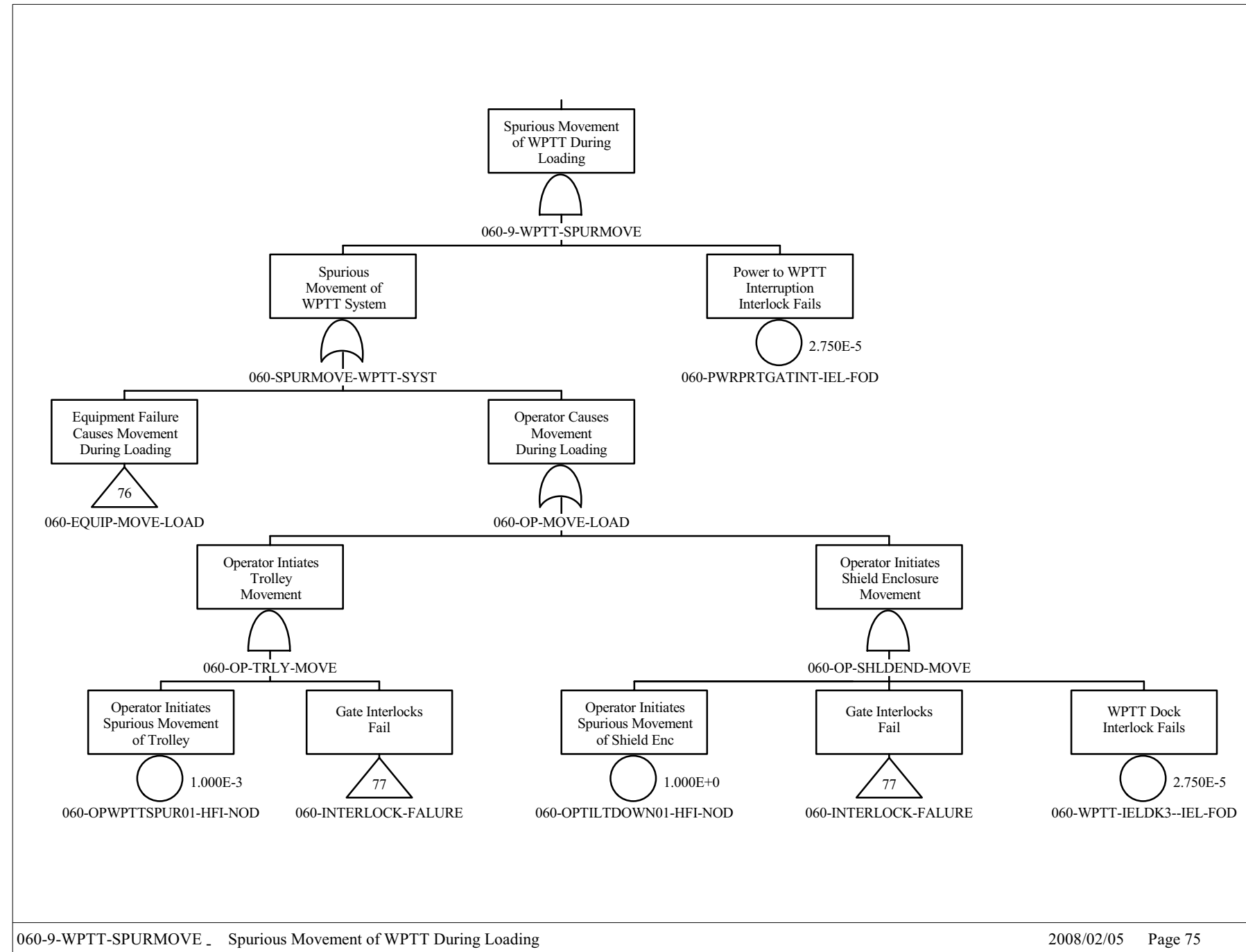

Source: Original

Figure B5.4-3. Fault Tree for Spurious Movement of the WPTT During Canister Loading

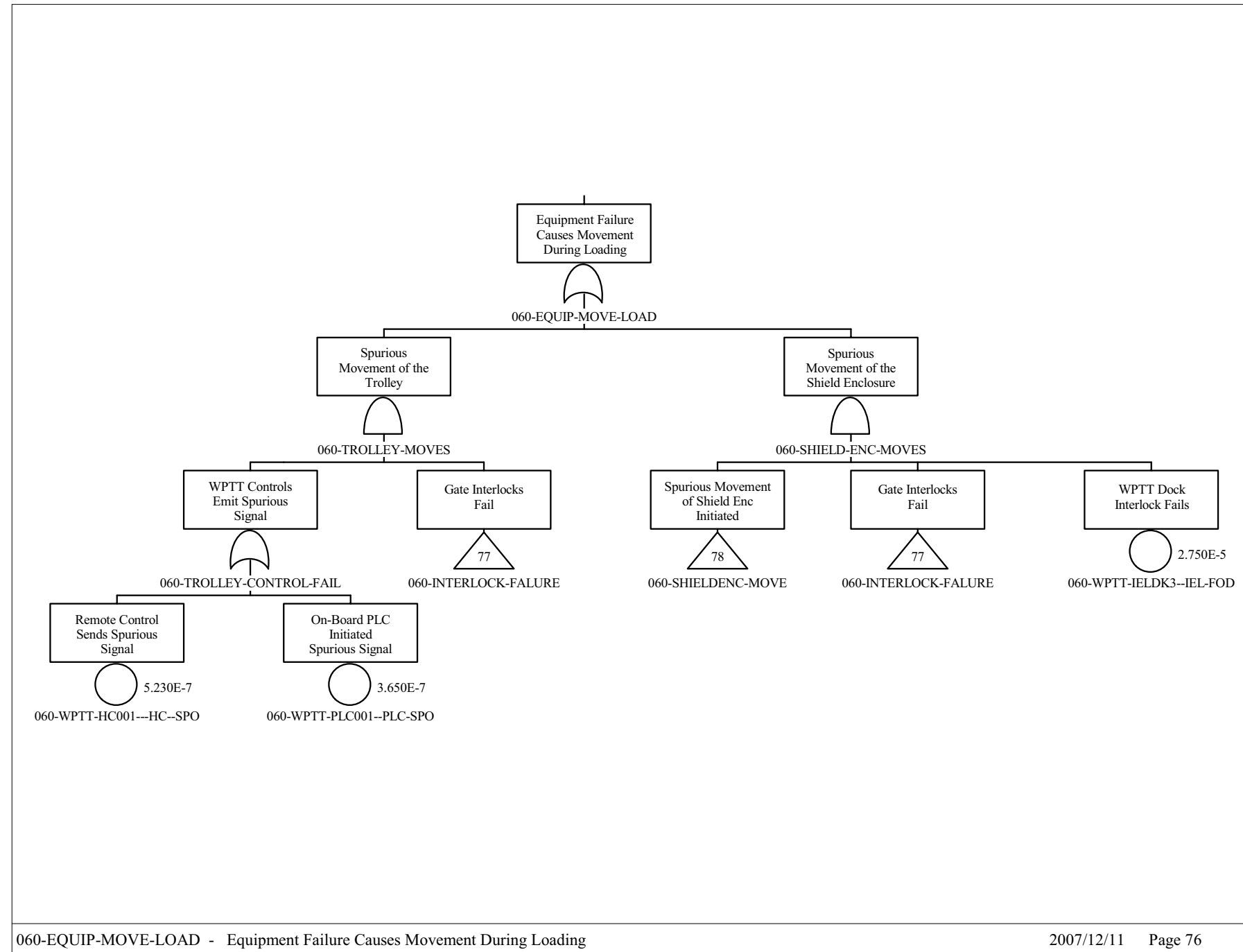

Source: Original

Figure B5.4-4. Fault Tree for Spurious Movement of the WPTT in the Loading Area While Loading the Waste Package with Canisters (Continued)

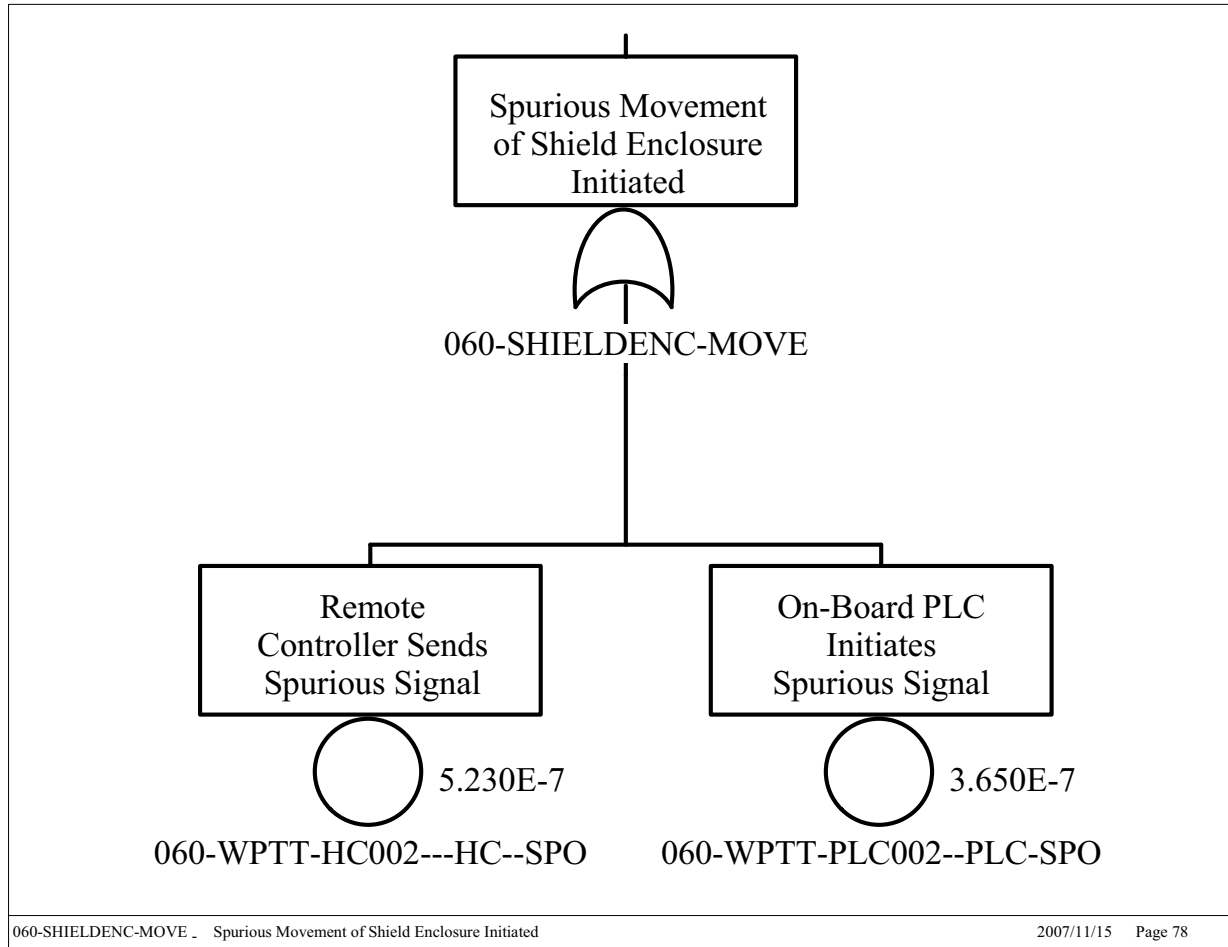

Source: Original

Figure B5.4-5. Fault Tree for Spurious Movement of the WPTT in the Loading Area While Loading the Waste Package with Canisters (Continued)

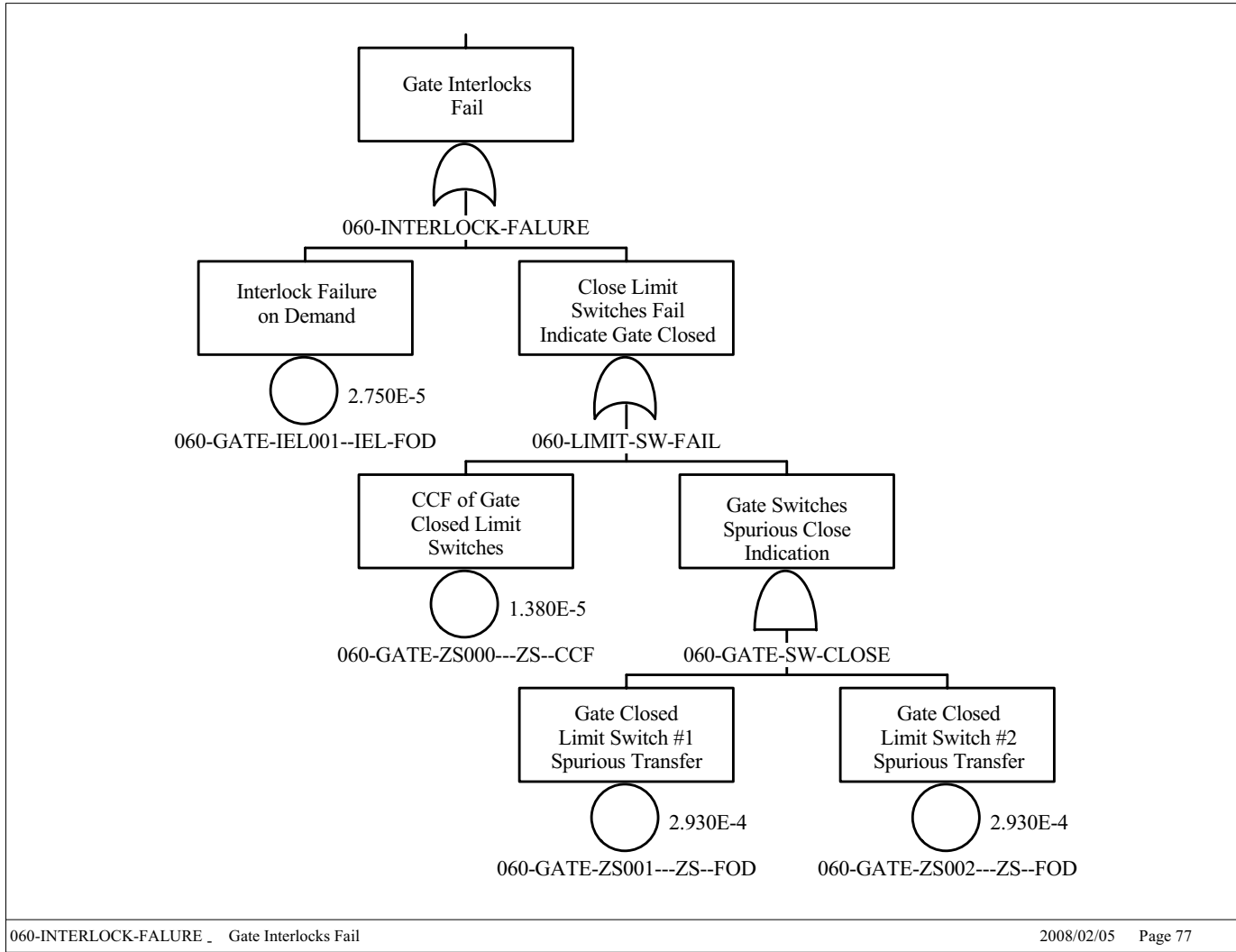

B5-19

Source: Original

Figure B5.4-6. Fault Tree for Spurious Movement of the WPTT in the Loading Area While Loading the Waste Package with Canisters (Continued)

March 2008

B5.4.2 Impact of the WPTT with a Structure

B5.4.2.1 Description

This fault tree considers the potential for the WPTT to collide with a structure or object while moving the waste package from the loading area to the positioning area to satisfy ESD-10, pivotal event “Collision of WPTT with Facility, Structure or Equipment.” The top event is “Impact of WPTT with Structure.” This fault tree is shown in Figures B5.4-9 and B5.4-10.

The same fault considers the potential for the WPTT to collide into a structure or object while moving the waste package from the Waste Package Positioning Room (or Waste Package Closure Room) to the docking station to satisfy ESD-13, pivotal event “WPTT Collision.”

Two primary causes of a collision are operator initiated (possibly through inattention), or failure of the WPTT to stop. Movement in the wrong direction as a contributing factor is negated by the use of rails forcing the WPTT to only move forward and backward. A runaway condition is prevented by the sizing of the electrical motor and drive gears to limit the speed to less than 40 fpm.

Failure to stop requires failure of the brake or failure of the motor to shut off. The emergency stop buttons in the control room must also fail; however, because these are recovery actions to be taken by the operator the emergency stop functions are not credited in the fault tree.

B5.4.2.2 Success Criteria

Success criteria for moving the WPTT with a waste package from the loading area to the Waste Package Positioning Room and then to the Waste Package Loadout Room requires the WPTT travel at a speed no greater than 40 fpm and the operator be in control and able to stop the WPTT as required. The WPTT is stopped to prevent a collision into a closed shield door or other object by the operator speed controls in the control room, or by the emergency stop buttons in the control room that remove power to the WPTT. When moving the waste package between the loading area and the Waste Package Loadout Room, movement in the wrong direction is prevented by the rails on which the WPTT travels. This forces the WPTT to move only in a straight line, forward and backward between the two areas. Runaway of the WPTT is prevented by the limited motor power and gear drive system such that the maximum speed allowable is less than 40 fpm.

B5.4.2.3 Design Requirements and Features

The design feature is the size of the motor that limits the speed of the WPTT to 40 fpm. The requirement is that the speed of the WPTT does not exceed 40 fpm.

B5.4.2.4 Fault Tree Model

The fault tree is shown in Figures B5.4-9 and B5.4-10. The top event is “Impact of the WPTT with a Structure” and may be caused by operator error or failure to stop. Failure to stop may be caused by equipment failure shown in Figure B5.4-10.

B5.4.2.5 Basic Event Data

Table B5.4-4 contains a list of basic events used in the fault tree for impact of the WPTT with a structure while moving the waste package from the loading area to the Waste Package Loadout Room.

Table B5.4-4. Basic Event Probabilities for Impact of the WPTT with a Structure

Name	Calc. Type ^a	Calc. Prob.	Fail. Prob.	Lambda	Miss. Time ^a
060-OPWPCOLLIDE1-HFI-NOD	1	3.000E-003	3.000E-003	0.000E+000	0.000E+000
060-WPTT-BRK401--BRK-FOD	1	1.460E-006	1.460E-006	0.000E+000	0.000E+000
060-WPTT-MOE001-MOE-FSO	3	1.350E-008	0.000E+000	1.350E-008	1.000E+000

NOTE: ^a For Calc. Type 3 with a mission time of 0, SAPHIRE performs the quantification using the system mission time.

Calc. = calculation; Fail. = failure; Miss. = mission; Prob. = probability.

Source: Original

B5.4.2.5.1 Human Failure Events

One operator error (060-OPWPCOLLIDE1-HFI-NOD) involves causing a collision of the WPTT.

B5.4.2.5.2 Common-cause Failures

There are no common-cause failures.

B5.4.2.6 Uncertainty and Cut Set Generation

Figure B5.4-7 contains the uncertainty results for “Impact of the WPTT with a Structure” using a cutoff probability of 1E-12. Figure B5.4-8 provides the cut set generation results for “Impact of the WPTT with a Structure” during movement fault tree.

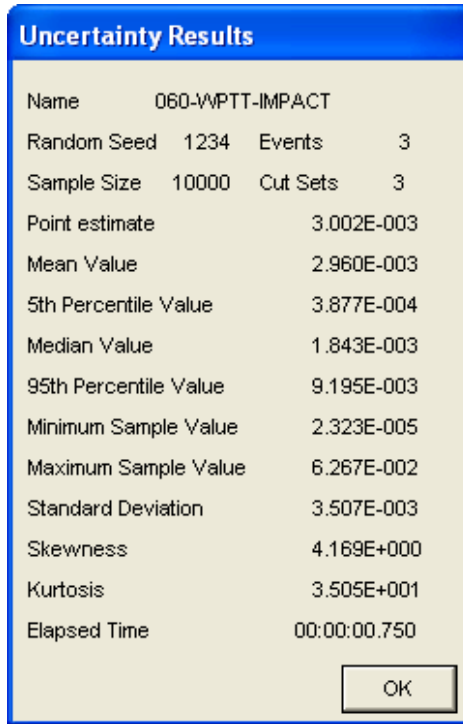

Source: Original

Figure B5.4-7. Uncertainty Results for the Impact of the WPTT with a Structure Fault Tree

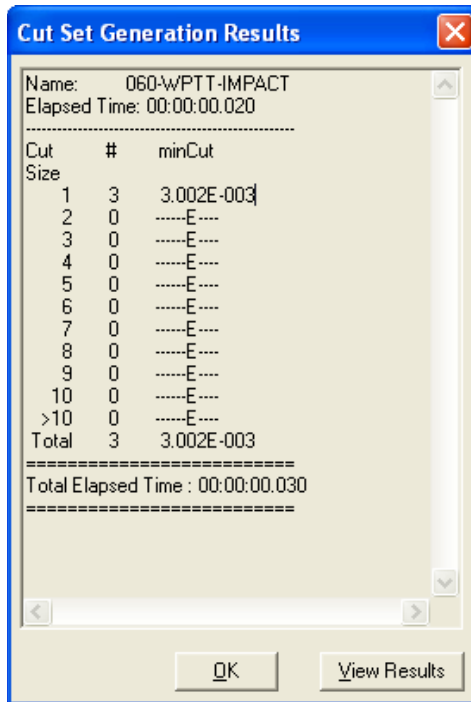

Source: Original

Figure B5.4-8. Cut Set Generation Results for Impact of the WPTT with a Structure Fault Tree

B5.4.2.7 Cut Sets

Table B5.4-5 contains the cut sets for “Impact of the WPTT with a Structure”. The total probability per cask is 3.002E-003 with operator error the dominant cause of collision.

Table B5.4-5. Cut Sets for Impact of the WPTT with a Structure Fault Tree

Fault Tree	Cut Set %	Prob./Freq.	Basic Event	Description	Probability
060-WPTT-IMPACT	99.95	3.000E-003	060-OPWPCOLLIDE1-HFI-NOD	Operator Causes Collision	3.0E-003
	0.05	1.460E-006	060-WPTT-BRK401--BRK-FOD	Brake Failure on Demand	1.5E-006
	0.00	1.350E-008	060-WPTT-MOE001-MOE-FSO	Motor (Electric) Fails to Shut Off	1.4E-008
		3.002E-003	= Total		

NOTE: Freq. = frequency; Prob. = probability.

Source: Original

B5.4.2.8 Fault Trees

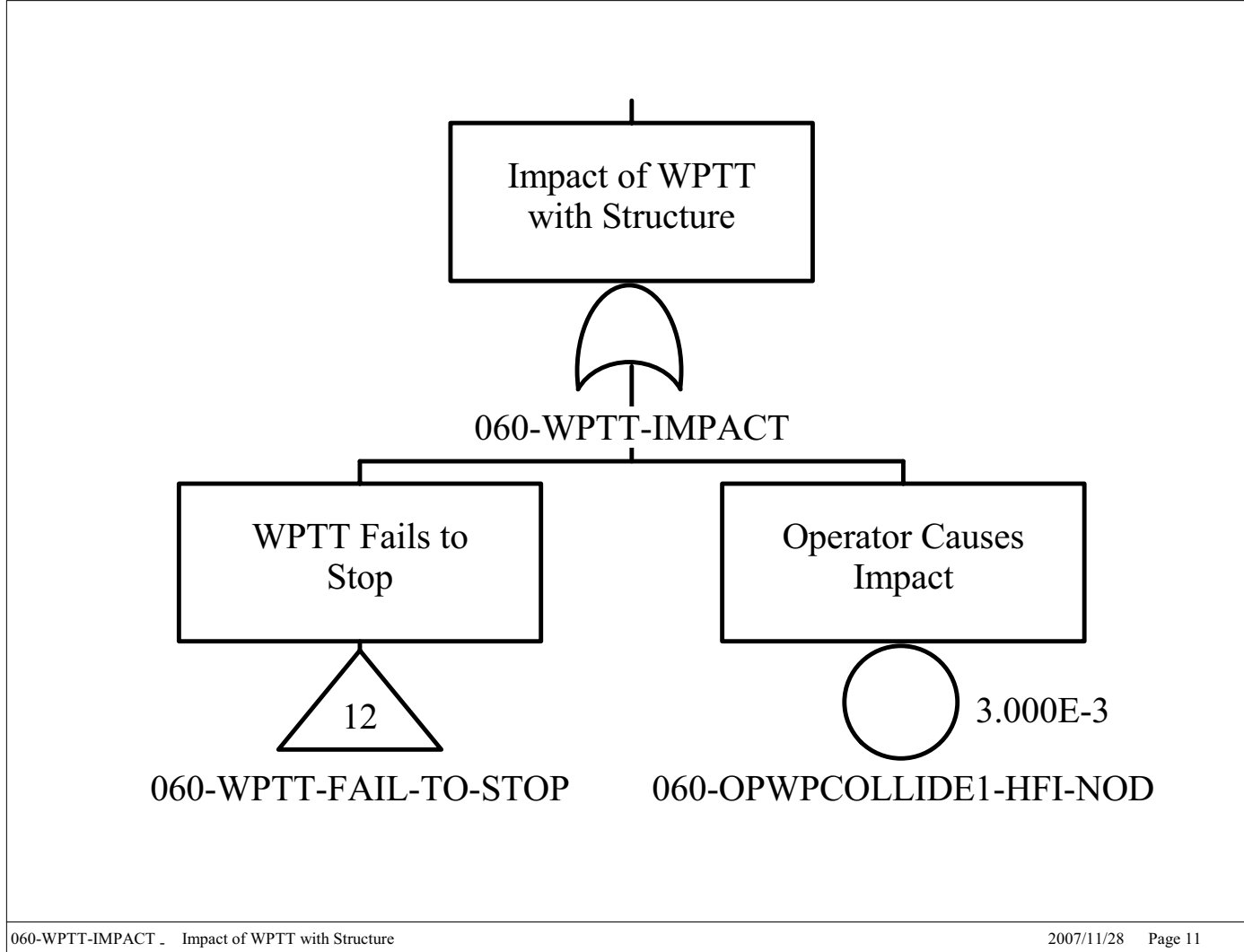

B5-24

March 2008

Source: Original

Figure B5.4-9. Fault Tree for Impact of the WPTT with a Structure during Waste Package Transfer

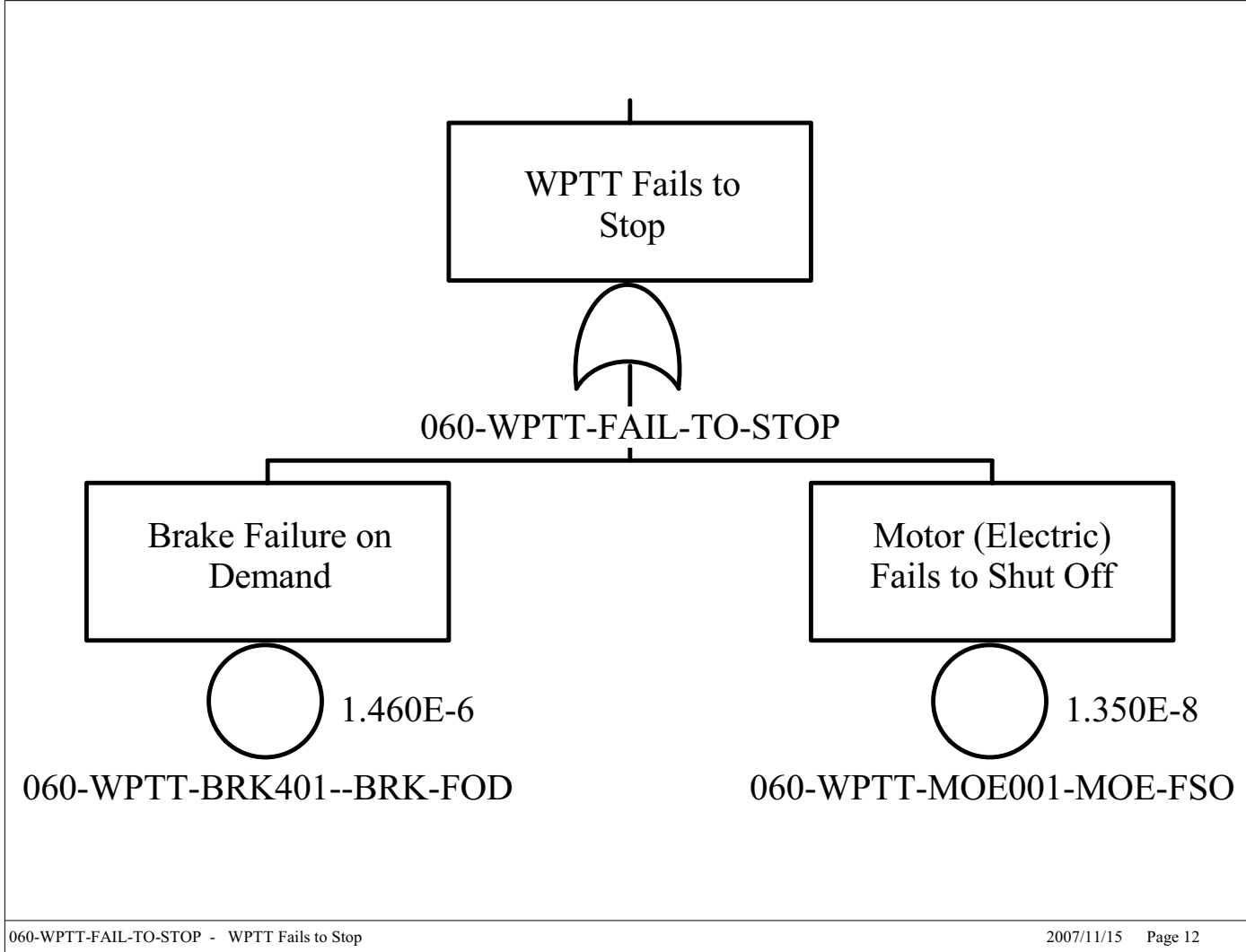

B5-25

March 2008

Source: Original

Figure B5.4-10. Fault Tree for Impact of the WPTT with a Structure during Waste Package Transfer (Continued)

B5.4.3 Derailment of the Waste Package Transfer Trolley

B5.4.3.1 Description

This fault tree considers the potential for the WPTT to derail during movement from the loading area to the Waste Package Positioning Room (ESD-10) and during movement from the Waste Package Positioning Room (or Waste Package Closure Room) to the docking station (ESD-13). For both ESDs, the pivotal event is “Derailment of WPTT.” The top event is “WPTT Derails.” This fault tree is shown in Figure B5.4-13.

The probability of derailment is based on historical data for train derailment at low speeds and is discussed in the section on data development. The probability of derailment per mile is multiplied by the number of miles the WPTT travels from the loading area to the Waste Package Loadout Room (approximately 4E-2 miles).

B5.4.3.2 Success Criteria

The success criterion is that the WPTT does not derail during the transport process.

B5.4.3.3 Design Features and Requirements

There are no design features or requirements.

B5.4.3.4 Fault Tree Model

The fault tree model is shown in Figure B5.4-13 with “Derailment of the WPTT” as the top event.

B5.4.3.5 Basic Event Data

Table B5.4-6 contains a list of basic events used in the “Derailment of the WPTT” fault tree.

Table B5.4-6. Basic Event Probabilities for Derailment of the WPTT During Waste Package Transfer

Name	Fail. Type ^a	Calc. Prob.	Prob.	Lambda	Miss. Time ^a
060-WPTT-DERAIL--DER-FOM	1	1.180E-005	1.180E-005	0.000E+000	0.000E+000
060-WPTT-MILES-IN-CRCF	V	4.000E-002	4.000E-002	0.000E+000	0.000E+000

NOTE: ^a For Calc. Type 3 with a mission time of 0, SAPHIRE performs the quantification using the system mission time.

Calc. = calculation; Fail. = failure; Miss. = mission; Prob. = probability.

Source: Original

B5.4.3.6 Uncertainty and Cut Set Generation

Figure B5.4-11 contains the uncertainty results for the “Derailment of the WPTT” fault tree using a cutoff probability of 1E-12. Figure B5.4-12 provides the cut set generation results obtained from running the fault trees for “Derailment of the WPTT” during waste package transfer fault tree.

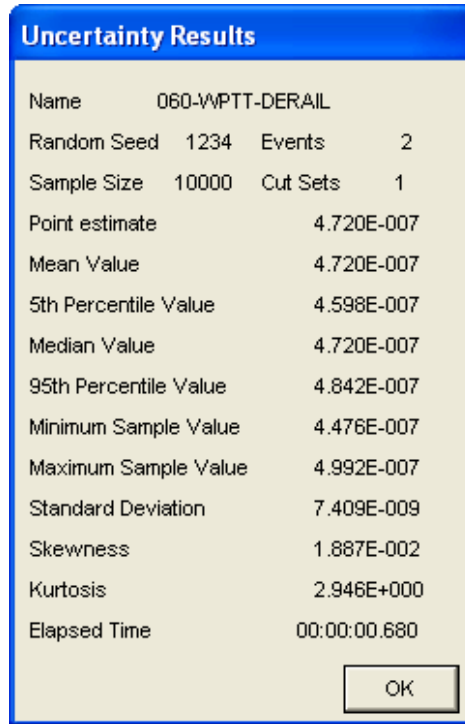

Source: Original

Figure B5.4-11. Uncertainty Results for the Derailment of the WPTT Fault Tree

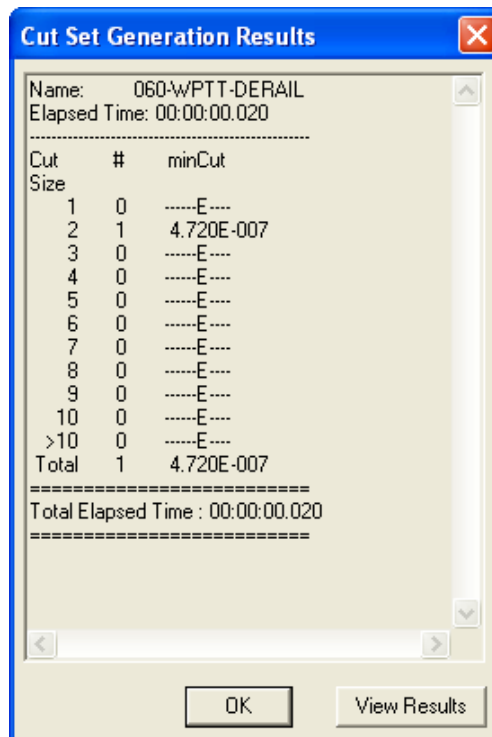

Source: Original

Figure B5.4-12. Cut Set Generation Results for the Derailment of the WPTT Fault Tree

B5.4.3.7 Cut Sets

Table B5.4-7 contains the cut sets for the “Derailment of the WPTT” fault tree. The total probability per cask is 4.720E-007.

Table B5.4-7. Cut Sets for the Derailment of the WPTT

Fault Tree	Cut Set %	Prob./Freq.	Basic Event	Description	Probability
060-WPTT- DERAIL	100.00	4.720E-007	060-WPTT-DERAIL--DER- FOM	Probability of WPTT Derailment per Mile	1.2E-005
			060-WPTT-MILES-IN-CRCF	Miles Traveled by WPTT During Transfer	4.0E-002
		4.720E-007	= Total		

NOTE: Freq. = frequency; Prob. = probability; WPTT = waste package transfer trolley.

Source: Original

B5.4.3.8 Fault Trees

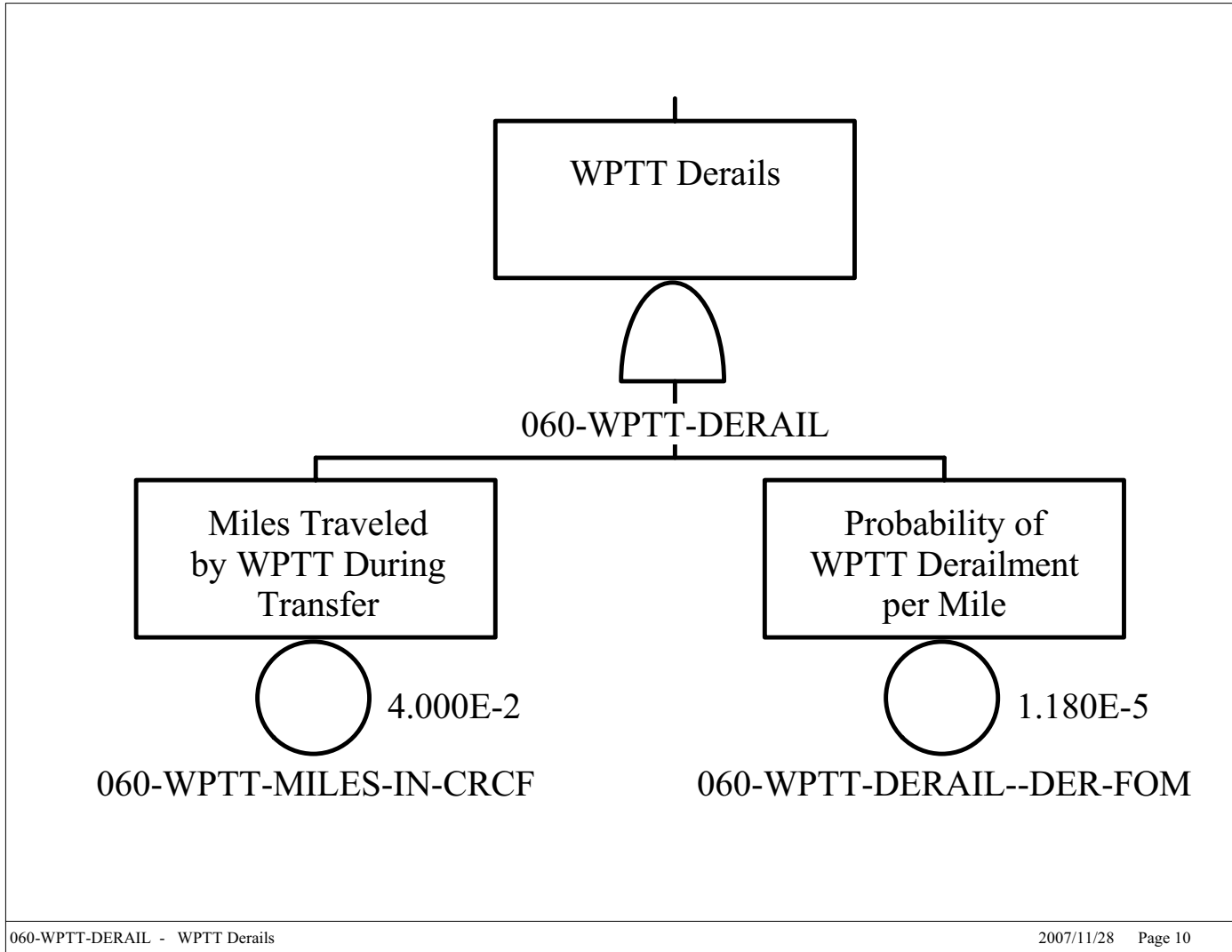

B5-29

March 2008

Source: Original

Figure B5.4-13. Fault Tree for Derailment of the WPTT during WP Transfer

B5.4.4 Premature Tilt-down of the WPTT

B5.4.4.1 Description

This fault tree considers the potential for the shield enclosure to prematurely tilt-down during movement of the WPTT from the loading area to the Waste Package Positioning Room (ESD-10) and during movement from the positioning area (or Waste Package Closure Room) to the docking station (ESD-13). For both ESDs, the pivotal event is “Premature Tilt-down of WPTT.” The top event is “Premature Tilt-down of WPTT.” This fault tree is shown in Figures B5.4-17.

Premature tilt-down may occur due to operator error, failure of the control system, or structural failure of the mechanical components supporting the shield enclosure. Operator or control system initiated tilt-down must coincide with failure of the docking interlock that must engage for power to be supplied to the shield enclosure motors. Structural failure requires failure of either the gear box or shaft on both sides of the shield enclosure since each side is designed to support the shield enclosure without the opposite side. If inadvertent tilt-down does begin, the gear system on each side is designed to provide a slow tilt-down and prevent slapdown.

B5.4.4.2 Success Criteria

Premature tilt-down of the shield enclosure is prevented during this transfer by interlocks that prevent power to the shield enclosure motors until the WPTT is docked.

B5.4.4.3 Design Features and Requirements

The design feature is the gearing system on each side of the shielding enclosure that prevents slapdown and which can support the shield enclosure independently. An additional design feature is the docking interlock that must be engaged for power to be provided to the shield enclosure motors.

B5.4.4.4 Fault Tree Model

The top event of the fault tree, shown in Figure B5.4-16 is premature tilt-down during movement of the WPTT from the loading area to the loadout room. Premature tilt-down may occur due to operator error or spurious signals from the control system coupled with the failure of the docking interlock.

B5.4.4.5 Basic Events

Table B5.4-8 contains a list of basic events used in the fault tree for “Premature Tilt-down of the WPTT” during waste package transfer.

Table B5.4-8. Basic Event Probabilities for Premature Tilt-down of the WPTT

Name	Calc. Type ^a	Calc. Prob.	Fail. Prob.	Lambda	Miss. Time ^a
060-OPTILTDOWN01-HFI-NOD	1	1.000E+000	1.000E+000	0.000E+000	0.000E+000
060-WPTT-HCWPTT2-HC--SPO	3	5.230E-007	0.000E+000	5.230E-007	1.000E+000
060-WPTT-IEL001-IEL-FOD	1	2.750E-005	2.750E-005	0.000E+000	0.000E+000
060-WPTT-PLCWPT2-PLC-SPO	3	3.650E-007	0.000E+000	3.650E-007	1.000E+000

NOTE: ^a For Calc. Type 3 with a mission time of 0, SAPHIRE performs the quantification using the system mission time.

Calc. = calculation; Fail. = failure; Miss. = mission; Prob. = probability.

Source: Original

B5.4.4.5.1 Human Failure Events

One operator error (060-OPTILTDOWN01-HFI-NOD) involves initiation of tilt-down.

B5.4.4.5.2 Common-Cause Failures

There are no common-cause failures.

B5.4.4.6 Uncertainty and Cut Set Generation

Figure B5.4-14 contains the uncertainty results for the “Premature Tilt-down of the WPTT” fault tree using a cutoff probability of 1E-12. Figure B5.4-15 provides the cut set generation results obtained from running the fault trees for “Premature Tilt-down of the WPTT” during waste package transfer.

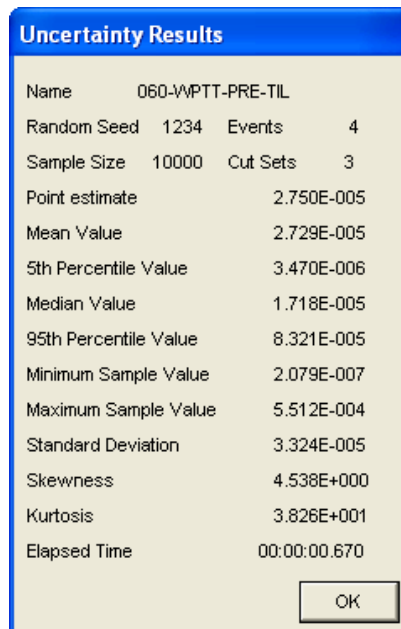

Source: Original

Figure B5.4-14. Uncertainty Results for the for Premature Tilt-down of the WPTT Fault Tree

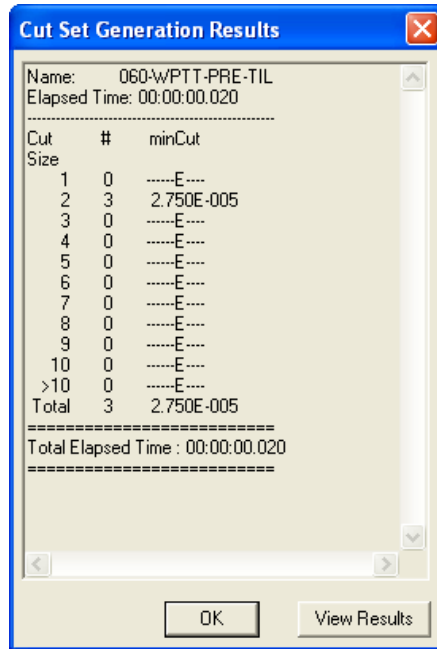

Source: Original

Figure B5.4-15. Cut Set Generation Results for the for Premature Tilt-down of the WPTT Fault Tree

B5.4.4.7 Cut Sets

Table B5.4-9 contains the cut sets for WPTT premature tilt-down during waste package transfer. The total probability per cask is 2.75E-5 with the major contributor operator initiation of premature tilt-down coinciding with failure of the docking interlock.

Table B5.4-9. Cut Sets for WPTT Premature Tilt-down During Waste Package Transfer

Fault Tree	Cut Set %	Prob./Freq.	Basic Event	Description	Probability
060-WPTT-PRE-TIL	100.00	2.750E-005	060-OPTILTDOWN01-HFI-NOD	Operator Initiates Premature Tilt Down	1.0E+000
			060-WPTT-IEL001-IEL-FOD	Docking Interlock Fails Closed	2.8E-005
	0.00	1.438E-011	060-WPTT-HCWPTT2-HC--SPO	Remote Control Sends Spurious Signal	5.2E-007
			060-WPTT-IEL001-IEL-FOD	Docking Interlock Fails Closed	2.8E-005
	0.00	1.004E-011	060-WPTT-IEL001-IEL-FOD	Docking Interlock Fails Closed	2.8E-005
			060-WPTT-PLCWPT2-PLC-SPO	On-Board PLC Initiates Spurious Signal	3.6E-007
		2.750E-005	= Total		

NOTE: Freq. = frequency; Prob. Probability; WPTT = waste package transfer trolley.

Source: Original

B5.4.4.8 Fault Trees

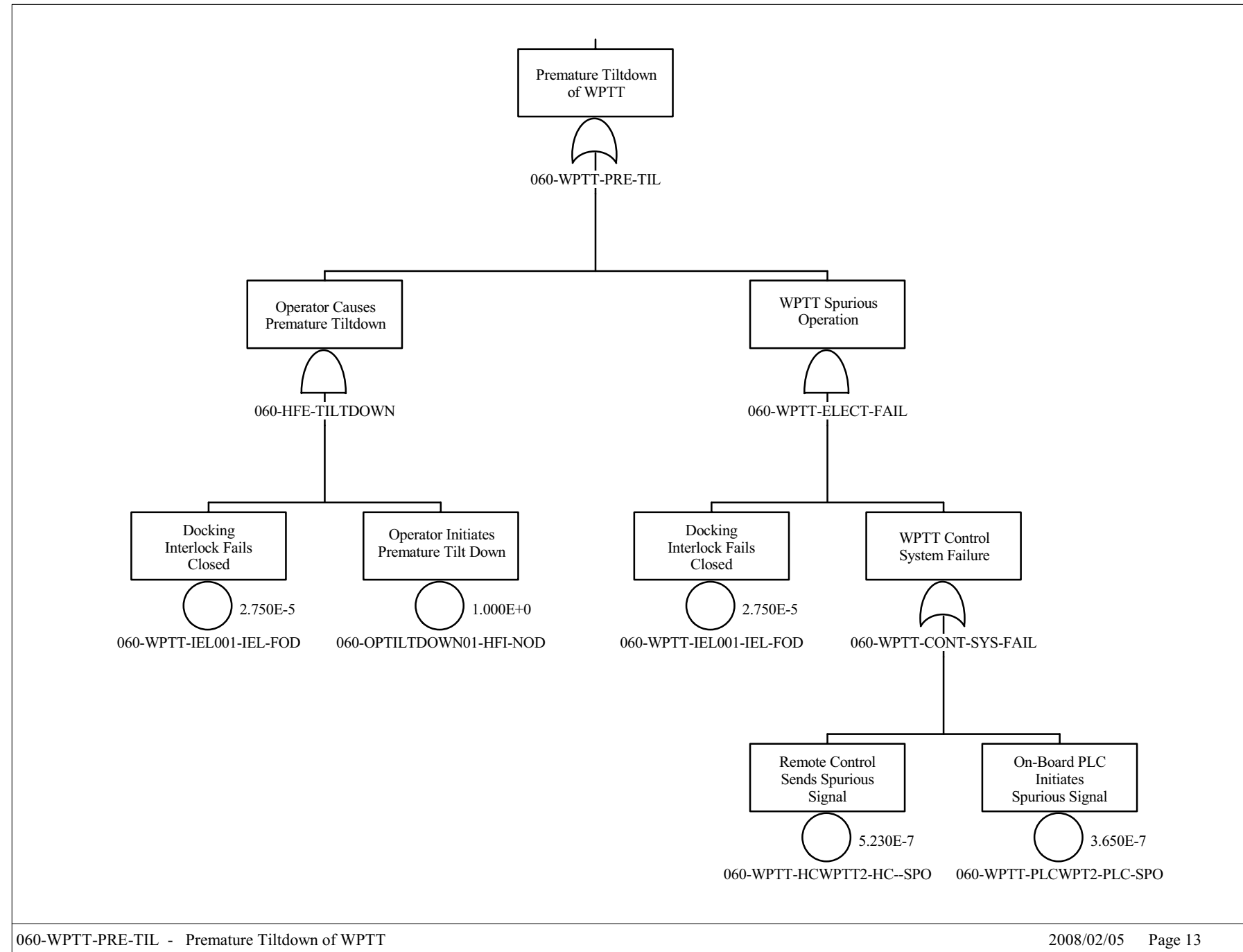

Source: Original

Figure B5.4-16. Fault Tree for WPTT Premature Tilt Down During Waste Package Transfer

B5.4.5 Malfunction of WPTT or Waste Package Transfer Carriage

B5.4.5.1 Description

This fault tree describes unplanned movements of the WPTT or carriage leading to impacts to the waste package during extraction of the waste package from the shield enclosure in the Waste Package Loadout Room. This fault tree satisfies ESD-15, pivotal event “Exposure due to Malfunction of WPTT or the waste package Transfer Carriage.” The top event is “WPTT or Carriage Malfunction during Export.” During the waste package extraction process, damage to the waste package may occur due to premature departure of the WPTT from the docking station, tilt-up of the shield enclosure, or operator error initiating the extraction process before the TEV door is completely open and impacting the waste package with the TEV door. This fault tree is shown in Figures B5.4-20, B5.4-21, and B5.4-22.

Several mechanical or control system failures must occur for the WPTT to prematurely leave the docking station during extraction. The control system (on-board or remote systems) must initiate a spurious signal, the locking mechanism must fail, and the docking interlock between the retrieval system and the power feed to the WPTT must fail. For the shield enclosure to tilt-up during extraction a tilt-up signal must be initiated (either through the control system or by the operator) and the motor running interlocks that close only when the waste package carriage retrieval assembly is completely extended or retracted must fail.

B5.4.5.2 Success Criteria

The success criteria are for the WPTT to remain motionless during the extraction process, and the extraction process start only after the TEV doors are completely open.

B5.4.5.3 Design Requirements and Features

The design features include the docking interlock that interrupts power to the trolley motor while the trolley is docked to prevent premature departure, and the carriage motor interlock that prevents power to the shield enclosure motors unless the carriage retrieval assembly is completely extended or retracted. A requirement is that the extraction process is not initiated until the TEV doors are fully open.

B5.4.5.4 Fault Tree Model

The top event of the fault trees in Figure B5.4-19 is “WPTT or Carriage Malfunction During Export” during export of the waste package from the shield enclosure. This may occur due to premature departure of the WPTT from the docking station, premature tilt-up of the shield enclosure during extraction or premature extraction of the waste package before the TEV doors are open due to operator error.

Premature departure (Figure B5.4-20) may occur due to spurious signals from the control system couples with failure of the docking interlock and the mechanical locking mechanism at the docking station. Premature tilt-up (Figure B5.4-21) may occur due to spurious signals from the control system or operator initiation of tilt-up couples with failure of the carriage motor interlock.

B5.4.5.5 Basic Events

Table B5.4-10 contains a list of basic events used in the fault tree for “Malfunction of WPTT or Waste Package Transfer Carriage” malfunction during waste package export.

Table B5.4-10. Basic Event Probabilities for WPTT or Carriage Malfunction During Export

Name	Calc. Type ^a	Calc. Prob.	Fail. Prob.	Lambda	Miss. Time ^a
060-OPTEVDRCLDSD-HFI-NOD	1	1.000E-003	1.000E-003	0.000E+000	0.000E+000
060-OPWPTILTUP01-HFI-NOD	1	1.000E+000	1.000E+000	0.000E+000	0.000E+000
060-WPTT-CAM001--CAM-FOH	3	3.190E-006	0.000E+000	3.190E-006	1.000E+000
060-WPTT-HCWPTT1-HC--SPO	3	5.230E-007	0.000E+000	5.230E-007	1.000E+000
060-WPTT-HCWPTT2-HC--SPO	3	5.230E-007	0.000E+000	5.230E-007	1.000E+000
060-WPTT-IEL001-IEL-FOD	1	2.750E-005	2.750E-005	0.000E+000	0.000E+000
060-WPTT-IEL003--IEL-FOD	1	2.750E-005	2.750E-005	0.000E+000	0.000E+000
060-WPTT-PLCWPT1-PLC-SPO	3	3.650E-007	0.000E+000	3.650E-007	1.000E+000
060-WPTT-PLCWPT2-PLC-SPO	3	3.650E-007	0.000E+000	3.650E-007	1.000E+000

NOTE: ^a For Calc. Type 3 with a mission time of 0, SAPHIRE performs the quantification using the system mission time.

Calc. = calculation; Fail. = failure; Miss. = Mission; Prob. = probability.

Source: Original

B5.4.5.5.1 Human Failure Events

There are two operator errors; one involves initiation of tilt up and the other extraction of the waste package with the TEV door closed.

B5.4.5.5.2 Common-cause Failures

There are no common-cause failures.

B5.4.5.6 Uncertainty and Cut Set Generation

Figure B5.4-17 contains the uncertainty results for “Malfunction of WPTT or Waste Package Transfer Carriage” using a cutoff probability of 1E-12. Figure B5.4-18 provides the cut set generation results obtained from “Malfunction of WPTT or Waste Package Transfer Carriage” malfunction during extraction of the waste package from the shield enclosure.

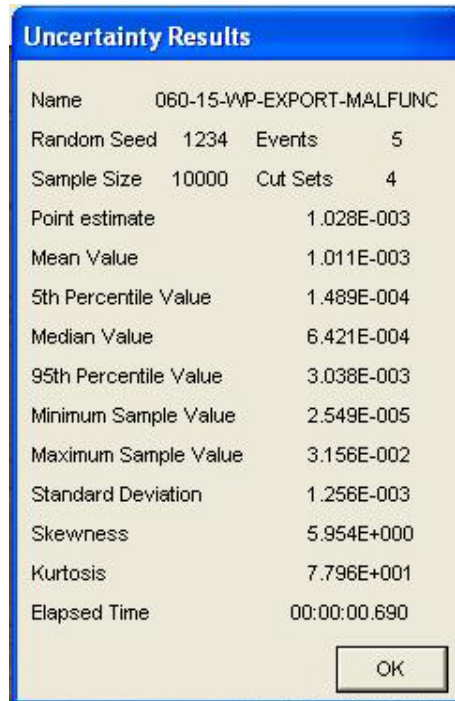

Source: Original

Figure B5.4-17. Uncertainty Results for the “Malfunction of WPTT or Waste Package Transfer Carriage” Fault Tree

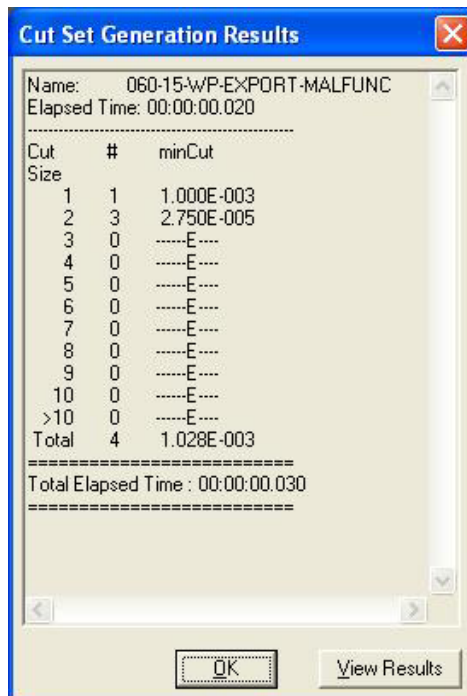

Source: Original

Figure B5.4-18. Cut Set Generation Results for the “Malfunction of WPTT or Waste Package Transfer Carriage”

B5.4.5.7 Cut Sets

Table B5.4-11 contains the cut sets for “Malfunction of WPTT or Waste Package Transfer Carriage” malfunction during waste package export. The total probability per cask is 1.03E-3 with operator error causing the waste package to impact the closed TEV door the primary contributor.

Table B5.4-11. Cut Sets for Malfunction of WPTT or Waste Package Transfer Carriage Malfunction During Waste Package Export

Fault Tree	Cut Set %	Prob./Freq.	Basic Event	Description	Probability
060-15-WP-EXPORT-MALFUNC	97.33	1.000E-003	060-OPTEVDRCLDSD-HFI-NOD	Operator begins WP Extraction with TEV Door Closed	1.0E-003
	2.68	2.750E-005	060-OPWPTILTUP01-HFI-NOD	Operator Initiates Tilt Up	1.0E+000
			060-WPTT-IEL001-IEL-FOD	Carriage Motor Running Interlock Fails to Halt Power to WPTT	2.8E-005
	0.00	1.438E-011	060-WPTT-HCWPTT2-HC--SPO	Remote Control Sends Spurious Signal	5.2E-007
			060-WPTT-IEL001-IEL-FOD	Carriage Motor Running Interlock Fails to Halt Power to WPTT	2.8E-005
	0.00	1.004E-011	060-WPTT-IEL001-IEL-FOD	Carriage Motor Running Interlock Fails to Halt Power to WPTT	2.8E-005
			060-WPTT-PLCWPT2-PLC-SPO	On-Board PLC Initiates Spurious Signal	3.6E-007
		1.028E-003	= Total		

NOTE: PLC = programmable logic controller; TEV = transport and emplacement vehicle; WP = waste package; WPTT = waste package transfer trolley.

Source: Original

B5.4.5.8 Fault Trees

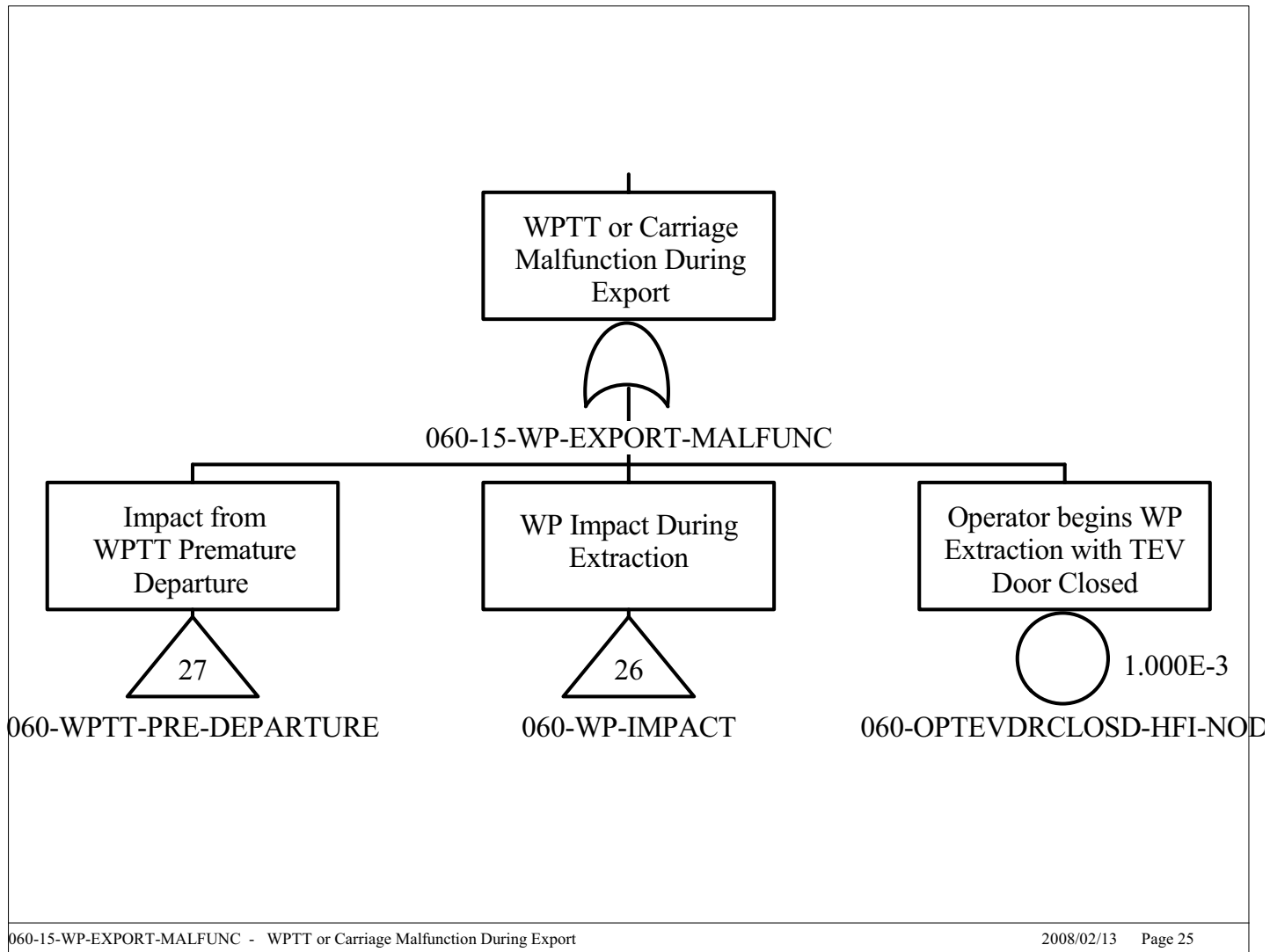

B5-38

March 2008

Source: Original

Figure B5.4-19. Fault Tree for WPTT or Carriage Malfunction during Export

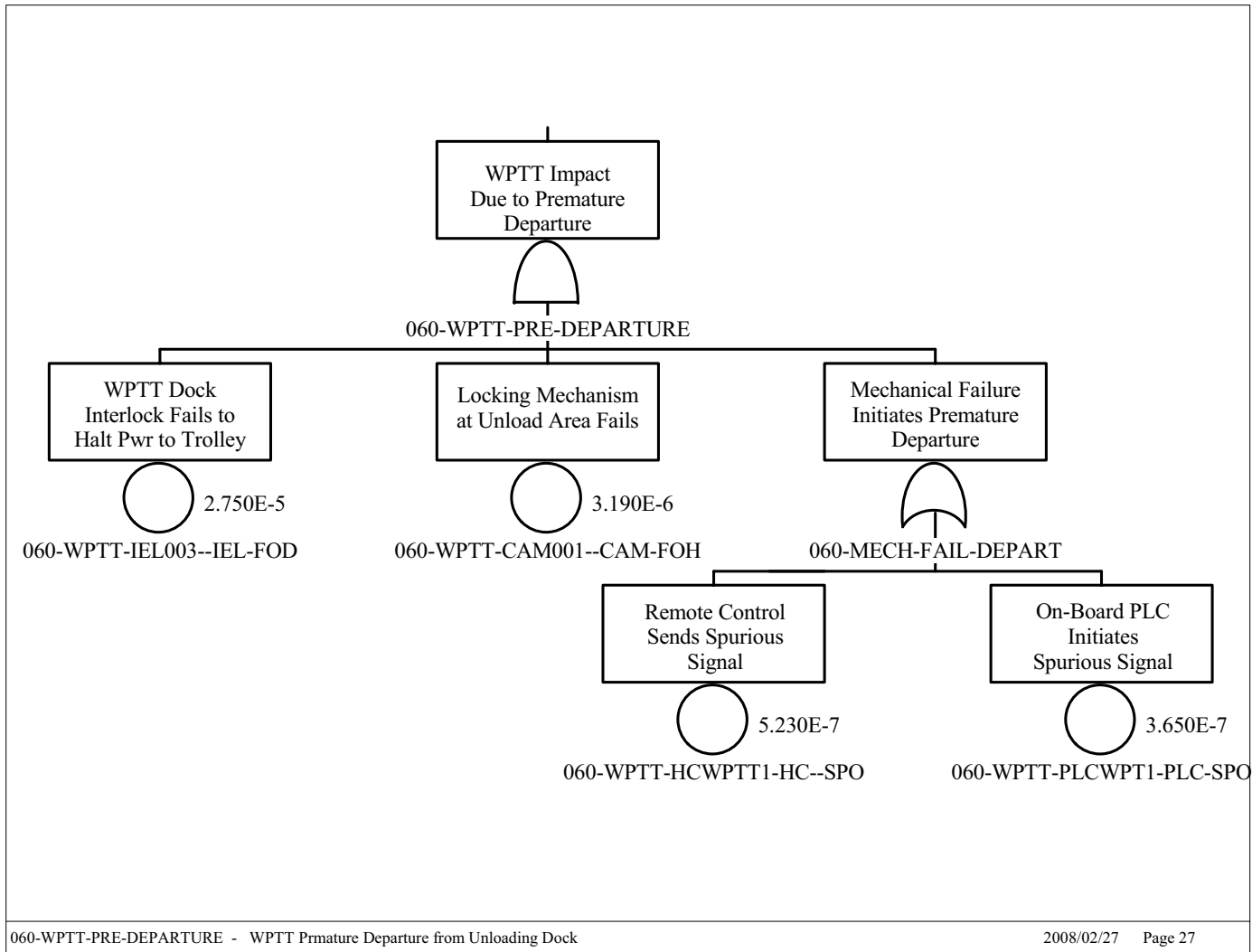

B5-39

March 2008

Source: Original

Figure B5.4-20. Fault Tree for WPTT or Carriage Malfunction during Export (Continued)

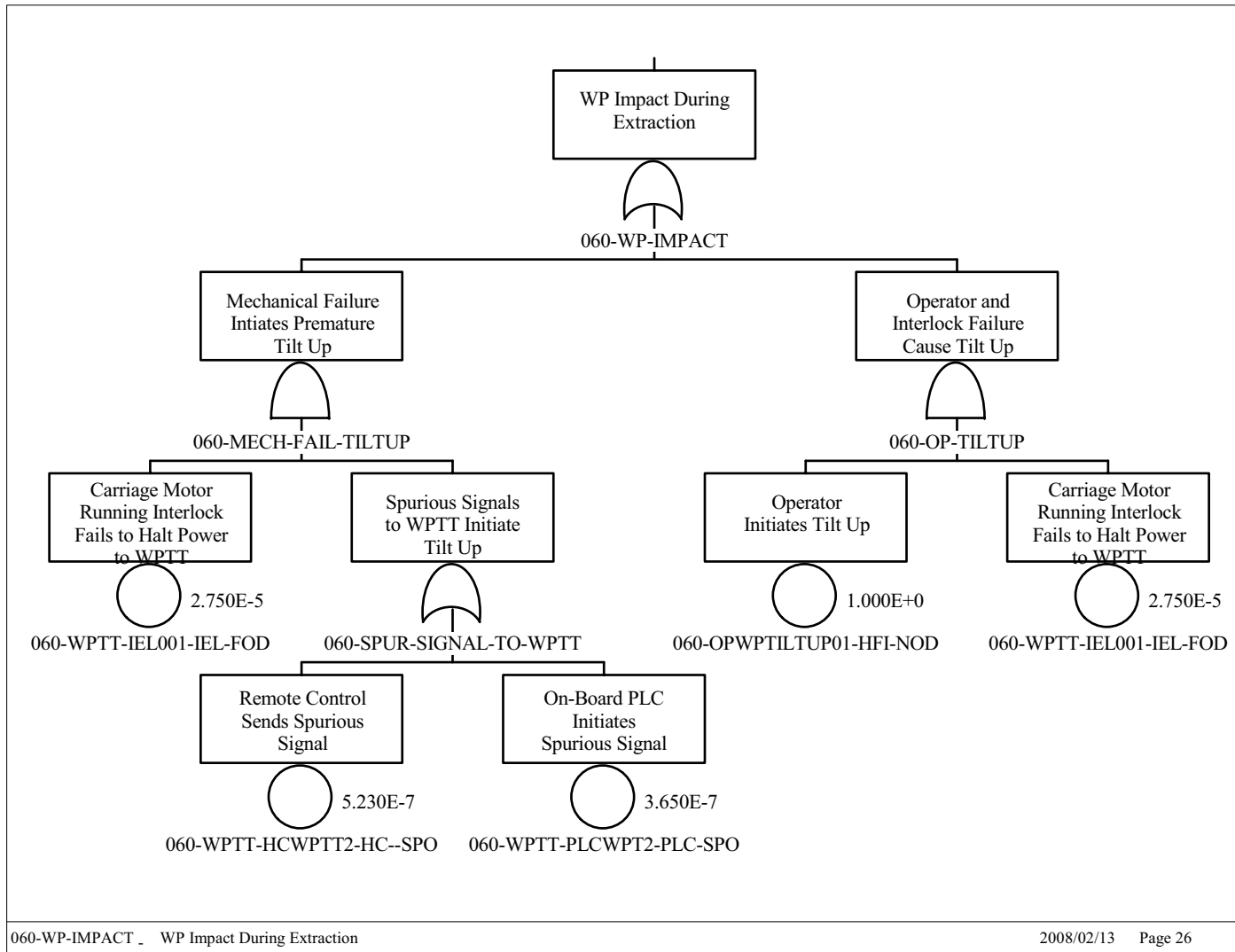

B5-40

March 2008

Source: Original

Figure B5.4-21. Fault Tree for WPTT or Carriage Malfunction during Export (Continued)

B6 SITE TRANSPORTER FAULT TREE ANALYSIS

B6.1 REFERENCES

Design Inputs

The PCSA is based on a snapshot of the design. The reference design documents are appropriately documented as design inputs in this section. Since the safety analysis is based on a snapshot of the design, referencing subsequent revisions to the design documents (as described in EG-PRO-3DP-G04B-00037, *Calculations and Analyses* (Ref. 2.1.1, Section 3.2.2.F)) that implement PCSA requirements flowing from the safety analysis would not be appropriate for the purpose of the PCSA.

B6.1.1 BSC (Bechtel SAIC Company) 2007. *Mechanical Handling Design Report – Site Transporter*. 170-30R-HAT0-00100-000 Rev 000. Las Vegas Nevada: Bechtel SAIC Company. ACC: ENG.20071217.0015.

B6.1.2 BSC 2007. *Exhibit D, Statement of Work for Mechanical Handling Equipment Design*. 000-3SW-MGR0-00100-000-003. Las Vegas, Nevada: Bechtel SAIC Company. ACC: ENG.20070904.0031.

B6.1.3 Morris Material Handling 2007. *P&ID Site Transporter*. V0-CY05-QHC4-00459-00049-001 Rev. 004. Oak Creek, Wisconsin: Morris Material Handling. ACC: ENG.20071022.0012.

B6.2 SITE TRANSPORTER DESCRIPTION

The site transporter is a diesel/electric self-propelled tracked vehicle that is designed to transport a cylindrical concrete and steel ventilated aging overpack. The transport occurs within the Intra-Site, the CRCF, WHF and the RF. The site transporter only transports aging overpacks to and from the CRCF.

Movement of the site transporter within the CRCF is limited to the Entry Vestibule (Room 1027), the Cask Preparation Room (Room 1026), and either of the two Cask Unloading Rooms (Rooms 1023 or 1024).

B6.2.1 Overview

The interface between the site transporter and the aging overpack is via two parallel rectangular lift slots that pass through the containers near their lower ends. Orientation of the aging overpack is such that the axis of the aging overpack is vertical with lid, at the top. Access to the top of the aging overpack is unobstructed.

An integrated, diesel powered, electric generator provides electricity to operate the site transporter outside the facility building. Inside the facility buildings the site transporter is electrically driven via an umbilical cable (or remote control) from the facility main electrical supply (Ref, B6.1.1 Section 2.1).

The site transporter is a track driven vehicle with four synchronized tracks (two on each side of the site transporter). The components of the drive system (i.e., tumblers, idlers, rollers) are not included in this analysis since these components are not important to safety (ITS).

A rear fork assembly consists of a pair of arms that extend to the front of the site transporter. These forks move up and down for the purpose of raising, lowering, and supporting the aging overpack during movement. A pair of support arms is located at the front of the site transporter which is moved into position around the forks to provide support and assistance during the lifting and lowering of the aging overpack.

A passive restraint system stabilizes the aging overpack during movement. There are two mechanisms that control aging overpack movement on the pitch and roll axis. These restraints are not engaged until the aging overpack has been raised to the desired height. Once engaged, three pins are inserted, one in each restraint arm that keep the restraints in place should there be a failure of the electromechanical assembly used to position and secure the restraint device. Properly installed, they also serve as interlocks that prevent movement of a loaded site transporter.

Control of the site transporter is provided by a wireless remote control or a wired pendant. Although these devices only provide a subset of the controls and indicators that are available on the control console located on the site transporter, they contain all the necessary controls and indicators to perform and monitor the operation state of the site transporter during normal operations. The site transporter is shown in Figure B6.2-1.

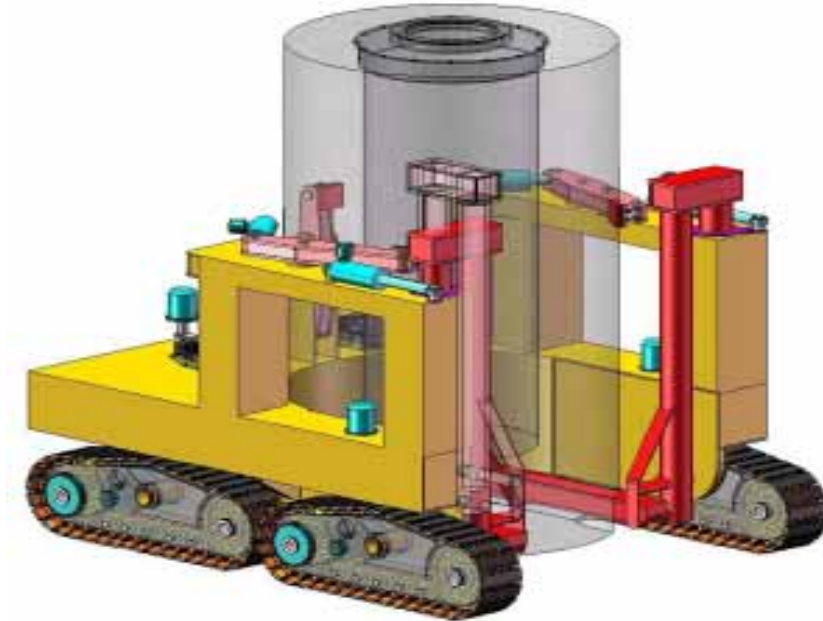

Source: Ref. B6.1.1

Figure B6.2-1 Site Transporter

The site transporter system is composed of six subsystems (Ref. B6.1.1):

1. Crawler Tracks Subsystem—Four crawlers, two on each side of the site transporter, are used to move the vehicle. These crawlers use tracks with chamfered flat steel plates mounted to double grouser shoes on a continuous chain.
2. Power Plant Subsystem—A diesel engine, generator, and diesel fuel tank are enclosed in the back of the site transporter. During Intra-Site activities, the diesel engine drives the generator, which provides the required 480VAC/3-phase/60 Hertz power to the vehicle. During facility operations, the diesel engine is disabled and facility 480VAC/3-phase/60 Hertz power is supplied to operate the vehicle.
3. Rear Lift Fork Subsystem—Site transporter contains a pair of arms that extend forward from the site transporter through slots in the aging overpack. The lift/lower drive system utilizes an ACME type nut that changes the elevation of the fork as the screw lift mechanism turns through the ACME nut. A lift synchronizer controls the lift/lower operation.
4. Lift Support Arms Subsystem—Two support arms with electromechanical actuators are located on the front of the site transporter. These support arms are rotated 90 degrees to provide support and stabilization for the lift forks during lifting/lowering/moving operations. ACME nuts are used on these arms and synchronized with the lift forks during lifting/lowering/moving.
5. Restraint Subsystem—A two axis restraint system is incorporated to stabilize the aging overpack during site transporter movement. The restraints are emplaced/retracted with electromechanical actuators. These restraints, when positioned against the aging overpack are secured with a locking pin. The three locking pins serve as an interlock and must be properly installed before the site transporter can be moved.
6. Vehicle Controls Subsystem—There are two modes of control provided on the site transporter. Operators can control every operation on the site transporter with either a remote (wireless) controller or through a pendant connected to the site transporter.

Note: In addition to the six subsystems identified above, Ref. B6.1.1 also includes a description of the site transporter “car body.” Events associated with car body failure are screen from this analysis based on the results of the stress analysis contained in this reference.

A simplified block diagram of the functional subsystems on the site transporter is shown in Figure B6.2-2.

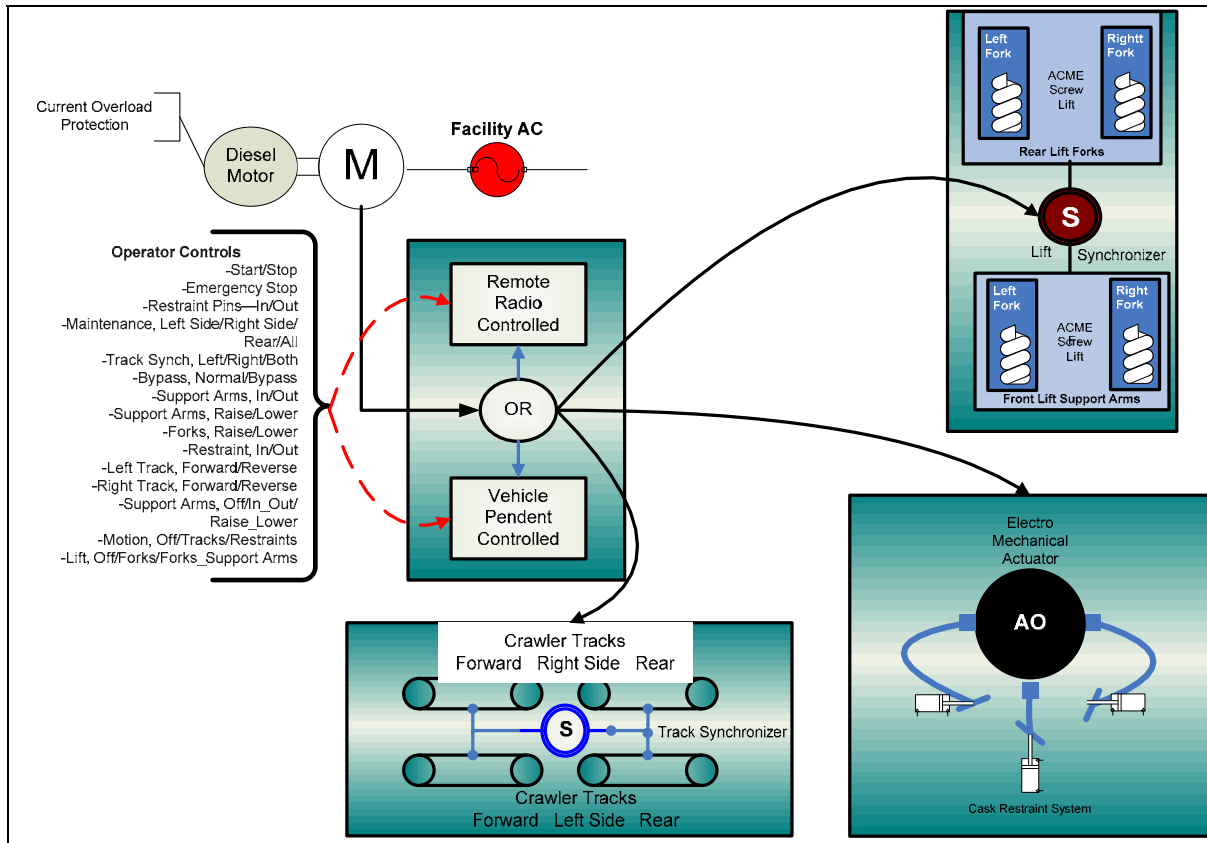

NOTE: AC = alternating current; AO = aging overpack; M = motor; S = synchronizer.

Source: Original

Figure B6.2-2. Simplified Block Diagram of the Site Transporter Subsystems

B6.2.1.1 Site Transporter Crawler Tracks Subsystem Description

The site transporter moves by four tracks mounted on the crawler frames with two on each side of the vehicle to increase stability when traversing terrain that includes sudden changes in elevation such as a drainage trough or curb. The site transporter is designed to negotiate roadways with a 5% grade and up to a 2% cross-slope (Ref. B6.1.2, Section 7.2.2-11). Special pads are included on the tracks to reduce the wear and tear on concrete or roadways.

Each track is driven by its own electric motor (50 HP @ 900 rpm) through its own gear reduction and final chain drive reduction. During forward operations, motors on both sides of the machine drive are synchronized. During turns the outside tracks are driven faster and for very sharp turns the tracks are counter-rotated to turn the site transporter about its own vertical centerline (Ref. B6.1.1, Section 2.1.2).

B6.2.1.2 Power Plant Subsystem Description

The power plant subsystem supplies the site transporter with 480 volts AC, 3-phase power at 60 Hertz. Because of the risk of contamination from their various fluids, there are no storage

batteries or capacitors in the system. The generator is size approximately 110% more than the highest power requirement for the vehicle.

The 150 KW generator is sized for seven hours of continuous operation with a fuel tank containing 99-gallons of diesel fuel (Ref. B6.1.1, Section 2.2.3). The fuel tank capacity is sized to minimize the amount of fuel taken inside the facilities, but sufficient to transport a loaded aging overpack three miles and return to the site transporter's point of origin without refueling (Ref. B6.1.2, Section 7.2.2-2).

When entering a building the generator is shut down and a power source from the building is plugged into the site transporter integral receptacle to allow the site transporter to operate inside the building without a source of combustion.

The motor drive system and current overload protection system prevents the site transporter from exceeding 2.5 mph (Ref. B6.1.1, Section 3.2.1).

B6.2.1.3 Rear Lift Forks Subsystem Description

The rear forks are only capable of moving up or down. Each fork is driven by its own gear reduction and 16 HP, 900 rpm electric motor. The output of the drive is a rotating ACME type screw which, as it turns inside the rear fork lift tube, drives an ACME nut that raises or lowers the fork. The height of the rear lift fork is controlled by limit switches as well as being mechanically unable to lift an aging overpack height more than 12 inches above the floor/ground (Ref. B6.1.1), Sections 2.1.4 and 2).

B6.2.1.4 Lift Support Arms Subsystem Description

The front support arms have constrained movement which consists of a clockwise/counterclockwise rotation and up and down movement. The right and left assemblies are mirror images of one another and move as a synchronous pair although they are each driven by their own gear reduction and 20 HP, 900 rpm electric motor (Ref. B6.1.1, Section 2.1.5).

The operator positions the lift support arms around the lifting forks. After the site transporter has been positioned properly around the aging overpack, the rear forks are raised to contact the bottom of the aging overpack's lifting slots. Limit and position switches ensure the lift support arms are in the correct position. Additional limit switches prevent the support arms from exceeding the 12 inch lift.

B6.2.1.5 Restraints Subsystem Description

When the load on the site transporter is ready to be lifted, the three arms of the restraint system are activated and moved to a location "near" the aging overpack. This location is determined by a combination of operator observation and integral limit switches.

After the aging overpack has been raised to the specified transportation height, the restraint arms are engaged and locked to hold the aging overpack in place during movement. The arms are moved by linear electromechanical actuators. In addition, a locking pin is utilized to take

extreme loads as well as serve as an interlock device. The three restraint arms must be properly pinned before the interlock allows the site transporter to be moved (Ref. B6.1.3, Sheet 1 of 3).

B6.2.1.6 Vehicle Controls Subsystem Description

The site transporter can be operated in two modes: a remote (wireless) control and an operator controlled pendant (Ref. B6.1.1, Section 2.1.7). Both of these devices have the same capability. Table B6.2-1 contains a list of controls that are available on the controller and the corresponding activation device (Ref. B6.1.3, Sheet 3 of 3).

Table B6.2-1. Site Transporter Remote or Pendant Controls

Site Transporter Operation	Activation Device on Controller
Start/Stop	Pushbutton
Emergency Stop	Palm Button
Restraint pin—Engage(in)/Disengage (out)	Selector Switch
Maintenance--Left Side/Right Side/Rear/All	Keyed Selector Switch
Track synch—Left/Right/Both	Selector Switch
Bypass—Normal/Bypass	Keyed Selector Switch
Support Arms—In/Out	Induction Pushbutton
Support Arms—Raise/Lower	Induction Pushbutton
Forks—Raise/Lower	Induction Pushbutton
Restraint—In/Out	Induction Pushbutton
Left Track—Forward/Reverse	Induction Pushbutton
Right Track—Forward/Reverse	Induction Pushbutton
Support Arms—Off/In-Out/Raise-Lower	Selector Switch
Motion—Off/Tracks/Restraints	Selector Switch
Lift—Off/Forks/Forks Support Arms	Selector Switch

Source: Original

All safety interlocks and controls of the site transporter are hard wired between the specific relays, drives, circuit breakers, and other electrical equipment. No PLC or computer is used to control the machine.

B6.2.2 Normal Operations

Once the lift has been completed, the operator performs the final positioning of the upper restraint arms and inserts a pin in each arm. When the pins are properly installed, the site transporter can move.

The operator trails behind the site transporter during movement using the remote control to drive the site transporter to the desired location. Once the site transporter arrives at the facility, the operator stops the vehicle outside the Entry Vestibule and turns off the diesel generator. An electrical umbilical cable is manually retrieved from inside the building and attached to the site transporter. The site transporter is never operated inside the CRCF on diesel power.

Once inside the building, the operator positions the site transporter in the Cask Preparation Room and in the Cask Unloading Rooms. Before work is performed on the aging overpack, the site transporter operator removes the pins from the restraint arms and disengages them from the aging overpack. The movement interlock is engaged when the pins are removed. The operator then lowers the aging overpack to the floor. The procedure is reversed when it is necessary to move the site transporter again inside the facility. Once inside the Cask Unloading Room, the pins are removed, the restraints are disengaged, the aging overpack lowered to the floor and the umbilical cable removed.

The operations used to move an unloaded aging overpack are identical but not considered in this analysis.

B6.2.3 Site Transporter Off-Normal Operations

There are four off-normal conditions that could occur during the movement of an aging overpack. When any of these occur, the operator response encompasses only those actions to return the aging overpack to a safe state. These are:

- Lowering the forks without electrical power
- Rotating the lift support arms without electrical power
- On-board generator fails to operate
- Track belt fails.

In the event of a loss of power, the site transporter is designed to stop, retain its load and enter a locked mode. Upon the restoration of power the site transporter stays in the locked mode until operator action is taken (Ref. B6.1.2, Section 7.2.3-5).

B6.2.4 Site Transporter Testing and Maintenance

Testing and Maintenance of the site transporter is done on a periodic basis and does not affect the normal operations of the site transporter. Testing and/or maintenance are not performed on a site transporter loaded with an aging overpack. A site transporter that has malfunctioned or has a warning light lit on the site transporter is deemed unserviceable and turned in for maintenance. Unserviceable vehicles are not used.

If an unserviceable state is identified during a lift/lower or movement activity, the site transporter is immediately placed in a safe state (as quickly as possible) and recovery actions for the site transporter are invoked.

B6.2.5 Site Transporter System/Pivotal Event Success Criteria

A site transporter failure is the initiating event in five event sequences in the CRCF as shown in Table B6.2-2.

Table B6.2-2. Site Transporter Initiating Events by ESD

Initiating Event	Affected ESD
Site Transporter Collision Site Transporter Rollover Site Transporter Load Drop	ESD-2 Receipt of AO in Site Transporter Vestibule and Movement into Cask Preparation Room
Site Transporter Spurious Movement	ESD-5 AO Preparation Activities
Site Transporter Collision	ESD-6 Transfer of AO on site Transporter from Cask Preparation Room to Cask Unloading Room
Site Transporter Spurious Movement	ESD-9 Lifting and Lowering a Canister During Transfer in CTM
Site Transporter Spurious Movement	ESD-12 Assembly and Closure of AO
Site Transporter Collision	ESD-14 Site Transporter Collision during Transfer of AO from Cask Unloading Room to Cask Preparation Room
Site Transporter Collision Site Transporter Rollover Site Transporter Load Drop	ESD-16 Exporting AO from CRCF

NOTE: AO = Aging Overpack; CRCF = Canister Receipt And Closure Facility; CTM = Canister Transfer Machine; ESD = Event Sequence Diagram.

Source: Original

Spurious movement of the site transporter is prevented by the inherent design constraints of the site transporter. There is only sufficient electrical power to perform one type of operation at a time. For example, it is not possible to command a lift/lower of the aging overpack when the site transporter is moving. Spurious signals can not be generated when primary power is removed from the site transporter (i.e., diesel engine shut down and/or facility electrical power cable disconnected). There are no batteries or capacitors in the site transporter that can store electrical energy.

Requirements

Two means of stopping the site transporter are incorporated in the controllers. One is the normal stop button and the other consists of an emergency stop that is the equivalent of a dead man switch.

On the loss of AC power derived from the facility, the site transporter performs a controlled stop. Once stopped the site transporter enters the “lock mode,” safe state. The “lock mode,” safe state is not reversible without specific operator action.

There is no testing or maintenance permitted on a site transporter loaded with an aging overpack.

Since the dominant contributor to site transporter collision in the facility is human error, no priority is given to either the remote or the pendant controllers.

Design Features

Stopping the site transporter is accomplished by pushing the “stop” button on the remote or pendant controller. The site transporter, upon receiving a stop command from either control source immediately responds by removing power from the propulsion system.

The site transporter is only able to perform one function at any time. It can lift a aging overpack or it can move it, but it can not perform both functions at the same time. This feature is accomplished by interlock and by power limitations inherent in the sizing of the power plant that ensures a limited amount of power for each of the electromechanical devices and drive system.

B6.3 DEPENDENCIES AND INTERACTIONS ANALYSIS

Dependencies are broken down into five categories with respect to their interactions with structures, systems, and components. The five areas considered are addressed in Table B6.3-1 with the following dependencies:

1. Functional dependence
2. Environmental dependence
3. Spatial dependence
4. Human dependence
5. Failures based on external events.

Table B6.3-1. Dependencies and Interactions Analysis

Structures, Systems, and Components	Dependencies and Interactions				
	Functional	Environmental	Spatial	Human	External Events
Lift Booms	-Material failure -ACME screw/nut	—	—	—	—
Lift Support Arms	-Material failure -ACME screw/nut	—	—	—	—
Restraint Arms	-Material failure -Lock pin failure	—	—	—	—
Power Plant	-Current Overload Protection Fails -Safe State On	—	—	- Failure to stop - Failure to remove power cable	—
Remote Control	-Spurious Commands	—	—	- Improper command	- Collide with Crane Rigging
Tracks	-Material Failure	—	—	-Failure to stop	—

Source: Original

B6.4 SITE TRANSPORTER RELATED FAILURE SCENARIOS

There are four basic site transporter fault trees developed for the CRCF. The top events for these fault trees and the variations are:

1. Site transporter collides with CRCF structures
 - A. Importing aging overpack to Cask Preparation Room
 - B. Transfer from Cask Preparation Room to Cask Unloading Room
 - C. Transfer of aging overpack from Cask Unloading Room to Cask Preparation Room
 - D. Exporting aging overpack from Cask Preparation Room.
2. Site transporter load drop during lift/movement
3. Site transporter rollover
4. Site transporter spurious movement (ESD-09)
5. Site transporter spurious movement (ESD-05, ESD-12).

There are various top events for the site transporter operating inside the CRCF. Table B6.4-1 provides a cross reference between the ESDs and the site transporter fault trees that support them.

Table B6.4-1. ESD Cross Reference with Site Transporter Fault Trees

Crcf ESD Number	Site Transporter Collision	St Rollover	St Load Drop Lift/Lower	St Spurious Movement
F-2	X	X	X	—
F-5	—	—	—	X
F-6	X	—	—	—
F-7	X (Impact by Shield Door)*	—	—	—
F-9	—	—	—	X
F-12	—	—	—	X
F-14	X	—	—	—
F-16	X	X	X	—

NOTE: *Impact Into ST by Shield Door Described In Attachment A Section A4.7.

CRCF = Canister Receipt and Closure Facility; ST = Site Transporter.

Source: Original

B6.4.1 Site Transporter Collides with CRCF Structures (ESD -02, -06, -14, and -16)

B6.4.1.1 Description

The fault trees for the four collisions event sequences are identical. Collisions can occur as a result of human error or mechanical failures (human error events are uniquely identified but all have the same screening value of $3E-3$ with a lognormal error factor of 5) (Table 6.4-1). Mechanical failures leading to a collision consist of the site transporter failing to stop when commanded, the site transporter exceeding a safe speed or the site transporter moves in the wrong direction.

B6.4.1.2 Success Criteria

The success criteria for preventing a site transporter collision include safety design features incorporated in the site transporter for mechanical failures. The site transporter operator continuously maintains situational awareness and proper control of the movement of the site transporter. To avoid collisions, the site transporter must stop when commanded, be prevented from entering a runaway situation or respond correctly to a site transporter movement command.

The site transporter is designed to stop whenever commanded to stop or, when there is a loss of power. The operator can stop the site transporter by either commanding a “stop” from the start/stop button or by releasing the palm switch which initiates an emergency stop. Anytime there is a loss of power detected, the site transporter immediately stops all movement and enters into a “lock mode,” safe state. The site transporter remains in this locked mode until power is returned and the operator restarts the site transporter.

Runaway situations on the site transporter are prevented by mechanical constraints. The maximum speed of the site transporter is limited by motor current overload protection (Ref. B6.1.1, Section 3.2.1). The site transporter motor speed and gearing prevents the site transporter from exceeding 2.5 miles per hour.

The prevention of site transporter movements in the wrong direction is prevented by the limitation of the power plant that prevents simultaneous operations.

B6.4.1.3 Design Requirements and Features

Requirements

The site transporter has two off-equipment control devices that have complete control over the site transporter.

Features

Drive system consists of an electric motor and a transmission constraint which limits the maximum speed of the site transporter to 2.5 mph.

B6.4.1.4 Fault Tree Model

The fault tree model for “Site Transporter Collides with CRCF Structures in the CRCF,” accounts for both human error and/or site transporter mechanical problems that could result in collision. There are three distinct movements within the CRCF which are reversed if an aging overpack is picked up in the CRCF and taken to the aging pads. Movement within the facility is restricted and even at low speeds a collision can occur.

The fault tree considers mechanical failures that fail to stop the site transporter, events that could cause the site transporter to exceed safe speed, and events that could cause the site transporter to move in the wrong direction

B6.4.1.5 Basic Events

Table B6.4-2 lists the basic events used in the “Site Transporter Collides with CRCF Structures” fault tree.

Table B6.4-2. Basic Event Probability for Site Transporter Collides with CRCF Structures

Basic Events Probability Report					
Project: Yucca-Mountain	Calc. Type ^a	Case : Current	Fail. Prob.	Lambda	Miss. Time ^a
ST Collision in Facility		Units: Per Hour			
Name		Calc. Prob.			
060-OPSTCOLLIDE1-HFI-NOD	1	3.00E-03	3.00E-03	0.00E+00	1.00E+00
060-ST---BRK001--BRK-FOD	1	1.46E-06	1.46E-06	0.00E+00	1.00E+00
060-ST---CBP004-CBP--OPC	3	9.13E-08	0.00E+00	9.13E-08	1.00E+00
060-ST---CBP004-CBP--SHC	3	1.88E-08	0.00E+00	1.88E-08	1.00E+00
060-ST---CT000---CT--FOD	1	4.00E-06	4.00E-06	0.00E+00	1.00E+00
060-ST---CT002---CT--FOH	3	6.88E-05	0.00E+00	6.88E-05	1.00E+00
060-ST---HC001--HC--FOD	1	1.74E-03	1.74E-03	0.00E+00	1.00E+00
060-ST---HC002---HC--SPO	3	5.23E-07	0.00E+00	5.23E-07	1.00E+00
060-ST---MOE000--MOE-FSO	3	1.35E-08	0.00E+00	1.35E-08	1.00E+00
060-ST---MOE021--MOE-FSO	3	1.35E-08	0.00E+00	1.35E-08	1.00E+00
060-ST---SC021---SC--FOH	3	1.28E-04	0.00E+00	1.28E-04	1.00E+00
060-ST---SC021---SC--SPO	3	3.20E-05	0.00E+00	3.20E-05	1.00E+00
060-ST---SEL021--SEL-FOH	3	4.16E-06	0.00E+00	4.16E-06	1.00E+00
LOSP-4	1	4.1E-06	4.1E-06	0.00E+00	0.00E+00

NOTE: ^a For Calc. Type 3 with a mission time of 0, SAPHIRE performs the quantification using the system mission time.

Calc. = calculation; Fail. =failure; Prob. = probability; ST = site transporter.

Source: Original

B6.4.1.5.1 Human Failure Events

There is one human event in the collision fault trees for the site transporter and accounts for the site transporter operator causing the collision. This human error is set at the screening value of 3E-03 for all four ESD events.

B6.4.1.5.2 Common-Cause Failures

There are no common-cause failures (CCFs) identified for this fault tree.

B6.4.1.6 Uncertainty and Cut Set Generation

Figures B6.4-1 and B6.4-2 contain the uncertainty and the cut set generation results for the “Site Transporter Collides with CRCF Structures” fault tree using a cutoff probability of 1E-15.

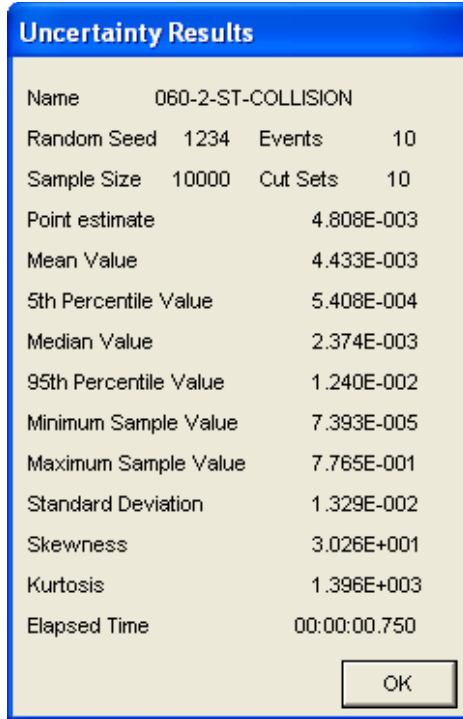

Source: Original

Figure B6.4-1. Uncertainty Results for Site Transporter Collides with CRCF Structures Fault Tree

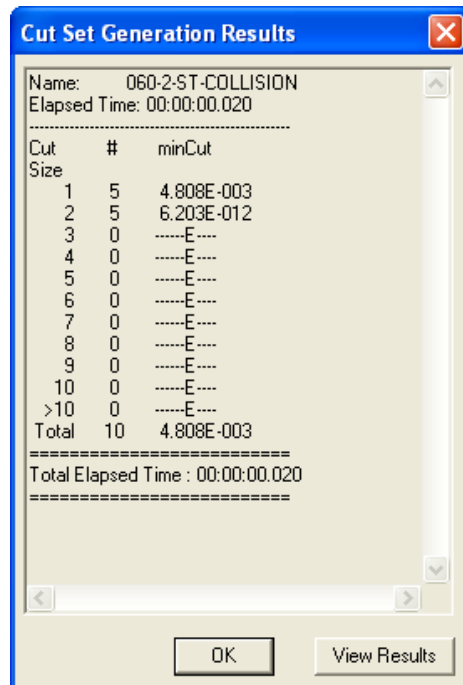

Source: Original

Figure B6.4-2. Cut Set Generation Results for Site Transporter Collides with CRCF Structures Fault Tree

B6.4.1.7 Cut Sets

Table B6.4-3 contains the cut sets for “Site Transporter Collides with CRCF Structures” fault tree.

Table B6.4-3. Cut Sets for the Site Transporter Collides with CRCF Structures

Fault Tree	Cut Set %	Prob./Freq.	Basic Event	Description	Probability
060-2-ST-COLLISION	62.40	3.000E-003	060-OPSTCOLLIDE2-HFI-NOD	Operator Error Causes Collision	3.0E-003
	36.19	1.740E-003	060-ST---HC001--HC--FOD	Remote Control Transmits Wrong Signal	1.7E-003
	1.43	6.880E-005	060-ST---CT002---CT--FOH	Direction Controller Fails	6.9E-005
	0.08	4.000E-006	060-ST---CT000---CT--FOD	ST Primary Stop Switch Fails	4.0E-006
	0.01	5.230E-007	060-ST---HC002---HC--SPO	Spurious Command to Lift/Lower AO or STC	5.2E-007
	0.00	5.986E-012	060-ST---BRK001--BRK-FOD	ST Fails to Stop on Loss of Power	1.5E-006
			LOSP-4	Failure of Off Site Power	4.1E-006
	0.00	1.333E-013	060-ST---BRK001--BRK-FOD	ST Fails to Stop on Loss of Power	1.5E-006
			060-ST---CBP004-CBP--OPC	ST Power Cable - Open Circuit	9.1E-008
	0.00	5.535E-014	060-ST---MOE000--MOE-FSO	Motor (Electric) Fails to Shut Off	1.4E-008
			LOSP-4	Failure of Off Site Power	4.1E-006
	0.00	2.745E-014	060-ST---BRK001--BRK-FOD	ST Fails to Stop on Loss of Power	1.5E-006
			060-ST---CBP004-CBP--SHC	ST Power Cable Short Circuit	1.9E-008
	0.00	1.233E-015	060-ST---CBP004-CBP--OPC	ST Power Cable - Open Circuit	9.1E-008
			060-ST---MOE000--MOE-FSO	Motor (Electric) Fails to Shut Off	1.4E-008
			4.808E-003	= Total	

NOTE: AO = aging overpack; Freq. = frequency, Prob. = probability; ST = site transporter; STC = shielded transfer cask.

Source: Original

B6.4.1.8 Fault Tree

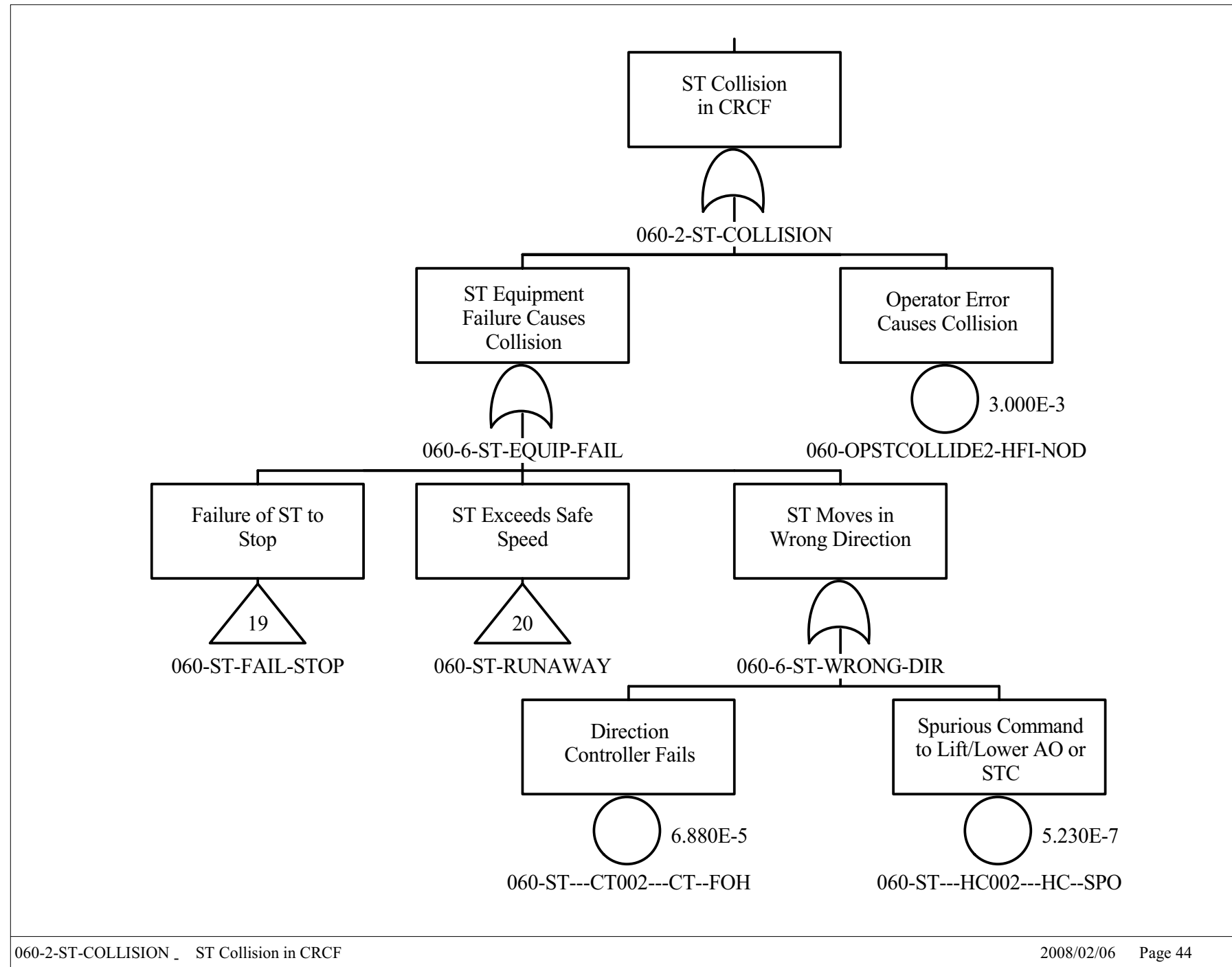

Source: Original

Figure B6.4-3. Site Transporter Collides with CRCF Structures Fault Tree

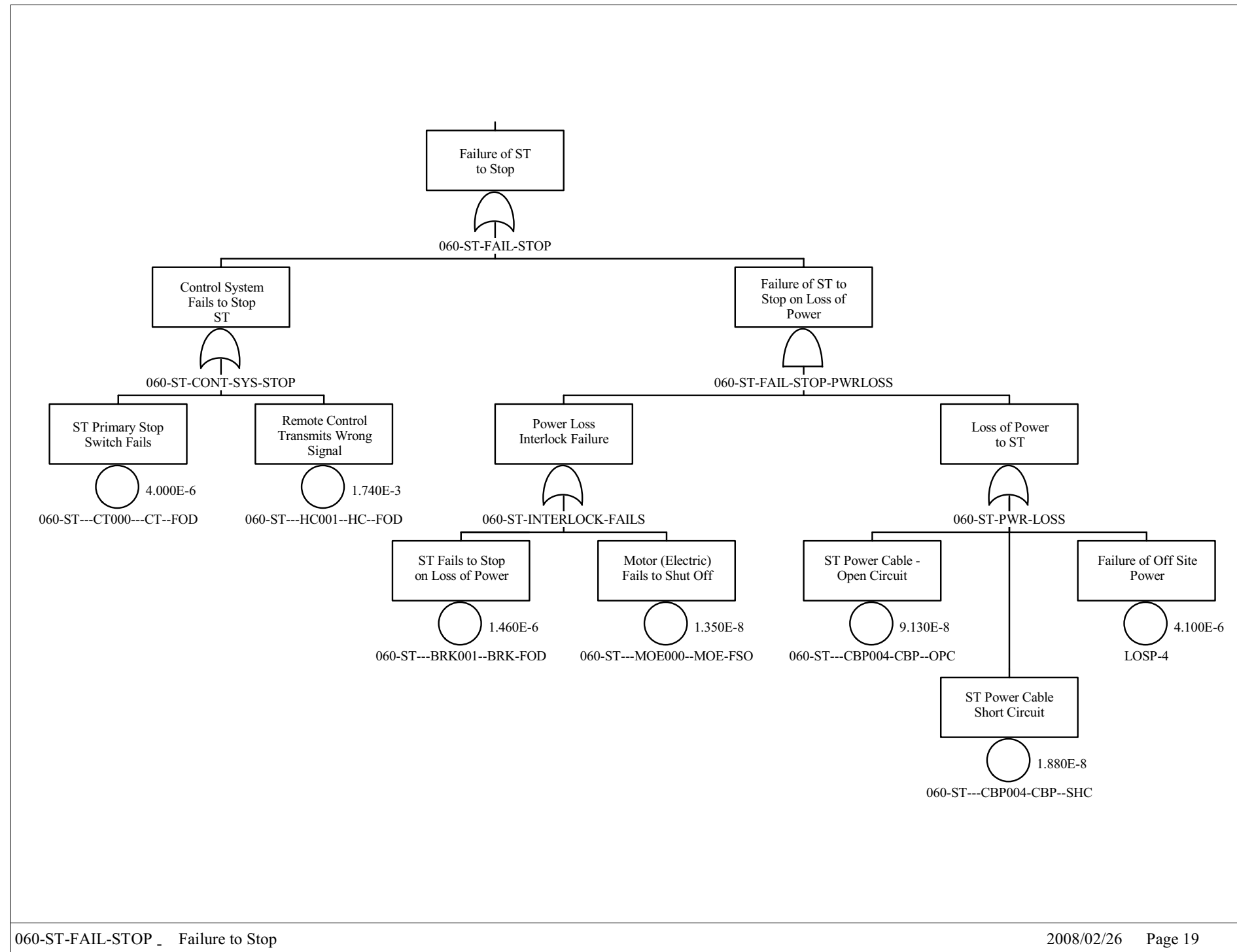

Source: Original

Figure B6.4-4. Site Transporter Collides with CRCF Structures – Failure to Stop

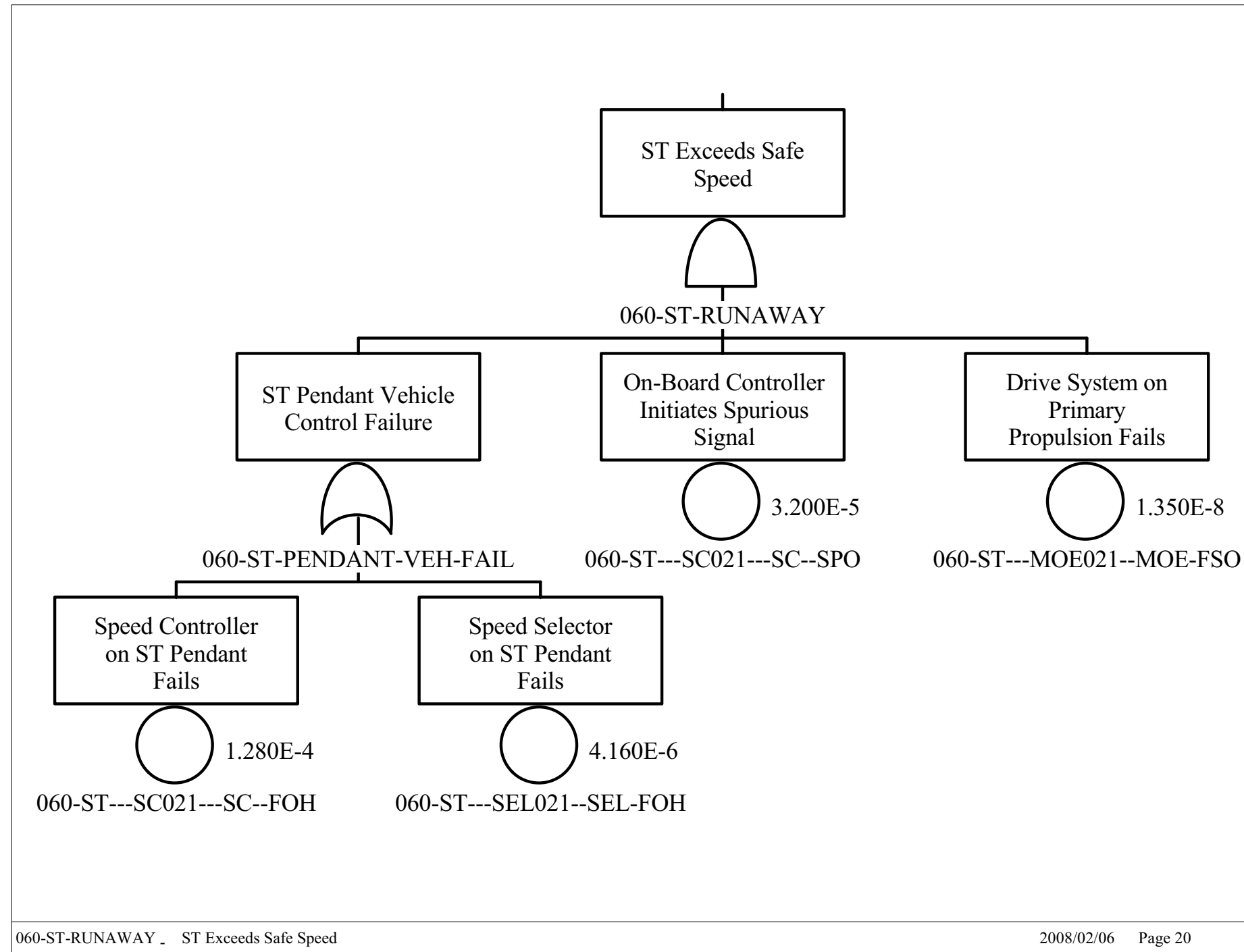

Source: Original

Figure B6.4-5. Site Transporter Collides with CRCF Structures – Site Transporter Exceeds Safe Speed

B6.4.2 Site Transporter Load Drop during Lift and Movement (ESD-02 and -16)

B6.4.2.1 Description

The site transporter conducts lift/lowering and movement operations at the aging pads and inside the facilities. Since the site transporter is only capable of performing one operation at a time it is not possible to move an aging overpack while it is being lifted/lowered. For activities associated with this ESD, there are four distinct failure modes. Those associated with electrical failures, site transporter controller failures, mechanical failures during lifting/lowering, and mechanical failures during movement.

B6.4.2.2 Success Criteria

The potential for a load drop exists when there is a loss of site transporter power, a mechanical failure of the lift/lowering devices, aging overpack restraint device failure during movement, or a failure of the site transporter control system during these operations.

If there is a failure of the electrical system during lifting/lower or movement, the ACME screw/nuts prevent the rear forks and the lift support arms from moving.

The ACME devices also serve to prevent a load drop when there is a lift boom failure. There are four of these devices. One on each of the rear forks and one on each of the lift support arms.

The aging overpack restraint system is engaged after the lift has been accomplished and released prior to performing a lowering operation. These devices restrict the movement of the aging overpack during transport. There are three of these restraints that prevent/restrict movement in the roll-pitch-axis. Pins are used in these devices that prevent the release of the restraint in the advent of an electromechanical failure that controls the position of these devices.

There is an interlock built-in to the restraint system. Movement of the site transporter is prevented until the three pins in the restraint system have been properly installed. These pins also preclude an inadvertent release of the restraint system since they have to be physically removed by the operator before the restraints can be released.

The receipt of inadvertent command signals is also prevented in that the site transporter can only perform one operation at a time due to the limitations in the power plant.

B6.4.2.3 Design Requirements and Features

Requirements

Facility power is removed from the site transporter when it has been properly positioned within the Cask Unloading Room.

On the loss or removal of AC power derived from the facility, the site transporter performs a controlled stop. Once stopped the site transporter enters the “lock mode,” safe state. The “lock mode,” safe state is not reversible without specific operator action.

Features

There are no electrical storage devices in the design of the site transporter. When the facility AC power cable is removed, the site transporter is incapable of movement.

Two operators have the capability of stopping any operation performed by the site transporter when it is inside a facility.

B6.4.2.4 Fault Tree Model

The fault tree model for site transporter drop load during lift and movement addresses:

- Electrical failures including motor and distribution events and the failure to enter a “lock mode,” safe state.
- A load drop during the lifting or lowering of the aging overpack which includes mechanical failure of the lifting booms and restraint/lifting arms.
- Failure of the aging overpack restraint subsystem during the lift/lowering/moving of the site transporter.
- Failure of the site transporter control subsystem.

NOTE: The fault tree defines the movement of the aging overpack in a three axis system as:

1. A roll movement side-to-side as the “R-axis”
2. A pitch movement front-to-back as the “P-axis”
3. An up or down movement as the “D-axis.”

B6.4.2.5 Basic Events

Table B6.4-4 lists the basic events used in the “Site Transporter Load Drop during Lift and Movement” fault tree.

Table B6.4-4. Basic Event Probability for the Site Transporter Load Drop during Lift and Movement Fault Tree

Basic Events Probability Report					
Project: Yucca-Mountain	Calc. Type ^a	Case : Current	Fail. Prob.	Lambda	Miss. Time ^a
ST Load Drop Lift/Movement		Units: Per Hour			
Name		Calc. Prob.			
060-CRWT-ATB1001-AT--FOH	3	7.54E-05	0.00E+00	7.54E-05	1.00E+00
060-CRWT-ATB1011-AT--FOH	3	7.54E-05	0.00E+00	7.54E-05	1.00E+00
060-CRWT-ATB2002-AT--FOH	3	7.54E-05	0.00E+00	7.54E-05	1.00E+00
060-CRWT-ATB222-AT--FOH	3	7.54E-05	0.00E+00	7.54E-05	1.00E+00
060-CRWT-ATD0002-AT-FOH	3	7.54E-05	0.00E+00	7.54E-05	1.00E+00
060-CRWT-ATD001-AT-FOH	3	7.54E-05	0.00E+00	7.54E-05	1.00E+00

Table B6.4-4. Basic Event Probability for the Site Transporter Load Drop during Lift and Movement
Fault Tree (Continued)

Basic Events Probability Report					
Project: Yucca-Mountain	Calc. Type ^a	Case : Current	Fail. Prob.	Lambda	Miss. Time ^a
ST Load Drop Lift/Movement		Units: Per Hour			
Name		Calc. Prob.			
060-CRWT-ATD03-AT-FOH	3	7.54E-05	0.00E+00	7.54E-05	1.00E+00
060-CRWT-ATD04-AT-FOH	3	7.54E-05	0.00E+00	7.54E-05	1.00E+00
060-CRWT-ATP002-AT-FOH	3	7.54E-05	0.00E+00	7.54E-05	1.00E+00
060-CRWT-ATR10002-AT-FOH	3	7.54E-05	0.00E+00	7.54E-05	1.00E+00
060-CRWT-EATR2004-AT-FOH	3	7.54E-05	0.00E+00	7.54E-05	1.00E+00
060-CRWT-BEA#1-BEA-BRK	3	2.40E-08	0.00E+00	2.40E-08	1.00E+00
060-CRWT-BEA22-BEA-BRK	3	2.40E-08	0.00E+00	2.40E-08	1.00E+00
060-CRWT-BEAB202-BEA-BRK	3	2.40E-08	0.00E+00	2.40E-08	1.00E+00
060-CRWT-BEAD003-BEA-BRK	3	2.40E-08	0.00E+00	2.40E-08	1.00E+00
060-CRWT-BEAD006-BEA-BRK	3	2.40E-08	0.00E+00	2.40E-08	1.00E+00
060-CRWT-BEAP02-BEA-BRK	3	2.40E-08	0.00E+00	2.40E-08	1.00E+00
060-CRWT-BEAR103-BEA-BRK	3	2.40E-08	0.00E+00	2.40E-08	1.00E+00
060-CRWT-BEAR204-BEA-BRK	3	2.40E-08	0.00E+00	2.40E-08	1.00E+00
060-CRWT-CBP0000-CBP-OPC	3	9.13E-08	0.00E+00	1.53E-07	1.00E+00
060-CRWT-CON0000-CON-FOH	3	7.10E-05	0.00E+00	7.10E-05	1.00E+00
060-CRWT-CTSHC000-CT-SPO	3	2.27E-05	0.00E+00	2.27E-05	1.00E+00
060-CRWT-DROP11-BEA-BRK	3	2.40E-08	0.00E+00	2.40E-08	1.00E+00
060-CRWT-ECP0000-ECP-FOH	3	1.79E-06	0.00E+00	1.79E-06	1.00E+00
060-CRWT-ELEC-MOE-FOD	1	6.00E-05	6.00E-05	0.00E+00	1.00E+00
060-CRWT-IEL0001-IEL-FOD	1	2.74E-05	2.74E-05	0.00E+00	1.00E+00
060-CRWT-LC000011-LC-FOD	1	6.25E-04	6.25E-04	0.00E+00	1.00E+00
060-CRWT-LVRD01-LVR-FOH	3	2.10E-06	0.00E+00	2.10E-06	1.00E+00
060-CRWT-LVRD02-LVR-FOH	3	2.10E-06	0.00E+00	2.10E-06	1.00E+00
060-CRWT-PIND004-PIN-BRK	3	2.12E-09	0.00E+00	2.12E-09	1.00E+00
060-CRWT-PIND005-PIN-BRK	3	2.12E-09	0.00E+00	2.12E-09	1.00E+00
060-CRWT-PINP04-PIN-BRK	3	2.12E-09	0.00E+00	2.12E-09	1.00E+00
060-CRWT-PINR103-PIN-BRK	3	2.12E-09	0.00E+00	2.12E-09	1.00E+00
060-CRWT-PINR202-PIN-BRK	3	2.12E-09	0.00E+00	2.12E-09	1.00E+00
060-CRWT-SJKB011-SJK-FOH	3	8.14E-06	0.00E+00	8.14E-06	1.00E+00
060-CRWT-SJKB101-SJK-FOH	3	8.14E-06	0.00E+00	8.14E-06	1.00E+00
060-CRWT-SJKB202-SJK-FOH	3	8.14E-06	0.00E+00	8.14E-06	1.00E+00
060-CRWT-SJKB22-SJK-FOH	3	8.14E-06	0.00E+00	8.14E-06	1.00E+00
060-CRWT-ZSD00005-ZS-FOD	1	2.93E-04	2.93E-04	0.00E+00	1.00E+00
060-CRWT-ZSD0006-ZS-FOD	1	2.93E-04	2.93E-04	0.00E+00	1.00E+00

Table B6.4-4. Basic Event Probability for the Site Transporter Load Drop during Lift and Movement
Fault Tree (Continued)

Basic Events Probability Report					
Project: Yucca-Mountain	Calc. Type ^a	Case : Current	Fail. Prob.	Lambda	Miss. Time ^a
ST Load Drop Lift/Movement		Units: Per Hour			
Name		Calc. Prob.			
060-CRWT-ZSP00003-ZS-FOD	1	2.93E-04	2.93E-04	0.00E+00	1.00E+00
060-CRWT-ZSR00005-ZS-FOD	1	2.93E-04	2.93E-04	0.00E+00	1.00E+00
060-ST-MOE0001-MOE-FSO	3	1.35E-08	0.00E+00	1.35E-08	1.00E+00

NOTE: ^a For Calc. Type 3 with a mission time of 0, SAPHIRE performs the quantification using the system mission time.

Calc. = calculation; Fail. = failure; Miss. = mission; ST = site transporter.

Source: Original

B6.4.2.5.1 Human Failure Events

There are no human error events incorporated in the tree.

B6.4.2.5.2 Common-cause Failures

There are no CCFs identified in this fault tree.

B6.4.2.6 Uncertainty and Cut Set Generation

Figures B6.4-6 and B6.4-7 contain the uncertainty and the cutset generation results for “Site Transporter Load Drop during Lift and Movement” fault tree using a cutoff probability of 1E-15.

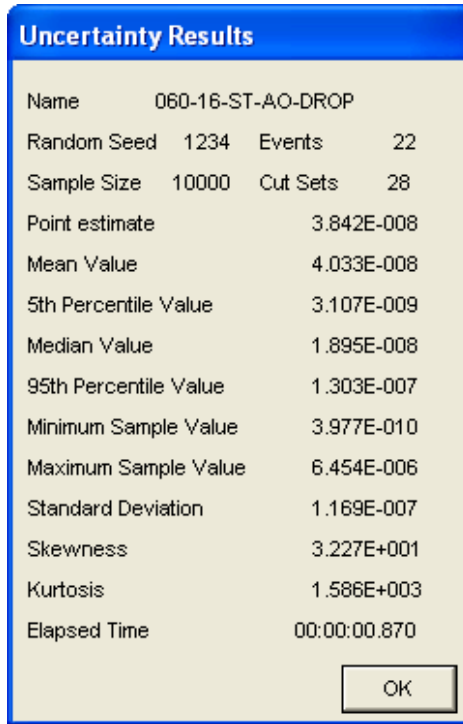

Source: Original

Figure B6.4-6. Uncertainty Results for Site Transporter Load Drop during Lift and Movement Fault Tree

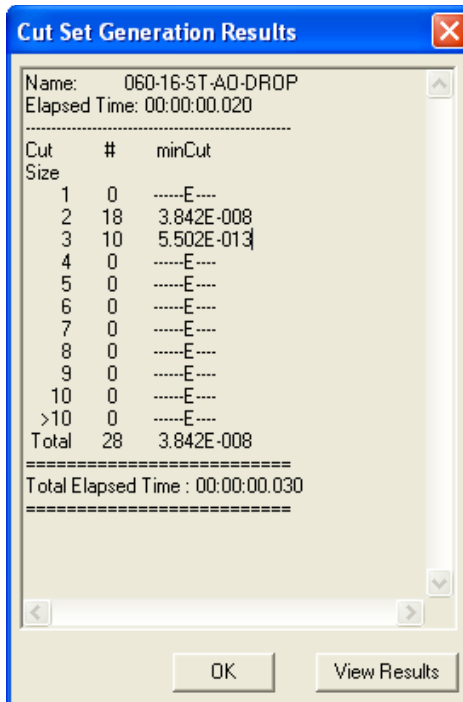

Source: Original

Figure B6.4-7. Cut Set Generation Results for Site Transporter Load Drop during Lift/Movement Fault Tree

B6.4.2.7 Cut Sets

Table B6.4-5 contains the cut sets for “Site Transporter Load Drop during Lift/Movement” fault tree.

Table B6.4-5. Cut Sets for Site Transporter Load Drop during Lift/Movement

Fault Tree	Cut Set %	Prob./Freq.	Basic Event	Description	Probability
060-16-ST-AO-DROP	36.92	1.419E-008	060-CRWT-CTSHC000-CT-SPO	Spurious Command to Raise/Lower AO or STC	2.3E-005
			060-CRWT-LM00011-LC-FOD	ST Lift/Lower Selector Lever Fails	6.2E-004
	20.97	8.058E-009	060-CRWT-IEL0001-IEL-FOD	Restraint System Interlock Failure	2.8E-005
			060-CRWT-ZSD00005-ZS-FOD	ST D-Axis Position Switch Failure Movement	2.9E-004
	20.97	8.058E-009	060-CRWT-IEL0001-IEL-FOD	Restraint System Interlock Failure	2.8E-005
			060-CRWT-ZSP00003-ZS-FOD	ST P-Axis Position Switch Failure During Movement	2.9E-004
	20.97	8.058E-009	060-CRWT-IEL0001-IEL-FOD	Restraint System Interlock Failure	2.8E-005
			060-CRWT-ZSR00005-ZS-FOD	ST R-Axis Position Switch Failure Movement	2.9E-004
	0.11	4.063E-011	060-CRWT-CTSHC000-CT-SPO	Spurious Command to Raise/Lower AO or STC	2.3E-005
			060-CRWT-ECP0000-ECP-FOH	ST Restraint Arms Position Selector Fails	1.8E-006
	0.02	7.032E-012	060-CRWT-BEA22-BEA-BRK	Boom#2 Fails During Cask Lift	2.4E-008
			060-CRWT-ZSD00006-ZS-FOD	ST D-Axis Position Switch Failure Lift/Lower	2.9E-004
	0.02	7.032E-012	060-CRWT-DROP11-BEA-BRK	Boom#1 Fails During Cask Lift	2.4E-008
			060-CRWT-ZSD00006-ZS-FOD	ST D-Axis Position Switch Failure Lift/Lower	2.9E-004
	0.00	1.810E-012	060-CRWT-ATD0002-AT--FOH	ST D-Axis Electrical Actuator #2 Fails Lift/Lower	7.5E-005
			060-CRWT-BEA22-BEA-BRK	Boom#2 Fails During Cask Lift	2.4E-008
	0.00	1.810E-012	060-CRWT-ATD0002-AT--FOH	ST D-Axis Electrical Actuator #2 Fails Lift/Lower	7.5E-005
			060-CRWT-DROP11-BEA-BRK	Boom#1 Fails During Cask Lift	2.4E-008
	0.00	1.810E-012	060-CRWT-ATD0001-AT--FOH	ST D-Axis Electrical Actuator #1 Fails Lift/Lower	7.5E-005
			060-CRWT-BEA22-BEA-BRK	Boom#2 Fails During Cask Lift	2.4E-008
	0.00	1.810E-012	060-CRWT-ATD0001-AT--FOH	ST D-Axis Electrical Actuator #1 Fails Lift/Lower	7.5E-005
			060-CRWT-DROP11-BEA-BRK	Boom#1 Fails During Cask Lift	2.4E-008

Table B6.4-5. Cut Sets for Site Transporter Load Drop during Lift/Movement (Continued)

Fault Tree	Cut Set %	Prob./Freq.	Basic Event	Description	Probability
	0.00	9.639E-013	060-CRWT- CON0000-CON- FOH	Electrical Power Dist Connectors Fail on ST	7.1E-005
			060-ST-MOE0001- MOE-FSO	ST Lock Mode State Fails on Loss of Power	1.4E-008
	0.00	8.100E-013	060-CRWT-ELEC- MOE-FOD	ST Electric Motor Failure	6.0E-005
			060-ST-MOE0001- MOE-FSO	ST Lock Mode State Fails on Loss of Power	1.4E-008
	0.00	1.798E-013	060-CRWT- ATB1001-AT--FOH	Screw Actuator Mechanism on Lift Boom #1 Fails	7.5E-005
			060-CRWT- SJKB101-SJK-FOH	Screw Lift on Boom #1 Fails	8.1E-006
			060-CRWT- ZSD0006-ZS-FOD	ST D-Axis Position Switch Failure Lift/Lower	2.9E-004
	0.00	1.798E-013	060-CRWT- ATB2002-AT--FOH	Screw Actuator Mechanism on Lift Boom #2 Fails	7.5E-005
			060-CRWT-SJKB22- SJK-FOH	Screw Lift on Boom #2 Fails	8.1E-006
			060-CRWT- ZSD0006-ZS-FOD	ST D-Axis Position Switch Failure Lift/Lower	2.9E-004
	0.00	5.040E-014	060-CRWT-BEA22- BEA-BRK	Boom#2 Fails During Cask Lift	2.4E-008
			060-CRWT- LVRD01-LVR-FOH	ST D-Axis Actuator Structural Arm #1 Failure	2.1E-006
	0.00	5.040E-014	060-CRWT-BEA22- BEA-BRK	Boom#2 Fails During Cask Lift	2.4E-008
			060-CRWT- LVRD02-LVR-FOH	ST D-Axis Actuator Structural Arm #2 Failure	2.1E-006
	0.00	5.040E-014	060-CRWT- DROP11-BEA-BRK	Boom#1 Fails During Cask Lift	2.4E-008
			060-CRWT- LVRD01-LVR-FOH	ST D-Axis Actuator Structural Arm #1 Failure	2.1E-006
	0.00	5.040E-014	060-CRWT- DROP11-BEA-BRK	Boom#1 Fails During Cask Lift	2.4E-008
			060-CRWT- LVRD02-LVR-FOH	ST D-Axis Actuator Structural Arm #2 Failure	2.1E-006
	0.00	4.627E-014	060-CRWT- ATB1001-AT--FOH	Screw Actuator Mechanism on Lift Boom #1 Fails	7.5E-005
			060-CRWT- ATD0002-AT--FOH	ST D-Axis Electrical Actuator #2 Fails Lift/Lower	7.5E-005
			060-CRWT- SJKB101-SJK-FOH	Screw Lift on Boom #1 Fails	8.1E-006
	0.00	4.627E-014	060-CRWT- ATB1001-AT--FOH	Screw Actuator Mechanism on Lift Boom #1 Fails	7.5E-005
			060-CRWT-ATD001- AT--FOH	ST D-Axis Electrical Actuator #1 Fails Lift/Lower	7.5E-005
			060-CRWT- SJKB101-SJK-FOH	Screw Lift on Boom #1 Fails	8.1E-006

Table B6.4-5. Cut Sets for Site Transporter Load Drop during Lift/Movement (Continued)

Fault Tree	Cut Set %	Prob./Freq.	Basic Event	Description	Probability
	0.00	4.627E-014	060-CRWT-ATB2002-AT--FOH	Screw Actuator Mechanism on Lift Boom #2 Fails	7.5E-005
			060-CRWT-ATD0002-AT--FOH	ST D-Axis Electrical Actuator #2 Fails Lift/Lower	7.5E-005
			060-CRWT-SJKB22-SJK-FOH	Screw Lift on Boom #2 Fails	8.1E-006
	0.00	4.627E-014	060-CRWT-ATB2002-AT--FOH	Screw Actuator Mechanism on Lift Boom #2 Fails	7.5E-005
			060-CRWT-ATD001-AT--FOH	ST D-Axis Electrical Actuator #1 Fails Lift/Lower	7.5E-005
			060-CRWT-SJKB22-SJK-FOH	Screw Lift on Boom #2 Fails	8.1E-006
	0.00	1.289E-015	060-CRWT-ATB1001-AT--FOH	Screw Actuator Mechanism on Lift Boom #1 Fails	7.5E-005
			060-CRWT-LVRD01-LVR-FOH	ST D-Axis Actuator Structural Arm #1 Failure	2.1E-006
			060-CRWT-SJKB101-SJK-FOH	Screw Lift on Boom #1 Fails	8.1E-006
	0.00	1.289E-015	060-CRWT-ATB1001-AT--FOH	Screw Actuator Mechanism on Lift Boom #1 Fails	7.5E-005
			060-CRWT-LVRD02-LVR-FOH	ST D-Axis Actuator Structural Arm #2 Failure	2.1E-006
			060-CRWT-SJKB101-SJK-FOH	Screw Lift on Boom #1 Fails	8.1E-006
	0.00	1.289E-015	060-CRWT-ATB2002-AT--FOH	Screw Actuator Mechanism on Lift Boom #2 Fails	7.5E-005
			060-CRWT-LVRD01-LVR-FOH	ST D-Axis Actuator Structural Arm #1 Failure	2.1E-006
			060-CRWT-SJKB22-SJK-FOH	Screw Lift on Boom #2 Fails	8.1E-006
	0.00	1.289E-015	060-CRWT-ATB2002-AT--FOH	Screw Actuator Mechanism on Lift Boom #2 Fails	7.5E-005
			060-CRWT-LVRD02-LVR-FOH	ST D-Axis Actuator Structural Arm #2 Failure	2.1E-006
			060-CRWT-SJKB22-SJK-FOH	Screw Lift on Boom #2 Fails	8.1E-006
	0.00	1.233E-015	060-CRWT-CBP0000-CBP-OPC	Electrical Power Dist Cable Failure on ST	9.1E-008
			060-ST-MOE0001-MOE-FSO	ST Lock Mode State Fails on Loss of Power	1.4E-008
		3.842E-008	= Total		

NOTE: AO = aging overpack; Freq. = frequency, Prob. = probability; ST = site transporter; STC = shielded transfer cask.

Source: Original

B6.4.2.8 Fault Trees

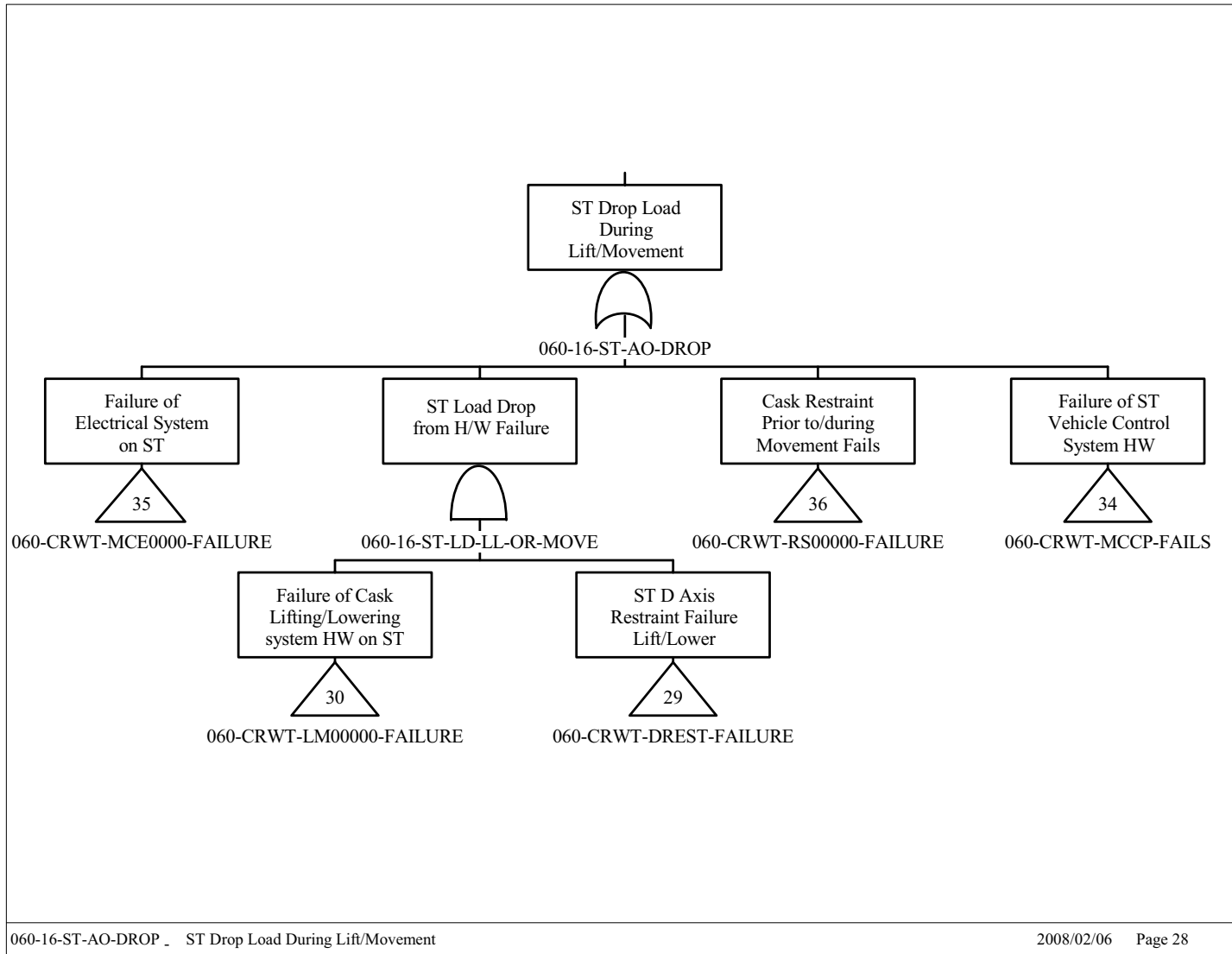

B6-27

March 2008

Source: Original

Figure B6.4-8. Site Transporter Drop Load During Lift/Movement

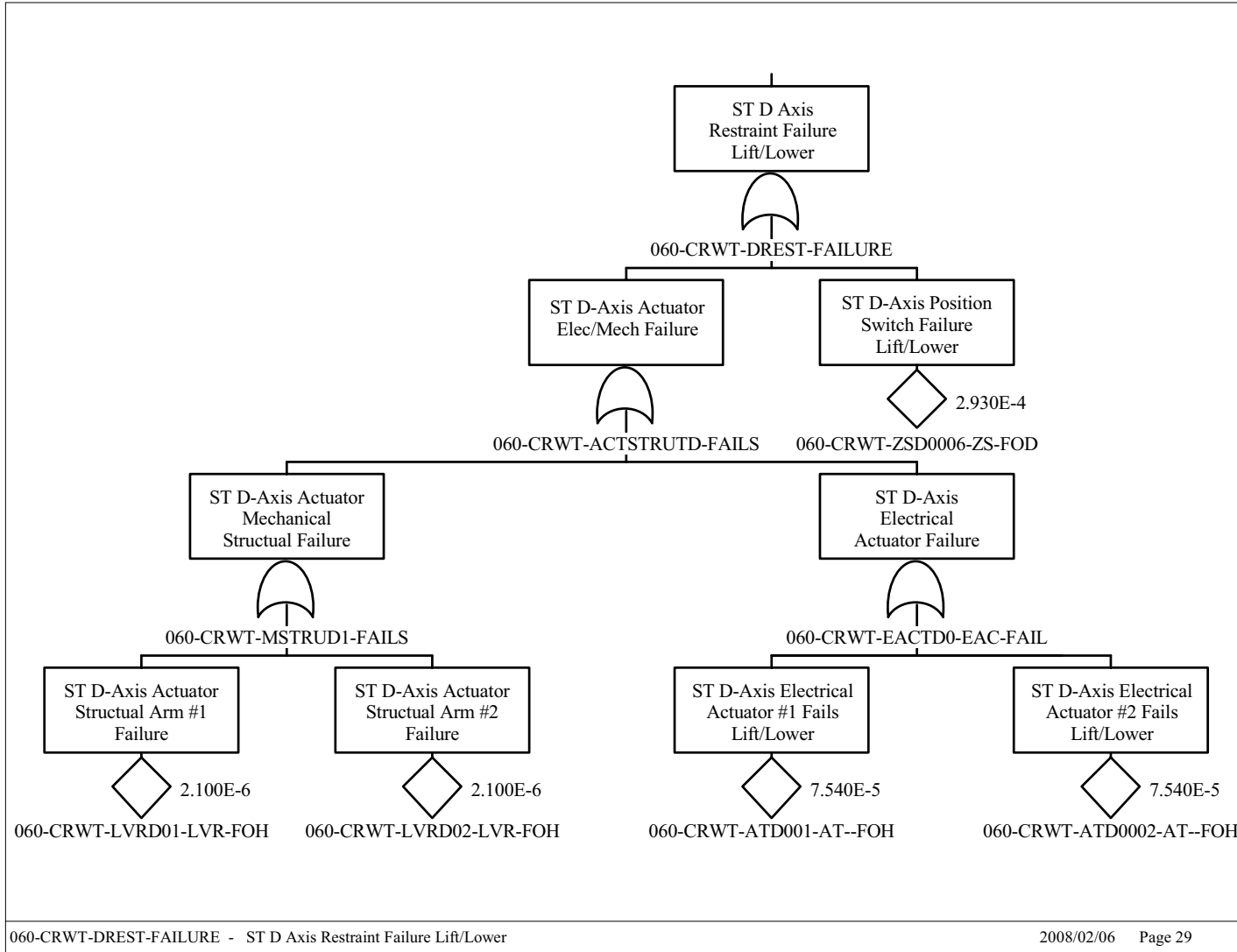

B6-28

March 2008

Source: Original

Figure B6.4-9. Site Transporter Drop Axis Restraint Failure Lift/Lower

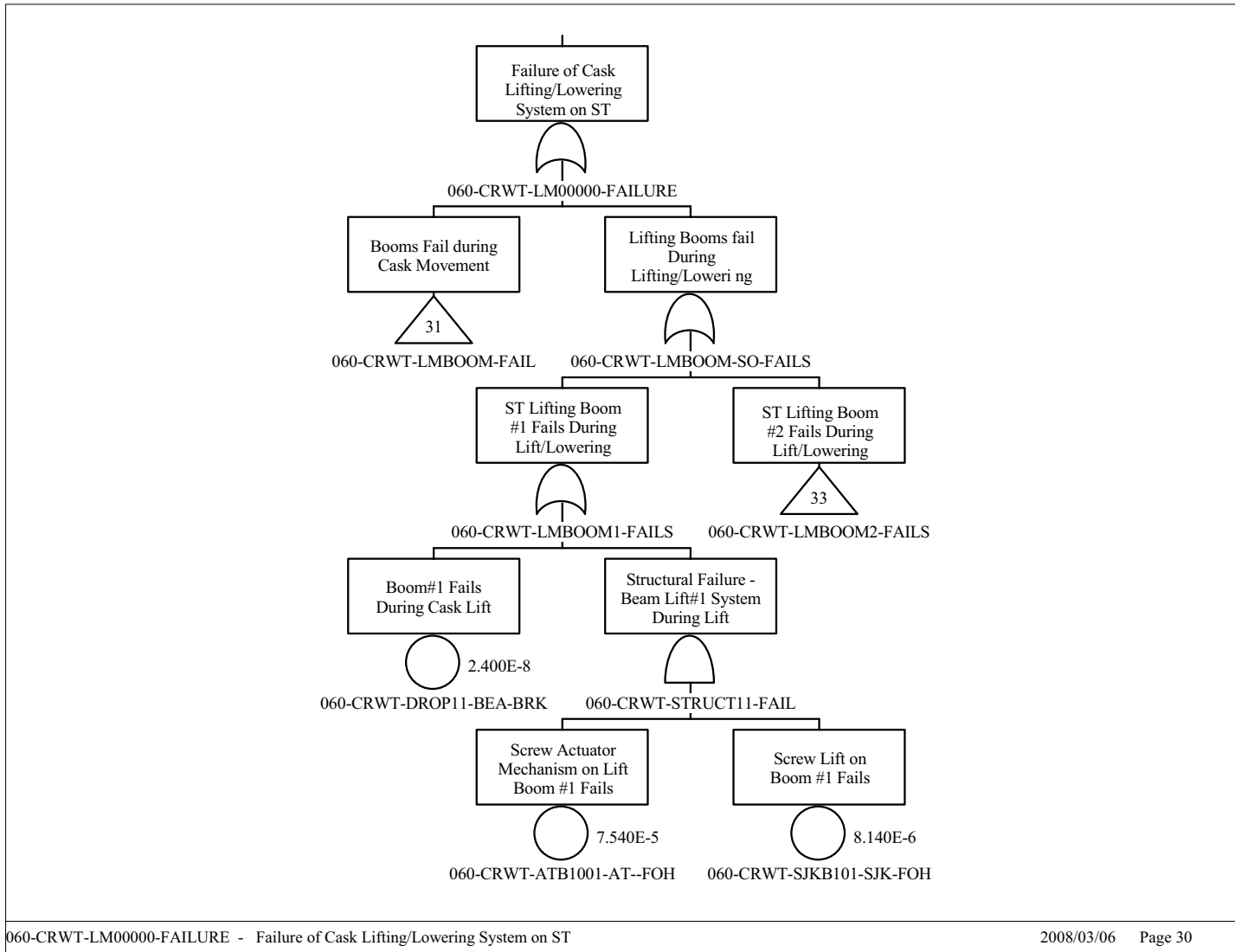

B6-29

March 2008

Source: Original

Figure B6.4-10. Failure of Cask Lifting/Lowering System on Site Transporter

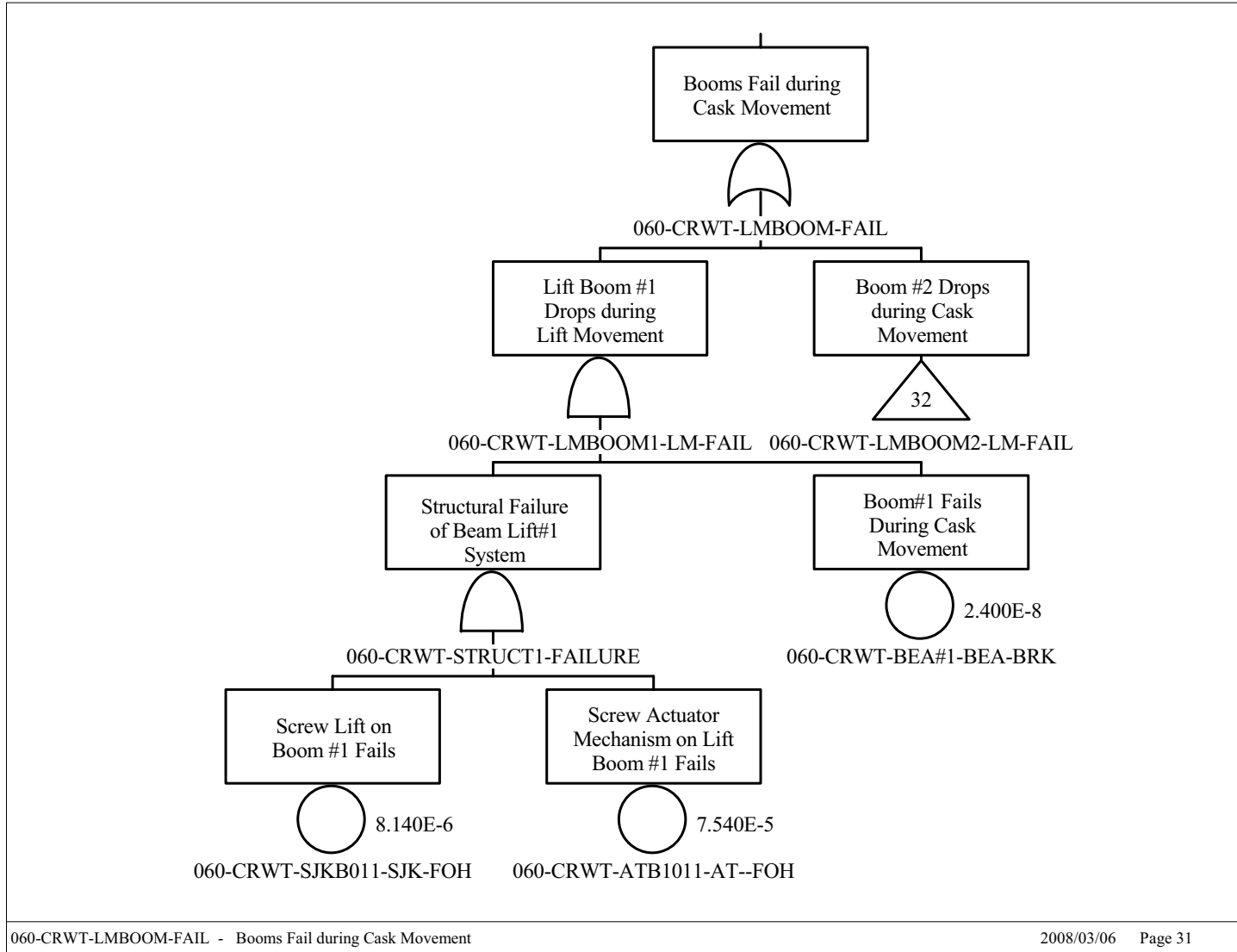

B6-30

March 2008

Source: Original

Figure B6.4-11. Booms Fail During Cask Movement

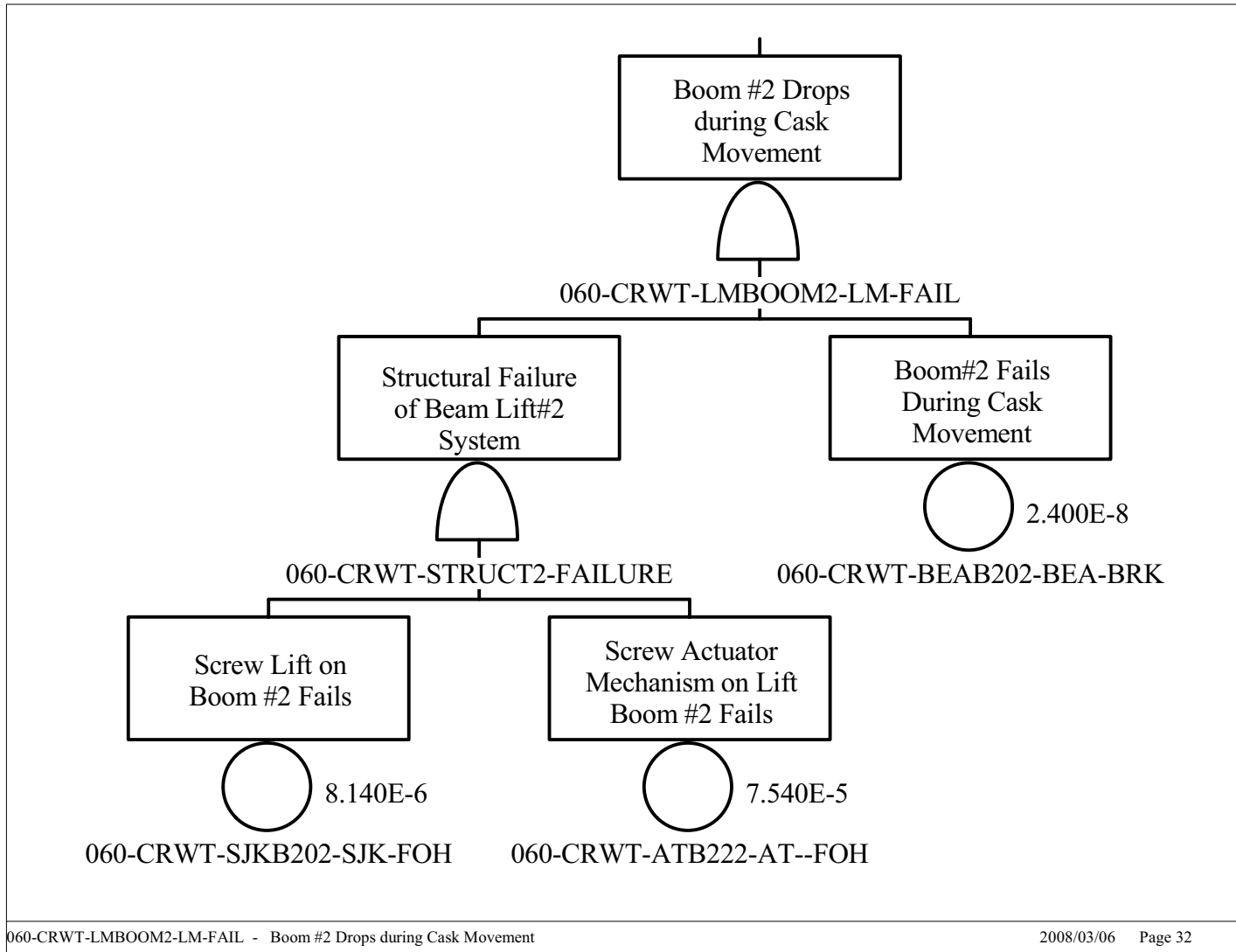

B6-31

March 2008

Source: Original

Figure B6.4-12. Boom#2 Drops During Cask Movement

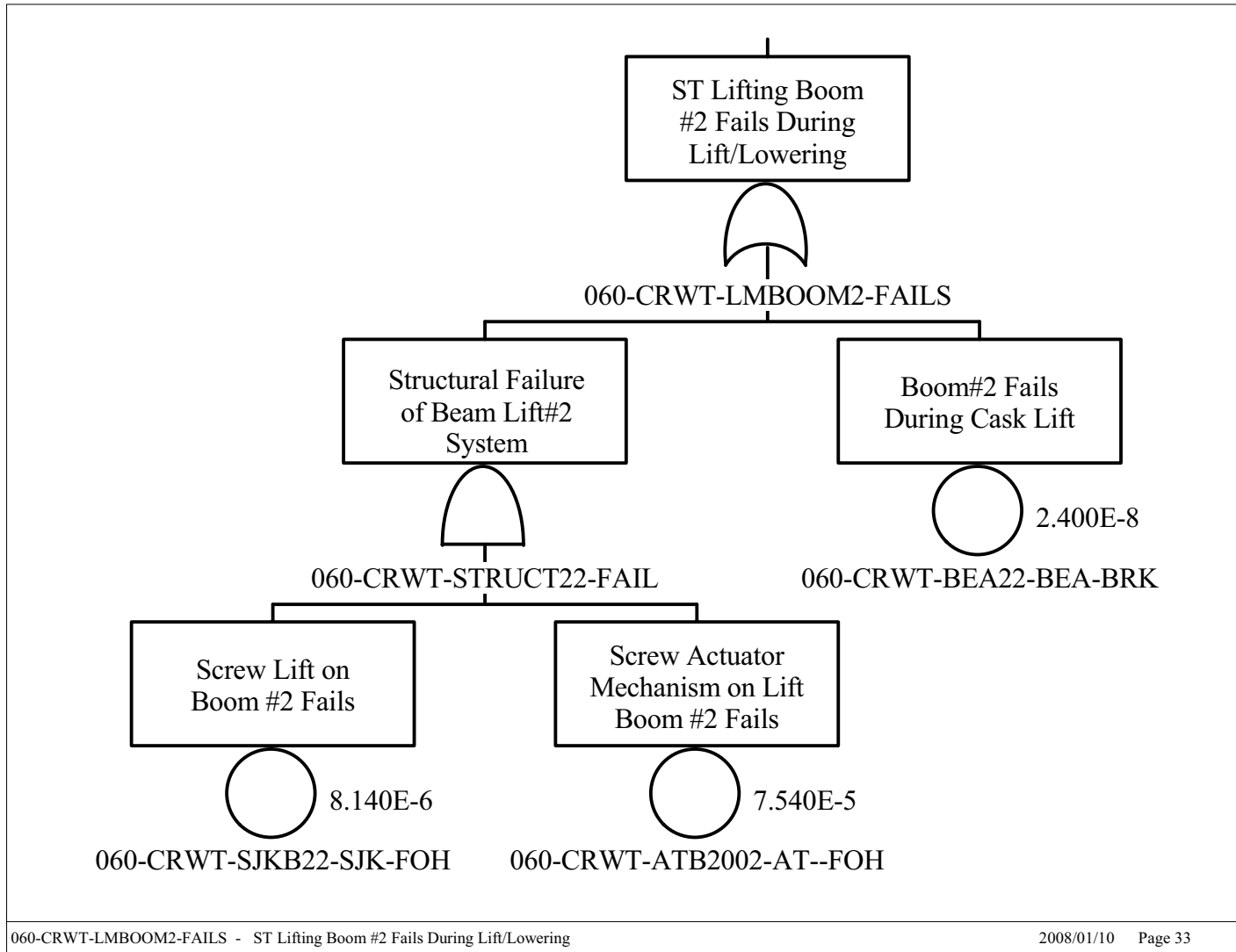

B6-32

Source: Original

Figure B6.4-13. Site Transporter Lifting Boom #2 Fails During Lift/Lowering

March 2008

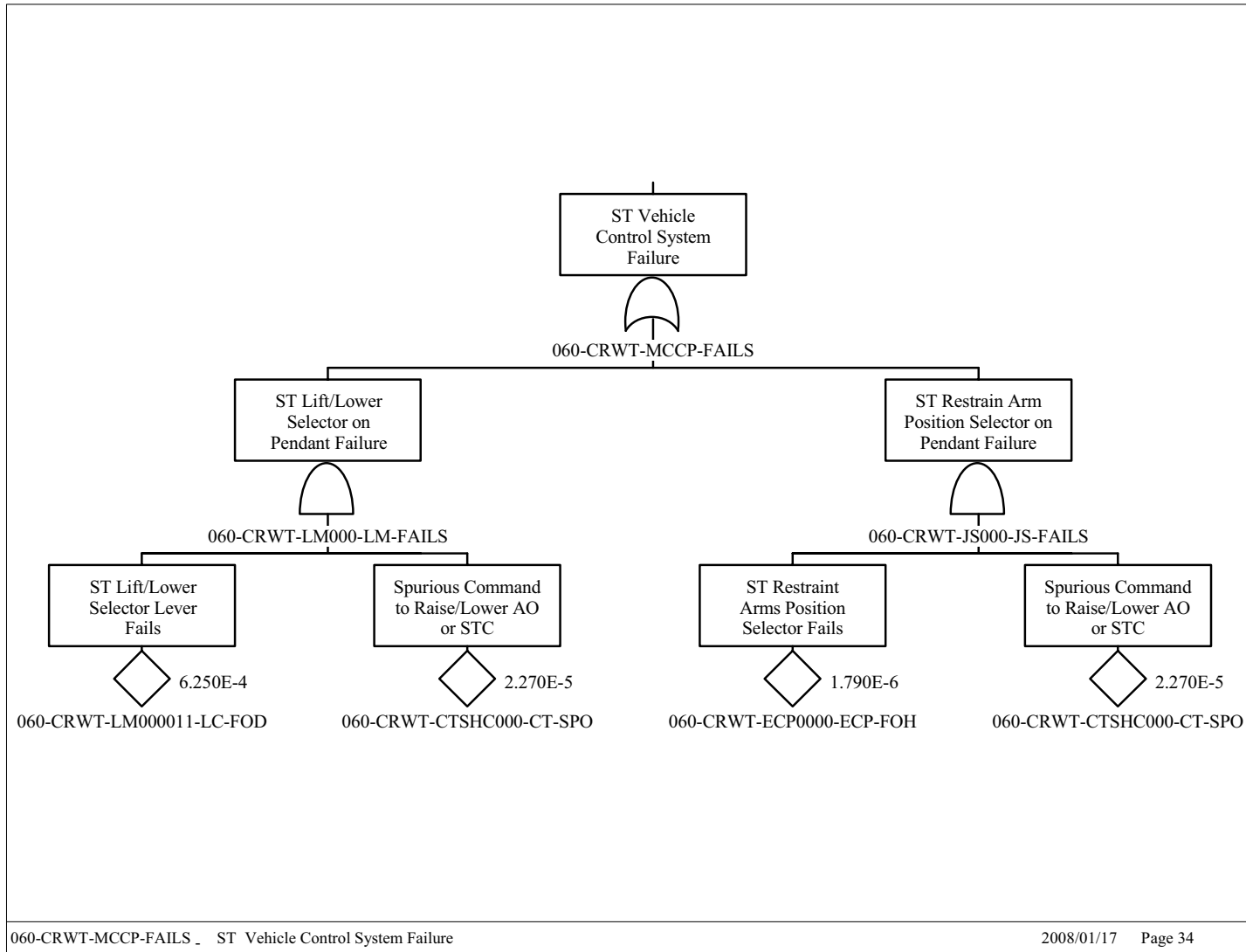

B6-33

Source: Original

Figure B6.4-14. Site Transporter Vehicle Control System Failure

March 2008

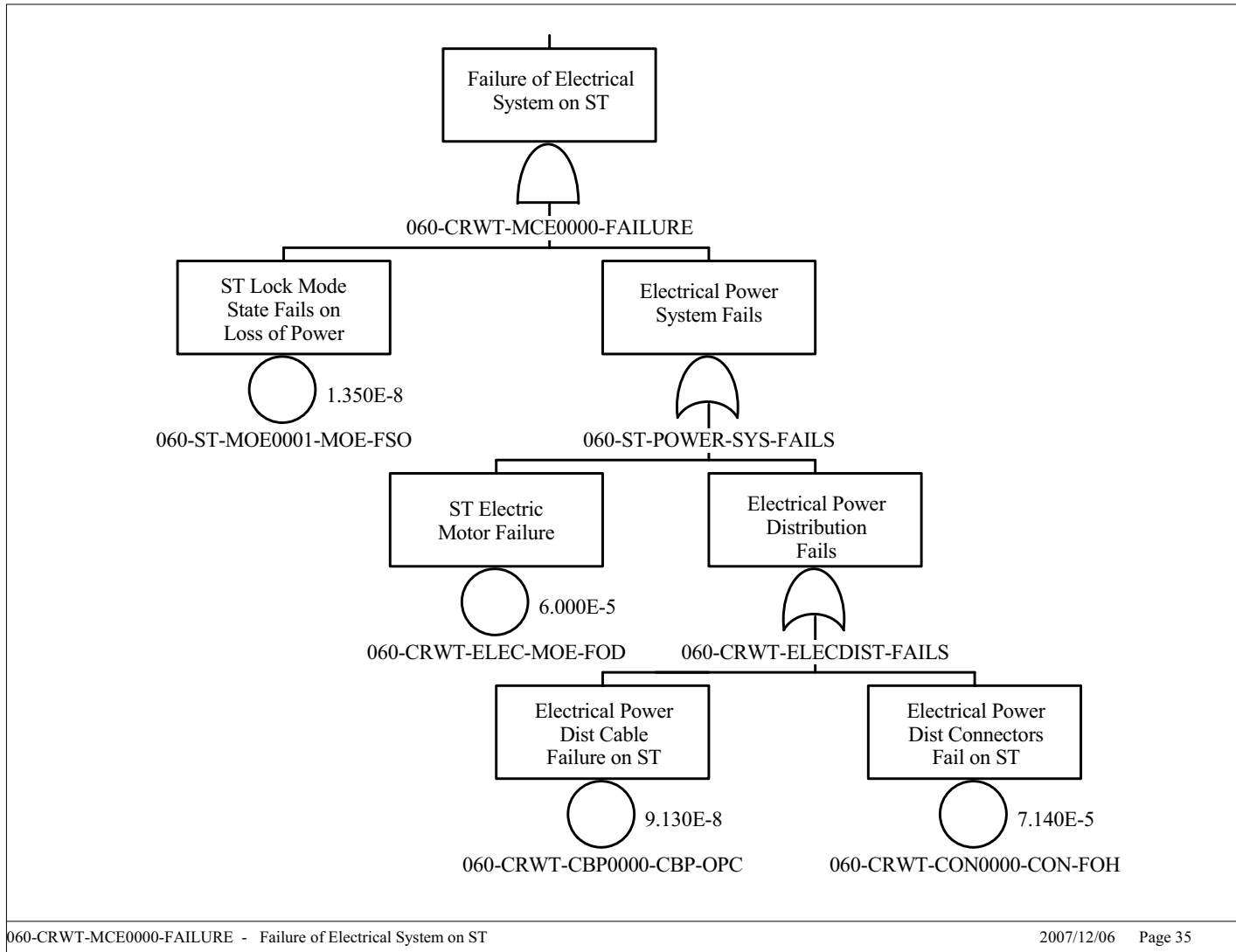

B6-34

Source: Original

Figure B6.4-15. Failure of Electrical System on Site Transporter

March 2008

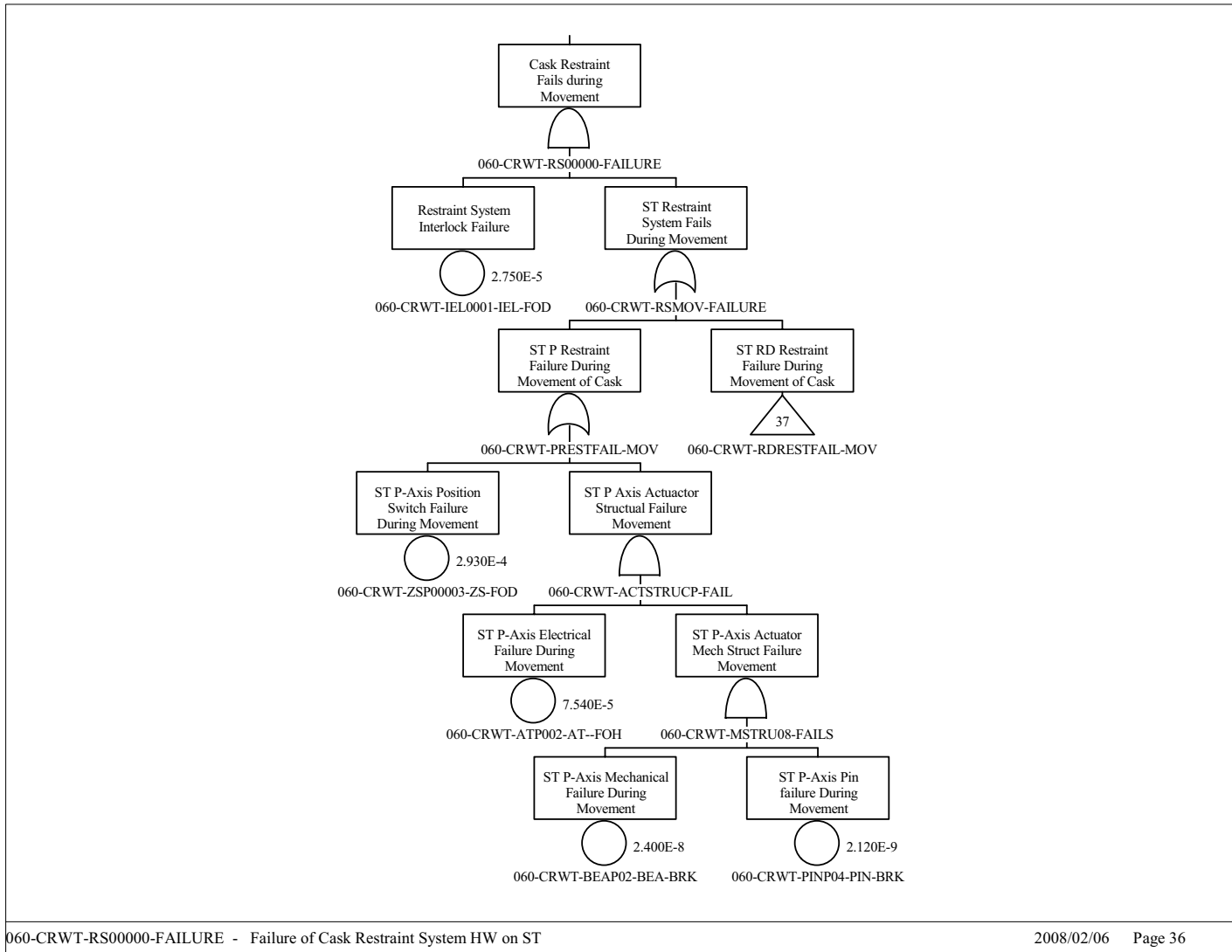
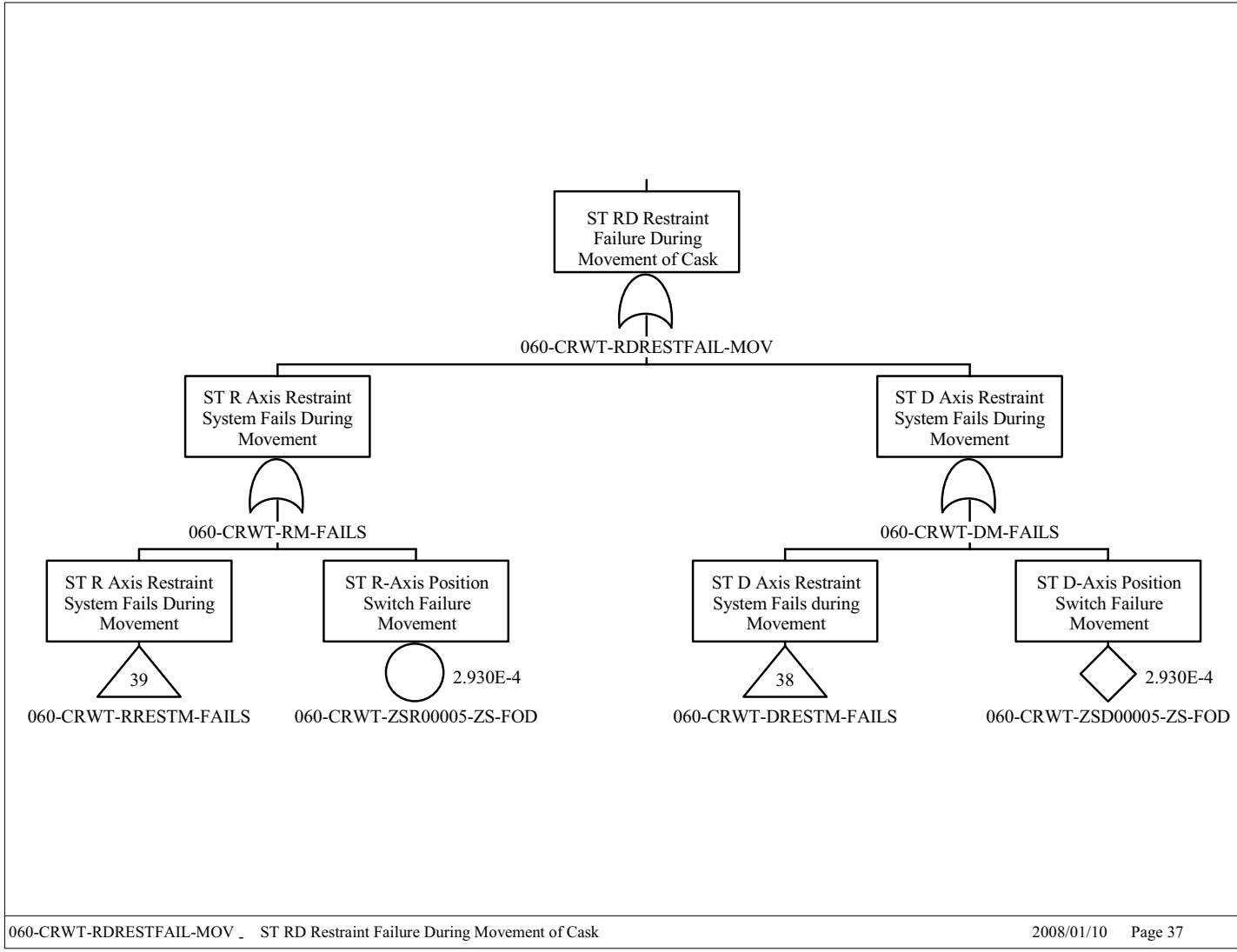

Figure B6.4-16. Cask Restraint Fails During Movement

Source: Original



B6-36

March 2008

Source: Original

Figure B6.4-17. Site Transporter Roll/Drop Restraint Failure During Movement of Cask

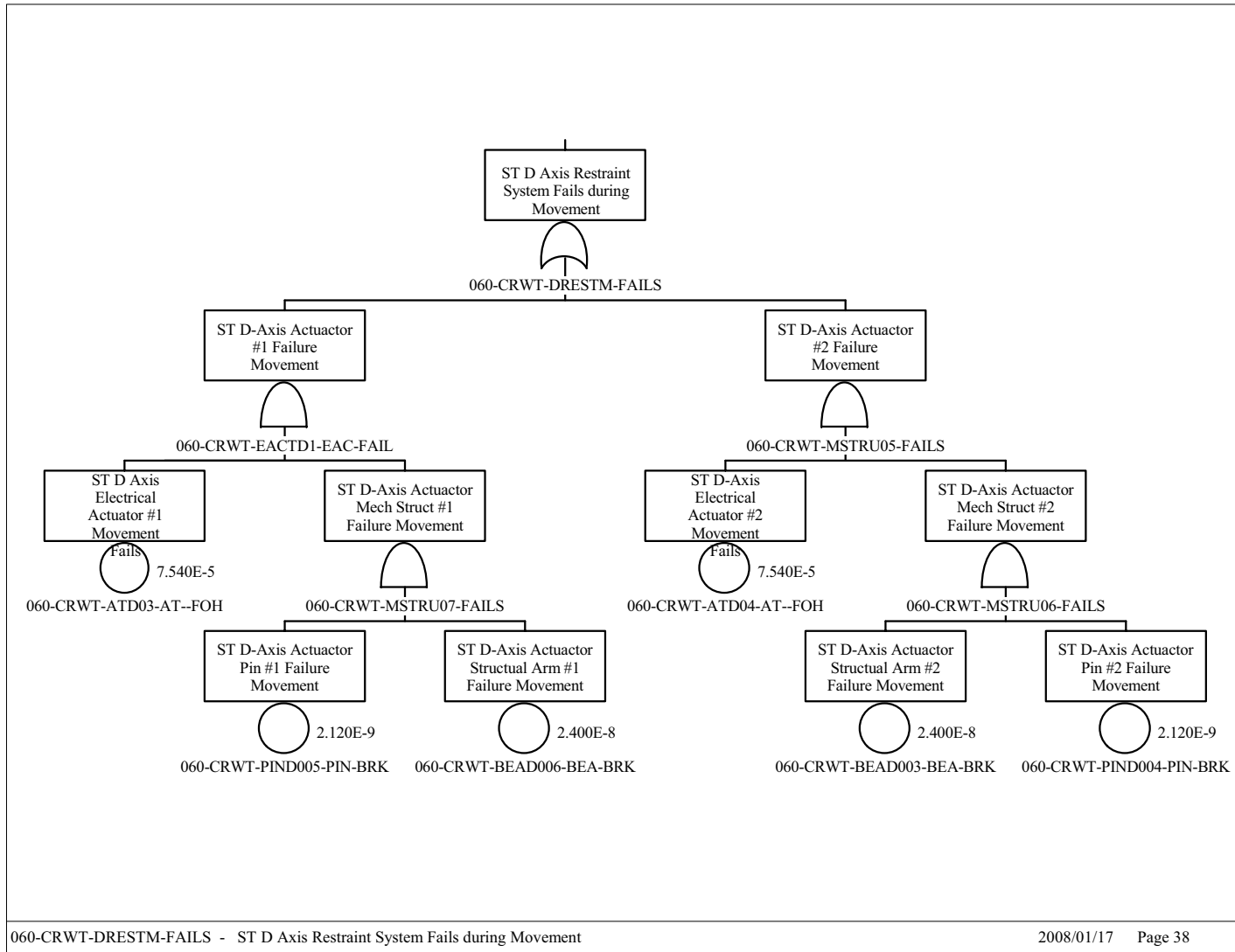
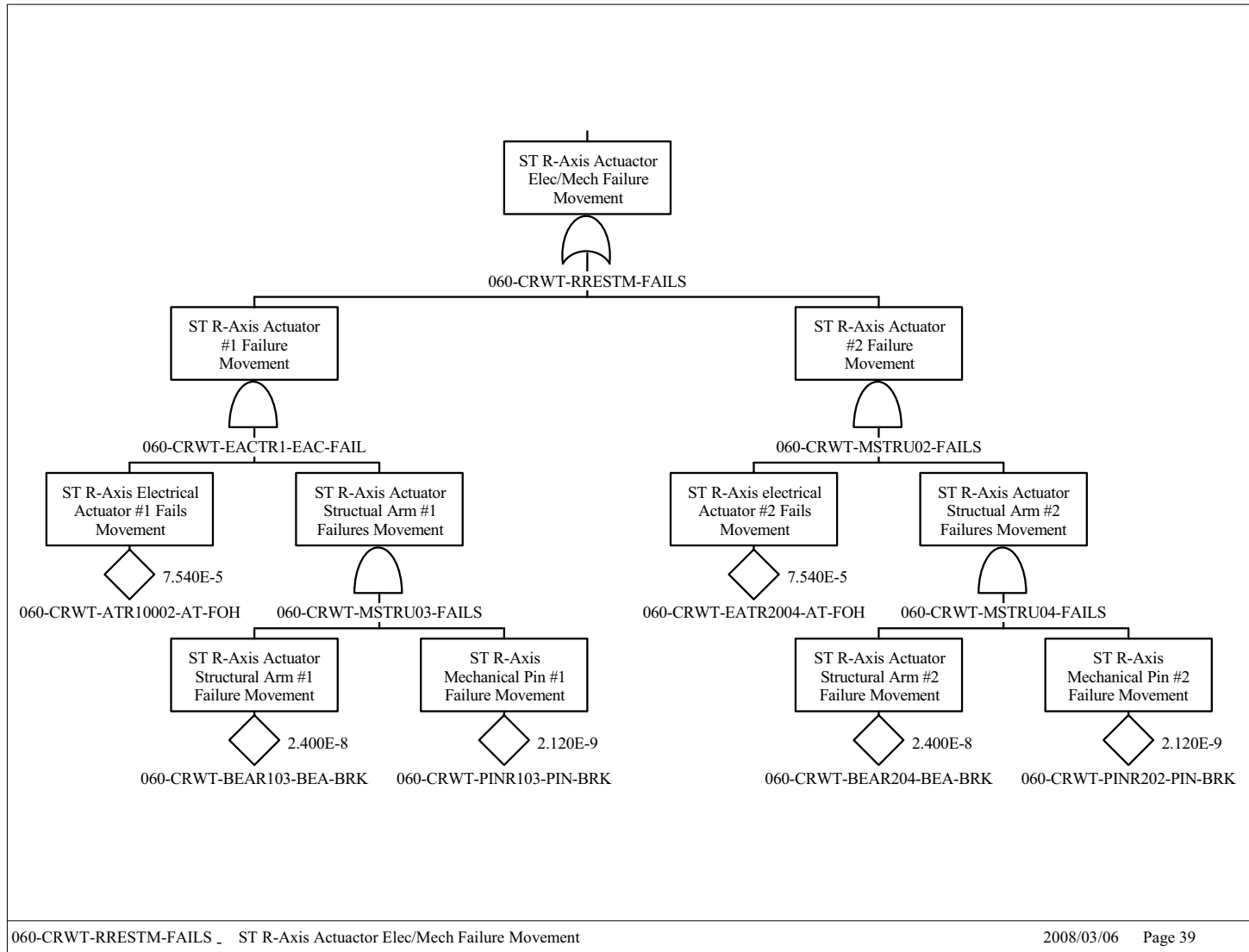

Figure B6.4-18. Site Transporter Drop Axis Restraint System Fails during Movement

Source: Original

B6-37

March 2008



B6-38

March 2008

Source: Original

Figure B6.4-19. Site Transporter Roll-Axis Actuator Electrical/Mechanical Failure Movement

B6.4.3 Site Transporter Rollover (Tipover) (ESD-02, ESD-16)

B6.4.3.1 Description

Although the site transporter has been designed to have a low center of gravity and a wide footprint, there is a possibility of a rollover caused by a track failure with a subsequent operator failure to stop the site transporter upon loss of a track. The track would have to fail in a manner such that it binds (i.e., rolls up), the site transporter drives over the failed track, and the site transporter tilts to an angle that results in a tipover condition.

B6.4.3.2 Success Criteria

The design of the site transporter prevents the majority of events that could potentially cause a site transporter rollover. The site transporter is designed to negotiate a 5% grade and a 2% cross-slope. In addition, the aging overpack is mechanically prevented from being lifted more than 12 inches. The combination of the low lift height of the aging overpack, the low center of gravity, and the wide footprint of the site transporter results in stable platform during movement.

During movement, a site transporter track failure could result in a potential tipover situation. There is no design constraint for this failure mode, preventing this situation relies on operator awareness and response time to this situation to initiate an emergency stop command. The operator has several seconds to respond to the track failure; however, since this is a recovery action, no credit is taken for the operator response.

B6.4.3.3 Design Requirements and Features

Requirements

Operator has the capability of stopping the site transporter in sufficient time to keep the site transporter from running off the end of a broken track.

Features

The center of gravity of a loaded site transporter with aging overpack, ensures stability.

The site transporter operator has the capability to stop the operation of the site transporter during abnormal conditions.

B6.4.3.4 Fault Tree Model

Human error is conservatively postulated to result in a rollover/tipover if the operator does not stop the site transporter in sufficient time to prevent the site transporter from running off the broken track.

B6.4.3.5 Basic Events

Table B6.4-6 lists the basic events used in the site transporter drop load during lift/movement fault tree. Uncertainty and cut set results are provided in Figures B6.4-20 and B6.4-21 respectively.

Table B6.4-6. Basic Event Probability for the Site Transporter Rollover

Basic Events Probability Report					
Project: Yucca-Mountain	Calc. Type ^a	Case : Current	Fail. Prob.	Lambda	Miss. Time ^a
ST Rollover		Units: Per Hour			
Name		Calc. Prob.			
060-CRWT-TRD0001-TRD-FOH	3	5.89E-007	0.00E+00	5.89E-007	1.00E+00
060-CRWT-TRD0002-TRD-FOH	3	5.89E-007	0.00E+00	5.89E-007	1.00E+00
060-CRWT-TRD0003-TRD-FOH	3	5.89E-007	0.00E+00	5.89E-007	1.00E+00
060-CRWT-TRD0004-TRD-FOH	3	5.89E-007	0.00E+00	5.89E-007	1.00E+00
060-CRWT-TRK0001-TRD-FOH	3	5.89E-007	0.00E+00	5.89E-007	1.00E+00
060-OP-FAILSTOP-HFI-NOD	1	1.00E+000	1.00E+00	0.00E+000	1.00E+00

NOTE: ^a For Calc. Type 3 with a mission time of 0, SAPHIRE performs the quantification using the system mission time.

Calc. = Calculation; Fail. = failure; Miss. = mission; Prob. = probability.

Source: Original

B6.4.3.5.1 Human Failure Events

There is one human error failure event included in this model. It is conservatively set to a value of 1E+0 because unsafe actions that require an equipment failure to cause an initiating event are generically assigned a screening HEP of 1.0 (Table E6.4-1).

B6.4.3.5.2 Common Cause Failures

There is no common-cause failure identified for this fault tree in that the failure of one track could potentially result in a rollover (tipover).

B6.4.3.6 Uncertainty and Cut Set Generation

Figures B6.4-20 and B6.4-21 contain the uncertainty and the cut set generation results for the “Site Transporter Rollover (Tipover)” fault tree using a cutoff probability of 1E-15.

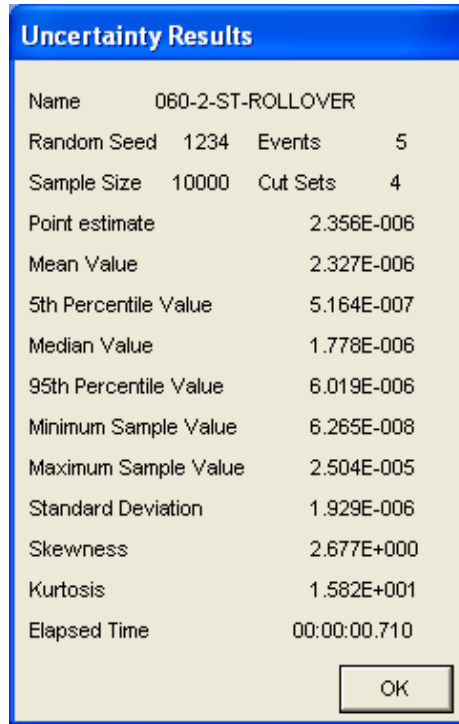

Source: Original

Figure B6.4-20. Uncertainty Results for the Site Transporter Rollover (Tipover) Fault Tree

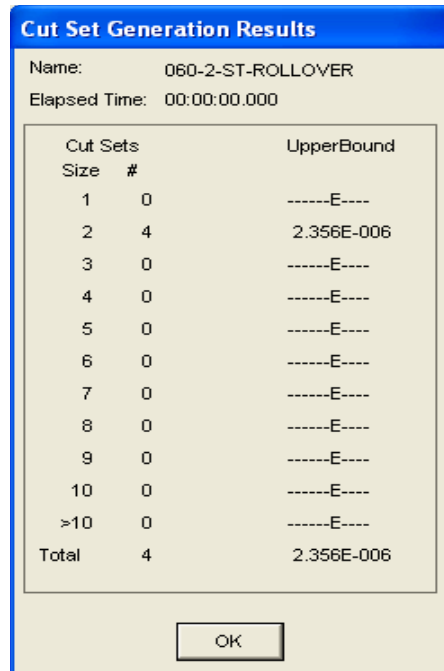

Source: Original

Figure B6.4-21. Cut Set Generation Transporter Rollover Results for the Site Transporter Rollover (Tipover) Fault Tree

B6.4.3.7 Cut Sets

Table B6.4-7 contains the cut sets for the “Site Transporter Rollover” fault tree.

Table B6.4-7. Cut Sets for the Site Transporter Rollover (Tipover)

		Fault Tree Cutsets (Detailed) Report		
Project: Yucca Mountain		Case : Current		
Analysis: RANDOM		Units: Per Hour		
Cut Set %	Prob./Freq.	Basic Event	Description	Probability
25	5.89E-07	060-CRWT-TRD0001-TRD-FOH	Front Portside Track Failure	5.90E-07
		060-OP-FAILSTOP-HFI-FOD	Operator Fails to Stop ST on Track Failure	1.00E+00
25	5.89E-07	060-CRWT-TRD0002-TRD-FOH	Rear Portside Track Failure	5.90E-07
		060-OP-FAILSTOP-HFI-FOD	Operator Fails to Stop ST on Track Failure	1.00E+00
25	5.89E-07	060-CRWT-TRD0003-TRD-FOH	Front Starboard Track Failure	5.90E-07
		060-OP-FAILSTOP-HFI-FOD	Operator Fails to Stop ST on Track Failure	1.00E+00
25	5.89E-07	060-CRWT-TRD0004-TRD-FOH	Rear Starboard Track Failure	5.90E-07
		060-OP-FAILSTOP-HFI-FOD	Operator Fails to Stop ST on Track Failure	1.00E+00

NOTE: Freq. = frequency, Prob. = probability; ST = site transporter; STC = shielded transfer cask.

Source: Original

B6.4.3.8 Fault Tree

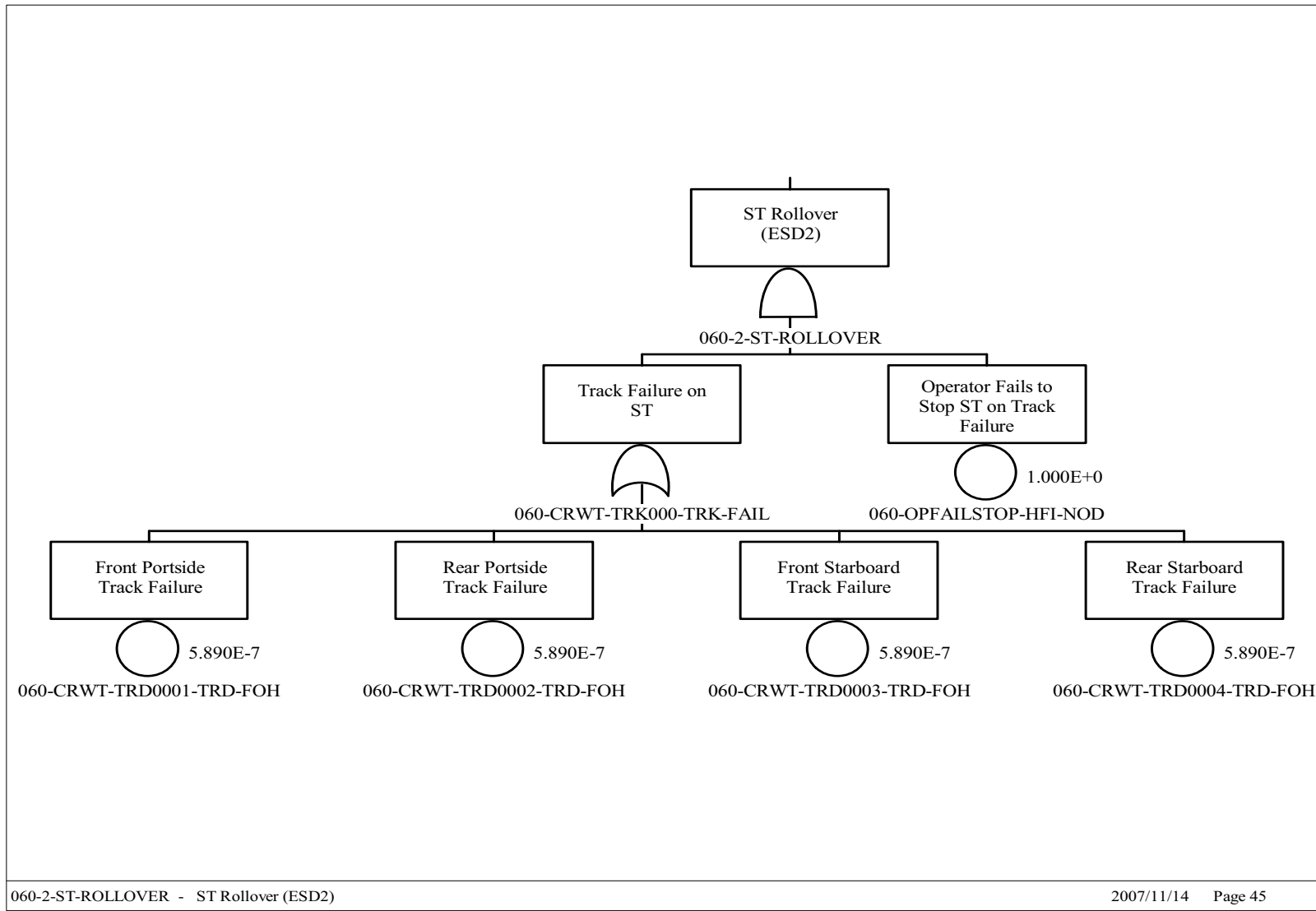

060-2-ST-ROLLOVER - ST Rollover (ESD2)

2007/11/14 Page 45

B6-43

March 2008

Source: Original

Figure B6.4-22. Operator causes Site Transporter Tipover

B6.4.4 Site Transporter Spurious Movement (ESD--09)

B6.4.4.1 Description

The fault tree for “Site Transporter Spurious Movement” in this event sequence addresses activities associated with site transporter transfers of aging overpack canisters to or from staging in the Cask Unloading Room.

B6.4.4.2 Success Criteria

Spurious movement of the site transporter is prevented by the inherent design constraints of the site transporter. There is only sufficient electrical power to perform one type of operation at a time. For example, it is not possible to lift/lower an aging overpack when the site transporter is moving. Spurious signals can not be generated when primary power is removed from the site transporter (i.e., diesel engine shut down and/or facility electrical power cable disconnected). There are no batteries or capacitors in the site transporter that can store electrical energy.

B6.4.4.3 Design Requirements and Features

Requirements

Site transporter power and the remote control pendant are removed by the operator from the site transporter when it has been positioned within the Cask Unloading Room.

On removal of AC power derived from the facility, the site transporter performs a controlled stop. Once stopped it enters the “lock mode,” safe state. The “lock mode,” safe state is not reversible without specific operator action.

Features

There are no electrical storage devices in the design of the site transporter. When the facility AC power cable is removed, the site transporter is incapable of movement.

A shield door interlock ensures that facility power has been removed from the site transporter.

B6.4.4.4 Fault Tree Model

The fault tree model for “Site Transporter Spurious Movement in Cask Unloading Room” accounts for the failure to remove facility power and the possibility of the site transporter receiving a spurious movement command for the remote control device.

B6.4.4.5 Basic Event Data

Table B6.4-8 lists the basic events used in the “Site Transporter Spurious Movement” fault tree.

Table B6.4-8. Basic Event Probability for Site Transporter Spurious Movement

Basic Events Probability Report					
Project: Yucca-Mountain	Case : Current				
ST Spurious Movement	Calc. Type ^a	Units: Per Hour	Fail. Prob.	Lambda	Miss. Time ^a
Name		Calc. Prob.			
060-CR---IEL00A--IEL-FOD	1	2.75E-05	2.75E-05	0.00E+00	1.00E+00
060-CR---IEL00B--IEL-FOD	1	2.75E-05	2.75E-05	0.00E+00	1.00E+00
060-CR---IELCCF--IEL-CCF	1	1.30E-06	1.30E-06	0.00E+00	1.00E+00
060-OPNOUNPLUGST-HFI-NOD	1	1.00E-03	1.00E-03	0.00E+00	1.00E+00
060-ST---HC000--HC--SPO	3	5.23E-07	0.00E+00	5.23E-07	1.00E+00
060-ST---SC002--SC--FOH	3	1.28E-04	0.00E+00	1.28E-04	1.00E+00
060-ST---SC021---SC--SPO	3	3.20E-05	0.00E+00	3.20E-05	1.00E+00

NOTE: ^a For Calc. Type 3 with a mission time of 0, SAPHIRE performs the quantification using the system mission time.

Calc. = Calculation; Fail. = failure; Miss. = mission; Prob. = probability.

Source: Original

B6.4.4.5.1 Human Failure Events

There is one human error associated with this fault tree that addresses an operator failure to unplug the site transporter power cable after it has been parked in the Cask Unloading Room.

B6.4.4.5.2 Common-Cause Failures

There is one common-cause failure associated with two interlock failures on the slide gates. An alpha factor of 0.047 was used to determine the common-cause value using two of two as the failure criteria (Table C3-1, CCCG = 2).

B6.4.4.6 Uncertainty and Cut Set Generation

Figures B6.4-23 and B6.4-24 contain the uncertainty and the cut set generation results for “Site Transporter Spurious Movement” fault tree using a cutoff probability of 1E-15.

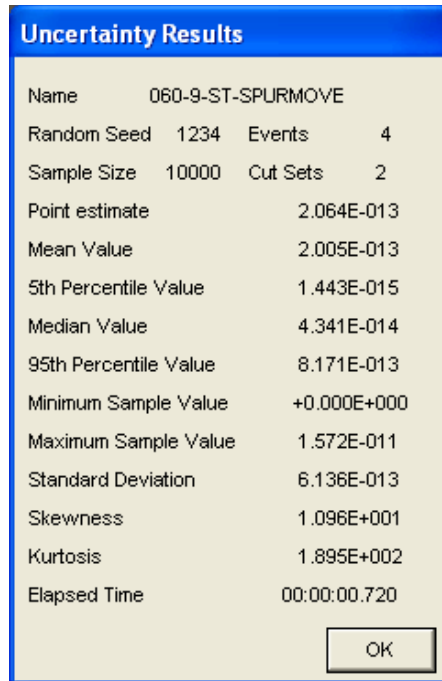

Source: Original

Figure B6.4-23. Uncertainty Results Site Transporter Spurious Movement Fault Tree

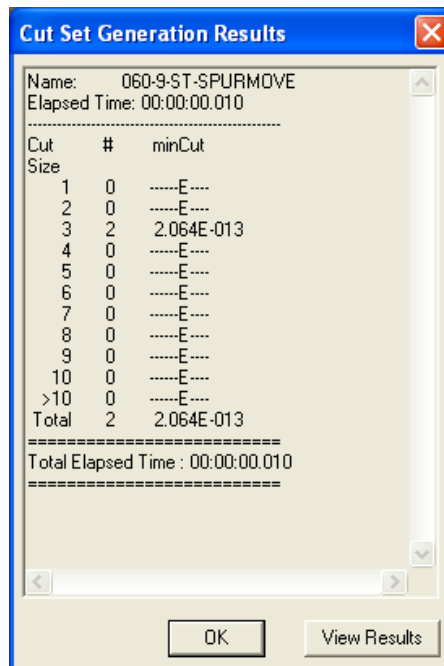

Source: Original

Figure B6.4-24. Cut Set Generation Results for the Site Transporter Spurious Movement Fault Tree

B6.4.4.7 Cut Sets

Table B6.4-9 contains the cut sets for the “Site Transporter Spurious Movement” fault tree.

Table B6.4-9. Cut Sets for the Site Transporter Spurious Movement

Fault Tree	Cut Set %	Prob./Freq.	Basic Event	Description	Probability
060-9-ST-SPURMOVE	80.00	1.651E-013	060-CR---IELCCF--IEL-CCF	Common Cause Failure of Interlocks From Slide Gate	1.3E-006
			060-OPNOUNPLUGST-HFI-NOD	Operator Fails to Unplug ST Power cable	1.0E-003
			060-ST---SC002--SC--FOH	Speed Control on ST Pendant Control Fails	1.3E-004
	20.00	4.128E-014	060-CR---IELCCF--IEL-CCF	Common Cause Failure of Interlocks From Slide Gate	1.3E-006
			060-OPNOUNPLUGST-HFI-NOD	Operator Fails to Unplug ST Power cable	1.0E-003
			060-ST---SC021---SC--SPO	On-Board Controller Initiates Spurious Signal	3.2E-005
		2.064E-013	= Total		

NOTE: AO = aging overpack; Freq. = frequency, Prob. = probability; ST = site transporter; STC = shielded transfer cask.

Source: Original

B6.4.4.8 Fault Tree

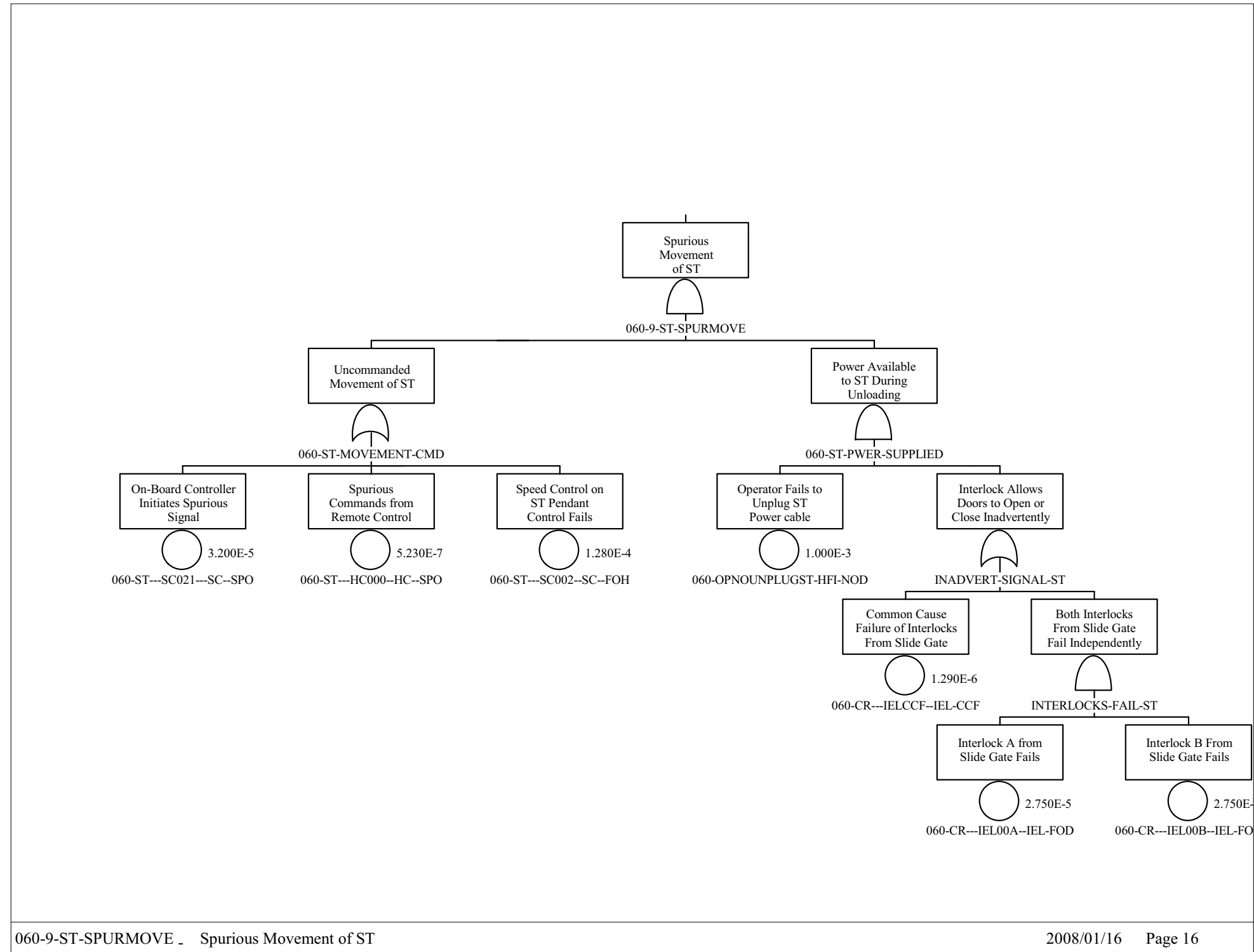

Source: Original

Figure B6.4-25. Spurious Movement of Site Transporter

B6.4.5 Site Transporter Spurious Movement (ESD-05, ESD-12)

B6.4.5.1 Description

Site transporter impact fault trees for these ESDs are identical. The fault tree addresses site transporter impacts with the aging overpack due to spurious movement due to both human error and equipment failure.

B6.4.5.2 Success Criteria

The success criteria for preventing an impact to the site transporter include safety design features for hardware failures resulting in spurious commands and the site transporter operator maintaining situational awareness and proper control of the movement of the site transporter.

B6.4.5.3 Design Requirements and Features

Requirements

The operational control of the site transporter, when inside facility is performed, as a minimum, by a two crewmember team.

One crewmember controls the movement of the site transporter and the other performs spotter functions.

There is no maintenance or testing permitted on a site transporter loaded with an aging overpack.

Features

All vehicles in the CRCF have limiters to restrict speed.

B6.4.5.4 Fault Tree Model

The fault tree model for site transporter impact due to spurious movement addresses one human errors and the possibility of the site transporter receiving a spurious movement or speed commands for the remote control device.

B6.4.5.5 Basic Event Data

Table B6.4-10 lists the basic events used in the site transporter spurious movement. Uncertainty and cut set results are provided in Figures B6.4-26 and B6.4-27 respectively.

Table B6.4-10. Basic Event Probability for Site Transporter Spurious Movement

Basic Events Probability Report					
Project: Yucca-Mountain	Calc. Type ^a	Case : Current	Fail. Prob.	Lambda	Miss. Time ^a
ST Impact		Units: Per Hour			
Name		Calc. Prob.			
060-ST---SC002--SC--FOH	3	1.280E-004	0.000E+000	1.280E-004	1.000E+000
060-ST---SC021---SC--SPO	3	3.200E-005	0.000E+000	3.200E-005	1.000E+000
060-OPSPURMOVE01-HFI-NOD	1	1.000E-004	1.000E-004	0.000E+000	1.000E+000
060-ST---HC000--HC--SPO	3	5.230E-007	0.000E+000	5.230E-007	1.000E+000

NOTE: ^a For Calc. Type 3 with a mission time of 0, SAPHIRE performs the quantification using the system mission time.

Calc. = Calculation; Fail. = failure; Miss. = mission; Prob. = probability.

Source: Original

B6.4.5.5.1 Human Failure Events

The human failure associated with this fault tree is 060-OPSPURMOVE01-HFI-NOD—the site transporter operator initiates a spurious movement which is set to a screening value of 1E-04.

B6.4.5.5.2 Common Cause Failures

There are no CCFs identified for this fault tree.

B6.4.5.6 Uncertainty and Cut Set Generation

Figures B6.4-26 and B6.4-27 contain the uncertainty and the cut set generation results for the “Site Transporter Spurious Movement” fault tree using a cutoff probability of 1E-15.

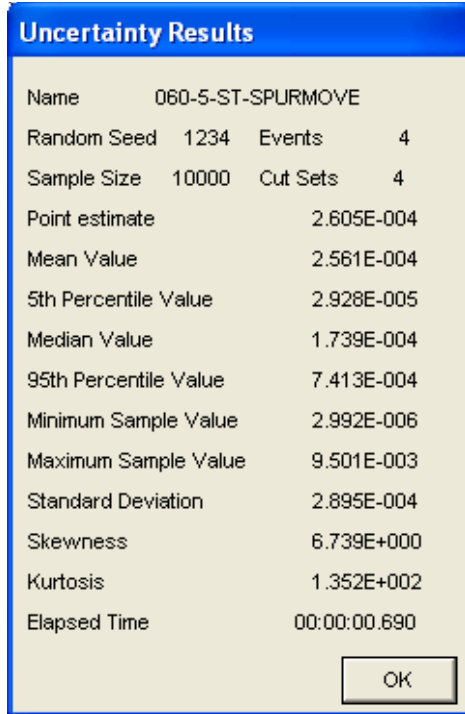

Source: Original

Figure B6.4-26. Uncertainty Results Site Transporter Spurious Movement

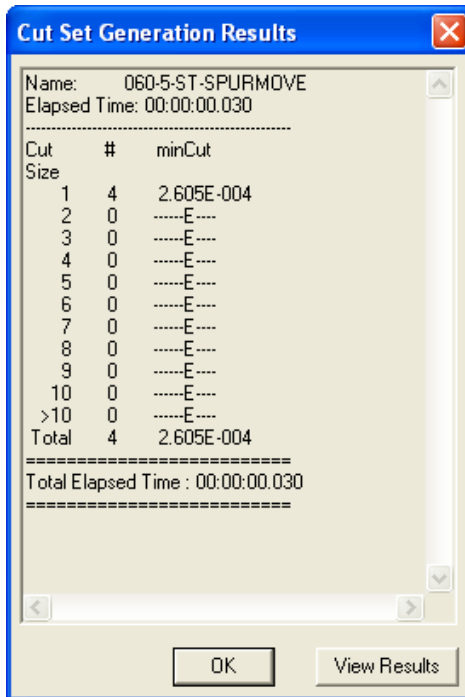

Source: Original

Figure B6.4-27. Cut Set Generation Results for the Site Transporter Spurious Movement Fault Tree

B6.4.5.7 Cut Sets

Table B6.4-11 contains the cut sets for the “Site Transporter Spurious Movement” fault tree.

Table B6.4-11. Cut Sets for Site Transporter Spurious Movement

Fault Tree	Cut Set %	Prob./Freq.	Basic Event	Description	Probability
060-5-ST-SPURMOVE	49.13	1.280E-004	060-ST---SC002--SC--FOH	Speed Control on ST Pendant Control Fails	1.3E-004
	38.39	1.000E-004	060-OPSPURMOVE01-HFI-NOD	Operator Initiates Spurious Movement of Conveyance	1.0E-004
	12.28	3.200E-005	060-ST---SC021---SC--SPO	On-Board Controller Initiates Spurious Signal	3.2E-005
	0.20	5.230E-007	060-ST---HC000--HC--SPO	Spurious Commands from Remote Control	5.2E-007
		2.605E-004	= Total		

NOTE: Freq. = frequency, Prob. = probability; ST = site transporter; STC = shielded transfer cask.

Source: Original

B6.4.5.8 Fault Tree

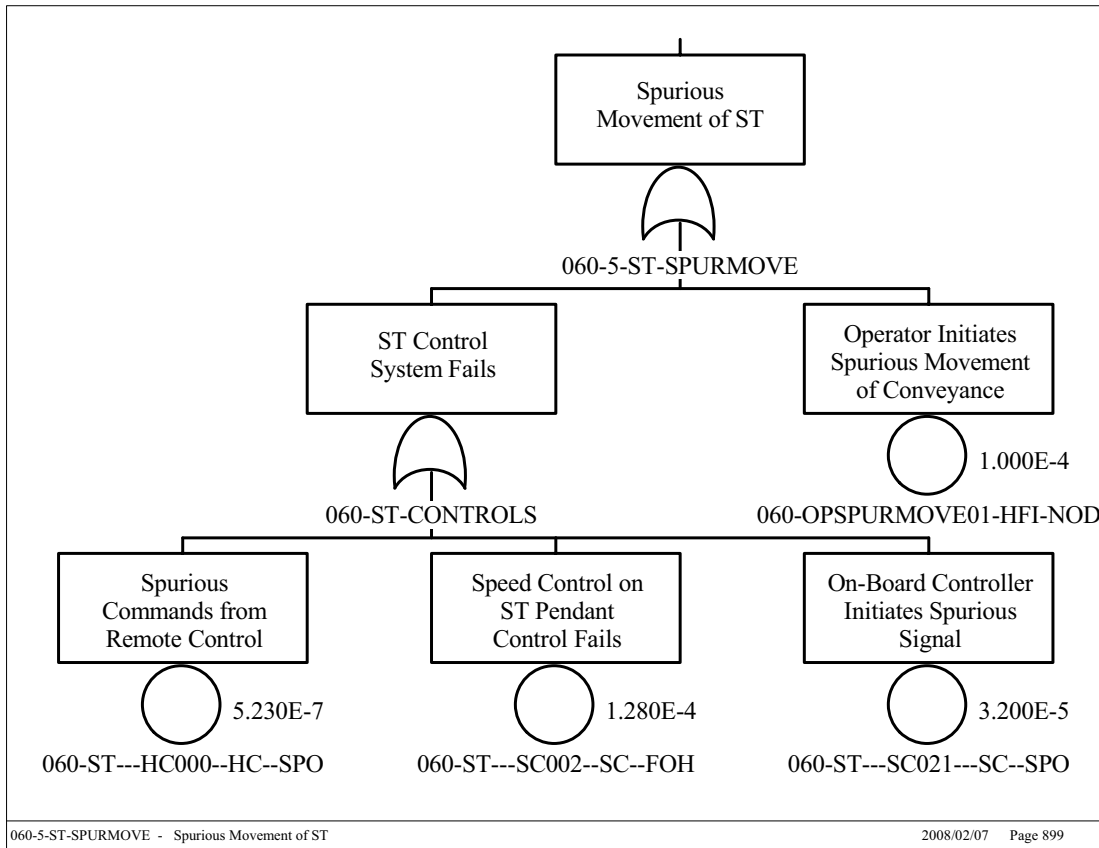

Source: Original

Figure B6.4-28. Impact to ST with AO

B7 HEATING VENTILATION AND AIR CONDITIONING FAULT TREE ANALYSIS

B7.1 REFERENCES

Design Inputs

The PCSA is based on a snapshot of the design. The reference design documents are appropriately documented as design inputs in this section. Since the safety analysis is based on a snapshot of the design, referencing subsequent revisions to the design documents (as described in EG-PRO-3DP-G04B-00037, *Calculations and Analyses* (Ref. 2.1.1, Section 3.2.2.F)) that implement PCSA requirements flowing from the safety analysis would not be appropriate for the purpose of the PCSA.

B7.1.1 Not Used.

B7.1.2 Not Used.

B7.1.3 BSC 2007. *CRCF 1 Composite Vent Flow Diagram Tertiary Conf ITS Exhaust & Non-ITS HVAC Supply Systems*. 060-M50-VCT0-00101-000 REV 00B. Las Vegas, Nevada: Bechtel SAIC Company. ACC: ENG.20071227.0013.

B7.1.4 BSC 2007. *CRCF 1 ITS Confinement Areas HEPA Exhaust System—Train A Ventilation & Instrumentation Diagram*. 060-M80-VCT0-00103-000 REV 00B. Las Vegas, Nevada: Bechtel SAIC Company. ACC: ENG.20071204.0005.

B7.1.5 BSC 2007. *CRCF 1 ITS Confinement Areas HEPA Exhaust System—Train B Ventilation & Instrumentation Diagram*. 060-M80-VCT0-00104-000 REV 00B. Las Vegas, Nevada: Bechtel SAIC Company. ACC: ENG.20071204.0006.

B7.1.6 BSC 2007. *CRCF 1 Equipment Sizing and Selection Calculation (ITS)*. 060-M8C-VCT0-00500-000-00B. Las Vegas, Nevada: Bechtel SAIC Company. ACC: ENG.20071220.0032.

Design Constraints

B7.1.7 NRC (Nuclear Regulatory Commission) 2007. *Preclosure Safety Analysis - Dose Performance Objectives and Radiation Protection Program*. HLWRS-ISG-03. Washington, D.C.: Nuclear Regulatory Commission. ACC: MOL.20070918.0096.

B7.2 IMPORTANT TO SAFETY HVAC DESCRIPTION

B7.2.1 Overview

The ITS HVAC is a two train system of identical components. One train is always operational while the other train is in standby mode. This system is not configured to run both trains at the same time without bypassing relevant control circuitry. An operational two-train configuration is not addressed in this analysis.

Figure B7.2-1 shows the locations of the various pieces of ITS HVAC equipment described in the following sections. Sizing of the ITS HVAC in the CRCF (Ref. B7.1.6, Section 6.1) was performed to ensure desired air distribution, ventilation rates, and transport velocities were attainable to maintain the required negative delta pressure within the tertiary confinement (C2) zones in this facility.

In the CRCF, the train A HVAC equipment is located in Room 1011 and the train B HVAC equipment is on the opposite end of the building in Room 1032. Each HVAC train exhausts air through separate discharge ducts into the atmosphere. Although these trains are interconnected through interior duct work, the trains are independent. A backdraft damper is used on each train to ensure there is no airflow from the atmosphere back through the standby train.

This HVAC system is composed of four subsystems:

- A series of dampers are used to control pressure, flow, and flow direction
- Three HEPA filter units, each consisting of one medium-efficiency roughing filter (60-90% efficiency), two high-efficiency filters for particulate removal (99.97% efficiency) (Ref. B7.1.6, Appendix B) and a mister/demister for maintaining proper humidity levels. (There is a water deluge system in each HEPA filter which is used in fire scenarios. Refer to the facility fire analysis for information regarding these pieces of equipment)
- One exhaust fan with a rated capacity of 40,500 cfm and an exhaust fan motor rated at 200 horsepower (Ref. B7.1.6, Section 6.1.2)
- Control circuitry with logic contained in an erasable programmable read-only memory (EPROM) located in the adjustable speed drive (ASD) controller used for controlling the speed of the operating fan and on fault detection (Ref. B7.1.6, Section 3.2.3). For off-nominal conditions, uncorrectable delta pressures is either too high or too low, as defined in Table B7.2-1, the ASD, shuts down the operating train and starts the standby train. The ASD also controls non-ITS supply fans that are adjusted to maintain airflow in the facility.

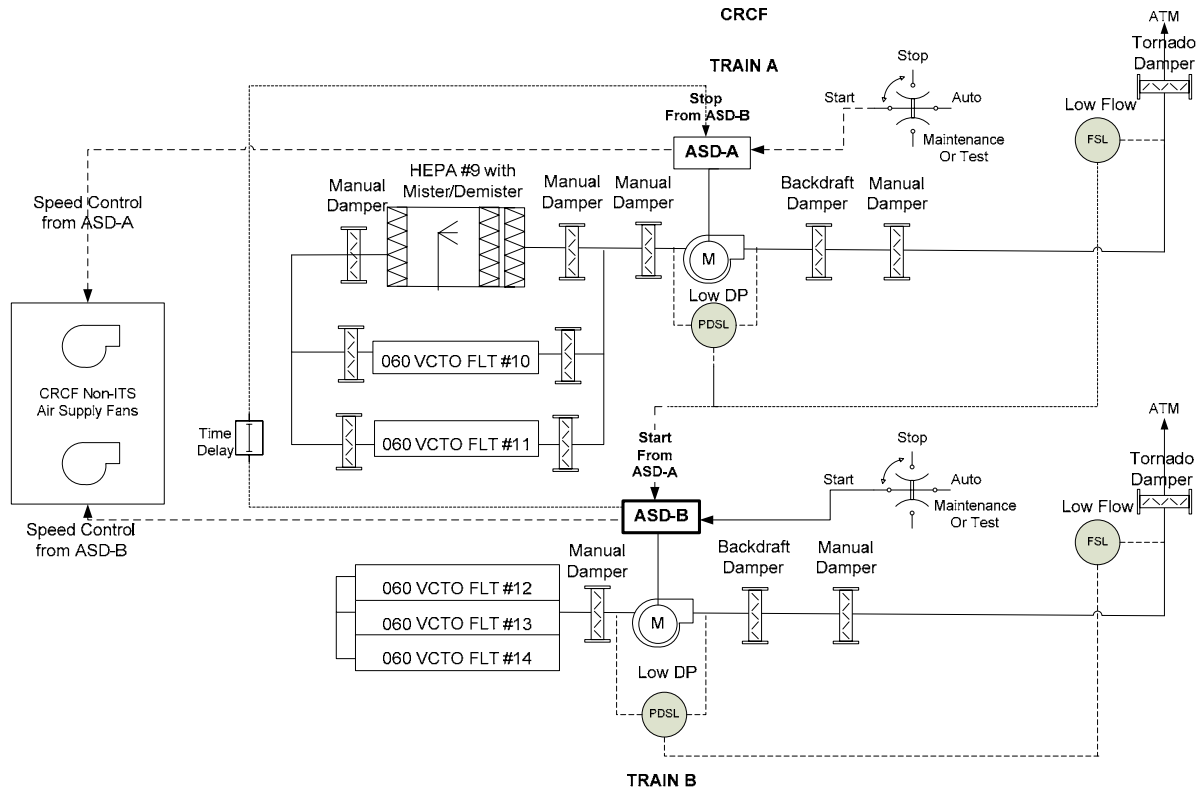

NOTE: It should be noted that, the diagram has been simplified with respect to the HEPA filter equipment shown for train A and B. The equipment configuration for HEPA Filters identified as 060 VCTO FLT 10, 11, 12, 13 and 14 are identical to the HEPA FLT 9. In addition, train B has the same input/output dampers shown for train A. Train A is always defined as the operating train and train B is always designated as the standby train.

ASD = adjustable speed drive; ATM = atmosphere; CRCF = Canister Receipt and Closure Facility; DP = delta pressure; FSL = flow sensor low; ITS = important to safety; HEPA = high=efficiency particulate air (filter); PDSL = pressure differential sensor low.

Source: Original

Figure B7.2-1. Block Diagram of the CRCF ITS HVAC System

B7.2.2 Damper Subsystem Description

The ITS HVAC system uses manual, backdraft and tornado dampers to control the delta pressure inside the containment area or to isolate the standby system from the outside atmosphere.

Manual dampers are located on the input and output sides of the HEPA filter. These filters are used to isolate the HEPA filter, if required, during maintenance. There is a manual damper on the input side of the exhaust fan that is used to isolate the entire HEPA filter subsystem for maintenance on the HEPA filters or the exhaust fan. One additional manual damper is located between the backdraft and the tornado damper which can be used to isolate the entire train.

A backdraft damper is located on the exhaust side of the fan. This damper is normally open for the operating train and closed on the standby train. This damper prevents a reverse airflow through the standby system as a result of the negative delta pressure in the containment C2 areas.

A tornado damper is used to control airflow automatically to prevent the transmission of tornado pressure surges from outside the facility.

B7.2.3 HEPA Filters

The three HEPA filter units are identical consisting of a 3×3 array of medium (nine filters) and two banks of HEPAs (18 filters). A bag-in/bag-out procedure is used to replace the HEPA filters. Each filter is sized for a maximum flow of 1,500 cfm (Ref. B7.1.6, Section 3.2.2). The failure analysis includes the HEPA filter bank for plugs and leaks, mister/demister for humidity control, and the medium roughing filter.

The HEPA subsystem also contains the following components that are not modeled in the analysis: Inlet test section, combination test section, the outlet test section, and the deluge system during fire scenarios.

B7.2.4 Direct Drive Exhaust Fan and Motor

The exhaust fan and motor are sized to provide a maximum airflow rate of 40,500 cfm. To meet delta pressure requirements for the CRCF, the exhaust system must provide an airflow rate of 35,010 cfm (Ref. B7.1.6, Appendix A, Table A-1). At this airflow rate, the exhaust system provides for a total of 14.2 inches of water column required to maintain delta pressure in the facility (Ref. B7.1.6, Section 3.1.4).

The exhaust fan motor is rated at 1800 rpm (Ref. B7.1.6, Section 3.1.5) but the actual speed is controlled by the ASD. The ASD adjusts the speed to maintain delta pressure when facility doors are opened, HEPA filters lose efficiency, or outside wind speeds.

B7.2.5 Control Circuitry

The ITS HVAC system is controlled by EPROM (although there are programmable logic controls in various locations throughout the CRCF, none of these are ITS) logic. This control logic is contained in the ASD control panel which is used to monitor the delta pressure across the exhaust fan and airflow rate exhausting to the atmosphere. Changes in air pressure cause the ASD to change the speed of the exhaust fan motor. The ASD also controls the rpm of the non-ITS supply fans (Ref. B7.1.4, Ref. B7.1.5, and Ref. B7.1.3). The supply fans are used to stabilize the airflow within the CRCF. These fans are non-ITS so they are not accounted for in this analysis except in a degraded mode of operation.

At any time the ASD can not return the delta pressure to normal operating conditions, the ADS shuts down the operating train and sends a signal to the standby train to start up. When the standby ASD receives this signal, it starts the standby system and sends a signal to the operational train to shutdown. There is an interlock to preclude the operation of both trains at the same time. Time delays are built-into the ASD processing system to preclude spurious signals received from the sensors triggering a false transfer.

B7.2.6 ITS HVAC Normal Operations

In normal operations, train A is operational and train B is in standby. EPROM logic within the ASD monitors the pressure differential across the exhaust fan and the flow rate of the exhaust to the atmosphere. There are no programmable logic controllers used in the ITS HVAC control system and all interlocks are hardwired for ITS operations. Table B7.2-1 shows the ASD operational response to various delta pressure conditions inside the facility. The delta pressure sensor and low flow sensor are ITS equipment with defined set points for the CRCF.

Table B7.2-1. ASD Response to Variations in Delta Pressure and Flow Rates

DP Pressure Sensor	Low Flow Sensor	ASD Response
High DP (Plugged HEPA)	Low Flow	Switch trains
High DP	High Flow	Decrease RPM of Exhaust Fan
High DP	Nominal Flow	Increase RPM of Supply Fans
Low DP (HEPA Leak)	High Flow	Switch trains
Low DP	Nominal Flow	Decrease RPM of Supply Fans
Low DP	Low Flow	Increase RPM of Exhaust Fan

NOTE: ASD = adjustable speed drive; DP = delta pressure; HEPA = high-efficiency particulate air (filter); RPM = revolutions per minute.

Source: Original

If the ASD-A response does not return the delta pressure and/or flow rates to a nominal state, then ASD-A issues the command to the ASD-B to startup train B. ASD-B commands the startup of train B and, after a time delay, send a signal back to ASD-A to shut down. An interlock prevents both trains from operating at the same time.

Under normal operations with non-ITS supply fans working, all three HEPA filter assemblies in the train must be working to achieve the exhaust flow rate of 35,010 cfm (Ref. B7.1.6, Section 6.1.1 (1)). Each HEPA filter array can filter 13,500 cfm at maximum efficiency (Ref. B7.1.6, Section 6.1.1 (2)). The design has some reserve capacity but not enough to maintain the required delta pressure if one of the HEPA filters fails. Under normal operations, the only redundancy in the design is the second train.

Misters/demisters are included as part of the HEPA filters to control the temperature and relative humidity of the air passing through the filters. The water deluge system is not considered to be normal operations and is handled in the fire suppression analyses.

During receipt of a transportation cask or aging overpack or during the export of a waste package or aging overpack, delta pressure is lost for a period of time not to exceed seven minutes per event (this is a conservative estimate of the time it will take for the HVAC system to return the vestibule to a negative pressure). This occurs when the vestibule doors are opened to allow the site transporter, site prime mover or the transport and emplacement vehicle to enter or leave the CRCF.

B7.2.7 ITS HVAC Degraded Operations

The ITS HVAC system maintains proper delta pressure throughout Class C2 designated containment areas. Exhausted air from the CRCF is made-up from opening/closing doors to the outside, leaks in the structure and from one of two supply fans which are controlled by the ASD on the operating train. One of these fans in conjunction with other air makeup sources can provide sufficient airflow through the C2 containment areas for the HVAC to maintain delta pressure. These supply fans are non-ITS and therefore, they are not connected to the ITS power system for the CRCF. Should there be a loss of non-ITS site power or for a mechanical reason, these fans shut down, the HVAC system can be operated in a degraded mode. Since there is less air to exhaust, train A no longer has to exhaust 35,010 cfm. It then becomes possible to maintain delta pressure with 2 of 3 HEPA filters. This special case has been added to the fault trees for the “Failure to Maintain Delta Pressure in the CRCF”. In this case, there is redundancy within the train and a common-cause failure mode has been added to the fault tree.

B7.2.8 ITS HVAC Testing and Maintenance

Under normal operations train A continues to operate until a failure is detected or the train is shut down for maintenance. Normal maintenance renders train B unavailable 40 hours per year (the majority of operational-level maintenance can be performed on the operational train and therefore does not affect the overall availability of the standby train). During maintenance, the train B “start/stop/auto/maintenance” switch is placed in the maintenance position. When maintenance is completed, the standby system (train B) is started and operational system (train A) is shut down and is now considered to be the standby train (train A). Maintenance may be scheduled consecutively for this train or at some future date. Under normal operations, maintenance does not result in the loss of/or the inability of the operating train to perform its intended function.

Testing is considered part of routine maintenance. When the maintenance has been completed, maintenance personnel turns the standby train on and check for normal operations including delta pressure, flow rate, and that all failure indicators are reset/off. Maintenance personnel also observe the forced shutdown of the operating system as the standby train is turned on.

Flow rates are monitored as part of testing to ensure that the manual dampers for the active train are in the proper position to achieve a balanced airflow across the three HEPA filters. Once the dampers have been adjusted, they do not require further adjustment unless a damper or combination of dampers must be closed to isolate a component in the train or the entire train.

B7.3 DEPENDENCIES AND INTERACTIONS

Dependencies are broken down into five categories with respect to their interactions with structures, systems, and components. The five areas considered are addressed in Table B7.3-1 with the following dependencies:

1. Functional dependence
2. Environmental dependencies

3. Spatial dependence
4. Human dependence
5. Failures based on external events.

Table B7.3-1. Dependencies and Interactions Analysis

Structures, Systems, and Components	Dependencies and Interactions				
	Functional	Environmental	Spatial	Human	External Events
ASD	Flow and pressure sensors	—	—	—	—
	Speed control for fan/motor	—	—	—	—
DP Exhaust Fans	—	Wind speed	—	—	—
Stop/Start/Auto Switch Position	—	—	—	Wrong position	—
Dampers	—	—	—	Wrong position	—
ITS Power	HVAC shuts down	—	—	—	—
Non-ITS Power	—	—	—	—	Supply fans stop
HEPA	—	—	—	Failure to notice leak	—
HVAC Maintenance	—	—	—	Trains can not switch	—
Vestibule Doors	Open only one door at a time	—	—	—	—
Alarm Panel (Non-ITS)	—	—	—	Failure to Respond to HVAC Alarm	—

NOTE: ASD = adjustable speed drive; DP = delta pressure; HEPA = high-efficiency particulate air (filter); HVAC = heating, ventilation, and air-conditioning; ITS = important to safety.

Source: Original

B7.4 HVAC RELATED FAILURE SCENARIO

B7.4.1 Failure to Maintain Delta Pressure

B7.4.1.1 Description

There is a single failure scenario used in this analysis. The components of the HVAC system used inside buildings to maintain C2 in areas that are normally clean and where airborne contamination is not expected during normal facility operations. The ITS HVAC equipment maintains a positive airflow from outer confinement areas, through the HEPA filters, and into the atmosphere (Ref. B7.1.3).

This model is also applicable to CRCF 2 and 3, RF and WHF with only minor differences that are addressed in these facility specific appendices.

B7.4.1.2 Success Criteria

Success criteria for maintaining delta pressure in the CRCF requires that one of two HVAC trains is operational. The sizing of the exhaust motor and fan assembly maintains the delta pressure in sustained winds of 40 mph with less than 3 second gusts up to 90 mph. In addition, delta pressure is lost for a period of time not to exceed 7 minutes in the CRCF if and only if one of the four vestibule doors is open. These doors are interlocked to ensure only one door is open at a time during normal operations.

Switching between the active and standby trains is controlled by ASD-A (“active train”) which continually monitors the pressure across the exhaust fan and the air flow rate exhausting from the CRCF. These sensors are in a one-of-two configuration which means that the ASD initiates the transfer of operations from the “active train” to the “standby train” when either one of these sensors can not be returned to a normal operating range by the ASD, by controlling, in some combination, the speed of the supply and exhaust fans.

ASD-A must be able to recognize an uncorrectable airflow rate in train A and transmit a signal to ASD-B to start. Having received the start command, ASD-B must send a signal back to ASD-A, commanding a stop.

Maintaining delta pressure during/after the switchover requires the “start/stop/auto or test/maintenance” switch be in the auto position, the train B exhausts fan and motor start, and the airflow across the HEPA filters adjusted by ASD-B to maintain delta pressure.

With the exception of the tornado and backdraft dampers, all control dampers in the ITS HVAC system are manual dampers. These dampers are typically set once for air balancing. These dampers may be adjusted or closed when maintenance is required on the “standby train.” Should the damper setting be changed, it would require the maintenance personnel to return the damper to its proper position to ensure balanced airflow.

B7.4.1.3 Design Requirements and Features

Requirements

There is only one HVAC train in operation at anytime. The second train is on standby (exception—when train B is off-line for maintenance).

Alarms are on a panel in the continuously manned central control station and responded to by operators. Alarm conditions are: ASD trouble, fan failure, motor running/stop, and flow rate problem. Operators are not required to respond to the alarm (ITS-HVAC trains are switched automatically); however, operators are expected to notify maintenance that a switch has occurred and maintenance is required to determine the cause of the failure and correct it.

Design Features

ITS HVAC system is in normal operation with three, 3 HEPA filter units. Each HEPA filter unit consists of one 3×3 medium filter array and two 3×3 high-efficiency arrays.

The only difference between the ITS HVAC in the CRCF, RF and WHF facilities are the number of non-ITS fans operating in the facility.

Testing and Maintenance

Requirements

HVAC maintenance personnel are notified when an alarm condition exists. Repairs are performed as soon as possible to return train to operational status.

While a HVAC train is undergoing maintenance, the train is not available for service.

Testing that requires the exhaust fan to run is performed on the active HVAC system.

Features

Normal maintenance is performed in accordance with manufacturer's recommendations; however, the majority of preventative maintenance does not require shutting down the active system.

B7.4.1.4 Fault Tree Model

The top event in this fault tree is "Delta Pressure not Maintained in CRCF Facility." This is defined as the inability of the ITS HVAC system to maintain delta pressure within the facility. The ITS HVAC system is a two train system. The configuration of the ITS HVAC systems in the CRCF facilities is essentially identical. The only variations are the number of non-ITS supply fans used to stabilize the airflow within these buildings.

The fault tree model for the failure to maintain delta pressure in the facility includes those components that have been designated as ITS. There is only one exception and that is the inclusion of two non-ITS supply fans. The fans were added to stabilize air pressure differentials in the facility during normal operations and provide a capability for operating in a degraded mode.

There are two interlocks in the ITS HVAC system. The first addresses the potential for opening two or more of the Entry/Exit Vestibule doors. (Note: There is no physical connection between this door interlock and the HVAC system.) The second interlock prevents two HVAC trains from operating at the same time.

The mission time for the ITS HVAC system is currently set to 720 hours (Ref. B7.1.7). To take into account the differences in failure rates for active and standby systems, all basic events in the standby train are set to half that of the active system. For ease of implementation in SAPHIRE, the rate data is maintained constant and the mission time is set to $\frac{1}{2}$ the mission time or 360 hours.

B7.4.1.5 Basic Event Data

Table B7.4-1 contains a list of basic events used in the loss of delta pressure in the CRCF. The model contains undeveloped transfers to ITS power systems. These failures are addressed in Attachment B8. Reliability data for basic events is detailed in Attachment C with the following exceptions:

- A. Three are associated with human error. HFE detailed analysis is in Section 6.4 and Attachment E:
 - 1. Opening two or more vestibule doors.
 - 2. Failure to properly restore system after maintenance.
 - 3. Failure to notice HEPA filter leak.
- B. Unavailability of the standby train due to scheduled maintenance which is based on a conservative estimate.
- C. Loss of delta pressure as a direct result of opening a vestibule door and the time it takes for the HVAC exhaust fans to re-establish delta pressure.
- D. Two common-cause failures:
 - 1. Common-cause failures of the HEPA filters in the degraded mode.
 - 2. Common-cause failures of the non-ITS supply fans.

Table B7.4-1. Basic Event Probability for the Failure to Maintain Delta Pressure in the CRCF Fault Tree

Name	Calc. Type ^a	Calc. Prob.	Fail. Prob.	Lambda	Miss. Time ^a
060-EXCESSIVE-WIND-SPEED	1	4.700E-003	4.700E-003	0.000E+000	0.000E+000
060-VCT0-SUPPLY-FAN-CCF	3	1.200E-003	3.760E-006	1.667E-006	0.000E+000
060-VCOO-NITS-PWR-FAILS	3	3.536E-002	1.000E+000	5.000E-005	0.000E+000
060-VCOO-SFAN001-FAN-FTR	3	5.059E-002	0.000E+000	7.210E-005	0.000E+000
060-VCOO-SFAN002-FAN-FTR	3	5.059E-002	0.000E+000	7.210E-005	0.000E+000
060-VCTO--B-FAIL-START	1	2.020E-003	2.020E-003	0.000E+000	0.000E+000
060-VCTO-CONTDOORS-OPEN	T	1.000E+000	1.000E+000	0.000E+000	0.000E+000
060-VCTO-DMP000A-DMP-FRO	3	6.033E-005	0.000E+000	8.380E-008	0.000E+000
060-VCTO-DMP000B-DMP-FRO	3	3.017E-005	0.000E+000	8.380E-008	3.600E+002
060-VCTO-DMP001A-DMP-FRO	3	6.033E-005	0.000E+000	8.380E-008	0.000E+000
060-VCTO-DMP001B-DMP-FRO	3	3.017E-005	0.000E+000	8.380E-008	3.600E+002
060-VCTO-DMP009I-DMP-FRO	3	6.033E-005	0.000E+000	8.380E-008	0.000E+000
060-VCTO-DMP009O-DMP-FRO	3	6.033E-005	0.000E+000	8.380E-008	0.000E+000
060-VCTO-DMP010I-DMP-FRO	3	6.033E-005	0.000E+000	8.380E-008	0.000E+000
060-VCTO-DMP010O-DMP-FRO	3	6.033E-005	0.000E+000	8.380E-008	0.000E+000
060-VCTO-DMP011I-DMP-FRO	3	6.033E-005	0.000E+000	8.380E-008	0.000E+000
060-VCTO-DMP011O-DMP-FRO	3	6.033E-005	0.000E+000	8.380E-008	0.000E+000
060-VCTO-DMP012I-DMP-FRO	3	3.017E-005	0.000E+000	8.380E-008	3.600E+002

Table B7.4-1. Basic Event Probability for the Failure to Maintain Delta Pressure in the CRCF (Continued)

Name	Calc. Type ^a	Calc. Prob.	Fail. Prob.	Lambda	Miss. Time ^a
060-VCTO-DMP012O-DMP-FRO	3	3.017E-005	0.000E+000	8.380E-008	3.600E+002
060-VCTO-DMP013I-DMP-FRO	3	3.017E-005	0.000E+000	8.380E-008	3.600E+002
060-VCTO-DMP013O-DMP-FRO	3	3.017E-005	0.000E+000	8.380E-008	3.600E+002
060-VCTO-DMP014I-DMP-FRO	3	3.017E-005	0.000E+000	8.380E-008	3.600E+002
060-VCTO-DMP014O-DMP-FRO	3	3.017E-005	0.000E+000	8.380E-008	3.600E+002
060-VCTO-DR00001-HFI-NOD	1	1.000E-002	1.000E-002	0.000E+000	0.000E+000
060-VCTO-DRS0000-DRS-OPN	1	1.600E-004	1.600E-004	0.000E+000	0.000E+000
060-VCTO-DTC0A-DTC-RUP	3	2.675E-003	0.000E+000	3.720E-006	0.000E+000
060-VCTO-DTC0B-DTC-RUP	3	1.338E-003	0.000E+000	3.720E-006	3.600E+002
060-VCTO-FAN00A-FAN-FTR	3	5.059E-002	0.000E+000	7.210E-005	0.000E+000
060-VCTO-FAN00B-FAN-FTR	3	2.562E-002	0.000E+000	7.210E-005	3.600E+002
060-VCTO-FAN00B-FAN-FTS	1	2.020E-003	2.020E-003	0.000E+000	0.000E+000
060-VCTO-FANA-PRM-FOH	3	3.873E-004	0.000E+000	5.380E-007	0.000E+000
060-VCTO-FANB-PRM-FOH	3	1.937E-004	0.000E+000	5.380E-007	3.600E+002
060-VCTO-FSLAB0-SRF-FOH	3	7.701E-004	0.000E+000	1.070E-006	0.000E+000
060-VCTO-HEPA-CCF	3	1.067E-004	6.200E-007	1.067E-007	0.000E+000
060-VCTO-HEPA09-DMS-FOH	3	6.545E-003	0.000E+000	9.120E-006	0.000E+000
060-VCTO-HEPA0A9-HEP-LEK	3	2.158E-003	0.000E+000	3.000E-006	0.000E+000
060-VCTO-HEPA10-DMS-FOH	3	6.545E-003	0.000E+000	9.120E-006	0.000E+000
060-VCTO-HEPA11-DMS-FOH	3	6.545E-003	0.000E+000	9.120E-006	0.000E+000
060-VCTO-HEPA12-DMS-FOH	3	3.278E-003	0.000E+000	9.120E-006	3.600E+002
060-VCTO-HEPA13-DMS-FOH	3	3.278E-003	0.000E+000	9.120E-006	3.600E+002
060-VCTO-HEPA14-DMS-FOH	3	3.278E-003	0.000E+000	9.120E-006	3.600E+002
060-VCTO-HEPAA09-HEP-LEK	3	2.158E-003	0.000E+000	3.000E-006	0.000E+000
060-VCTO-HEPAA09-HEP-PLG	3	3.070E-003	0.000E+000	4.270E-006	0.000E+000
060-VCTO-HEPAA10-HEP-LEK	3	2.158E-003	0.000E+000	3.000E-006	0.000E+000
060-VCTO-HEPAA10-HEP-PLG	3	3.070E-003	0.000E+000	4.270E-006	0.000E+000
060-VCTO-HEPAA11-HEP-LEK	3	2.158E-003	0.000E+000	3.000E-006	0.000E+000
060-VCTO-HEPAA11-HEP-PLG	3	3.070E-003	0.000E+000	4.270E-006	0.000E+000
060-VCTO-HEPAB-CCF	3	3.841E-005	1.000E+000	1.067E-007	3.600E+002
060-VCTO-HEPAB12-HEP-LEK	3	1.079E-003	0.000E+000	3.000E-006	3.600E+002
060-VCTO-HEPAB12-HEP-PLG	3	1.536E-003	0.000E+000	4.270E-006	3.600E+002
060-VCTO-HEPAB13-HEP-LEK	3	1.079E-003	0.000E+000	3.000E-006	3.600E+002
060-VCTO-HEPAB13-HEP-PLG	3	1.536E-003	0.000E+000	4.270E-006	3.600E+002
060-VCTO-HEPAB14-HEP-LEK	3	1.079E-003	0.000E+000	3.000E-006	3.600E+002
060-VCTO-HEPAB14-HEP-PLG	3	1.536E-003	0.000E+000	4.270E-006	3.600E+002
060-VCTO-HEPALK-HFI-NOD	1	1.000E+000	1.000E+000	0.000E+000	0.000E+000
060-VCTO-HFIA000-HFI-NOM	1	1.000E-001	1.000E-001	0.000E+000	0.000E+000
060-VCTO-IEL0001-IEL-FOD	1	2.750E-005	2.750E-005	0.000E+000	0.000E+000
060-VCTO-PDSLA0B-SRP-FOD	1	3.990E-003	3.990E-003	0.000E+000	0.000E+000

Table B7.4-1. Basic Event Probability for the Failure to Maintain Delta Pressure in the CRCF (Continued)

Name	Calc. Type ^a	Calc. Prob.	Fail. Prob.	Lambda	Miss. Time ^a
060-VCTO-TDMP00A-DTM-FOD	1	8.710E-004	8.710E-004	0.000E+000	0.000E+000
060-VCTO-TDMP00B-DTM-FOD	1	8.710E-004	8.710E-004	0.000E+000	3.600E+002
060-VCTO-TDMP00B-DTM-FOH	3	8.103E-003	0.000E+000	2.260E-005	3.600E+002
060-VCTO-TRAINB-MAINT	1	4.570E-003	4.570E-003	0.000E+000	0.000E+000
060-VCTO-UDMP000-UDM-FOH	3	8.103E-003	0.000E+000	2.260E-005	3.600E+002

NOTE: ^a For Calc. Type 3 with a mission time of 0, SAPHIRE performs the quantification using the system mission time

Calc. = calculation; CRCF = Canister Receipt and Closure Facility; DP = delta pressure; Fail. = failure; Miss. = mission; P = pressure; Prob. = probability.

Source: Original

B7.4.1.5.1 Human Failure Events

There are three basic human failure events (HFE) associated with human error listed in Table B7.4-2. They are for inadvertently opening two or more vestibule doors at the same time, failure to notice that there is a HEPA leak and leaving the “start/stop/auto” switch on the standby train in the wrong position.

Table B7.4-2. Human Failure Events

Basic Event Name	Basic Event Description
060-VCTO-DR00001-HFI-NOD	Operators open 2 of more vestibule doors in CRCF
060-VCTO-HEPALK-HFI-NOD	Operator fails to notice HEPA filter leak in train A (or train B)
060-VCTO-HFIA000-HFI-NOM	Human error exhaust fan switch wrong position

NOTE: CRCF = Canister Receipt and Closure Facility; HEPA = high-efficiency particulate air (filter).

Source: Original

B7.4.1.5.2 Common-Cause Failures

There are three common-cause failures identified in the HVAC model. Two of the common-causes are associated with the potential of a HEPA filter failure in the degraded mode for HEPA filters in the degraded mode where there is a two-of-three success situation. An alpha factor of 0.025 is used (Table C3-1, CCCG=3). The third common-cause is applied to the non-ITS supply fans where success is one-of-two in the degraded mode of operation. An alpha factor of 0.0235 is used (Table C3-1, CCCG-2).

B7.4.1.6 Uncertainty and Cut Set Generation

Figure B7.4-1 contains the uncertainty results obtained from running the fault trees for “Failure to Maintain Delta Pressure” using a cutoff probability of 1E-12. Figure B7.4-2 provides the cut set generation results for the “Failure to Maintain Delta Pressure” fault tree. These results are for the HVAC system coupled with loss of electrical power, which is discussed separately in Section B8. If loss of electrical power is not included in the HVAC tree, the mean failure probability and standard deviation of the HVAC system alone is 3.3E-02 and 9.3E-02.



Source: Original

Figure B7.4-1. Uncertainty Results of the Failure to Maintain Delta Pressure Fault Tree

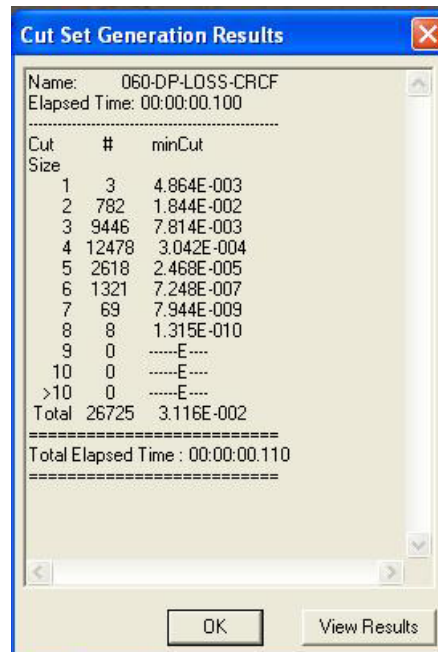

Source: Original

Figure B7.4-2. Cut Set Generation Results for the Failure to Maintain Delta Pressure Fault Tree

B7.4.1.7 Cut Sets

Table B7.4-3 contains the top 35 cut sets for the “Failure to Maintain Delta Pressure” fault tree.

Table B7.4-3. Dominant Cut Sets for the Failure to Maintain Delta Pressure Fault Tree

Fault Tree	Cut Set %	Prob./Freq.	Basic Event	Description	Probability
060-DP-LOSS-CRCF	16.23	5.059E-003	060-VCTO-FAN00A-FAN-FTR	Exhaust Fan in Train A Fails	5.1E-002
			060-VCTO-HFIA000-HFI-NOM	Human Error Exhaust Fan Switch Wrong Position	1.0E-001
	15.08	4.700E-003	060-EXCESSIVE-WIND-SPEED	Sustained Wind Exceeds 40 MPH & Gust to 90 MPH	4.7E-003
	5.69	1.772E-003	LOSP	Loss of offsite power	3.0E-003
			26D-#EEY-ITSDG-A-#DG-FTR	ITS Diesel Generator A Fails to Run	7.7E-001
			26D-#EEY-ITSDGB-#DG-FTR	ITS DG B Fails to Run	7.7E-001
		1.296E-003	060-VCTO-FAN00A-FAN-FTR	Exhaust Fan in Train A Fails	5.1E-002
			060-VCTO-FAN00B-FAN-FTR	Exhaust Fan in Train B Fails	2.6E-002
	2.10	6.545E-004	060-VCTO-HEPA09-DMS-FOH	Moisture Separator/Demister HEPA 09 Fails	6.5E-003
			060-VCTO-HFIA000-HFI-NOM	Human Error Exhaust Fan Switch Wrong Position	1.0E-001
	2.10	6.545E-004	060-VCTO-HEPA10-DMS-FOH	Moisture Separator/Demister HEPA 10 Fails	6.5E-003
4.16			060-VCTO-HFIA000-HFI-NOM	Human Error Exhaust Fan Switch Wrong Position	1.0E-001
	2.10	6.545E-004	060-VCTO-HEPA11-DMS-FOH	Moisture Separator/Demister HEPA 11 Fails	6.5E-003
			060-VCTO-HFIA000-HFI-NOM	Human Error Exhaust Fan Switch Wrong Position	1.0E-001
	1.73	5.378E-004	060-#EEE-MCC0001-MCC-FOH	CRCF ITS MCC 00001 Fails	5.4E-003
			060-VCTO-HFIA000-HFI-NOM	Human Error Exhaust Fan Switch Wrong Position	1.0E-001
	1.32	4.099E-004	060-VCTO-FAN00A-FAN-FTR	Exhaust Fan in Train A Fails	5.1E-002
			060-VCTO-TDMP00B-DTM-FOH	Tornado damper Train B Fails	8.1E-003
	1.32	4.099E-004	060-VCTO-FAN00A-FAN-FTR	Exhaust Fan in Train A Fails	5.1E-002
			060-VCTO-UDMP000-UDM-FOH	Backdraft Damper for Train B exhaust Fails	8.1E-003
	1.22	3.816E-004	060-#EEE-LDCNTRA-C52-SPO	Load Center A Feed Circuit Breaker (AC) Spurious Operation	3.8E-003
			060-VCTO-HFIA000-HFI-NOM	Human Error Exhaust Fan Switch Wrong Position	1.0E-001
	1.22	3.816E-004	060-#EEE-MCC0001-C52-SPO	CRCF ITS MCC 0001 Feed Breaker Spurious Operation	3.8E-003
			060-VCTO-HFIA000-HFI-NOM	Human Error Exhaust Fan Switch Wrong Position	1.0E-001
	0.99	3.070E-004	060-VCTO-HEPAA09-HEP-PLG	HEPA #A09 Train A Plugged	3.1E-003
			060-VCTO-HFIA000-HFI-NOM	Human Error Exhaust Fan Switch Wrong Position	1.0E-001
	0.99	3.070E-004	060-VCTO-HEPAA10-HEP-PLG	HEPA #A10 Train A Plugged	3.1E-003
			060-VCTO-HFIA000-HFI-NOM	Human Error Exhaust Fan Switch Wrong Position	1.0E-001
	0.99	3.070E-004	060-VCTO-HEPAA11-HEP-PLG	HEPA #A11 Train A Plugged	3.1E-003
			060-VCTO-HFIA000-HFI-NOM	Human Error Exhaust Fan Switch Wrong Position	1.0E-001

B7-14

March 2008

Table B7.4-3. Dominant Cut Sets for The Loss of Delta Pressure in The CRCF (Continued)

Fault Tree	Cut Set %	Prob./Freq.	Basic Event	Description	Probability
	0.94	2.938E-004	060-VCTO-HFIA000-HFI-NOM	Human Error Exhaust Fan Switch Wrong Position	1.0E-001
			26D-#EEY-ITSDG-A-#DG-FTR	ITS Diesel Generator A Fails to Run	7.7E-001
			26D-#EEY-OB-SWGA-C52-SPO	13.8kV ITS SWGR A feed Breaker Spurious Operation	3.8E-003
	0.94	2.938E-004	060-VCTO-HFIA000-HFI-NOM	Human Error Exhaust Fan Switch Wrong Position	1.0E-001
			26D-#EEY-ITSDG-A-#DG-FTR	ITS Diesel Generator A Fails to Run	7.7E-001
			27A-#EEE-BUS2DGA-C52-SPO	13.8kV Open Bus 2 ITS Load Breaker Spurious Operation	3.8E-003
	0.87	2.721E-004	060-#EEE-MCC0002-MCC-FOH	CRCF ITS MCC00002 Failure	5.4E-003
			060-VCTO-FAN00A-FAN-FTR	Exhaust Fan in Train A Fails	5.1E-002
	0.86	2.675E-004	060-VCTO-DTC0A-DTC-RUP	Duct Fails between HEPA and Exhaust Fan (10 feet)	2.7E-003
			060-VCTO-HFIA000-HFI-NOM	Human Error Exhaust Fan Switch Wrong Position	1.0E-001
	0.85	2.646E-004	060-VCTO-HFIA000-HFI-NOM	Human Error Exhaust Fan Switch Wrong Position	1.0E-001
			26D-#EEESWGRDGA-AHU-FTR	13.8kV ITS Switchgear room Air Handling Unit Fails	2.6E-003
		2.559E-004	060-VCT0-EXH-005-FAN-FTR	CRCF ITS Elec Exhaust Fan 00005 Fails to Run	5.1E-002
			060-VCT0-EXH-006-FAN-FTR	CRCF ITS Elec Exh. Fan Fails to Run	5.1E-002
			060-VCTO-HFIA000-HFI-NOM	Human Error Exhaust Fan Switch Wrong Position	1.0E-001
0.82	0.74	2.312E-004	060-VCTO-FAN00A-FAN-FTR	Exhaust Fan in Train A Fails	5.1E-002
			060-VCTO-TRAINB-MAINT	Train B HVAC is Off-Line for Maintenance	4.6E-003
		2.302E-004	LOSP	Loss of offsite power	3.0E-003
			060-VCTO-HFIA000-HFI-NOM	Human Error Exhaust Fan Switch Wrong Position	1.0E-001
			26D-#EEY-ITSDG-A-#DG-FTR	ITS Diesel Generator A Fails to Run	7.7E-001
0.74	0.69	2.158E-004	060-VCTO-HEPA0A9-HEP-LEK	HEPA #09 Train A Leaks	2.2E-003
			060-VCTO-HEPALK-HFI-NOD	Operator Fails to Notice HEPA Filiter Leak in Train A	1.0E+000
			060-VCTO-HFIA000-HFI-NOM	Human Error Exhaust Fan Switch Wrong Position	1.0E-001
	0.69	2.158E-004	060-VCTO-HEPAA10-HEP-LEK	HEPA #10 Train A Leaks	2.2E-003
			060-VCTO-HEPALK-HFI-NOD	Operator Fails to Notice HEPA Filiter Leak in Train A	1.0E+000
			060-VCTO-HFIA000-HFI-NOM	Human Error Exhaust Fan Switch Wrong Position	1.0E-001
	0.69	2.158E-004	060-VCTO-HEPAA11-HEP-LEK	HEPA #11 Train A Leaks	2.2E-003
			060-VCTO-HEPALK-HFI-NOD	Operator Fails to Notice HEPA Filiter Leak in Train A	1.0E+000
			060-VCTO-HFIA000-HFI-NOM	Human Error Exhaust Fan Switch Wrong Position	1.0E-001
	0.62	1.930E-004	060-#EEE-LDCNTRB-C52-SPO	CRCF ITS Load Center Circuit Breaker (AC) Spur Op	3.8E-003
			060-VCTO-FAN00A-FAN-FTR	Exhaust Fan in Train A Fails	5.1E-002

B7-15

March 2008

Canister Receipt and Closure Facility Reliability and Event Sequence Categorization Analysis

060-PSA-CR00-00200-000-00A

Table B7.4-3. Dominant Cut Sets for The Loss of Delta Pressure in The CRCF (Continued)

Fault Tree	Cut Set %	Prob./Freq.	Basic Event	Description	Probability
	0.62	1.930E-004	060-#EEE-MCC0002-C52-SPO	CRCR MCC-00002 Feed Breaker Spurious Operation	3.8E-003
			060-VCTO-FAN00A-FAN-FTR	Exhaust Fan in Train A Fails	5.1E-002
	0.54	1.677E-004	060-VCTO-FAN00B-FAN-FTR	Exhaust Fan in Train B Fails	2.6E-002
			060-VCTO-HEPA09-DMS-FOH	Moisture Separator/Demister HEPA 09 Fails	6.5E-003
	0.54	1.677E-004	060-VCTO-FAN00B-FAN-FTR	Exhaust Fan in Train B Fails	2.6E-002
			060-VCTO-HEPA10-DMS-FOH	Moisture Separator/Demister HEPA 10 Fails	6.5E-003
	0.54	1.677E-004	060-VCTO-FAN00B-FAN-FTR	Exhaust Fan in Train B Fails	2.6E-002
			060-VCTO-HEPA11-DMS-FOH	Moisture Separator/Demister HEPA 11 Fails	6.5E-003
	0.53	1.658E-004	060-VCTO-FAN00A-FAN-FTR	Exhaust Fan in Train A Fails	5.1E-002
			060-VCTO-HEPA12-DMS-FOH	Moisture Separator/Demister HEPA 12 Fails	3.3E-003
	0.53	1.658E-004	060-VCTO-FAN00A-FAN-FTR	Exhaust Fan in Train A Fails	5.1E-002
			060-VCTO-HEPA13-DMS-FOH	Moisture Separator/Demister HEPA 13 Fails	3.3E-003
	0.53	1.658E-004	060-VCTO-FAN00A-FAN-FTR	Exhaust Fan in Train A Fails	5.1E-002
			060-VCTO-HEPA14-DMS-FOH	Moisture Separator/Demister HEPA 14 Fails	3.3E-003
	0.51	1.600E-004	060-VCTO-DRS0000-DRS-OPN	Vestibule Door Open During Receipt/Export	1.6E-004
	0.48	1.486E-004	060-VCTO-FAN00A-FAN-FTR	Exhaust Fan in Train A Fails	5.1E-002
			26D-#EEY-ITSDGB-#DG-FTR	ITS DG B Fails to Run	7.7E-001
			26D-#EEY-OB-SWGB-C52-SPO	13.8kV ITS SWGR Feedt Breaker (AC) Spurious Op	3.8E-003
	0.48	1.486E-004	060-VCTO-FAN00A-FAN-FTR	Exhaust Fan in Train A Fails	5.1E-002
			26D-#EEY-ITSDGB-#DG-FTR	ITS DG B Fails to Run	7.7E-001
			27A-#EEE-BUS3DGB-C52-SPO	13.8kV Open Bus 4 to ITS B Load Breaker (AC) Spurious Op	3.8E-003
	0.44	1.378E-004	060-#EEE-MCC0001-MCC-FOH	CRCF ITS MCC 00001 Fails	5.4E-003
			060-VCTO-FAN00B-FAN-FTR	Exhaust Fan in Train B Fails	2.6E-002
	0.43	1.339E-004	060-VCTO-FAN00A-FAN-FTR	Exhaust Fan in Train A Fails	5.1E-002
			26D-#EEE-SWGRDGB-AHU-FTR	EDGB Switchgear Room Air Handling Unit Failure to Run	2.6E-003
	0.42	1.295E-004	060-VCT0-EXH-007-FAN-FTR	CRCF ITS Elec Exhaust Fan 00007 Fails to Run	5.1E-002
			060-VCT0-EXH-008-FAN-FTR	CRCF ITS Elec Exh. Fan 8 Fails to Run	5.1E-002
			060-VCTO-FAN00A-FAN-FTR	Exhaust Fan in Train A Fails	5.1E-002
	0.37	1.164E-004	LOSP	Loss of offsite power	3.0E-003
			060-VCTO-FAN00A-FAN-FTR	Exhaust Fan in Train A Fails	5.1E-002

B7-16

March 2008

Table B7.4-3. Dominant Cut Sets for The Loss of Delta Pressure in The CRCF (Continued)

Fault Tree	Cut Set %	Prob./Freq.	Basic Event	Description	Probability
			26D-#EEY-ITSDGB-#DG-FTR	ITS DG B Fails to Run	7.7E-001
		1.022E-004	060-VCTO--B-FAIL-START	Train B Fails to Start	2.0E-003
			060-VCTO-FAN00A-FAN-FTR	Exhaust Fan in Train A Fails	5.1E-002
	0.33	1.022E-004	060-VCTO-FAN00A-FAN-FTR	Exhaust Fan in Train A Fails	5.1E-002
0.33			060-VCTO-FAN00B-FAN-FTS	Exhaust Fan in Train B Fails to Start	2.0E-003
		3.116E-002	= Total		

NOTE: AC = alternating current; CRCF = canister receipt and closure facility; DG = diesel generator; Elec = electrical; Exh = exhaust; Freq. = frequency; HEPA = high efficiency particulate air; ITS = important-to-safety; MCC = motor control center; Prob. = probability; SWGR = switchgear

Source: Original

B7.4.1.8 HVAC Fault Trees

The following fault trees show the transfers to the ITS electrical system for the HVAC equipment. For specifics on the electrical system, refer to the “AC Power System Fault Tree Analysis” in Attachment B8.

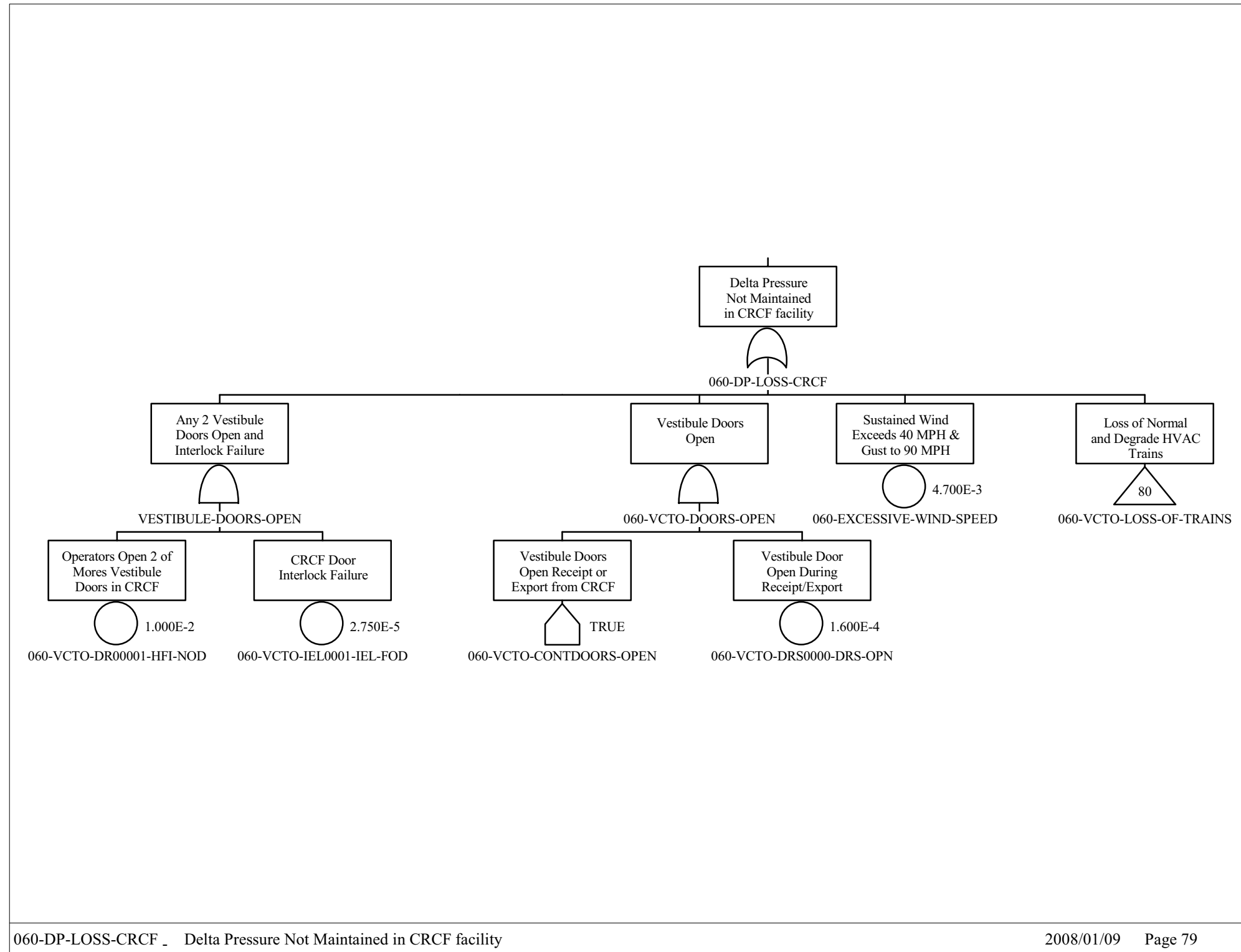

Source: Original

Figure B7.4-3. Delta Pressure not Maintained in CRCF Facility

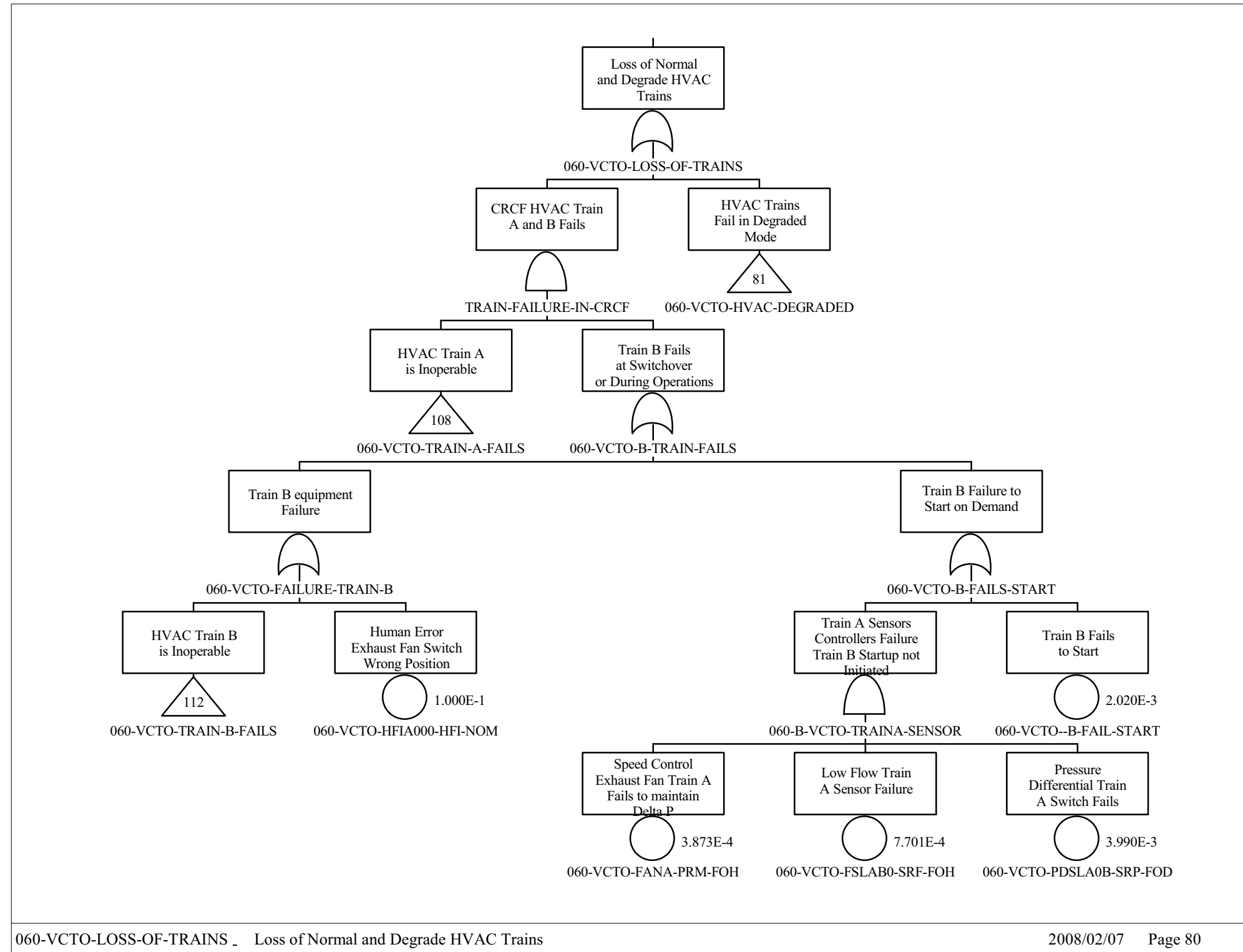

Source: Original

Figure B7.4-4. Loss of Normal and Degrade HVAC Trains

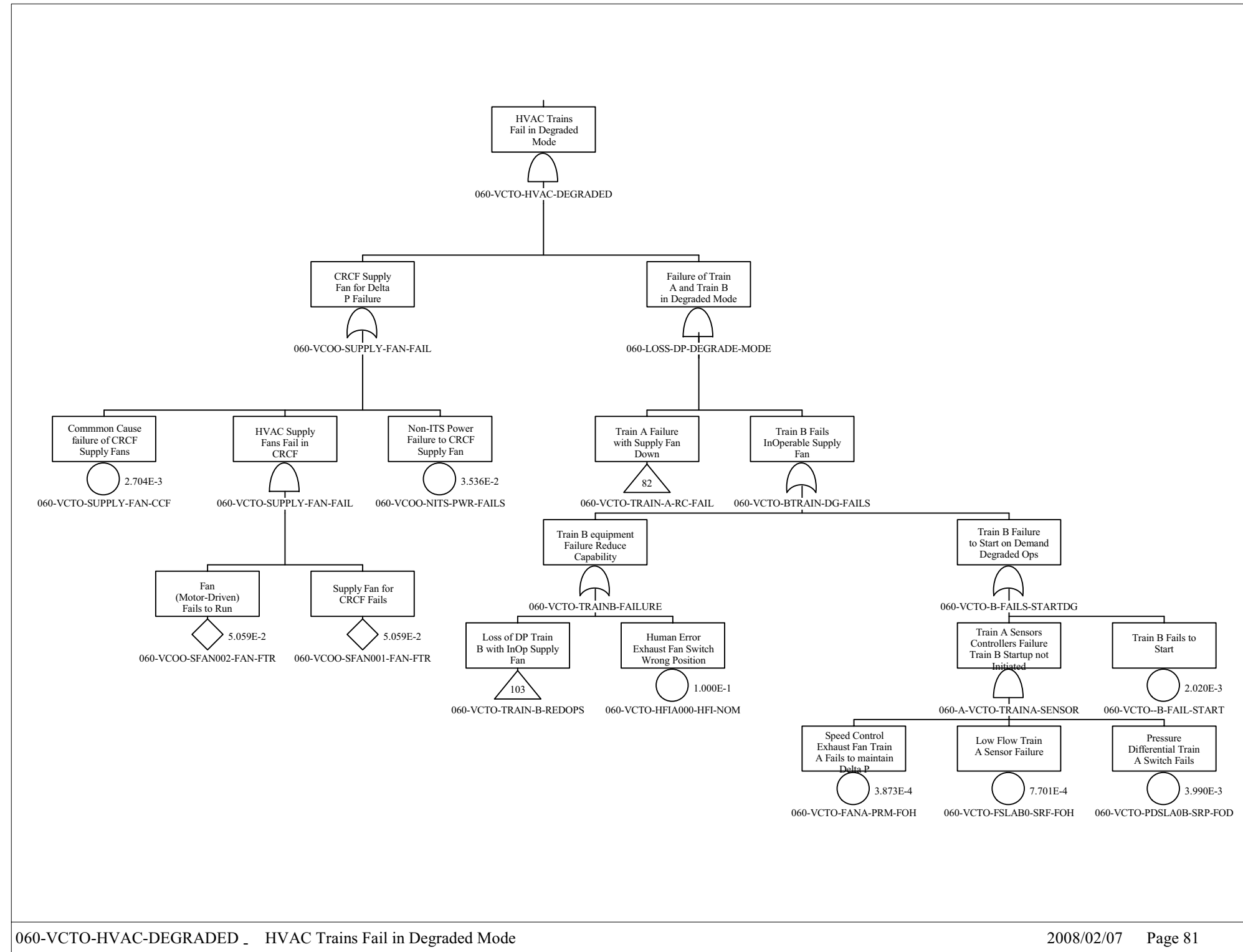

Source: Original

Figure B7.4-5. HVAC Trains Fail in Degraded Mode

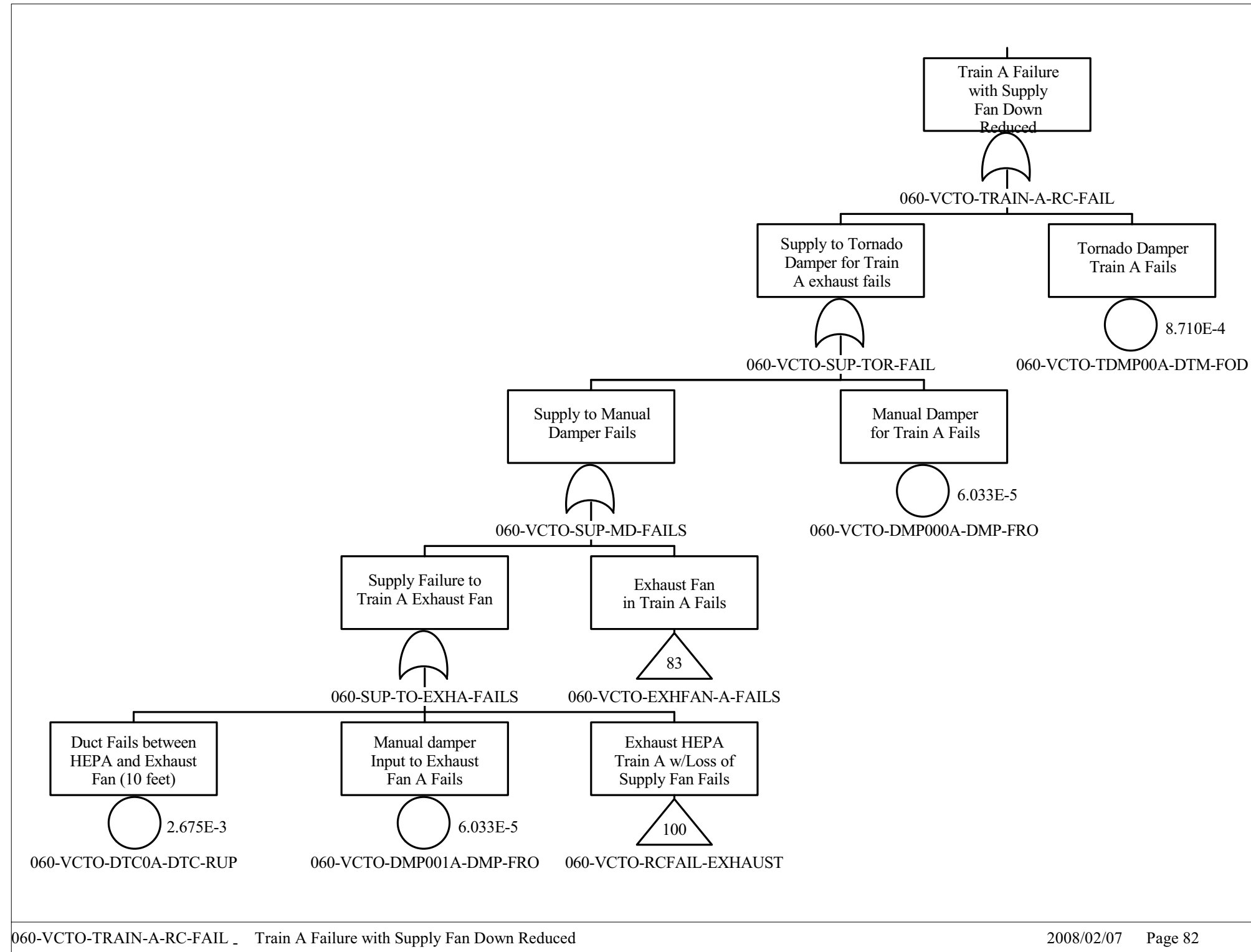

Source: Original

Figure B7.4-6. Train A Failure with Supply Fan Down Reduced

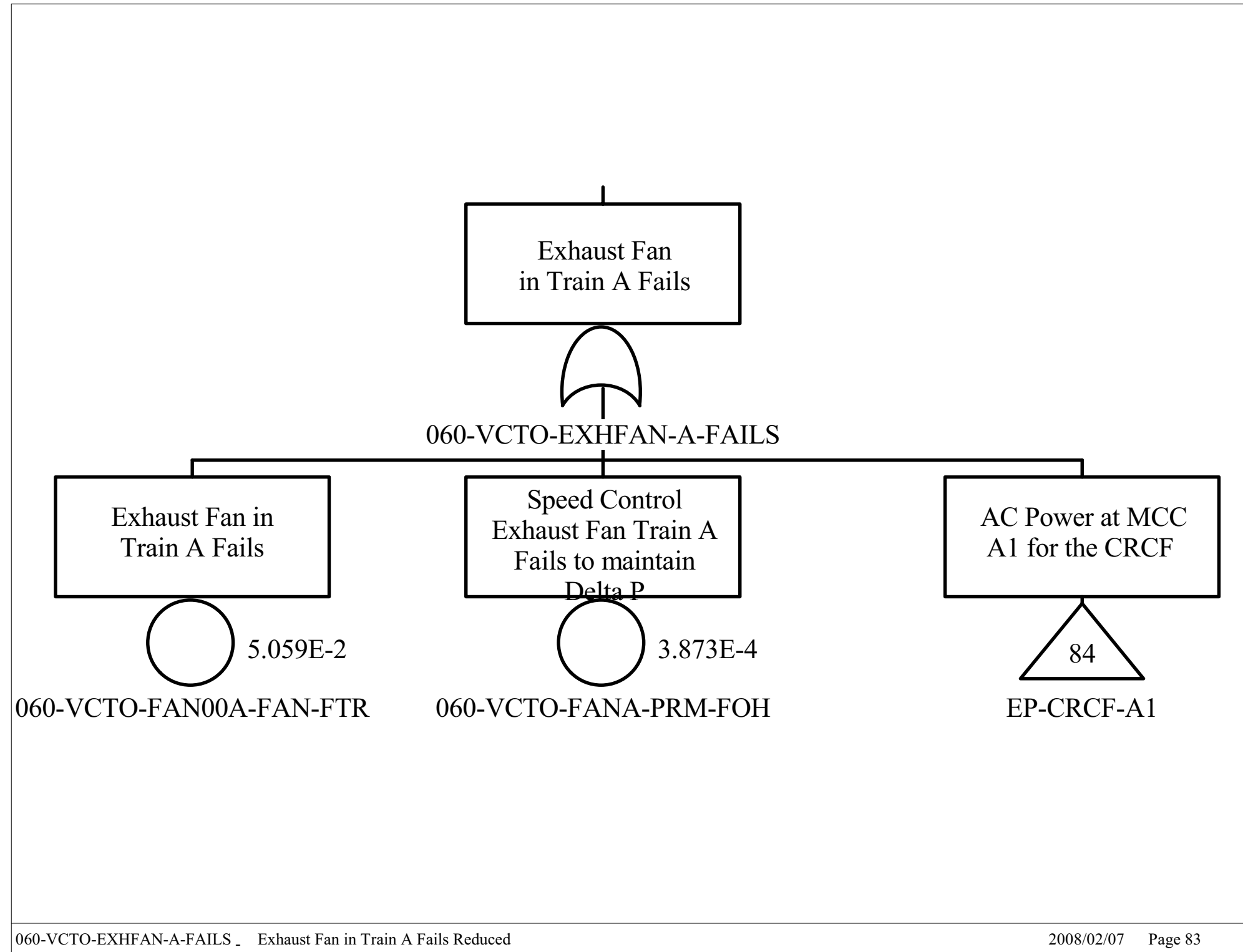

Source: Original

Figure B7.4-7. Exhaust Fan in Train A Fails Reduced

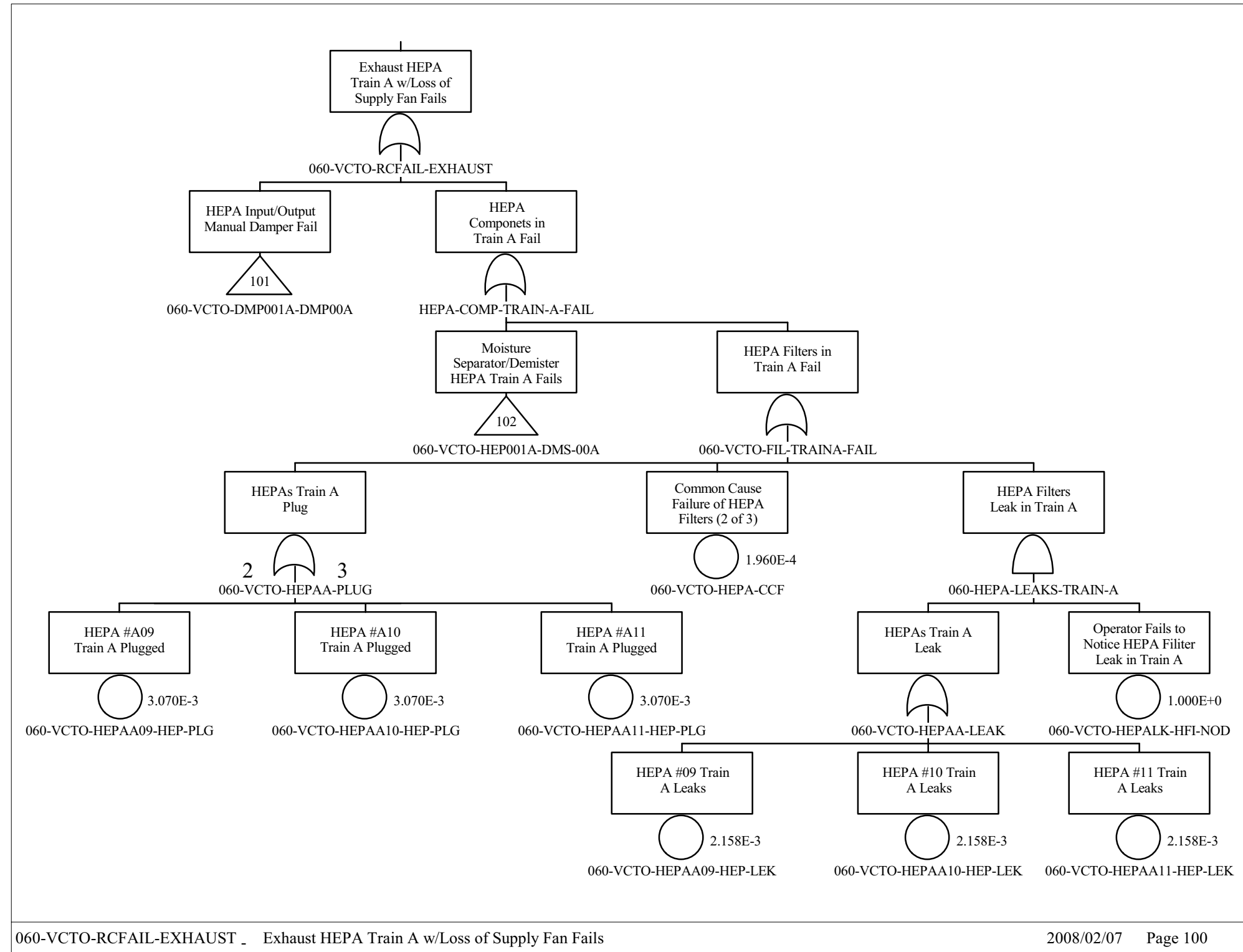

Source: Original

Figure B7.4-8. Exhaust HEPA Train A with Loss of Supply Fan Fails

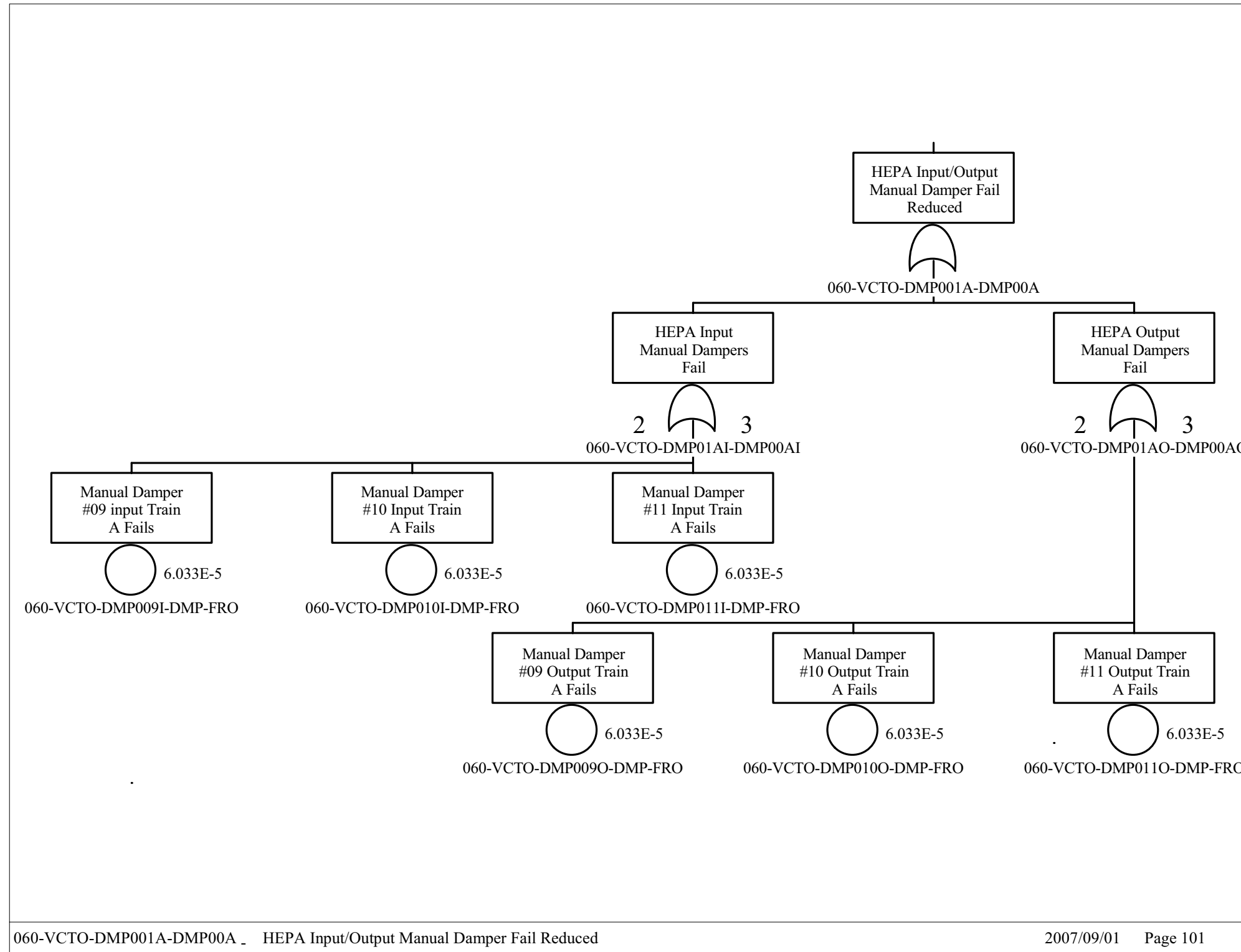

Source: Original

Figure B7.4-9. HEPA Input/Output Manual Damper Fail Reduced

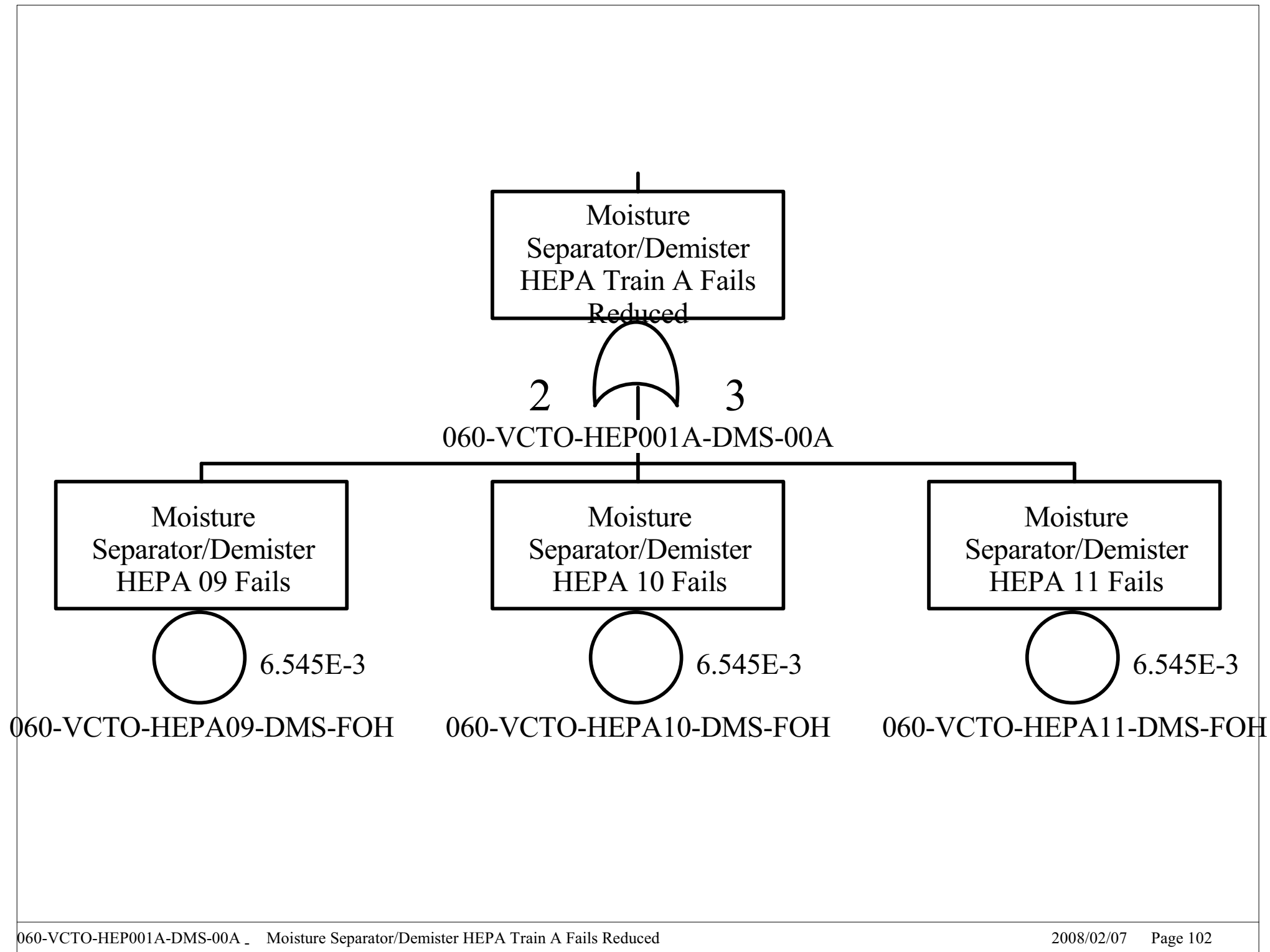

Source: Original

Figure B7.4-10. Moisture Separator/Demister HEPA Train A Fails Reduced

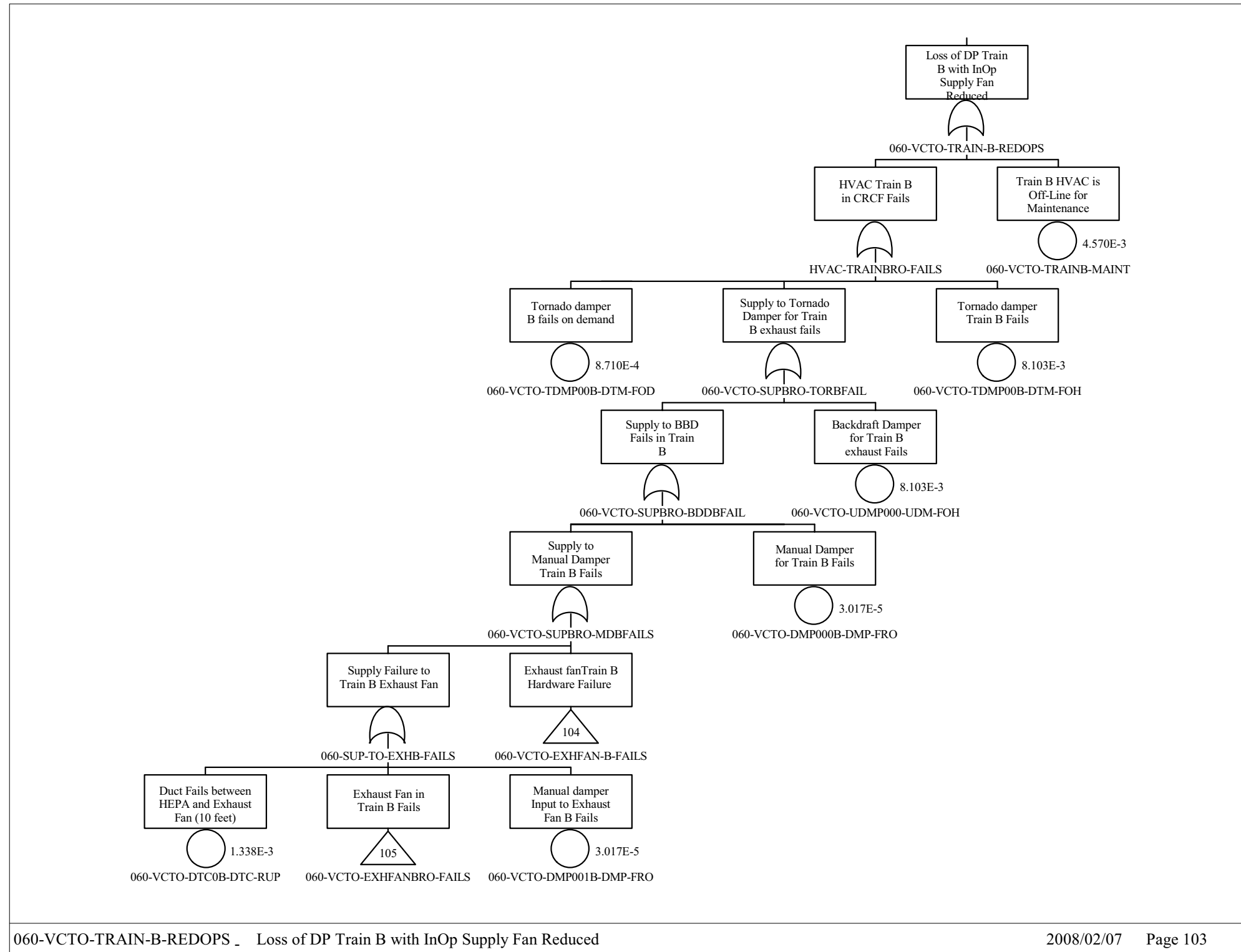

Source: Original

Figure B7.4-11. Loss of Delta Pressure Train B with InOp. Supply Fan Reduced

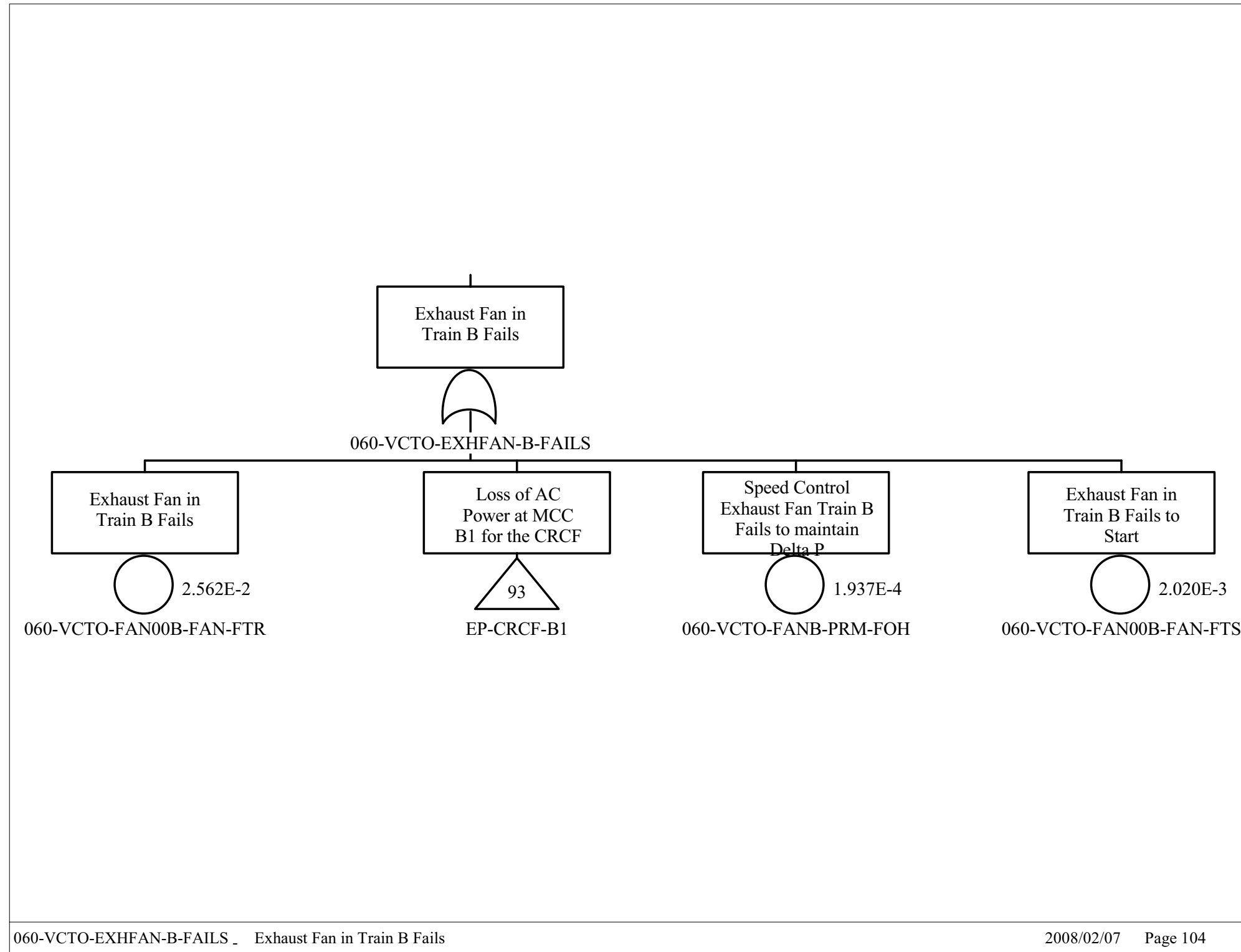

Source: Original

Figure B7.4-12. Exhaust Fan in Train B Fails

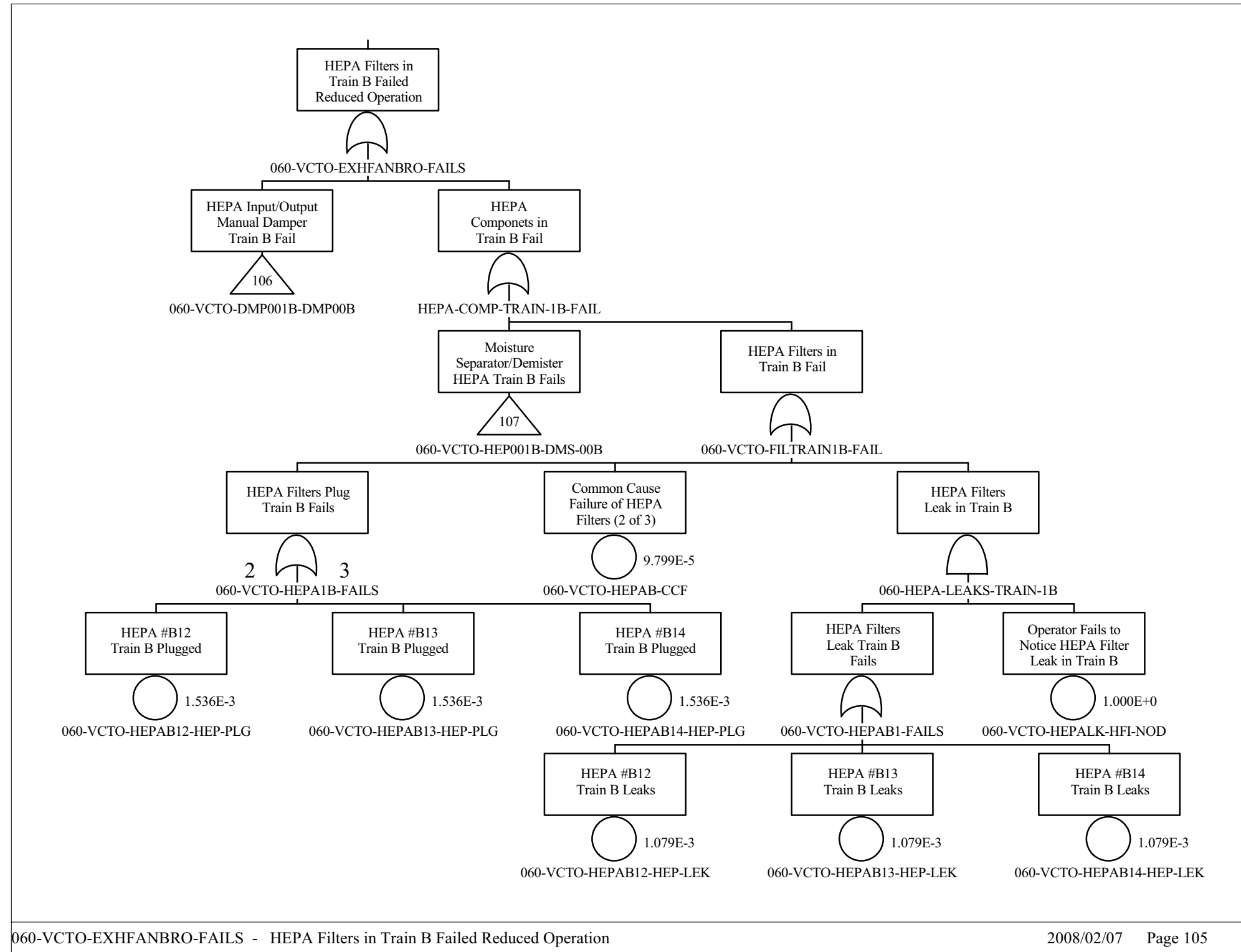

Source: Original

Figure B7.4-13. HEPA Filters in Train B Failed Reduced Operation

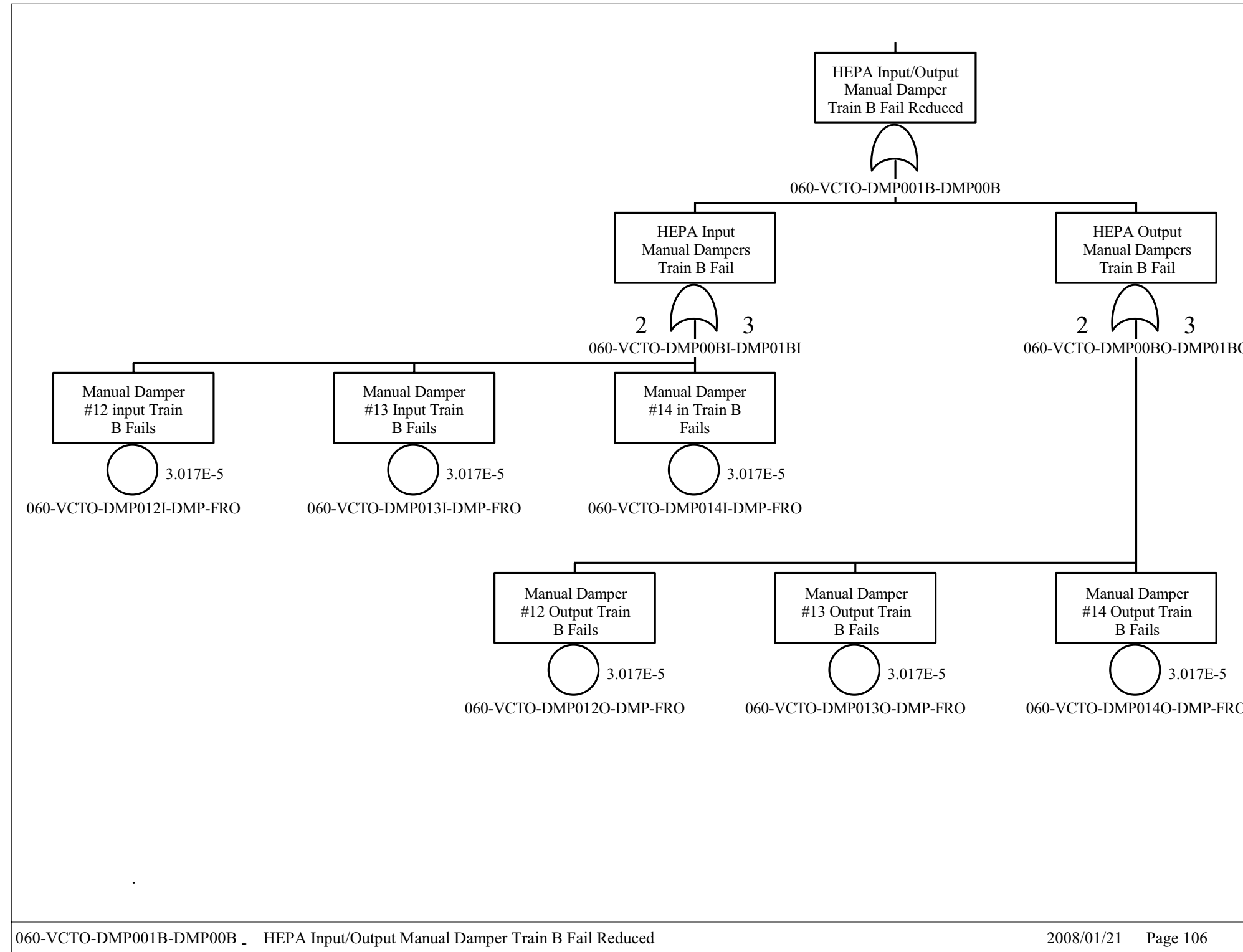

Source: Original

Figure B7.4-14. HEPA Input/Output Manual Damper Train B Fail Reduced

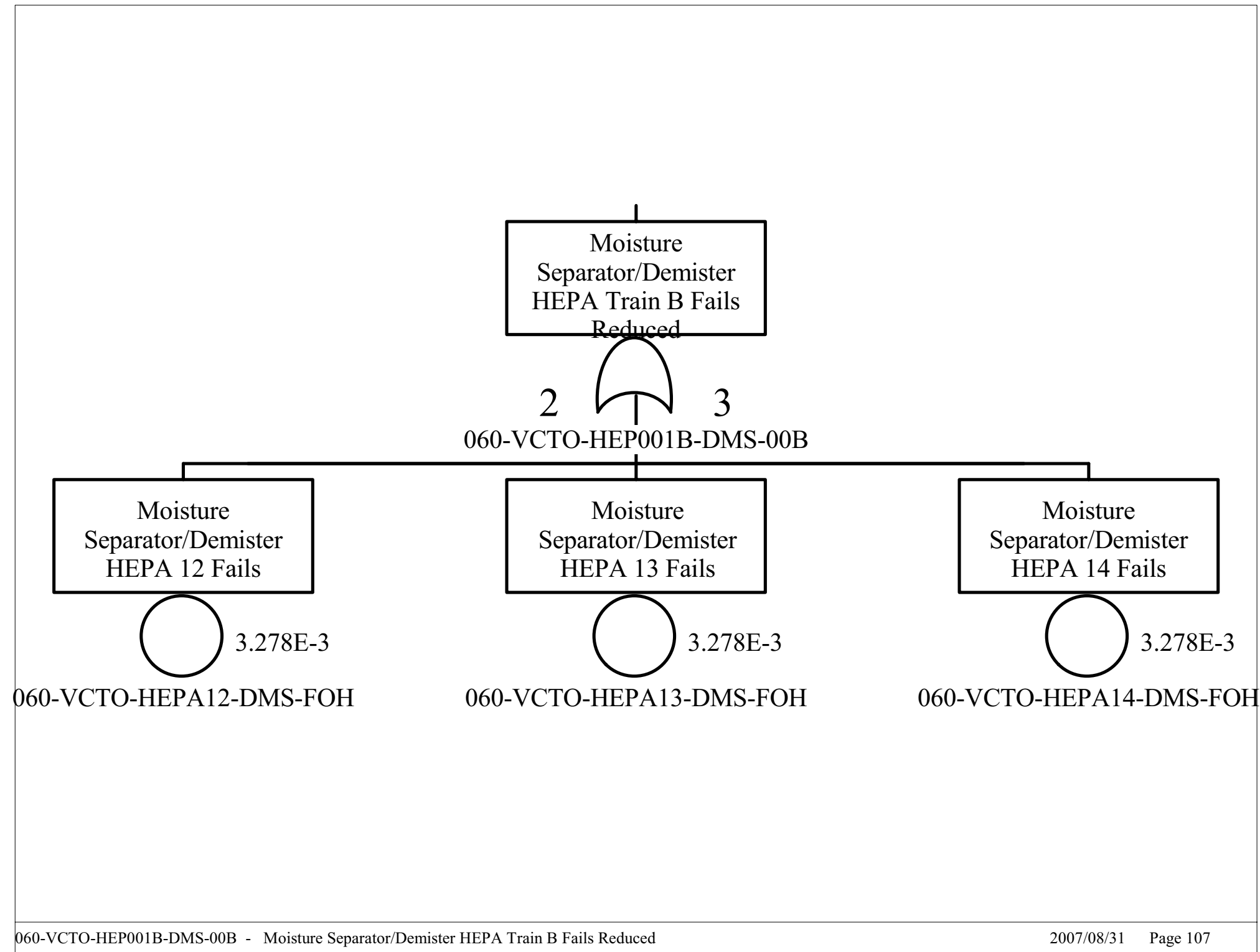

Source: Original

Figure B7.4-15. Moisture Separator/Demister HEPA Train B Fails Reduced

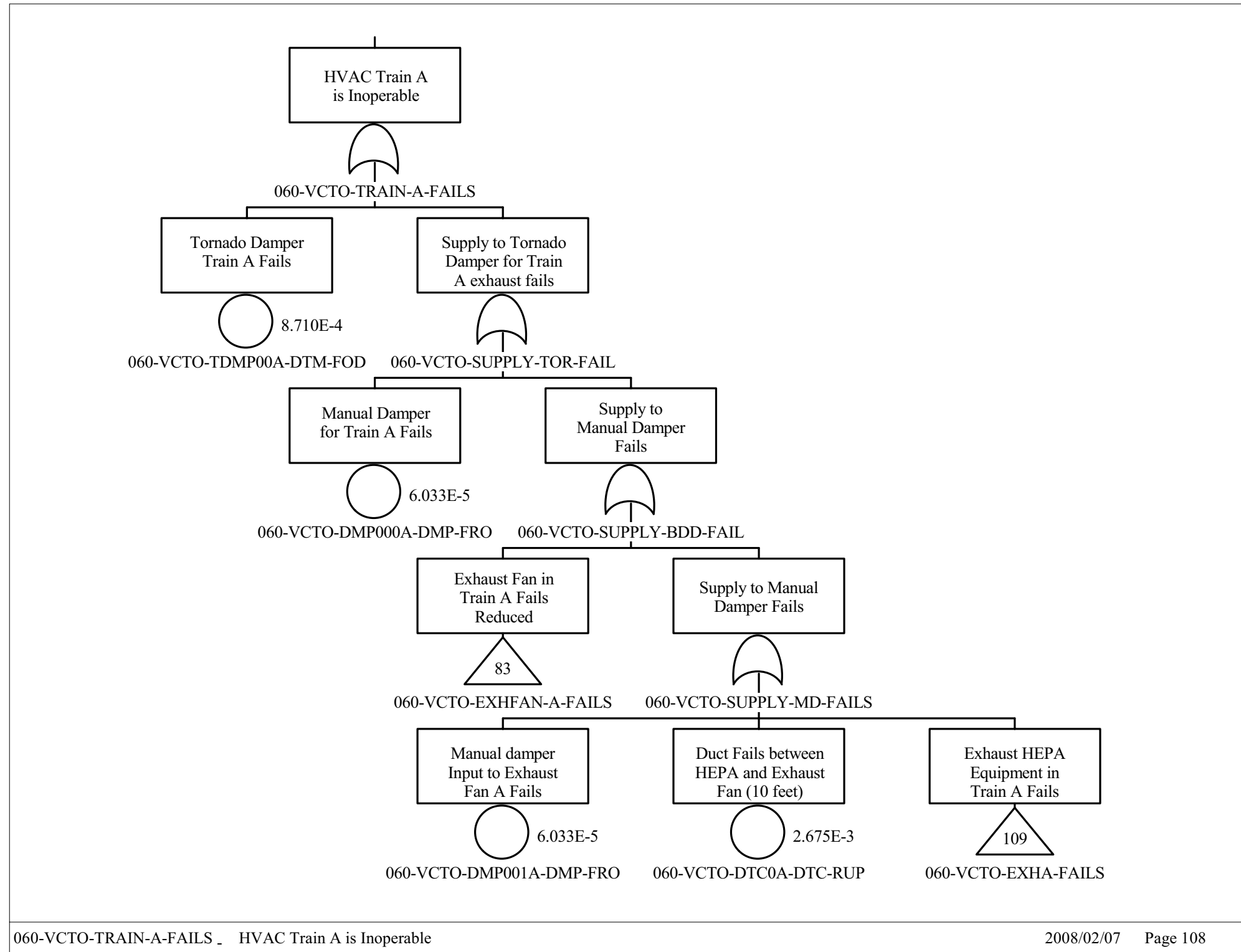

Source: Original

Figure B7.4-16. HVAC Train A is Inoperable

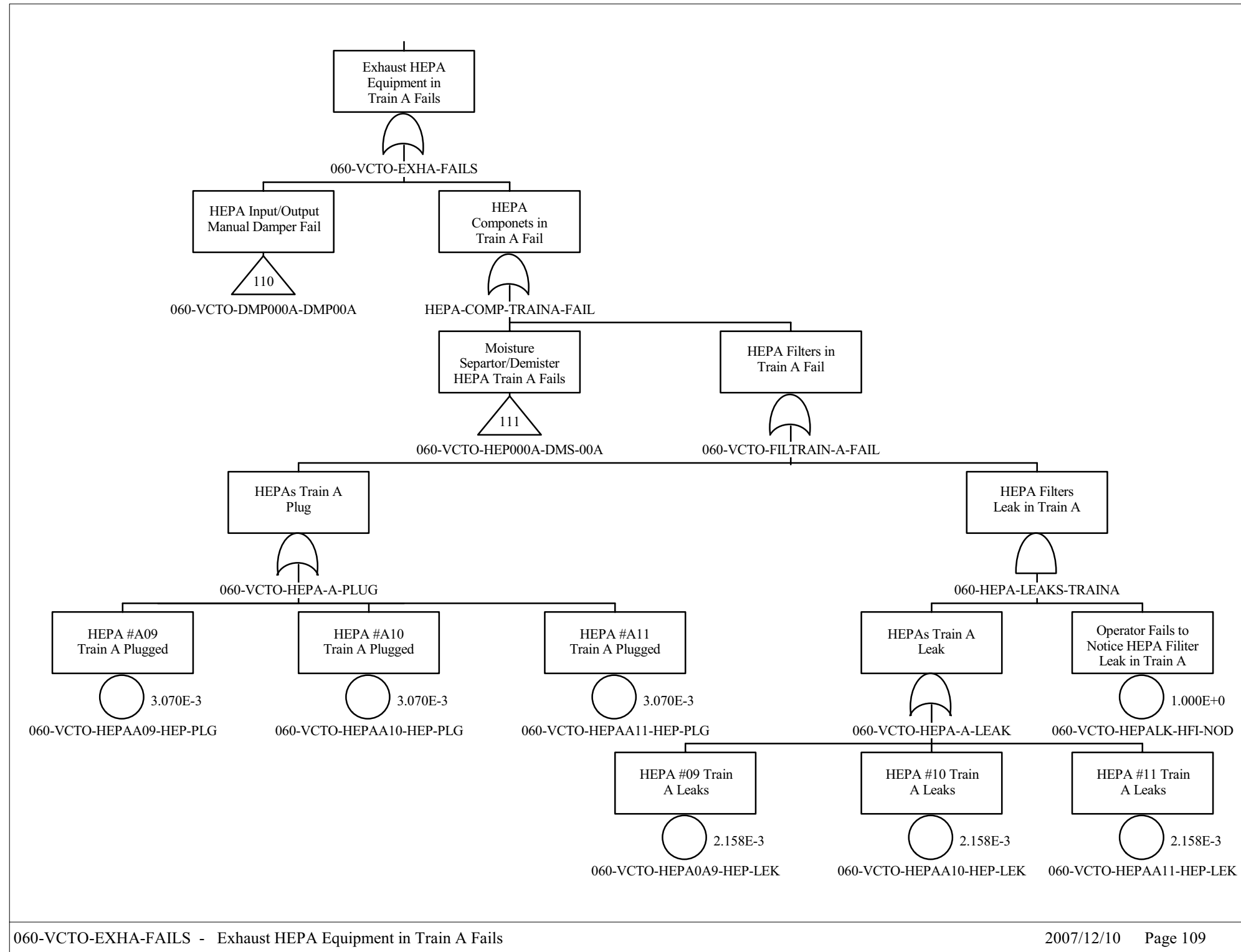

Source: Original

Figure B7.4-17. Exhaust HEPA Equipment in Train A Fails

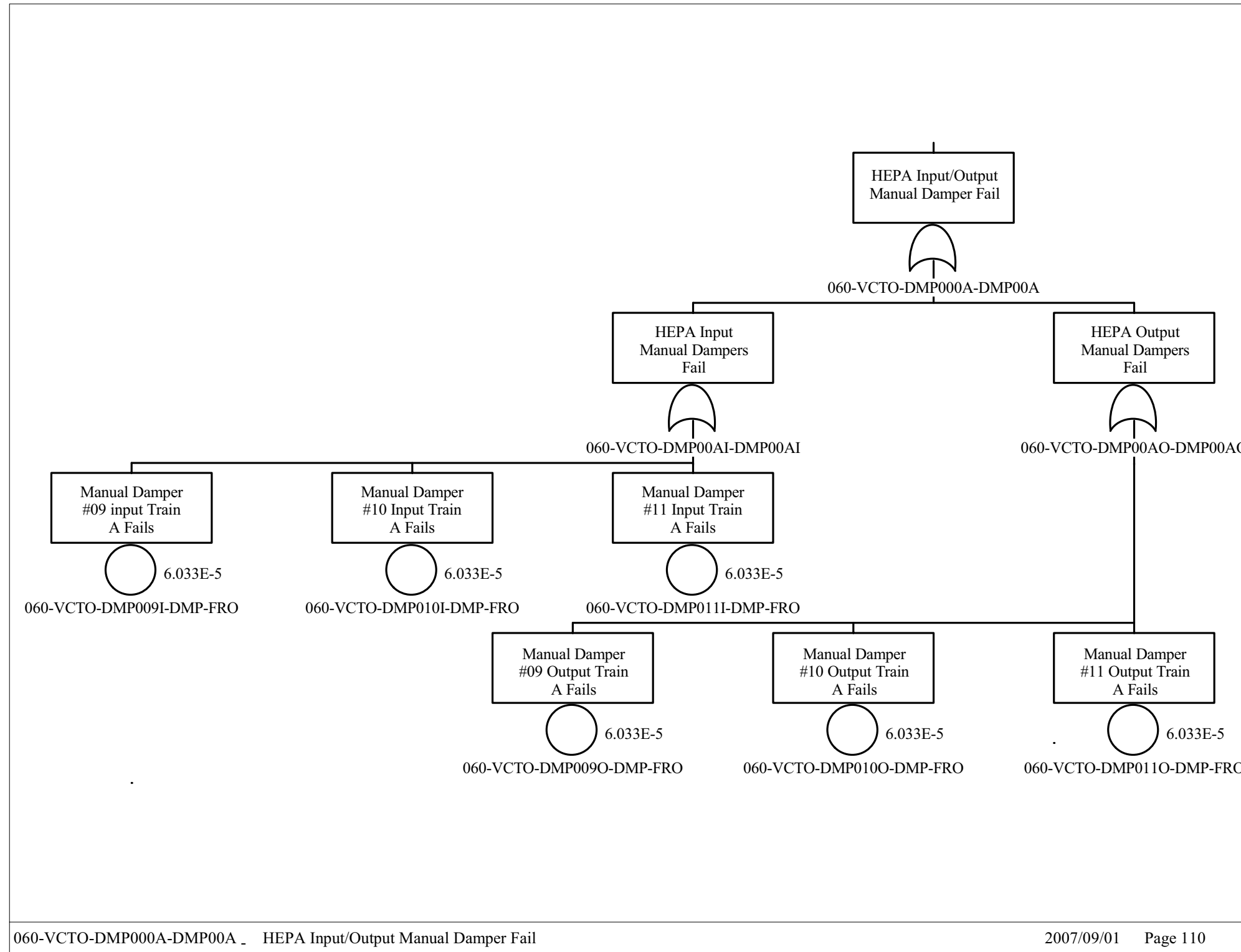

Source: Original

Figure B7.4-18. HEPA Input/Output Manual Damper Fail

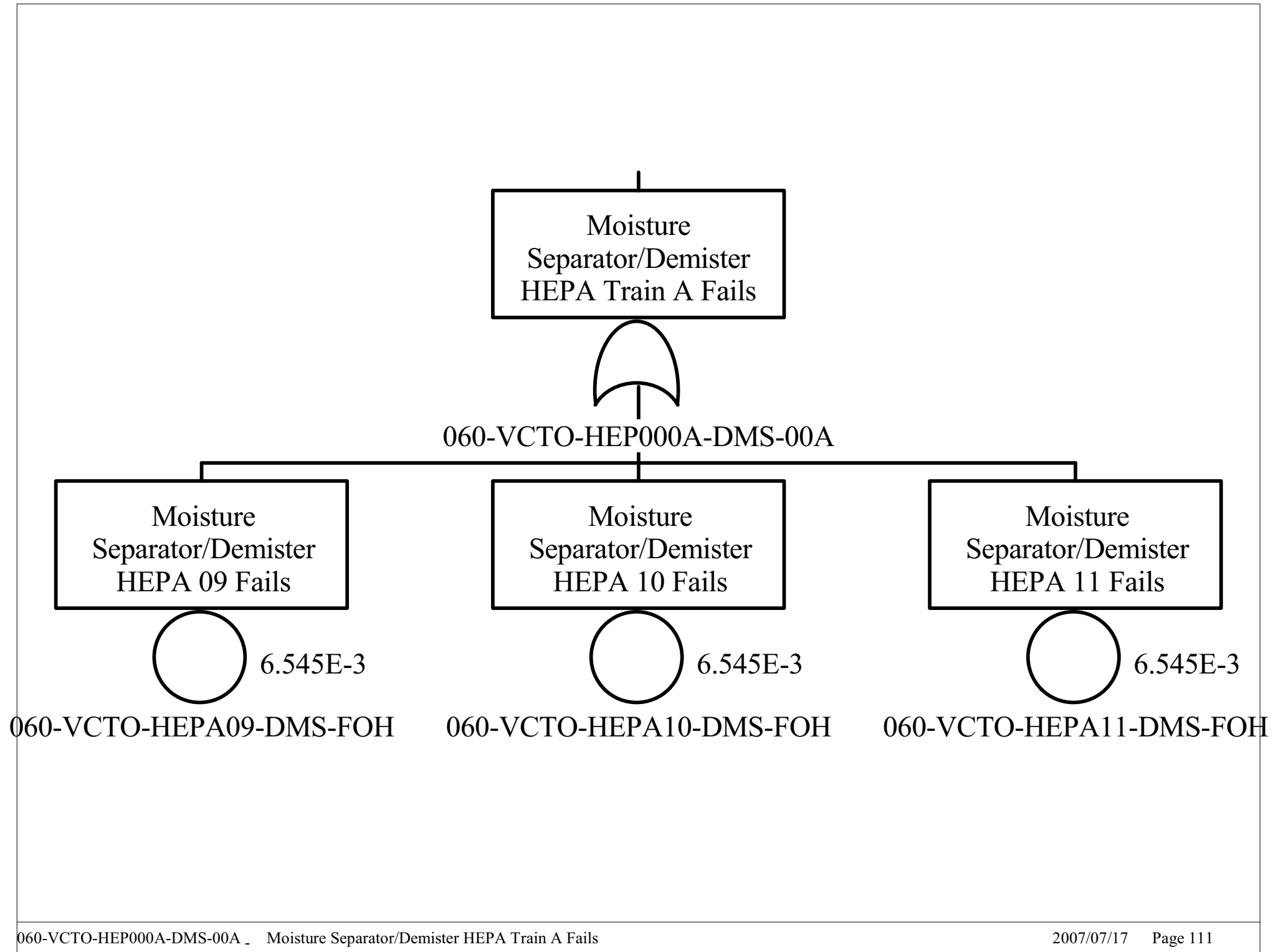

Source: Original

Figure B7.4-19. Moisture Separator/Demister HEPA Train A Fails

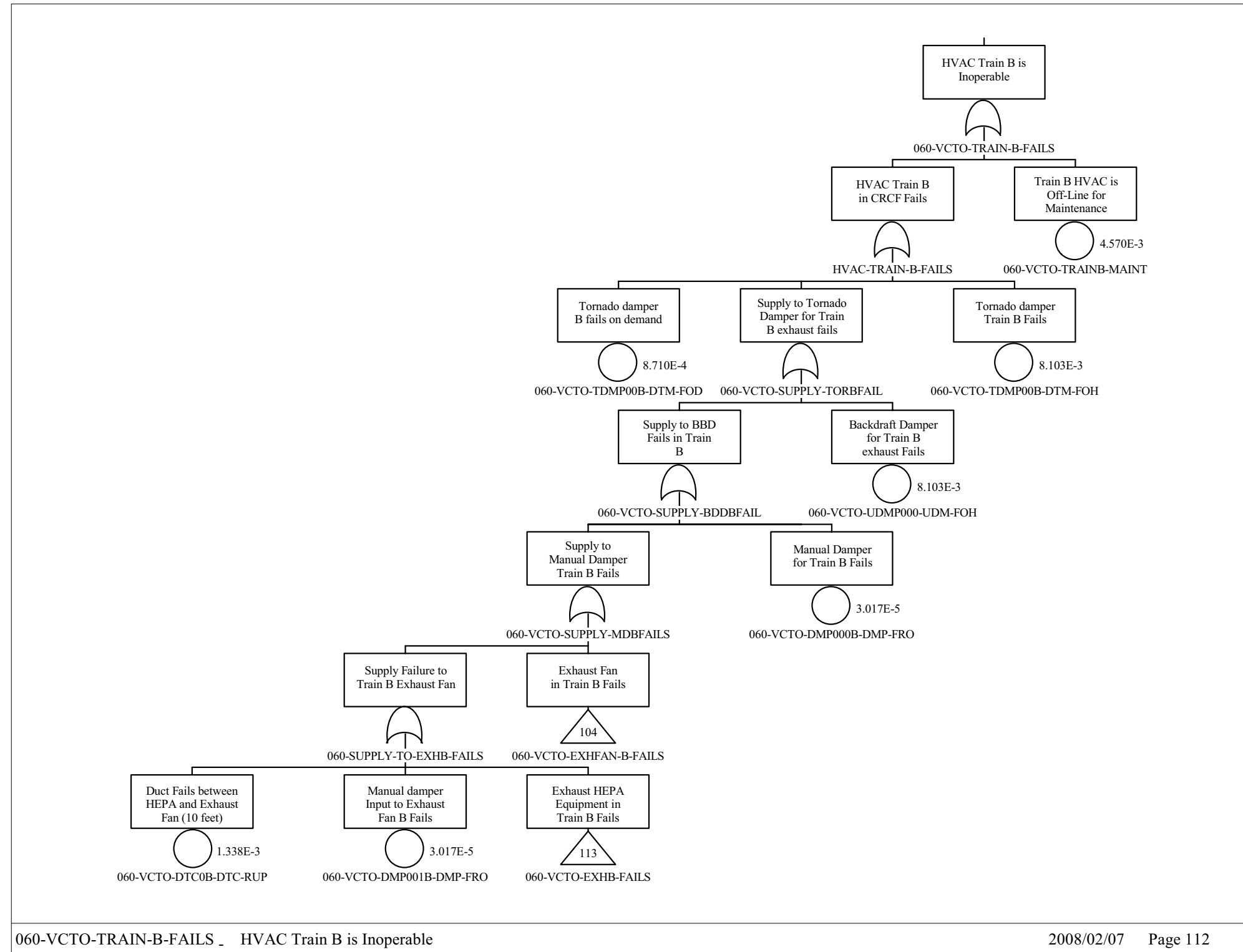

Source: Original

Figure B7.4-20. HVAC Train B is Inoperable

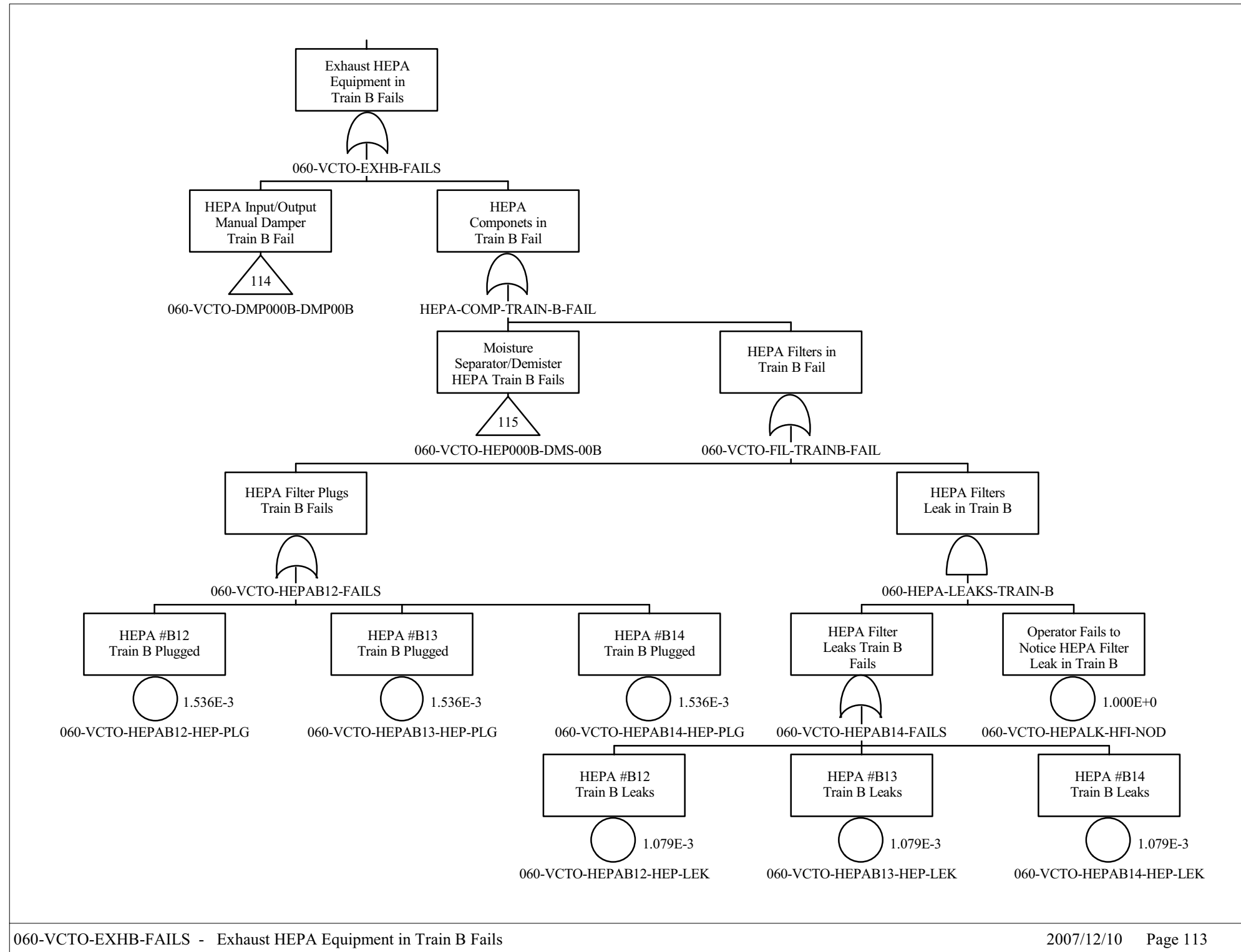

Source: Original

Figure B7.4-21. Exhaust HEPA Equipment in Train B Fails

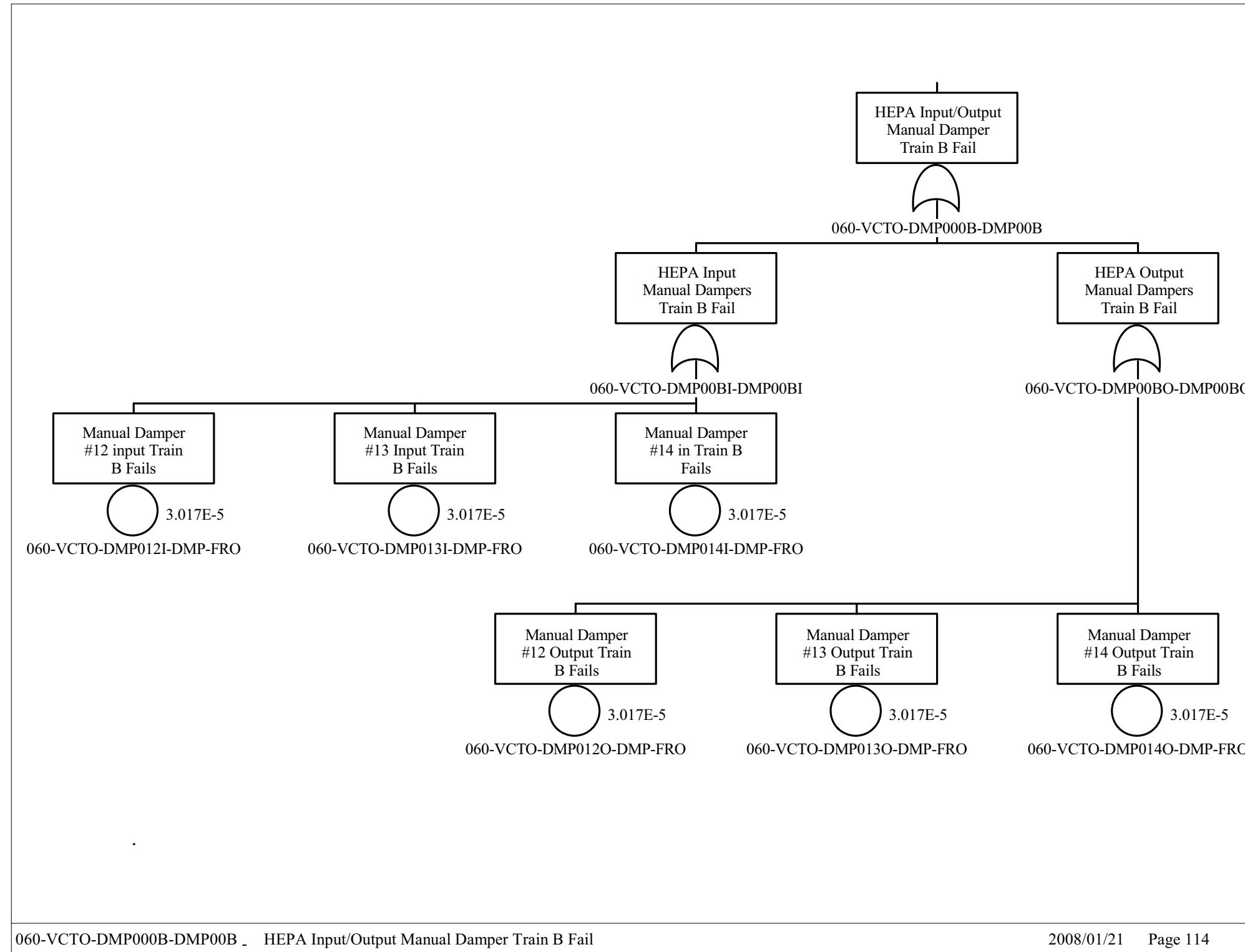

Source: Original

Figure B7.4-22. HEPA Input/Output Manual Damper Train B Fail

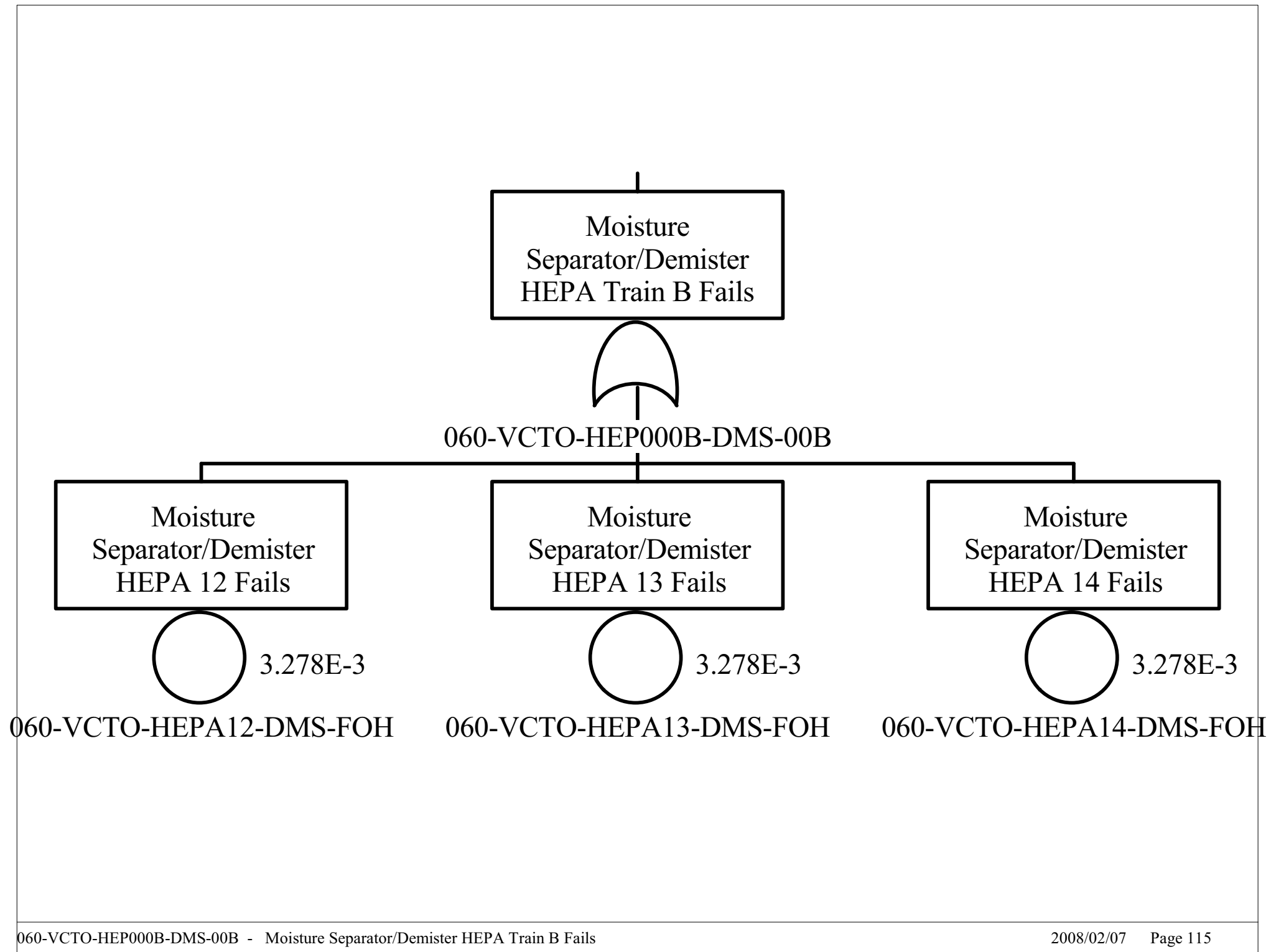

Source: Original

Figure B7.4-23. Moisture Separator/Demister HEPA Train B Fails

B8 IMPORTANT TO SAFETY AC POWER FAULT TREE ANALYSIS

B8.1 REFERENCES

Design Inputs

The PCSA is based on a snapshot of the design. The reference design documents are appropriately documented as design inputs in this section. Since the safety analysis is based on a snapshot of the design, referencing subsequent revisions to the design documents (as described in EG-PRO-3DP-G04B-00037, *Calculations and Analyses* (Ref. 2.1.1, Section 3.2.2.F)) that implement PCSA requirements flowing from the safety analysis would not be appropriate for the purpose of the PCSA.

The inputs in this Section noted with an asterisk (*) indicate that they fall into one of the designated categories described in Section 4.1, relative to suitability for intended use.

- B8.1.1 BSC (Bechtel SAIC Company) 2007. *CRCF 1 480V ITS LC – Train A 060-EEE0-LC-00001 Single Line Diagram*. 060-E10-EEE0-00301-000 REV 00B. Las Vegas, Nevada: Bechtel SAIC Company. ACC: ENG.20071129.0004.
- B8.1.2 BSC 2007. *CRCF 1 480V ITS LC – Train B 060-EEE0-LC-00002 Single Line Diagram*. 060-E10-EEE0-00401-000 REV 00B. Las Vegas, Nevada: Bechtel SAIC Company. ACC: ENG.20071129.0005.
- B8.1.3 BSC 2007. *CRCF 1 480V ITS MCC – Train A 060-EEE0-MCC-00001 Single Line Diagram*. 060-E10-EEE0-00101-000 REV 00B. Las Vegas, Nevada: Bechtel SAIC Company. ACC: ENG.20071129.0002.
- B8.1.4 BSC 2007. *CRCF 1 480V ITS MCC – Train B 060-EEE0-MCO-00002 Single Line Diagram*. 060-E10-EEE0-00201-000 REV 00B. Las Vegas, Nevada: Bechtel SAIC Company. ACC: ENG.20071129.0003.
- B8.1.5 BSC 2007. *CRCF 1 Confinement ITS Battery Room Exhaust System - Train A Ventilation & Instrumentation Diagram*. 060-M80-VCT0-00402-000-00C. Las Vegas, Nevada: Bechtel SAIC Company. ACC. ENG. 20071227.0011.
- B8.1.6 BSC 2007. *CRCF 1 Confinement ITS Battery Room Exhaust System - Train B Ventilation & Instrumentation Diagram*. 060-M80-VCT0-00404-000-00C. Las Vegas, Nevada: Bechtel SAIC Company. ACC. ENG. 20071227.0012.
- B8.1.7 BSC 2007. *CRCF 1 Confinement ITS Electrical Room HVAC System - Train A Ventilation & Instrumentation Diagram*. 060-M80-VCT0-00401-000-00B. Las Vegas, Nevada: Bechtel SAIC Company. ACC. ENG.20071119.0023.
- B8.1.8 BSC 2007. *CRCF 1 Confinement ITS Electrical Room HVAC System - Train B Ventilation & Instrumentation Diagram*. 060-M80-VCT0-00403-000-00B. Las Vegas, Nevada: Bechtel SAIC Company. ACC. ENG.20071119.0025.

- B8.1.9 BSC 2007. *Emergency Diesel Generator Facility – 480V ITS MCC 26D-EEE0-MCC-00001 Single Line Diagram (Train A)*. 26D-E10-EEE0-00301-000 REV 00B. Las Vegas, Nevada: Bechtel SAIC Company. ACC: ENG.20071130.0026.
- B8.1.10 BSC 2007. *Emergency Diesel Generator Facility – 480V ITS MCC 26D-EEE0-MCC-00002 Single Line Diagram (Train B)*. 26D-E10-EEE0-00401-000 REV 00B. Las Vegas, Nevada: Bechtel SAIC Company. ACC: ENG.20071130.0027.
- B8.1.11 BSC 2007. *Emergency Diesel Generator Facility – Fuel Oil System Calculation*. 26D-M6C-EG00-00200-000-00A. Las Vegas, Nevada: Bechtel SAIC Company. ACC: ENG.20071025.0001.
- B8.1.12 BSC 2007. *Emergency Diesel Generator Facility – Generator Room Ventilation System Calculation*. 26D-M5C-VNI0-00100-000-00B. Las Vegas, Nevada: Bechtel SAIC Company. ACC: ENG.20071015.0018.
- B8.1.13 BSC 2007. *Emergency Diesel Generator Facility – ITS 125V DC System Single Line Diagram (Train A)*. 26D-E10-EED0-00101-000 REV 00A. Las Vegas, Nevada: Bechtel SAIC Company. ACC: ENG.20071026.0015.
- B8.1.14 B SC 2007. *Emergency Diesel Generator Facility – ITS 125V DC System Single Line Diagram (Train B)*. 26D-E10-EED0-00201-000 REV 00A. Las Vegas, Nevada: Bechtel SAIC Company. ACC: ENG.20071026.0016.
- B8.1.15 BSC 2007. *Emergency Diesel Generator Facility - Switchgear and Battery Rooms Ventilation System Calculation*. 26D-M5C-VNI0-00200-000-00C. Las Vegas, Nevada: Bechtel SAIC Company. ACC: ENG.20071022.0001.
- B8.1.16 BSC 2008. *Normal Power System 13.8kV Site Distribution Overall Single Line Diagram*. 000-E10-EEN0-00202-000 REV 00C. Las Vegas, Nevada: Bechtel SAIC Company. ACC: ENG. 20080206.0078.
- B8.1.17 BSC 2008. *Emergency Diesel Generator Facility-13.8kV ITS Switchgear 26D-EEE0-SWGR-00001 Single Line Diagram (Train A)*. 26D-E10-EEE0-00101-000 REV 00C. Las Vegas, Nevada: Bechtel SAIC Company. ACC: ENG.20080204.0001.
- B8.1.18 B SC 2008. *Emergency Diesel Generator Facility-13.8kV ITS Switchgear 26D-EEE0-SWGR-00002 Single Line Diagram (Train B)*. 26D-E10-EEE0-00201-000 REV 00C. Las Vegas, Nevada: Bechtel SAIC Company. ACC: ENG.20080204.0002.
- B8.1.19 *Eide, S.A.; Gentillon, C.D.; Wierman, T.E.; and Rasmuson, D.M. 2005. *Analysis of Loss of Offsite Power Events: 1986-2004*. Volume 1 of *Reevaluation of Station Blackout Risk at Nuclear Power Plants*. NUREG/CR-6890. Washington, D.C.: U.S. Nuclear Regulatory Commission. ACC: MOL.20071114.0164.

B8.2 ITS AC POWER DESCRIPTION

The ITS AC power system supplies power to the ITS HVAC systems in the CRCF, WHF and RF. The ITS power system makes use of two elements: (1) the onsite ITS power supply and (2) the ITS equipment needed to supply power from the onsite ITS power supply to the ITS loads in each of the site facilities. During normal operations AC power is supplied from two offsite 138 kV power lines through the 138 kV – 13.8 kV switchyard and then through the plant AC power distribution system to the various facilities throughout the site. Off-normal conditions for the distribution of AC power occur during a loss of offsite power (LOSP). A LOSP may be the result of problems on the power grid, or the result of failures within the plant AC power systems (most likely within the 138 kV – 13.8 kV switchyard). Under these conditions, the AC power source for the CRCF ITS equipment is two onsite ITS diesel generators. There are several diesel generators located onsite. However there are only two generators designated as ITS; the two that support each division of ITS equipment (A or B) in the three CRCFs, the WHF and the RF. Power is supplied to ITS loads via the same onsite AC power distribution system that is used during normal operation. Each ITS diesel generator supplies power to one division (A or B) of ITS systems. Each ITS diesel generator, its associate support systems and the power distribution system is independent and electrically isolated, of the other diesel generator, its support systems and power distribution system.

There are three CRCFs on site. The same ITS diesel generators, 13.8 kV ITS switchgear, and associated equipment and support systems are used to support all three facilities. The AC power distribution equipment from the 13.8 kV ITS Switchgear to each CRCF's set of ITS equipment are separate but identical for all three facilities. Only one set of CRCF ITS AC power fault trees have been developed, and are applicable for all three CRCFs.

B8.2.1 Normal AC Power Distribution

Normal AC power to the CRCF ITS equipment is provided via two 13.8 kV ITS Switchgears (A and B), one supplying CRCF Train A ITS loads and the second supplying power to CRCF Train B ITS loads. These two 13.8 kV ITS switchgears (Figures B8.2-1 through B8.2-3) are normally aligned to receive power from the site 138 kV - 13.8 kV switchyard through Open Buses 2 and 4.

In addition to supplying power to the ITS loads in the CRCF, the 13.8 kV ITS switchgear supplies power to equipment in the EDGF required to support ITS diesel generator operation. These loads include the diesel generator room fans, 13.8 kV ITS Switchgear Room and Battery Room air handling unit, the ITS diesel generator fuel oil pumps, and DC power (via a battery charger) to operate the ITS switchgear circuit breakers (Figures B8.2-4 and B8.2-5 for ITS diesel generator Train A and Figures B8.2-6 and B8.2-7 for ITS diesel generator Train B).

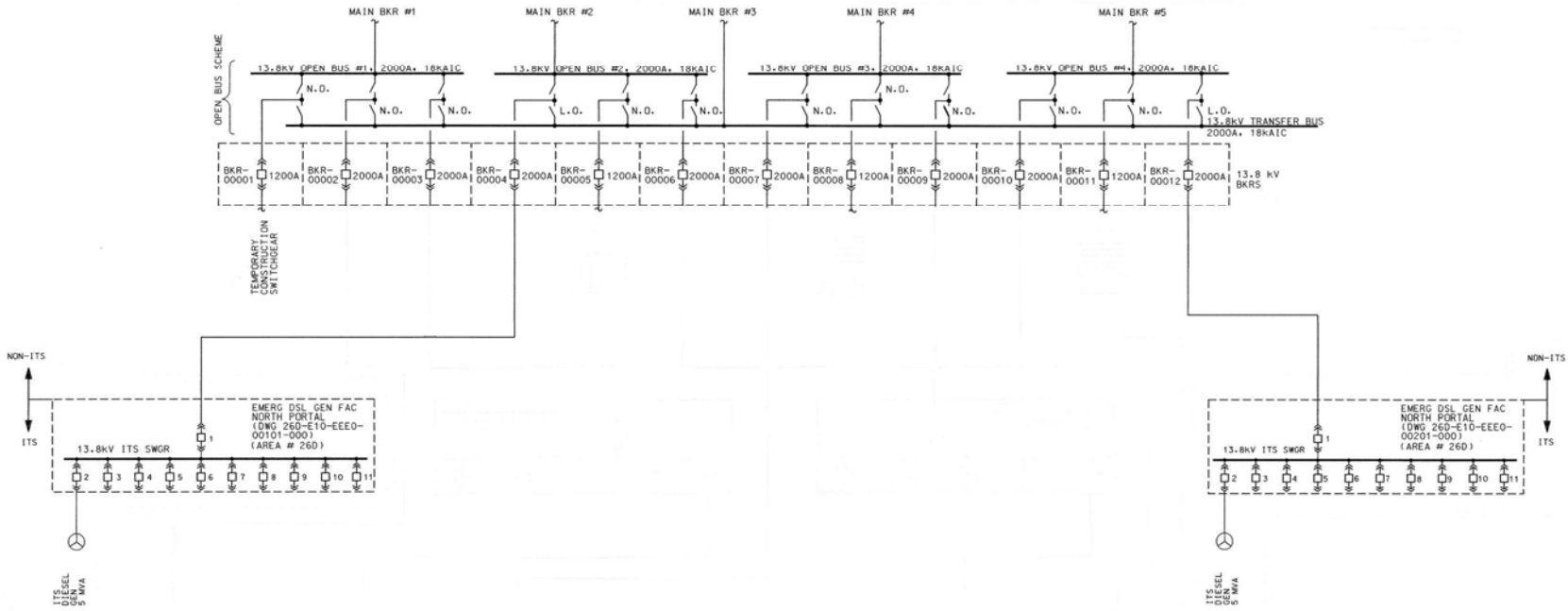

NOTE: Legibility of figure does not affect technical content of the document. See source for detail.

Source: Ref. B8.1.16

Figure B8.2-1. AC Power – Main Electrical Distribution

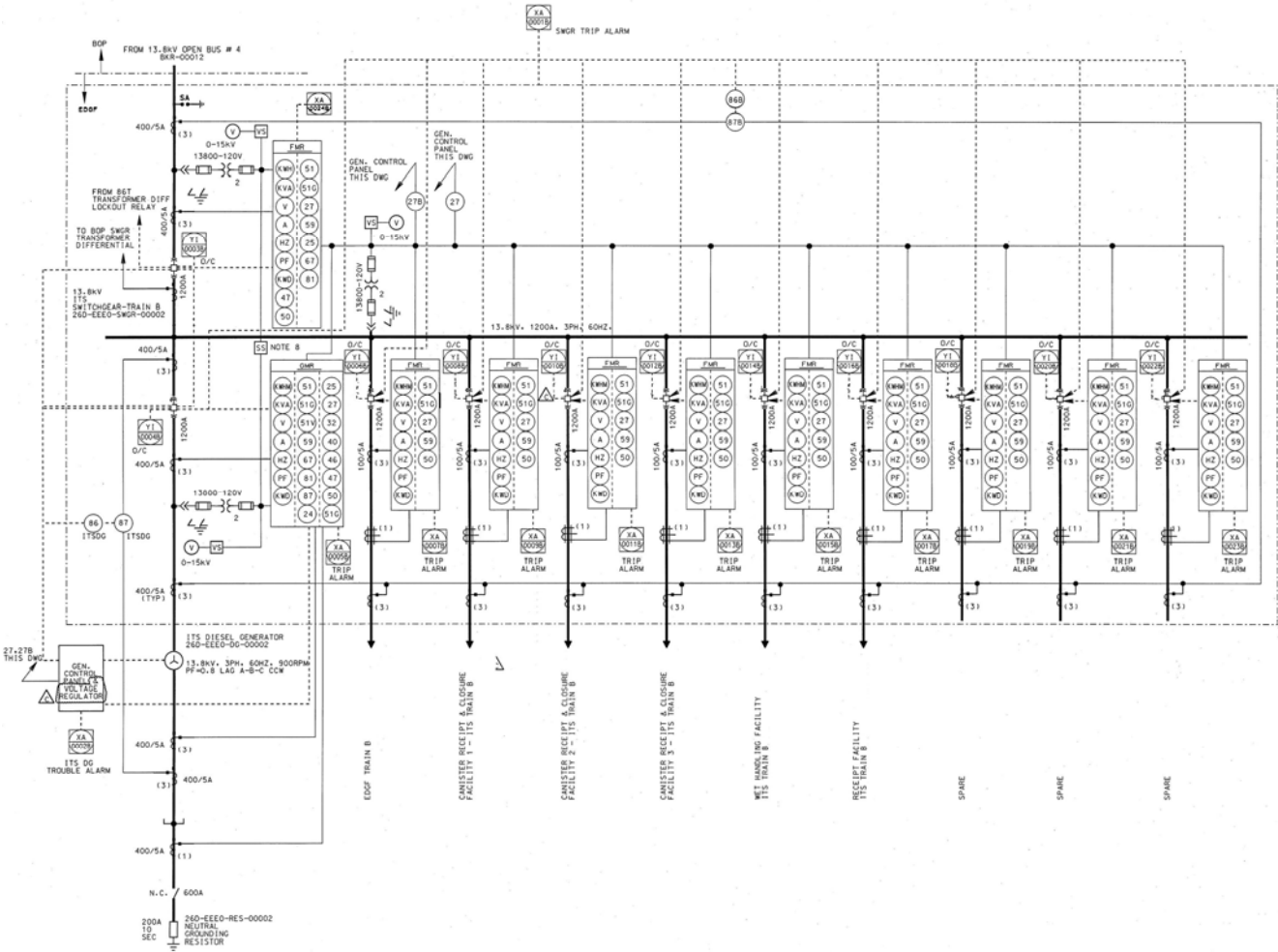

NOTE: Legibility of figure does not affect technical content of the document. See source for detail.

Source: Ref. B8.1.18

Figure B8.2-3. AC Power – 13.8 kV ITS Switchgear Train B

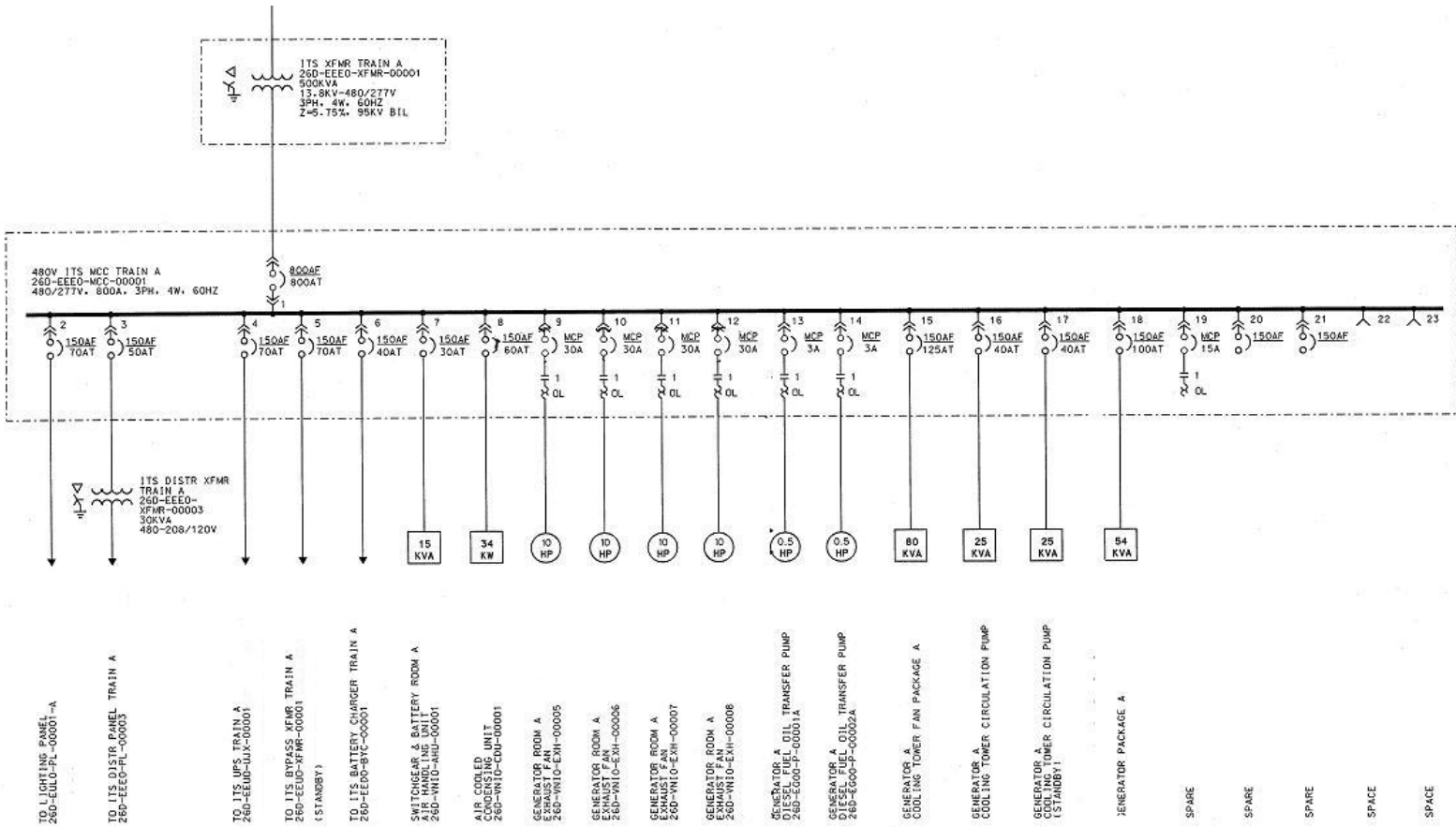

NOTE: Legibility of figure does not affect technical content of the document.. See source for detail.

Source: Ref. B8.1.9

Figure B8.2-4. Emergency Diesel Generator Facility – 480V ITS Motor Control Center Train A

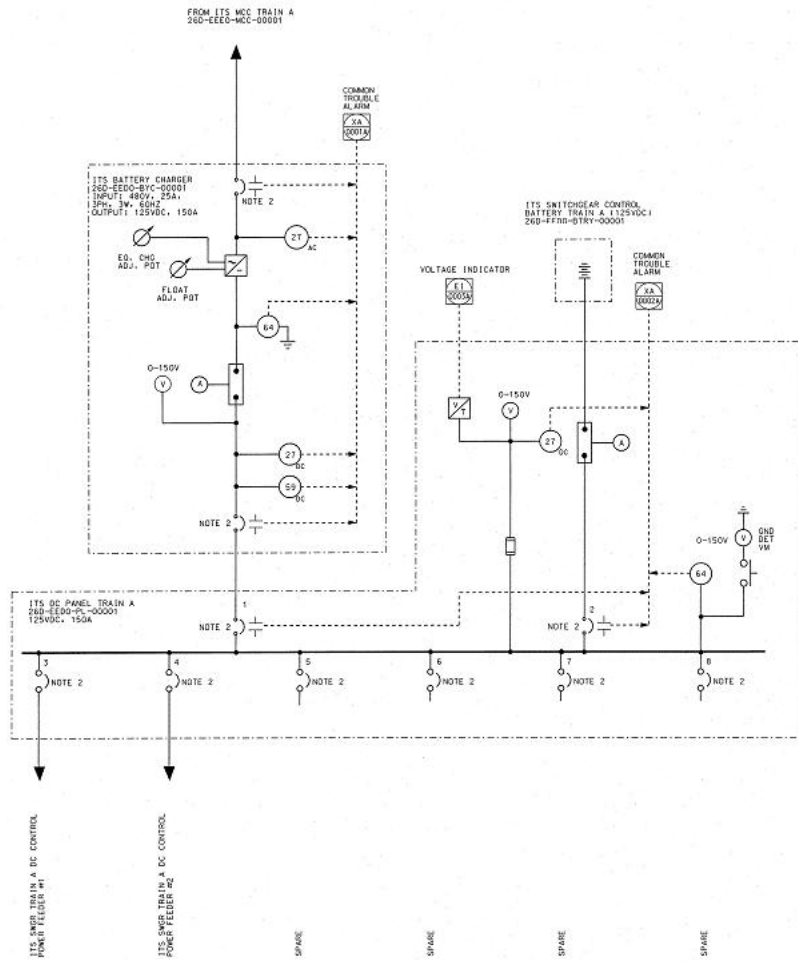

NOTE: Legibility of figure does not affect technical content of the document. See source for detail.

Source: Ref. B8.1.13

Figure B8.2-5. ITS 125 V DC System Train A

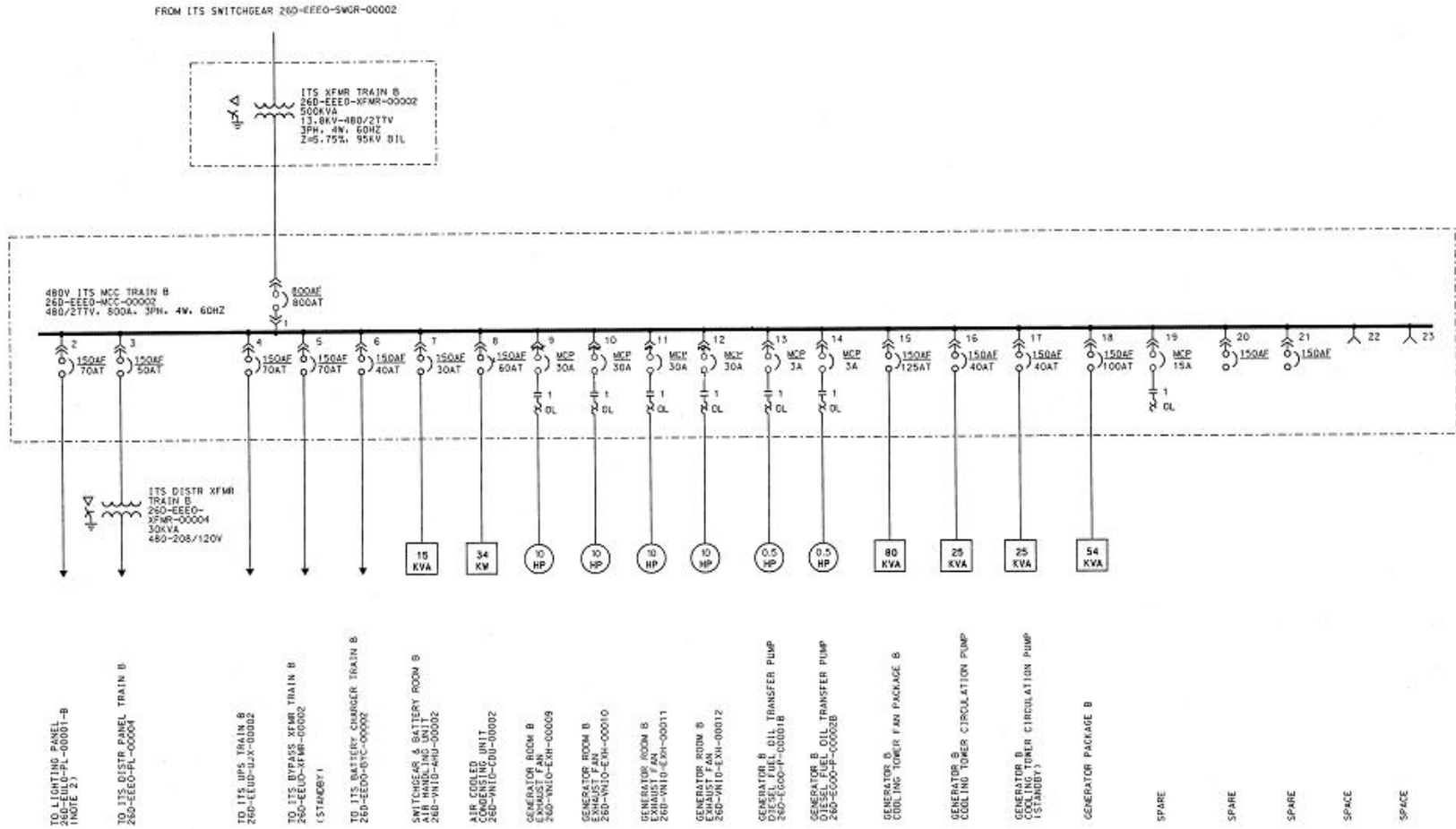

NOTE: Legibility of figure does not affect technical content of the document. See source for detail.

Source: Ref. B8.1.10

Figure B8.2-6. Emergency Diesel Generator Facility – 480V ITS Motor Control Center Train B

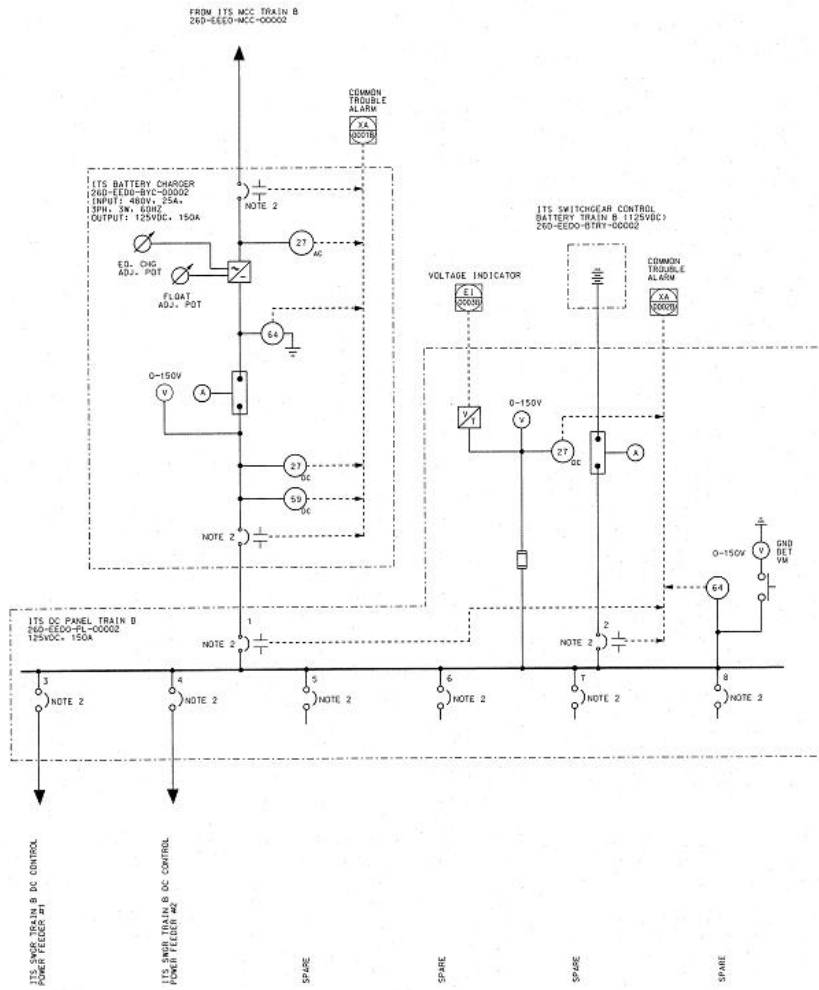

NOTE: Legibility of figure does not affect technical content of the document. See source for detail.

Source: Ref. B.8.1.14

Figure B8.2-7. ITS 125 V DC System Train B

The ITS loads within the CRCF are powered via two ITS 480/277 V load centers and ITS 480/277 V motor control centers (MCC) located within separate areas in the CRCF. The ITS 480/277 V load center Train A (Figure B8.2-8) and ITS 480/277 V MCC Train A (Figure B8.2-10) support Train A of the CRCF ITS HVAC.

For the remainder of this attachment, these are referred to as ITS load center Train A and ITS MCC Train A.

The ITS 480/277 V load center Train B (Figure B8.2-9) and ITS 480/277 V MCC Train B (Figure B8.2-11) support Train B of the CRCF ITS HVAC.

For the remainder of this attachment these are referred to as ITS load center Train B and ITS MCC Train B. Each division of the AC power supply from the 13.8 kV ITS switchgears to the CRCF passes through a 13.8 kV to a 480 V transformer (Figures B8.2-8 through B8.2-11).

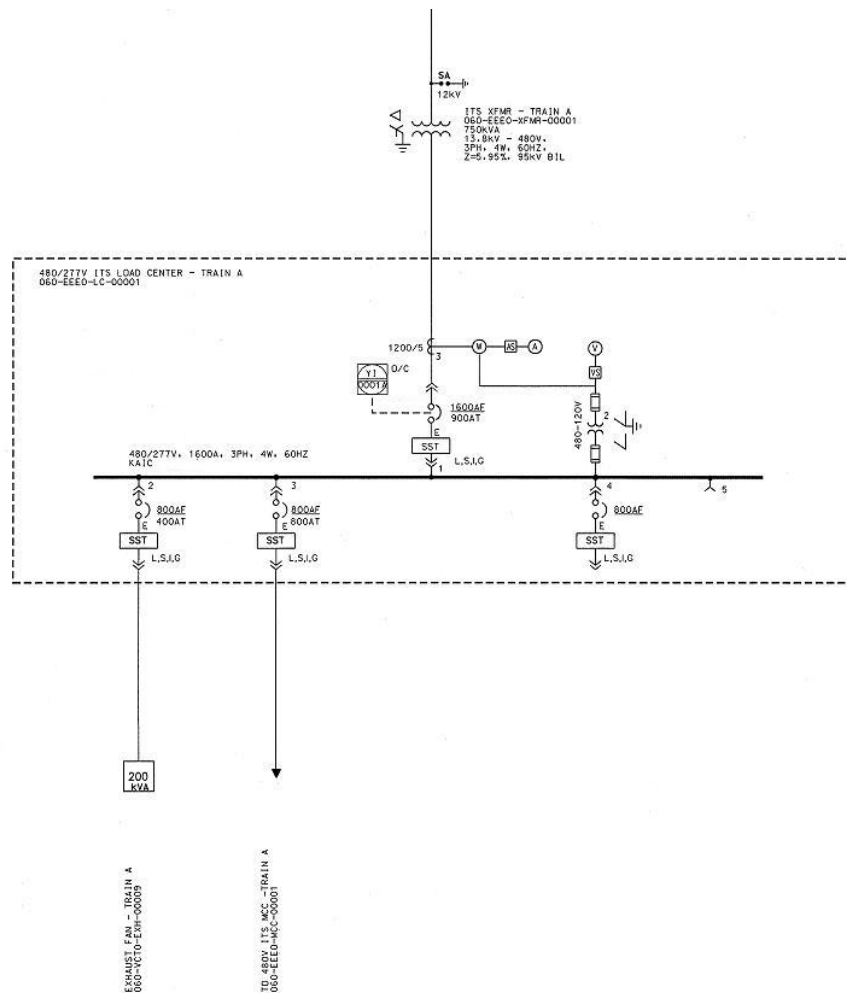

NOTE: Legibility of figure does not affect technical content of the document. See source for detail.

Source: Ref. B8.1.1

Figure B8.2-8. CRCF ITS Load Center Train A

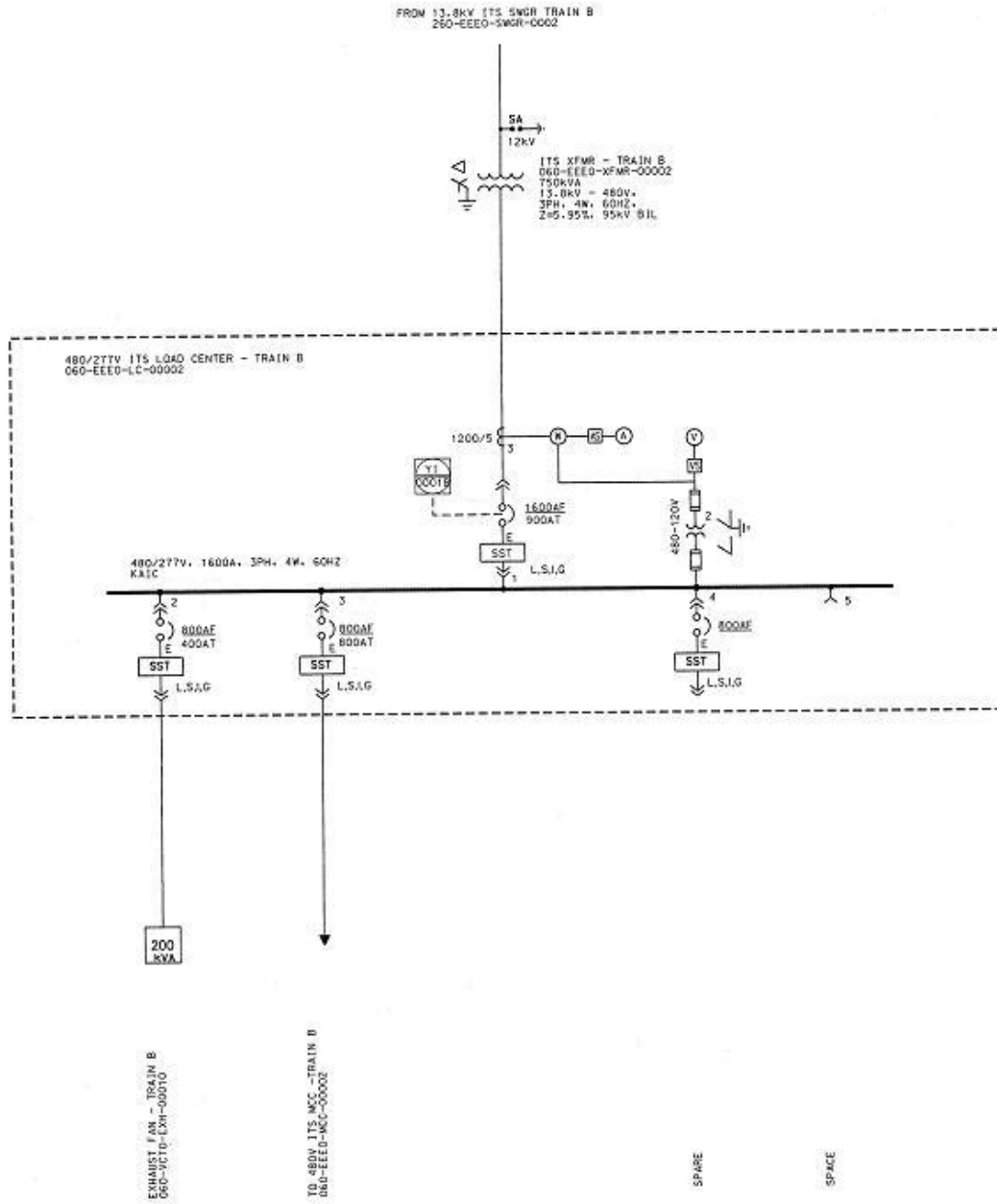

NOTE: Legibility of figure does not affect technical content of the document. See source for detail.

Source: Ref. B8.1.2

Figure B8.2-9. CRCF ITS Load Center Train B

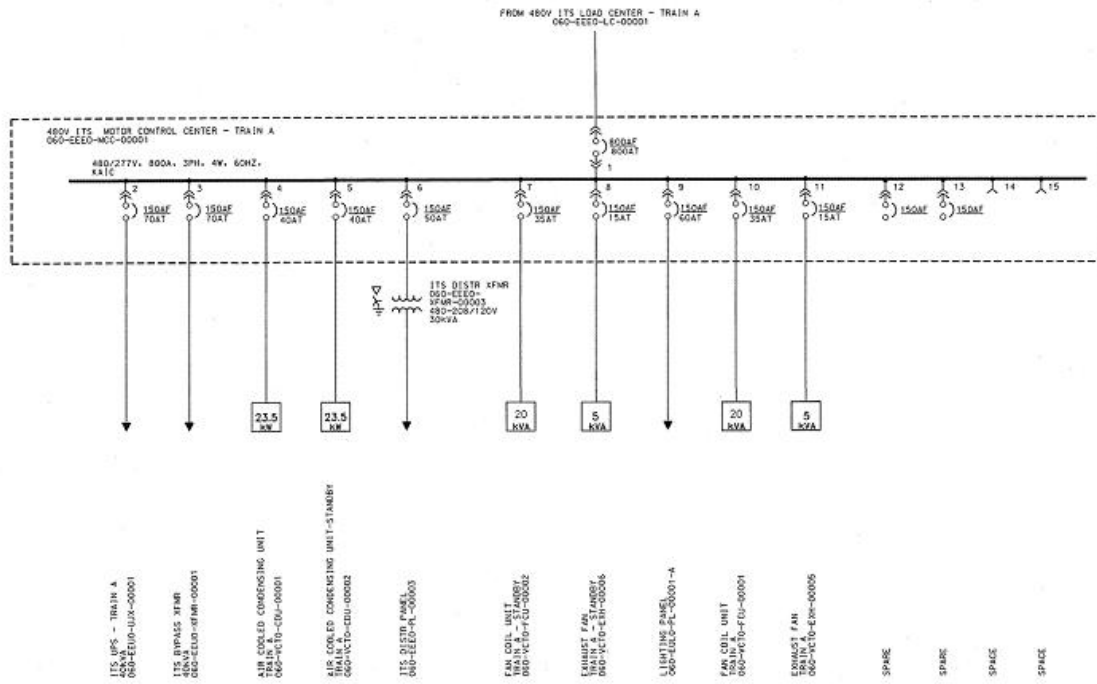

NOTE: Legibility of figure does not affect technical content of the document. See source for detail.

Source: Ref. B8.1.3

Figure B8.2-10. CRCF ITS MCC Train A

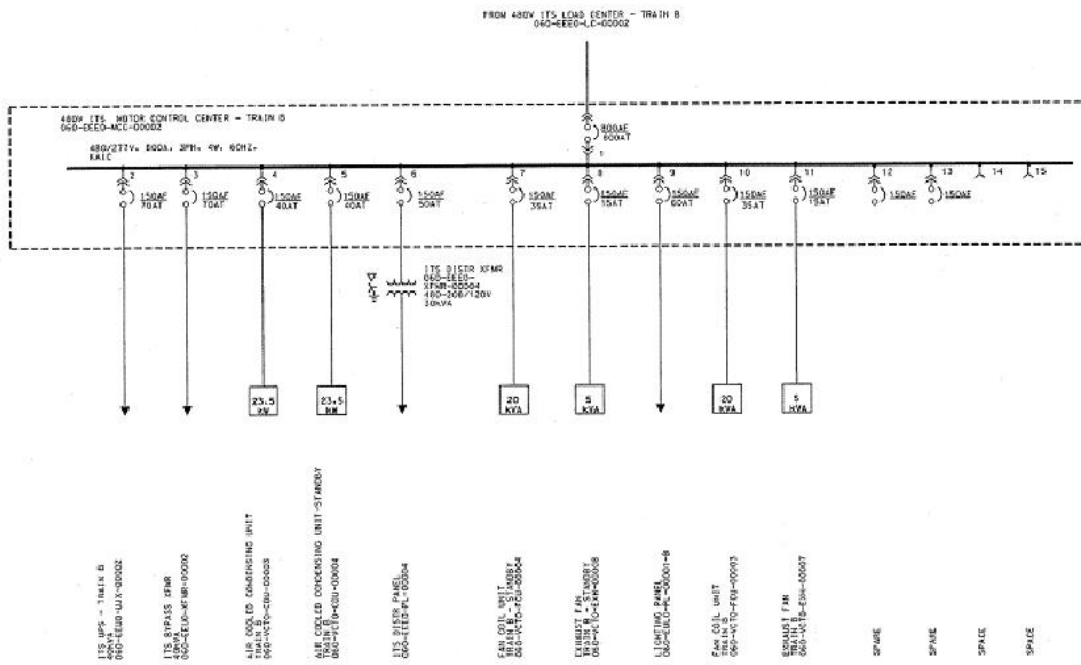

NOTE: Legibility of figure does not affect technical content of the document. See source for detail.

Source: Ref. B8.1.4

Figure B8.2-11. CRCF ITS MCC Train B

B8.2.2 ITS Onsite AC Power

The ITS power supply system is intended to provide back-up power to selected buildings and operations in the event of LOSP. A LOSP could result from a loss of power on the offsite power grid or a failure within the site 138 kV to 13.8 kV switchyard. This portion of the ITS power supply system consists of two identical divisions of diesel generator supplied AC power. The primary components in each division include: a diesel generator, support systems for the diesel generator, and a load sequencer.

Both ITS diesel generators are located in the Emergency Diesel Generator Facility (EDGF). Each is sized to provide sufficient 13.8 kV power to support all of the ITS loads in one ITS switchgear (A or B) in six facilities (three CRCFs, the WHF, the RF, and the EDGF). The ITS diesel generator starts upon detection of an under voltage condition via an under voltage relay of the 13.8 kV ITS switchgear. (The switchyard to switchgear feeder breaker also trips open upon

detection of this under voltage condition.) Each ITS diesel generator is equipped with a complete set of support systems including HVAC systems, UPS, and DC power systems, a fuel oil system, diesel generator start subsystem, diesel generator cooling subsystem and lube oil subsystem that are separate and independent from the support system for the other ITS diesel generator.

The EDGF is divided into several areas/rooms supporting the two trains of ITS AC power. Separate HVAC systems are provided for each room. The 125V DC power system (one for each ITS division) provides the necessary power to operate (open/close) the medium voltage circuit breakers on the ITS switchgears. The uninterruptible power system (UPS) supports the ITS diesel generator control systems. The UPS is not included in the ITS AC Power model. A UPS is generally very reliable and inclusion of this support system would not noticeably impact the ITS AC Power System failure probability. The HVAC for the 13.8 kV ITS Switchgear Room and Battery Room for each train of the ITS power system, includes an air handling unit and two exhaust fans for each battery room for both air flow and temperature control (Ref. B8.1.15). The system for each of the ITS diesel generator rooms consists of four exhaust fans, as maintaining air flow is sufficient to maintain room temperature within the ITS diesel generator operational limits. All four fans must operate to maintain an acceptable temperature within the ITS Diesel Generator Room (Ref B8.1.12)

The 125 V DC power system (one for each ITS diesel generator) provides essential power needed to start and load the diesel generator upon a LOSP. The DC power for each division of the ITS power supply in the EDGF is supplied by a single battery. The battery is continuously charged through a single battery charger powered (through a transformer and the 480V ITS MCC, 26D-EEE0-MCC-00001) from the 13.8 kV ITS switchgear (Figures B8.2-5 and B8.2-7).

Each ITS diesel generator fuel oil system consists primarily of a bulk storage tank, two fuel pumps, and a day tank (Figure B8.2-12). The bulk storage tank, located outside of the EDGF, has a capacity sufficient to operate the ITS diesel generator for two weeks. Each fuel pump is sized to be capable of providing sufficient makeup flow to the day tank once the level in the day tank has dropped to a one hour supply for the ITS diesel generator, and to refill the tank while the ITS diesel generator is running. The day tank, located within the EDGF, has a capacity to support four hours of ITS diesel generator operation (Ref. B8.1.11).

The lube oil subsystem, the diesel generator cooling subsystem, and the starting subsystem are considered to be part of the diesel generator and their failures are not modeled as separate events in the fault trees.

The load sequencer controls the sequence of events that occur after a LOSP and the diesel generator starts. Upon a LOSP, and after the diesel generator starts and reaches its rated capacity, the load sequencer connects the diesel generator to the 13.8 kV ITS Switchgear and then reconnects all division ITS loads, including the CRCF ITS loads.

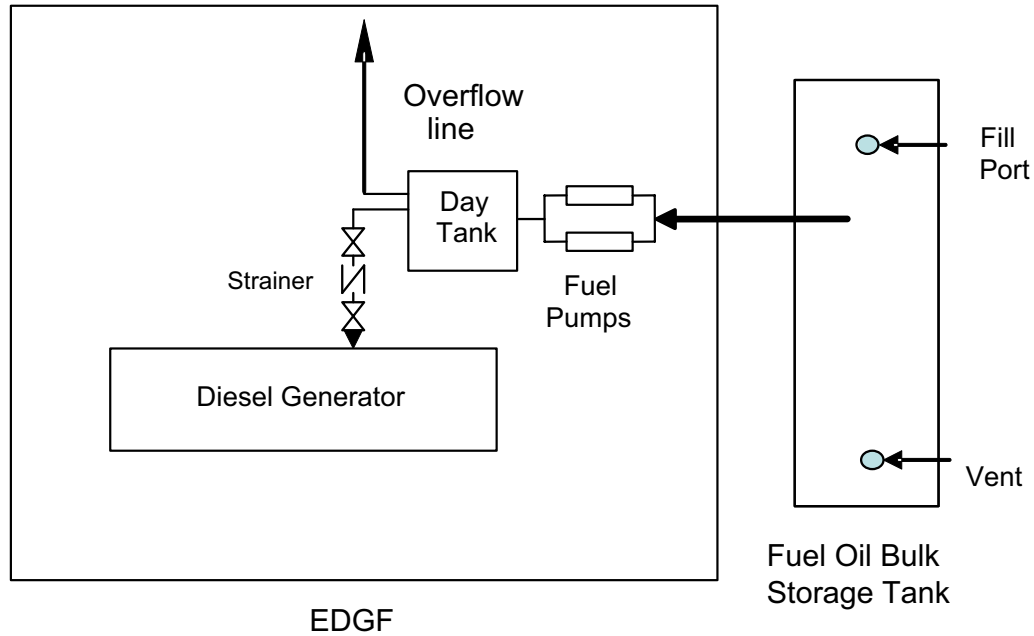

Source: Modified from Ref. B8.1.11

Figure B8.2-12. ITS Diesel Generator Fuel Oil System

Within the CRCF, ventilation and cooling for the ITS Electrical Rooms and ITS Battery Rooms is provided by a dedicated ventilation system. A separate ventilation train is provided for each train of ITS Electrical/Battery Rooms. Each train consists of two air handling units (each consisting of an air cooled condensing unit and a fan coil unit), two exhaust fans and associated ducting and instrumentation (See Figure B8.2-13). Each air handling unit and exhaust fan is rated at 100% capacity. Two air handling units, one in each train (air cooled condensing units 060-VCT0-CDU-00001 and 060-VCT0-CDU-00003 and fan coil units 060-VCT0-FCU-00001 and 060-VCT0-FCU-00003) are normally operating while the second one in each train (Air cooled condensing units 060-VCT0-CDU-00002 and 060-VCT0-CDU-00004 and Fan coil units 060-VCT0-FCU-00002 and 060-VCT0-FCU-00004) is normally in standby. Similarly, two exhaust fans, one in each train, (exhaust fan 060-VCT0-EXH-00005 and 060-VCT0-EXH-00007) are normally operating while the second one in each train (exhaust fan 060-VCT0-EXH-00006 and 060-VCT0-EXH-00008) is normally in standby (Ref B8.1.7, Ref. B8.1.5, Ref. B8.1.8, and Ref. B8.1.6).

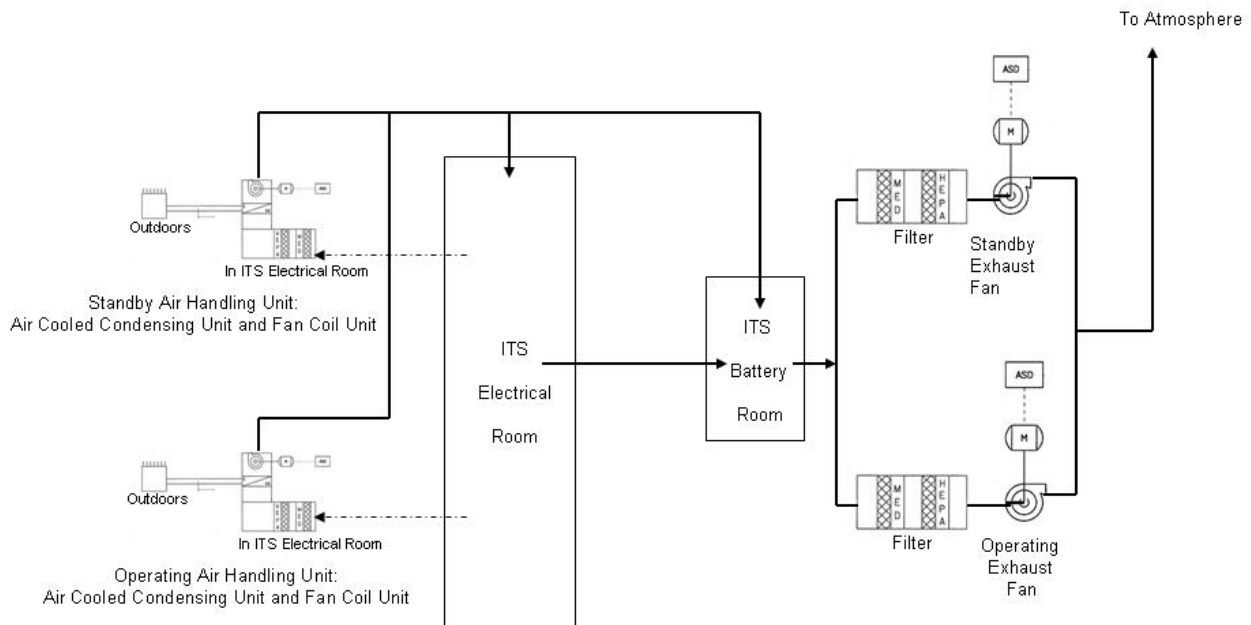

NOTE: Legibility of figure does not affect technical content of the document. See source for detail.

Source: Ref. B8.1.5 through B8.1.8

Figure B8.2-13. Simplified Diagram of Representative Train of CRCF ITS Electrical and ITS Battery Rooms Ventilation System

B8.2.3 ITS AC Power Normal Operations

Under normal operating conditions, AC power is supplied from two 138 kV offsite power lines. Power is passed through the 138 kV – 13.8 kV switchyard to the two independent 13.8 kV ITS switchgears. From there, power is transmitted to two 13.8 kV - 480 V transformers, one supporting division A and one supporting division B of the CRCF. Power to individual ITS equipment within each facility is provided via the ITS load centers and ITS MCCs (one of each for division A and division B).

The AC power system is normally operating, but one division at a time may be taken out of service for maintenance. With one division out of service, only one division of the supported ITS systems can be considered to be operable.

B8.2.4 ITS AC Power Off-Normal Operations

The off-normal condition of interest for the ITS AC power system is a LOSP. During a LOSP, both ITS diesel generators are required to start and accept loads in a timely manner. Upon a LOSP, the onsite power distribution system supporting ITS loads is disconnected from the switchyard; a circuit breaker between the 13.8 kV ITS switchgear and the switchyard in each division automatically opens. Both diesel generators start automatically and are connected to the 13.8 kV ITS switchgear when the connecting breaker is closed by the load sequencer. The load

sequencer then reconnects the CRCF loads to the 13.8 kV ITS switchgear. Both diesel generators continue to supply AC power until normal power is restored.

B8.2.5 ITS AC Power Testing and Maintenance

The normal AC power system is operated continuously. Maintenance would be performed on an as needed basis. The diesel generators and supporting subsystems are normally in a standby mode. Routine tests are performed to ensure that the ITS diesel generator can start and load, in the event of a loss of normal power, including during a LOSP event.

Requirements

The ITS diesel generators and their associated support components (start systems, lube oil, HVAC) are tested monthly on a staggered basis.

Design Feature

Normal maintenance is performed in accordance with manufacturer's recommendations.

Maintenance outages that remove a division of ITS AC power from operation is limited to one week per maintenance outage.

B8.2.5.1 Fault Trees

B8.2.5.1.1 Requirements

The fault tree model for the ITS AC power system includes: (1) those components that have been declared as ITS and (2) those AC power distribution system components whose failure would require the ITS AC power system to perform. The ITS power system includes components that are normally in standby (e.g. the diesel generator) and components that are normally in operation. The portions of the normal AC power distribution system modeled include the AC power distribution system from the 13.8 kV ITS switchgear to the facility ITS load centers.

The mission time for the ITS AC power system is set to 720 hours. This is based on the mission time requirement for the CRCF HVAC system following the potential breach of a waste canister.

B8.2.5.1.2 Design Feature

Common-cause failures (CCF) have been included for fourteen events. Six are associated with ITS diesel generator operation: two for the ITS diesel generators (failure to start or run) themselves and four for the pair of fuel pumps (failure to start and run for each pair) that support each ITS diesel generator. Three more are associated with the failure to open/close of the breakers that disconnect the 13.8 kV ITS Switchgear from the normal offsite power supply, the ITS load center feed breakers, and the breakers that connect the ITS diesel generators to the 13.8 kV ITS switchgear. Four are associated with the CRCF Confinement ITS Electrical and Battery Rooms Ventilation System: one for the failure to start and run of the system standby exhaust fans, one for the failure to run of the operating exhaust fans, one for the failure to start and run of the standby air handling units, and one for the failure to run of the operating air handling units.

The final CCF event modeled is associated with the CRCF 13.8 kV - 480 V ITS transformers. Additional detail about the treatment of CCF failures can be found in Attachment C.

Four human error conditions are incorporated into the model, details are provided in Section B8.4 of this attachment. All four address the failure to properly restore portions of the system to operable status following maintenance.

The ITS diesel generator lube oil, cooling systems, and start subsystems are considered to be part of the diesel generator and are not modeled as separate systems.

B8.3 DEPENDENCIES AND INTERACTIONS

Dependencies are broken down into five categories with respect to their interactions with structures, systems, and components. The five areas considered are addressed in Table B8.3-1 with the following dependencies:

1. Functional dependence
2. Environmental dependencies
3. Spatial dependence
4. Human dependence
5. Failures based on external events.

Table B8.3-1. Dependencies and Interactions Analysis

Structures, Systems, and Components	Dependencies and Interactions				
	Functional	Environ-mental	Spatial	Human	External Events
ITS diesel generators	Start systems, load sequencer	EDGF Diesel Generator Room HVAC	—	Test and maintenance	—
13.8 kV ITS Switchgear	ITS Diesel generator, CRCF 13.8 – 480V ITS transformers	EDGF Switchgear Room HVAC	—	Test and maintenance	Offsite power
ITS Load Centers and ITS MCCs	ITS diesel generator, 13.8 kV ITS switchgear	CRCF ITS AC Power Room Ventilation	—	Test and maintenance	Offsite power
AC load breakers	EDGF DC power system	—	—	Test and maintenance	—
CRCF 13.8 kV to 480 V ITS transformers	ITS diesel generator, 13.8 kV ITS switchgear	—	—	Test and maintenance	Offsite power
CRCF ITS AC Power Room Ventilation	CRCF ITS MCCs	—	—	Test and maintenance	—

NOTE: CRCF = Canister Receipt and Closure Facility; EDGF = Emergency Diesel Generator Facility HVAC = heating, ventilation, and air conditioning; ITS = important to safety; kV = kilovolt; MCC = motor control centers.

Source: Original

B8.4 ITS AC POWER FAILURE SCENARIOS

For the CRCF the ITS AC power system has two credible failure scenarios:

1. Loss of AC power to CRCF ITS load center Train A. Failure to provide power to the CRCF ITS HVAC system Train A.
2. Loss of AC power to CRCF ITS load center Train B. Failure to provide power to the CRCF ITS HVAC system Train B.

These two scenarios apply to operations in all three CRCFs. The facilities and operations within each of these facilities are identical, therefore, only one set of fault trees have been developed to address operations within all three facilities.

B8.4.1 Loss of AC Power to CRCF ITS Load Center Train A

B8.4.1.1 Description

CRCF confinement following the potential breach of a waste canister is provided, in part, by the CRCF ITS HVAC system. The ITS AC power system provides the power needed to operate the ITS HVAC system equipment. This fault tree models the components that are required to provide AC power from either the normal offsite power supplies or from ITS diesel generator A to ITS load center Train A.

B8.4.1.2 Success Criteria

Success criteria for this train of the ITS AC power system is providing AC power from either the normal power system, or from the ITS diesel generator (DG A) to the ITS HVAC division powered through CRCF ITS load center Train A. The AC power system must operate in support of the ITS HVAC system for as long as necessary to successfully provide confinement after the potential release of material from a breached canister. Therefore, the mission time (the period for which ITS AC power must be supplied to the ITS HVAC system) is the same for the ITS AC power system as it is for the ITS HVAC system, 720 hours.

B8.4.1.3 Design Requirements and Features

Requirements

Each ITS diesel generator has support systems that are independent from the support system for the other diesel generator. Independent support systems include:

- Fuel oil systems
- HVAC systems to include the ITS Diesel Generator Room and 13.8 kV ITS Switchgear Room systems

- Lube oil system
- ITS diesel generator cooling systems
- Diesel generator start system.

Design Features

The 13.8 kV ITS switchgear is isolated from the main switchyard upon a loss of power in the switchyard, either due to a LOSP or from failures within the switchyard.

The CRCF load is shed from the 13.8 kV ITS switchgear upon a loss of power indication.

A load sequencer controls the loading of the diesel generator onto the 13.8 kV ITS switchgear upon the ITS diesel generator reaching rated output. The same load sequencer controls reloading the CRCF loads onto the ITS AC power system.

Environmental systems are provided to maintain the temperature in the various EDGF rooms within acceptable levels. This includes a fan system for the diesel generator room and an air handling unit for the 13.8 kV ITS switchgear and battery room.

B8.4.1.4 Fault Tree Model

The top event in this fault tree is “Loss of AC Power to CRCF ITS Load Center Train A.” This is defined as a failure of normal and ITS on-site power to provide power to ITS load center Train A. Faults considered in the evaluation of this top event include: failure of components in the normal AC power system, failure of the ITS diesel generator, human events that can contribute to onsite system failures resulting in a power loss at the CRCF and a LOSP. In this fault tree offsite power is not modeled as an initiating event, but as a system failure. The value used for this event represents the probability that offsite power would be lost in the 720 hours following a possible radioactive release from a damaged canister.

B8.4.1.5 Basic Event Data

Table B8.4-1 contains a list of basic events used in the “Loss of AC Power to CRCF ITS Load Center Train A” fault tree. Included are component failures, maintenance errors and the human and CCF events identified in the previous two sections. The data, for both random and CCF failures used to develop the failure probabilities associated with these basic events comes from the component reliability data analysis (Attachment C). Human reliability analyses (Attachment E) provide the probabilities for the human events.

Mission times for the various components are based on the following:

- Fault exposure time (168 hours) for events limited to one week maintenance outages (train OOS for maintenance).
- Mission time (360 hours) for operation of standby equipment that would operate after a LOSP is the average fault exposure time for standby components tested monthly. This means that the distribution of the occurrence of an LOSP is evenly distributed over the 720 hours, after a potential radiological release.
- Mission time (720) hours for operating components.

While some of the components are normally in operation, it is possible for any of the components to be out of service (OOS) for maintenance. With Train A of AC power OOS (resulting in Train A of the facility ITS HVAC being OOS), Train B provides support to an operable ITS HVAC Train B. The intent of the maintenance events modeled is for the events to address maintenance on any component in that AC power division. This is true for the components normally in operation and the standby components. The maintenance unavailability represented by the ITS load center maintenance events model the unavailability of any component from the 13.8 kV ITS switchgear through the ITS load center. The maintenance unavailability represented by the ITS diesel generator maintenance events represent the unavailability of any of the components or systems that would prevent the ITS diesel generator from starting and loading onto the 13.8 kV ITS switchgear. As noted earlier all of the human events are associated with the failure to restore a component to operable or standby status after maintenance. The operator-related events shown in the following table are combinations events: they include the probability that the component has been taken OOS for maintenance and that site personnel have not restored the component to operable or standby status. A screening value of 0.1 has been used for the HEP in all cases.

Table B8.4-1. Basic Event Probability for the Loss of AC Power to CRCF ITS Load Center Train A Fault Tree

Name	Description ^b	Calc. Type ^a	Calc. Prob.	Fail. Prob.	Lambda	Miss. Time ^a
060-#EEE-CRCF1-A-XMR-CCF	CRCF ITS Transformers CCF	1	4.920E-06	4.920E-06	0.000E+00	0.000E+00
060-#EEE-CRCF1-A-XMR-FOH	CRCF ITS Train A Transformer Failure	3	2.095E-04	0.000E+00	2.910E-07	7.200E+02
060-#EEE-LDCNTRA-BUA-FOH	CRCF ITS Load Center A Fails	3	4.391E-04	0.000E+00	6.100E-07	7.200E+02
060-#EEE-LDCNTRA-BUA-MTN	ITS Load Center Train A OOS for Maintenance	3	1.025E-04	0.000E+00	6.100E-07	1.680E+02
060-#EEE-LDCNTRA-BUA-ROE	Failure to Restore ITS Load Center Train A post maintenance	1	1.025E-05	1.025E-05	0.000E+00	0.000E+00
060-#EEE-LDCNTRA-C52-FOD	ITS Load Center A feed breaker (AC) Fails to reclose	1	2.240E-03	2.240E-03	0.000E+00	0.000E+00
060-#EEE-LDCNTRA-C52-SPO	ITS Load Center A Feed Circuit Breaker (AC) Spurious Operation	3	3.816E-03	0.000E+00	5.310E-06	7.200E+02
060-#EEE-LDCNTRB-BUA-MTN	ITS Load Center Train B OOS for Maintenance	3	1.025E-04	0.000E+00	6.100E-07	1.680E+02
060-#EEE-LDCNTRB-BUA-ROE	ITS Failure to Restore Load Center Train B post maintenance	1	1.025E-05	1.025E-05	0.000E+00	0.000E+00
060-#EEE-LDCNTRS-C52-CCF	Common-cause failure of the ITS Load Center feed breakers to reclose	1	1.050E-04	1.050E-04	0.000E+00	0.000E+00
060-#EEE-MCC0001-C52-SPO	CRCF ITS MCC 0001 Feed Breaker Spurious Operation	3	3.816E-03	0.000E+00	5.310E-06	7.200E+02
060-#EEE-MCC0001-MCC-FOH	CRCF ITS MCC 00001 Fails	3	5.378E-03	0.000E+00	7.490E-06	7.200E+02
060-VCT0-AHU0001-AHU-FTR	CRCF ITS Elec AHU 00001 Fails to run	3	2.646E-03	0.000E+00	3.680E-06	7.200E+02
060-VCT0-AHU0001-CTL-FOD	CRCF ITS Elec AHU 00001 Controller Fails	1	2.030E-03	2.030E-03	0.000E+00	0.000E+00
060-VCT0-AHU0002-AHU-FTR	CRCF ITS ELec AHU 00002 Fails to Run	3	2.646E-03	0.000E+00	3.680E-06	7.200E+02
060-VCT0-AHU0002-CTL-FOD	CRCF ITS Elec AHU 00002 Controller Fails	1	2.030E-03	2.030E-03	0.000E+00	0.000E+00
060-VCT0-AHU0002-FAN-FTS	CRCF ITS Elec AHU 00002 Fails to Start	1	2.020E-03	2.020E-03	0.000E+00	0.000E+00
060-VCT0-AHU0103-AHU-CCR	CCF of the running CRCF ITS Elec AHUs to continue to run	1	6.200E-05	6.200E-05	0.000E+00	0.000E+00
060-VCT0-AHU0202-AHU-CCR	CCF of standby CRCF ITS Elec AHUs to start/run	1	1.600E-04	1.600E-04	0.000E+00	0.000E+00
060-VCT0-EXH-005-CTL-FOD	CRCF ITS Elec Exh fan 00005 Controller Fails	1	2.030E-03	2.030E-03	0.000E+00	0.000E+00
060-VCT0-EXH-005-FAN-FTR	CRCF ITS Elec Exhaust Fan 00005 Fails to Run	3	5.059E-02	0.000E+00	7.210E-05	7.200E+02

B8-23

March 2008

Table B8.4-1. Basic Event Probability for the Loss of AC Power to CRCF ITS Load Center Train A Fault Tree (Continued)

Name	Description ^b	Calc. Type ^a	Calc. Prob.	Fail. Prob.	Lambda	Miss. Time ^a
060-VCT0-EXH-006-FAN-FTR	CRCF ITS Elec Exh. Fan Fails to Run	3	5.059E-02	0.000E+00	7.210E-05	7.200E+02
060-VCT0-EXH-006-FAN-FTS	CRCF ITS Elec Exh fan 00006 Fails to Start	1	2.020E-03	2.020E-03	0.000E+00	0.000E+00
060-VCT0-EXH006-CTL-FOD	CRCF ITS Elec Exh Fan 0006 Controller Fails	1	2.030E-03	2.030E-03	0.000E+00	0.000E+00
060-VCT0-EXH0507-FAN-CCR	CCF of running Exh fans for CRCF ITS Elec.	1	1.200E-03	1.200E-03	0.000E+00	0.000E+00
060-VCT0-EXH0608-FAN-CCF	CCF to start/run: standby Exh fans for the CRCF ITS Elec	1	1.300E-03	1.300E-03	0.000E+00	0.000E+00
26D-##EG-DAYTNKA-TKF-FOH	ITS DG A Day Tank (00002A) Fails	3	1.584E-04	0.000E+00	4.400E-07	3.600E+02
26D-##EG-FLITLKA-IEL-FOD	ITS DG A fuel transfer pumps Interlock Failure	1	2.750E-05	2.750E-05	0.000E+00	0.000E+00
26D-##EG-FTP1DGA-PMD-FTR	ITS DG A Fuel Transfer Pump Fails to Run	3	1.234E-02	0.000E+00	3.450E-05	3.600E+02
26D-##EG-FTP1DGA-PMD-FTS	ITS DG A Fuel Pump 1A Fails to Start	1	2.500E-03	2.500E-03	0.000E+00	0.000E+00
26D-##EG-FTP2DGA-PMD-FTR	ITS DG A Fuel Transfer Pump 2A Fails to Run	3	1.234E-02	0.000E+00	3.450E-05	3.600E+02
26D-##EG-FTP2DGA-PMD-FTS	ITS DG A Fuel Transfer pump 2A Fails to Start	1	2.500E-03	2.500E-03	0.000E+00	0.000E+00
26D-##EG-FULPMPA-PMD-CCR	Common-cause failure of ITS DG A fuel pumps to run	1	2.900E-04	2.900E-04	0.000E+00	0.000E+00
26D-##EG-FULPMPA-PMD-CCS	Common-cause failure of ITS DG A fuel pumps to start	1	1.200E-04	1.200E-04	0.000E+00	0.000E+00
26D-##EG-STRTDGA-C72-SPO	ITS Switchgear A Battery Circuit Breaker (DC) Spur Op	3	3.851E-04	0.000E+00	1.070E-06	3.600E+02 ^d
26D-##EG-WKTNK_A-TKF-FOH	ITS DG A Bulk Fuel Tank (00001A) Fails	3	1.584E-04	0.000E+00	4.400E-07	3.600E+02
26D-##EGBATCHRGA-BYC-FOH	ITS Switchgear A Battery: Battery Charger failure	3	1.276E-03	0.000E+00	7.600E-06	1.680E+02 ^c
26D-##EEE-SWGRDGA-BUA-FOH	13.8 kV ITS Switchgear A Failure	3	4.391E-04	0.000E+00	6.100E-07	7.200E+02
26D-##EEESWGRDGA-AHU-FTR	13.8 kV ITS Switchgear room Air Handling Unit Fails	3	2.646E-03	0.000E+00	3.680E-06	7.200E+02
26D-##EEG-HVACFA1-FAN-FTR	ITS DG A room Fan 1 (Motor-Driven) Fails to Run	3	2.562E-02	0.000E+00	7.210E-05	3.600E+02
26D-##EEG-HVACFA1-FAN-FTS	ITS DG A room Fan 1 (Motor-Driven) Fails to Start	1	2.020E-03	2.020E-03	0.000E+00	0.000E+00
26D-##EEG-HVACFA2-FAN-FTR	ITS DG A room Fan 2 (Motor-Driven) Fails to Run	3	2.562E-02	0.000E+00	7.210E-05	3.600E+02
26D-##EEG-HVACFA2-FAN-FTS	ITS DG A room Fan 2 (Motor-Driven) Fails to Start	1	2.020E-03	2.020E-03	0.000E+00	0.000E+00
26D-##EEG-HVACFA3-FAN-FTR	ITS DG A room Fan 3 (Motor-Driven) Fails to Run	3	2.562E-02	0.000E+00	7.210E-05	3.600E+02
26D-##EEG-HVACFA3-FAN-FTS	ITS DG A room Fan 3 (Motor-Driven) Fails to Start	1	2.020E-03	2.020E-03	0.000E+00	0.000E+00

B8-24

March 2008

Table B8.4-1. Basic Event Probability for the Loss of AC Power to CRCF ITS Load Center Train A Fault Tree (Continued)

Name	Description ^b	Calc. Type ^a	Calc. Prob.	Fail. Prob.	Lambda	Miss. Time ^a
26D-#EEG-HVACFA4-FAN-FTR	ITS DG A room Fan 4 (Motor-Driven) Fails to Run	3	2.562E-02	0.000E+00	7.210E-05	3.600E+02
26D-#EEG-HVACFA4-FAN-FTS	ITS DG A room Fan 4 (Motor-Driven) Fails to Start	1	2.020E-03	2.020E-03	0.000E+00	0.000E+00
26D-#EEU-208_DGA-BUD-FOH	ITS DC Panel A DC Bus Failure	3	8.640E-05	0.000E+00	2.400E-07	3.600E+02 ^d
26D-#EEY-DGALOAD-C52-FOD	DG A Load Breaker (AC) Fails to Close	1	2.240E-03	2.240E-03	0.000E+00	0.000E+00
26D-#EEY-DGLOADS-C52-CCF	Common-cause failure of ITS DG Load Breakers to close	1	1.050E-04	1.050E-04	0.000E+00	0.000E+00
26D-#EEY-ITSDG-A-#DG-FTR	ITS Diesel Generator A Fails to Run	3	7.698E-01	0.000E+00	4.080E-03	3.600E+02
26D-#EEY-ITSDG-A-#DG-FTS	Diesel Generator Fails to Start	1	8.380E-03	8.380E-03	0.000E+00	0.000E+00
26D-#EEY-ITSDG-A-#DG-MTN	ITS DG A OOS Maintenance	1	1.950E-03	1.950E-03	0.000E+00	0.000E+00
26D-#EEY-ITSDG-A-#DG-RSS	Failure to properly return ITS DG A to service	1	1.950E-04	1.950E-04	0.000E+00	0.000E+00
26D-#EEY-ITSDG-B-#DG-MTN	ITS DG B OOS Maintenance	1	1.950E-03	1.950E-03	0.000E+00	0.000E+00
26D-#EEY-ITSDG-B-#DG-RSS	Failure to properly restore ITS DG-B to service	1	1.950E-04	1.950E-04	0.000E+00	0.000E+00
26D-#EEY-ITSDGAB-#DG-CCR	CCF ITS DG A & B Fail to Run	1	1.800E-02	1.800E-02	0.000E+00	0.000E+00
26D-#EEY-ITSDGAB-#DG-CCS	CCF DG A and B to Start	1	3.900E-04	3.900E-04	0.000E+00	0.000E+00
26D-#EEY-OB-SWGA-C52-FOD	13.8 kV ITS SWGR feed breaker (AC) Fails to open	1	2.240E-03	2.240E-03	0.000E+00	0.000E+00
26D-#EEY-OB-SWGA-C52-SPO	13.8 kV ITS SWGR A feed Breaker Spurious Operation	3	3.816E-03	0.000E+00	5.310E-06	7.200E+02
26D-#EEY-OB-SWGS-C52-CCF	Common-cause failure of 13.8 kV ITS SWGR feed breakers to open	1	1.040E-04	1.040E-04	0.000E+00	0.000E+00
26D-#EG-LCKOUTRL-RLY-FTP	13.8 ITS Switchgear Feed breaker lock out relay fails to Open CB	3	3.152E-03	0.000E+00	8.770E-06	3.600E+02
26D-#EGLDSQNCRA-SEQ-FOD	ITS DG A Load Sequencer Fails	1	2.670E-03	2.670E-03	0.000E+00	0.000E+00
26D-EG-BATTERYA-BTR-FOD	ITS Switchgear A Battery No Output Given Challenge	1	8.200E-03	8.200E-03	0.000E+00	0.000E+00

B8-25

March 2008

Table B8.4-1. Basic Event Probability for the Loss of AC Power to CRCF ITS Load Center Train A Fault Tree (Continued)

Name	Description ^b	Calc. Type ^a	Calc. Prob.	Fail. Prob.	Lambda	Miss. Time ^a
27A-#EEE-BUS2DGA-C52-SPO	13.8 kV Open Bus 2 ITS Load Breaker Spurious Operation	3	3.816E-03	0.000E+00	5.310E-06	7.200E+02
27A-#EEN-OPENBS2-BUA-FOH	13.8 kV Open Bus 2 Bus Failure	3	4.391E-04	0.000E+00	6.100E-07	7.200E+02
27A-#EEN-OPNBS1A-SWP-SPO	13.8 kV Open Bus 2 to ITS Div A Electric Power Switch Spur. Xfer	3	1.116E-04	0.000E+00	1.550E-07	7.200E+02
LOSP*	Loss of Offsite Power	1	2.99E-03	2.99E-03	0.000E+00	0.000E+00

NOTE: ^a For Calc. Type 3 with a mission time of 0, SAPHIRE performs the quantification using the system mission time.

The designation of a circuit breaker as AC or DC refers to the system designation for the circuit breaker, it is not representative of the motive power for the circuit breaker.

^b The failure of the battery charger would result in eventual depletion of the battery and a low power indication on both the battery and the DC bus. The 168 hr mission time was selected as a conservative estimation for the detection time of this failure.

^c The mission times for the DC bus related failure rates do not take credit for any monitoring of bus status, which would provide nearly instantaneous indication of a bus failure or loss of power to the bus. The standby component mission time was used conservatively.

^d LOSP* represents the probability of losing offsite power during the 720 hours HVAC is required after any breach of a container releases radioactive material. It is based on a loss of offsite power frequency of 3.59E-02/year from NUREG/CR6890 Vol. 1 (Ref B8.1.19). AC = alternating current; AHU = air handling unit; Calc. = calculation; CCF = common-cause failure; DC = direct current; DG = diesel generator; Div = division; elec = electrical EXH = exhaust; ITS = important to safety; kV = kilovolt; Miss. = mission; OOS = out of service; op = operation; Prob. = probability; Spur. = spurious; SWGR = switch gear; Xfer = transfer.

Source: Original

B8.4.1.5.1 Human Failure Events

Four basic HFEs (Table B8.4-2) are associated with human error. All of the HFEs are associated with the failure to properly restore components to operable status following maintenance. The first two shown in Table B8.4-2 are associated with the failure to restore the normal power supply to the CRCF ITS load centers after maintenance. The last two are representative of the failure to restore the ITS diesel generators (and any other components that would prevent the ITS diesel generator from starting or loading) to service after maintenance. These events are combination events consisting of the probability that a component was removed for maintenance and the failure of plant operators (assigned a screening value of 0.1) to restore the component after maintenance.

Table B8.4-2. Human Failure Events

Name	Description
060-#EEE-LDCNTRA-BUA-ROE	Failure to Restore ITS Load Center Train A post maintenance
060-#EEE-LDCNTRB-BUA-ROE	Failure to Restore ITS Load Center Train B post maintenance
26D-#EEY-ITSDG-A-#DG-RSS	Failure to properly return ITS DG A to service
26D-#EEY-ITSDG-B-#DG-RSS	Failure to properly return ITS DG-B to service

NOTE: DG = diesel generator; ITS = important to safety.

Source: Original

B8.4.1.5.2 Common-Cause Failures

Twelve of the fourteen CCFs identified earlier (Section B8.2.5.1.2) have been included in the analysis of the loss of ITS AC power to the ITS load center Train A. Ten of the CCF events affect both trains of ITS AC Power. Two affect only this train of the system. The remaining two affect only the other train of the system. Two are associated with the ITS diesel generators: CCF failure of the ITS diesel generators to start and CCF failure of the ITS diesel generators to run. The CCF failure of the ITS diesel generator fuel oil system incorporates two CCF failures: CCF failure of the two fuel oil pumps to start and the CCF failure of the pumps to run. Three circuit breaker CCF events were considered. These are the CCF failure of the (1) 13.8 kV ITS switchgear feed breakers (from 13.8 kV open buses) to open on loss of offsite power, (2) ITS diesel generator load breakers to close when commanded by the load sequencer and (3) ITS load center feed breakers to close when commanded by the load sequencer. Four CCFs are associated with the CRCF ITS Electrical and Battery Rooms Ventilation System, two for the common cause failure of exhaust fans to start and run, and two for the common-cause failure of the air handling units to start and run. The last CCF event considered is the CCF failure of the 13.8 kV – 480 V ITS transformers.

Table B8.4-3. Common-Cause Basic Events

Name	Description	Alpha-factor
060-#EEE-CRCF1-A-XMR-CCF	CRCF ITS Transformers CCF	0.0235
060-#EEE-LDCNTRS-C52-CCF	CCF of the ITS Load Center feed breakers to reclose	0.047
26D-##EG-FULPMPA-PMD-CCR	CCF of ITS DG A fuel pumps to run	0.0235
26D-##EG-FULPMPA-PMD-CCS	CCF of ITS DG A fuel pumps to start	0.047
26D-#EEY-DGLOADS-C52-CCF	CCF of ITS DG Load Breakers to close	0.047
26D-#EEY-ITSDGAB-#DG-CCR	CCF ITS DG A & B Fail to Run	0.0235
26D-#EEY-ITSDGAB-#DG-CCS	CCF DG A and B to Start	0.047
26D-#EEY-OB-SWGS-C52-CCF	Common-cause failure of 13.8 kV ITS SWGR feed breakers to open	0.047
060-VCT0-AHU0103-AHU-CCR	CCF of the running CRCF ITS Elec AHUs to continue to run	0.0235
060-VCT0-AHU0202-AHU-CCR	CCF of standby CRCF ITS Elec AHUs to start/run	0.047 start 0.0235 run
060-VCT0-EXH0507-FAN-CCR	CCF of running Exh fans for CRCF ITS Elec.	0.0235
060-VCT0-EXH0608-FAN-CCF	CCF to start/run: standby Exh fans for the CRCF ITS Elec	0.047 start 0.0235 run

NOTE: AHU = air handling unit; CCF = common-cause failure, CRCF = Canister Receipt and Closure Facility; DG = diesel generator; elec = electrical; Exh = exhaust; ITS = important to safety; SWGR = switchgear.

Source: Original

All of the common cause failures modeled are used on pairs of components with one of two success criteria (i.e., two of two failure criteria). Alpha-factors used to determine the common cause failure probability are 0.047 for demand failures and 0.0235 for time dependent failures (Table C3-1, CCCG=2, and the associated text). Two common cause failures in Table B8.4-3 are used to represent the common cause failure associated with the failure to start and failure to run for components. For these two common cause failures, the appropriate alpha-factors were applied to the start and run portions of the random failure probability to develop a single common cause failure probability for the components.

B8.4.1.6 Uncertainty and Cut Set Generation

Figure B8.4-1 contains the uncertainty results obtained from running the fault trees for the “Loss of AC Power to CRCF ITS Load Center Train A”. Figure B8.4-2 provides the cut set generation results for the “Loss of AC Power to CRCF ITS Load Center Train A” fault tree.

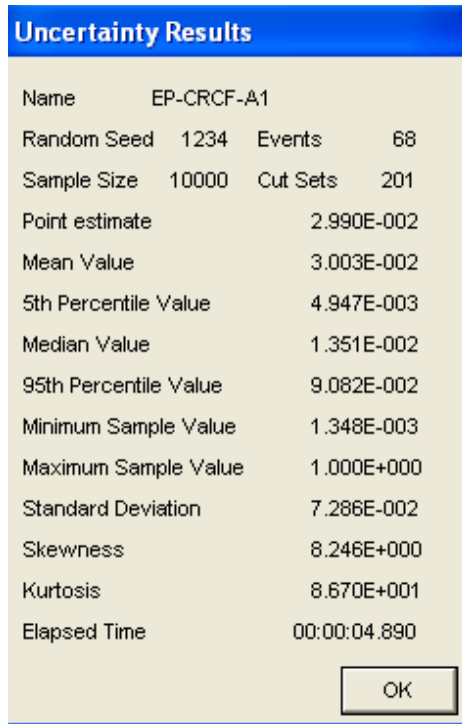

Source: Original

Figure B8.4-1. Uncertainty Results of the Loss of AC Power to CRCF ITS Load Center Train A Fault Tree

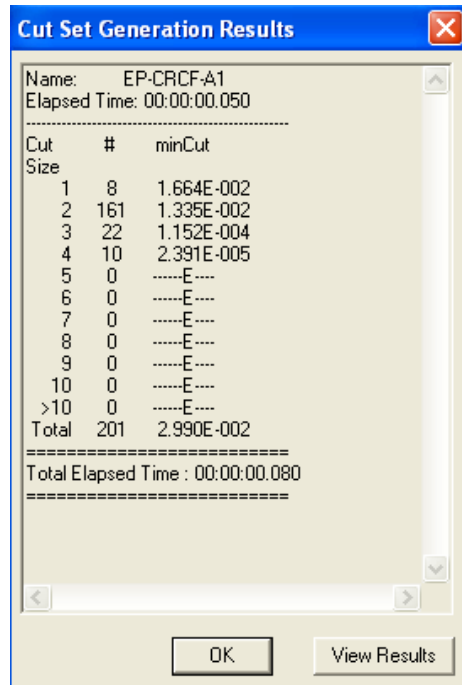

Source: Original

Figure B8.4-2. Cut Set Generation Results for Loss of AC Power to CRCF ITS Load Center Train A

B8.4.1.7 Cut Sets

Table B8.4-4 contains the top 25 cut sets accounting for 97% of the system failure probability for the “Loss of AC Power to CRCF ITS Load Center Train A” fault tree.

Table B8.4-4. Dominant Cut Sets for the Loss of AC Power to CRCF ITS Load Center Train A

% Total	% Cut Set	Prob./ Frequency	Basic Event	Description	Event Prob.
17.99	17.99	5.378E-03	060-#EEE-MCC0001-MCC-FOH	CRCF ITS MCC 00001 Fails	5.378E-03
30.75	12.76	3.816E-03	060-#EEE-LDCNTRA-C52-SPO	ITS Load Center A Feed Circuit Breaker (AC) Spurious Operation	3.816E-03
43.51	12.76	3.816E-03	060-#EEE-MCC0001-C52-SPO	CRCF ITS MCC 0001 Feed Breaker Spurious Operation	3.816E-03
53.33	9.82	2.937E-03	26D-#EEY-ITSDG-A-#DG-FTR	ITS Diesel Generator A Fails to Run	7.698E-01
			27A-#EEE-BUS2DGA-C52-SPO	13.8 kV Open Bus 2 ITS Load Breaker Spurious Operation	3.816E-03
63.15	9.82	2.937E-03	26D-#EEY-ITSDG-A-#DG-FTR	ITS Diesel Generator A Fails to Run	7.698E-01
			26D-#EEY-OB-SWGA-C52-SPO	13.8 kV ITS SWGR A feed Breaker Spurious Operation	3.816E-03
72.00	8.85	2.646E-03	26D-#EEESWGRDGA-AHU-FTR	13.8 kV ITS Switchgear room Air Handling Unit Fails	2.646E-03
80.56	8.56	2.559E-03	060-VCT0-EXH-005-FAN-FTR	CRCF ITS Elec Exhaust Fan 00005 Fails to Run	5.059E-02
			060-VCT0-EXH-006-FAN-FTR	CRCF ITS Elec Exh. Fan Fails to Run	5.059E-02
88.26	7.70	2.302E-03	26D-#EEY-ITSDG-A-#DG-FTR	ITS Diesel Generator A Fails to Run	7.698E-01
			LOSP	Loss of offsite power	2.990E-03
89.73	1.47	4.391E-04	26D-#EEE-SWGRDGA-BUA-FOH	13.8 kV ITS Switchgear A Failure	4.391E-04
91.20	1.47	4.391E-04	060-#EEE-LDCNTRA-BUA-FOH	CRCF ITS Load Center A Fails	4.391E-04
92.33	1.13	3.380E-04	26D-#EEY-ITSDG-A-#DG-FTR	ITS Diesel Generator A Fails to Run	7.698E-01
			27A-#EEN-OPENBS2-BUA-FOH	13.8 kV Open Bus 2 Bus Failure	4.391E-04
93.03	0.70	2.095E-04	060-#EEE-CRCF1-A-XMR-FOH	CRCF ITS Train A Transformer Failure	2.095E-04
93.37	0.34	1.027E-04	060-VCT0-EXH-005-CTL-FOD	CRCF ITS Elec Exh fan 00005 Controller Fails	2.030E-03
			060-VCT0-EXH-006-FAN-FTR	CRCF ITS Elec Exh. Fan Fails to Run	5.059E-02
93.71	0.34	1.027E-04	060-VCT0-EXH-005-FAN-FTR	CRCF ITS Elec Exhaust Fan 00005 Fails to Run	5.059E-02

Table B8.4-4. Dominant Cut Sets for the Loss of AC Power to CRCF ITS Load Center Train A
(Continued)

% Total	% Cut Set	Prob./ Frequency	Basic Event	Description	Event Prob.
			060-VCT0-EXH006-CTL-FOD	CRCF ITS Elec Exh Fan 0006 Controller Fails	2.030E-03
94.05	0.34	1.025E-04	060-#EEE-LDCNTRA-BUA-MTN	ITS Load Center Train A OOS for Maintenance	1.025E-04
			060-#EEE-LDCNTRB-BUA-MTN	ITS Load Center Train B OOS for Maintenance	9.999E-01
			060-#EEE-LDCNTRB-BUA-ROE	ITS Failure to Restore Load Center Train B post maintenance	1.000E+000
94.39	0.34	1.022E-04	060-VCT0-EXH-005-FAN-FTR	CRCF ITS Elec Exhaust Fan 00005 Fails to Run	5.059E-02
			060-VCT0-EXH-006-FAN-FTS	CRCF ITS Elec Exh fan 00006 Fails to Start	2.020E-03
94.72	0.33	9.777E-05	26D-#EEG-HVACFA1-FAN-FTR	ITS DG A room Fan 1 (Motor-Driven) Fails to Run	2.562E-02
			27A-#EEE-BUS2DGA-C52-SPO	13.8 kV Open Bus 2 ITS Load Breaker Spurious Operation	3.816E-03
95.05	0.33	9.777E-05	26D-#EEG-HVACFA2-FAN-FTR	ITS DG A room Fan 2 (Motor-Driven) Fails to Run	2.562E-02
			27A-#EEE-BUS2DGA-C52-SPO	13.8 kV Open Bus 2 ITS Load Breaker Spurious Operation	3.816E-03
95.38	0.33	9.777E-05	26D-#EEG-HVACFA3-FAN-FTR	ITS DG A room Fan 3 (Motor-Driven) Fails to Run	2.562E-02
			27A-#EEE-BUS2DGA-C52-SPO	13.8 kV Open Bus 2 ITS Load Breaker Spurious Operation	3.816E-03
95.71	0.33	9.777E-05	26D-#EEG-HVACFA4-FAN-FTR	ITS DG A room Fan 4 (Motor-Driven) Fails to Run	2.562E-02
			27A-#EEE-BUS2DGA-C52-SPO	13.8 kV Open Bus 2 ITS Load Breaker Spurious Operation	3.816E-03
96.04	0.33	9.777E-05	26D-#EEG-HVACFA1-FAN-FTR	ITS DG A room Fan 1 (Motor-Driven) Fails to Run	2.562E-02
			26D-#EEY-OB-SWGA-C52-SPO	13.8 kV ITS SWGR A feed Breaker Spurious Operation	3.816E-03
96.37	0.33	9.777E-05	26D-#EEG-HVACFA2-FAN-FTR	ITS DG A room Fan 2 (Motor-Driven) Fails to Run	2.562E-02
			26D-#EEY-OB-SWGA-C52-SPO	13.8 kV ITS SWGR A feed Breaker Spurious Operation	3.816E-03
96.70	0.33	9.777E-05	26D-#EEG-HVACFA3-FAN-FTR	ITS DG A room Fan 3 (Motor-Driven) Fails to Run	2.562E-02
			26D-#EEY-OB-SWGA-C52-SPO	13.8 kV ITS SWGR A feed Breaker Spurious Operation	3.816E-03
97.03	0.33	9.777E-05	26D-#EEG-HVACFA4-FAN-FTR	ITS DG A room Fan 4 (Motor-Driven) Fails to Run	2.562E-02

Table B8.4-4. Dominant Cut Sets for the Loss of AC Power to CRCF ITS Load Center Train A
(Continued)

% Total	% Cut Set	Prob./ Frequency	Basic Event	Description	Event Prob.
			26D-#EEY-OB-SWGA-C52-SPO	13.8 kV ITS SWGR A feed Breaker Spurious Operation	3.816E-03
97.32	0.29	8.590E-05	26D-#EEY-ITSDG-A-#DG-FTR	ITS Diesel Generator A Fails to Run	7.698E-01
			27A-#EEN-OPNBS1A-SWP-SPO	13.8 kV Open Bus 2 to ITS Div A Electric Power Switch Spur. Xfer	1.116E-04

NOTE: AC = alternating current; Calc. = calculation; CCF = common-cause failure; DC = direct current; DG = diesel generator; Div = division elec = electrical; exh = exhaust; ITS = important to safety; kV = kilovolt; Miss. = mission; OOS = out of service; op = operation; Prob. = probability; Spur. = spurious; SWGR = switch gear; Xfer = transfer

Source: Original

B8.4.2 Loss of AC Power to CRCF ITS Load Center Train B

B8.4.2.1 Description

CRCF confinement following the potential breach of a waste canister is provided, in part, by the CRCF ITS HVAC system. The ITS AC power system provides the AC power needed to operate the ITS HVAC system equipment. This fault tree models the components that are required to provide AC power from either the normal offsite power supplies or from ITS diesel generator B to ITS load center B.

B8.4.2.2 Success Criteria

Success criteria for this train of the ITS AC power system is providing AC power from either the normal power system or from the ITS diesel generator (DG Train B) to the ITS HVAC division powered through CRCF ITS load center Train B. The AC power system must operate in support of the ITS HVAC system for as long as necessary to successfully provide confinement after the potential release of material from a breached canister. Therefore, the mission time (the period for which AC power must be supplied to the ITS HVAC system) is the same for the ITS AC power system as it is for the ITS HVAC system, 720 hours.

B8.4.2.3 Design Requirements and Features

Requirements

Each ITS diesel generator has support systems that are independent from the support system for the other diesel generator. Independent support systems include:

- Fuel oil systems
- HVAC systems to include the ITS diesel generator room and 13.8 kV ITS switchgear room systems

- Lube oil system
- ITS diesel generator cooling systems
- Diesel generator start system.

Features

The 13.8 kV ITS switchgear is isolated from the main switchyard upon a loss of power in the switchyard, either due to a LOSP or from failures within the switchyard.

The CRCF load is shed from the 13.8 kV switchgear upon a loss of power indication.

A load sequencer controls the loading of the diesel generator onto the 13.8 kV ITS switchgear upon the ITS diesel generator reaching rated output. The same load sequencer controls reloading the CRCF loads onto the ITS AC power system.

Environmental systems are provided to maintain the temperature in the various EDGF rooms within acceptable levels. This includes a fan system for the diesel generator room and air handling units for the 13.8 kV ITS switchgear and battery room.

B8.4.2.4 Fault Tree Model

The top event in this fault tree is “Loss of AC Power to CRCF ITS Load Center Train B.” This is defined as a failure of the normal and ITS onsite power supplies to provide power to ITS load center B. Faults considered in the evaluation of this top event include: failure of components in the normal AC power system, failure of the ITS diesel generator subsystem, human events that can contribute to onsite system failures resulting in a power loss at the CRCF and a LOSP. In this fault tree offsite power is not modeled as an initiating event, but as a system failure. The value used for this event represents the probability that offsite power would be lost in the 720 hours following a possible radioactive release from a damaged canister.

B8.4.2.5 Basic Event Data

Table B8.4-5 contains a list of basic events used in the “Loss of AC Power to CRCF ITS Load Center Train B” fault tree. Included are component failures, maintenance errors and the human events and the CCF events identified in the previous two sections. The data, for both random and CCF failures, used to develop the failure probabilities associated with these basic events comes from the component reliability data analysis in Attachment C. The human reliability analyses in Attachment E, provides the human error probabilities (HEP).

Mission times for the various components are based on the following:

- Fault exposure time (168 hours) for events limited to one week maintenance outages (train OOS for maintenance)

- Mission time (360 hours) for operation of standby equipment that would operate after a LOSP. Distribution of the occurrence of an LOSP is evenly distributed over the 720 hours after a potential radiological release; average mission time is therefore 360 hours. Average fault exposure time for standby components tested monthly.
- Mission time (720 hours) for operating components

While some of the components are normally in operation, it is possible for any of the components to be out of service (OOS) for maintenance. With Train A of AC power OOS (resulting in Train B of the facility TIS HVAC being OOS) Train A provides support to an operable ITS HVAC Train A. The intent of the maintenance events modeled is for the events to address maintenance on any component in that AC power division. This is true for the components normally in operation and the standby components. The maintenance unavailability represented by the ITS load center maintenance events model the unavailability of any component from the 13.8 kV ITS switchgear through the ITS load center. The maintenance unavailability represented by the ITS diesel generator maintenance events represent the unavailability of any of the components or systems that would prevent the ITS diesel generator from starting and loading onto the 13.8 kV ITS switchgear. As noted earlier, all of the human events are associated with the failure to restore a component to operable or standby status after maintenance. The operator-related events shown in the following table are combination events: they include the probability that the component has been taken OOS for maintenance and that site personnel have not restored the component to operable or standby status. A screening value of 0.1 has been used for the HEP in all cases.

Table B8.4-5. Basic Event Probability for The Loss of AC Power to CRCF ITS Load Center Train B Fault Trees

Name	Description ^b	Calc. Type ^a	Calc. Prob.	Fail. Prob.	Lambda	Miss. Time ^a
060-#EEE-CRCF1-A-XMR-CCF	CRCF ITS Transformers CCF	1	4.920E-06	4.920E-06	2.910E-07	3.380E+01
060-#EEE-CRCF1-B-XMR-FOH	CRCF ITS Transformer Train B Failure	3	2.095E-04	0.000E+00	2.910E-07	7.200E+02
060-#EEE-LDCNTRA-BUA-MTN	ITS Load Center Train A OOS for Maintenance	3	1.025E-04	0.000E+00	6.100E-07	1.680E+02
060-#EEE-LDCNTRA-BUA-ROE	Failure to Restore ITS Load Center Train A post maintenance	1	1.025E-05	1.025E-05	7.910E-07	1.680E+01
060-#EEE-LDCNTRB-BUA-FOH	CRCF ITS Load Center B Fails	3	4.391E-04	0.000E+00	6.100E-07	7.200E+02
060-#EEE-LDCNTRB-BUA-MTN	ITS Load Center Train B OOS for Maintenance	3	1.025E-04	0.000E+00	6.100E-07	1.680E+02
060-#EEE-LDCNTRB-BUA-ROE	ITS Failure to Restore Load Center Train B post maintenance	1	1.025E-05	1.025E-05	7.910E-07	1.680E+01
060-#EEE-LDCNTRB-C52-FOD	13.8 kV ITS SWGR to CRCF ITS LC B Circuit Breaker Fails on Demand	1	2.240E-03	2.240E-03	0.000E+00	0.000E+00
060-#EEE-LDCNTRB-C52-SPO	CRCF ITS Load Center Circuit Breaker (AC) Spur Op	3	3.816E-03	0.000E+00	5.310E-06	7.200E+02
060-#EEE-LDCNTRS-C52-CCF	CCF of the ITS Load Center feed breakers to reclose	1	1.050E-04	1.050E-04	0.000E+00	0.000E+00
060-#EEE-MCC0002-C52-SPO	CRCR MCC-00002 Feed Breaker Spurious Operation	3	3.816E-03	0.000E+00	5.310E-06	7.200E+02
060-#EEE-MCC0002-MCC-FOH	CRCF ITS MCC00002 Failure	3	5.378E-03	0.000E+00	7.490E-06	7.200E+02
060-VCT0-AHU0004-AHU-FTR	CRCF ITS ELeC AHU 00004 Fails to Run	3	2.646E-03	0.000E+00	3.680E-06	7.200E+02
060-VCT0-AHU0004-CTL-FOD	CRCF ITS Elec AHU 00004 Controller Fails	1	2.030E-03	2.030E-03	0.000E+00	0.000E+00
060-VCT0-AHU0004-FAN-FTS	CRCF ITS Elec AHU 00004 Fails to Start	1	2.020E-03	2.020E-03	0.000E+00	0.000E+00
060-VCT0-AHU0202-AHU-CCR	CCF of standby CRCF ITS Elec AHUs to start/run	1	1.600E-04	1.600E-04	0.000E+00	0.000E+00
060-VCT0-EXH-007-CTL-FOD	CRCF ITS Elec Exh fan 00007 Controller Fails	1	2.030E-03	2.030E-03	0.000E+00	0.000E+00
060-VCT0-EXH-007-FAN-FTR	CRCF ITS Elec Exhaust Fan 00007 Fails to Run	3	5.059E-02	0.000E+00	7.210E-05	7.200E+02
060-VCT0-EXH-008-FAN-FTR	CRCF ITS Elec Exh. Fan 8 Fails to Run	3	5.059E-02	0.000E+00	7.210E-05	7.200E+02
060-VCT0-EXH-008-FAN-FTS	CRCF ITS Elec Exh fan 00008 Fails to Start	1	2.020E-03	2.020E-03	0.000E+00	0.000E+00
060-VCT0-EXH008-CTL-FOD	CRCF ITS Elec Exh Fan 0008 Controller Fails	1	2.030E-03	2.030E-03	0.000E+00	0.000E+00
060-VCT0-EXH0507-FAN-CCR	CCF of running Exh fans for CRCF ITS Elec.	1	1.200E-03	1.200E-03	0.000E+00	0.000E+00
060-VCT0-EXH0608-FAN-CCF	CCF to start/run: standby Exh fans for the CRCF ITS Elec	1	1.300E-03	1.300E-03	0.000E+00	0.000E+00
060-VCT0-AHU0003-AHU-FTR	CRCF ITS Elec AHU 00003 Fails to run	3	2.646E-03	0.000E+00	3.680E-06	7.200E+02
060-VCT0-AHU0003-CTL-FOD	CRCF ITS Elec AHU 00003 Controller Fails	1	2.030E-03	2.030E-03	0.000E+00	0.000E+00

B8-35

March 2008

Table B8.4-5. Basic Event Probability for The Loss of AC Power to CRCF ITS Load Center Train B Fault Trees (Continued)

Name	Description ^b	Calc. Type ^a	Calc. Prob.	Fail. Prob.	Lambda	Miss. Time ^a
060-VCTO-AHU0103-AHU-CCR	CCF of the running CRCF ITS Elec AHUs to continue to run	1	6.200E-05	6.200E-05	0.000E+00	0.000E+00
26D-##EG-DAYTNKB-TKF-FOH	ITS DG B Day fuel tank fails	3	1.584E-04	0.000E+00	4.400E-07	3.600E+02
26D-##EG-FLITLKB-IEL-FOD	ITS DG B fuel transfer pumps Interlock Failure	1	2.750E-05	2.750E-05	0.000E+00	0.000E+00
26D-##EG-FTP1DGB-PMD-FTR	ITS DG B Fuel Transfer Pump 1 (Motor Driven) Fails to Run	3	1.234E-02	0.000E+00	3.450E-05	3.600E+02
26D-##EG-FTP1DGB-PMD-FTS	ITS DG B Fuel Transfer Pump 1 (Motor Driven) Fails to Start	1	2.500E-03	2.500E-03	0.000E+00	0.000E+00
26D-##EG-FTP2DGB-PMD-FTR	ITS DG B Fuel Transfer Pump 2 (Motor Driven) Fails to Run	3	1.234E-02	0.000E+00	3.450E-05	3.600E+02
26D-##EG-FTP2DGB-PMD-FTS	ITS DG B Fuel Transfer Pump 2 (Motor Driven) Fails to Start on Demand	1	2.500E-03	2.500E-03	0.000E+00	0.000E+00
26D-##EG-FULPMPB-PMD-CCR	CCF of ITS DG B fuel pumps to run	1	2.900E-04	2.900E-04	0.000E+00	0.000E+00
26D-##EG-FULPMPB-PMD-CCS	CCF of ITS DG B fuel pumps to start	1	1.200E-04	1.200E-04	0.000E+00	0.000E+00
26D-##EG-HVACFN1-FAN-FTR	ITS DG B room Fan 1 (Motor-Driven) Fails to Run	3	2.562E-02	0.000E+00	7.210E-05	3.600E+02
26D-##EG-HVACFN1-FAN-FTS	ITS DG B room Fan (Motor-Driven) Fails to Start	1	2.020E-03	2.020E-03	0.000E+00	0.000E+00
26D-##EG-HVACFN2-FAN-FTR	ITS DG B room Fan 2 (Motor-Driven) Fails to Run	3	2.562E-02	0.000E+00	7.210E-05	3.600E+02
26D-##EG-HVACFN2-FAN-FTS	ITS DG B Room Fan (Motor-Driven) Fails to Start	1	2.020E-03	2.020E-03	0.000E+00	0.000E+00
26D-##EG-HVACFN3-FAN-FTR	ITS DG B room Fan 3 (Motor-Driven) Fails to Run	3	2.562E-02	0.000E+00	7.210E-05	3.600E+02
26D-##EG-HVACFN3-FAN-FTS	ITS DG B Room Fan 3 (Motor-Driven) Fails to Start	1	2.020E-03	2.020E-03	0.000E+00	0.000E+00
26D-##EG-HVACFN4-FAN-FTR	ITS DG B Fan 4 (Motor-Driven) Fails to Run	3	2.562E-02	0.000E+00	7.210E-05	3.600E+02
26D-##EG-HVACFN4-FAN-FTS	ITS DG B Room Fan 4 (Motor-Driven) Fails to Start	1	2.020E-03	2.020E-03	0.000E+00	0.000E+00
26D-##EG-STRTDGB-C72-SPO	13.8 kV ITS SWGR Battery B Circuit Breaker (DC) Spur Op	3	3.851E-04	0.000E+00	1.070E-06	3.600E+02 ^d
26D-##EG-WKTNK_B-TKF-FOH	ITS DG B Bulk Fuel Tank Fails	3	1.584E-04	0.000E+00	4.400E-07	3.600E+02
26D-##EGBATCHRGB-BYC-FOH	ITS DG B Battery Charger failure	3	1.276E-03	0.000E+00	7.600E-06	1.680E+02 ^c
26D-##EEE-SWGRDGB-AHU-FTR	EDGB Switchgear Room Air Handling Unit Failure to Run	3	2.646E-03	0.000E+00	3.680E-06	7.200E+02
26D-##EEE-SWGRDGB-BUA-FOH	13.8 kV ITS Switchgear B Bus Failure	3	4.391E-04	0.000E+00	6.100E-07	7.200E+02
26D-##EEU-208_DGB-BUD-FOH	ITS DG B DC Panel Failure	3	8.640E-05	0.000E+00	2.400E-07	3.600E+02 ^d
26D-##EEY-DGBLOAD-C52-FOD	ITS DG B Load Breaker (AC) Fails to Close	1	2.240E-03	2.240E-03	0.000E+00	0.000E+00

B8-36

March 2008

Table B8.4-5. Basic Event Probability for The Loss of AC Power to CRCF ITS Load Center Train B Fault Trees (Continued)

Name	Description ^b	Calc. Type ^a	Calc. Prob.	Fail. Prob.	Lambda	Miss. Time ^a
26D-#EEY-DGLOADS-C52-CCF	Common cause failure of ITS DG Load Breakers to close	1	1.050E-04	1.050E-04	0.000E+00	0.000E+00
26D-#EEY-ITS-DGB-#DG-FTS	Diesel Generator Fails to Start	1	8.380E-03	8.380E-03	0.000E+00	0.000E+00
26D-#EEY-ITSDG-A-#DG-MTN	ITS DG A OOS Maintenance	1	1.950E-03	1.950E-03	0.000E+00	0.000E+00
26D-#EEY-ITSDG-A-#DG-RSS	Failure to properly return ITS DG A to service	1	1.950E-04	1.950E-04	0.000E+00	0.000E+00
26D-#EEY-ITSDG-B-#DG-MTN	ITS DG B OOS Maintenance	1	1.950E-03	1.950E-03	0.000E+00	0.000E+00
26D-#EEY-ITSDG-B-#DG-RSS	Failure to properly restore ITS DG-B to service	1	1.950E-04	1.950E-04	0.000E+00	0.000E+00
26D-#EEY-ITSDGAB-#DG-CCR	CCF ITS DG A & B Fail to Run	1	1.800E-02	1.800E-02	0.000E+00	0.000E+00
26D-#EEY-ITSDGAB-#DG-CCS	CCF DG A and B to Start	1	3.900E-04	3.900E-04	0.000E+00	0.000E+00
26D-#EEY-ITSDGB-#DG-FTR	ITS DG B Fails to Run	3	7.698E-01	0.000E+00	4.080E-03	3.600E+02
26D-#EEY-OB-SWGB-C52-FOD	13.8 kV Feed Breaker (from SWYD) Fails on Demand	1	2.240E-03	2.240E-03	0.000E+00	0.000E+00
26D-#EEY-OB-SWGB-C52-SPO	13.8 kV ITS SWGR Feed Breaker (AC) Spurious Op	3	3.816E-03	0.000E+00	5.310E-06	7.200E+02
26D-#EEY-OB-SWGS-C52-CCF	Common cause failure of 13.8kV ITS SWGR feed breakers to open	1	1.040E-04	1.040E-04	0.000E+00	0.000E+00
26D-#EG-BATTERYB-BTR-FOD	ITS SWGR Control Battery B No Output	1	8.200E-03	8.200E-03	0.000E+00	0.000E+00
26D-#EG-LDSQNCRB-SEQ-FOD	ITS DG B load sequencer fails	1	3.330E-03	3.330E-03	0.000E+00	0.000E+00
26D-#EG-LOCKOUTB-RLY-FTP	13.8 kV ITS SWGR Lockout Relay (Power) Fails to Open CB	3	3.152E-03	0.000E+00	8.770E-06	3.600E+02

B8-37

March 2008

Table B8.4-5. Basic Event Probability for The Loss of AC Power to CRCF ITS Load Center Train B Fault Trees (Continued)

Name	Description ^b	Calc. Type ^a	Calc. Prob.	Fail. Prob.	Lambda	Miss. Time ^a
27A-#EEE-BUS3DGB-C52-SPO	13.8 kV Open Bus 4 to ITS B Load Breaker (AC) Spurious Op	3	3.816E-03	0.000E+00	5.310E-06	7.200E+02
27A-#EEN-OPENBS4-BUA-FOH	13.8 kV Open Bus 4 Bus Failure	3	4.391E-04	0.000E+00	6.100E-07	7.200E+02
27A-#EEN-OPNBS3B-SWP-SPO	13.8 kV Open Bus 4 to ITS B Electric Power Switch Spur Xfer	3	1.116E-04	0.000E+00	1.550E-07	7.200E+02
LOSP*	Loss of Offsite Power	1	2.99E-03	2.99E-03	0.000E+00	0.000E+00

NOTE: ^a For Calc. Type 3 with a mission time of 0, SAPHIRE performs the quantification using the system mission time.

The designation of a circuit breaker as AC or DC refers to the system designation for the circuit breaker, it is not representative of the motive power for the circuit breaker.

^b The failure of the battery charger would result in eventual depletion of the battery and a low power indication on both the battery and the DC bus. The 168 hr mission time was selected as a conservative estimation for the detection time of this failure.

^c The mission times for the DC bus related failure rates do not take credit for any monitoring of bus status, which would provide nearly instantaneous indication of a bus failure or loss of power to the bus. The standby component mission time was used conservatively.

^d LOSP* represents the probability of losing offsite power during the 720 hours HVAC is required after any breach of a container releases radioactive material. It is based on a loss of offsite power frequency of 3.59E-02/year from NUREG/CR6890 Vol. 1 (Ref. B8.1.19).

AC = alternating current; AHU = air handling unit; Calc. = calculation; CCF = common-cause failure; DC = direct current; DG = diesel generator; Div = division; elc = electrical; exh = exhaust; ITS = important to safety; kV = kilovolt; Miss. = mission; OOS = out of service; op = operation; Prob. = probability; Spur. = spurious; SWGR = switch gear; Xfer = transfer.

Source: Original

B8.4.2.5.1 Human Failure Events

Four basic HFEs (Table B8.4-6) are associated with human error. All of the HFEs are associated with the failure to properly restore components to operable status following maintenance. The first two shown in Table B8.4-6 are associated with the failure to restore the normal power supply to the CRCF ITS load centers after maintenance. The last two are representative of the failure to restore the ITS diesel generators (and any other components that would prevent the ITS diesel generator from starting or loading) to service after maintenance. These events are combination events consisting of the probability that a component was removed for maintenance and the failure of plant operators (assigned a screening value of 0.1) to restore the component after maintenance.

Table B8.4-6. Human Failure Events

Name	Description
060-#EEE-LDCNTRA-BUA-ROE	Failure to restore ITS load center Train A post maintenance
060-#EEE-LDCNTRB-BUA-ROE	Failure to restore ITS load center Train B post maintenance
26D-#EEY-ITSDG-A-#DG-RSS	Failure to properly return ITS DG A to service
26D-#EEY-ITSDG-B-#DG-RSS	Failure to properly return ITS DG B to service

NOTE: DG = diesel generator; ITS = important to safety.

Source: Original

B8.4.2.5.2 Common-Cause Failures

Twelve of the fourteen CCF failures identified (Table B8.4-7) have been included in the analysis of the loss of ITS AC power to the ITS load center Train A. Ten of the CCF events affect both trains of ITS AC Power. Two affect only this train of the system. The remaining two affect only the other train of the system.. Two are associated with the ITS diesel generators: CCF failure of the ITS diesel generators to start and CCF failure of the ITS diesel generators to run.

The CCF failure of the ITS diesel generator fuel oil system incorporates two CCF failures: The CCF failure of the two fuel oil pumps to start and the CCF failure of the pumps to run. Three circuit breaker CCF events were considered. These are the CCF failure of the (1) 13.8 kV ITS switchgear feed breakers, from 13.8 kV open buses to open on loss of offsite power, (2) ITS diesel generator load breakers to close when commanded by the load sequencer, and (3) ITS load center feed breakers to close when commanded by the load sequencer. Four CCFs are associated with the CRCF ITS Electrical and Battery Rooms Ventilation System, two for the CCF of exhaust fans to start and run, and two for the CCF of the air handling units to start and run. The last CCF event considered is the CCF failure of the 13.8 kV - 480V ITS transformers.

All of the CCFs modeled are used on pairs of components with one of two success criteria (i.e., two of two failure criteria). Alpha-factors used to determine the common cause failure probability are 0.047 for demand failures and 0.0235 for time dependent failures (Table C3-1, CCCG=2, and the associated text). Two CCFs in Table B8.4-7 are used to represent the CCF associated with the failure to start and failure to run for components. For these two CCFs, the appropriate alpha-factors were applied to the start and run portions of the random failure probability to develop a single common cause failure probability for the components.

Table B8.4-7 Common-Cause Basic Events

Name	Description	Alpha-factor
060-#EEE-CRCF1-A-XMR-CCF	CRCF ITS Transformers CCF	0.0235
060-#EEE-LDCNTRS-C52-CCF	CCF of the ITS load center feed breakers to reclose	0.047
26D-##EG-FULPMPB-PMD-CCR	CCF of ITS DG B fuel pumps to run	0.0235
26D-##EG-FULPMPB-PMD-CCS	CCF of ITS DG B fuel pumps to start	0.047
26D-#EEY-DGLOADS-C52-CCF	CCF of ITS DG load breakers to close	0.047
26D-#EEY-ITSDGAB-#DG-CCR	CCF ITS DG A & B fail to run	0.0235
26D-#EEY-ITSDGAB-#DG-CCS	CCF DG A and B to start	0.047
26D-#EEY-OB-SWGS-C52-CCF	CCF of 13.8 kV ITS SWGR feed breakers to open	0.047
060-VCT0-AHU0202-AHU-CCR	CCF of standby CRCF ITS Elec AHUs to start/run	0.047 start 0.0235 run
060-VCT0-EXH0507-FAN-CCR	CCF of running Exh fans for CRCF ITS Elec.	0.0235
060-VCT0-EXH0608-FAN-CCF	CCF to start/run: standby Exh fans for the CRCF ITS Elec	0.047 start 0.0235 run
060-VCT0-AHU0103-AHU-CCR	CCF of the running CRCF ITS Elec AHUs to continue to run	0.0235

NOTE: AHU = air handling unit; CCF = common-cause failure, CRCF = Canister Receipt and Closure Facility; DG = diesel generator; elec = electrical; exh = exhaust; ITS = important to safety; SWGR = switch gear.

Source: Original

B8.4.2.6 Uncertainty and Cut Set Generation

Figure B8.4-3 contains the uncertainty results obtained from running the fault tree for “Loss of AC Power to CRCF ITS Load Center Train B”. Figure B8.4-4 provides the cut set generation results for the “Loss of AC Power to CRCF ITS Load Center Train B”.

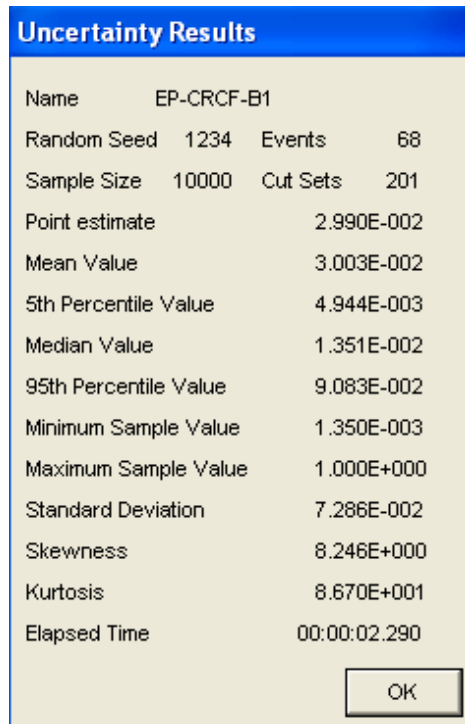

Source: Original

Figure B8.4-3. Uncertainty Results of the Loss of AC Power to CRCF ITS Load Center Train B Fault Tree

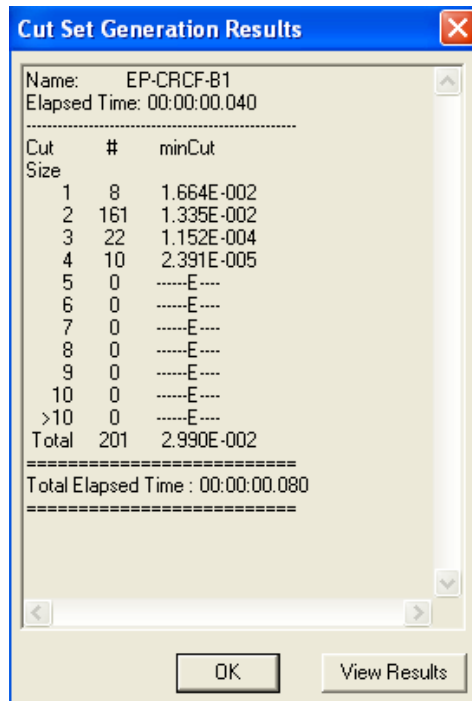

Source: Original

Figure B8.4-4. Cut Set Generation Results for Loss of AC Power to CRCF ITS Load Center Train B

B8.4.2.7 Cut Sets

Table B8.4-8 contains the top 25 cut sets that contribute 97% of the total system failure probability for the “Loss of AC Power to CRCF ITS Load Center Train B” fault tree.

Table B8.4-8. Dominant Cut Sets for the Loss of AC Power to CRCF ITS Load Center Train B

% Total	% Cut Set	Prob./ Frequency	Basic Event	Description	Event Prob.
17.99	17.99	5.378E-03	060-#EEE-MCC0002-MCC-FOH	CRCF ITS MCC00002 Failure	5.378E-03
30.75	12.76	3.816E-03	060-#EEE-LDCNTRB-C52-SPO	CRCF ITS Load Center Circuit Breaker (AC) Spur Op	3.816E-03
43.51	12.76	3.816E-03	060-#EEE-MCC0002-C52-SPO	CRCR MCC-00002 Feed Breaker Spurious Operation	3.816E-03
53.33	9.82	2.937E-03	26D-#EEY-ITSDGB-#DG-FTR	ITS DG B Fails to Run	7.698E-01
			26D-#EEY-OB-SWGB-C52-SPO	13.8 kV ITS SWGR Feed Breaker (AC) Spurious Op	3.816E-03
63.15	9.82	2.937E-03	26D-#EEY-ITSDGB-#DG-FTR	ITS DG B Fails to Run	7.698E-01
			27A-#EEE-BUS3DGB-C52-SPO	13.8 kV Open Bus 4 to ITS B Load Breaker (AC) Spurious Op	3.816E-03
72.00	8.85	2.646E-03	26D-#EEE-SWGRDGB-AHU-FTR	EDGF Switchgear Room Air Handling Unit Failure to Run	2.646E-03
80.56	8.56	2.559E-03	060-VCT0-EXH-007-FAN-FTR	CRCF ITS Elec Exhaust Fan 00007 Fails to Run	5.059E-02
			060-VCT0-EXH-008-FAN-FTR	CRCF ITS Elec Exh. Fan 8 Fails to Run	5.059E-02
88.26	7.70	2.302E-03	26D-#EEY-ITSDGB-#DG-FTR	ITS DG B Fails to Run	7.698E-01
			LOSP	Loss of offsite power	2.990E-03
89.73	1.47	4.391E-04	060-#EEE-LDCNTRB-BUA-FOH	CRCF ITS Load Center B Fails	4.391E-04
91.20	1.47	4.391E-04	26D-#EEE-SWGRDGB-BUA-FOH	13.8 kV ITS Switchgear B Bus Failure	4.391E-04
92.33	1.13	3.380E-04	26D-#EEY-ITSDGB-#DG-FTR	ITS DG B Fails to Run	7.698E-01
			27A-#EEN-OPENBS4-BUA-FOH	13.8 kV Open Bus 4 Bus Failure	4.391E-04
93.03	0.70	2.095E-04	060-#EEE-CRCF1-B-XMR-FOH	CRCF ITS Transformer Train B Failure	2.095E-04
93.37	0.34	1.027E-04	060-VCT0-EXH-007-FAN-FTR	CRCF ITS Elec Exhaust Fan 00007 Fails to Run	5.059E-02
			060-VCT0-EXH008-CTL-FOD	CRCF ITS Elec Exh Fan 0008 Controller Fails	2.030E-03

Table B8.4-8. Dominant Cut Sets for the Loss of AC Power to CRCF ITS Load Center Train B
(Continued)

% Total	% Cut Set	Prob./ Frequency	Basic Event	Description	Event Prob.
93.71	0.34	1.027E-04	060-VCT0-EXH-007-CTL-FOD	CRCF ITS Elec Exh fan 00007 Controller Fails	2.030E-03
			060-VCT0-EXH-008-FAN-FTR	CRCF ITS Elec Exh. Fan 8 Fails to Run	5.059E-02
94.05	0.34	1.025E-04	060-###LDCNTRA-BUA-MTN	ITS Load Center Train A OOS for Maintenance	9.999E-01
			060-###LDCNTRA-BUA-ROE	Failure to Restore ITS Load Center Train A post maintenance	1.000E+00
			060-###LDCNTRB-BUA-MTN	ITS Load Center Train B OOS for Maintenance	1.025E-04
94.39	0.34	1.022E-04	060-VCT0-EXH-007-FAN-FTR	CRCF ITS Elec Exhaust Fan 00007 Fails to Run	5.059E-02
			060-VCT0-EXH-008-FAN-FTS	CRCF ITS Elec Exh fan 00008 Fails to Start	2.020E-03
94.72	0.33	9.777E-05	26D-###EG-HVACFN1-FAN-FTR	ITS DG B room Fan 1 (Motor-Driven) Fails to Run	2.562E-02
			26D-###EEY-OB-SWGB-C52-SPO	13.8 kV ITS SWGR Feed Breaker (AC) Spurious Op	3.816E-03
95.05	0.33	9.777E-05	26D-###EG-HVACFN2-FAN-FTR	ITs DG B room Fan 2 (Motor-Driven) Fails to Run	2.562E-02
			26D-###EEY-OB-SWGB-C52-SPO	13.8 kV ITS SWGR Feed Breaker (AC) Spurious Op	3.816E-03
95.38	0.33	9.777E-05	26D-###EG-HVACFN3-FAN-FTR	ITS DG B room Fan 3 (Motor-Driven) Fails to Run	2.562E-02
			26D-###EEY-OB-SWGB-C52-SPO	13.8 kV ITS SWGR Feed Breaker (AC) Spurious Op	3.816E-03
95.71	0.33	9.777E-05	26D-###EG-HVACFN4-FAN-FTR	ITS DG B Fan 4 (Motor-Driven) Fails to Run	2.562E-02
			26D-###EEY-OB-SWGB-C52-SPO	13.8 kV ITS SWGR Feed Breaker (AC) Spurious Op	3.816E-03
96.04	0.33	9.777E-05	26D-###EG-HVACFN1-FAN-FTR	ITS DG B room Fan 1 (Motor-Driven) Fails to Run	2.562E-02
			27A-###BUS3DGB-C52-SPO	13.8 kV Open Bus 4 to ITS B Load Breaker (AC) Spurious Op	3.816E-03
96.37	0.33	9.777E-05	26D-###EG-HVACFN2-FAN-FTR	ITS DG B room Fan 2 (Motor-Driven) Fails to Run	2.562E-02
			27A-###BUS3DGB-C52-SPO	13.8 kV Open Bus 4 to ITS B Load Breaker (AC) Spurious Op	3.816E-03

Table B8.4-8. Dominant Cut Sets for the Loss of AC Power to CRCF ITS Load Center Train B
(Continued)

% Total	% Cut Set	Prob./ Frequency	Basic Event	Description	Event Prob.
96.70	0.33	9.777E-05	26D-##EG-HVACFN3-FAN-FTR	ITS DG B room Fan 3 (Motor-Driven) Fails to Run	2.562E-02
			27A-###EEE-BUS3DGB-C52-SPO	13.8 kV Open Bus 4 to ITS B Load Breaker (AC) Spurious Op	3.816E-03
97.03	0.33	9.777E-05	26D-##EG-HVACFN4-FAN-FTR	ITS DG B Fan 4 (Motor-Driven) Fails to Run	2.562E-02
			27A-###EEE-BUS3DGB-C52-SPO	13.8 kV Open Bus 4 to ITS B Load Breaker (AC) Spurious Op	3.816E-03
97.32	0.29	8.590E-05	26D-##EEY-ITSDGB-#DG-FTR	ITS DG B Fails to Run	7.698E-01
			27A-##EEN-OPNBS3B-SWP-SPO	13.8 kV Open Bus 4 to ITS B Electric Power Switch Spur Xfer	1.116E-04

NOTE: AC = alternating current; CCF = common-cause failure; DG = diesel generator; elec = electrical; exh = exhaust; ITS = important to safety; kV = kilovolt; SWGR = switch gear; Xfer = transfer.

Source: Original

B8.4.2.8 AC Power Fault Trees

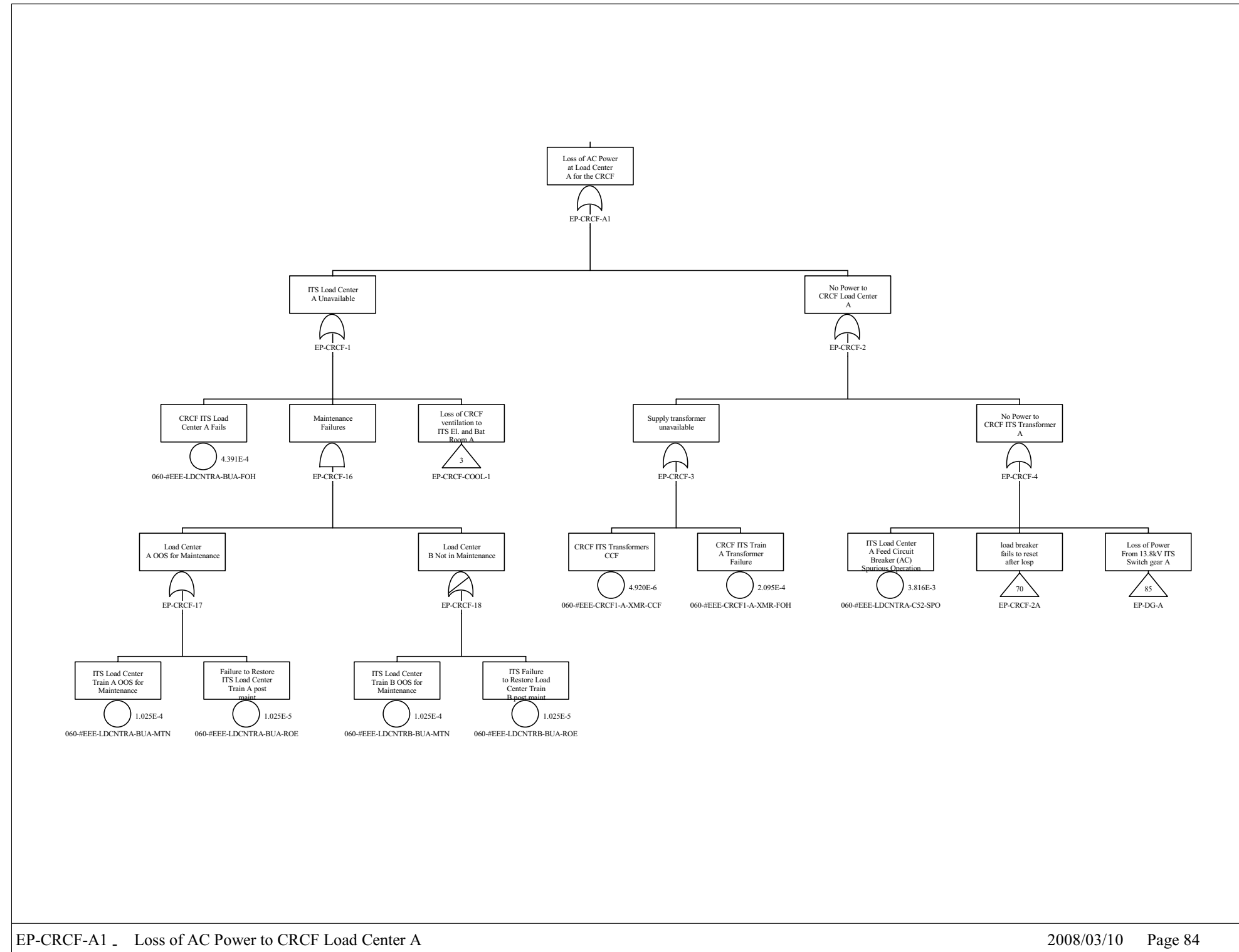

Source: Original

Figure B8.4-5. Loss of Power to CRCF ITS Load Center Train A Sheet 1

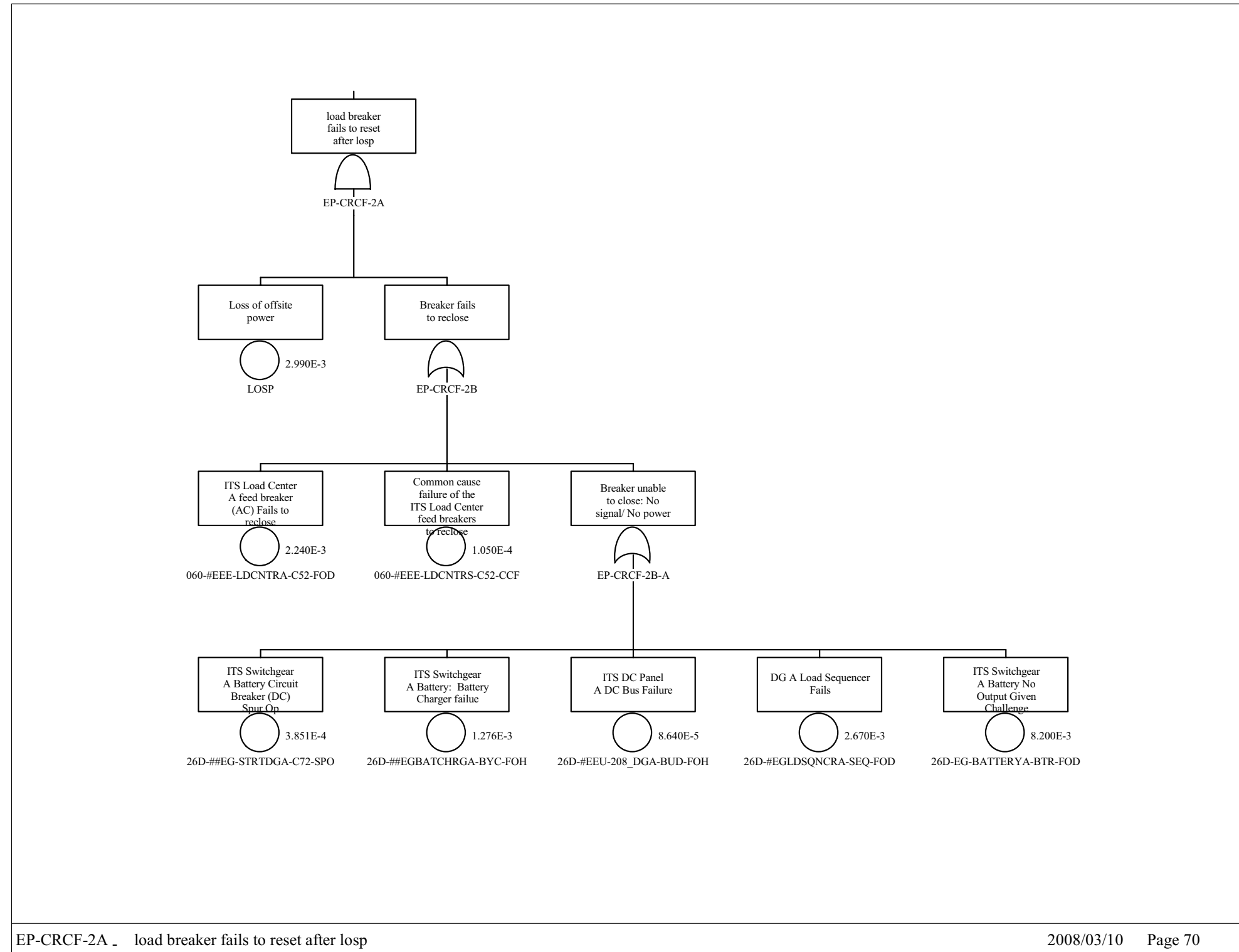

Source: Original

Figure B8.4-6. Loss of Power to CRCF ITS Load Center Train A Sheet 2

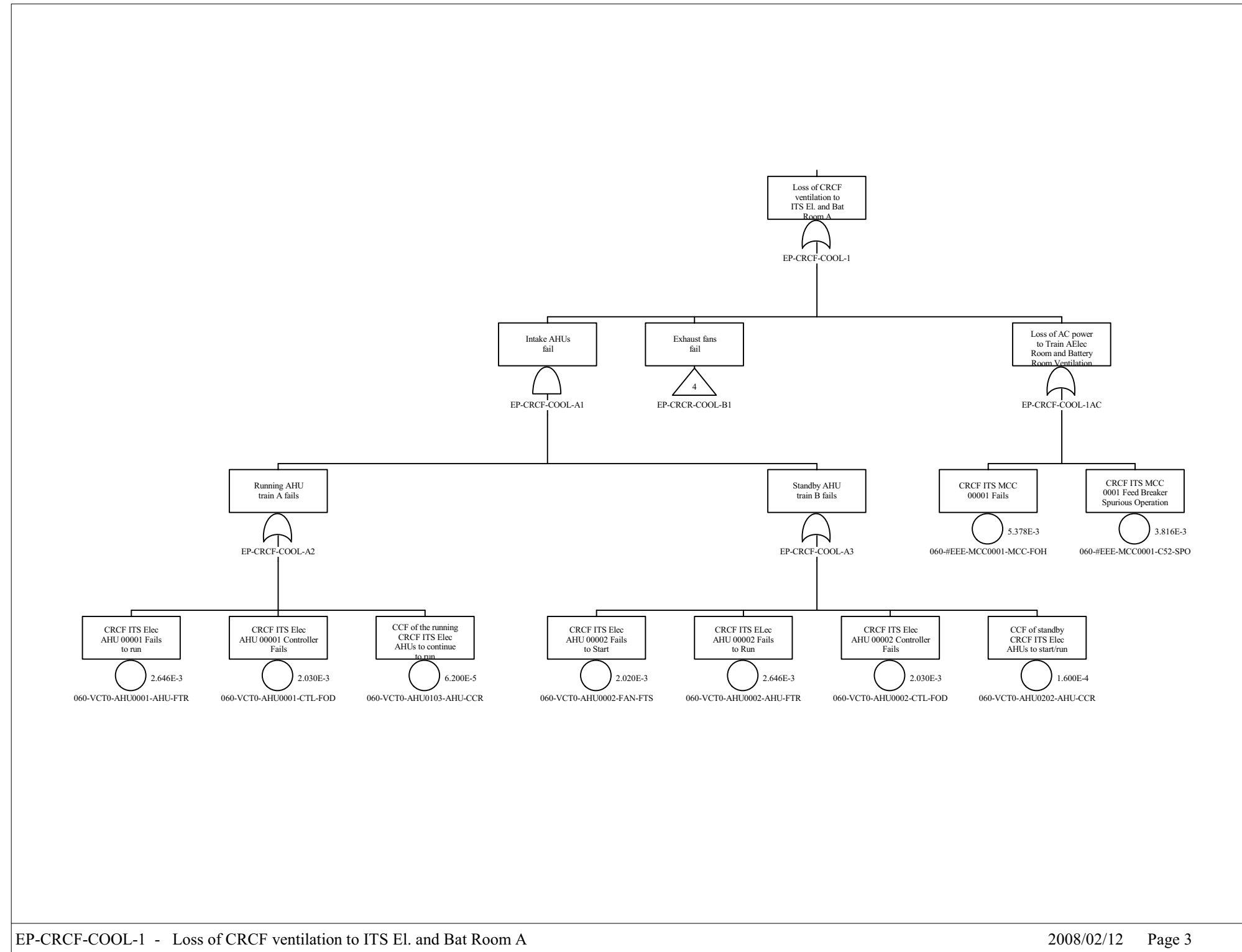

Source: Original

Figure B8.4-7. Loss of Power to CRCF ITS Load Center Train A Sheet 3

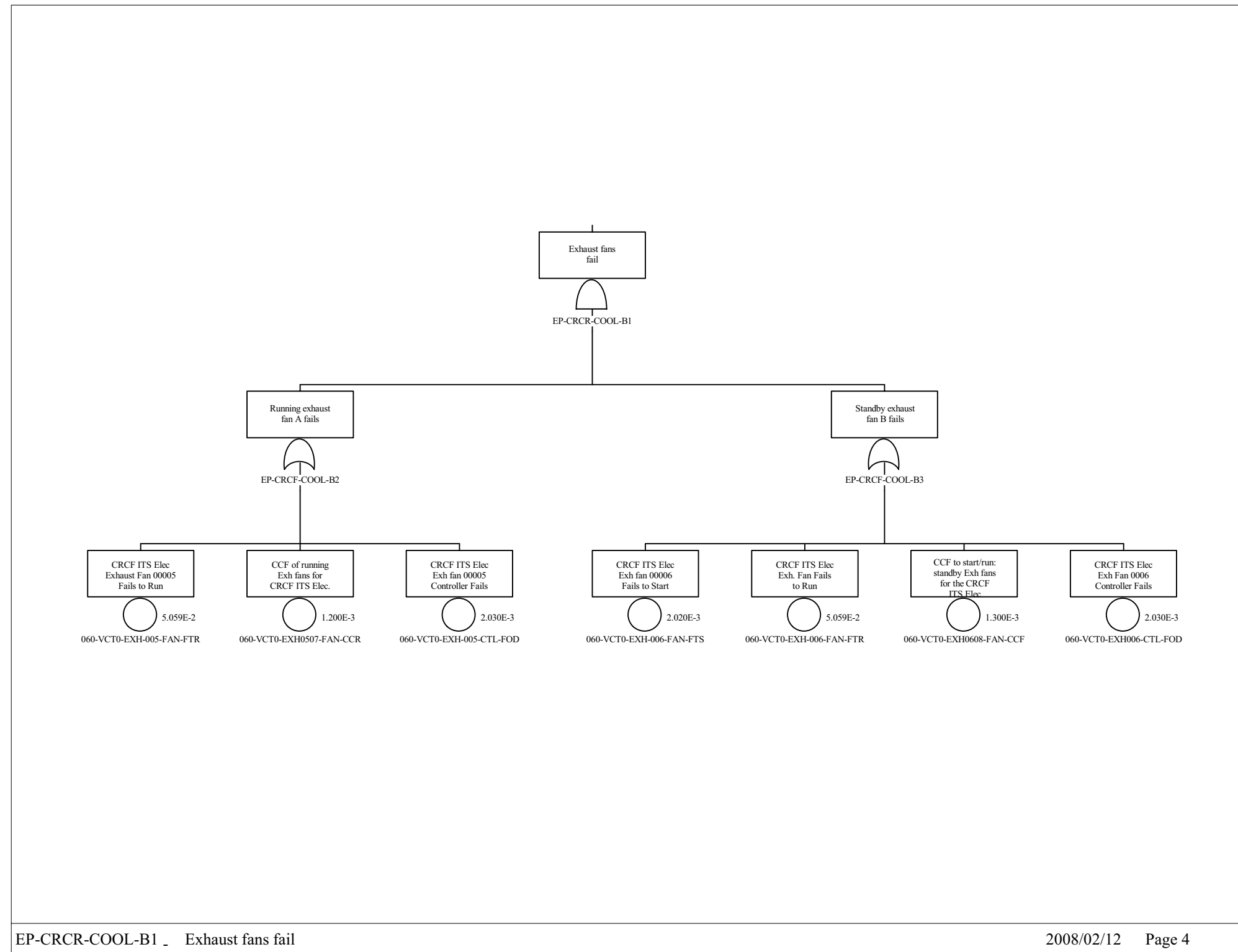

Source: Original

Figure B8.4-8. Loss of Power to CRCF ITS
Load Center Train A Sheet 4

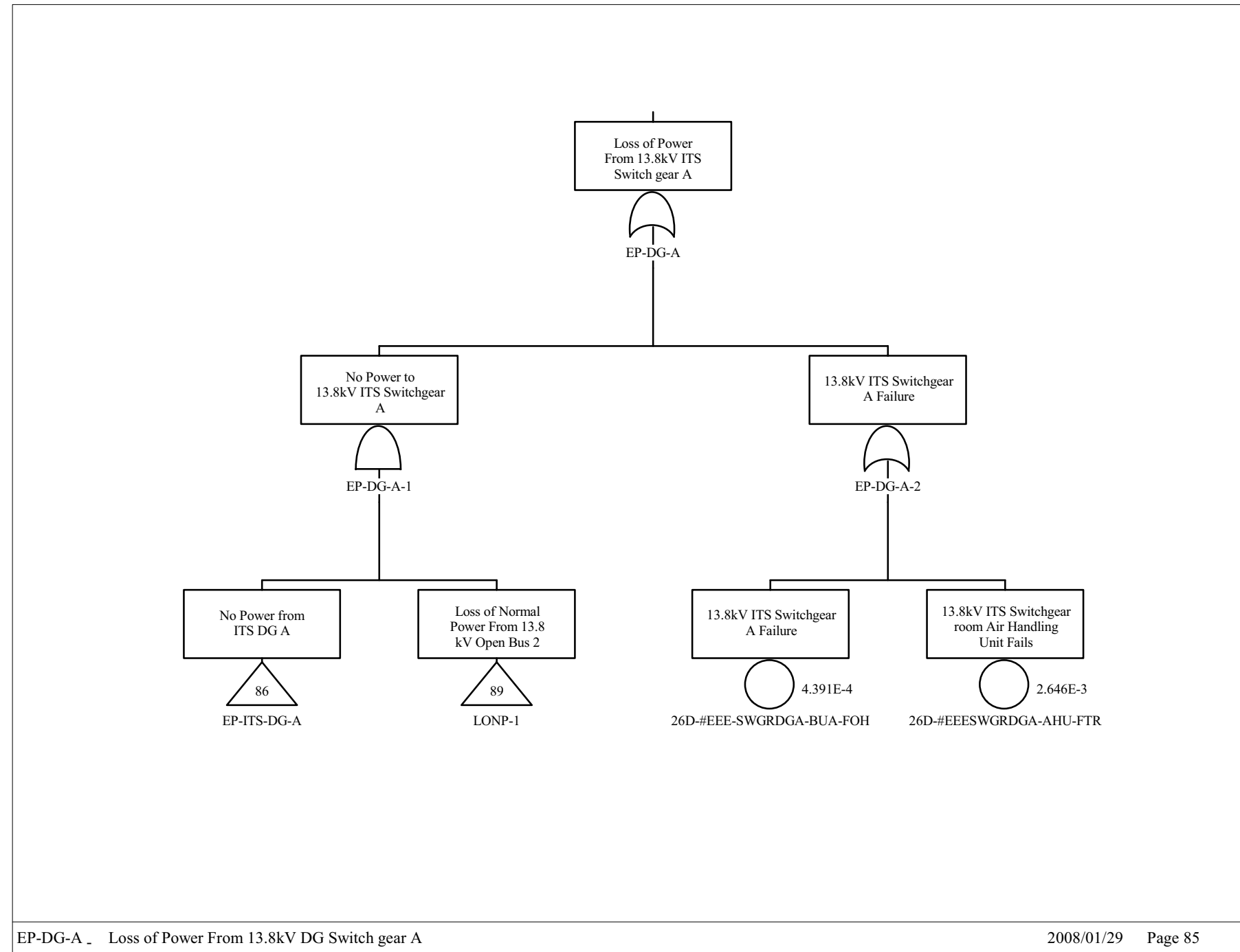

Source: Original

Figure B8.4-9. Loss of Power to CRCF ITS Load Center Train A Sheet 5

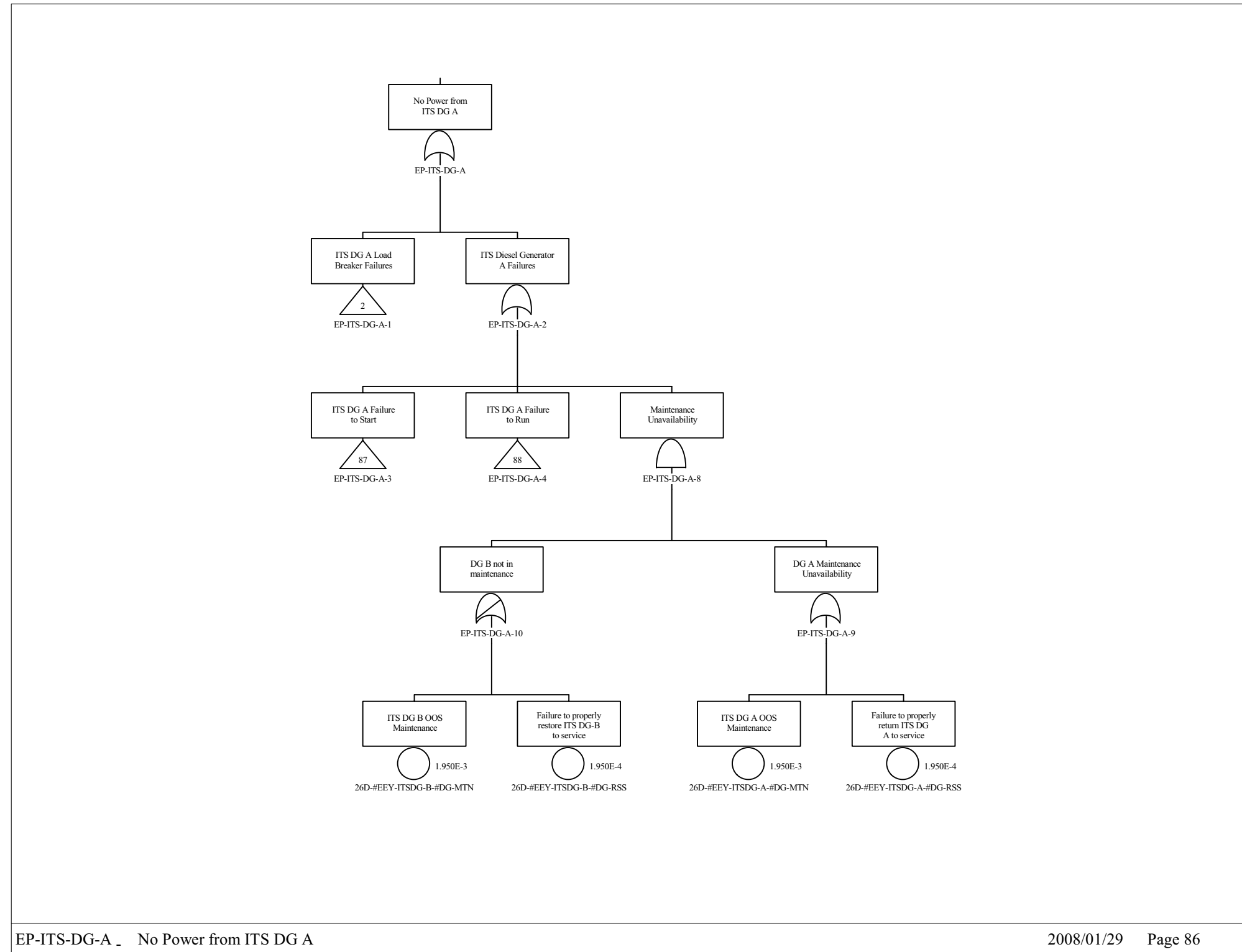

Source: Original

Figure B8.4-10. Loss of Power to CRCF ITS
Load Center Train A Sheet 6

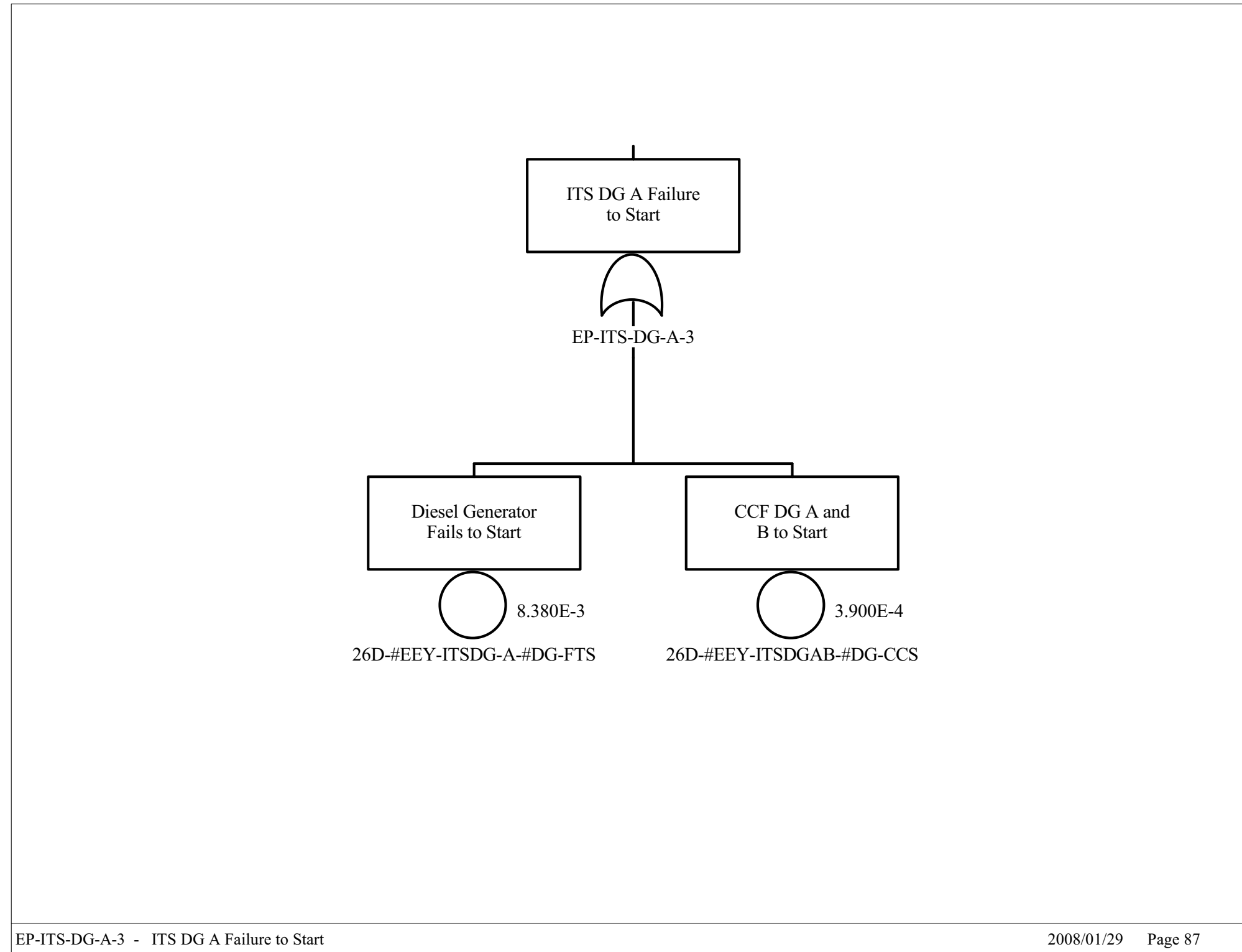

EP-ITS-DG-A-3 - ITS DG A Failure to Start

2008/01/29 Page 87

Source: Original

Figure B8.4-11. Loss of Power to CRCF ITS
Load Center Train A Sheet 7

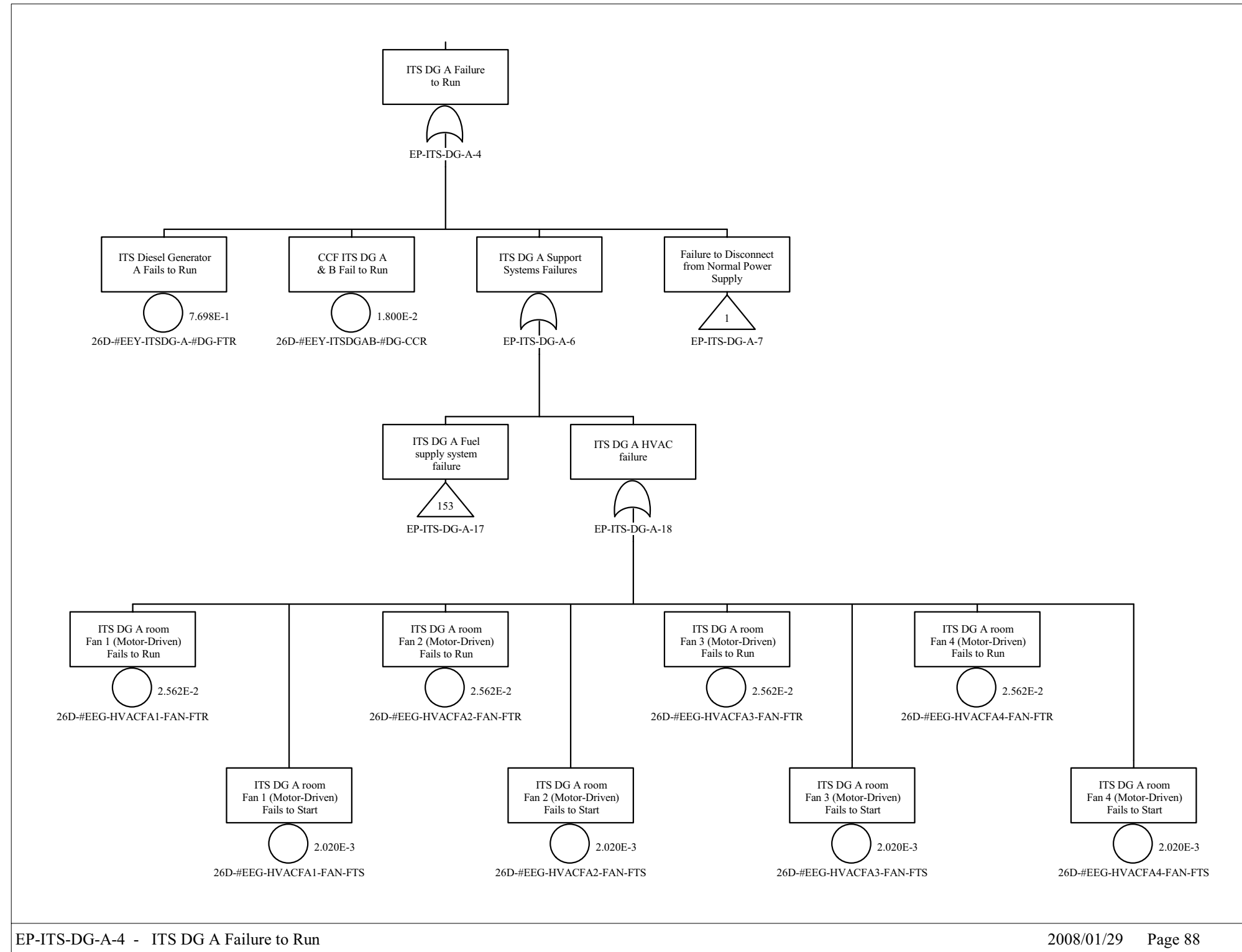

Source: Original

Figure B8.4-12. Loss of Power to CRCF ITS
Load Center Train A Sheet 8

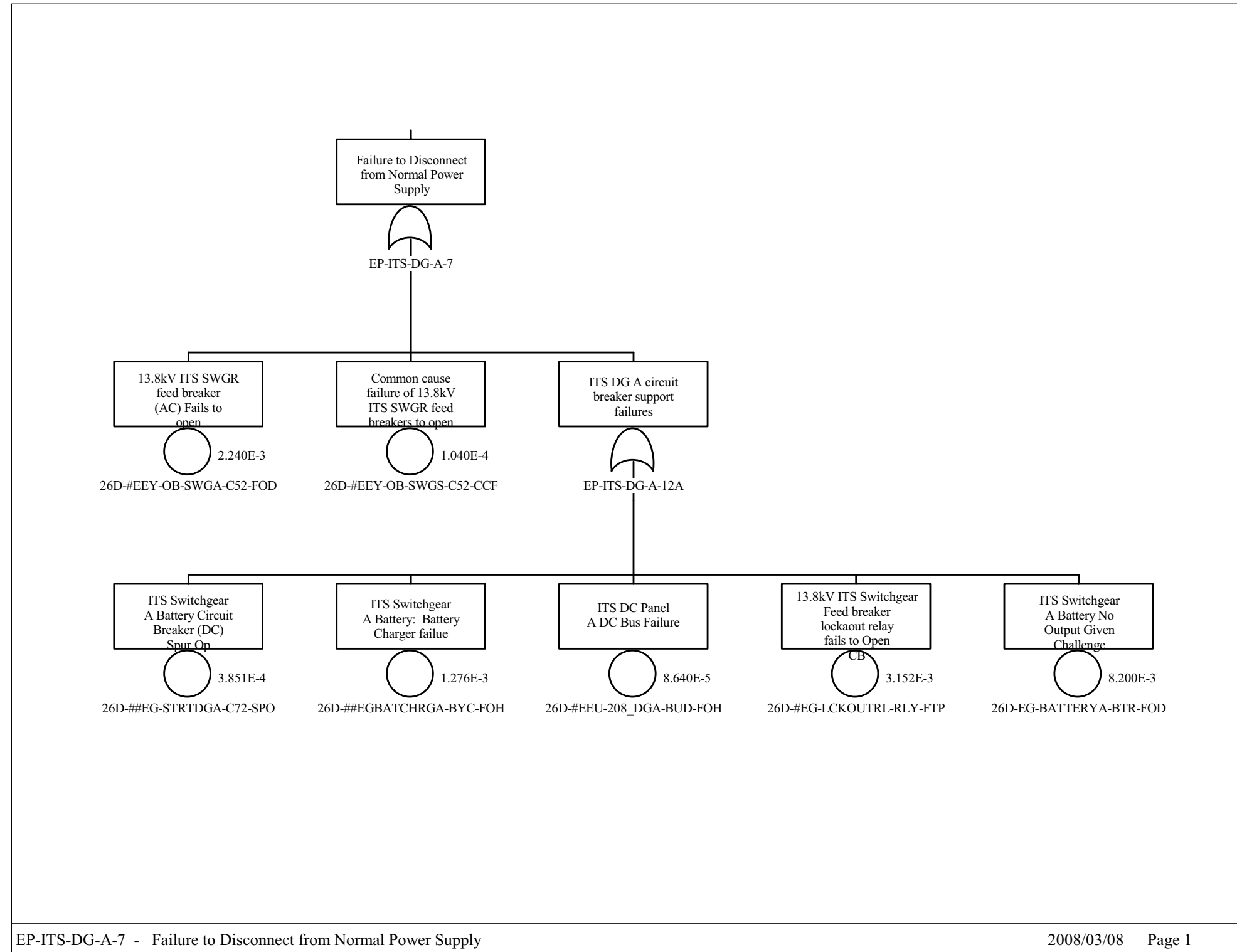

Source: Original

Figure B8.4-13. Loss of Power to CRCF ITS Load Center Train A Sheet 9

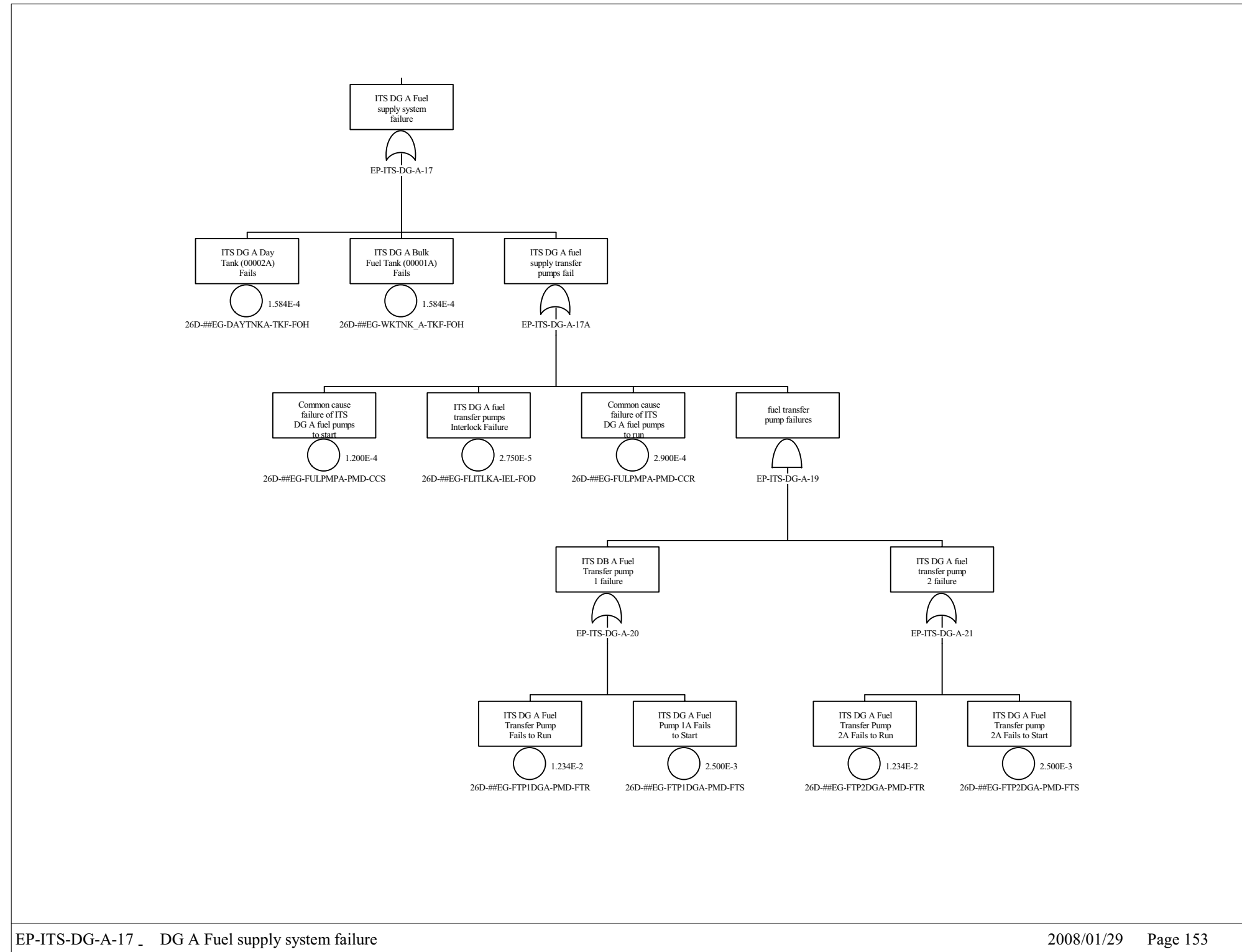

Source: Original

Figure B8.4-14. Loss of Power to CRCF ITS
Load Center Train A Sheet 10

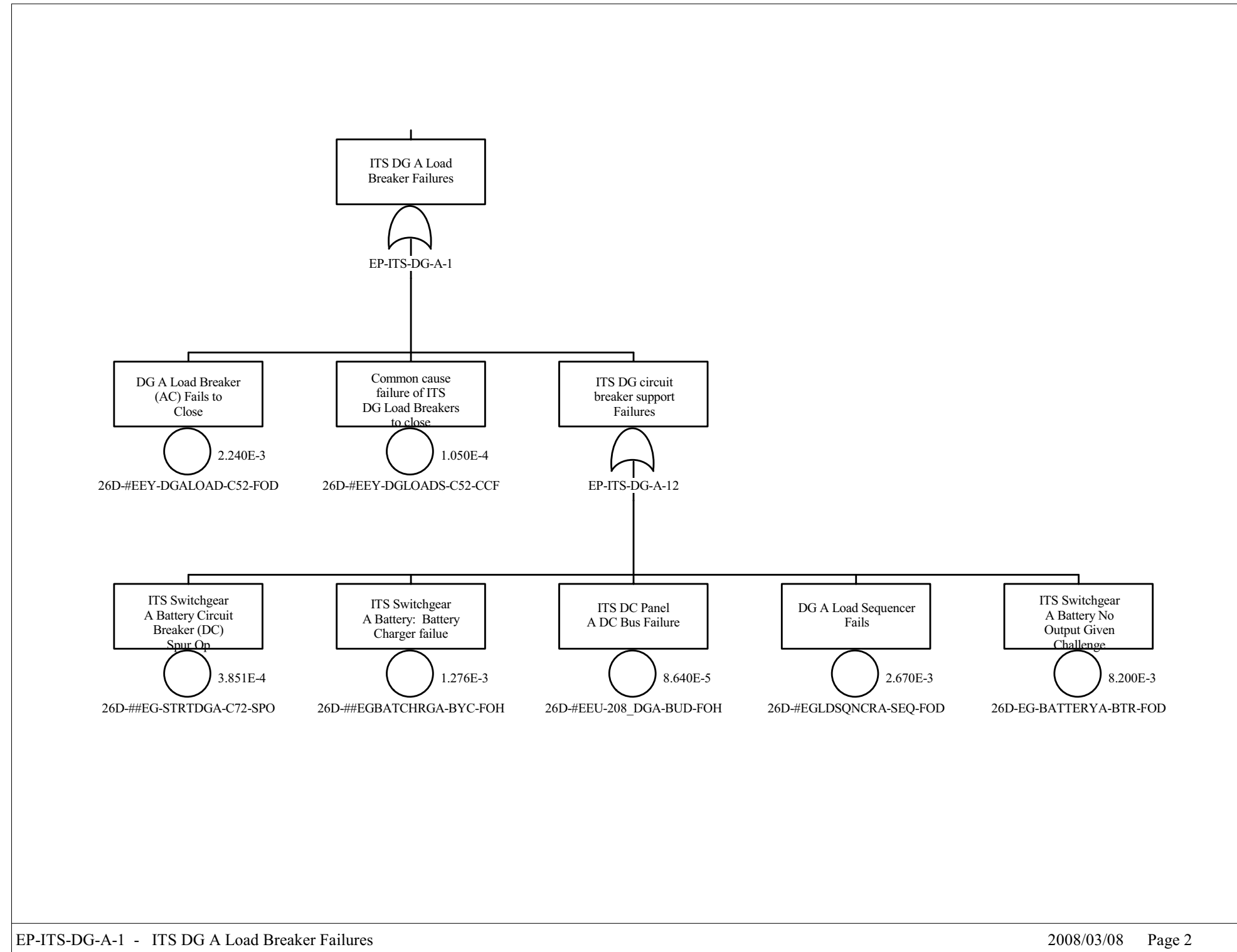

Source: Original

Figure B8.4-15. Loss of Power to CRCF ITS
Load Center Train A Sheet 11

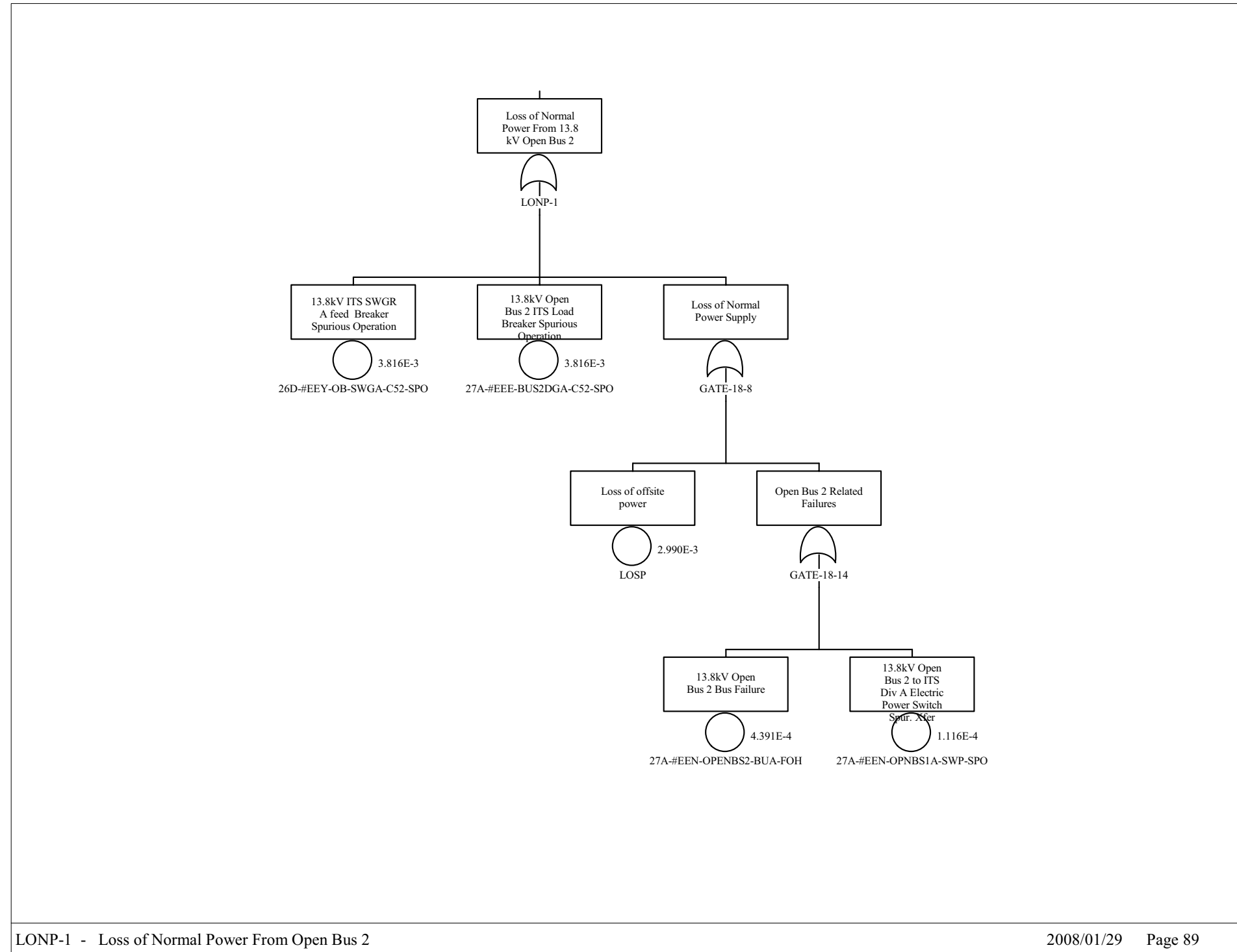

Source: Original

Figure B8.4-16. Loss of Power to CRCF ITS Load Center Train A Sheet 12

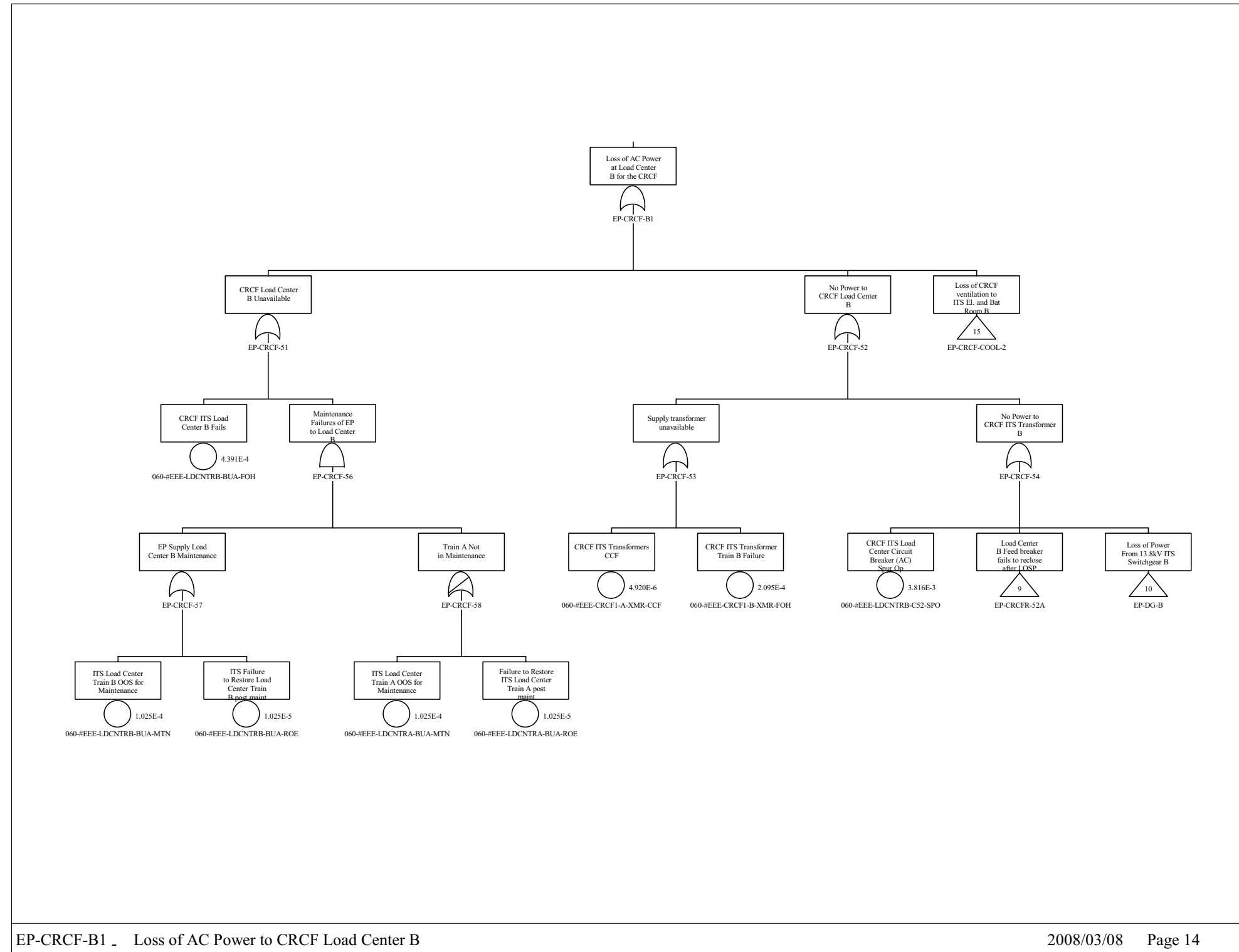

Source: Original

Figure B8.4-17. Loss of Power to CRCF ITS
Load Center Train B Sheet 1

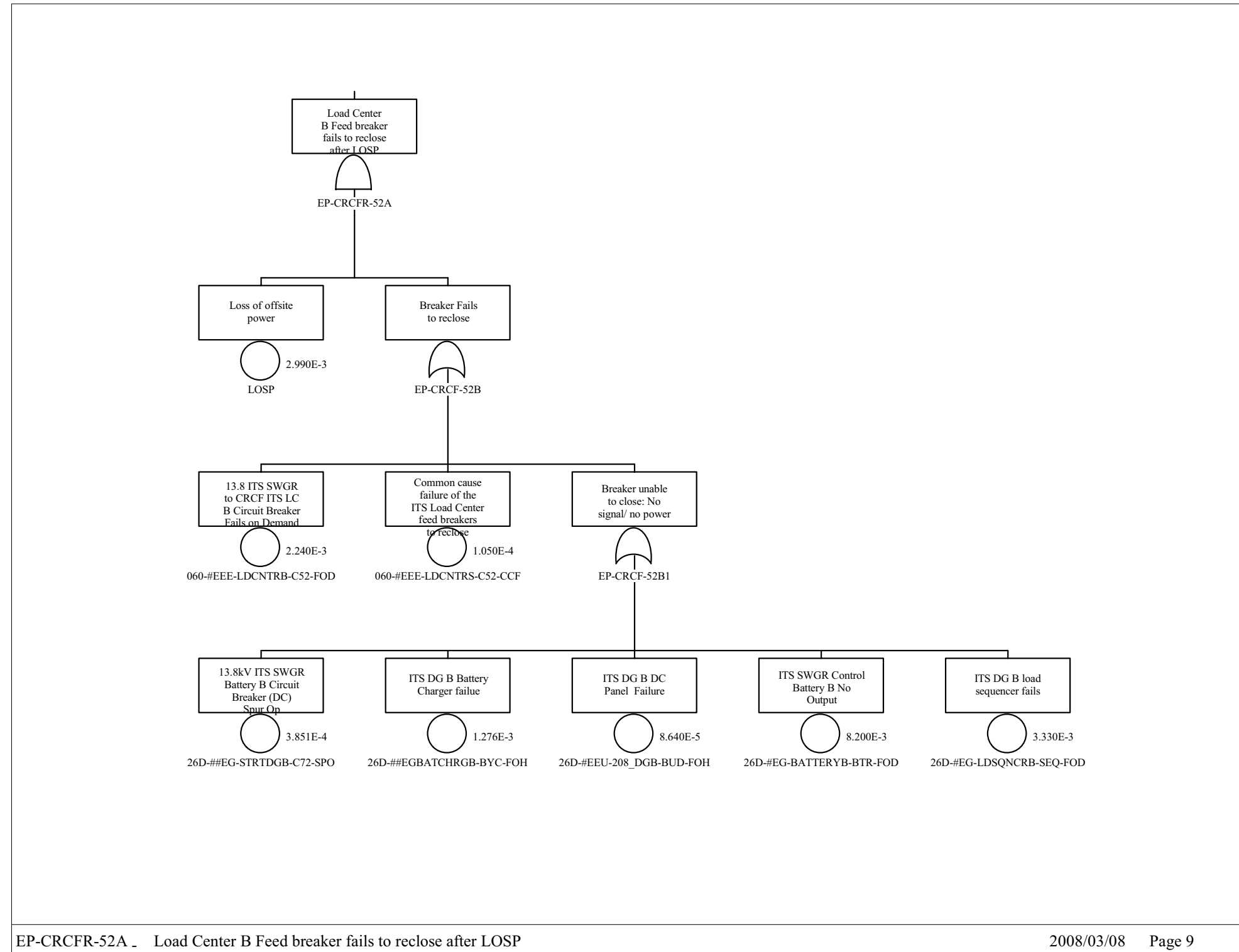

Source: Original

Figure B8.4-18. Loss of Power to CRCF ITS
Load Center Train B Sheet 2

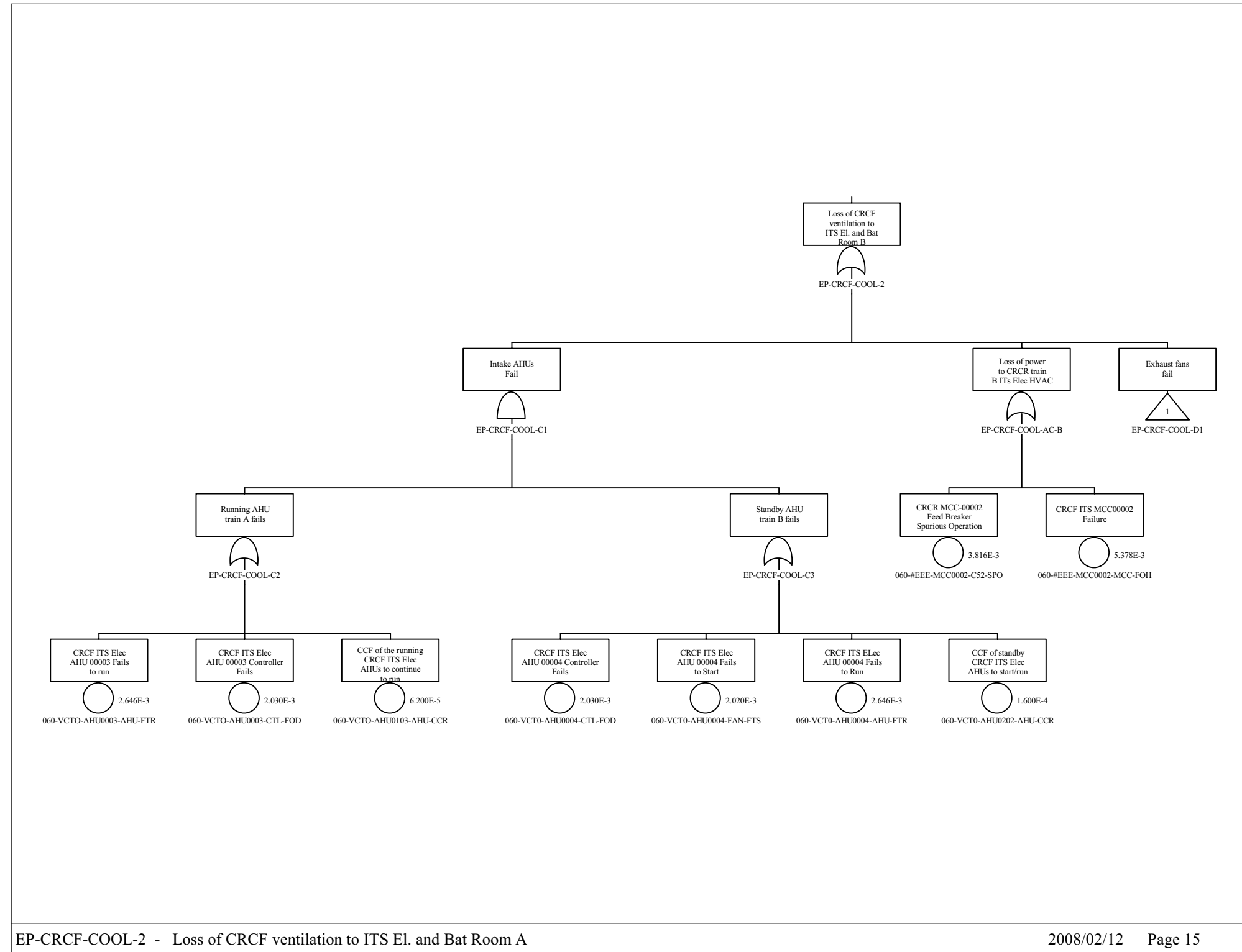

Source: Original

Figure B8.4-19. Loss of Power to CRCF ITS
Load Center Train B Sheet 3

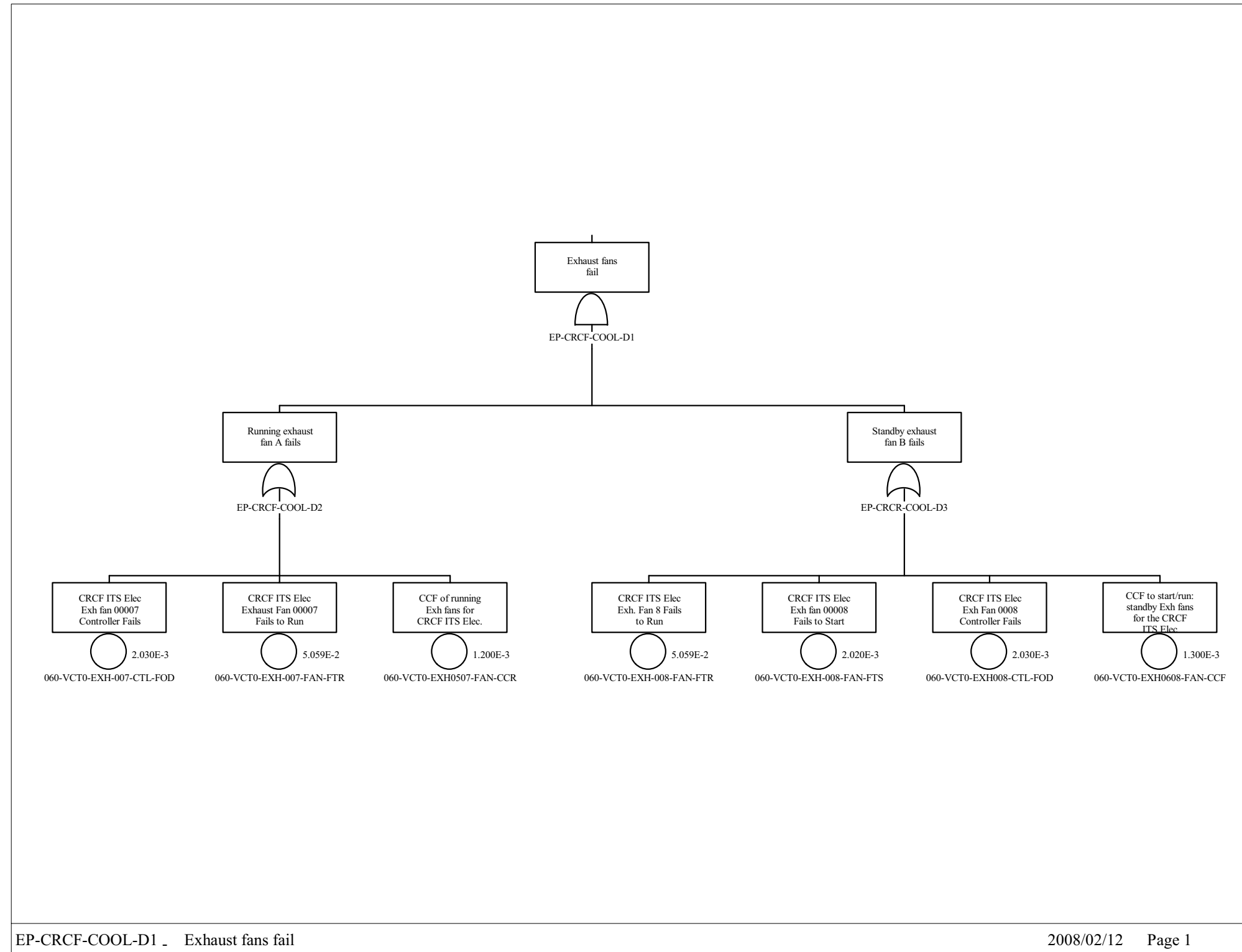

Source: Original

Figure B8.4-20. Loss of Power to CRCF ITS
Load Center Train B Sheet 4

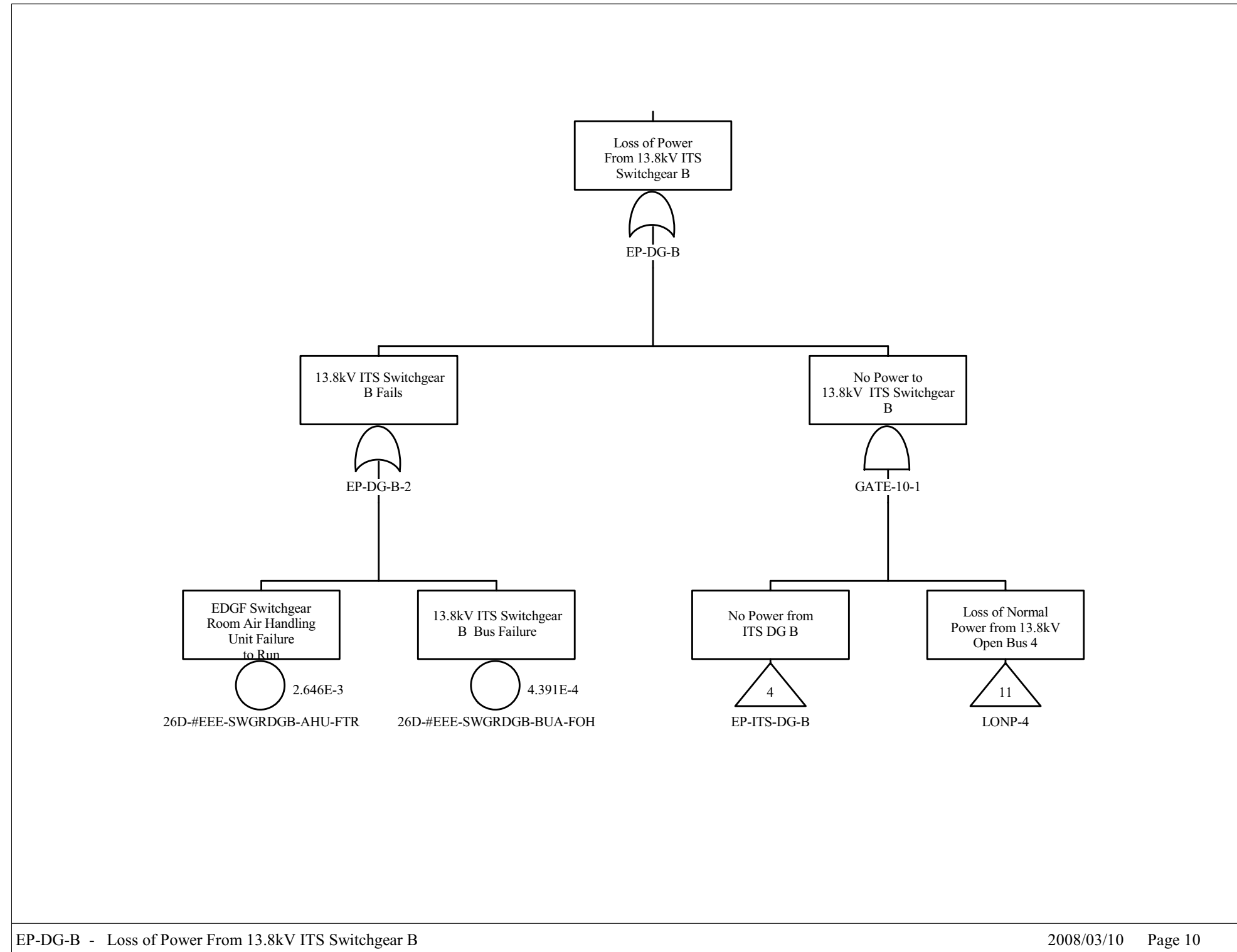

Source: Original

Figure B8.4-21. Loss of AC Power to CRCF ITS Load Center Train B Sheet 5

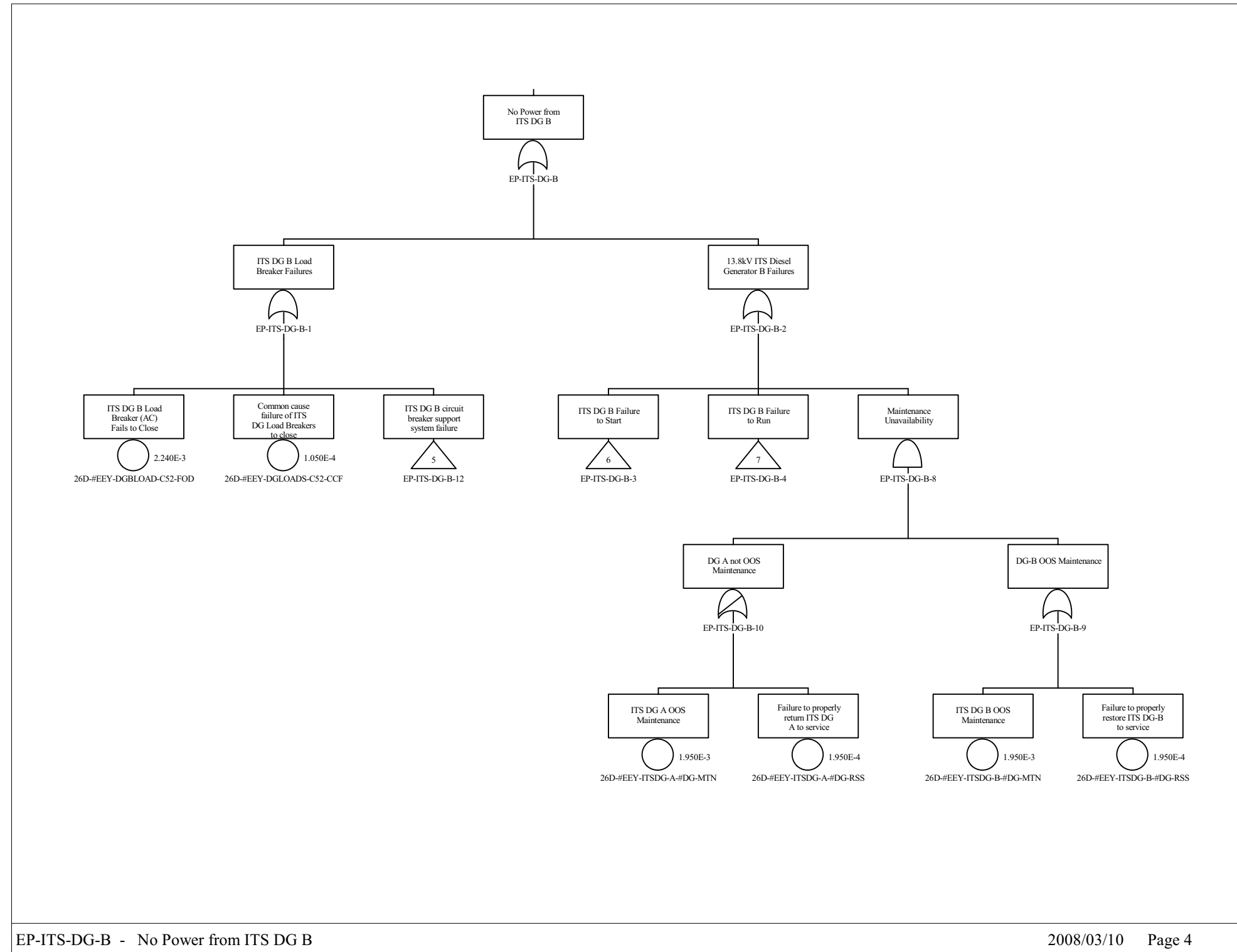

Source: Original

Figure B8.4-22. Loss of AC Power to CRCF ITS
Load Center Train B Sheet 6

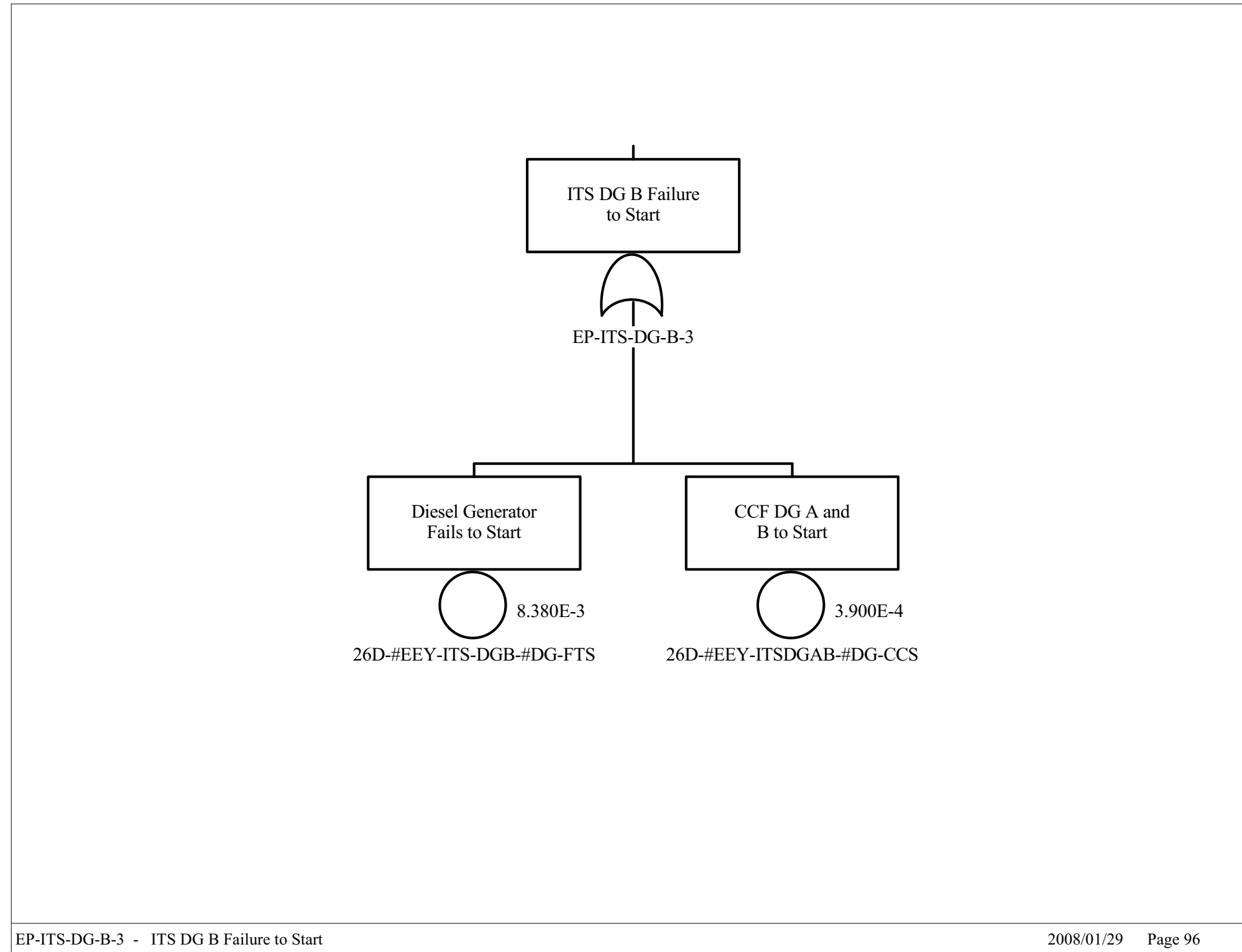

Source: Original

Figure B8.4-23. Loss of AC Power to CRCF ITS
Load Center Train B Sheet 7

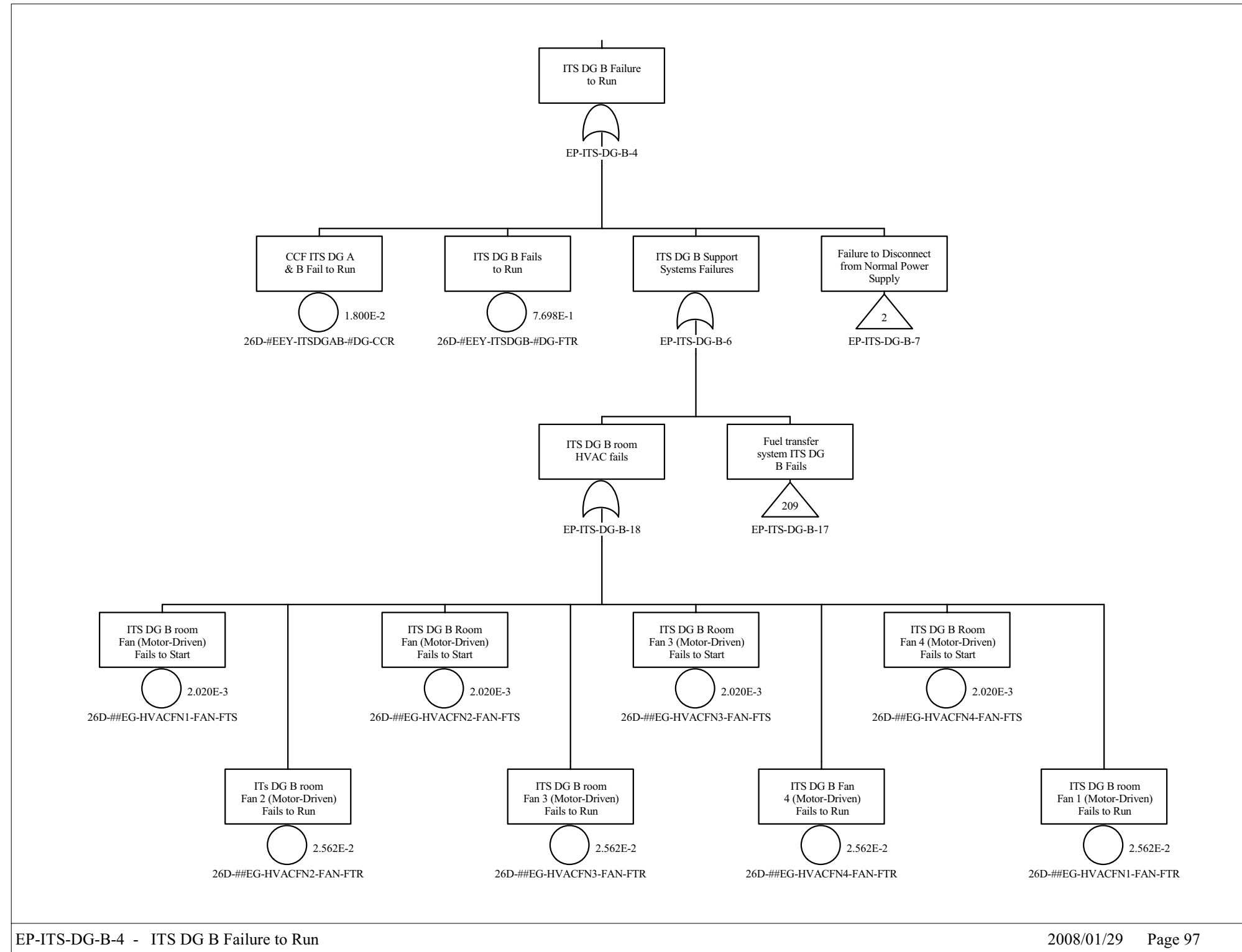

Source: Original

Figure B8.4-24. Loss of AC Power to CRCF ITS
Load Center Train B Sheet 8

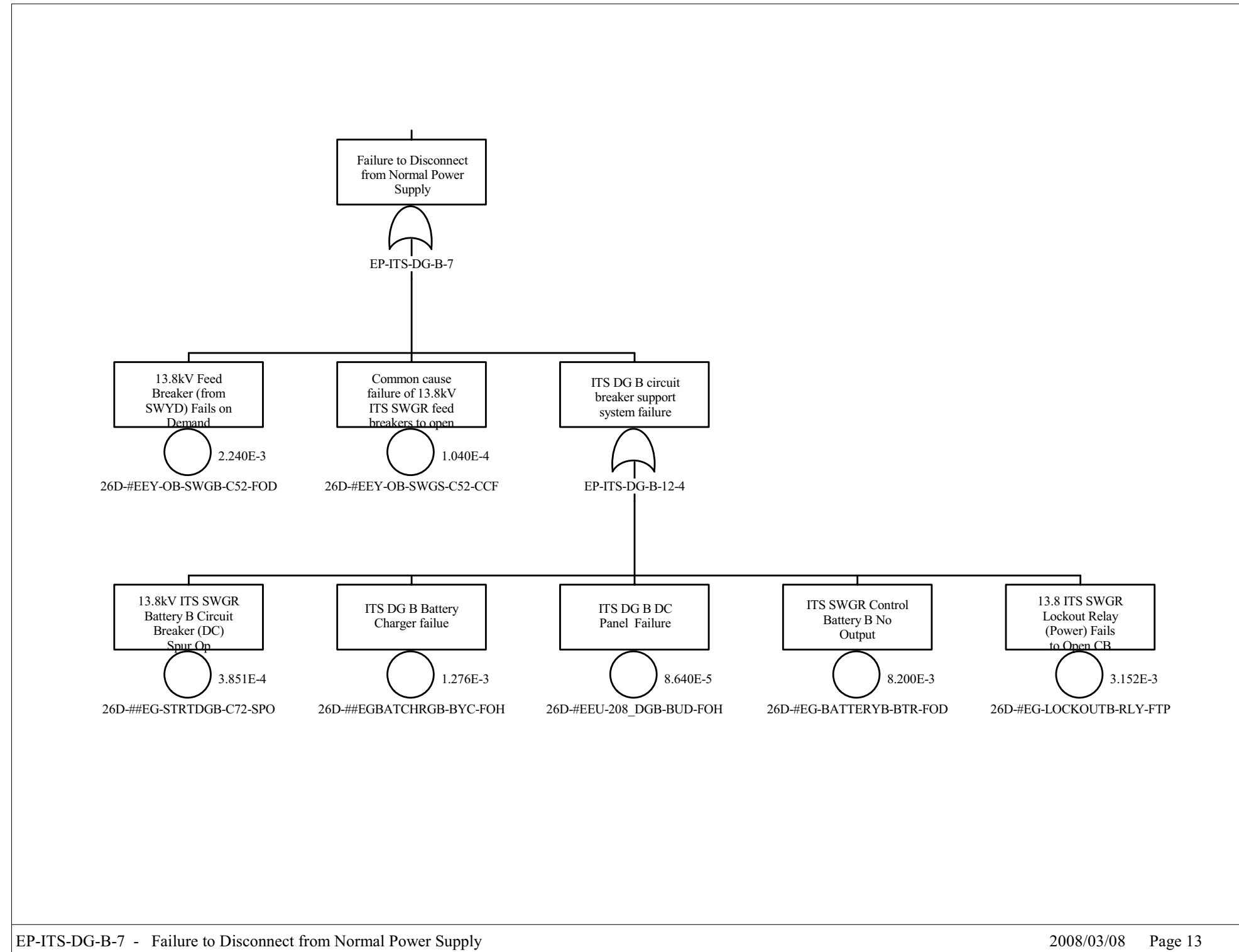

Source: Original

Figure B8.4-25. Loss of AC Power to CRCF ITS Load Center Train B Sheet 9

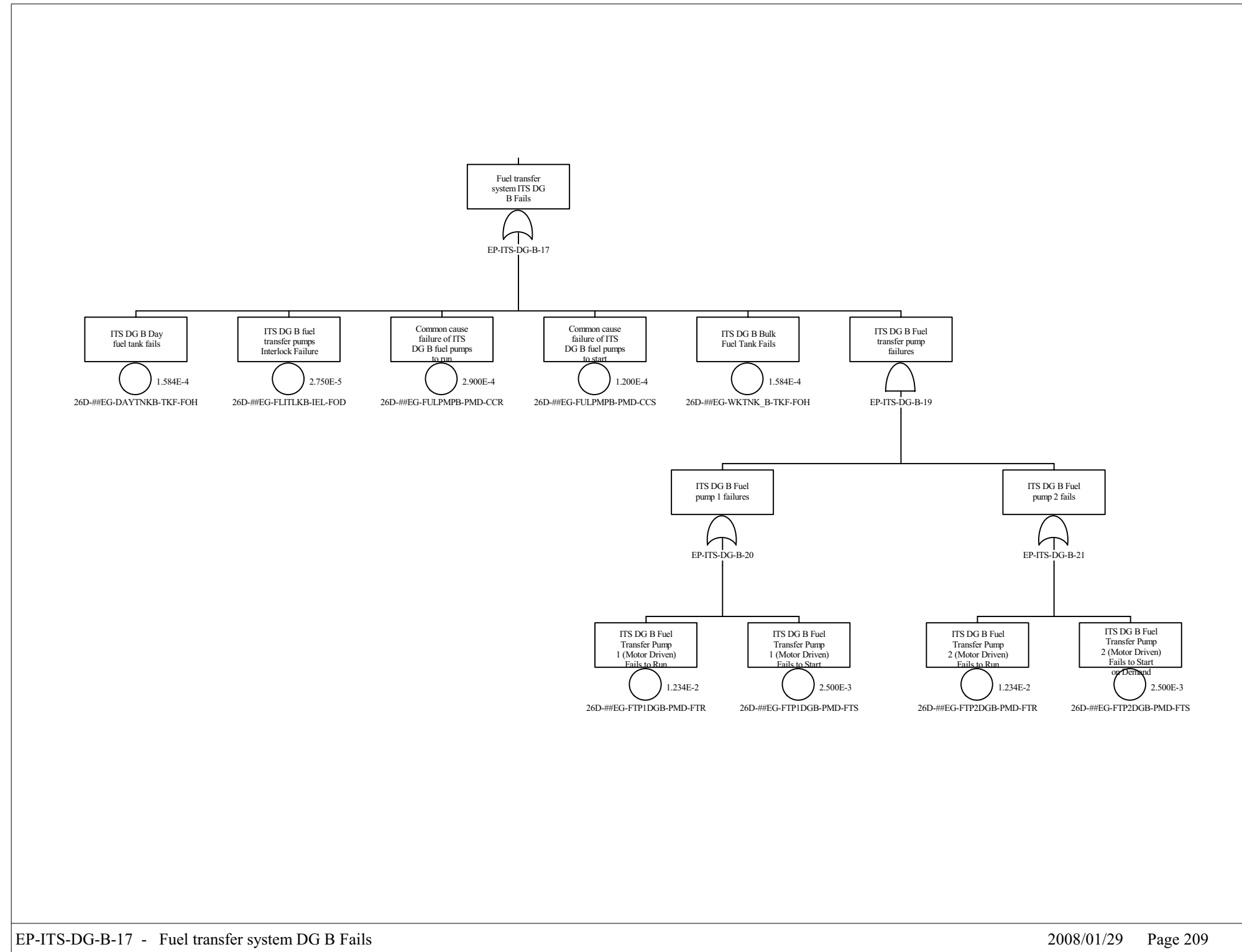

Source: Original

Figure B8.4-26. Loss of AC Power to CRCF ITS Load Center Train B Sheet 10

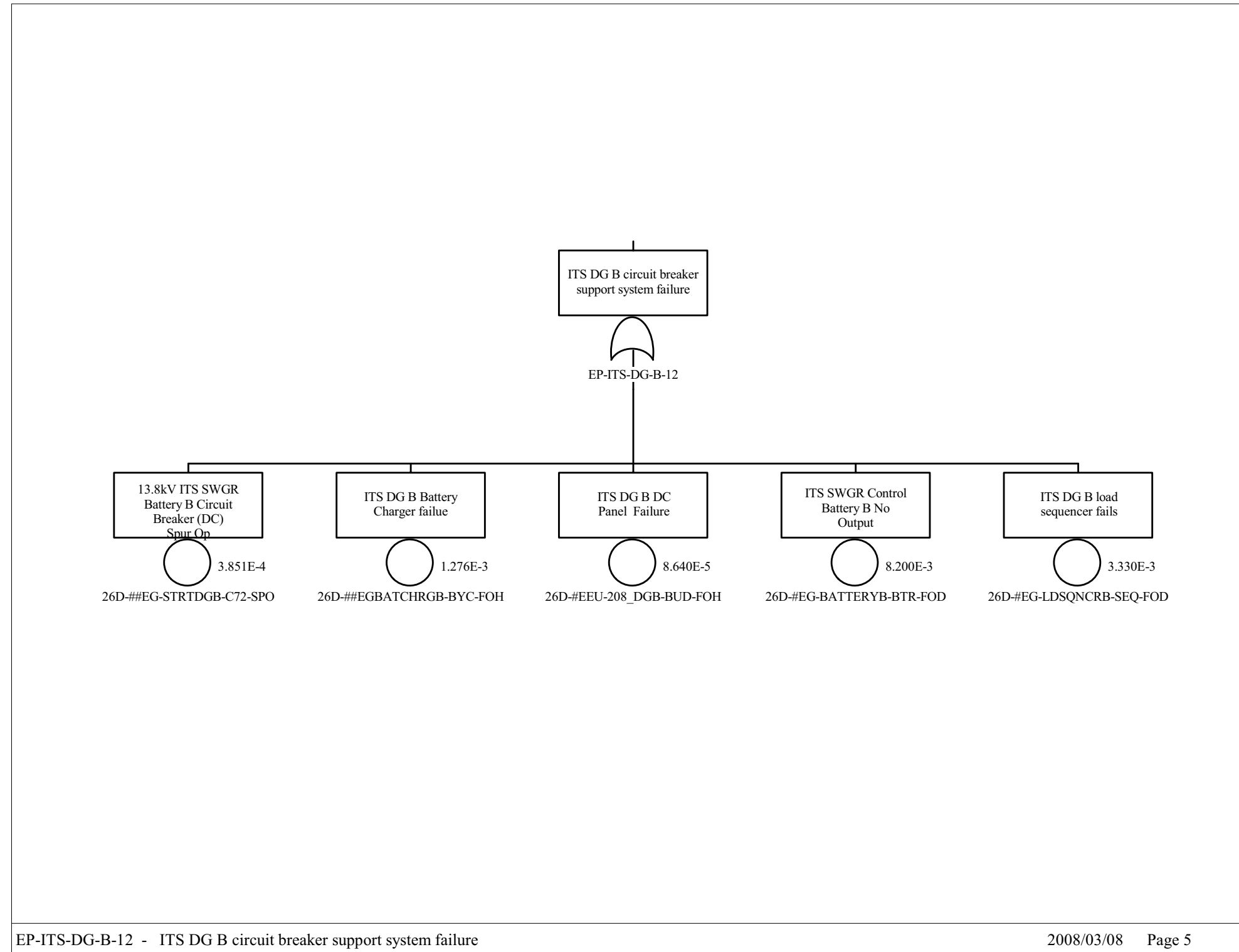

Source: Original

Figure B8.4-27. Loss of AC Power to CRCF ITS Load Center Train B Sheet 11

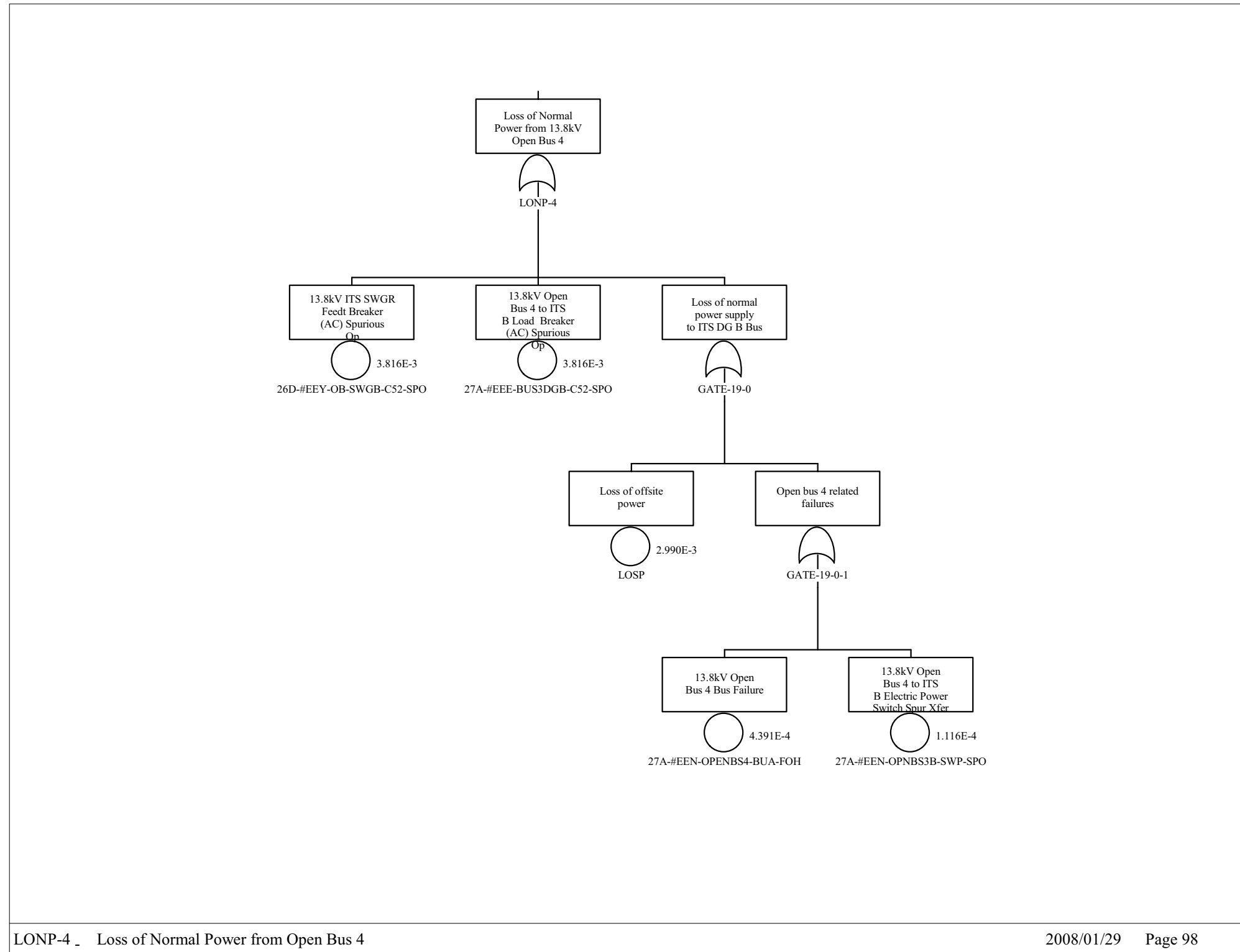

Source: Original

Figure B8.4-28. Loss of AC Power to CRCF ITS Load Center Train B Sheet 12

B9 PIVOTAL EVENT ANALYSIS

Miscellaneous linking fault trees that were not discussed in Attachment A are described in this section. Attachment A describes fault trees that provided links between the event trees and basic events, fault trees containing split fractions, and initiating event fault trees described in Attachment B. This section describes the remaining types of initiating event fault trees that do not fit into these categories.

There are eight types of fault trees discussed in this section: dropping an object onto a cask or waste package, impact to a cask by another vehicle or object, spurious movement of a crane causing impact to or tipover of a cask, loss of shielding leading to direct exposure, introduction of liquid moderator, shield door impact with a conveyance, failure of shielding due to collision of a moving shield door with a conveyance, and failure in a fire.

B9.1 FAULT TREES INVOLVING DROPPING AN OBJECT

These “drop-on” fault trees describe dropping an object onto a cask or a waste package and are listed in Table B9.1-1. A typical fault tree for drop of an object onto a transportation cask is shown in Figure B9.1-1, and a fault tree for dropping an object onto a waste package is shown in Figure B9.1-2.

Table B9.1-1. Drop-On Fault Trees

Fault Tree Name	Applies to ESD	Applies To Waste Type	Number of Objects Lifted
060-3-200T-CRANE-DROPON	ESD-3	DPC transportation cask DSNF transportation cask HLW transportation cask MCO transportation cask TAD transportation cask	3 3 3 3 3
ESD4-DPC-DROPON	ESD-4	DPC transportation cask	3
ESD4-DSNF-DROPON	ESD-4	DSNF transportation cask	1
ESD4-HLW-DROPON	ESD-4	HLW transportation cask	1
ESD4-MCO-DROPON	ESD-4	MCO transportation cask	1
ESD4-TAD-DROPON	ESD-4	TAD transportation cask	1
ESD11-WP-H&D-DROPON	ESD-11	WP with HLW & DSNF	2
ESD11-WP-H&M-DROPON	ESD-11	WP with HLW & MCO	2
ESD11-WP-TAD-DROPON	ESD-11	WP with TAD canister	2
060-15-WP-CRANE-DROPON	ESD-15	WP with HLW & DSNF WP with HLW & MCO WP with TAD canister	1 1 1

NOTE: DSNF = DOE spent nuclear fuel; DPC = dual-purpose canister, ESD = event sequence diagram; HLW = high-level radioactive waste; MCO = multiccanister overpack; TAD = transportation, aging and disposal; WP = waste package,

Source: Original

In Figure B9.1-1 the 200-ton crane may drop a lifting fixture or lid onto the transportation cask from a normal height or from a much higher than normal height due to a two-blocking event. The probabilities of crane drops are based on historical data discussed in Section 6.3 and Attachment C. The calculated probability of a crane dropping an object on a cask is 3.24E-005 for one object lifted.

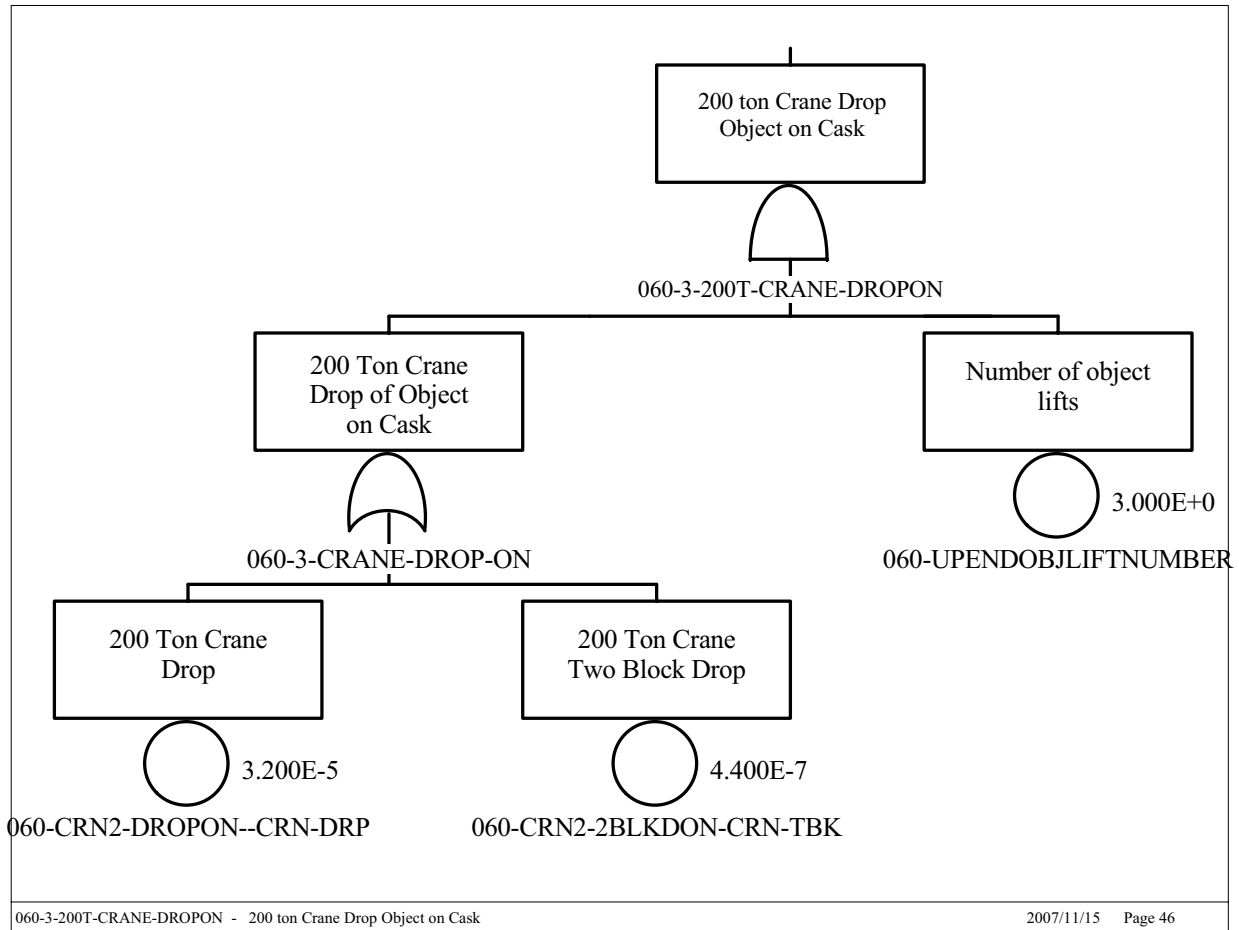

Source: Original

Figure B9.1-1. Typical 200-Ton Crane Drop-On Fault Tree

In Figure B9.1-2 the remote handling system crane (RHS) may drop the inner or outer waste package lids onto the waste package from a normal height or from a much higher than normal height due to a two-blocking event. The probabilities of crane drops are based on historical data discussed in Section 6.3 and Attachment C. The calculated probability of the RHS dropping one object on a cask is 1.450E-004.

The data for the 200-ton cranes with or without the use of slings is based on operational experience of cranes designed to be single failure proof (SFP). However, the mobile cranes used with the waste packages were presumed to be not single failure proof.

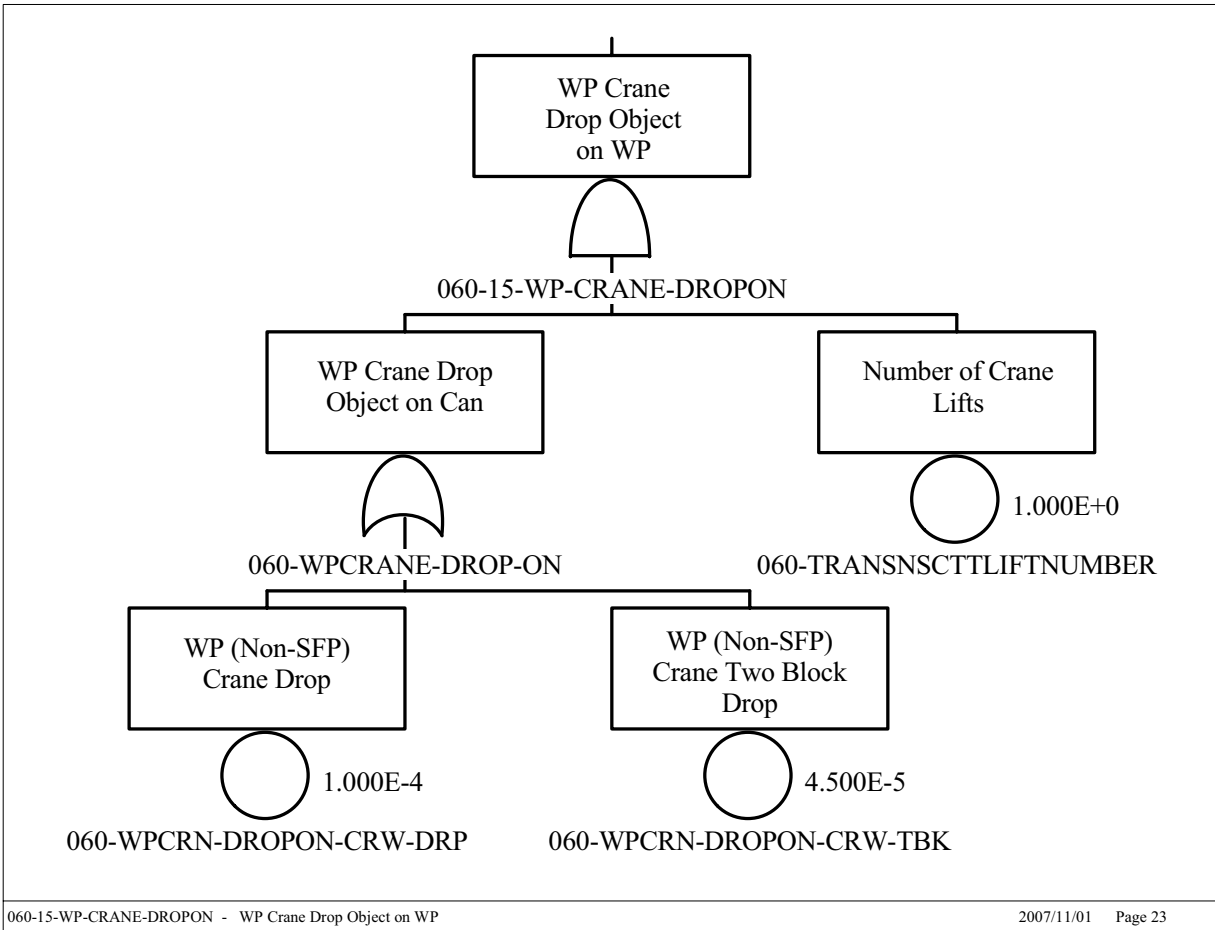

Source: Original

Figure B9.1-2. Typical RHS Crane Drop-On Fault Tree

B9.2 IMPACT TO A CASK BY ANOTHER VEHICLE OR OBJECT

These trees involve side impacts to the transportation cask by another vehicle or object. Table B9.2-1 lists the fault trees that describe these impacts.

Table B9.2-1. Transportation Cask Impact Fault Trees

Fault Tree Name	Applies To
060-3-DPC-TC-IMPACT	DPC transportation cask
060-3-DSNF-TC-IMPACT	DSNF and MCO transportation cask
060-3-HLW-TC-IMPACT	HLW transportation cask
060-3-TAD-TC-IMPACT	TAD canister transportation cask
ESD4-DPC-IMPACT	DPC transportation cask
ESD4-DSNF-IMPACT	DSNF transportation cask
ESD4-HLW-IMPACT	HLW transportation cask
ESD4-MCO-IMPACT	MCO transportation cask
ESD4-TAD-IMPACT	TAD canister transportation cask
060-5-ST-IMPACT	TAD canister in AO
ESD9-DPC-SIMPACT	DPC canister in CTM
ESD9-DSNF-SIMPACT	DSNF canister in CTM
ESD9-HLW-SIMPACT	HLW canister in CTM
ESD9-MCO-SIMPACT	MCO canister in CTM
ESD9-TAD-SIMPACT	TAD canisters in CTM
060-12-ST-IMPACT	DPC in AO TAD canister in AO

NOTE: AO = aging overpack; DPC = dual-purpose canister; DSNF = U.S. Department of Energy spent nuclear fuel; HLW = high-level radioactive waste; MCO = multiccanister overpack; TAD = transportation, aging, and disposal canister.

Source: Original

Figure B9.2-1 illustrates a side impact to a transportation cask that may occur due to the following operator errors:

- Operator causing impact by the crane or object being carried by the crane
- Operator impacting a vehicle (such as a forklift) into the cask at the design speed
- Operator causing a forklift impact at higher than the design speed coupled with failure of the forklift speed control.

The calculated probability of impact to the transportation cask is 6.12E-003.

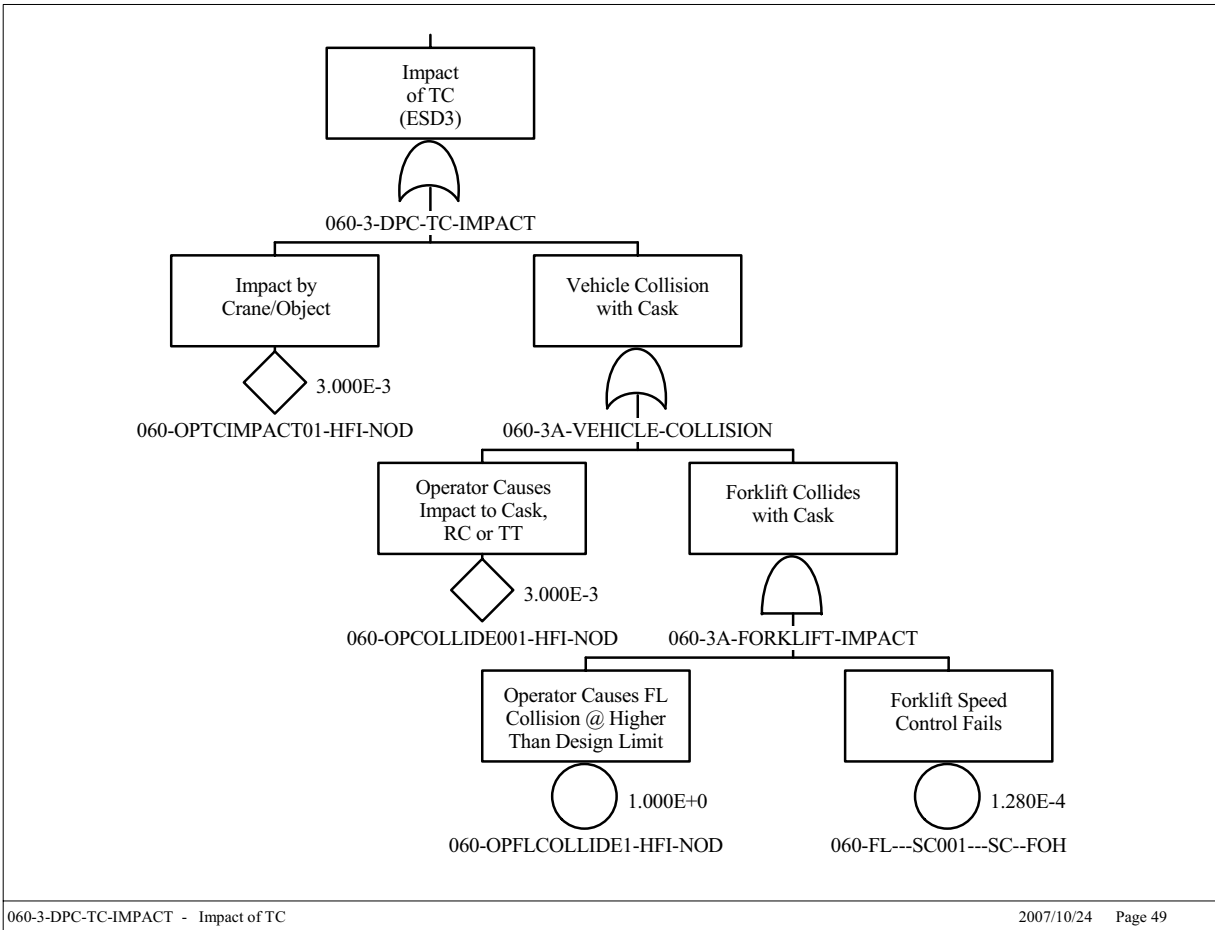

Source: Original

Figure B9.2-1. Typical Side Impact Fault Tree

Figures B9.2-2 and B9.2-3 are identical to Figure 9.2-1 except for the addition of another cause of a side impact; the spurious movement of the CTT or the site transporter during cask loading which is described in Attachment B. The calculated probability of impact to the transportation cask with CTT spurious movement is 6.24E-003 and with site transporter spurious movement is 6.38E-003.

Figure B9.2-4 illustrates a side impact to a canister that may occur due to a CTM collision. The calculated probability of impact to the canister depends on the number of lifts and is 3.9E-006 for a single lift.

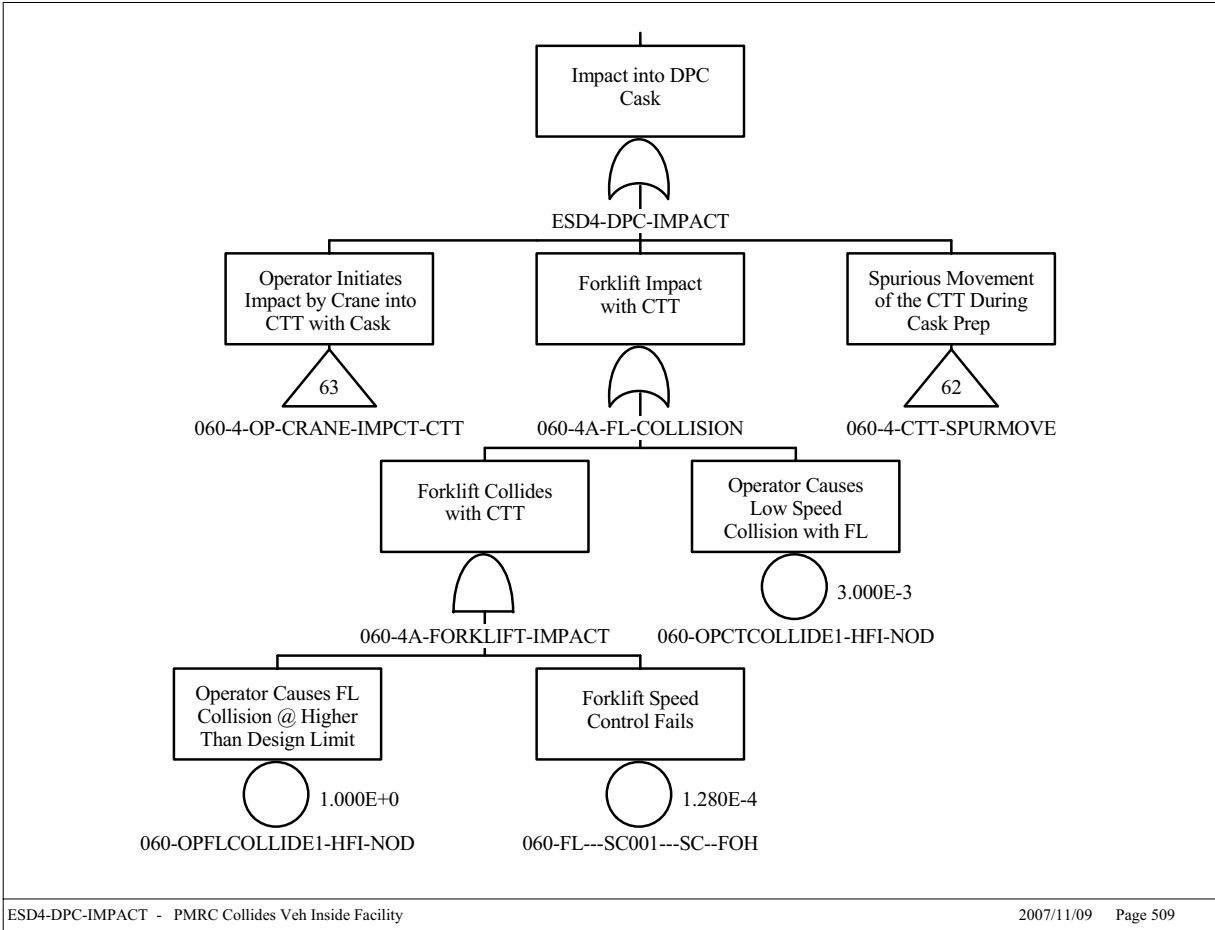

Source: Original

Figure B9.2-2. Typical Side Impact with Spurious Movement of CTT Fault Tree

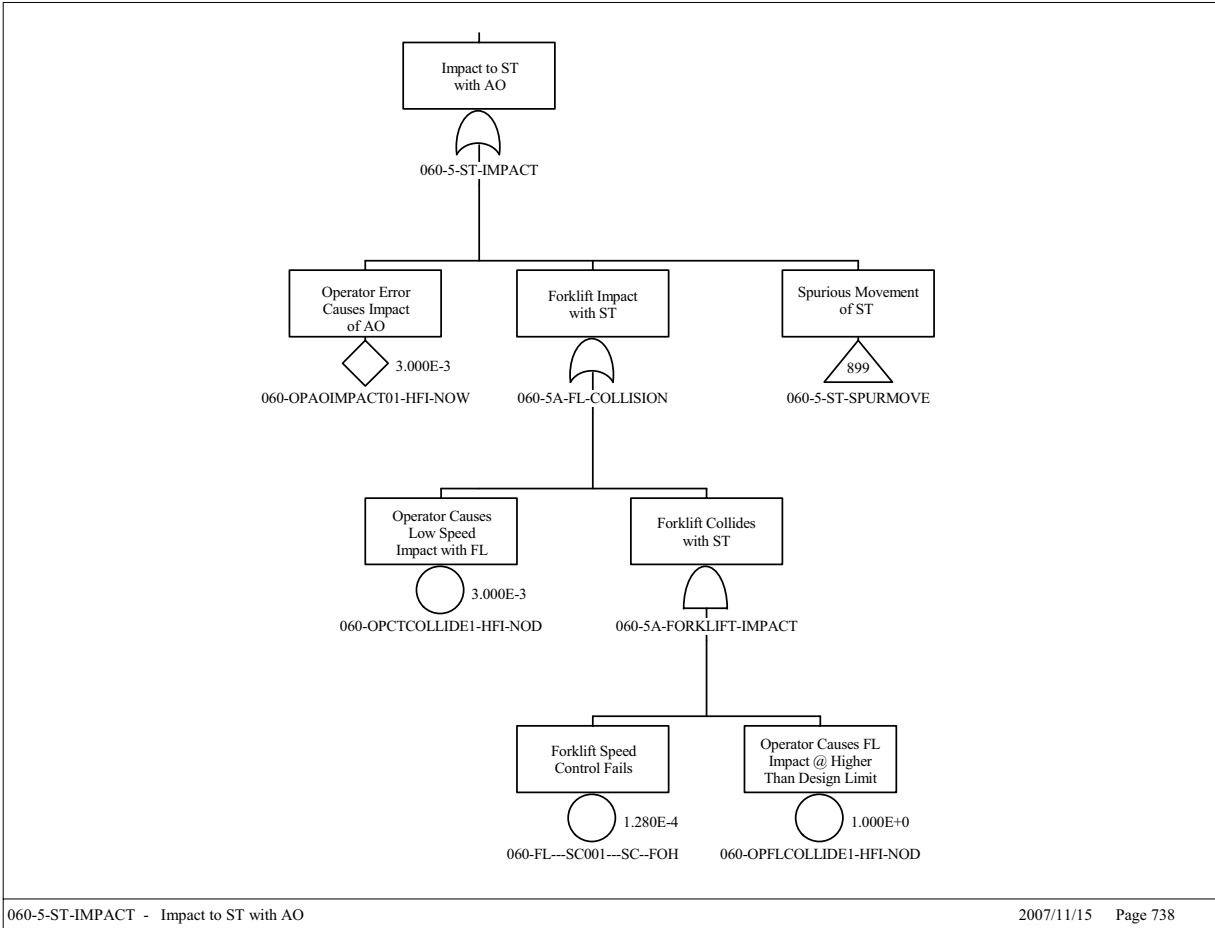

Source: Original

Figure B9.2-3. Typical Side Impact with Spurious Movement of Site Transporter Fault Tree

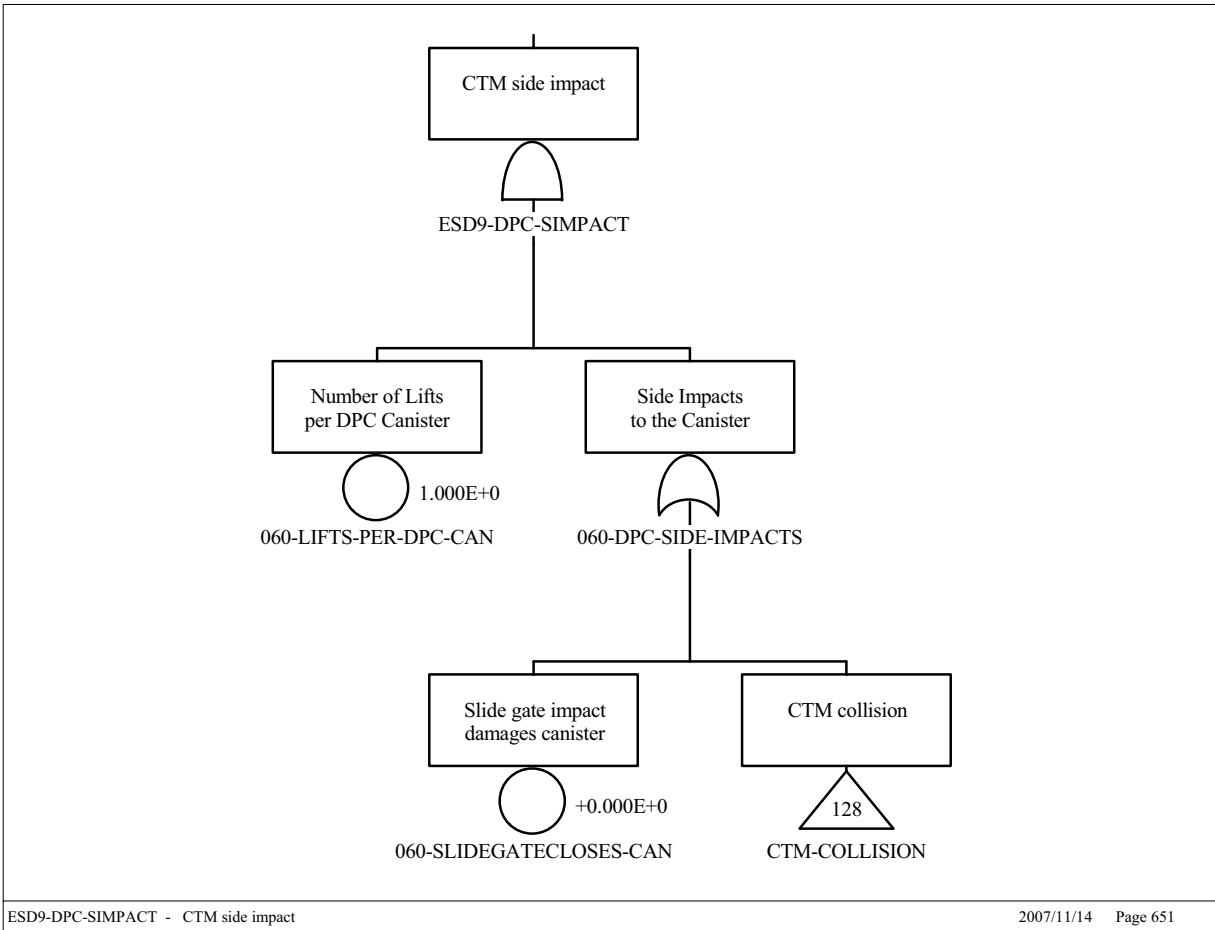

Source: Original

Figure B9.2-4. Typical Side Impact to Canister with CTM Collision Fault Tree

B9.3 IMPACT TO A CASK DUE TO SPURIOUS MOVEMENT

These trees involve impacts to or tip over of the transportation cask due to operator error or spurious movements of the crane, CTT or site transporter. Table B9.3-1 lists the fault trees that describe these impacts.

Table B9.3-1. Transportation Cask Impact or Tipover Fault Trees

Fault Tree Name	Applies To
ESD2-AO-ROLLOVER	TAD canister in AO
060-3-DPC-TC-SPURMOVE	DPC transportation cask
060-3-DSNF-TC-SPURMOVE	DSNF & MCO transportation cask
060-3-HLW-TC-SPURMOVE	HLW transportation cask
060-3-TAD-TC-SPURMOVE	TAD canister transportation cask
ESD4-DPC-TIP	DPC transportation cask
ESD4-DSNF-TIP	DSNF transportation cask
ESD4-HLW-TIP	HLW transportation cask
ESD4-MCO-TIP	MCO transportation cask
ESD4-TAD-TIP	TAD canister transportation cask
060-3-CRANE-SPURMOVE	DPC transportation cask DSNF transportation cask HLW transportation cask MCO transportation cask TAD canister transportation cask
ESD9-DPC-SPUR	Waste package with DPC
ESD9-DSNF-SPUR	Waste package with DSNF
ESD9-HLW-SPUR	Waste package with HLW
ESD9-MCO-SPUR	Waste package with MCO
ESD9-TAD-SPUR	Waste package or AO with TAD canister

NOTE: AO = aging overpack; DPC = dual-purpose canister; DSNF = U.S. Department of Energy spent nuclear fuel; HLW = high-level radioactive waste; MCO = multiccanister overpack; TAD = transportation, aging, and disposal canister.

Source: Original

Figure B9.3-1 describes a rollover of a site transporter carrying an aging overpack or drop of an aging overpack from a site transporter. Fault trees for site transporter rollover and aging overpack drop are described in Attachment B6. The calculated probability of a rollover or drop is 2.46E-006.

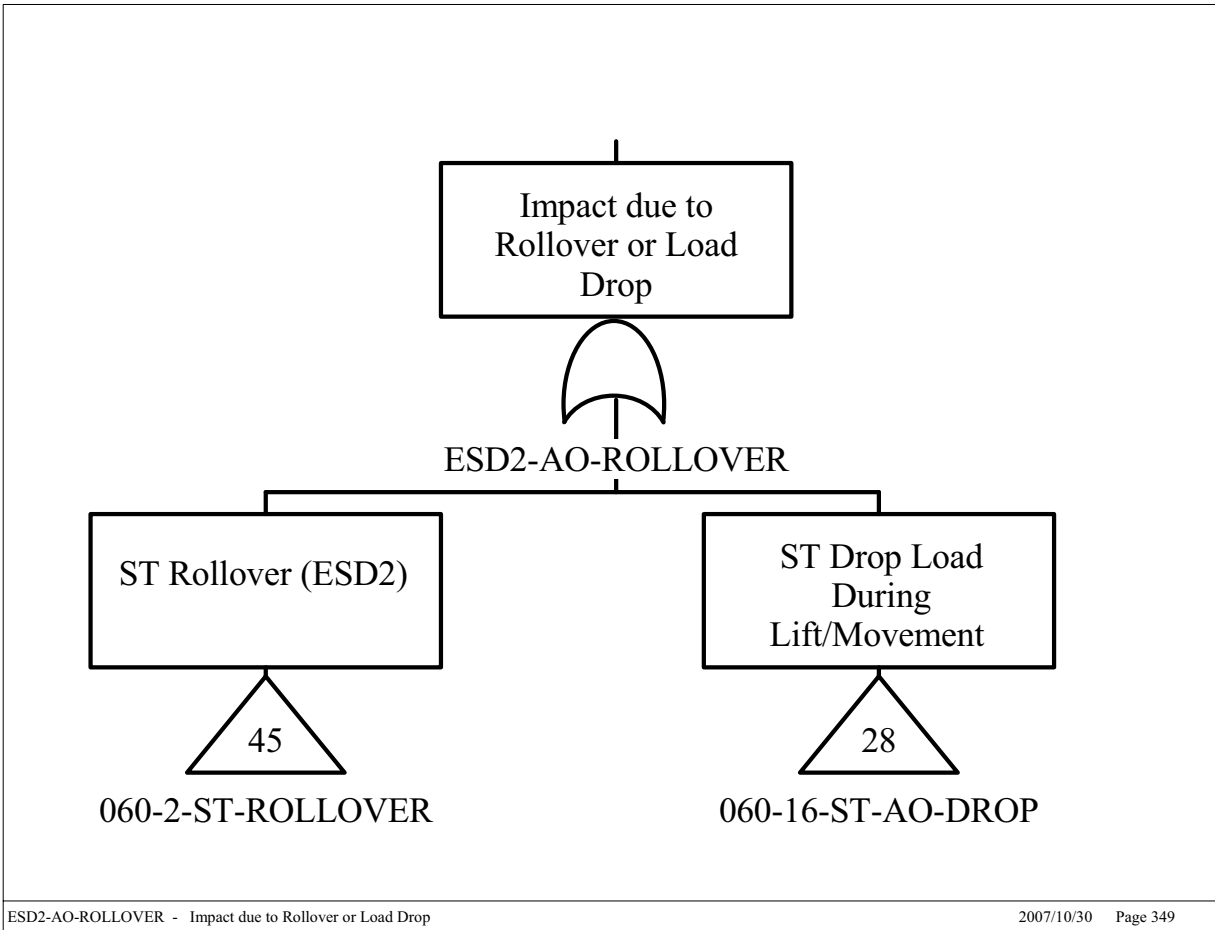

Source: Original

Figure B9.3-1. Impact due to Site Transporter Rollover or Aging Overpack Drop

Figure B9.3-2 describes an impact to a cask due to spurious movement of the CTT during loading or spurious movement of the crane. The fault tree for spurious movement of the CTT is described in Attachment B2. Spurious movement of the crane fault tree is shown in Figure B9.3-3. Spurious movement of the crane may occur due to failure of either the crane bridge or hoist motor to shut off, or spurious signals from the crane bridge motor PLC. The calculated probability of an impact due to spurious movement of the carrier is 3.94E-007.

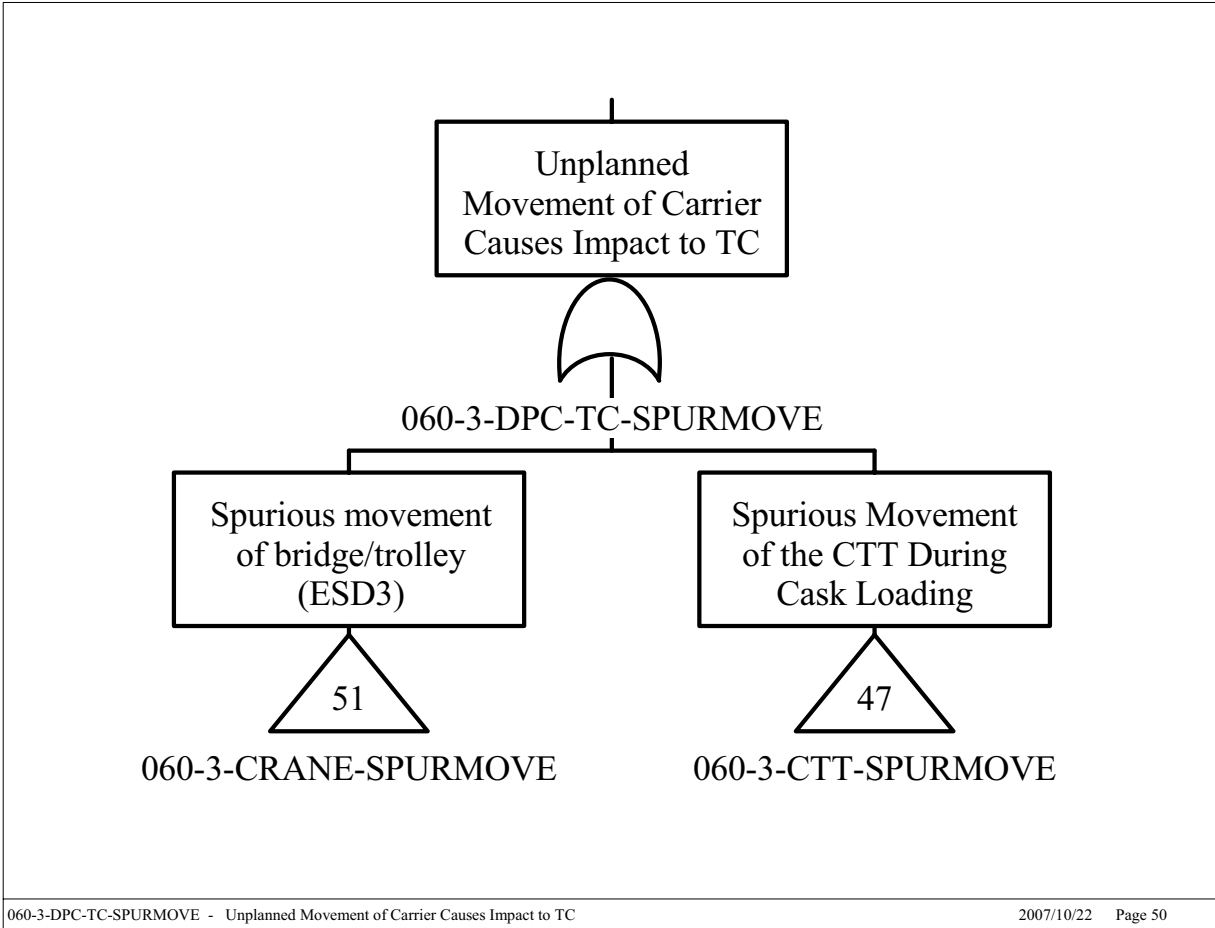

Source: Original

Figure B9.3-2. Spurious Movement of the Crane or CTT Fault Tree

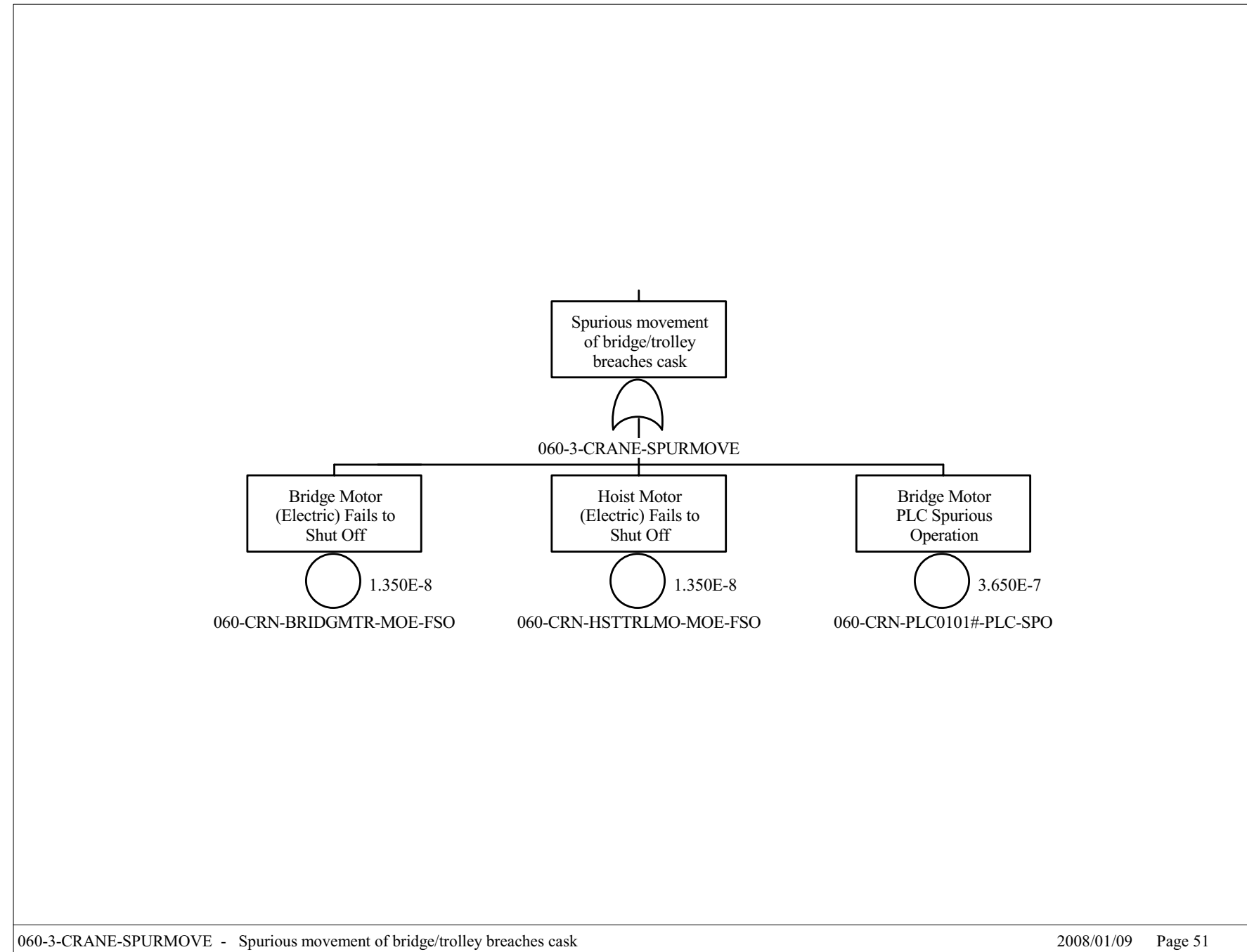

Source: Original

Figure B9.3-3. Spurious Movement of the Crane Fault Tree

Impacts due to tipover may be caused by operator error or spurious movement of the crane as shown in Figure B9.3-4. The calculated probability of a tipover is 1.00E-4 due to the over-riding influence of operator error causing the tipover.

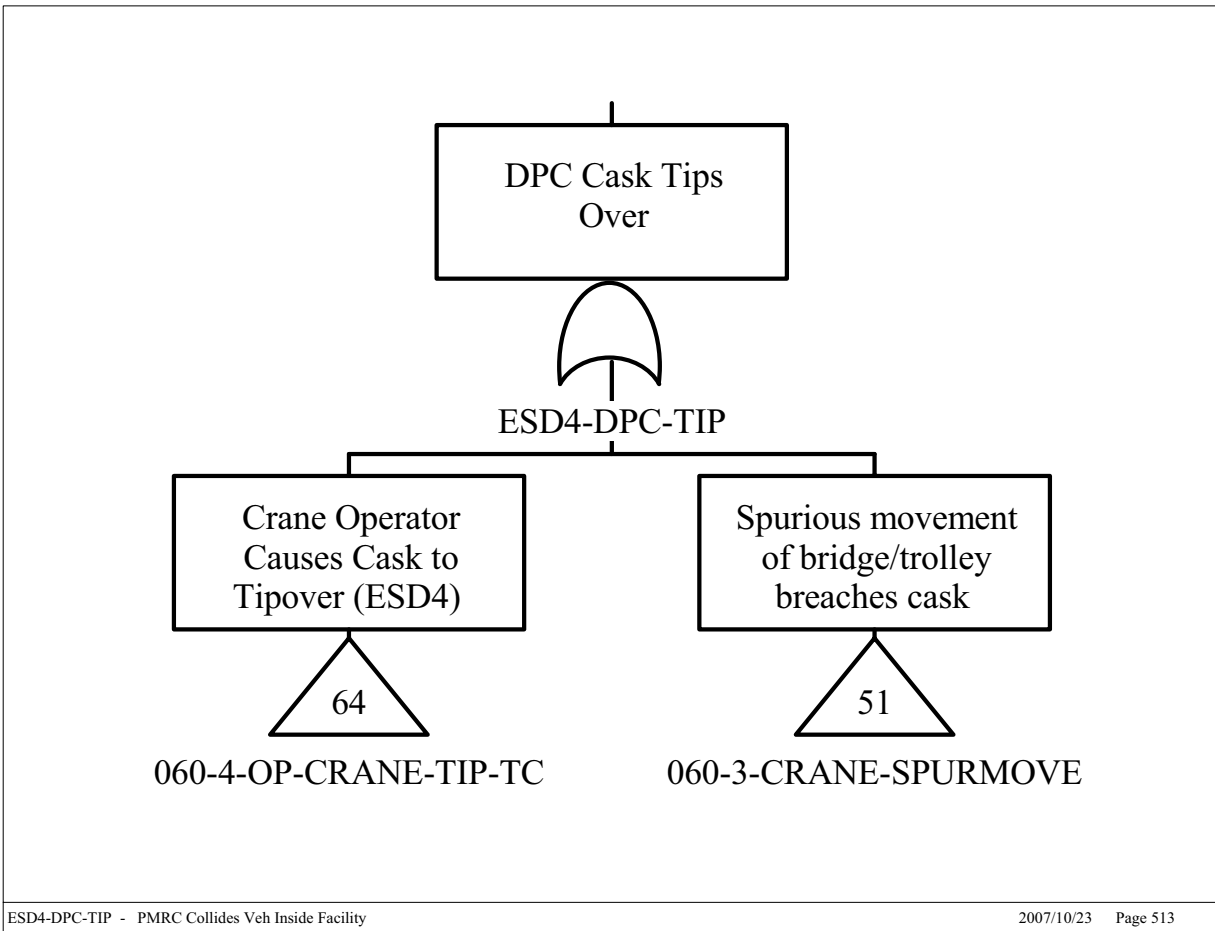

Source: Original

Figure B9.3-4. Typical Tipover Fault Tree

Figure B9.3-5 illustrates the fault tree for impact to a canister caused by spurious movement of the CTT during unloading of the transportation cask, the site transporter during loading of the aging overpack, or the CTM during transfer of the DPC canister. The calculated probability of an impact due to spurious movement of the carriers is 6.92E-009.

Figure B9.3-6 illustrates the fault tree for impact to a canister caused by spurious movement of the CTT during unloading of the transportation cask, the WPTT during loading of the WP, or the CTM during transfer of the canister. The calculated probability of an impact due to spurious movement of the carriers is 6.92E-009.

Because a TAD may be in a transportation cask on a CTT or in an aging overpack on a site transporter, a split fraction fault tree is required as shown in Figure B9.3-7. The calculated probability of an impact due to spurious movement of the carriers is also 6.92E-009

The fault trees for spurious movement of these components are described in their respective sections of Attachment B.

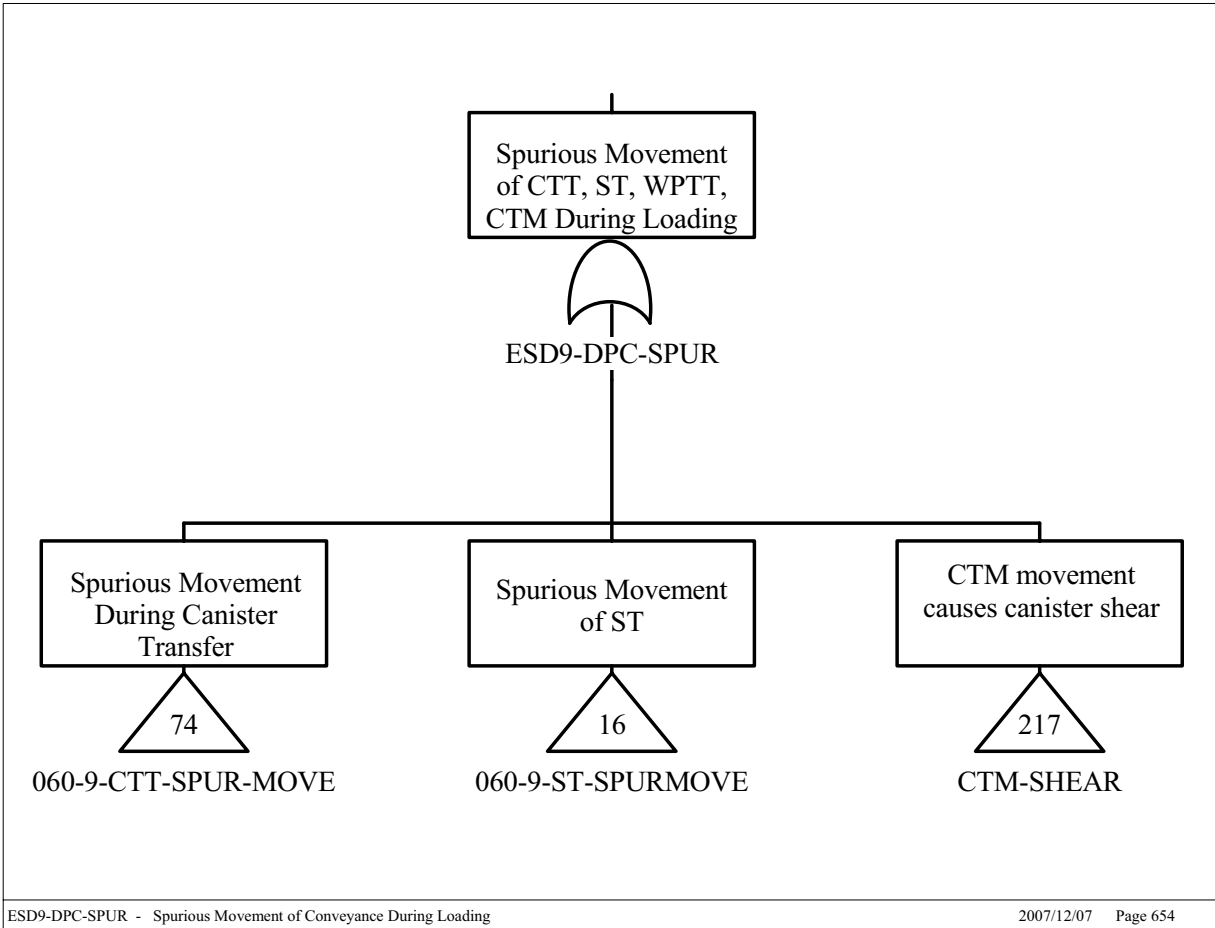

Source: Original

Figure B9.3-5. Fault Tree for Impact to a Canister due to Spurious Movement of the CTT, Site Transporter or CTM

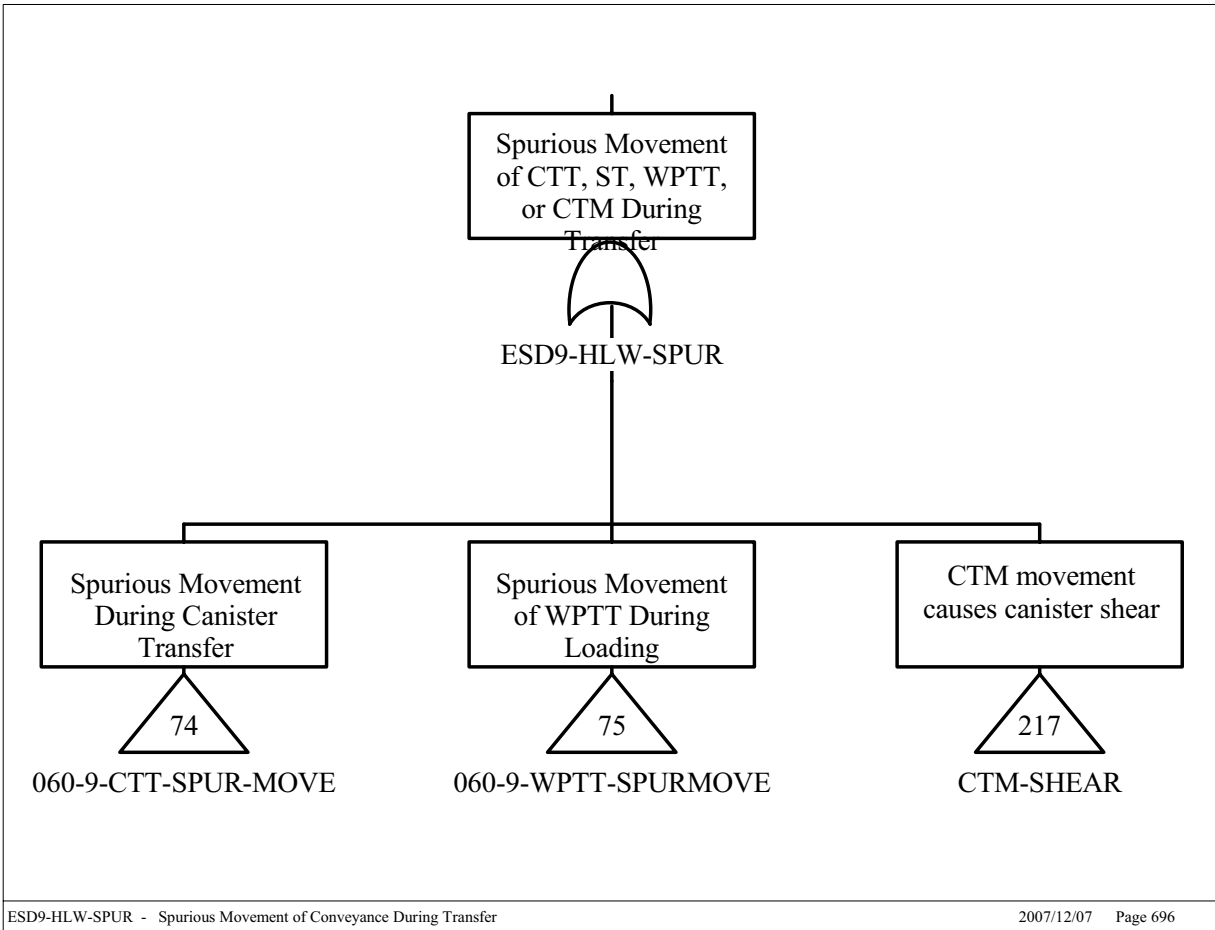

Source: Original

Figure B9.3-6. Fault Tree for Impact to a Canister due to Spurious Movement of the CTT, WPTT or CTM

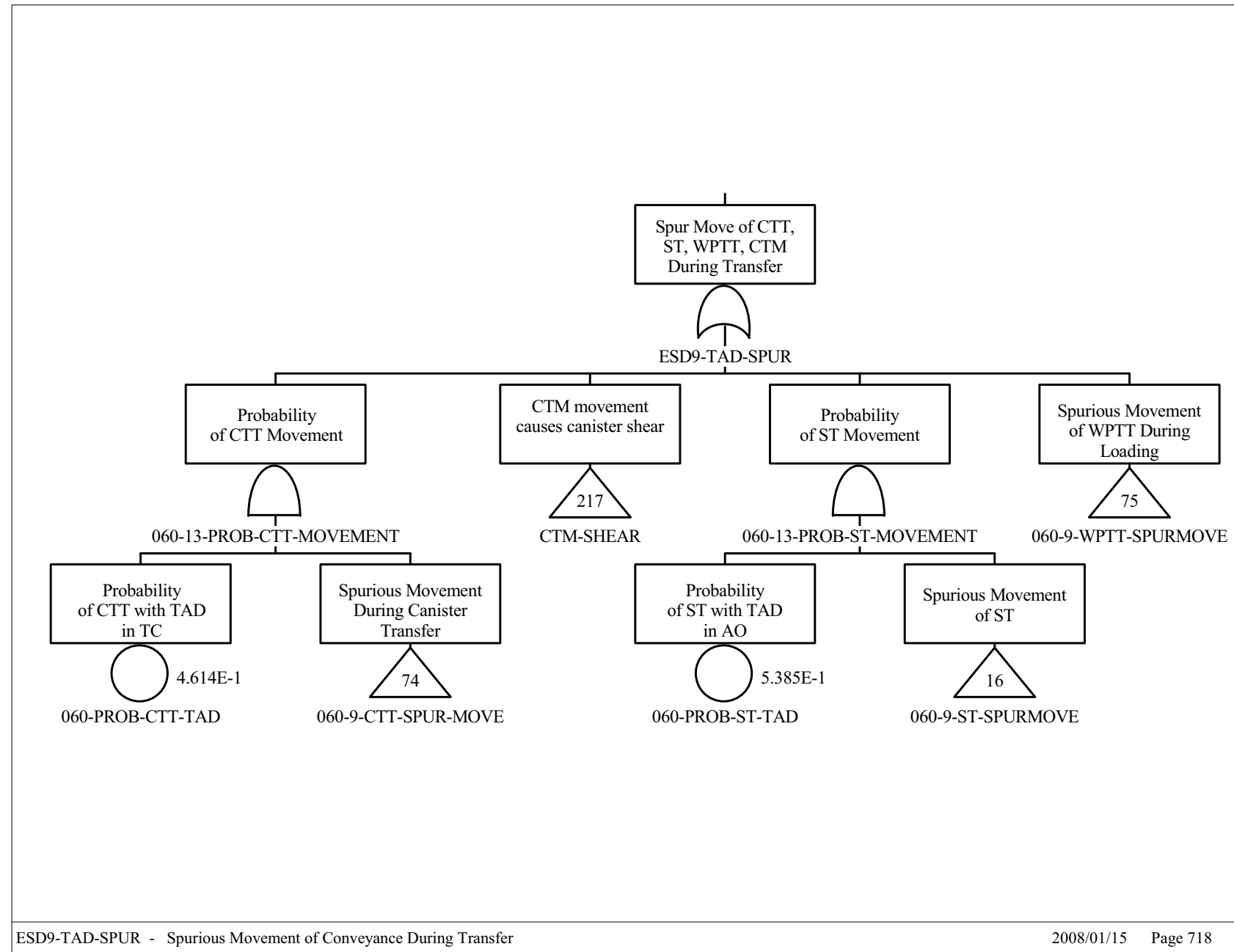

Source: Original

Figure B9.3-7. Fault Tree for Impact to a Canister due to Spurious Movement of the CTT, Site Transporter, WPTT or CTM during TAD Canister Transfer

B9.4 LOSS OF SHIELDING LEADING TO DIRECT EXPOSURE

These fault trees describe direct exposure during canister transfer or while closing the waste package. Table B9.4-1 lists the fault trees that describe these direct exposures.

Table B9.4-1. Direct Exposure Fault Trees

Fault Tree Name	Applies To
ESD18-TEMP-SHIELD-LOSS	All Canisters
ESD19-SHIELD-RING	All Canisters in WP

NOTE: WP = waste package

Source: Original

Figure B9.4-1 illustrates the potential causes of direct exposure during canister transfer. The potential causes include operator error coupled with interlock failures, and inadvertent opening of the shield door or slide gate. Fault trees for inadvertent opening of the shield door or slide gate are described in “Loading/Unloading Room Shield Door and Slide Gate Fault Tree Analysis” in Attachment B. The probability of shield loss is 1.062E-005.

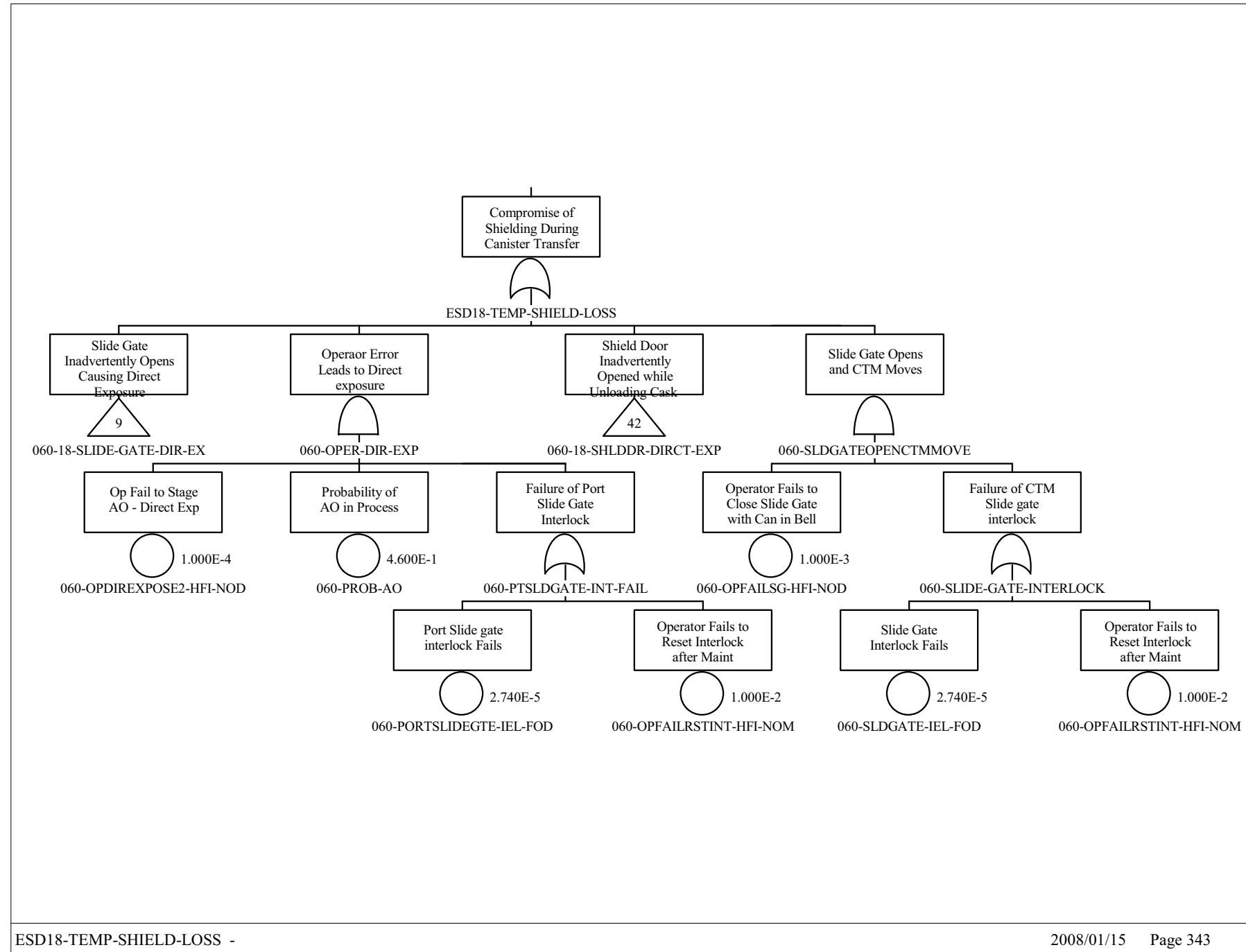

Source: Original

Figure B9.4-1. Typical Direct Exposure Fault Tree due to Shield Door or Slide Gate Opening

Figure B9.4-2 is a fault tree for direct exposure from a waste package that has been improperly closed or shielded with a probability of 2.100E-05. The causes are improper installation of the inner lid or improper installation of the shield ring due to operator error.

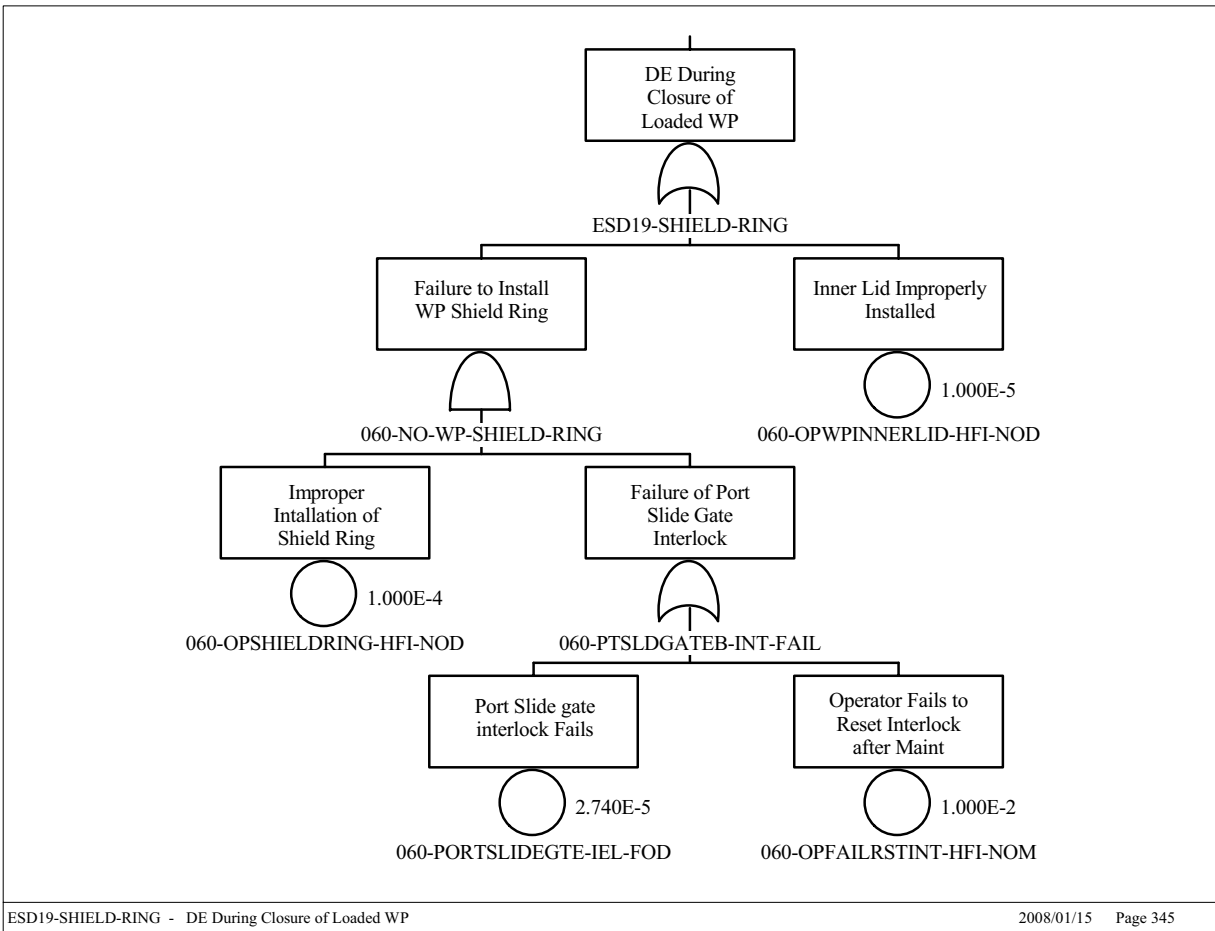

Source: Original

Figure B9.4-2. Typical Direct Exposure Fault Tree due to Improper Shielding of the Waste Package

B9.5 MODERATOR SOURCE

Internal floods are potential sources of moderator addition into a canister associated with pivotal events in the event sequences included in Section 6.1. Moderator addition into a canister can occur following a breach of the canister and a subsequent internal flood causing criticality. Table B9.5-1 lists the fault trees that describe the moderator events during CRCF operations.

Table B9.5-1. Moderator Fault Trees

Fault Tree Name	Applies To
060-MODERATOR-SOURCE	Transportation casks, canisters (except for HLW) and AOs
ESD20-MOD-FIRE	Transportation casks, canisters (except for HLW) and AOs
HLW-MODERATOR	HLW transportation casks and canisters

NOTE: AO = aging overpack; HLW = high-level radioactive waste.

Source: Original

Figure B9.5-1 illustrates the possibility of a moderator source during normal operations in the CRCF. Potential sources are: Oil from the 200-ton crane gear box, water from an inadvertent activation of the fire suppression system and other water sources in the facility (i.e., water pipes). Details on moderator source failures are addressed in Section 6.2.2.9.

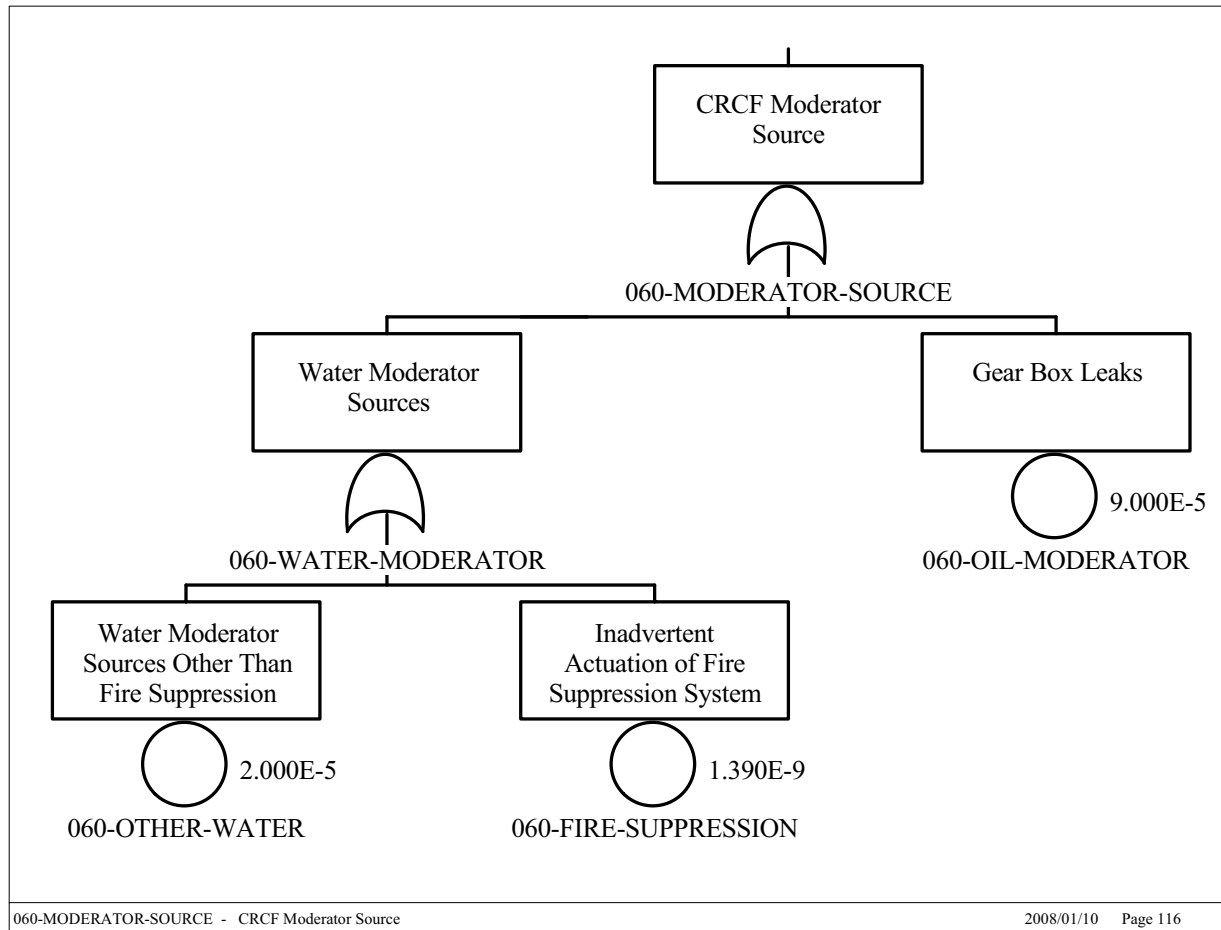

060-MODERATOR-SOURCE - CRCF Moderator Source

2008/01/10 Page 116

Source: Original

Figure B9.5-1. Moderator Source (no fire)

Figure B9.5-2 addresses the possibility of a moderator entering a canister during a facility fire in the CRCF. A conservative value of 1.000E-3 has been established for this event. Initiation of criticality for HLW due to moderator infiltration has been set to zero as explained in Section 6.2.2.9.

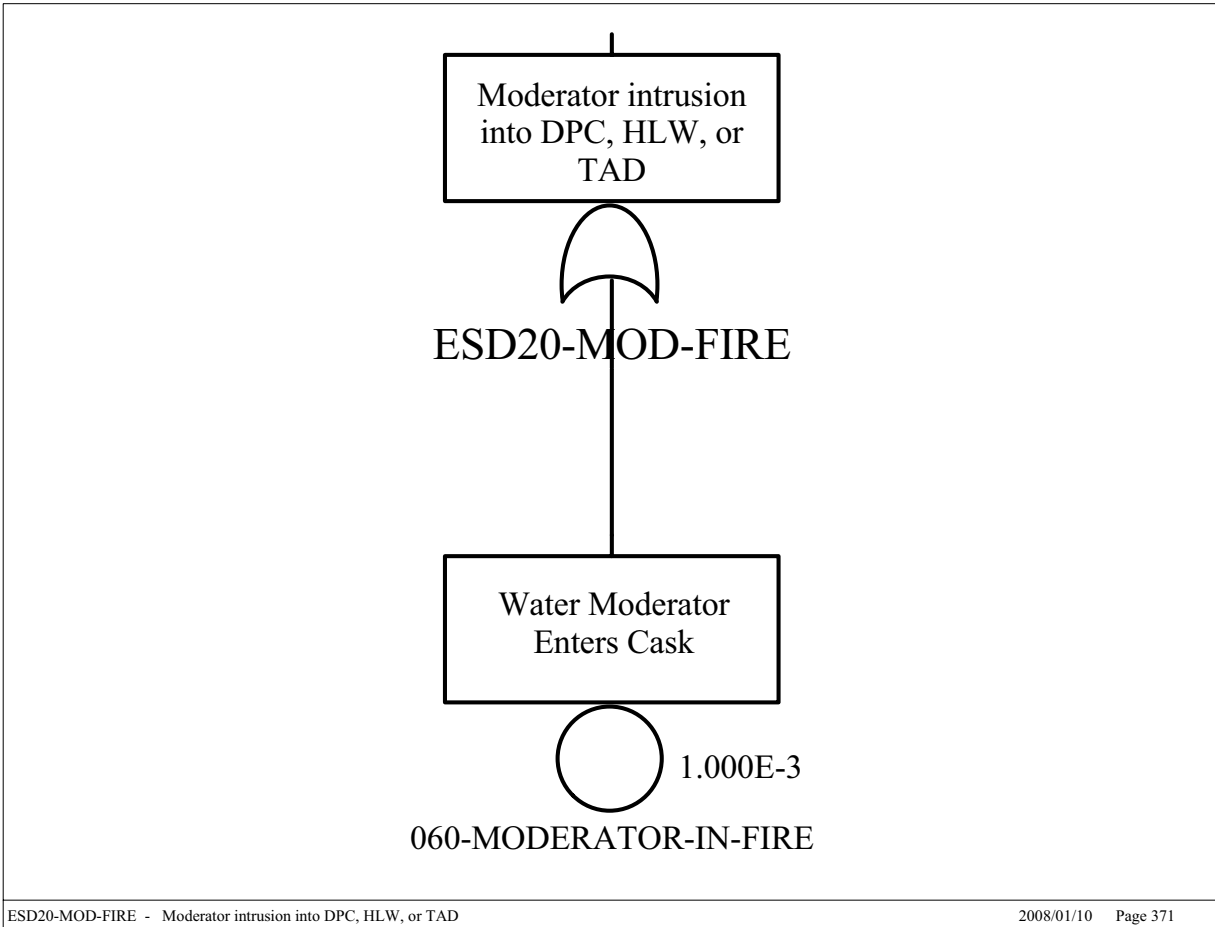

Source: Original

Figure B9.5-2. Moderator Source (fire)

B9.6 IMPACT OF SHIELD DOOR INTO CONVEYANCE

These fault trees describe collision of a moving shield door with the CTT, site transporter, or WPTT. Table B9.6-1 lists the fault trees that describe these impacts. The DPCs and TAD canisters may be transported in the CRCF in transportation casks on a CTT or in aging overpacks on a site transporter; therefore, these fault trees contain split fractions that define the fraction of DPCs or TAD canisters carried on a CTT or site transporter. DSNF, HLW and MCOs are only carried in transportation casks on the CTT; the fault tree for these waste types is described in Section B2.

Table B9.6-1. Impact of Shield Door Fault Trees

Fault Tree Name	Applies To
ESD07-DPC-IMPACT	DPCs in Transportation Casks or AOs
060-7-CTT-COLLIDE-SDR	DSNF in Transportation Casks
060-7-CTT-COLLIDE-SDR	HLW in Transportation Casks
060-7-CTT-COLLIDE-SDR	MCO in Transportation Casks
ESD07-TAD-IMPACT	TADs in Transportation Casks or AOs

NOTE: AO = aging overpack; DPC = dual-purpose canister; DSNF = U.S. Department of Energy spent nuclear fuel; HLW = high-level radioactive waste; MCO = multicatcher overpack; TAD = transportation, aging, and disposal canister.

Source: Original

Figure B9.6-1 illustrates the fault tree for shield door impact to a conveyance carrying a DPC. The DPC may be carried on a CTT or a site transporter where the site transporter passes through two shield doors and the CTT passes through one door. The same quantity of DPCs that are carried on a CTT are also carried on a site transporter.

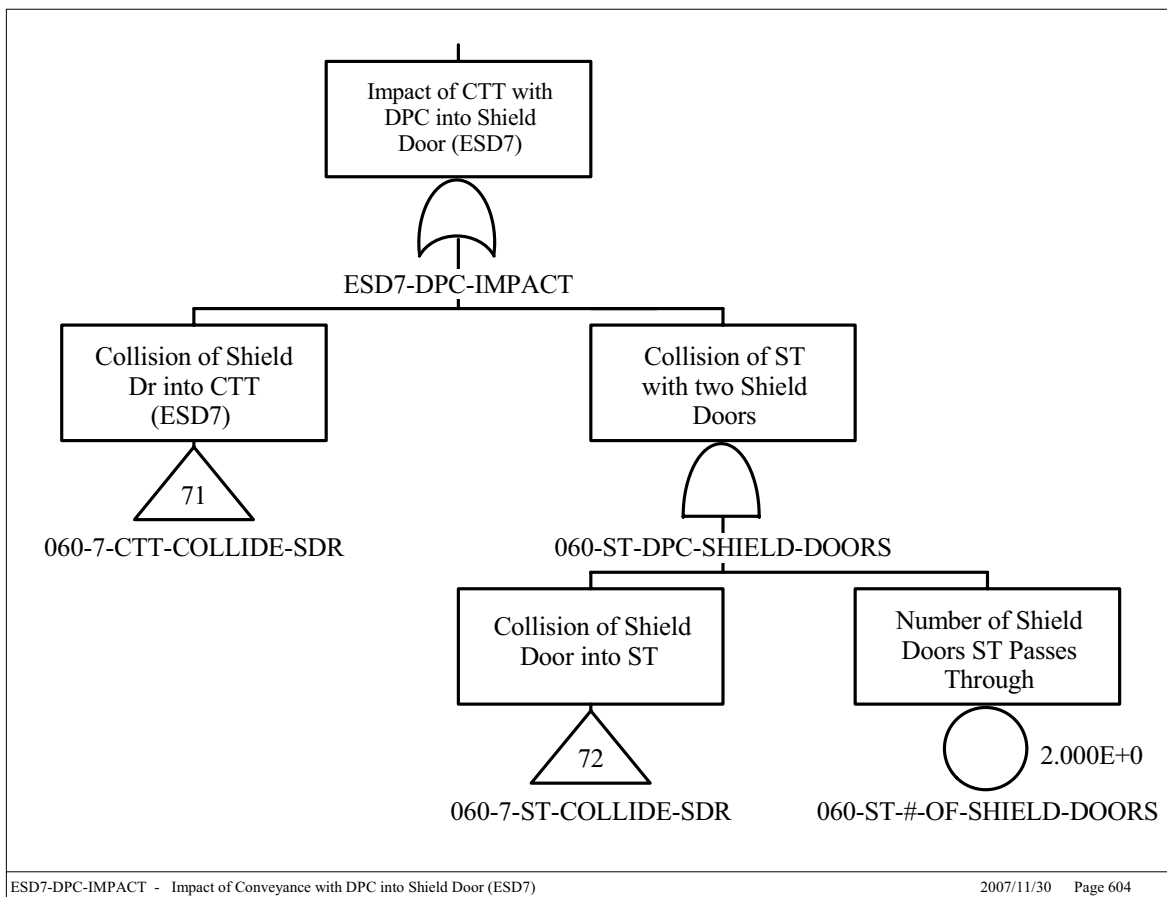

Source: Original

Figure B9.6-1. Impact of Shield Door into Conveyance with DPC

Figure B9.6-2 illustrates the fault tree for shield door impact to a conveyance carrying a TAD canister. This fault tree contains a split fraction because a different number of TAD canisters are carried on a CTT as are carried on a site transporter, and the site transporter passes through two shield doors where the CTT passes through one door.

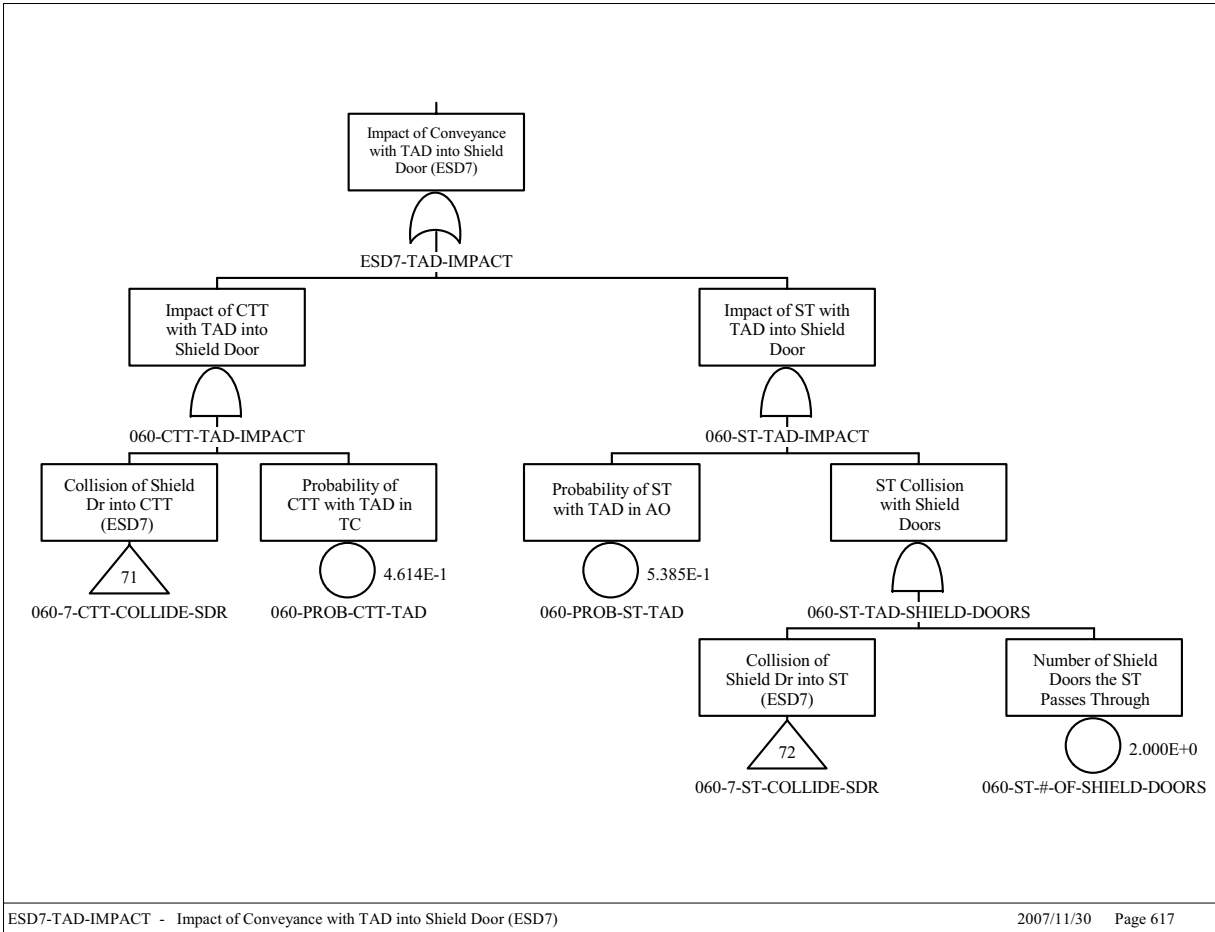

Source: Original

Figure B9.6-2. Impact of Shield Door into Conveyance with TAD canister

B9.7 SHIELDING FAILURE DUE TO IMPACT OF SHIELD DOOR INTO CONVEYANCE

These fault trees describe the failure of shielding due to collision of a moving shield door with the CTT or site transporter. The DPCs and TAD canisters may be transported in the CRCF in transportation casks on a CTT or aging overpacks on a site transporter; therefore, these fault trees contain split fractions that define the fraction of DPCs or TAD canisters carried on a CTT or site transporter and the number of shield doors traversed.

Figure B9.7-1 describes the failure of DPC shielding due to the CTT with a transportation cask traversing one shield door and the site transporter with an aging overpack traversing two doors. Figure B9.7-2 describes the failure of TAD canister shielding due to the CTT with a transportation cask traversing one shield door and the site transporter with an aging overpack traversing two doors.

Figure B9.7-3 illustrates cask shielding failure with a split fraction of casks with and without lead lining. Casks without lead will not lose shielding; however, casks with lead may lose shielding due to lead slumping upon impact. Conservatively, it is assumed that all casks contain lead.

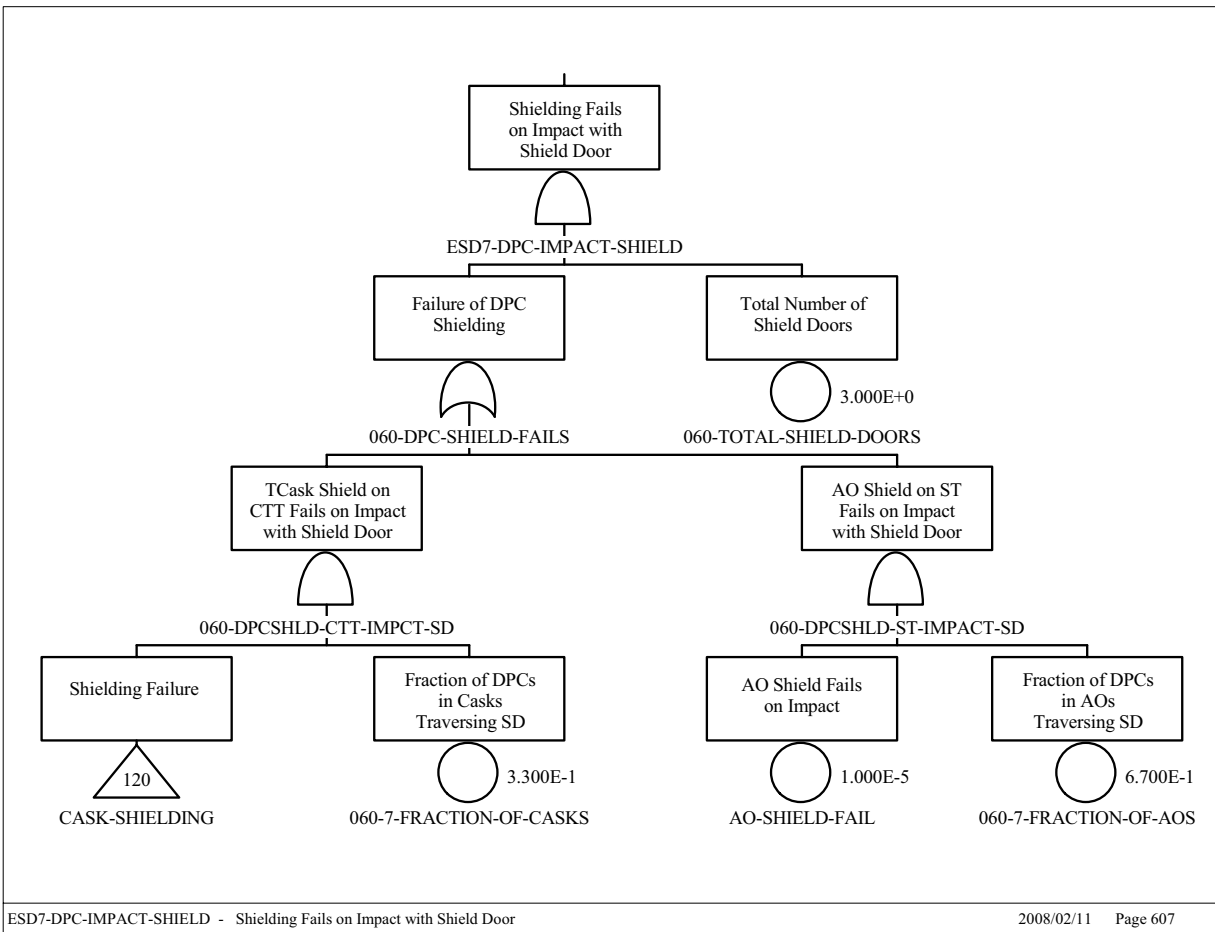

Source: Original

Figure B9.7-1. Shielding Failure due to Impact of Shield Door into Conveyance with DPC

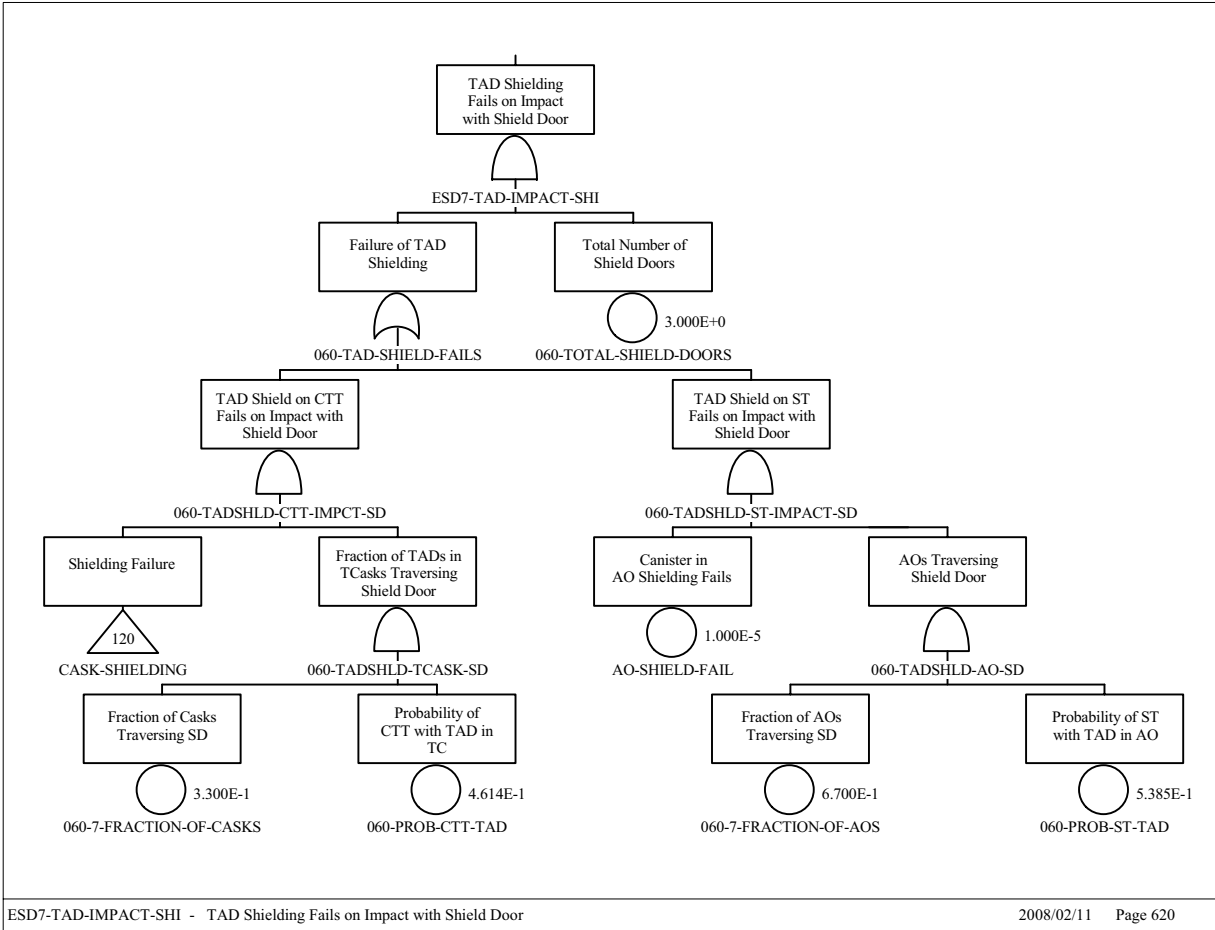

Source: Original

Figure B9.7-2. Shielding Failure due to Impact of Shield Door into Conveyance with TAD Canister

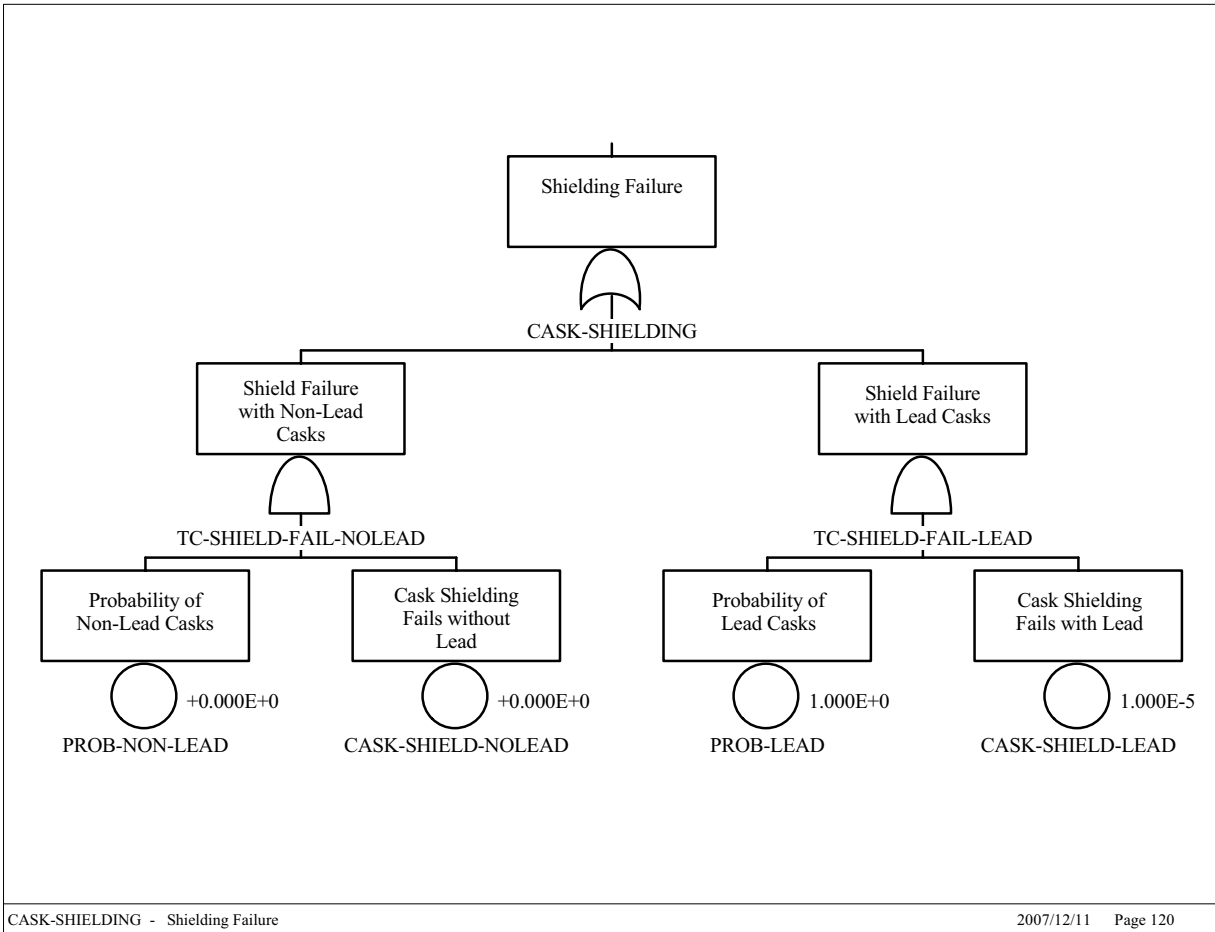

Source: Original

Figure B9.7-3. Cask Shielding Failure

B9.8 CASK OR CANISTER FAILURE IN A FIRE

These fault trees describe the probability of failure of a cask or canister in a fire and involve split fractions associated with the probability of the canister being in a transportation cask, aging overpack, waste package or CTM. The probability that the canister is in a particular configuration is derived from fire data in Attachment F and the derivation is shown in Table 6.3-3. The failure probability in a diesel versus a non-diesel fire is the same in these calculations.

Table B9.8-1 lists the fault trees that describe these failures.

Table B9.8-1. Fault Trees for Canister Failure in a Fire

Fault Tree Name	Applies To
ESD20-DPC-CPA-FIRE-CAN	DPC in transportation cask or AO in cask preparation room
ESD20-DPC-CTM-FIRE-CAN	DPC in CTM
ESD20-DPC-CUR-FIRE-CAN	DPC in transportation cask in cask unloading room
ESD20-DPC-LG-FIRE-CAN	DPC in transportation cask or AO in large fire

Table B9.8-1. Fault Trees for Canister Failure in a Fire (Continued)

Fault Tree Name	Applies To
ESD20-DSNF-CPA-FIRE-CAN	DSTD in transportation cask in cask preparation room
ESD20-DSNF-CTM-FIRE-CAN	DSTD in CTM
ESD20-DSNF-CUR-FIRE-CAN	DSTD in transportation cask in cask unloading room
ESD20-DSNF-LG-FIRE-CAN	DSTD in large fire in transportation cask, CTM or staging area
ESD20-HLW-CPA-FIRE-CAN	HLW in transportation cask in cask preparation room
ESD20-HLW-CTM-FIRE-CAN	HLW in CTM
ESD20-HLW-CUR-FIRE-CAN	HLW in transportation cask in cask unloading room
ESD20-HLW-LG-FIRE-CAN	HLW in large fire in transportation cask, CTM or waste package
ESD20-HLW-PR-FIRE-CAN	HLW in WPTT in positioning room
ESD20-MCO-CPA-FIRE-CAN	MCO in transportation cask in cask preparation room
ESD20-MCO-CTM-FIRE-CAN	MCO in CTM
ESD20-MCO-CUR-FIRE-CAN	MCO in transportation cask in cask unloading room
ESD20-MCO-LG-FIRE-CAN	MCO in large fire in transportation cask or CTM
ESD20-TAD-CPA-FIRE-CAN	TAD in transportation cask or AO in cask preparation room
ESD20-TAD-CTM-FIRE-CAN	TAD in CTM
ESD20-TAD-CUR-FIRE-CAN	TAD in transportation cask in cask unloading room
ESD20-TAD-LG-FIRE-CAN	TAD in large fire in transportation cask, AO, CTM, waste package or WPTT
ESD20-TAD-LOR-FIRE-CAN	TAD in WPTT in loadout room
ESD20-TAD-PR-FIRE-CAN	TAD in WPTT in positioning room
ESD20-WP-H&D-LG-FIRE-CAN	HLW and DSTD in WPTT in large fire
ESD20-WP-H&D-LOR-FIRE-CA	HLW and DSTD in WPTT in loadout room
ESD20-WP-H&D-PR-FIRE-CAN	HLW and DSTD in WPTT in positioning room
ESD20-WP-H&M-LG-FIRE-CAN	HLW and MCO in WPTT in large fire
ESD20-WP-H&M-LOR-FIRE-CA	HLW and MCO in WPTT in loadout room
ESD20-WP-H&M-PR-FIRE-CAN	HLW and MCO in WPTT in positioning room

NOTE: AO = aging overpack; DPC = dual-purpose canister; DSNF = U.S. Department of Energy spent nuclear fuel; HLW = high-level radioactive waste; MCO = multiccanister overpack; TAD = transportation, aging, and disposal canister.

Source: Original

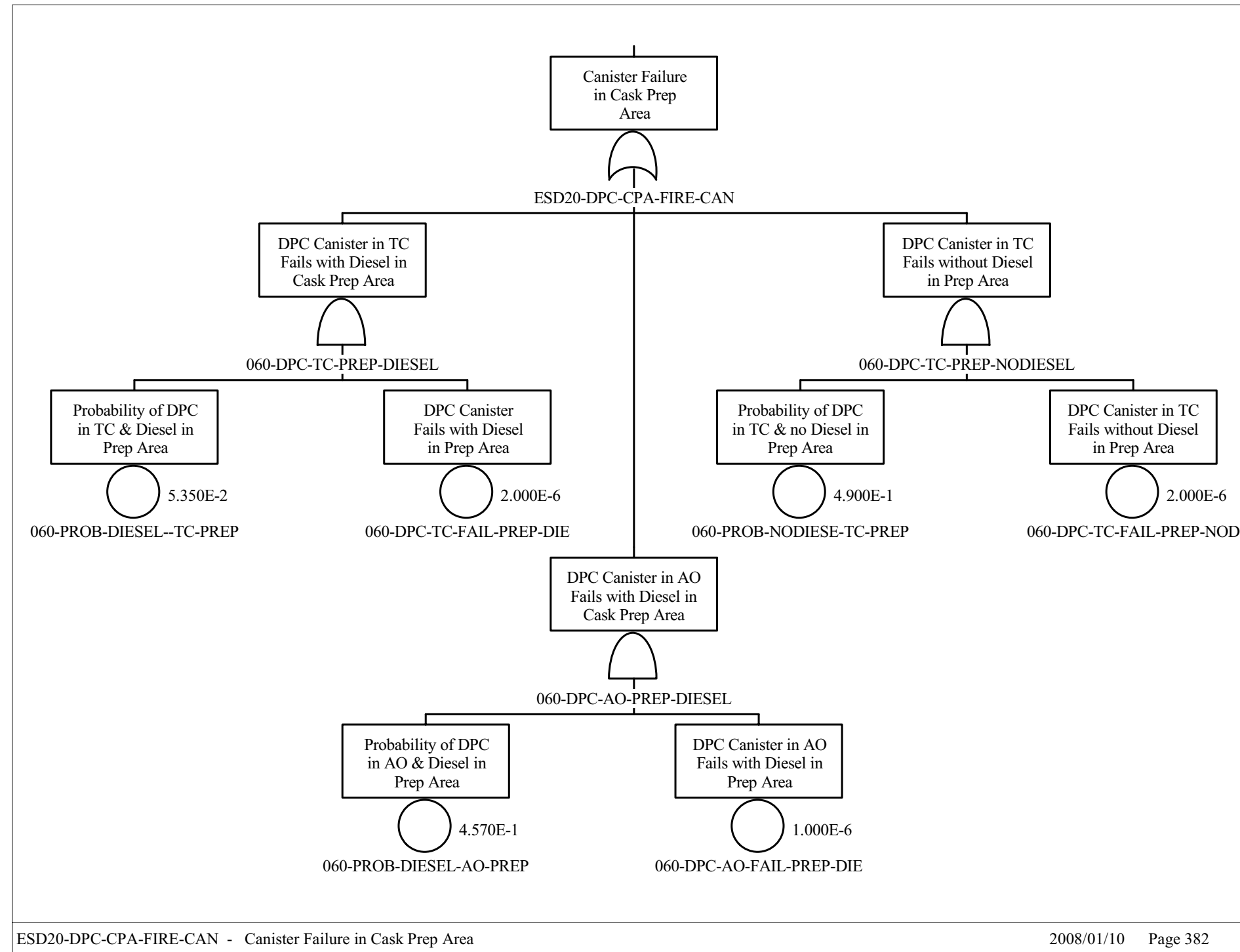

Source: Original

Figure B9.8-1. DPC Failure in a Fire in the
Cask Preparation Room

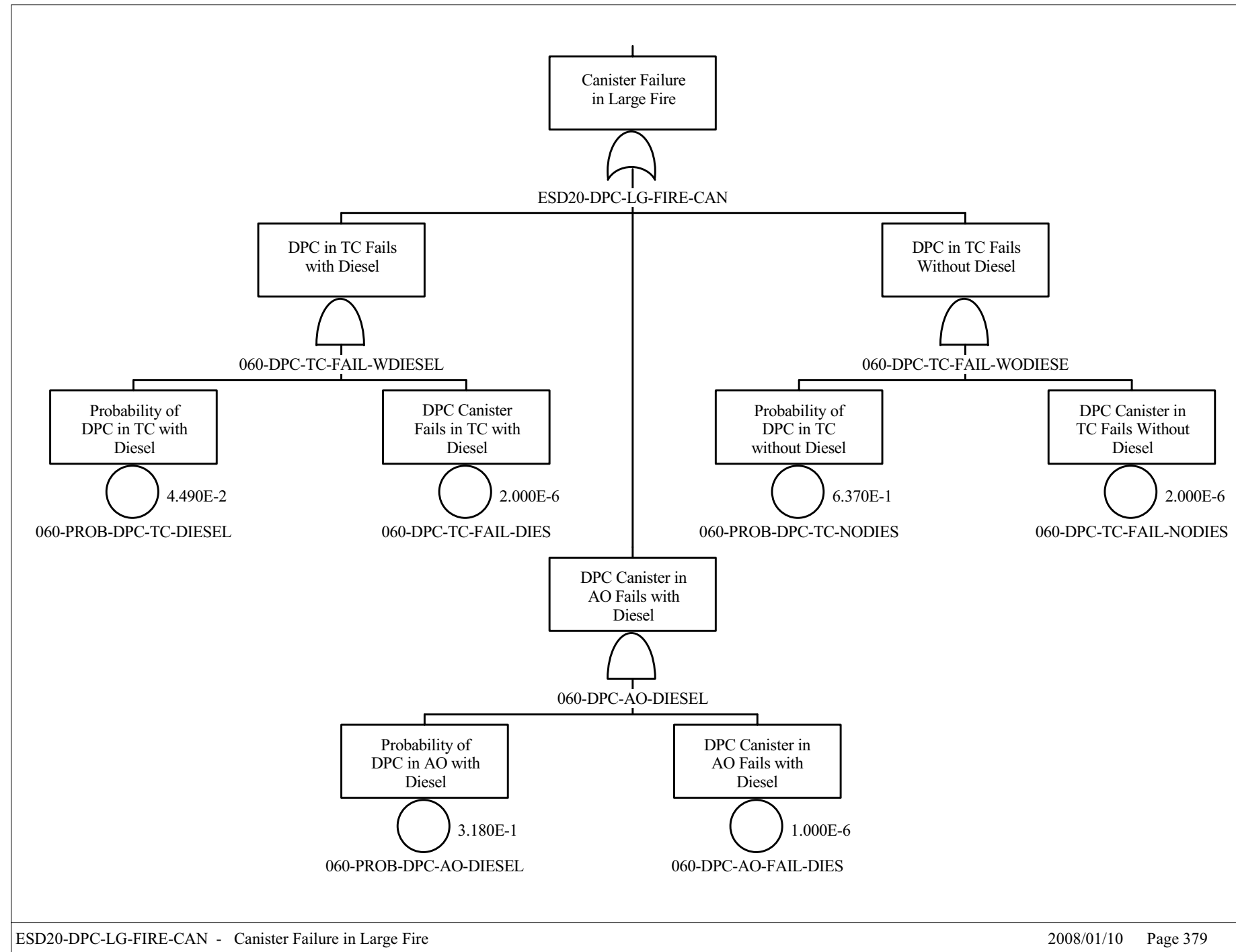

Source: Original

Figure B9.8-2. DPC Failure in a Large Fire

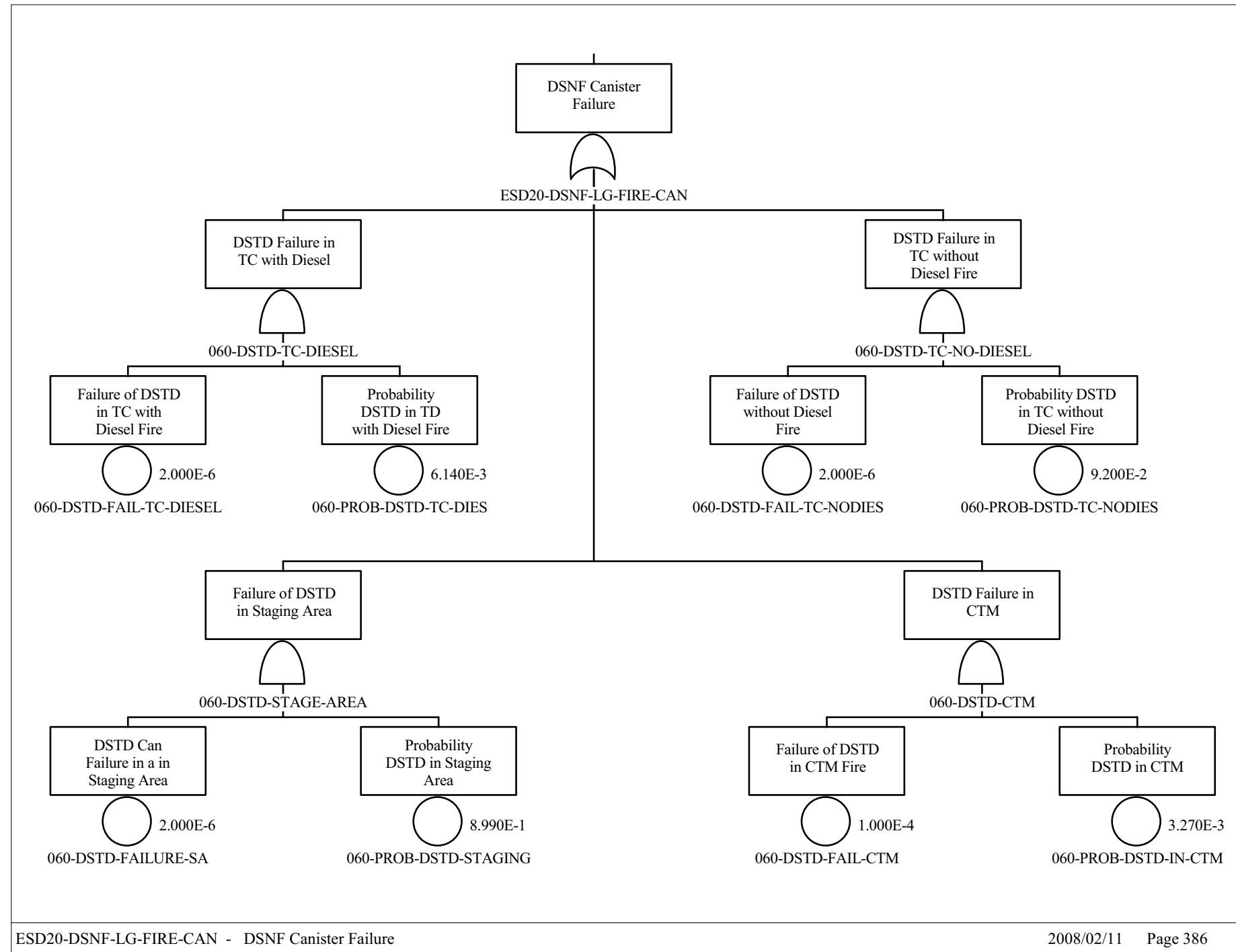

Source: Original

Figure B9.8-3. DSNF Failure in a Large Fire

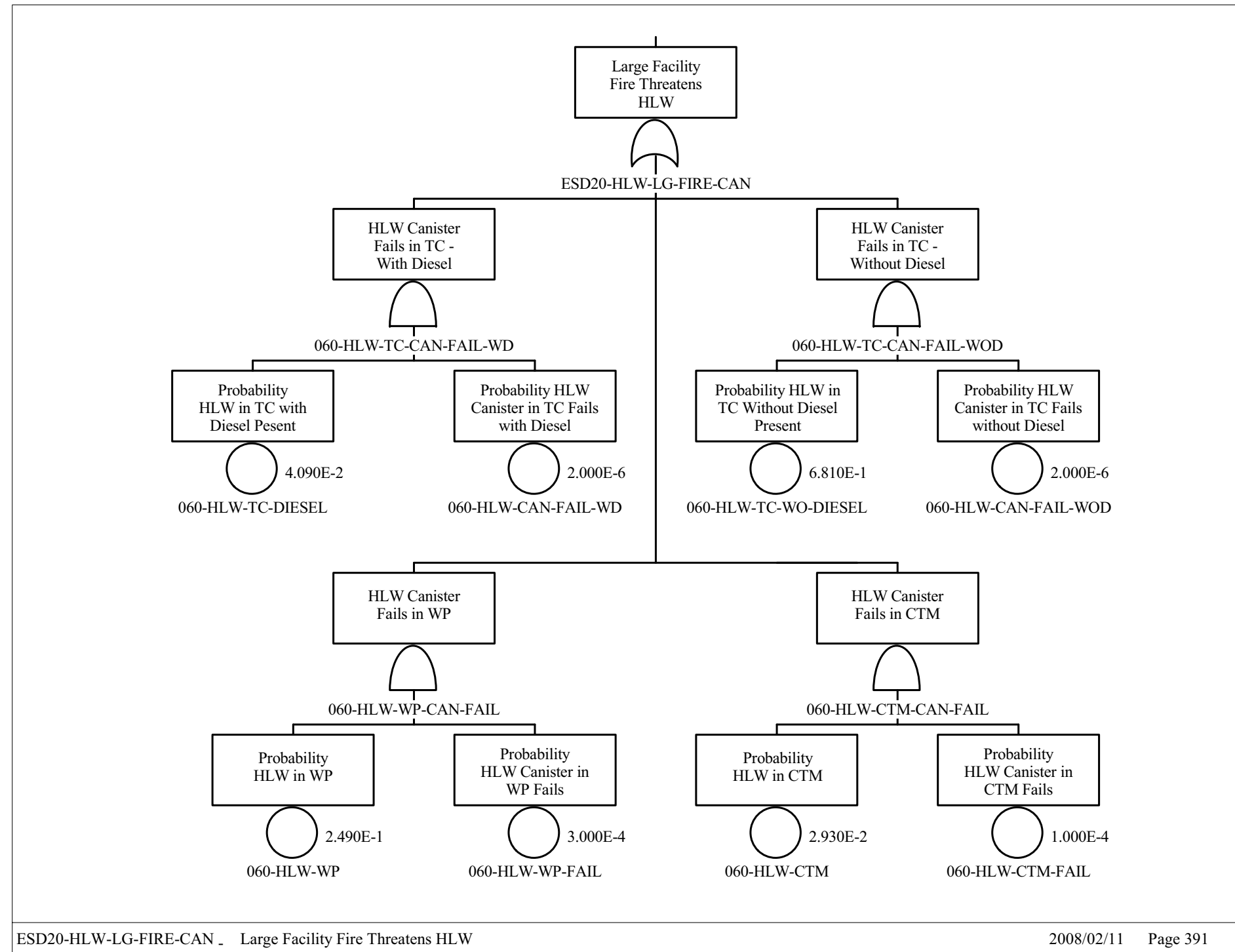

Source: Original

Figure B9.8-4. HLW Failure in a Large Fire

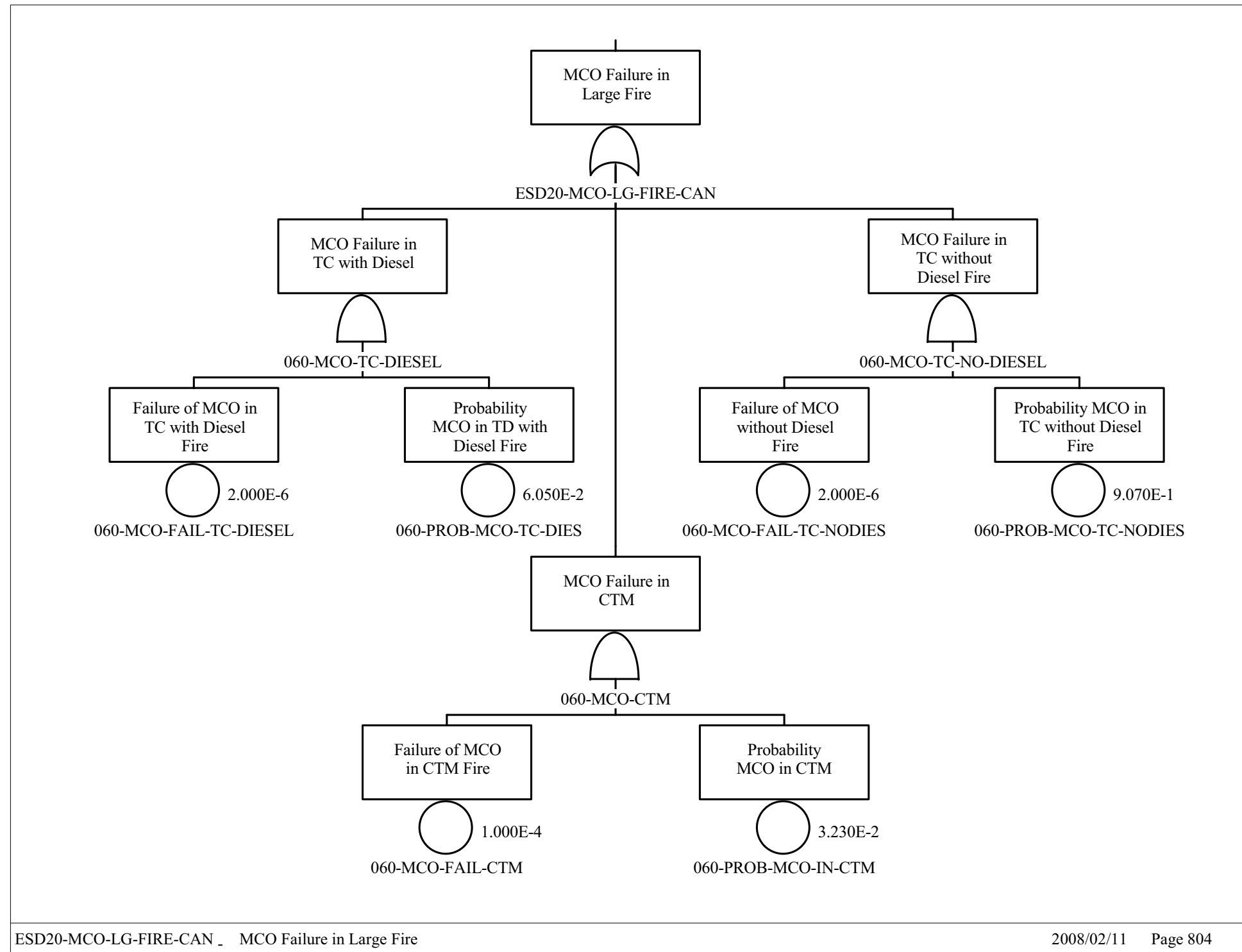

Source: Original

Figure B9.8-5. MCO Failure in a Large Fire

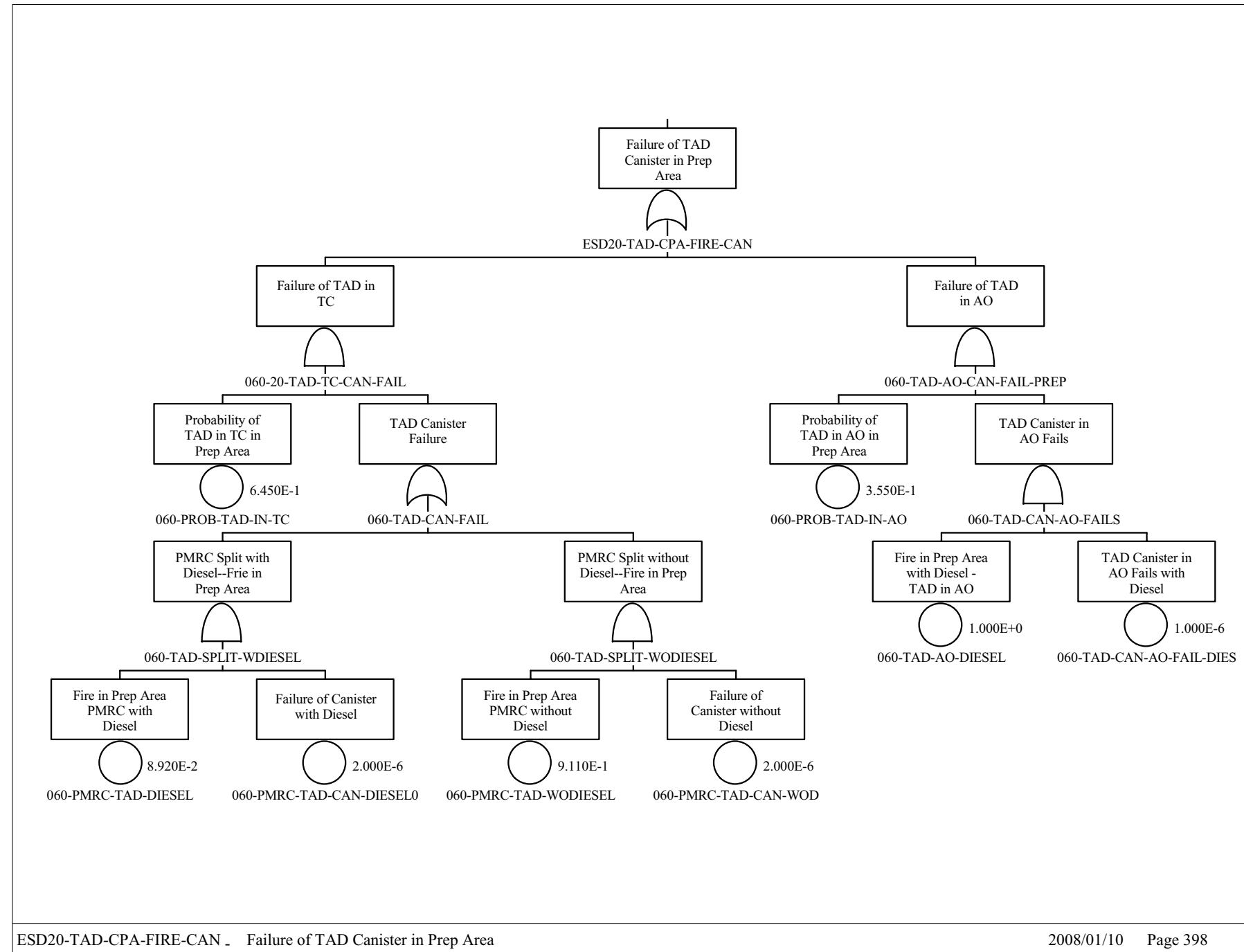

Source: Original

Figure B9.8-6. TAD Failure in a Fire in the Cask Preparation Room

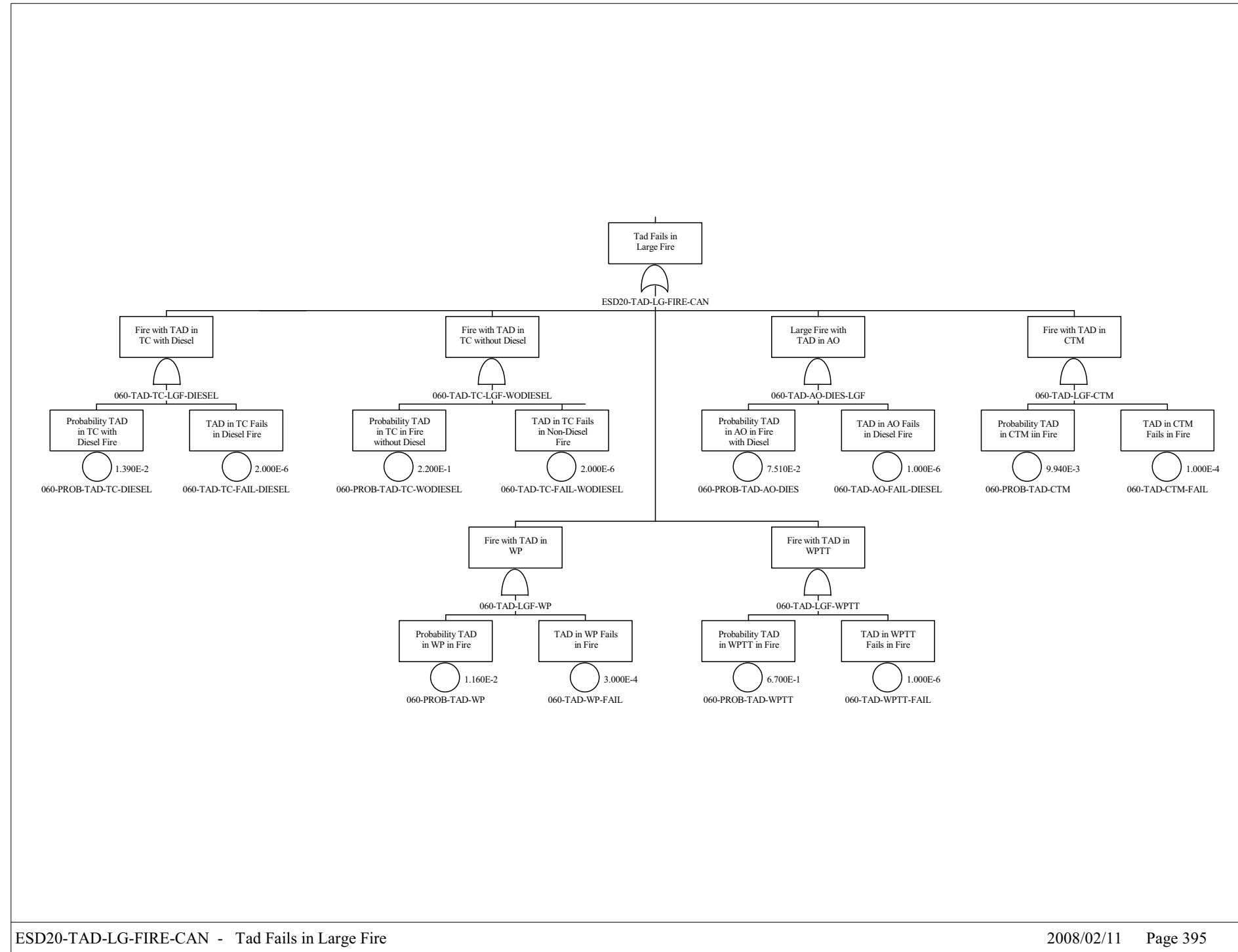

Source: Original

Figure B9.8-7. TAD Failure in a Large Fire

ATTACHMENT C
ACTIVE COMPONENT RELIABILITY DATA ANALYSIS

CONTENTS

	Page
ACRONYMS AND ABBREVIATIONS	C-5
C1 INDUSTRY-WIDE COMPONENT RELIABILITY DATA	C-6
C1.1 COMPONENT DEFINITION	C-6
C1.2 INDUSTRY-WIDE RELIABILITY DATA.....	C-13
C1.3 CRANE AND SPENT FUEL TRANSFER MACHINE DROP ESTIMATES	C-18
C2 BAYESIAN DATA COMBINATION	C-21
C2.1 PARAMETER ESTIMATION USING DATA FROM DIFFERENT SOURCES.....	C-22
C2.2 PARAMETER ESTIMATION IN CASE ONLY ONE DATA SOURCE IS AVAILABLE.....	C-30
C3 COMMON CAUSE FAILURE DATA	C-31
C4 ACTIVE COMPONENT RELIABILITY ESTIMATES INPUT TO SAPHIRE	C-34
C5 REFERENCES; DESIGN INPUTS	C-47

FIGURES

	Page
C2.1-1. Likelihood Functions from Data Sources (Dashed Lines) and Population-Variability Probability Density Function (Solid Line)	C-30
C3-1. Alpha Factor.....	C-32

TABLES

	Page
C1.1-1. YMP PCSA Component Types (TYP) and Failure Modes (FM).....	C-9
C1.2-1. Industry-wide Data Sources Used in YMP PCSA Active Component Reliability Database	C-13
C1.2-2. Data Source Comparison for Check Valve	C-16
C1.2-3. Failure Rates Extracted from Various Data Sources for Check Valve.....	C-17
C1.2-4. Guidelines for Industry-wide Data Selection.....	C-17
C2.1-1. Comparison of Results of Parametric Empirical Bayes and Results Reported by Lopez Droguett et al.....	C-25
C3-1. Alpha Factor Table	C-33
C4-1. Active Component Reliability Estimates Entered into SAPHIRE Models	C-36

ACRONYMS AND ABBREVIATIONS

Acronyms

CCF	common-cause failure
CTM	canister transfer machine
CTT	cask transfer trolley
DOE	U.S. Department of Energy
GROA	geologic repository operations area
HEPA	high-efficiency particulate air filter
HLW	high-level radioactive waste
HVAC	heating, ventilation, and air conditioning
MCC	motor control centers
MCO	multicanister overpack
NRC	U.S. Nuclear Regulatory Commission
PCSA	Preclosure Safety Analysis
PRA	probabilistic risk assessment
SFTM	spent fuel transfer machine
SNF	spent nuclear fuel
TEV	transport and emplacement vehicle
TYP	component type code
TYP-FM	component type and failure mode code
UPS	uninterruptible power supply
YMP	Yucca Mountain Project

Abbreviations

AC	alternating current
DC	direct current
hr	hour

ATTACHMENT C

ACTIVE COMPONENT RELIABILITY DATA ANALYSIS

The purpose of component-level reliability data analysis is to provide reliability information for logic model quantification at the appropriate level agreed upon by the systems and data analysts. In this report, the term data is taken to mean reliability data analyzed as part of the preclosure safety analysis (PCSA) from published sources. The fault tree models described in Section 4.3.2 include random failures of active mechanical equipment as basic events. In order to numerically solve these models, estimates of the likelihood of failure of these equipment basic events are needed. This attachment provides a summary of the approach for developing these active component reliability estimates by gathering and reviewing industry-wide data, and applying Bayesian combinatorial methods to develop mean values and uncertainty bounds that best represented the range of the industry-wide information. The discussion also addresses the method used for estimating the probability of common-cause failures among multiple components. Finally, a table is given showing the template data values input to the Yucca Mountain Project (YMP) PCSA SAPHIRE models (Section 4.2).

C1 INDUSTRY-WIDE COMPONENT RELIABILITY DATA

While data from the facility being studied is the preferred source of equipment failure rate information, it is common in a safety analysis for information from other facilities in the same industry to be used when facility-specific data is sparse or unavailable. Because the YMP activities are atypical of nuclear power plant activities and no operating history exists, it was necessary to develop the required data from the experience of other industries.

C1.1 COMPONENT DEFINITION

The purpose of component-level data analysis is to provide reliability information for logic model quantification at the appropriate level agreed upon by the systems and data analysts. To do this, it is necessary to clearly define component types, boundaries, and failure modes. The system analysis fault tree basic events identify the component and failure mode combinations requiring data, and the analysts' descriptions provide an understanding of the component operating environments. In response to these identified data needs, the data analysts compile data at the component failure mode level for input to the SAPHIRE models. However, this is best achieved via an iterative process between the system and data analysts to ensure that all basic events are properly quantified with appropriate failure data estimates.

1. **Component Type.** Corresponds to the category of equipment at the level for which data is required by the logic model and at which data will be developed by the data analyst. Examples of such component types are motor-driven pumps, cameras, diesel generators, and heat exchangers. For certain complex components, a larger component type such as the canister transfer machine (CTM) is likely to be broken down by the system analyst in the logic model into constituent component types including motors and brakes, not only to facilitate the data analysis but to evaluate the contribution of various subcomponents to the overall component failure.

2. **Component Boundaries.** The boundary definition task is closely connected with the tasks of defining systems boundaries and fault tree construction. Therefore this task is performed jointly with the system analysts.
3. **Failure Mode.** Failure mode is defined as an undesirable component state (e.g., normally closed motor operated valve doesn't open on demand because of valve mechanical damage that occurred before the demand itself).
4. **Selection of Model and Parameters.** Stochastic models of failures of different systems component are defined for component failure probability estimation depending on the system operational mode. A set of available models is given in SAPHIRE for Windows and includes the following:
 - A. **Components of stand-by systems.** The main parameter of stand-by system is the unavailability upon demand. Such system unavailability can be modeled by fault tree, where basic events probabilities are equal to system components unavailabilities averaged by time. This model treats the time to failure as a random value with exponential distribution. Such component unavailability is the function of time. In case of periodic test, unavailability is a periodic function of time. For simplifying the calculation, time dependency is usually replaced by the average value over the considered interval. For periodically tested components, the interval average is the average value for the test interval.

Three types of stand-by system components are identified:

- 1) **Periodically tested stand-by components.** For such components it is necessary to estimate following parameters: failure rate, probability of failure per demand, average restoring time (for repair), and average outage time due to test and maintenance.
- 2) **Non-tested stand-by component.** For such components, the exposure time is set to unit projected operation time for calculation of unavailability. But often the component is tested indirectly or replaced. For example, if the system gets a real actuation signal, the state of the non-tested component can be determined. In this case, the average time to failure for a component is set to the average interval between system actuations. In some instances, the component can be replaced along with the tested components. In this case, test interval for non-tested component is set to average time to failure of tested component.
- 3) **Monitored components.** State of some stand-by components is tested continuously (monitoring). In this case component failure is revealed immediately.

- B. Components of systems in operation. For systems in operation, the most important parameter is the probability of failure during the defined mission time. This probability may be estimated based on fault trees or another logic model, where basic event probabilities are set to unavailabilities of components over the interval mission time. Failures of operating components are modeled using an exponentially distribution with a failure rate different from the failure rate in stand-by mode.

Operating systems contain two main types of components: restorable and non-restorable.

1) Non-restorable components. Components that cannot be restored in case of failure. Exponential distribution of time between failures for such components is characterized by failure rate, λ .

2) Restorable components. Components that may be restored in case of failure. In this case restoration means restoration without outage of operation.

- C. Stand-by systems following demand. Stand-by systems must fulfill a specific function during the defined time after successful start. During this time such systems are described in the same way as operating systems.
- D. Constant probability per demand. The model treats component failure probability as a fixed probability for every demand. For such components, tests are excluded from consideration.

For YMP, the operational mode of failure and standby failures predominate; therefore, constant failure rates and constant probabilities per demand were constructed.

Component types and failure modes were initially identified based upon a listing of the components considered to be likely to be encountered in the analysis. This list was compiled from expertise in database development and familiarity with general component requirements in a variety of facilities. As the fault tree modeling progressed, this list was augmented and tailored to the specific active components included in the PCSA models based on the YMP design.

Correspondingly, it was necessary to develop an active component and failure mode coding scheme that would be consistent with the fault tree model basic events, the needs of the SAPHIRE models, as well as with standard repository naming conventions for YMP equipment types.

The YMP PCSA basic event naming convention was therefore developed to incorporate the following information in the 24 character basic event (BE) name (consistent with the BE field in SAPHIRE):

- Area code – physical design or construction area where a component would be installed
- System locator code – operational systems and processes

- Component function identifiers – component function
- Sequence code – numeric sequence and train assignment
- Component type code – three character identifier for general component type, such as battery, actuator, or pump
- Failure mode code – three character identifier for the way in which the component is considered in the fault tree models to have failed, (e.g., FTS for fails to start or FOD for fails on demand).

The area, system locator, and component function codes were obtained from engineering standards from the YMP repository as a whole to be consistent with overall site naming conventions. The sequence codes were taken from the component identification numbers on project drawings, if the design had progressed to that point at the time of the data development and modeling.

Active component type codes were developed to be consistent with the component function identifiers, but since the type codes were limited to three digits and the function identifiers were occasionally four-characters long, in some instances it was necessary to truncate the identifier to construct the type code.

Failure mode codes (FM) were developed using prior database conventions or abbreviations that would be as intuitively obvious as possible.

Both type (TYP) and failure mode were limited to three characters each in order to be consistent with the input constraints and conventions of the SAPHIRE template database feature, which allows the same component failure data to be applied to all items in the model.

A list of the component type and failure mode combinations is provided in Table C1.1-1.

Industry-wide data sources were then collected and reviewed to identify failure rates per hour or failure probabilities per demand that would be relevant to each of the 146 TYP-FM combinations.

Table C1.1-1. YMP PCSA Component Types (TYP) and Failure Modes (FM)

TYP-FM	Component Name & Failure Mode
AHU-FTR	Air Handling Unit Failure to Run
ALM-SPO	Alarm/Annunciator Spurious Operation
AT-FOH	Actuator (Electrical) Failure
ATH-FOH	Actuator (Hydraulic) Failure
ATP-SPO	Actuator (Pneumatic Piston) Spurious Operation
AXL-FOH	Axle Failure
B38-FOH	Bearing Failure
BEA-BRK	Lifting Beam/Boom Breaks
BLD-RUP	Air Bag Ruptures

Table C1.1-1. YMP PCSA Component Types (TYP) and Failure Modes (FM) (Continued)

TYP-FM	Component Name & Failure Mode
BLK-FOD	Block or Sheaves Failure on Demand
BRH-FOD	Brake (Hydraulic) Failure on Demand
BRK-FOD	Brake Failure on Demand
BRK-FOH	Brake (Electric) Failure
BRP-FOD	Brake (Pneumatic) Failure on Demand
BRP-FOH	Brake (Pneumatic) Failure
BTR-FOD	Battery No Output Given Challenge
BTR-FOH	Battery Failure
BUA-FOH	AC Bus Failure
BUD-FOH	DC Bus Failure
BYC-FOH	Battery Charger Failure
C52-FOD	Circuit Breaker (AC) Fails on Demand
C52-SPO	Circuit Breaker (AC) Spurious Operation
C72-SPO	Circuit Breaker (DC) Spurious Operation
CAM-FOH	Cam Lock Fails
CBP-OPC	Cables (Electrical Power) Open Circuit
CBP-SHC	Cables (Electrical Power) Short Circuit
CKV-FOD	Check Valve Fails on Demand
CKV-FTX	Check Valve Fails to Check
CON-FOH	Electrical Connector (Site Transporter) Failure
CPL-FOH	Coupling (Automatic) Failure
CPO-FOH	Control system Onboard (TEV or Trolley) Failure
CRD-FOH	Badge/Card Reader Failure
CRJ-DRP	Jib Crane Load Drop
CRN-DRP	200-Ton Crane Load Drop
CRN-TBK	200-Ton Crane Two-Blocking Load Drop
CRS-DRP	Crane using Slings Load Drop
CRW-DRP	Waste Package Crane Load Drop
CRW-TBK	Waste Package Crane Two-Blocking Load Drop
CSC-FOH	Cask Cradle Failure
CT-FOD	Controller Mechanical Jamming
CT-FOH	Controller Failure
CT-SPO	Controller Spurious Operation
CTL-FOD	Logic Controller Fails on Demand
DER-FOM	Derailment Failure per Mile
DG-FTR	Diesel Generator Fails to Run
DG-FTS	Diesel Generator Fails to Start
DGS-FTR	Diesel Generator - Seismic - Fails to Run for 29 Days
DM-FOD	Drum Failure on Demand
DM-MSP	Drum Mis-spooling (Hourly)
DMP-FOH	Damper (Manual) Fails to Operate

Table C1.1-1. YMP PCSA Component Types (TYP) and Failure Modes (FM) (Continued)

TYP-FM	Component Name & Failure Mode
DMP-FRO	Damper (Manual) Fails to Remain Open (Transfers Closed)
DMS-FOH	Demister (Moisture Separator) Failure
DRV-FOH	Drive (Adjustable Speed) Failure
DRV-FSO	Drive (Adjustable Speed) Failure to Stop on Demand
DTC-RUP	Duct Ruptures
DTM-FOD	Damper (Tornado) Failure on Demand
DTM-FOH	Damper (Tornado) Failure
ECP-FOH	Position Encoder Failure
ESC-FOD	Emergency Stop Button Controller Failure to Stop (on Demand)
FAN-FTR	Fan (Motor-Driven) Fails to Run
FAN-FTS	Fan (Motor-Driven) Fails to Start on Demand
FRK-PUN	Forklift Puncture
G65-FOH	Governor Failure
GPL-FOD	Grapple Failure on Demand
GRB-FOH	Gear Box Failure
GRB-SHH	Gear Box Shaft/Coupling Shears
GRB-STH	Gear Box Stripped
HC-FOD	Hand Held Radio Remote Controller Fails to Stop (on Demand)
HC-SPO	Hand Held Radio Remote Controller Spurious Operation
HEP-LEK	Filter (HEPA) Leaks [Bypassed]
HEP-PLG	Filter (HEPA) Plugs
HOS-LEK	Hose Leaking
HOS-RUP	Hose Ruptures
IEL-FOD	Interlock Failure on Demand
IEL-FOH	Interlock Failure
LC-FOD	Level Controller Failure on Demand
LRG-FOH	Lifting Rig or Hook Failure
LVR-FOH	Lever (Two Position; Up-Down) Failure
MCC-FOH	Motor Control Centers (MCCs) Failure
MOE-FOD	Motor (Electric) Fails on Demand
MOE-FSO	Motor (Electric) Fails to Shut Off
MOE-FTR	Motor (Electric) Fails to Run
MOE-FTS	Motor (Electric) Fails to Start (Hourly)
MOE-SPO	Motor (Electric) Spurious Operation
MSC-FOH	Motor Speed Control Module Failure
MST-FOH	Motor Starter Failure
NZL-FOH	Nozzle Failure
PIN-BRK	Pin (Locking or Stabilization) Breaks
PLC-FOD	Programmable Logic Controller Fails on Demand
PLC-FOH	Programmable Logic Controller Fails to Operate
PLC-SPO	Programmable Logic Controller Spurious Operation

Table C1.1-1. YMP PCSA Component Types (TYP) and Failure Modes (FM) (Continued)

TYP-FM	Component Name & Failure Mode
PMD-FTR	Pump (Motor Driven) Fails to Run
PMD-FTS	Pump (Motor Driven) Fails to Start on Demand
PPL-RUP	Piping (Lined) Catastrophic
PPM-PLG	Piping (Water) Plugs
PPM-RUP	Piping (Water) Ruptures
PR-FOH	Passive Restraint (Bumper) Failure
PRM-FOH	eProm (HVAC Speed Control) Failure
PRV-FOD	Pressure Relief Valve Fails on Demand
PV-SPO	Pneumatic Valve Spurious Operation
QDV-FOH	Quick Disconnect Valve Failure
RCV-FOH	Air Receiver Fails to Supply Air
RLY-FTP	Relay (Power) Fails to Close/Open
SC-FOH	Speed Control Failure
SC-SPO	Speed Control Spurious Operation
SEL-FOH	Speed Selector Fails
SEQ-FOD	Sequencer Fails on Demand
SFT-COL	Spent Fuel Transfer Machine Collision/Impact
SFT-DRP	Spent Fuel Transfer Machine Fuel Drop
SFT-RTH	Spent Fuel Transfer Machine Fuel Raised Too High
SJK-FOH	Screw jack (TEV) Failure
SRF-FOH	Flow Sensor Failure
SRP-FOD	Pressure Sensor Fails on Demand
SRP-FOH	Pressure Sensor Fails
SRR-FOH	Radiation Sensor Fails
SRS-FOH	Over Speed Sensor Fails
SRT-FOD	Temperature Sensor/Transmitter Fails on Demand
SRT-FOH	Temperature Sensor/Transmitter Fails
SRT-SPO	Temperature Sensor Spurious Operation
SRU-FOH	Ultrasonic Sensor Fails
SRV-FOH	Vibration Sensor (Accelerometer) Fails
SRX-FOD	Optical Position Sensor Fails on Demand
SRX-FOH	Optical Position Sensor Fails
STU-FOH	Structure (Truck or Railcar) Failure
SV-FOD	Solenoid Valve Fails on Demand
SV-FOH	Solenoid Valve Fails
SV-SPO	Solenoid Valve Spurious Operation
SWA-FOH	Switch, Auto-Stop Fails (CTT end of Hose Travel)
SWG-FOH	13.8kV Switchgear Fails
SWP-FTX	Electric Power Switch Fails to Transfer
SWP-SPO	Electric Power Switch Spurious Transfer
TD-FOH	Transducer Failure

Table C1.1-1. YMP PCSA Component Types (TYP) and Failure Modes (FM) (Continued)

TYP-FM	Component Name & Failure Mode
TDA-FOH	Transducer (Air Flow) Failure
TDP-FOH	Transducer (Pressure) Fails
TDT-FOH	Transducer (Temperature) Fails
THR-BRK	Third Rail Breaks
TKF-FOH	Fuel Tank Fails
TL-FOH	Torque Limiter Failure
TRD-FOH	Tread (Site Transporter)
UDM-FOH	Damper (Backdraft) Failure
UPS-FOH	Uninterruptible Power Supply (UPS) Failure
WNE-BRK	Wire Rope Breaks
XMR-FOH	Transformer Failure
XV-FOD	Manual Valve Failure on Demand
ZS-FOD	Limit Switch Failure on Demand
ZS-FOH	Limit Switch Fails
ZS-SPO	Limit Switch Spurious Operation

NOTE: AC = alternating current; DC = direct current; CTT = cask transfer trailer; HEPA = high efficiency particulate air (filter); HVAC = heating, ventilation, and air conditioning; MCC = motor control center; TEV = transport and emplacement vehicle; UPS = uninterruptible power supply.

Source: Original

C1.2 INDUSTRY-WIDE RELIABILITY DATA

Industry-wide data sources are documents containing industrial or military experience on component performance. Usually they are previous safety/risk analyses and reliability studies performed nationally or internationally, but they can also be standards or published handbooks. For the YMP PCSA, an industry-wide database was constructed using a library of industry-wide data sources of reliability data from nuclear power plants, equipment used by the military, chemical processing plants, and other facilities. The sources used are listed in Table C1.2-1.

Table C1.2-1. Industry-wide Data Sources Used in YMP PCSA Active Component Reliability Database

Industry-wide Data Sources Used in YMP PCSA Active Component Reliability Database
<i>Guidelines for Process Equipment Reliability Data with Data Tables.</i> [CCPS] (Ref. C5.1)
<i>Savannah River Site, Generic Data Base Development (U)</i> [SRS Reactors] (Ref. C5.5)
<i>The In-Plant Reliability Data Base for Nuclear Plant Components: Interim Report-The Valve Component.</i> NUREG/CR-3154 (Ref. C5.6)
<i>Waste Form Throughputs for Preclosure Safety Analysis.</i> [BSC 2007](Ref. C5.7)
<i>Probabilistic Risk Assessment (PRA) of Bolted Storage Casks, Updated Quantification and Analysis Report.</i> [EPRI PRA] (Ref. C5.8)

Table C1.2-1. Industry-wide Data Sources Used in YMP PCSA Active Component Reliability Database (Continued)

Industry-wide Data Sources Used in YMP PCSA Active Component Reliability Database
<i>Component Failure and Repair Data for Coal-Fired Power Units.</i> EPRI AP-2071 [EPRI Pipe Failure Study] (Ref. C5.10)
<i>Mechanical Reliability: Theory, Models and Applications.</i> [AIAA] (Ref. C5.11)
<i>Military Handbook, Reliability Prediction of Electronic Equipment.</i> MIL-HDBK-217F [MIL-HDBK-217F] (Ref. C5.12)
<i>The In-Plant Reliability Data Base for Nuclear Power Plant Components - Pump Component.</i> NUREG/CR-2886. (Ref. C5.13)
<i>Some Published and Estimated Failure Rates for Use in Fault Tree Analysis</i> [DuPont] (Ref. C5.14)
<i>Analysis of Station Blackout Risk. Volume 2 of Reevaluation of Station Blackout Risk at Nuclear Power Plants.</i> NUREG/CR-6890 (Ref. C5.15)
<i>Industry-Average Performance for Components and Initiating Events at U.S. Commercial Nuclear Power Plants.</i> NUREG/CR-6928. (Ref. C5.16)
"Train Accidents by Cause from Form FRA F 6180.54." [Federal Railroad Administration] (Ref. C5.17)
<i>Summary, Commercial Nuclear Fuel Assembly Damage/Misload Study – 1985-1999.</i> [McKenna] (Ref. C5.20)
Ruggedized Card Reader/Ruggedized Keypad Card Reader. [HID] (Ref. C5.21)
<i>IEEE Recommended Practice for the Design of Reliable Industrial and Commercial Power Systems.</i> [IEEE-493] (Ref. C5.22)
<i>IEEE Guide to the Collection and Presentation of Electrical, Electronic, Sensing Component, and Mechanical Equipment Reliability Data for Nuclear-Power Generating Stations.</i> [IEEE-500] (Ref. C5.23)
<i>The In-Plant Reliability Data Base for Nuclear Plant Components: Interim Report- Diesel Generators, Batteries, Chargers and Inverters.</i> NUREG/CR-3831 (Ref. C5.24)
Instruments and Software Solutions (for Emergency Response and Health Physics [LAURUS] (Ref. C5.25)
<i>A Survey of Crane Operating Experience at U.S. Nuclear Power Plants from 1968 through 2002.</i> NUREG-1774. (Ref. C5.26)
<i>Data Summaries of Licensee Event Reports of Valves at U.S. Commercial Nuclear Power Plants from January 1, 1976 to December 31, 1980.</i> NUREG/CR-1363 (Ref. C5.28)
<i>The Reliability Data Handbook.</i> [Moss] (Ref. C5.32)
<i>Control of Heavy Loads at Nuclear Power Plants.</i> NUREG-0612. (Ref. C5.35)
<i>Handbook of Reliability Prediction Procedures for Mechanical Equipment</i> [NSWC-98-LE1] (Ref. C5.37)
"Using the EDA to Gain Insight into Failure Rates" [Rand] (Ref. C5.38)
<i>Nuclear Computerized Library for Assessing Reactor Reliability (NUCLARR), Volume 5: Data Manual, Part 3: Hardware Component Failure Data.</i> NUREG/CR-4639, (Ref. C5.39)

Table C1.2-1. Industry-wide Data Sources Used in YMP PCSA Active Component Reliability Database (Continued)

Industry-wide Data Sources Used in YMP PCSA Active Component Reliability Database
<i>Nonelectronic Parts Reliability Data 1995.</i> NPRD-95. [NPRD -95] (Ref. C5.40)
<i>Umatilla Chemical Agent Disposal Facility Quantitative Risk Assessment.</i> [SAIC Umatilla] (Ref. C5.41)
<i>Offshore Reliability Data Handbook.</i> 2nd Edition [OREDA-92] (Ref. C5.42)
<i>Offshore Reliability Data Handbook.</i> 4th Edition. [OREDA-2002] (Ref. C5.43)
<i>Data Summaries of Licensee Event Reports of Pumps at U.S. Commercial Nuclear Power Plants: January 1, 1972-April 30, 1980.</i> NUREG/CR-1205. (Ref. C5.45)
<i>N-Reactor Level 1 Probabilistic Risk Assessment: Final Report.</i> [N-Reactor] (Ref. C5.46)

NOTE: The code in brackets [XXXX] is used to aid the reader in identifying references in Table C4-1.

Source: Original

It was necessary to analyze the industry-wide data to compare the relevancy of the component data selected from the industry-wide data sources with the equipment in the YMP PCSA models.

The data source scope had to be sufficiently broad to cover a reasonable number of the equipment types modeled, yet with enough depth to ensure that the subject matter is appropriately addressed. For example, a separate source might have been used for electronics data versus mechanical data, so long as its use was justified by the detail and the applicability of the information provided. Lastly, the quality of the data source was considered to be a measure of the source’s credibility. Higher quality data sources are based on equipment failures documented by a facility’s maintenance records. Lower quality sources use either abbreviated accounts of the failure event and resulting repair activity, or do not allow the user to trace back to actual failure events. Every effort was made to use the highest quality data source available for each active component type and failure mode.

Data were selected from the industry-wide data sources using the following criteria:

- The component type (TYP) and failure mode (FM) identified in the data source had to match those in the basic events specified in the fault tree. For every component modeled, a comparison was made between the modeled component and the component found in the data source to ensure its suitability for the PCSA. Also, every attempt was made to match the failure modes. Often, the source described the failure mode as “all modes,” whereas the fault tree required “fails to operate.” In cases such as this, sources with more general failure modes were not used unless they were the only available sources.
- The data source had to be widely available, not proprietary. This ensured traceability and accessibility.

- Mid level or low level quality data sources were used only when high level sources were not available.
- The operating environment is an important factor in the selection of data sources. The environment of a component refers not only to its physical state, but also its operational state. The operating conditions of a component include the plant’s maintenance policy and testing policy. If either of these states differed from the modeled facility’s state, then the data were reconsidered and usually rejected (unless no alternative existed).

A potential disadvantage of using industry-wide data is that a source may provide failure rates that are not realistic because the source environment, either physical or operational, may not correlate to the facility modeled. Part of the PCSA active component reliability analysis effort, therefore, was to evaluate the similarity between the YMP operating environment and that represented in each generic data source to ensure data appropriateness.

An example of how data were retrieved from the various data sources is described in the following example for check valves. The failure modes modeled in the PCSA for the check valve are fails per hour (FOH), fails to check (FTX), leaks (LEK), and spurious operation (SPO).

Table C1.2-2 shows a comparison between the failure rates for the check valve and its failure modes from three different industry-wide data sources.

Table C1.2-2. Data Source Comparison for Check Valve

Data Source	Equipment Description	Failure Modes	Data Values Provided	Equipment Boundary Given?	Taxonomy Given?
(Ref. C5.1)	Valve-non-operated, Check	<ul style="list-style-type: none"> • Fails to Check • Significant Back Leakage 	Lower, Mean, Upper	Yes	Yes
(Ref. C5.23)	Driven Equipment Valves, Check	“All Modes”	Low, Recommended, High	No	Yes
(Ref. C5.5)	Check	<ul style="list-style-type: none"> • Fails to Open • Fails to Close • Plugs • Internal Leakage • Internal Rupture • External Leakage • External Rupture 	Mean	No	No

NOTE: AICHe = American Institute of Chemical Engineers; IEEE = Institute of Electrical and Electronics Engineers.

Source: Original

Table C1.2-3 shows actual numbers extracted from industry-wide data sources for five failure modes for check valves.

Table C1.2-3. Failure Rates Extracted from Various Data Sources for Check Valve

Failure Mode Description	Failure Mode Code	Data Source	Lower	Median	Upper	EF
Fails to Close (Hourly)	FOH	(Ref. C5.5)	1.27×10^{-7}	7.74×10^{-7}	4.70×10^{-6}	6.1
Leaks	LEK	(Ref. C5.5)	6.98×10^{-7}	3.49×10^{-6}	1.75×10^{-5}	5.0
Fails to Open (Hourly)	FOH	(Ref. C5.5)	1.27×10^{-7}	7.74×10^{-7}	4.70×10^{-6}	6.1
Transfers Closed	SPO	(Ref. C5.23)	8.00×10^{-8}	7.81×10^{-7}	3.27×10^{-4}	5.0
Transfers Open	SPO	(Ref. C5.23)	8.00×10^{-8}	7.81×10^{-7}	3.27×10^{-4}	5.0

NOTE: EF = error factor.

Source: Original

At this stage of the analysis, it remains to decide which data is appropriate to keep and include in the data pool and which are discarded. The criteria for this process are discussed below.

The guidelines shown in Table C1.2-4 are based on observations of the analysts of their preferences and rationales during the data selection process among the data available at the time.

Table C1.2-4. Guidelines for Industry-wide Data Selection

Data Selection Guidelines	
1.	Preference for greater than zero failures (but not always able to exclude on this basis)
2.	Population of at least 5
3.	Denominator greater than 1,000 hours or 100 demands
4.	If mean or median values, some expression of uncertainty surrounding these values (either upper or lower bounds or lognormal error factor)
5.	Data analyst's confidence in the applicability of the data to the YMP based on: <ul style="list-style-type: none"> • Component design • Driver/operator • Size • Component application • Active versus passive service • Materials/fluids moved (e.g., water versus caustic versus viscous) • Component boundary • What's included and excluded in component definition (e.g., motor, electrical connections) • Failure modes • Operating environment • Physical (e.g., heat, humidity, corrosive) • Functional (e.g., operation, maintenance, and testing frequency)

NOTE: YMP = Yucca Mountain Project.

Source: Original

Given the fact that the YMP will be a relatively unique facility (although portions will be similar to the spent fuel handling and aging areas of commercial nuclear plants), the data development perspective was to collect as much relevant industry-wide failure estimate information as possible to cover the spectrum of equipment operational experience. It is assumed that the YMP equipment would fall within this spectrum (Assumption 3.2.1). The scope of the sources selected for this data set was deliberately broad to increase the probability that YMP operational

experience would fall within the bounds. A combined estimate that reflected the uncertainty ranges defined by the data source values was developed. This process is addressed further in the Bayesian estimation Section C2.

Every attempt was made to find more than one data source for each TYP-FM, although the unique nature of many equipment types made this difficult. Data was extracted from several sources in many cases, then combined using Bayesian estimation (as described further below), and compared by plotting the individual and combined distributions. However, the comparison process often resulted in one source being selected as most representative of the TYP-FM. Ultimately, 53% of the TYP-FMs were quantified with one data source, 8% with two data sources, 8% with three data sources, and 31% with four or more data sources.

C1.3 CRANE AND SPENT FUEL TRANSFER MACHINE DROP ESTIMATES

Industry-wide data was used to quantify the likelihood of experiencing a drop from the 200-ton crane while handling waste forms and their associated containers and for estimating drop probability for jib cranes and cranes used to maneuver waste packages. In addition, drop likelihoods for the spent fuel transfer machine (SFTM) were estimated using industry-wide data.

The rationale for using industry-wide data for these estimates was that a significant amount of crane experience exists within the commercial nuclear power industry and other applications and that this experience could be used to bound the anticipated crane performance at YMP. Further, the repository is expected to have training for crane operators and maintenance programs similar to those of nuclear power plants.

Handling incidents that resulted in a drop were included in the drop probability regardless of cause; they may have been caused by equipment failures (including failures in the yokes and grapples), human error, or some combination of the two.

The industry-wide data for cranes was taken from NUREG-0612 (Ref. C5.35), *A Survey of Crane Operating Experience at U.S. Nuclear Power Plants from 1968 through 2002*. NUREG-1774 (Ref. C5.26), and the *Probabilistic Risk Assessment (PRA) of Bolted Storage Casks, Updated Quantification and Analysis Report* (Ref. C5.8). NUREG-0612 (Ref. C5.35) has several appendices that contain crane data from the Occupational Safety and Health Act Administration, the U.S. Navy, Waste Isolation Pilot Plant, Licensee Event Reports, and from the results of a fault tree analysis. The *Probabilistic Risk Assessment (PRA) of Bolted Storage Casks, Updated Quantification and Analysis Report* (Ref. C5.8) provides estimates from Savannah River Site crane experience in addition to fault tree analysis. Crane failure information was also obtained from quantitative risk study performed for the U.S. Army chemical weapons destruction program (Ref. C5.41).

The information from each of these sources was evaluated in terms of quality, applicability to YMP, and to ensure that the events cited included both equipment failures and human failures. For the industry-wide data provided in terms of the number of events, another major factor was the ability to reasonably and justifiably estimate a meaningful denominator of number of lifts (demands) conducted by the crane population considered in the data source. If this could not be done, the source information could not be used.

A key consideration in evaluating the industry-wide crane data for the 200-ton cranes was the NOG-1 (Ref. C5.3) design requirements that will be placed upon the YMP cranes versus the crane design features reflected in the input data sources. NUREG-1774 (Ref. C5.26, Table 12, pp. 61 – 63) provides a list of the nuclear power plants that had upgraded their cranes to single-failure-proof status consistent with licensee response to U.S. Nuclear Regulatory Commission (NRC) *NRC Bulletin 96-02* (Ref. C5.9) which requested specific information relating to their heavy loads programs and plans consistent with the recommendations of NUREG-0554 (Ref. C5.34). This information was used to constrain the denominator of the number of very heavy load lifts from NUREG-1774 (54,000) by using a percentage of percent of nuclear power plants reporting single failure proof cranes out of total plants (42/110).

Conversely, a separate category of non-single-failure-proof cranes for the waste package manipulating cranes was developed using the remaining percentage (68/110) to adjust the number of lifts. The jib crane lifts were estimated using the NUREG-1774 (Ref. C5.26, Appendix D) table of the types of cranes involved in accidents; mobile and tower cranes using jibs are cited as being involved in ~76% of accidents while bridge and gantry (used for very heavy loads) are ~19%. The percentage of accidents that did not involve jib cranes was therefore believed to reside somewhere between 19% and 24% (100% – 76%). So, the 20,620 lifts estimated for very heavy loads by single failure proof cranes was divided by 21.2% to yield a round number estimate of 97,250 jib crane lifts.

The number of crane drop incidents used as the numerator of the 200-ton crane drop estimate from NUREG-1774 (Ref. C5.26) was also restricted to those involving very heavy loads (defined in NUREG-1774 as >30 tons) of single-failure-proof cranes. Drops occurring during sling lifts were parsed into a separate category and used to estimate the sling lift-related drop likelihood.

Load drop likelihood due to two-blocking was also estimated using industry-wide data. NUREG-0612 (Ref. C5.35) describes a two-blocking event as: “The act of continued hoisting to the extent that the upper head block and the load block are brought into contact, and unless additional measures are taken to prevent further movement of the load block, excessive loads will be created in the rope reeving system, with the potential for rope failure and dropping of the load.” Two-blocking events in the various data sources were evaluated based upon the type of crane involved, as was done for the drop likelihood estimates.

As a result, several categories of crane drop estimates were developed, were coded with TYP-FM designators, and were included in the template database for input to SAPHIRE:

CRN-DRP	200-ton Crane Load Drop	3.2E-05/demand
CRN-TBK	200-ton Crane Two Block Causing Load Drop	4.4E-07/demand
CRS-DRP	200-ton Crane using Slings Load Drop	1.2E-04/demand
CRJ-DRP	Jib Crane Load Drop	2.6E-05/demand
CRW-DRP	Waste Package Crane (Not Single Failure Proof) Load Drop	1.1E-04/demand
CRW-TBK	Waste Package Crane (Not Single Failure Proof) Two Block Causing Load Drop	4.5E-05/demand

In each of these cases, as with the other active component reliability estimates, an effort was made to include a variety of operating experience and combine it together using a parametric empirical Bayes approach. However, for the CRS, CRJ and CRW estimates, since only NUREG-1774 (Ref. C5.26), data was considered to be applicable, a Jeffrey's non-informative prior approach for the Beta distribution was used, since the estimates were per lift (demand).

These crane incident estimates were combined in the SAPHIRE models with the number of estimated YMP crane lifts.

One potential issue regarding the applicability of the industry-wide crane data was the inclusion of hard-wired interlock features on the YMP cranes that might not exist at the nuclear power plants or naval installations from which the industry-wide experience resulted. In other instances, there was concern that interlocks included in the design for use in normal operations, on grapples to verify installation or engagement, could be defeated during maintenance actions where bypasses are permitted to move tools or pallets, since a particular grapple interlock is not standard in industry but is unique to YMP. Further, PCSA is not crediting the grapple interlock function and it was considered that having such interlocks in place would not make the estimated failure probability worse. Therefore the estimates from industry-wide data were considered to be reasonable in that they provided experience-based, and perhaps somewhat pessimistic measures of anticipated crane performance.

Estimates were also developed from industry-wide data source information for the likelihood of SFTM drop, collision, and raising the fuel too high but not dropped (for potential personnel exposure considerations). The primary source for this information was NUREG-1774 (Ref. C5.26, Table 4), which provides brief descriptions of SFTM incidents at U.S. nuclear power plants from 1968 through 2002. A separate study (McKenna/Framatome) (Ref. C5.20) was reviewed, which also included SFTM incidents at U.S. nuclear power plants categorized in terms of Human Error, Equipment Failure, or Misload. Some of these were the same incidents included in NUREG-1774 (Ref. C5.26) so care was taken not to double-count any events. Each of the incidents described was reviewed in detail to evaluate their relevance to the failure modes of interest to the study and their applicability to spent fuel transfers. Incidents related to all types of fuel transfers, such as refueling or new fuel receipt, were used to estimate upper bounds (95th percentiles of a lognormal distribution) and to develop the error factor uncertainty information input to SAPHIRE along with the mean value.

It should be noted that events prior to 1985 were removed from consideration since the number of plants in operation (and therefore the number of lifts per year) would significantly differ from that cited in McKenna/Framatome (Ref. C5.20). Also, McKenna/Framatome stated that reporting practices were inconsistent prior to 1985.

The number of fuel movements used as the denominator of the SFTM estimates was based upon information from McKenna/Framatome (Ref. C5.20), which gave 1,198,723 fuel movements for the 15 year study data window, from 1985 through 1999, or a rough estimate of 79,914.87 per year. Since the numerator information from NUREG-1774 (Ref. C5.26) was based upon 17 years of data, from 1985 through 2002, the estimated denominator was calculated for consistency as $79,914.87 \times 17$ or 1,358,553 SFTM lifts.

As a result, several categories of SFTM event estimates were developed, were coded with TYP-FM designators, and were included in the template database for input to SAPHIRE:

SFT-COL	SFTM Collision/Impact	2.9E-06/demand
SFT-DRP	SFTM Load Drop	5.2E-06/demand
SFT-RTH	SFTM Fuel Raised Too High (but not dropped)	7.4E-07/demand

These SFTM incident estimates were combined in the SAPHIRE models with the number of estimated YMP fuel assembly transfers, specifically: 66,188 based on two transfers each of 33,094 assemblies (Ref. C5.7, Table 4, pg. 27).

The results of the industry-wide data search are documented, organized by component type and failure mode, and can be found in the Excel spreadsheet file “YMP Active Comp Database.xls”, located on the CD in Attachment H.

C2 BAYESIAN DATA COMBINATION

The application of industry-wide data sources or expert elicitation introduces uncertainty in the input parameters used in basic events and, ultimately, the quantification of probabilities of event sequences. Uncertainty is a probabilistic concept that is inversely proportional to the amount of knowledge, with less knowledge implying more uncertainty. Bayes’ theorem is a common method of mathematically expressing a decrease in uncertainty gained by an increase in knowledge (for example, knowledge about failure frequency gained by in-field experience).

A typical application of Bayes’ theorem is illustrated as follows: a failure rate for a given component is needed for fault tree (e.g., a fan motor in the heating, ventilation, and air conditioning (HVAC) system). There is no absolute value but there are several data sources for the same kind of fan and/or similar fans that may exhibit considerable variability for many reasons. Applying any or all of the available data introduces uncertainty in the analysis of the reliability of the HVAC system. Bayes’ theorem provides a mechanism for systematically treating the uncertainty and applying λ_j data sources using the following steps:

1. Initially, estimate the failure rate to be within some range with a probability distribution. This is termed the “prior” probability of having a certain value of the failure rate that expresses the state of knowledge before any new information is applied.
2. Characterize the test information, or evidence, in the form of a likelihood function that expresses the probability of observing the number of failures in the given number of trial if the failure rate is a certain value. The evidence comprises observations or test results on the number of failure events that occur in over a certain exposure, operational, or test duration.
3. Update the probability distribution for the failure rate based on the new body of evidence using the mathematical expression of Bayes’ theorem.

The mathematical expression for applying Bayes' theorem to data analysis is briefly described here. Let λ_j be one failure rate of a set of possible failure rates of the fan motor (component j). Initially, the state of knowledge of the "true value" of λ_j is expressed by the probability distribution $P(\lambda)$, the "prior." The choice of the analytic or discrete form of the prior distribution is made by the data analyst. Let E be a new body of evidence, e.g., a new set of test data or field observations. The new evidence improves the data analyst's state of knowledge. The revised, or "updated," probability distribution for the "true value" of λ_j is represented as $P(\lambda_j|E)$. Bayes' theorem gives:

$$P(\lambda_j | E) = \frac{P(\lambda_j)L(E | \lambda_j)}{\sum_j P(\lambda_j)P(E | \lambda_j)} \quad (\text{Eq. C-1})$$

In summary, Equation C-1 states that the knowledge of the "updated" probability of λ_j , given the new information E , equals the "prior" probability of λ_j before any new information times the likelihood function, $L(E|\lambda_j)$. The likelihood function expresses the probability of observing the number of failures in the evidence if the failure rate λ_j has a certain value. The likelihood function is defined by the analyst in accordance with the kind of evidence. For time-based failure data, a Poisson model is used for the likelihood function. For demand-based failure data, a binomial model is used. The numerator in Equation C-1 is divided by a normalization factor, which must be such that the sum of the probabilities over the entire set of λ_j equals unity.

There are several approaches for applying Bayes' theorem to data management and combining data sources, as described in NUREG/CR-6823 (Ref. C5.4). For the YMP PCSA, the method known as "parametric empirical Bayes" was used. This permitted a variety of different sources to be statistically combined and compared, whether the inputs were expressed as the number of failures and exposure time or demands, or as a mean and error factor. Examples of the methods used for several combinatorial cases are provided below.

C2.1 PARAMETER ESTIMATION USING DATA FROM DIFFERENT SOURCES

Using multiple reliability databases will typically cause a given active component to have various reliability estimates, each one from a different source. These various estimates can be viewed as independent samples from the same distribution, g , representing the source-to-source variability, also called population variability, of the component reliability (Ref. C5.4, Section 8.1). The objective of this section is to outline the methodology for developing the population-variability distribution of active components in the preclosure safety analysis. In a Bayesian approach to reliability estimation, the population-variability distribution of a component constitutes an informative prior distribution for its reliability. This distribution is to be updated, as operating experience becomes available, to produce a reliability distribution specific to the component operated under geologic repository operations area (GROA) conditions. For the time being however, the components anticipated for use at the GROA are yet to be procured and operated. As a consequence, the population-variability distributions developed in this section both aim at and are limited to encompassing the actual component reliability distributions that will be observed at the GROA when operating experience becomes available.

A parametric empirical Bayes method is used to develop the population-variability distributions of active components considered in the preclosure safety analysis. As indicated in “Bayesian Parameter Estimation in Probabilistic Risk Assessment.” (Ref. C5.44, Section 5.1.2), this method is a pragmatic approach that has been used in PRA-related applications; it involves specifying the functional form of the prior population-variability distribution, and fitting the prior to available data, using classical techniques, for example, the maximum likelihood method. A discussion of the adequacy of the parametric empirical Bayes method for determining the population-variability distribution is given at the end of this section.

Applying the parametric empirical Bayes method requires first to categorize the reliability data sources into two types: those that provide information on exposure data (i.e., the number of failures that were recorded over an exposure time (in case of a failure rate) or over a number of demands (in case of a failure probability), and those that do not provide such information). In the latter case, reliability estimates for a failure rate or failure probability are provided in the form of a mean or a median value, along with an uncertainty estimate, typically an error factor.

For each data source, the reliability information about a component’s failure rate or failure probability is mathematically represented by its likelihood function. If exposure data are provided, the likelihood function takes the form of a Poisson distribution (for failure rates), or a binomial distribution (for failure probabilities) (Ref. C5.44, Section 4.2). When no exposure data are available, the reliability estimates for failure rates or failure probabilities are interpreted as expert opinion, for which an adequate representation of the likelihood function is a lognormal distribution ((Ref. C5.44, Section 4.4) and (Ref. C5.27, pp. 312, 314, and 315)).

The next step is to specify the form of the population-variability distribution. In its simplest form, the parametric empirical Bayes method only considers exposure data and employs distributions that are conjugate to the likelihood function (i.e., a gamma distribution if the likelihood is a Poisson distribution, and a beta distribution if the likelihood is binomial) (Ref. C5.4, Section 8.2.1), which have the advantage of resulting in relatively simpler calculations. This technique however is not applicable when both exposure data and expert opinion are to be taken into consideration, because no conjugate distribution exists in this situation. Following the approach of “The Combined Use of Data and Expert Estimates in Population Variability Analysis,”(Ref. C5.27, Section 3.1), the population-variability distribution in this case is chosen to be lognormal. More generally, for consistency, the parametric empirical Bayes method is applied using the lognormal functional form for the population-variability distributions regardless of the type of reliability data available for the component considered (exposure data, expert opinion, or a combination of the two). In the rest of this section, the population-variability distribution in its lognormal form is noted $g(x, \nu, \tau)$, where x is the reliability parameter for the component (failure rate or failure probability), and ν and τ , the two unknowns to be determined, are respectively the mean and standard deviation of the normal distribution associated with the lognormal. The use of a lognormal distribution is appropriate for modeling the population-variability of failure rates and failure probabilities, provided in the latter case that any tail truncation above $x = 1$ has a negligible effect (Ref. C5.44, p. 99). The validity of this can be confirmed by selecting the failure probability with the highest mean and the most skewed lognormal distribution and calculating what the probability is of exceeding 1. In Table C4-1, PRV-FOD fits this profile, with a mean failure probability of 6.54E-03 and an error factor of 27.2. The probability that the distribution exceeds 1 is 2E-04. Stated equivalently,

99.98 percent of the values taken by the distribution are less than 1. This confirms that the use of a truncated lognormal distribution to represent the probability distribution is appropriate.

To determine ν and τ , it is first necessary to express the likelihood for each data source as a function of ν and τ only (i.e., unconditionally on x). This is done by integrating, over all possible values of x , the likelihood function evaluated at x , weighted by the probability of observing x , given ν and τ . For example, if the data source i indicates that r failures of a component occurred out of n demands, the associated likelihood function $L_i(\nu, \tau)$, unconditional on the failure probability x , is as follows:

$$L_i(\nu, \tau) = \int_0^1 \text{Binom}(x, r, n) \times g(x, \nu, \tau) dx \quad (\text{Eq. C-2})$$

where $\text{Binom}(x, r, n)$ represents the binomial distribution evaluated for r failures out of n demands, given a failure probability equal to x , and $g(x, \nu, \tau)$ is defined as previously indicated. This equation is similar to that shown in “Bayesian Parameter Estimation in Probabilistic Risk Assessment.” (Ref. C5.44, Equation 37). If the component reliability was expressed in terms of a failure rate and the data source provided exposure data, the binomial distribution in Equation C-2 would be replaced by a Poisson distribution. If the data source provided expert opinion only (no exposure data), the binomial distribution in Equation C-2 would be replaced by a lognormal distribution.

The maximum likelihood method is an acceptable method to determine ν and τ (Ref. C5.44, p. 101). The maximum likelihood estimators for ν and τ are obtained by maximizing the likelihood function for the entire set of data sources. Given the fact that the data sources are independent, the likelihood function is the product of the individual likelihood functions for each data source (Ref. C5.27, Equation 4). To find the maximum likelihood estimators for ν and τ , it is equivalent and computationally convenient to maximize the log-likelihood function, which is the sum of the logarithms of the likelihood function for each data source.

The calculation of ν and τ completely determines the population-variability distribution g for the reliability of a given active component. The associated parameters to be plugged into SAPHIRE are the mean and the error factor of the lognormal distribution g , which are calculated using the formulas given in NUREG/CR-6823 (Ref. C5.4, Section A.7.3). Specifically, the mean of the lognormal distribution is equal to $\exp(\nu + \tau^2/2)$ and the error factor is equal to $\exp(1.645 \times \tau)$.

The selection of the parametric empirical Bayes method to determine the population-variability distribution is now discussed. This method provides a single “best” solution, while other techniques, such as the hierarchical Bayes method (Ref. C5.4, Section 8.3) differ by using a weighted mix of distributions of the chosen model, which incorporate epistemic (state of knowledge) uncertainty about the model. The parametric empirical Bayes method does not embed epistemic uncertainty but was nevertheless employed because of its satisfactory results for the majority of active components modeled in the preclosure safety analysis. The general adequacy of the method was confirmed by comparing its results to those obtained based on an example using a state-of-knowledge-informed approach (Ref. C5.27). The example involves twelve hypothetical data sources, each documenting the failure rate of motor-driven pumps either

in terms of expert judgment or exposure data (Ref. C5.27, Table 1). Table C2.1-1 compares the percentiles predicted by the parametric empirical Bayes method and those found in “The Combined Use of Data and Expert Estimates in Population Variability Analysis.” (Ref. C5.27, Table 4). Overall, the percentiles appear to be similar, with a key metric of the distributions, their mean, being nearly identical, and the medians being comparable. Percentiles at the tails of the distributions show more differences, the parametric empirical Bayes method yielding a population-variability distribution more spread out overall than the state-of-knowledge-informed distribution (Ref. C5.27).

Table C2.1-1. Comparison of Results of Parametric Empirical Bayes and Results Reported by Lopez Droguett et al.

Population-Variability Value	Parametric Empirical Bayes Method ^a	Lopez Droguett Results ^b
Mean	6.00×10^{-5}	6.05×10^{-5}
1 st percentile	1.32×10^{-7}	3.16×10^{-7}
5 th percentile	4.75×10^{-7}	1.38×10^{-6}
10 th percentile	9.38×10^{-7}	2.67×10^{-6}
50 th percentile (median)	1.04×10^{-5}	1.61×10^{-5}
90 th percentile	1.14×10^{-4}	7.79×10^{-5}
95 th percentile	2.26×10^{-4}	1.36×10^{-4}
99 th percentile	8.10×10^{-4}	4.85×10^{-4}

NOTE: ^a Derivation of the results is given in the following section, Example of Development of Population-Variability Distribution.

^b (“The Combined Use of Data and Expert Estimates in Population Variability Analysis.” *Reliability Engineering and System Safety*, 83 (Ref. C5.27, Table 1)

Source: (Ref. C5.27, Table 1).

An adjustment to the parametric empirical Bayes method was done in a few instances where the error factor of the calculated lognormal distribution was found to be excessive. In a synthetic examination of the failure rates of various components, “External Maintenance Rate Prediction and Design Concepts for High Reliability and Availability on Space Station Freedom,” *Reliability Engineering and System Safety*, 47 (Ref. C5.19, Figure 3) finds that electromechanical and mechanical components have, overall, a range of variation approximately between 2×10^{-8} /hr (5th percentile) and 6×10^{-5} /hr (95th percentile). Using the definition of the error factor given in NUREG/CR-6823, (Ref. C5.4, Section A.7.3), this corresponds to an error factor of $\sqrt{6 \cdot 10^{-5} / 2 \cdot 10^{-8}} = 55$. Therefore, in the preclosure safety analysis, it is considered that lognormal distributions resulting from the empirical Bayes method that yield error factors with a value greater than 55 are too diffuse to adequately represent the population-variability distribution of a component. In such instances (two such cases in the entire PCSA database, when the error factors from the Bayesian estimation were greater than 200), the lognormal distribution used to represent the population-variability is modified as follows. It has the same median as that predicted by the parametric empirical Bayes method, and its error factor is assigned a value of 55. The median is selected as the unvarying parameter because, contrary to the mean, it is not sensitive to the behavior of the tails of the distribution and therefore is

unaffected by the value taken by the error factor. Based on NUREG/CR-6823, (Ref. C5.4, Section A.7.3), the median is calculated as $\exp(v)$, where v is obtained by the maximum likelihood estimation.

A limitation of the parametric empirical Bayes method that prevented its use for all active components of the preclosure safety analysis is that the calculated lognormal distribution can sometimes have a very small error factor (with a value around 1), corresponding to a distribution overly narrow to represent a population-variability distribution. As indicated in NUREG/CR-6823, (Ref. C5.4, p. 8-4), this situation can arise when the reliability data sources provide similar estimates for a component reliability. The inadequacy of the parametric empirical Bayes method in such situations is made apparent by plotting the probability density function of the lognormal distribution and comparing it with the likelihood functions associated with the reliability estimates of each data source. In the cases where the lognormal distribution does not approximately encompass the likelihood functions yielded by the data sources, it is not used to model the population-variability distribution. Instead, this distribution is modeled using a data source that yields a more diffuse likelihood. In the other cases, the lognormal distribution approximately encompasses the likelihood functions yielded by the data sources, showing that the parametric empirical Bayes method is adequate. An illustration of a graph plotting the population-variability distribution along with the likelihood functions from data, based on the example of the Lopez Droguett et al. paper (Ref. C5.27) is provided below.

Example of Development of Population-Variability Distribution

Mathcad is used to calculate the population-variability distribution of active components. An illustration of such a calculation is given using the example in “The Combined Use of Data and Expert Estimates in Population Variability Analysis.” (Ref. C5.27, Table 1). In this example, several data sources supply information about the reliability of motor-driven pumps, as follows:

Four data sources supply point estimates of the failure rates, along with a range (error) factor. This information is given in the following matrix, where the first column contains the estimated hourly failure rate (considered to be a median value) and the second column the associated error factor:

$$A := \begin{pmatrix} 3.0 \cdot 10^{-5} & 5 \\ 2.1 \cdot 10^{-5} & 3 \\ 2.0 \cdot 10^{-5} & 10 \\ 2.53 \cdot 10^{-5} & 10 \end{pmatrix}$$

In addition, eight data sources supply exposure data, which are given in the following matrix, where a recorded number of failures is shown in the first column, and the associated operating time (in hours) is shown in the second.

$$B := \begin{pmatrix} 0 & 76000 \\ 0 & 152000 \\ 0 & 74000 \\ 2 & 74000 \\ 0 & 48000 \\ 3 & 76000 \\ 9 & 10200 \\ 2 & 48000 \end{pmatrix}$$

The population-variability distribution g of the failure rate x is approximated by a lognormal distribution whose unknown parameters, ν and τ , respectively the mean and standard deviation of the associated normal distribution, are to be determined. Calculating ν and τ involves calculating the likelihood function associated with the reliability information in each data source. This is done as follows:

For a data source providing a failure rate point estimate, the likelihood function is a lognormal distribution, function of the failure rate x , and characterized by its median value and associated error factor shown in the matrix A . In Mathcad, the parameters required for defining a lognormal distribution are the mean and standard deviation of the associated normal distribution. Based on the formulas given in NUREG/CR-6823 (Ref. C5.4, Section A.7.3), the mean of the associated normal distribution is the natural logarithm of the median failure rate, and the standard deviation of the associated normal distribution is $\ln(EF)/1.645$, where EF is the error factor.

Because the unknowns to be determined are ν and τ , the likelihood function is expressed as a function unconditional on the value of x . This is done by integrating the likelihood function over all possible values of x (i.e., theoretically, from 0 to infinity) and weighting by the probability of having a value of x , conditional on observing ν and τ . In practice, to facilitate the numerical integration on Mathcad, the integration is performed on a range that encompasses credible values for x . In this example, the failure rate range considered varies from $10^{-8}/\text{hr}$ to $10^{-2}/\text{hr}$. Thus, the likelihood functions, unconditional on x , for each of the data source in the matrix A , are calculated as follows:

$$a := 1..4 \quad fe(a, x) := dlnorm\left(x, \ln(A_{a,1}), \frac{\ln(A_{a,2})}{1.645}\right) \quad (\text{Eq. C-3})$$

$$LA(a, \nu, \tau) := \int_{10^{-8}}^{10^{-2}} fe(a, x) \cdot dlnorm(x, \nu, \tau) dx \quad (\text{Eq. C-4})$$

(In the above formulas, a is an index used to particularize a likelihood function to a data source in the matrix A .)

For a data source providing exposure data (given in the form of a number n of recorded failures over an exposure time t), the likelihood function is a Poisson distribution, expressing the probability that n failures are observed when the expected number of failures is x times t . Here also, the likelihood needs to be expressed as a function unconditional on the failure rate x , which is done by integrating x out, in a similar manner as above:

$$b := 1..8 \qquad fd(b, x) := dpois(Bb, 1, Bb, 2 \cdot x) \qquad \text{(Eq. C-5)}$$

$$LB(b, \nu, \tau) := \int_{10^{-8}}^{10^{-2}} fd(b, x) \cdot dlnorm(x, \nu, \tau) dx \qquad \text{(Eq. C-6)}$$

(In the above formulas, b is an index used to particularize a likelihood function to a data source in the matrix B .)

The maximum likelihood method is used to calculate ν and τ . This involves maximizing the likelihood function for the entire set of data sources. This likelihood function is the product of the individual likelihood function for each data source (this is because the data sources are independent from each other). It is equivalent and computationally convenient to find the maximum likelihood estimators for ν and τ by using the sum of the log-likelihood (logarithm of the likelihood) of each data source.

Therefore, the log-likelihood function to be maximized is:

$$L(\nu, \tau) := \sum_{a=1}^4 \ln(LA(a, \nu, \tau)) + \sum_{b=1}^8 \ln(LB(b, \nu, \tau)) \qquad \text{(Eq. C-7)}$$

To maximize a function, Mathcad requires guess values and a range over which to search for maxima. The quantity ν represents the logarithm of a failure rate, which is expected to be in the 10^{-6} /hr range. Therefore, a guess value for ν is:

$$\nu := \ln(10^{-6}) \qquad \nu = -13.8$$

Based on a typical error factor value of 10, a guess value for τ is:

$$\tau := \frac{\ln(10)}{1.645} \qquad \tau = 1.4$$

A reasonable range over which to perform the likelihood maximization is as follows:

<i>Given</i>	$\nu > -20$	$\nu < -1$
	$\tau > 0.01$	$\tau < 5$

The maximum likelihood estimators for ν and τ are:

$$\begin{aligned} \underline{\nu} &:= \text{Maximize}(L, \nu, \tau) & \underline{\nu} &:= L1 & \nu &= -11.478 \\ \underline{\tau} &:= L2 & \tau &= 1.874 \end{aligned}$$

Therefore, the mean and error factors of the population-variability distribution for the failure rate are (based on the formula in NUREG/CR-6823 (Ref. C5.4, Section A.7.3)):

$$\begin{aligned} \underline{m} &:= \exp\left(\nu + \frac{\tau}{2}\right) & m &= 6.00 \times 10^{-5} & \text{per hour} \\ EF &:= \exp(1.645 \cdot \tau) & EF &= 21.8 \end{aligned}$$

Notable percentiles of the population-variability distribution are as follows (expressed as hourly failure rates) and shown in Figure C2.1-1:

1 st percentile:	$qlnorm(0.01, \nu, \tau) = 1.32 \times 10^{-7}$
5 th percentile:	$qlnorm(0.05, \nu, \tau) = 4.75 \times 10^{-7}$
10 th percentile:	$qlnorm(0.10, \nu, \tau) = 9.38 \times 10^{-7}$
50 th percentile:	$qlnorm(0.50, \nu, \tau) = 1.04 \times 10^{-5}$
90 th percentile:	$qlnorm(0.90, \nu, \tau) = 1.14 \times 10^{-4}$
95 th percentile:	$qlnorm(0.95, \nu, \tau) = 2.26 \times 10^{-4}$
99 th percentile:	$qlnorm(0.99, \nu, \tau) = 8.10 \times 10^{-4}$

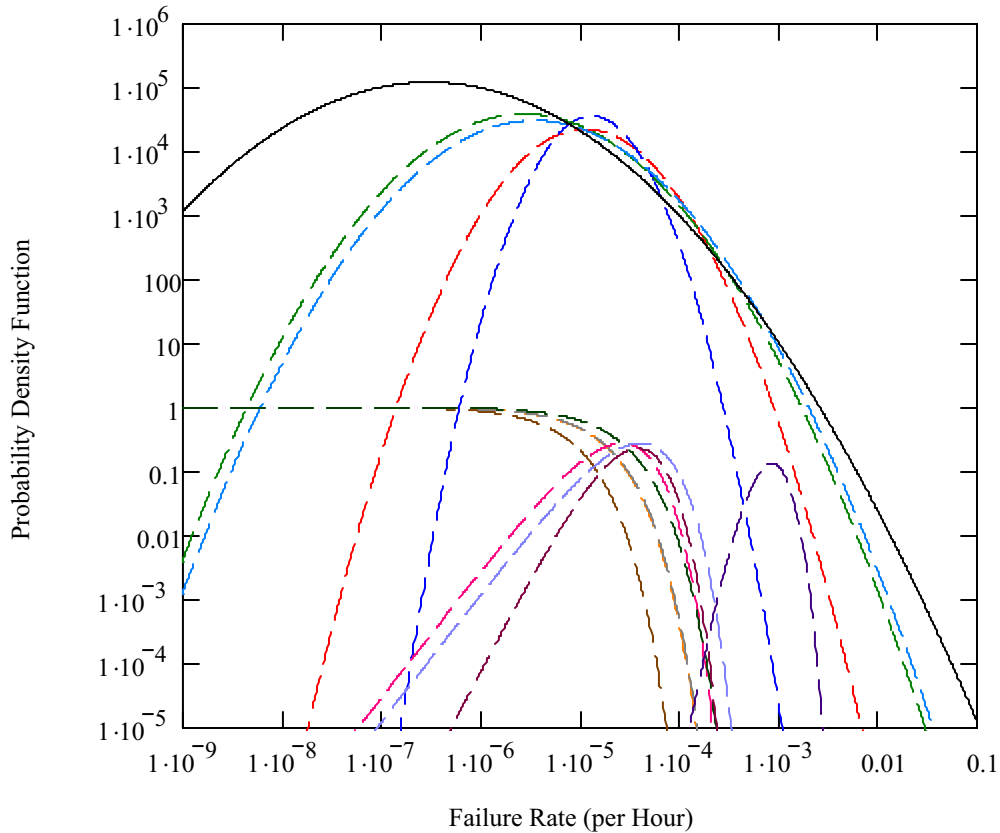

Source: Original

Figure C2.1-1. Likelihood Functions from Data Sources (Dashed Lines) and Population-Variability Probability Density Function (Solid Line)

C2.2 PARAMETER ESTIMATION IN CASE ONLY ONE DATA SOURCE IS AVAILABLE

To be developed, a population-variability distribution requires at least two data sources, and therefore the previous method is not applicable when only one data source is available. In this case, the probability distribution for the reliability parameter of an active component is that yielded by the data source. For example, if the data source provides a mean and an error factor for the component reliability parameter, the probability distribution is modeled in SAPHIRE as a lognormal distribution with that mean and that error factor. If the data source does not readily provide a probability distribution, but instead exposure data (i.e., a number of recorded failures over an exposure time for failure rates, or over a number of demands for failure probabilities) the probability distribution for the reliability parameter is developed through a Bayesian update using Jeffrey’s noninformative prior distribution. As indicated in NUREG/CR-6823 (Ref. C5.4, Section 6.2.2.5.2), this noninformative prior conveys little prior belief or information, thus allowing the data to speak for themselves.

As mentioned in “Bayesian Parameter Estimation in Probabilistic Risk Assessment,” (Ref. C5.44, Section 4.2), the likelihood function associated with exposure data is either a Poisson distribution (in the case of failure rates), or a binomial distribution (in the case of failure probabilities).

Applying Bayes' theorem with Jeffrey's noninformative prior in conjunction with a Poisson likelihood function characterized by r recorded failures over an exposure time t results in a closed-form posterior distribution, namely a gamma distribution, characterized by a shape parameter equal to $0.5 + r$, and a scale parameter equal to t ; the mean of this distribution is $(0.5 + r)/t$ (Ref. C5.4, Sections 6.2.2.5.2 and A7.6). In SAPHIRE, this distribution is characterized by its mean and by its shape parameter (i.e., $0.5 + r$).

Applying Bayes' theorem with Jeffrey's noninformative prior in conjunction with a binomial likelihood function characterized by r recorded failures out of n demands results in a closed-form posterior distribution, namely a beta distribution, characterized by a parameter " a " equal to $0.5 + r$, and a parameter " b " equal to $n - r + 0.5$; the mean of this distribution is $(0.5 + r)/(n + 1)$ (Ref. C5.4, Sections 6.3.2.3.2 and A7.8). In SAPHIRE, this distribution is characterized by its mean and by the parameter " b " (i.e., $n - r + 0.5$).

C3 COMMON CAUSE FAILURE DATA

Dependent failures are modeled in event tree and fault tree logic models, with potential dependent failures modeled explicitly via the logic models, whenever possible. For example, failure of the HVAC system is explicitly dependent upon failures in the electrical supply systems that are modeled in the fault trees. Similarly, the effects of erroneous calibration or other human failure events can be explicitly included in the system fault tree models and the basic event probabilities considered during the human reliability analysis. Otherwise, potential dependencies known as common-cause failures are included in fault tree logic, but their probabilities are quantified by an implicit, parametric method. Therefore, another subtask of the active component reliability data analysis is to estimate common cause failure probabilities.

Surveys of failure events in the nuclear industry have led to several parameter models. Of these, three are most commonly used: the Beta Factor method (Ref. C5.18), the Multiple Greek Letter method (Ref. C5.29) and (Ref. C5.30), and the Alpha Factor method (Ref. C5.31). These methods do not require an explicit knowledge of the dependence failure mode. For the YMP PCSA, common-cause failure rates or probabilities were estimated using the alpha factor method described in NUREG/CR-5485 (Ref. C5.31).

The vast majority of the equipment types for which common cause failure basic events were modeled in the YMP PCSA are not covered by the detailed component-specific alpha factor sources based on commercial nuclear plant equipment. Therefore, it was necessary to use alpha factors to address the common cause failure estimates for crane hoist wire ropes, gear boxes, over-torque sensors and the like.

The alpha factor method provides a model to treat common cause failure (CCF) probabilities of k -of- m components. In addition, industry-wide alpha factors have been developed for the U.S. Nuclear Regulatory Commission from experience data collected at nuclear power plants. The data analysis reported in NUREG/CR-5485 (Ref. C5.31) consisted of:

1. Identifying the number of redundant components in each subsystem being reported (e.g., two, three, or four (this is termed the CCF group size, CCCG of size m)).

2. Partitioning the total number of reported failure events for a given component into the number of components that failed together, i.e., $k = 1$ for one component at a time, $k = 2$ for two components at a time, $k = 3$ for three components at a time, up to m for failure of all components in a given CCF group.
3. Estimating the alpha factor for a given component type based on its definition as the fraction of total failure events that involve k component failures due to common cause, for a system of m redundant components, using the alpha factor equation from NUREG/CR-5485 (Ref, C5.31, Table 5-10), as shown in Figure C3-1.

$$\alpha_k^m = \frac{n_k}{\sum_{j=1}^m n_j} \quad k = 1, \dots, m$$

Source: NUREG/CR-5485, p. 70 (Ref. C5.31)

Figure C3-1. Alpha Factor

4. Performing statistical analysis and curve fitting to define the mean and uncertainty range for alpha factors for various CCF group sizes up to eight.

The data analysis also produced industry-wide prior distributions for the alpha factors for each CCF size, based on all CCF events in their database. Events were mapped to a given CCF size, the maximum likelihood estimator obtained and fit to a constrained noninformative prior distribution. The parameter A_T of a Dirichlet distribution was then calculated for each alpha and the results combined using the geometric mean. The results are the industry-wide mean alpha factors and uncertainty bounds reported in of NUREG/CR-5485 (Ref. C5.31, Table 5-11) shown in Table C3-1:

Table C3-1. Alpha Factor Table

Table 5-11. Generic prior distributions for various system sizes.

CCCG Size m	α -Factor	Distributions Parameters		Percentiles			Mean
		a	b	P ₀₅	P ₅₀	P ₉₅	
2	α_1	9.5300	0.470	8.20E-01	9.78E-01	1.00E-00	0.95300
	α_2	0.4700	9.530	1.42E-04	2.16E-02	1.81E-01	0.04700
3	α_1	15.2000	0.800	8.42E-01	9.67E-01	9.99E-01	0.95000
	α_2	0.3872	15.613	2.10E-05	8.79E-03	1.01E-01	0.02420
	α_3	0.4128	15.587	3.45E-05	1.01E-02	1.05E-01	0.02580
4	α_1	24.7000	1.300	8.67E-01	9.61E-01	9.95E-01	0.95000
	α_2	0.5538	25.446	1.44E-04	1.08E-02	7.81E-02	0.02130
	α_3	0.2626	25.737	2.98E-07	1.99E-03	4.82E-02	0.01010
	α_4	0.4836	25.516	6.29E-05	8.42E-03	7.17E-02	0.01860
5	α_1	38.042	1.958	8.86E-01	9.58E-01	9.91E-01	0.95106
	α_2	0.7280	39.272	3.72E-04	1.10E-02	6.05E-02	0.01820
	α_3	0.4120	39.588	1.32E-05	3.93E-03	4.22E-02	0.01030
	α_4	0.2336	39.766	4.57E-08	8.97E-04	2.89E-02	0.00584
	α_5	0.5840	39.416	1.24E-04	7.66E-03	5.27E-02	0.01460
6	α_1	50.4724	2.528	8.97E-01	9.58E-01	9.89E-01	0.95231
	α_2	0.7791	52.221	3.76E-04	9.20E-03	4.78E-02	0.01470
	α_3	0.5406	52.459	6.04E-05	5.02E-03	3.79E-02	0.01020
	α_4	0.3127	52.687	9.28E-07	1.56E-03	2.66E-02	0.00590
	α_5	0.2433	52.757	5.77E-08	7.67E-04	2.24E-02	0.00459
	α_6	0.6519	52.348	1.66E-04	6.93E-03	4.27E-02	0.01230
7	α_1	74.5360	3.464	9.12E-01	9.59E-01	9.86E-01	0.95559
	α_2	0.9906	77.009	6.44E-04	8.84E-03	3.79E-02	0.01270
	α_3	0.6817	77.318	1.39E-04	5.05E-03	2.99E-02	0.00874
	α_4	0.4891	77.511	2.21E-05	2.82E-03	2.42E-02	0.00627
	α_5	0.2941	77.706	3.39E-07	8.97E-04	1.74E-02	0.00377
	α_6	0.2051	77.795	3.84E-09	2.94E-04	1.35E-02	0.00263
	α_7	0.8034	77.197	2.89E-04	6.52E-03	3.32E-02	0.01030
8	α_1	97.6507	4.349	9.20E-01	9.60E-01	9.84E-01	0.95736
	α_2	1.1118	100.888	7.25E-04	7.91E-03	3.13E-02	0.01090
	α_3	0.7915	101.209	2.07E-04	4.87E-03	2.52E-02	0.00776
	α_4	0.6253	101.375	6.92E-05	3.34E-03	2.17E-02	0.00613
	α_5	0.4417	101.558	8.51E-06	1.76E-03	1.74E-02	0.00433
	α_6	0.2581	101.742	6.09E-08	4.74E-04	1.21E-02	0.00253
	α_7	0.1969	101.803	1.59E-09	1.93E-04	1.00E-02	0.00193
	α_8	0.9241	101.076	3.82E-04	6.12E-03	2.78E-02	0.00906

Source: NUREG/CR-5485 (Ref. C5.31)

These values were used in the YMP PCSA by multiplying the mean failure rate for the TYP-FM data by the appropriate alpha factor for k-of-n components for failure-on-demand events (e.g., pump failure to start) and by using the alpha factor divided by two for failure-to-operate events (e.g., pump fails to run) as per the guidance in NUREG/CR-5485 (Ref. C5.31). For example, for a 2-out-of-2 failure on demand event, the mean alpha factor of 0.047 shown in the far right column of Table C3-1 associated with α_2 was multiplied by the mean failure probability for the appropriate component type and failure mode (from Table C4-1) to yield the common cause failure probability.

This approach was considered to provide conservative CCF data for all the component types for which common causes were modeled. This was considered particularly important since the

YMP has never operated and therefore the applicability of conventional nuclear plant alpha factors could not be justified.

The conservatism of this approach can be demonstrated by comparing the alpha factors used for the PCSA diesel generator CCF events to those posted on the U.S. Nuclear Regulatory Commission website for use in Probabilistic Risk Assessment studies of commercial nuclear power plants in the U.S.

The alpha factor used for the PCSA for 2 of 2 diesel generators failing to start was the 0.047 value cited earlier, while the mean alpha factor for a CCCG=2 cited by the NRC (Ref. C5.36) is 0.0136.

Diesel generators are the only component types for which such a comparison can be made since the other YMP component types for which common cause failures were modeled were not covered by the NRC equipment-specific alpha factors.

C4 ACTIVE COMPONENT RELIABILITY ESTIMATES INPUT TO SAPHIRE

Since the primary active component reliability data task objective is to support the quantification of fault tree models developed in SAPHIRE by the system analysts, the output data had to conform to the format appropriate for input to the SAPHIRE code.

SAPHIRE provides template data to the fault tree models in the form of three input comma delimited files:

- BEA – attributes to assign information to the proper SAPHIRE fields
- BED – descriptions of the component type name and failure mode
- BEI – information on the failure rate or probability estimates and distributions used.

Demonstration files for the .BEA, .BED and .BEI template data files provided with SAPHIRE were originally used to construct the PCSA template data files to ensure the proper formatting of the data for use by the fault tree models. In general, the .BEA file provides attribute designators for the code to implement such that the template data is properly assigned to the appropriate fields in SAPHIRE. The .BED file allows description information to be entered and linked to the template data name or designator (which in the YMP PCSA case was the TYP-FM coding). Examples of descriptions used for the PCSA template data were Clutch Failed to Operate, Relay Spurious Operation, Position Sensor Fails on Demand, and Wire Rope Breaks. The .BEI file contains the actual active component reliability parameters, namely the mean value and uncertainty parameter, either the Lognormal Error Factor, or the shape parameter of the Beta or Gamma distributions.

Geometric means of the input parameters from the industry-wide data sources were initially used as screening values for each TYP-FM and were entered into the .BEI file, along with a default Error Factor of 10. Once the Bayesian combination process was completed for all 275 TYP-FM combinations, mean and uncertainty parameter information was entered into the BEA files, and tested in SAPHIRE before being distributed to the systems analysts.

Failure probability per demand information was entered as SAPHIRE Calculation Type 1 for a simple probability and failure rate per hour information was entered as SAPHIRE Calculation Type 3 as a mean failure rate in the lambda field. Calc Type 3 uses the formula $P = 1 - \exp(-\lambda T_m)$, where λ is the mean failure rate (or lambda) and T_m is the mission time. Mission time is defined in the SAPHIRE Basics manual as "...the period of time that a component is required to operate in order to characterize the component operation as successful." Since the template data was to be used for all YMP facilities while the mission times would be system-specific, the mission time field in the three template data files was left blank and these times were instead input individually by the systems analysts.

The correlation class field was also used for the YMP template data files "to account for data dependencies among like events in the database" during the uncertainty analysis, as stated in the SAPHIRE Basics manual. This meant that all components in the same correlation class would be treated the same during the uncertainty analysis. This feature of SAPHIRE is based upon the observations documented (Ref. C5.2) that in the risk models, all components of the same type are quantified with the same failure rate or probability, therefore it is appropriate to group together the experience of all the nominally identified components in the same facility. Therefore, all components of the same type and failure mode are aggregated into a single number, meaning that the dependency between components of the same class must somehow be addressed. For example, if multiple motor-operated valves needed to open for success and all are assigned the same failure probability, then these basic events needed to be correlated via being assigned the same correlation class in the .BEI file. However, if different probabilities were to be used for different motor-operated valves based on the data, then the basic events would not be correlated. In all cases, a correlation class identifier, using the TYP-FM acronyms, was input to the .BEI file to indicate that all equipment within the same TYP-FM should be correlated by the SAPHIRE model. SAPHIRE then would sample from one distribution and then use this sampled probability for all other basic events with the same correlation class.

The template data was also identified by TYP-FM combination and was utilized by the fault tree models by being imported into SAPHIRE using the MAR-D portion of the code, then by using the Modify Event feature to link the template data to each basic event in the fault tree. This permitted each active component of the same type and failure mode to utilize the same failure estimate and uncertainty information, based on the results of the industry-wide data investigation and Bayesian combination process.

Table C4-1 shows the active component reliability estimates that were input to SAPHIRE as template data for fault tree model quantification.

Table C4-1. Active Component Reliability Estimates Entered into SAPHIRE Models

TYP-FM	Component Name & Failure Mode	Dist Type	Uncert Value	Demand Probability	Hourly Failure Rate	Number of Inputs	Input Data Sources ^a
AHU-FTR	Air Handling Unit Failure to Run	G	5.00E-01 ^b		3.80E-06 ^b	1 source; N/D	NUREG/CR-6928 (Ref. C5. 16)
ALM-SPO	Alarm/Annunciator Spurious Operation	L	1.30E+01		4.74E-07	5 sources N/D; 1 source mean	IEEE-500 (Ref. C5.23), NPRD-95 (Ref. C5.40)
AT-FOH	Actuator (Electrical) Failure	L	1.24E+01		7.54E-05	3 sources; N/D	NPRD-95 (Ref. C5.40)
ATH-FOH	Actuator (Hydraulic) Failure	L	3.81E+01		8.91E-04	4 sources; N/D	NPRD-95 (Ref. C5.40)
ATP-SPO	Actuator (Pneumatic Piston) Spurious Operation	L	5.00E+00		1.34E-06	1 source; mean + EF	NPRD-95 (Ref. C5.40)
AXL-FOH	Axle Failure	G	5.00E-01 ^b		1.60E-08	1 source; N/D	NPRD-95 (Ref. C5.40)
B38-FOH	Bearing Failure	L	1.13E+01		2.50E-06	8 sources; N/D	NPRD-95 (Ref. C5.40)
BEA-BRK	Lifting Beam/Boom Breaks	G	1.50E+00		2.40E-08	1 source; N/D	NPRD-95 (Ref. C5.40)
BLD-RUP	Air Bag Ruptures	B	1.10E+04	1.36E-04		1 source; N/D	BSC 2007 (Ref. C5.7)
BLK-FOD	Block or Sheaves Failure on Demand	B	1.30E+06	1.15E-06		1 source; N/D	NPRD-95 (Ref. C5.40)
BRH-FOD	Brake (Hydraulic) Failure on Demand	L	5.50E+01	8.96E-06		3 sources N/D; 1 source mean + EF	NPRD-95 (Ref. C5.40)
BRK-FOD	Brake Failure on Demand	L	6.30E+00	1.46E-06		3 sources; mean + EF	EPRI PRA (Ref. C5.8)
BRK-FOH	Brake (Electric) Failure	G	2.50E+00		4.40E-06	1 source; N/D	NPRD-95 (Ref. C5.40)
BRP-FOD	Brake (Pneumatic) Failure on Demand	L	2.55E+00	5.02E-05		4 sources; N/D	NPRD-95 (Ref. C5.40)
BRP-FOH	Brake (Pneumatic) Failure	L	2.55E+00		8.38E-06	4 sources; N/D	NPRD-95 (Ref. C5.40)
BTR-FOD	Battery No Output Given Challenge	B	6.05E+01	8.20E-03		1 source; N/D	NUREG/CR-4639 (Ref. C5.39)
BTR-FOH	Battery Failure	L	4.30E+00		4.29E-06	12 sources N/D; 8 sources mean + EF	CCPS (Ref. C5.1), N-Reactor (Ref. C5.46), NPRD-95 (Ref. C5.40), NUREG/CR-4639 (Ref. C5.39), NUREG/CR-6928 (Ref. C5. 16), SAIC Umatilla (Ref. C5.41)
BUA-FOH	AC Bus Failure	L	3.08E+00		6.10E-07	3 sources; N/D	IEEE 493 (Ref. C5. 22), NUREG/CR-6928 (Ref. C5. 16)

C-36

March 2008

Table C4-1. Active Component Reliability Estimates Entered into SAPHIRE Models (Continued)

TYP-FM	Component Name & Failure Mode	Dist Type	Uncert Value	Demand Probability	Hourly Failure Rate	Number of Inputs	Input Data Sources ^a
BUD-FOH	DC Bus Failure	L	8.70E+01		2.40E-07	1 source mean + EF	IEEE-500 (Ref. C5.23)
BYC-FOH	Battery Charger Failure	L	1.00E+01		7.60E-06	1 source mean + EF	CCPS (Ref. C5.1)
C52-FOD	Circuit Breaker (AC) Fails on Demand	L	9.80E+00	2.24E-03		19 sources N/D; 1 source mean + EF	CCPS (Ref. C5.1), NUREG/CR-4639 (Ref. C5.39), SAIC Umatilla (Ref. C5.41), SRS Reactors (Ref. C5.5)
C52-SPO	Circuit Breaker (AC) Spurious Operation	L	2.29E+01		5.31E-06	12 sources N/D; 1 source mean + EF	CCPS (Ref. C5.1), MIL-HDBK-217F (Ref. C5.12), NUREG/CR-6928 (Ref. C5.16), NUREG/CR-4639 (Ref. C5.39), SAIC Umatilla (Ref. C5.41)
C72-SPO	Circuit Breaker (DC) Spurious Operation	L	1.20E+00		1.07E-06	3 sources N/D; 1 source mean + EF	CCPS (Ref. C5.1), MIL-HDBK-217F (Ref. C5.12), NUREG/CR-4639 (Ref. C5.39), NUREG/CR-6928 (Ref. C5.16)
CAM-FOH	Cam Lock Fails	L	8.30E+01		3.19E-06	4 sources N/D; 1 source mean + EF	NPRD-95 (Ref. C5.40)
CBP-OPC	Cables (Electrical Power) Open Circuit	G	5.00E-01		9.13E-08	1 source; N/D	NPRD-95 (Ref. C5.40)
CBP-SHC	Cables (Electrical Power) Short Circuit	G	5.00E-01		1.88E-08	1 source; N/D	NPRD-95 (Ref. C5.40)
CKV-FOD	Check Valve Fails on Demand	L	1.36E+01	6.62E-04		4 sources N/D; 7 sources mean + EF	CCPS (Ref. C5.1), N-Reactor (Ref. C5.46), NUREG/CR-4639 (Ref. C5.39), NUREG/CR-6928 (Ref. C5.16), SRS Reactors (Ref. C5.5)
CKV-FTX	Check Valve Fails to Check	L	1.50E+01	2.20E-03		1 source; mean + EF	CCPS (Ref. C5.1)
CON-FOH	Electrical Connector (Site Transporter) Failure	G	5.00E-01		7.14E-05	1 source; N/D	NPRD-95 (Ref. C5.40)
CPL-FOH	Coupling (Automatic) Failure	L	5.00E+00		1.90E-06	1 source mean + EF	AIAA (Ref. C5.11)
CPO-FOH	Control System Onboard [TEV or Trolley] Failure	G	9.85E+01		2.10E-08	1 source; N/D	NPRD-95 (Ref. C5.40)
CRD-FOH	Card Reader Failure	L	5.00E+00		4.55E-05	1 source mean + EF	HID (Ref. C5.21)

Table C4-1. Active Component Reliability Estimates Entered into SAPHIRE Models (Continued)

TYP-FM	Component Name & Failure Mode	Dist Type	Uncert Value	Demand Probability	Hourly Failure Rate	Number of Inputs	Input Data Sources ^a
CRJ-DRP	Jib Crane Drop	B	9.72E+04	2.60E-05		1 source; N/D	NUREG-1774 (Ref. C5.26)
CRN-DRP	200 Ton Crane Drop	L	4.35E+01	3.21E-05		2 sources N/D; 4 sources mean + EF	NUREG-0612 (Ref. C5.35), NUREG-1774 (Ref. C5.26), EPRI PRA (Ref. C5.8)
CRN-TBK	200 Ton Crane Two Block Drop	L	1.15E+01	4.41E-07		1 source N/D; 3 sources mean + EF	NUREG-0612 (Ref. C5.35), NUREG-1774 (Ref. C5.26)
CRS-DRP	200 Ton Crane Sling Drop	B	2.06E+04	1.21E-04		1 source; N/D	NUREG-1774 (Ref. C5.26)
CRW-DRP	WP (Non-Single Failure Proof) Crane Drop	B	3.34E+04	1.05E-04		1 source; N/D	NUREG-1774 (Ref. C5.26)
CRW-TBK	WP (Non-Single Failure Proof) Crane Two Block Drop	B	3.34E+04	4.49E-05		1 source; N/D	NUREG-1774 (Ref. C5.26)
CSC-FOH	Cask Cradle Failure	G	1.50E+00		4.81E-08	1 source; N/D	NPRD-95 (Ref. C5.40)
CT-FOD	Controller Mechanical Jamming	L	5.00E+00 ^b	4.00E-06		1 source; mean + EF	EPRI PRA (Ref. C5.8)
CT-FOH	Controller Failure	L	1.00E+01		6.88E-05	1 source mean + EF	CCPS (Ref. C5.1)
CT-SPO	Controller Spurious Operation	L	1.00E+01		2.27E-05	1 source mean + EF	CCPS (Ref. C5.1)
CTL-FOD	Logic Controller Fails on Demand	L	1.10E+01	2.03E-03		3 sources; N/D	NUREG/CR-6928 (Ref. C5.16)
DER-FOM	Derailment Failure per Mile	G	3.97E+03		1.18E-05	1 source; N/D	Federal Railroad Administration (Ref. C5.17)
DG-FTR	Diesel Generator Fails to Run	L	1.51E+01		4.08E-03	8 sources N/D; 1 source mean + EF	CCPS (Ref. C5.1), IEEE 493 (Ref. C5.22), NUREG/CR-4639 (Ref. C5.39), NUREG/CR-3831 (Ref. C5.24), NUREG/CR-6890 (Ref. C5.15), NUREG/CR-6928 (Ref. C5.16), SAIC Umatilla (Ref. C5.41), SRS Reactors (Ref. C5.5)

Table C4-1. Active Component Reliability Estimates Entered into SAPHIRE Models (Continued)

TYP-FM	Component Name & Failure Mode	Dist Type	Uncert Value	Demand Probability	Hourly Failure Rate	Number of Inputs	Input Data Sources ^a
DG-FTS	Diesel Generator Fails to Start	L	3.50E+00	8.38E-03		9 sources N/D; 1 source mean + EF	CCPS (Ref. C5.1), IEEE 493 (Ref. C5.22), NUREG/CR-4639 (Ref. C5.39), NUREG/CR-3831 (Ref. C5.24), NUREG/CR-6890 (Ref. C5.15), NUREG/CR-6928 (Ref. C5.16), SAIC Umatilla (Ref. C5.41), SRS Reactors (Ref. C5.5)
DGS-FTR	Diesel Generator - Seismic - Fails to Run for 29 Days	G	5.05E+01		8.27E-04	1 source, N/D	NUREG/CR-6890 (Ref. C5.15)
DM-FOD	Drum Failure on Demand	L	1.00E+01	4.00E-08		2 sources mean + EF	EPRI PRA (Ref. C5.8)
DM-MSP	Drum Mis-spooling (Hourly)	G	5.00E-01		6.86E-07	1 source, N/D	NPRD-95 (Ref. C5.40)
DMP-FOH	Damper (Manual) Fails to Operate	L	4.30E+00		5.94E-06	3 sources mean + EF	IEEE-500 (Ref. C5.23), N-Reactor (Ref. C5.46), Moss (Ref. C5.32)
DMP-FRO	Damper (Manual) Fails to Remain Open (Transfers Closed)	L	3.20E+00		8.38E-08	2 sources N/D; 2 sources mean + EF	NUREG/CR-3154 (Ref. C5.6), NUREG/CR-1363 (Ref. C5.28), NUREG/CR-4639 (Ref. C5.39), SAIC Umatilla (Ref. C5.41)
DMS-FOH	Demister (Moisture Separator) Failure	L	5.00E+00		9.12E-06	1 source mean + EF	EPRI AP-2071 (Ref. C5.10)
DRV-FOH	Drive (Adjustable Speed) Failure	G	5.0E-01		2.5E-04	1 source; N/D	NPRD-95 (Ref. C5.40)
DRV-FSO	Drive (Adjustable Speed) Failure to Stop on Demand	B	2.5E+02		3.4E-05	1 source; N/D	NPRD-95 (Ref. C5.40)
DTC-RUP	Duct Ruptures	L	2.6E+01		3.7E-06	9 sources N/D; 1 source mean + EF	NPRD-95 (Ref. C5.40), SRS Reactors (Ref. C5.5), SAIC Umatilla (Ref. C5.41)
DTM-FOD	Damper (Tornado) Failure on Demand	L	5.0E+00	8.7E-04		1 source; mean + EF	IEEE-500 (Ref. C5.23)
DTM-FOH	Damper (Tornado) Failure	L	7.9E+00		2.3E-05	2 sources N/D; 1 source mean + EF	IEEE-500 (Ref. C5.23), Moss (Ref. C5.32)
ECP-FOH	Position Encoder Failure	G	5.0E-01		1.8E-06	2 sources; N/D	NPRD-95 (Ref. C5.40)

Table C4-1. Active Component Reliability Estimates Entered into SAPHIRE Models (Continued)

TYP-FM	Component Name & Failure Mode	Dist Type	Uncert Value	Demand Probability	Hourly Failure Rate	Number of Inputs	Input Data Sources ^a
ESC-FOD	Emergency Stop Button Controller Failure to Stop (on Demand)	L	5.0E+00	2.5E-04		1 source; mean + EF	EPRI PRA (Ref. C5.8)
FAN-FTR	Fan (Motor-Driven) Fails to Run	L	4.6E+01		7.21E-05	11 sources N/D; 6 sources mean + EF	CCPS (Ref. C5.1), N-Reactor (Ref. C5.46), NPRD-95 (Ref. C5.40), NUREG/CR-4639 (Ref. C5.39), NUREG/CR-6928 (Ref. C5.16), SAIC Umatilla (Ref. C5.41), SRS Reactors (Ref. C5.5)
FAN-FTS	Fan (Motor-Driven) Fails to Start on Demand	L	1.0E+01	2.0E-03		7 sources N/D; 5 sources mean + EF	CCPS (Ref. C5.1), N-Reactor (Ref. C5.46), NPRD-95 (Ref. C5.40), NUREG/CR-4639 (Ref. C5.39), NUREG/CR-6928 (Ref. C5.16), SAIC Umatilla (Ref. C5.41), SRS Reactors (Ref. C5.5)
FRK-PUN	Forklift Puncture	L	1.06E+01		1.20E-05	1 source mean + EF	SAIC Umatilla (Ref. C5.41)
G65-FOH	Governor Failure	G	1.82E+02		1.16E-05	1 source; N/D	NPRD-95 (Ref. C5.40)
GPL-FOD	Grapple Failure on Demand	B	1.30E+06	1.15E-06		1 source; N/D	NPRD-95 (Ref. C5.40)
GRB-FOH	Gear Box Failure	L	1.40E+01		2.21E-04	1 source N/D; 1 source mean + EF	NPRD-95 (Ref. C5.40)
GRB-SHH	Gear box Shaft/Coupling Shears	L	5.00E+00		2.40E-06	1 source; mean + EF	EPRI PRA (Ref. C5.8)
GRB-STH	Gear Box Stripped	L	5.00E+00		7.86E-08	1 source; mean + EF	NPRD-95 (Ref. C5.40)
HC-FOD	Hand Held Radio Remote Controller Failure to Stop (on Demand)	L	8.39E+01	1.74E-03		1 source N/D; 3 sources mean + EF	EPRI PRA (Ref. C5.8), NPRD-95 (Ref. C5.40)
HC-SPO	Hand Held Radio Remote Controller Spurious Operation	G	5.00E-01		5.23E-07	1 source N/D	NPRD-95 (Ref. C5.40)
HEP-LEK	Filter (HEPA) Leaks [Bypassed]	L	1.00E+01		3.00E-06	1 source; mean + EF	SRS Reactors (Ref. C5.5)
HEP-PLG	Filter (HEPA) Plugs	L	9.5E+00		4.3E-06	3 sources N/D; 2 sources mean + EF	IEEE-500 (Ref. C5.23), NUREG/CR-4639 (Ref. C5.39), SAIC Umatilla (Ref. C5.41)

Table C4-1. Active Component Reliability Estimates Entered into SAPHIRE Models (Continued)

TYP-FM	Component Name & Failure Mode	Dist Type	Uncert Value	Demand Probability	Hourly Failure Rate	Number of Inputs	Input Data Sources ^a
HOS-LEK	Hose Leaking	L	2.47E+01		1.48E-05	same as HOS-RUP with factor of 10	CCPS (Ref. C5.1), NPRD-95 (Ref. C5.40), SAIC Umatilla (Ref. C5.41), SRS Reactors (Ref. C5.5)
HOS-RUP	Hose Ruptures	L	2.47E+01		1.48E-06	2 sources N/D; 3 sources mean + EF	CCPS (Ref. C5.1), NPRD-95 (Ref. C5.40), SAIC Umatilla (Ref. C5.41), SRS Reactors (Ref. C5.5)
IEL-FOD	Interlock Failure on Demand	L	5.0E+00	2.8E-05		1 source; mean + EF	NPRD-95 (Ref. C5.40)
IEL-FOH	Interlock Failure	L	5.50E+01		3.43E-05	4 sources; N/D	NPRD-95 (Ref. C5.40)
LC-FOD	Level Controller Failure on Demand	B	6.07E+03	6.25E-04		1 source; N/D	NUREG/CR-6928 (Ref. C5.16)
LRG-FOH	Lifting Rig or Hook Failure	G	4.65E+01		7.45E-07	1 source; N/D	NPRD-95 (Ref. C5.40)
LVR-FOH	Lever (two position; up-down) Failure	G	9.85E+01		2.10E-06	1 source; N/D	NPRD-95 (Ref. C5.40)
MCC-FOH	Motor Control Centers (MCCs) Failure	L	1.00E+01		7.49E-06	composite of Relay (RLY-FTP) + Motor Starter (MST FOH) + Limit Switch (ZS-FOH)	
MOE-FOD	Motor (Electric) Fails on Demand	L	5.00E+00	6.00E-05		1 source; mean + EF	EPRI PRA (Ref. C5.8)
MOE-FSO	Motor (Electric) Fails to Shut Off	L	1.07E+01		1.35E-08	1 source N/D; 1 source mean + EF	CCPS (Ref. C5.1), MIL-HDBK-217F (Ref. C5.12)
MOE-FTR	Motor (Electric) Fails to Run	L	9.50E+00		6.50E-06	8 sources N/D; 2 sources mean + EF	NPRD-95 (Ref. C5.40), NSWC-98-LE1 (Ref. C5.37), NUREG/CR-4639 (Ref. C5.39), OREDA-2002 (Ref. C5.43)
MOE-FTS	Motor (Electric) Fails to Start (Hourly)	L	1.90E+01		7.14E-06	5 sources N/D; 2 sources mean + EF	NPRD-95 (Ref. C5.40)
MOE-SPO	Motor (Electric) Spurious Operation	L	1.07E+01		6.74E-07	1 source N/D; 1 source mean + EF	CCPS (Ref. C5.1), MIL-HDBK-217F (Ref. C5.12)
MSC-FOH	Motor Speed Control Module Failure	G	5.00E-01		1.28E-04	1 source; N/D	NPRD-95 (Ref. C5.40)
MST-FOH	Motor Starter Failure	L	1.33E+00		1.43E-07	2 sources; N/D	IEEE 493 (Ref. C5.22)

Table C4-1. Active Component Reliability Estimates Entered into SAPHIRE Models (Continued)

TYP-FM	Component Name & Failure Mode	Dist Type	Uncert Value	Demand Probability	Hourly Failure Rate	Number of Inputs	Input Data Sources ^a
NZL-FOH	Nozzle Failure	L	7.50E+00		2.85E-06	5 sources N/D; 1 source mean + EF	IEEE-500 (Ref. C5.23), NPRD-95 (Ref. C5.40), SAIC Umatilla (Ref. C5.41)
PIN-BRK	Pin (Locking or Stabilization) Breaks	L	1.46E+00		2.12E-09	4 sources; N/D	NPRD-95 (Ref. C5.40)
PLC-FOD	Programmable Logic Controller Fails on Demand	B	1.35E+03	3.69E-04		1 source; N/D	NPRD-95 (Ref. C5.40)
PLC-FOH	Programmable Logic Controller Fails to Operate	L	1.00E+01		3.26E-06	5 sources N/D; 1 source mean + EF	MIL-HDBK-217F (Ref. C5.12), NPRD-95 (Ref. C5.40), SAIC Umatilla (Ref. C5.41)
PLC-SPO	Programmable Logic Controller Spurious Operation	L	1.00E+01		3.65E-07	5 sources N/D; 1 source mean + EF	MIL-HDBK-217F (Ref. C5.12), NPRD-95 (Ref. C5.40), SAIC Umatilla (Ref. C5.41)
PMD-FTR	Pump (Motor Driven) Fails to Run	L	9.9E+00		3.5E-05	6 sources N/D; 87 sources mean + EF	CCPS (Ref. C5.1), N-Reactor (Ref. C5.46), NUREG/CR-4639 (Ref. C5.39), NUREG/CR-1205 (Ref. C5.45), NUREG/CR-2886 (Ref. C5.13), NUREG/CR-6928 (Ref. C5.16), OREDA-2002 (Ref. C5.43), SAIC Umatilla (Ref. C5.41), SRS Reactors (Ref. C5.5)
PMD-FTS	Pump (Motor Driven) Fails to Start on Demand	L	3.80E+00	2.50E-03		7 sources N/D; 80 sources mean + EF	N-Reactor (Ref. C5.46), NUREG/CR-4639 (Ref. C5.39), NUREG/CR-1205 (Ref. C5.45), NUREG/CR-2886 (Ref. C5.13), NUREG/CR-6928 (Ref. C5.16), OREDA-2002 (Ref. C5.43), SAIC Umatilla (Ref. C5.41), SRS Reactors (Ref. C5.5)
PPL-RUP	Piping (Lined) Catastrophic	L	1.50E+01		4.42E-07	1 source; mean + EF	CCPS (Ref. C5.1)
PPM-PLG	Piping (Water) Plugs	L	1.35E+01		7.26E-07	1 source N/D; 2 sources mean + EF	DuPont (Ref. C5.14), EPRI Pipe Failure Study (Ref. C5.10), SAIC Umatilla (Ref. C5.41)
PPM-RUP	Piping (Water) Ruptures	L	2.00E+01		8.75E-10	1 source; mean + EF	NUREG/CR-6928 (Ref. C5.16)
PR-FOH	Passive restraint (bumper) Failure	G	2.09E+02		4.45E-10	1 source; N/D	NPRD-95 (Ref. C5.40)

Table C4-1. Active Component Reliability Estimates Entered into SAPHIRE Models (Continued)

TYP-FM	Component Name & Failure Mode	Dist Type	Uncert Value	Demand Probability	Hourly Failure Rate	Number of Inputs	Input Data Sources ^a
PRM-FOH	eProm (HVAC Speed Control) Failure	G	5.00E-01		5.38E-07	1 source; N/D	MIL-HDBK-217F (Ref. C5.12)
PRV-FOD	Pressure Relief Valve Fails on Demand	L	2.72E+01	6.54E-03		6 sources N/D; 2 sources mean + EF	CCPS (Ref. C5.1), NUREG/CR-4639 (Ref. C5.39), NUREG/CR-6928 (Ref. C5.16)
PV-SPO	Pneumatic Valve Spurious Operation	G	5.00E-01		2.92E-05	1 source; N/D	NPRD-95 (Ref. C5.40)
QDV-FOH	Quick Disconnect Valve Failure	L	3.56E+00		4.26E-06	4 sources N/D	NPRD-95 (Ref. C5.40)
RCV-FOH	Air Receiver Fails to Supply Air	L	1.00E+01		6.00E-07	1 source; mean + EF	IEEE-500 (Ref. C5.23)
RLY-FTP	Relay (Power) Fails to Close/Open	G	5.00E-01		8.77E-06	1 source N/D	NPRD-95 (Ref. C5.40)
SC-FOH	Speed Control Failure	G	5.00E-01		1.28E-04	1 source N/D	NPRD-95 (Ref. C5.40)
SC-SPO	Speed Control Spurious Operation	G	5.00E-01		3.20E-05	1 source N/D	NPRD-95 (Ref. C5.40)
SEL-FOH	Speed Selector Fails	L	5.34E+00		4.16E-06	3 sources N/D	NPRD-95 (Ref. C5.40)
SEQ-FOD	Sequencer Fails on Demand	B	7.49E+02	3.33E-03		1 source N/D	NUREG/CR-6928 (Ref. C5.16)
SFT-COL	Spent Fuel Transfer Machine (SFTM) Collision or Impact	L	4.00E+00	2.94E-06		2 sources N/D	NUREG-1774 (Ref. C5.26), McKenna (Ref. C5.20)
SFT-DRP	Spent Fuel Transfer Machine (SFTM) Drop	L	3.00E+00	5.15E-06		2 sources N/D	NUREG-1774 (Ref. C5.26), McKenna (Ref. C5.20)
SFT-RTH	Spent Fuel Transfer Machine (SFTM) Raised Fuel Too High	L	7.00E+00	7.36E-07		2 sources N/D	NUREG-1774 (Ref. C5.26), McKenna (Ref. C5.20)
SJK-FOH	Screw Jack [TEV] Failure	G	5.00E-01		8.14E-06	1 source; N/D	NPRD-95 (Ref. C5.40)
SRF-FOH	Flow Sensor Failure	G	5.00E-01		1.07E-06	1 source; N/D	NUREG/CR-4639 (Ref. C5.39)
SRP-FOD	Pressure Sensor Fails on Demand	B	1.25E+02	4.00E-03		1 source; N/D	NPRD-95 (Ref. C5.40)
SRP-FOH	Pressure Sensor Fails	L	1.21E+01		2.95E-06	8 sources N/D	NPRD-95 (Ref. C5.40), NUREG/CR-6928 (Ref. C5.16)
SRR-FOH	Radiation Sensor Fails	L	5.00E+00		2.00E-05	1 source; mean + EF	Laurus (Ref. C5.25)
SRS-FOH	OverSpeed Sensor Fails	G	1.28E+02		2.14E-05	1 source; N/D	NPRD-95 (Ref. C5.40)

Table C4-1. Active Component Reliability Estimates Entered into SAPHIRE Models (Continued)

TYP-FM	Component Name & Failure Mode	Dist Type	Uncert Value	Demand Probability	Hourly Failure Rate	Number of Inputs	Input Data Sources ^a
SRT-FOD	Temperature Sensor/Transmitter Fails on Demand	L	2.10E+00	7.33E-04		2 sources N/D	NUREG/CR-6928 (Ref. C5.16), OREDA-92 (Ref. C5.42)
SRT-FOH	Temperature Sensor/Transmitter Fails	L	1.41E+01		7.05E-07	4 sources N/D; 2 sources mean + EF	NPRD-95 (Ref. C5.40), NUREG/CR-6928 (Ref. C5.16), OREDA-2002 (Ref. C5.43)
SRT-SPO	Temperature Sensor Spurious Operation	L	2.80E+01		2.23E-06	1 source; mean + EF	OREDA-2002 (Ref. C5.43)
SRU-FOH	Ultrasonic Sensor Fails	G	5.00E-01		9.62E-05	1 source; N/D	NPRD-95 (Ref. C5.40)
SRV-FOH	Vibration Sensor (Accelerometer) Fails	L	1.07E+01		9.40E-05	4 sources N/D	NPRD-95 (Ref. C5.40)
SRX-FOD	Optical Position Sensor Fails on Demand	B	3.18E+03	1.10E-03		1 source; N/D	SAIC Umatilla (Ref. C5.41)
SRX-FOH	Optical Position Sensor Fails	L	5.00E+00		4.70E-06	1 source; mean + EF	NPRD-95 (Ref. C5.40)
STU-FOH	Structure (truck or railcar) Failure	G	1.50E+00		4.81E-08	1 source; N/D	NPRD-95 (Ref. C5.40)
SV-FOD	Solenoid Valve Fails on Demand	L	1.17E+01	6.28E-04		4 sources N/D; 5 sources mean + EF	CCPS (Ref. C5.1), N-Reactor (Ref. C5.46), NSWC-98-LE1 (Ref. C5.37), NUREG/CR-4639 (Ref. C5.39), NUREG/CR-6928 (Ref. C5.16), SRS Reactors (Ref. C5.5)
SV-FOH	Solenoid Valve Fails	L	1.70E+01		4.87E-05	1 source; mean + EF	CCPS (Ref. C5.1)
SV-SPO	Solenoid Valve Spurious Operation	L	3.00E+00		4.09E-07	1 source; mean + EF	CCPS (Ref. C5.1)
SWA-FOH	Auto-Stop Switch (CTT hose travel) Fails	G	6.50E+00		3.12E-06	1 source; N/D	NPRD-95 (Ref. C5.40)
SWG-FOH	13.8kV Switchgear Fails	G	2.85E+01		1.31E-07	1 source; N/D	IEEE 493 (Ref. C5.22)
SWP-FTX	Electric Power Switch Fails to Transfer	G	6.50E+00		3.59E-07	1 source; N/D	IEEE 493 (Ref. C5.22)
SWP-SPO	Electric Power Switch Spurious Transfer	G	6.50E+00		1.55E-07	1 source; N/D	IEEE 493 (Ref. C5.22)
TD-FOH	Transducer Failure	L	4.70E+00		9.84E-05	3 sources N/D; 1 source mean + EF	NPRD-95 (Ref. C5.40)

C-44

March 2008

Table C4-1. Active Component Reliability Estimates Entered into SAPHIRE Models (Continued)

TYP-FM	Component Name & Failure Mode	Dist Type	Uncert Value	Demand Probability	Hourly Failure Rate	Number of Inputs	Input Data Sources ^a
TDA-FOH	Transducer (Air Flow) Failure	L	6.21E+00		1.65E-04	2 sources N/D	NPRD-95 (Ref. C5.40), NSWC-98-LE1 (Ref. C5.37)
TDP-FOH	Transducer (Pressure) Fails	L	5.35E+01		2.20E-04	23 sources N/D; 2 sources mean + EF	NPRD-95 (Ref. C5.40), NSWC-98-LE1 (Ref. C5.37)
TDT-FOH	Transducer (Temperature) Fails	L	2.95E+01		1.04E-04	12 sources N/D; 1 source mean + EF	NPRD-95 (Ref. C5.40)
THR-BRK	Third Rail Breaks	L	1.00E+01		1.01E-08	1 source; mean + EF	NPRD-95 TRK-BRK adjusted with failure information from Federal Railroad Administration Safety Data website (Ref. C5.17)
TKF-FOH	Fuel Tank Fails	L	1.11E+01		4.40E-07	15 sources; N/D	NPRD-95 (Ref. C5.40), NUREG/CR-4639 (Ref. C5.39), NUREG/CR-6928 (Ref. C5.16)
TL-FOH	Torque Limiter Failure	G	8.05E+01		8.05E-05	1 source N/D	NPRD-95 (Ref. C5.40)
TRD-FOH	Tread (Site Transporter)	L	3.40E+00		5.89E-07	1 source N/D; 1 source mean + EF	NPRD-95 (Ref. C5.40), Rand (Ref. C5.38)
UDM-FOH	Damper (Backdraft) Failure	L	7.90E+00		2.26E-05	2 sources N/D; 1 source mean + EF	IEEE-500 (Ref. C5.23), Moss (Ref. C5.32)
UPS-FOH	Uninterruptible Power Supply (UPS) Failure	L	5.08E+00		2.02E-06	10 sources; N/D	NPRD-95 (Ref. C5.40)
WNE-BRK	Wire Rope Breaks	L	5.00E+00	2.00E-06		1 source; mean + EF	EPRI PRA (Ref. C5.8)
XMR-FOH	Transformer Failure	L	1.53E+01		2.91E-07	13 sources N/D; 2 sources mean + EF	CCPS (Ref. C5.1), MIL-HDBK-217F (Ref. C5.12), NPRD-95 (Ref. C5.40), NUREG/CR-4639 (Ref. C5.39), NUREG/CR-6928 (Ref. C5.16)
XV-FOD	Manual Valve Failure on Demand	L	1.00E+01	6.48E-04		3 sources N/D; 12 sources mean + EF	CCPS (Ref. C5.1), N-Reactor (Ref. C5.46), NUREG/CR-4639 (Ref. C5.39), NUREG/CR-6928 (Ref. C5.16), SRS Reactors (Ref. C5.5)
ZS-FOD	Limit Switch Failure on Demand	L	5.7E+00	2.9E-04		3 sources N/D	MIL-HDBK-217F (Ref. C5.12), NPRD-95 (Ref. C5.40), SRS Reactors (Ref. C5.5)

Table C4-1. Active Component Reliability Estimates Entered into SAPHIRE Models (Continued)

TYP-FM	Component Name & Failure Mode	Dist Type	Uncert Value	Demand Probability	Hourly Failure Rate	Number of Inputs	Input Data Sources ^a
ZS-FOH	Limit Switch Fails	L	6.03E+00		7.23E-06	3 sources N/D	MIL-HDBK-217F (Ref. C5.12), NPRD-95 (Ref. C5.40), NUREG/CR-4639 (Ref. C5.39)
ZS-SPO	Limit Switch Spurious Operation	L	5.56E+00		1.28E-06	3 sources N/D	MIL-HDBK-217F (Ref. C5.12), NPRD-95 (Ref. C5.40), NUREG/CR-4639 (Ref. C5.39)

NOTE: ^a Refer to Section C1.2 for specific citation to data sources.

^b There are minor differences between the specific values tagged by this footnote and those used to quantify the SAPHIRE model. Such differences are not meaningful in the context of this analysis because (a) the difference pertains only to the uncertainty of the component reliability or (b) the uncertainty in the reliability value is much greater than difference between the value given here and that used in the model.

B = Beta Distribution; EF = Lognormal Error Factor; G = Gamma Distribution; L = Lognormal Distribution; N/D = Numerator/Denominator

Source: Original

C5 REFERENCES; DESIGN INPUTS

The PCSA is based on a snapshot of the design. The reference design documents are appropriately documented as design inputs in this section. Since the safety analysis is based on a snapshot of the design, referencing subsequent revisions to the design documents (as described in EG-PRO-3DP-G04B-00037, *Calculations and Analyses* (Ref. 2.1.1, Section 3.2.2.F) that implement PCSA requirements flowing from the safety analysis would not be appropriate for the purpose of the PCSA.

The inputs in this Section noted with an (*) indicate that they fall into one of the designated categories described in Section 4.1, relative to suitability for intended use.

- C5.1 *AIChE (American Institute of Chemical Engineers) 1989. *Guidelines for Process Equipment Reliability Data with Data Tables*. G-07. New York, New York: American Institute of Chemical Engineers, Center for Chemical Process Safety. TIC: 259872. ISBN: 978-0-8169-0422-8.
- C5.2 *Apostolakis, G. and Kaplan, S. 1981. "Pitfalls in Risk Calculations." *Reliability Engineering*, 2, 135-145. Barking, England: Applied Science Publishers. TIC: 253648.
- C5.3 ASME NOG-1-2004. 2005. *Rules for Construction of Overhead and Gantry Cranes (Top Running Bridge, Multiple Girder)*. New York, New York: American Society of Mechanical Engineers. TIC: 257672. ISBN: 0-7918-2939-1.
- C5.4 *Atwood, C.L.; LaChance, J.L.; Martz, H.F.; Anderson, D.J.; Englehardt, M.; Whitehead, D.; and Wheeler, T. 2003. *Handbook of Parameter Estimation for Probabilistic Risk Assessment*. NUREG/CR-6823. Washington, D.C.: U.S. Nuclear Regulatory Commission. ACC: MOL.20060126.0121.
- C5.5 *Blanton, C.H. and Eide, S.A. 1993. *Savannah River Site, Generic Data Base Development (U)*. WSRC-TR-93-262. Aiken, South Carolina: Westinghouse Savannah River Company. TIC: 246444.
- C5.6 *Borkowski, R.J.; Kahl, W.K.; Hebble, T.L.; Fragola, J.R.; Johnson, J.W. 1983. *The In-Plant Reliability Data Base for Nuclear Plant Components: Interim Report-The Valve - Component*. NUREG/CR-3154; ORNL/TM-8647. Oak Ridge, TN: Oak Ridge National Laboratory. ACC: MOL.20071129.0315.
- C5.7 BSC 2007 (Bechtel SAIC Company). *Waste Form Throughputs for Preclosure Safety Analysis*. 000-PSA-MGR0-01800-000-00A. Las Vegas, Nevada: Bechtel SAIC Company. ACC: ENG.20071106.0001.
- C5.8 *Canavan, K.; Gregg, B.; Karimi, R.; Mirsky, S.; and Stokley, J. 2004. *Probabilistic Risk Assessment (PRA) of Bolted Storage Casks, Updated Quantification and Analysis Report*. 1009691. Palo Alto, California: Electric Power Research Institute. TIC: 257542.

- C5.9 *Crutchfield, D.M. 1996. "Movement of Heavy Loads Over Spent Fuel, Over Fuel in the Reactor Core, or Over Safety-Related Equipment." NRC Bulletin 96-02. Washington, D.C.: U.S. Nuclear Regulatory Commission. Accessed February 12, 2008. ACC: MOL.20080213.0021. URL: <http://www.nrc.gov/reading-rm/doc-collections/gen-comm/bulletins/1996/b196002.html>
- C5.10 *Derdiger, J.A.;Bhatt, K.M.;Siegfriedt, W.E. 1981. *Component Failure and Repair Data for Coal-Fired Power Units*. EPRI AP-2071. Palo Alto, CA: Electric Power Research Institute. TIC: 260070.
- C5.11 *Dhillon, B.S. 1988. *Mechanical Reliability: Theory, Models and Applications*. AIAA Education Series. Washington, D.C.: American Institute of Aeronautics & Astronautics. TIC: 259878.
- C5.12 *DOD (U.S. Department of Defense) 1991. *Military Handbook, Reliability Prediction of Electronic Equipment*. MIL-HDBK-217F. Washington, D.C.: U.S. Department of Defense. TIC: 232828.
- C5.13 *Drago, J.P.; Borkowski, R.J.; Fragola, J.R.; and Johnson, J.W. 1982. *The In-Plant Reliability Data Base for Nuclear Plant Components: Interim Data Report — The Pump Component*. NUREG/CR-2886. Washington, D.C.: U.S. Nuclear Regulatory Commission. ACC: MOL.20071219.0222.
- C5.14 *E.I. DuPont de Nemours & Company (Inc.) 1981. *Some Published and Estimated Failure Rates for Use in Fault Tree Analysis*. Washington, Delaware: E.I. DuPont de Nemours & Company (Inc). (DIRS 184415)
- C5.15 *Eide, S.A.; Gentillon, C.D.; Wierman, T.E.; and Rasmuson, D.M. 2005. *Analysis of Station Blackout Risk*. Volume 2 of *Reevaluation of Station Blackout Risk at Nuclear Power Plants*. NUREG/CR-6890. Washington, D.C.: U.S. Nuclear Regulatory Commission. ACC: MOL.20071114.0165.
- C5.16 *Eide, S.A.; Wierman, T.E.; Gentillon, C.D.; Rasmuson, D.M.; and Atwood, C.T. 2007. *Industry-Average Performance for Components and Initiating Events at U.S. Commercial Nuclear Power Plants*. NUREG/CR-6928. Washington, D.C.: U.S. Nuclear Regulatory Commission. ACC: MOL.20071211.0229.
- C5.17 *Federal Railroad Administration. 2004. "Train Accidents by Cause from Form FRA F 6180.54." Washington, D.C.: U.S. Department of Transportation, Federal Railroad Administration. Accessed 03/12/2004. ACC: MOL.20040311.0211. URL: <http://safetydata.fra.dot.gov/OfficeofSafety/Query/Default.asp>
- C5.18 *Fleming, K.N. 1975. *A Reliability Model for Common Mode Failures in Redundant Safety Systems*. GA-A13284. San Diego, California: General Atomic Company. ACC: MOL.20071219.0221.

- C5.19 *Fragola, J.R. and McFadden, R.H. 1995. "External Maintenance Rate Prediction and Design Concepts for High Reliability and Availability on Space Station Freedom." *Reliability Engineering and System Safety*, 47, 255-273. New York, New York: Elsevier. TIC: 259675.
- C5.20 *Framatome ANP (Advanced Nuclear Power) 2001. *Summary, Commercial Nuclear Fuel Assembly Damage/Misload Study – 1985-1999*. Lynchburg, Virginia: Framatome Advanced Nuclear Power. ACC: MOL.20011018.0158.
- C5.21 *HID Corporation [n.d.]. *Ruggedized Card Reader/Ruggedized Keypad Card Reader. Dorado 740 and 780*. Irvine, California: HID Corporation. TIC: 260007.
- C5.22 *IEEE (Institute of Electrical and Electronics Engineers) Std 493-1997. 1998. *IEEE Recommended Practice for the Design of Reliable Industrial and Commercial Power Systems*. New York, New York: Institute of Electrical and Electronics Engineers. TIC: 243205. ISBN 1-55937-969-3.
- C5.23 *IEEE Std 500-1984 (Reaffirmed 1991). 1991. *IEEE Guide to the Collection and Presentation of Electrical, Electronic, Sensing Component, and Mechanical Equipment Reliability Data for Nuclear-Power Generating Stations*. New York, New York: Institute of Electrical and Electronics Engineers. TIC: 256281.
- C5.24 *Kahl, W.K. and Borkowski, R.J. 1985. *The In-Plant Reliability Data Base for Nuclear Plant Components: Interim Report - Diesel Generators, Batteries, Chargers, and Inverters*. NUREG/CR-3831. Washington, D.C.: U.S. Nuclear Regulatory Commission. ACC: MOL.20071212.0181.
- C5.25 *Laurus Systems [n.d.]. *Instruments and Software Solutions for Emergency Response and Health Physics*. Ellicott City, Maryland: Laurus Systems. TIC: 259965.
- C5.26 Lloyd, R.L. 2003. *A Survey of Crane Operating Experience at U.S. Nuclear Power Plants from 1968 through 2002*. NUREG-1774. Washington, D.C.: U.S. Nuclear Regulatory Commission. ACC: MOL.20050802.0185.
- C5.27 *Lopez Droguett, E.; Groen, F.; and Mosleh, A. 2004. "The Combined Use of Data and Expert Estimates in Population Variability Analysis." *Reliability Engineering and System Safety*, 83, 311-321. New York, New York: Elsevier. TIC: 259380.
- C5.28 *Miller, C.F.; Hubble, W.H.; Trojovsky, M.; and Brown, S.R. 1982. *Data Summaries of Licensee Event Reports of Valves at U.S. Commercial Nuclear Power Plants from January 1, 1976 to December 31, 1980*. NUREG/CR-1363, Rev. 1. Washington, D.C.: U.S. Nuclear Regulatory Commission. ACC: MOL.20071219.0223.
- C5.29 *Mosleh, A.; Fleming, K.N.; Parry, G.W.; Paula, H.M.; Worledge, D.H.; and Rasmuson, D.M. 1988. *Analytical Background and Techniques. Volume 2 of Procedures for Treating Common Cause Failures in Safety and Reliability Studies*. NUREG/CR-4780. Washington, D.C.: U.S. Nuclear Regulatory Commission. TIC: 221775.

- C5.30 *Mosleh, A.; Fleming, K.N.; Parry, G.W.; Paula, H.M.; Worledge, D.H.; and Rasmuson, D.M. 1988. *Procedural Framework and Examples*. Volume 1 of *Procedures for Treating Common Cause Failures in Safety and Reliability Studies*. NUREG/CR-4780. Washington, D.C.: U.S. Nuclear Regulatory Commission. TIC: 221775.
- C5.31 *Mosleh, A.; Rasmuson, D.M.; and Marshall, F.M. 1998. *Guidelines on Modeling Common-Cause Failures in Probabilistic Risk Assessment*. NUREG/CR-5485. Washington, D.C.: U.S. Nuclear Regulatory Commission. ACC: MOL.20040220.0106.
- C5.32 *Moss, T.R. 2005. *The Reliability Data Handbook*. 1st Edition. New York, NY: ASME Press (American Society of Mechanical Engineers). ISBN: 0-7918-0233-7. TIC: 259912.
- C5.33 Not Used.
- C5.34 NRC (U.S. Nuclear Regulatory Commission) 1979. *Single-Failure-Proof Cranes for Nuclear Power Plants*. NUREG-0554. Washington, D.C.: U.S. Nuclear Regulatory Commission. TIC: 232978.
- C5.35 NRC 1980. *Control of Heavy Loads at Nuclear Power Plants*. NUREG-0612. Washington, D.C.: U.S. Nuclear Regulatory Commission. TIC: 209017.
- C5.36 NRC 2005. *CCF Parameter Estimation 2005*. Washington, D.C.: Nuclear Regulatory Commission (NRC). ACC: MOL.20080213.0022.
- C5.37 *NSWC (Naval Surface Warfare Center) 1998. *Handbook of Reliability Prediction Procedures for Mechanical Equipment*. NSWC-98/LE1. West Bethesda, Maryland: Naval Surface Warfare Center, Carderock Division. TIC: 245703.
- C5.38 *Peltz, E.; Robbins, M.; Boren, P.; Wolff, M. 2002. "Using the EDA to Gain Insight into Failure Rates.z" *Diagnosing the Army's Equipment Readiness: The Equipment Downtime Analyzer*. Santa Monica, CA: RAND. TIC: 259917. ISBN: 0-8330-3115-5.
- C5.39 *Reece, W.J.; Gilbert, B.G.; and Richards, R.E. 1994. *Nuclear Computerized Library for Assessing Reactor Reliability (NUCLARR), Volume 5: Data Manual, Part 3: Hardware Component Failure Data*. NUREG/CR-4639, Vol. 5, Rev. 4. Washington, D.C.: U.S. Nuclear Regulatory Commission. ACC: MOL.20071220.0209.
- C5.40 *Denson, W.; Chandler, G.; Crowell, W.; Clark, A.; and Jaworski, P. 1994. *Nonelectronic Parts Reliability Data 1995*. NPRD-95. Rome, New York: Reliability Analysis Center. TIC: 259757.
- C5.41 *SAIC (Science Applications International Corporation) 2002. *Umatilla Chemical Agent Disposal Facility Quantitative Risk Assessment*. Report No. SAIC-00/2641. Volume I. Abingdon, Maryland: Science Applications International Corporation. ACC: MOL.20071220.0210.

- C5.42 *SINTEF Industrial Management 1992. *OREDA, Offshore Reliability Data Handbook*. 2nd Edition. Trondheim, Norway: OREDA. ISBN: 825150188.1
- C5.43 *SINTEF Industrial Management 2002. *OREDA, Offshore Reliability Data Handbook*. 4th Edition. Trondheim, Norway: OREDA. ISBN: 8214027055. TIC: 257402.
- C5.44 *Siu, N.O. and Kelly, D.L. 1998. "Bayesian Parameter Estimation in Probabilistic Risk Assessment." *Reliability Engineering and System Safety*, 62, 89-116. New York, New York: Elsevier. TIC: 258633.
- C5.45 *Trojovsky, M. 1982. *Data Summaries of Licensee Event Reports of Pumps at U.S. Commercial Nuclear Power Plants, January 1, 1972 to April 30, 1980*. NUREG/CR-1205, Rev. 1. Washington, D.C.: U.S. Nuclear Regulatory Commission. ACC: MOL.20080207.0024.
- C5.46 *Zentner, M.D.; Atkinson, J.K.; Carlson, P.A.; Coles, G.A.; Leitz, E.E.; Lindberg, S.E.; Powers, T.B.; and Kelly, J.E. 1988. *N Reactor Level 1 Probabilistic Risk Assessment: Final Report*. WHC-SP-0087. Richland, Washington: Westinghouse Hanford Company. ACC: MOL.20080207.0021.

ATTACHMENT D
PASSIVE EQUIPMENT FAILURE ANALYSIS

CONTENTS

	Page
ACRONYMS AND ABBREVIATIONS	D-5
D1 LOSS OF CONTAINMENT DUE TO DROPS AND IMPACTS	D-7
D1.1 LAWRENCE LIVERMORE NATIONAL LABORATORY ANALYSIS OF CANISTERS AND CASKS.....	D-8
D1.2 IDAHO NATIONAL LABORATORY ANALYSIS OF SPENT NUCLEAR FUEL CANISTERS AND MULTICANISTER OVERPACKS.....	D-12
D1.3 PROBABILITIES OF FAILURE OF HIGH LEVEL WASTE CANISTERS DUE TO DROPS.....	D-19
D1.4 PROBABILITIES OF FAILURE OF WASTE PACKAGES DUE TO DROPS AND IMPACTS	D-21
D1.5 PREDICTING OUTCOMES OF OTHER SITUATIONS BY EXTRAPOLATING STRAINS FOR MODELED SCENARIOS	D-26
D1.6 MISCELLANEOUS SCENARIOS	D-28
D2 PASSIVE FAILURE DUE TO FIRE.....	D-29
D2.1 ANALYSIS OF CANISTER FAILURE DUE TO FIRE	D-29
D2.2 SHIELDING DEGRADATION IN A FIRE.....	D-69
D3 SHIELDING DEGRADATION DUE TO IMPACTS.....	D-72
D3.1 DAMAGE THRESHOLDS FOR LOS	D-74
D3.2 SEVERITY OF DAMAGE VERSUS IMPACT VELOCITY	D-75
D3.3 ESTIMATE OF THRESHOLD SPEEDS FOR LOSS OF SHIELDING DUE TO IMPACTS	D-79
D3.4 PROBABILITY OF LOSS OF SHIELDING	D-81
D4 REFERENCES.....	D-87
D4.1 DESIGN INPUTS	D-87
D4.2 DESIGN CONSTRAINTS.....	D-93

FIGURES

	Page
D1.1-1. Original and Shifted Cumulative Distribution Functions (CDF) for Capacity (or Fragility) Plotted as a Function of True Strain.....	D-9
D2.1-1. Comparison Between Results Calculated Using the Simplified Heat Transfer Model and ANSYS – Fire Engulfing a TAD Canister in a Waste Package	D-43
D2.1-2. Plot of Larson-Miller Parameter for Type 316 Stainless Steel	D-54
D2.1-3. Yield, Ultimate, and Flow Stress for Type 316 Stainless Steel	D-55
D2.1-4. Probability Distribution for the Failure Temperature of Thin-Walled Canisters ...	D-59
D2.1-5. Probability Distribution for the Failure Temperature of Thick-Walled Canisters.....	D-60
D2.1-6. Probability Distribution for Maximum Canister Temperature – Thin-Walled Canister in a Waste Package	D-62
D2.1-7. Distribution of Radiation Energy from Fire.....	D-68
D3.2-1. Illustration of Deformation and Lead Slumping for a SLS Rail Cask Following End-on Impact at 120 mph	D-77
D3.2-2. Truck Steel/Lead/Steel Inner Shell Strain versus Impact Speed	D-78
D3.2-3. Rail Steel/Lead/Steel Strain versus Impact Speed	D-79
D3.4-1. Summary Event Tree Showing Model Logic for Canisters and Aging Overpacks	D-82

TABLES

	Page
D1.1-1. Probability of Failure versus True Strain Tabulated for Figure D1.1-1	D-9
D1.2-1. Container Configurations and Loading Conditions	D-13
D1.2-2. Failure Probabilities with and without Triaxiality Factor, with and without the Fragility Curve Adjustment, for Representative Canister within an Aging Overpack.....	D-14
D1.2-3. Failure Probabilities with and without Triaxiality Factor, with and without Fragility Curve Adjustment, for Representative Canister.....	D-14
D1.2-4. Failure Probabilities with and without Triaxiality Factor, with and without the Fragility Curve Adjustment, for the Representative Canister inside the Transportation Cask	D-16
D1.2-5. Failure Probabilities with and without Triaxiality Factor, with and without the Fragility Curve Adjustment, for the Transportation Cask	D-17
D1.2-6. Strains at Various Canister Locations Due to Drops	D-18
D1.2-7. Failure Probabilities for the DOE Spent Nuclear Fuel (DSNF) Canisters and Multicanister Overpack (MCO).....	D-19
D1.4-1. Waste Package Probabilities of Failure for Various Drop and Impact Events	D-23
D1.5-1. Calculated Strains and Failure Probabilities for Given Side Impact Velocities	D-27
D2.1-1. Probability Distribution for Fire Duration - Without Automatic Fire Suppression	D-33
D2.1-2. Probability Distribution for Fire Duration - With Automatic Fire Suppression.....	D-34
D2.1-3. Effective Thermal Properties for 21-PWR Fuel in a TAD	D-39
D2.1-4. Model Inputs – Bare Canister	D-46
D2.1-5. Model Inputs – Canister in a Waste Package.....	D-47
D2.1-6. Model Inputs – Canister in Transportation Cask	D-48
D2.1-7. Model Inputs – Canister in a Shielded Bell	D-49
D2.1-8. Summary of Canister Failure Probabilities in Fire	D-63
D2.1-9. Model Inputs – Bare Fuel Cask	D-65
D2.1-10. Summary of Fuel Failure Probabilities	D-67
D2.1-11. Probabilities that Radiation Input Exceeds Failure Energy for Cask	D-69
D3.2-1. Maximum Plastic Strain in Inner Shell of Sandwich Wall Casks	D-76
D3.3-1. Drop Height to Reach a Given Impact Speed.....	D-81
D3.3-2. Impact Speeds on Real Target for Equivalent Damage for Unyielding Targets	D-81
D3.4-1. Probabilities of Degradation or Loss of Shielding.....	D-86

ACRONYMS AND ABBREVIATIONS

Acronyms

ASME	American Society of Mechanical Engineers
CDF	cumulative distribution function
COV	coefficient of variation
CTM	canister transfer machine
DOE	U.S. Department of Energy
DPC	dual-purpose canister
EPS	equivalent (or effective) plastic strain
ETF	expended toughness fraction
FEA	finite element analysis
HLW	high-level radioactive waste
INL	Idaho National Laboratory
LLNL	Lawrence Livermore National Laboratory
MCO	multicanister overpack
PCSA	preclosure safety analysis
PDF	probability density function
PWR	pressurized water reactor
SAR	Safety Analysis Report
SFC	spent fuel canister
SLS	steel-lead-steel
SNF	spent nuclear fuel
TAD	transportation, aging, and disposal
TEV	transport and emplacement vehicle
WPTT	waste package transfer trolley

ACRONYMS AND ABBREVIATIONS (Continued)

Abbreviations

C	Celsius
cm	centimeter
F	Fahrenheit
ft	foot, feet
hr, hrs	hour, hours
J	joule
K	Kelvin
kg	kilogram
kV	kilovolt
kW	kilowatt
LOS	loss of shielding
m	meter
min	minute, minutes
m/s	meters/second
mrem	millirem
MPa	megapascal
mph	miles per hour
psig	pounds per square inch gauge
rem	roentgen equivalent man
W/m K	watt per meter Kelvin
W/m ² K	watt per square meter Kelvin

ATTACHMENT D

PASSIVE EQUIPMENT FAILURE ANALYSIS

Many event sequences described in Section 6.1 include pivotal events that arise from loss of integrity of a passive component, namely one of the aging overpacks, casks, or canisters that contain a radioactive waste form. Such pivotal events involve (1) loss of containment of radioactive material that may result in airborne releases, or (2) loss of shielding effectiveness. Both types of pivotal events may be failure modes caused by either physical impact to the container or by thermal energy transferred to the container. This attachment presents the results of passive failure analyses that provide conditional probability of loss of containment or loss of shielding. Many scenarios were selected for analysis as representative or bounding for anticipated scenarios in the risk assessment. Results of some scenarios may not have been used in the final event sequence quantification.

D1 LOSS OF CONTAINMENT DUE TO DROPS AND IMPACTS

The category of passive equipment includes canisters and casks used during transport, aging, and disposal of spent nuclear fuel. The canisters and casks contain the spent fuel and provide containment of radioactive material. During transport and handling, the canisters and casks could be subjected to drops, impacts, or fires, which may result in loss of containment. The probabilities of loss of containment due to various physical or thermal challenges are evaluated primarily through structural and thermal analysis and drop test data.

Passive equipment (e.g., transportation casks, storage canisters, and waste packages) may fail from abnormal use such as defined by the event sequences. Studies were performed and passive equipment failure probabilities were determined using the methodologies summarized in Section 4.3.2.2. The probability of loss of containment (breach) was determined for several types of containers, including transportation casks (analyzed without impact limiters), shielded transfer casks, waste packages, TAD canisters, DPCs, DOE standardized canisters, MCOs, HLW canisters, and naval SNF canisters. The mechanical breach of TAD canisters, DPCs and naval SNF canisters were analyzed as representative canisters as described in Section D1.1. The structural analysis of DOE standardized canisters and MCOs for breaches is described in Section D1.2 and then the probabilistic methodology of Section D1.1 was applied. Transportation casks, site transfer casks (STCs) and horizontal STCs were analyzed as representative transportation casks as describe in Section D1.1. The probabilistic estimation of breach from mechanical loads of all other waste containers is described in Sections D1.3 through D1.6. The analysis of loss or degradation of shielding of casks and overpacks against mechanical loads is described in Section D3. The probabilistic analysis of fire severity and the associated effects on casks, canisters, and overpacks with respect to both containment breach and shielding degradation or loss is described in Section D2. The analysis of mechanical failures and thermal failures included the specific configuration defined by the event sequences. For example, if the event sequence occurred during a process in which the canister is within a transportation casks or aging overpack, the analysis is performed in that configuration.

D1.1 LAWRENCE LIVERMORE NATIONAL LABORATORY ANALYSIS OF CANISTERS AND CASKS

Lawrence Livermore National Laboratory (LLNL) performed the FEA using Livermore Software–Dynamic Finite Element Program (LS-DYNA) to model drops and impacts for casks and canisters with selected properties for use as representative containers expected to be delivered to Yucca Mountain (Ref. D4.1.27). LS-DYNA, which has been used in nuclear facility and non-nuclear industrial applications, is appropriate to model nonlinear, transient responses of a passive component to a structural challenge such as a drop or an impact. Existing commercial casks and canisters that would likely be used on the Yucca Mountain Project (YMP) were identified and characterized. The cases analyzed are listed in Table D1.2-1.

Appropriate finite element models were developed for the representative cask, selected container types, configurations, and drop types. The level of detail for each model was selected to understand deformation and damage patterns, possible failure mode(s) in each structural element, and failure-related response. Special attention was required to properly model the bottom-weld and closure regions to ensure that coarser mesh of the simplified model would capture failure-related response with acceptable accuracy. A consistent failure criterion for each case was identified as part of the detailed analyses. The effective plastic strain in each element, in combination with material ductility data, was used to predict failure measures.

The maximum strain for each scenario was compared with the capacity distribution based on material properties to obtain containment failure probabilities using the methodology described in Section 4.3.2.2. For simplicity and consistency in interpreting results, the impact-surface conditions, including both the ground and the falling 10-ton load for the analyses, were considered infinitely stiff and unyielding, which is conservative.

The results of these cases are summarized in Tables D1.2-2 through D1.2-4. The bases for these results are summarized in the following paragraphs. If a probability for the event sequence is less than 1.0×10^{-8} , additional conservatism is incorporated in the PCSA by using a failure probability of 1.0×10^{-5} , which are termed “LLNL, adjusted”. This additional conservatism is added to account for a) future evolutions of cask and canister designs, and b) uncertainties, such as undetected material defects, undetected manufacturing deviations, and undetected damage associated with handling before the container reaches the repository, which are not included in the tensile elongation data.

LLNL developed a fragility curve for the base metal by fitting a mixture of two normal probability density functions (PDFs) to the engineering (tensile) strain data (Ref. D4.1.4). Both the data and their corresponding log-transforms were found to be non-normally distributed ($p < 10^{-4}$) by the Shapiro-Wilk test (Ref. D4.1.62). These data collected at 100°F were determined to be reasonably well modeled as a sample from a weighted mixture of two normal distributions, one with a mean of 46% and a standard deviation of 2.24% (weight = 7.84%), and the other with a mean of 59.3% and a standard deviation of 4.22% (weight = 92.16%), with the goodness of fit ($p = 0.939$) assessed by the Kolmogorov-Smirnov 1 sample test (Ref. D4.1.33).

The stainless steel used in the LLNL (Ref. D4.1.27) analysis is alloy 304L. The un-annealed alloys have relatively shorter elongations at failure than annealed 304L. Therefore, the base

fragility cumulative distribution function (CDF) model was adjusted to different steels used in a typical design and to meet the code specification of the material model used in LS-DYNA. The adjustment consisted of shifting the distribution by -8.3% (Ref. D4.1.27, p. 93). Thus the initial fragility curve was shifted by 8.3% to a lower value of minimum elongation. The fragility curves before and after the shift are shown in Figure D1.1-1 and tabulated in Table D1.1-1. 316L stainless steel might be used for construction of some canisters and casks, but the stress-strain curves would be similar.

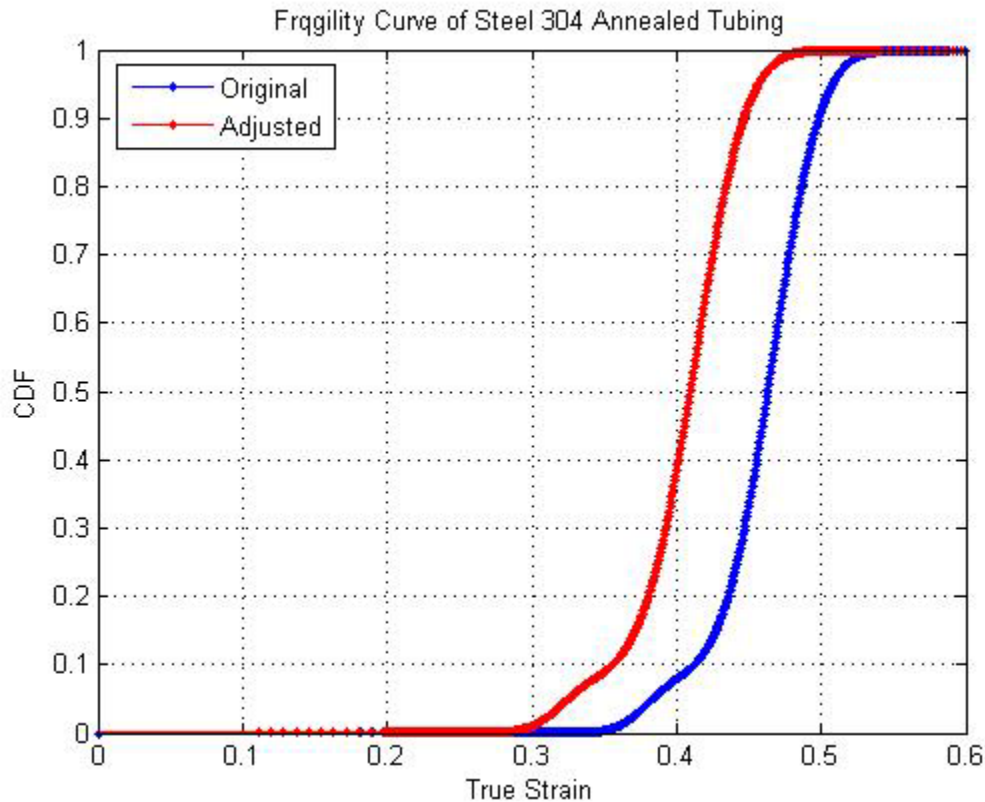

Source: Ref. D4.1.27, Figure 6.3.7-3

Figure D1.1-1. Original and Shifted Cumulative Distribution Functions (CDF) for Capacity (or Fragility) Plotted as a Function of True Strain

Table D1.1-1. Probability of Failure versus True Strain Tabulated for Figure D1.1-1

True Strain (TS)	$\frac{TS - TS_{mean}}{TS_{std}}$	Probability of Failure Original	Probability of Failure Adjusted (-8.3% shift)	True Strain (TS)	$\frac{TS - TS_{mean}}{TS_{std}}$	Probability of Failure Original	Probability of Failure Adjusted (-8.3% shift)
0.00	-1.70	0.0000E+00	1.6754E-15	0.36	0.05	1.0506E-02	1.0973E-01
0.01	-1.65	2.0924E-16	1.8688E-15	0.37	0.10	2.3978E-02	1.4282E-01
0.02	-1.60	4.1848E-16	2.0622E-15	0.38	0.15	4.3259E-02	1.9679E-01
0.03	-1.55	6.2772E-16	2.2555E-15	0.39	0.19	6.2863E-02	2.7687E-01

Table D1.1-1. Probability of Failure versus True Strain Tabulated for Figure D1.1-1 (Continued)

True Strain (TS)	$\frac{TS - TS_{mean}}{TS_{std}}$	Probability of Failure Original	Probability of Failure Adjusted (-8.3% shift)	True Strain (TS)	$\frac{TS - TS_{mean}}{TS_{std}}$	Probability of Failure Original	Probability of Failure Adjusted (-8.3% shift)
0.04	-1.50	8.3696E-16	2.4489E-15	0.40	0.24	7.9100E-02	3.8310E-01
0.05	-1.45	1.0462E-15	2.6422E-15	0.41	0.29	9.5539E-02	5.0814E-01
0.06	-1.41	1.2554E-15	2.8356E-15	0.42	0.34	1.2068E-01	6.3823E-01
0.07	-1.36	1.4647E-15	3.0290E-15	0.43	0.39	1.6410E-01	7.5736E-01
0.08	-1.31	1.6739E-15	3.2223E-15	0.44	0.44	2.3393E-01	8.5309E-01
0.09	-1.26	1.8832E-15	3.4157E-15	0.45	0.48	3.3371E-01	9.2036E-01
0.10	-1.21	2.0924E-15	3.6090E-15	0.46	0.53	4.5893E-01	9.6161E-01
0.11	-1.16	2.3016E-15	3.8024E-15	0.47	0.58	5.9615E-01	9.8363E-01
0.12	-1.11	2.5109E-15	2.8601E-14	0.48	0.63	7.2682E-01	9.9385E-01
0.13	-1.07	2.7201E-15	2.3645E-13	0.49	0.68	8.3454E-01	9.9797E-01
0.14	-1.02	2.9294E-15	1.6225E-12	0.50	0.73	9.1117E-01	9.9941E-01
0.15	-0.97	3.1386E-15	9.7686E-12	0.51	0.78	9.5806E-01	9.9985E-01
0.16	-0.92	3.3478E-15	5.2952E-11	0.52	0.82	9.8270E-01	9.9997E-01
0.17	-0.87	3.5571E-15	2.6233E-10	0.53	0.87	9.9379E-01	9.9999E-01
0.18	-0.82	3.7663E-15	1.2513E-09	0.54	0.92	9.9807E-01	1.0000E+00
0.19	-0.78	2.1733E-14	6.9107E-09	0.55	0.97	9.9948E-01	1.0000E+00
0.20	-0.73	2.1209E-13	2.6769E-08	0.56	1.02	9.9988E-01	1.0000E+00
0.21	-0.68	1.7358E-12	1.1600E-07	0.57	1.07	9.9998E-01	1.0000E+00
0.22	-0.63	1.1373E-11	4.8126E-07	0.58	1.11	1.0000E+00	1.0000E+00
0.23	-0.58	6.4625E-11	1.9316E-06	0.59	1.16	1.0000E+00	1.0000E+00
0.24	-0.53	4.1126E-10	7.5246E-06	0.60	1.21	1.0000E+00	1.0000E+00
0.25	-0.48	2.4773E-09	2.8566E-05	0.61	1.26	1.0000E+00	1.0000E+00
0.26	-0.44	1.2132E-08	1.0566E-04	0.62	1.31	1.0000E+00	1.0000E+00
0.27	-0.39	5.2343E-08	3.7635E-04	0.63	1.36	1.0000E+00	1.0000E+00
0.28	-0.34	2.4478E-07	1.2625E-03	0.64	1.41	1.0000E+00	1.0000E+00
0.29	-0.29	1.0945E-06	3.8474E-03	0.65	1.45	1.0000E+00	1.0000E+00
0.30	-0.24	4.7123E-06	1.0185E-02	0.66	1.50	1.0000E+00	1.0000E+00
0.31	-0.19	1.9709E-05	2.2466E-02	0.67	1.55	1.0000E+00	1.0000E+00
0.32	-0.15	7.9860E-05	4.0237E-02	0.68	1.60	1.0000E+00	1.0000E+00
0.33	-0.10	3.1104E-04	5.9110E-02	0.69	1.65	1.0000E+00	1.0000E+00
0.34	-0.05	1.1366E-03	7.5125E-02	0.70	1.70	1.0000E+00	1.0000E+00
0.35	0.00	3.7379E-03	8.9858E-02				

NOTE: The mean for true strain is 0.35, shown in bold. The standard deviation (std) of true strain is 0.21.

Source: Ref. D4.1.27, Table 6.3.7.3-1

The weldment at best can have the same mechanical properties as the hosting metal (native metal), but it is usually more brittle than the hosting metal. The failure likelihood of the

weldment substructure was considered, reflecting weighting factors of both 1.0 and 0.75 applied to estimated true strain at failure.

The capacity function is based on coupon tensile strength tests in uniaxial tension. However, cracking of a stainless steel may not be determined simply by comparing the calculated plastic strain to the true strain of failure, because the equivalent (or effective) plastic strain (EPS) is calculated from a complex 3-D state of stress, while the true strain at failure was based on data from a 1-D state of stress. A 3-D state of stress may constrain plastic flow in the material and lower the EPS at which failure occurs. This loss of ductility is accounted for by the use of a triaxiality factor, which is the ratio of normal stress to shear stress on the octahedral plane, normalized to unity for simple tension. For the purpose of determining the probability of structural failure, LLNL (Ref. D4.1.27) set the ductility ratio to 0.5. This is equivalent to a triaxiality factor of 2, which corresponds to a state of biaxial tension.

Failure of containment can occur when strain in a component is of sufficient magnitude that it results in breakage or puncture of the container. The probability of failure is calculated based on the maximum strain for a single finite element brick obtained from LS-DYNA simulations. Fracture propagation takes place on the milliseconds time-scale and thus propagates across the canister wall thickness very quickly, compared to the time-frame of the LS-DYNA simulations. Furthermore, the fragility curve is obtained on the basis of a maximum average strain over the thickness of the respective specimens, which are 2 in. long stainless steel 304L specimens. Although LS-DYNA results provide multiple values of the strain through the thickness of the canister wall (the wall thickness being represented by multiple finite element layers), it is more conservative to use the maximum strain value at a single finite element brick than the average of the multiple values across the thickness of the wall.

The probability of failure for each impact scenario is evaluated by finding the maximum strain at a location in which a through-wall crack would constitute a radionuclide release. A probability of failure is determined from the CDF of capacity or fragility curve (as discussed below) from the global maximum strain.

A conservative approach and aid to computational efficiency is achieved by performing calculations focusing on the regions of the container having high strain (and deformation) after a drop ("hot zones"). An importance sampling strategy was used which places greater-than-random emphasis on ranges of input-variable values, and/or on combinations of such value ranges, that are more likely to affect output. This approach is an alternative to Monte Carlo methods with the important advantage that possible combinations of upper-bound variable values are in fact incorporated into each probabilistic estimate of expected model output (which is not always guaranteed by uniform sampling).

Using the general probabilistic approach summarized here, LLNL (Ref. D4.1.27) calculated failure probabilities for representative canisters in an aging overpack, and in a transportation cask, and for the representative canister itself, as presented in Tables D1.2-2 through D1.2-5. For the drop of a 10-metric-ton load onto a cask, the falling mass is modeled as a rigid (unyielding) wall, oriented normal to longitudinal axis of the cask.

D1.2 IDAHO NATIONAL LABORATORY ANALYSIS OF SPENT NUCLEAR FUEL CANISTERS AND MULTICANISTER OVERPACKS

Drop tests of prototype canisters conducted by the Idaho National Laboratory (INL) confirmed that the stainless steel shell material can undergo significant strains without material failure leading to loss of containment. These drop tests also validated analytical models used to predict strains under various drop scenarios. Table D1.2-6 shows scenarios selected to address potential drop scenarios at YMP facilities and the predicted strains.

INL performed FEA (using ABAQUS/Explicit, which, like LS-DYNA, has been used in nuclear facility and non-nuclear industrial applications, and is appropriate to model nonlinear, transient responses of a passive component to a structural challenge such as a drop or an impact) of 23-foot drops, three degrees off vertical, to determine the extent of strain at various positions in the bottom head, cylindrical shell, and joining weld. The strain was evaluated and reported for the inside, outside, and middle layers (Ref. D4.1.64). The U.S. Department of Energy (DOE) standardized spent nuclear fuel (SNF) canisters were modeled at 300°F, the maximum skin temperature expected due to the heat evolved by the fuel (based on review of thermal analyses performed by transportation casks vendors), resulting in diminished casing material strength. It was found that greater strains would be expected in the multiccanister overpacks (MCOs) at ambient temperatures than at elevated temperatures.

During a canister drop event, the majority of the kinetic energy at impact performs work on the material, which causes the worst locations to exhibit plastic strain. A good measure of this work is equivalent plastic strain, which is a cumulative strain measure that takes into account the deformation history starting at impact. From the peak equivalent plastic strain, LLNL (Ref. D4.1.27) developed failure probabilities using the method described in Section D1.1 for an 18 in. and 24 in. DOE standard canister and an MCO. Results are summarized in Table D1.2-7.

Table D1.2-1. Container Configurations and Loading Conditions

Container	Configuration	Drop Type/Impact Condition ^a	Drop Height
AO (aging overpack) cell with canister inside	Representative canister inside AO	A IC 1: End with vertical orientation	3-ft vertical
		A IC 2: Slapdown from a vertical orientation and 2.5 mph horizontal velocity	0-ft vertical
Transportation cask with spent nuclear fuel (SNF) canister inside	Representative canister inside representative cask	T IC 1a: End, with 4 degree off-vertical orientation	12-ft vertical
		T.IC 1b: Same as T.IC 1a	13.1-ft vertical
		T.IC 1c: Same as T.IC 1a	30-ft vertical
		T IC 2a: End, with 4 degree off-vertical orientation, and approximated slapdown	13.1-ft vertical
		T.IC 2b: Same as T.IC 2a, with no free fall	0-ft vertical
		T IC 3: Side, with 3 degree off-horizontal orientation	6-ft vertical
DPC (Dual purpose canister) TAD (Transportation, aging, and disposal) canister	Representative canister	D IC 1a: End, with vertical orientation	32.5-ft vertical
		D IC 1b: Same as D.IC 1a	40-ft vertical
		D IC 2a: End, with 4 degree off-vertical orientation	23-ft vertical
		D IC 2b: Same as D.IC 2a	10-ft vertical
		D IC 2c: Same as D.IC 2a	5-ft vertical
		D IC 3: 40 ft/min horizontal collision inside the CTM bell	No drop
		D IC 4: Drop of 10-metric-ton load onto top of canister	10-ft vertical
		D.IC 2a: Hourglass-control study for end drop, with 4 degree off-vertical orientation	23-ft vertical
		D.IC 2a: Friction coefficient sensitivity study for end drop, with 4 degree off-vertical orientation	23-ft vertical
		D.IC 2a: Mesh density study for end drop, with 4 degree off-vertical orientation	23-ft vertical
D.IC 2a: Shell- and bottom-lid-thickness sensitivity study for end drop, with 4 degree off-vertical orientation	23-ft vertical		
DSNF (DOE spent nuclear fuel) canister	INL-analyzed case	O.IC 1: End, with 3-degree-off vertical orientation	23-ft vertical

NOTE: A = aging overpack; (AO) CTM = canister transfer machine; ft = foot; D = dual purpose canister; IC = impact condition; min = minute; mph = miles per hour; O = DOE SNF canister; SNF = spent nuclear fuel; T = transportation cask.

Source: ^a Ref. D4.1.27, Table 4.3.3-1a.

Table D1.2-2. Failure Probabilities with and without Triaxiality Factor, with and without the Fragility Curve Adjustment, for Representative Canister within an Aging Overpack

Container Type/ Impact Condition ^a	Impact Condition Description	Max EPS ^b	Failure Probability ^b			
			Original CDF Fragility Curve w/o Adjustment		CDF Fragility Curve Adjusted for Minimum Elongation (-8.3% Shift)	
			w/o Triaxiality	with Triaxiality	w/o Triaxiality	with Triaxiality
A.IC 1	3-ft end drop, with vertical orientation	0.16%	$<1 \times 10^{-8}$	$<1 \times 10^{-8}$	$<1 \times 10^{-8}$	$<1 \times 10^{-8}$
A.IC 2	Slapdown from a vertical orientation and 2.5-mph horizontal velocity	0.82%	$<1 \times 10^{-8}$	$<1 \times 10^{-8}$	$<1 \times 10^{-8}$	$<1 \times 10^{-8}$

NOTE: ^a“A” stands for aging overpack. “IC” stands for impact condition, which are defined in Table D1.2-1.
^bValues of Max EPS and failure probability are applicable to the SNF canister.

Source: Ref. D4.1.27, Table 6.3.7.6-1.

Table D1.2-3. Failure Probabilities with and without Triaxiality Factor, with and without Fragility Curve Adjustment, for Representative Canister

Container Type/ Impact Condition ^a	Impact Condition Description	Max EPS ^b	Failure Probability ^b			
			Original CDF Fragility Curve w/o Adjustment		CDF Fragility Curve Adjusted for Minimum Elongation (-8.3% Shift)	
			w/o Triaxiality	with Triaxiality	w/o Triaxiality	with Triaxiality
D.IC 1a	32.5-ft end drop, with vertical orientation	2.13%	$<1 \times 10^{-8}$	$<1 \times 10^{-8}$	$<1 \times 10^{-8}$	$<1 \times 10^{-8}$
D.IC 1b	40-ft end drop, with vertical orientation	2.65%	$<1 \times 10^{-8}$	$<1 \times 10^{-8}$	$<1 \times 10^{-8}$	$<1 \times 10^{-8}$
D.IC 2a	23-ft end drop, with 4-degree off-vertical orientation	24.19%	$<1 \times 10^{-8}$	7.71×10^{-1}	9.72×10^{-6}	9.96×10^{-1}
D.IC 2b	10-ft end drop, with 4-degree off-vertical orientation	19.71%	$<1 \times 10^{-8}$	7.01×10^{-2}	1.73×10^{-8}	3.19×10^{-1}
D.IC 2c	5-ft end drop, with 4-degree off-vertical orientation	15.76%	$<1 \times 10^{-8}$	4.10×10^{-5}	$<1 \times 10^{-8}$	3.12×10^{-2}
D.IC 3	40-ft/min horizontal side collision	0.16%	$<1 \times 10^{-8}$	$<1 \times 10^{-8}$	$<1 \times 10^{-8}$	$<1 \times 10^{-8}$
D.IC 4	10-ft drop of 10-metric-ton load onto top of canister	0.75%	$<1 \times 10^{-8}$	$<1 \times 10^{-8}$	$<1 \times 10^{-8}$	$<1 \times 10^{-8}$

Table D1.2-3. Failure Probabilities with and without Triaxiality Factor, with and without Fragility Curve Adjustment, for Representative Canister (Continued)

Container Type/ Impact Condition ^a	Impact Condition Description	Max EPS ^b	Failure Probability ^b			
			Original CDF Fragility Curve w/o Adjustment		CDF Fragility Curve Adjusted for Minimum Elongation (-8.3% Shift)	
			w/o Triaxiality	with Triaxiality	w/o Triaxiality	with Triaxiality
D.IC 2a S1-L1	Same as D.IC 2a	24.19%	$<1 \times 10^{-8}$	7.71×10^{-1}	9.72×10^{-6}	9.96×10^{-1}
D.IC 2a S2-L1	Same as D.IC 2a	21.52%	$<1 \times 10^{-8}$	1.66×10^{-1}	2.44×10^{-7}	7.62×10^{-1}
D.IC 2a S3-L1	Same as D.IC 2a	16.53%	$<1 \times 10^{-8}$	3.37×10^{-4}	$<1 \times 10^{-8}$	6.02×10^{-2}
D.IC 2a S1-L2	Same as D.IC 2a	23.34%	$<1 \times 10^{-8}$	5.52×10^{-1}	3.07×10^{-6}	9.78×10^{-1}
D.IC 2a S1-L3	Same as D.IC 2a	25.15%	$<1 \times 10^{-8}$	9.28×10^{-1}	3.48×10^{-5}	1.00
D.IC 2a S2-L3	Same as D.IC 2a	22.57%	$<1 \times 10^{-8}$	3.50×10^{-1}	1.07×10^{-6}	9.28×10^{-1}
D.IC 2a S3-L3	Same as D.IC 2a	18.08%	$<1 \times 10^{-8}$	1.22×10^{-2}	$<1 \times 10^{-8}$	1.14×10^{-1}
D.IC 2a S2-L4	Same as D.IC 2a	24.07%	$<1 \times 10^{-8}$	7.44×10^{-1}	8.27×10^{-6}	9.95×10^{-1}
D.IC 2a S3-L4	Same as D.IC 2a	19.50%	$<1 \times 10^{-8}$	6.29×10^{-2}	1.37×10^{-8}	2.77×10^{-1}

NOTE: ^a“D” stands for dual purpose canister. “IC” stands for impact condition, which are defined in Table D1.2-1.

See Table 6.3.3.5-1 of Ref. D4.1.27 for definitions of H1, F1, M1, etc. See Table 6.3.3.6-1 of Ref. D4.1.27 for definitions of S1, L1, etc.

^bValues of Max EPS and failure probability are applicable to the SNF canister. A range of canister shell and bottom plate thicknesses were evaluated. The values shown are for the configuration that yielded the highest strains (0.5-inch shell thickness and 2.313 inch bottom plate thickness)

Source: *Seismic and Structural Container Analyses for the PCSA* (Ref. D4.1.27, Table 6.3.7.6-3)

Table D1.2-4. Failure Probabilities with and without Triaxiality Factor, with and without the Fragility Curve Adjustment, for the Representative Canister inside the Transportation Cask

Container Type/ Impact Condition ^a	Impact Condition Description	Max EPS ^b	Failure Probability ^b			
			Original CDF Fragility Curve w/o Adjustment		CDF Fragility Curve Adjusted for Minimum Elongation (-8.3% Shift)	
			w/o Triaxiality	with Triaxiality	w/o Triaxiality	with Triaxiality
T.IC 1a	12-ft end drop, with 4-degree off-vertical orientation	3.53%	$<1 \times 10^{-8}$	$<1 \times 10^{-8}$	$<1 \times 10^{-8}$	$<1 \times 10^{-8}$
T.IC 1b	13.1-ft end drop, with 4-degree off-vertical orientation	4.06%	$<1 \times 10^{-8}$	$<1 \times 10^{-8}$	$<1 \times 10^{-8}$	$<1 \times 10^{-8}$
T.IC 1c	30-ft end drop, with 4-degree off-vertical orientation	5.77%	$<1 \times 10^{-8}$	$<1 \times 10^{-8}$	$<1 \times 10^{-8}$	$<1 \times 10^{-8}$
T.IC 2a	13.1-ft end drop, with 4-degree off-vertical orientation, and approximated slapdown	4.35%	$<1 \times 10^{-8}$	$<1 \times 10^{-8}$	$<1 \times 10^{-8}$	$<1 \times 10^{-8}$
T.IC 2b	Approximated slapdown from vertical orientation	1.25%	$<1 \times 10^{-8}$	$<1 \times 10^{-8}$	$<1 \times 10^{-8}$	$<1 \times 10^{-8}$
T.IC 3	6-ft side drop, with 3-degree off-horizontal orientation	2.07%	$<1 \times 10^{-8}$	$<1 \times 10^{-8}$	$<1 \times 10^{-8}$	$<1 \times 10^{-8}$
T.IC 4	10-ft drop of 10-metric-ton load onto top of cask	0.96%	$<1 \times 10^{-8}$	$<1 \times 10^{-8}$	$<1 \times 10^{-8}$	$<1 \times 10^{-8}$
T.IC 5a	30-ft end drop, with vertical orientation	3.55%	$<1 \times 10^{-8}$	$<1 \times 10^{-8}$	$<1 \times 10^{-8}$	$<1 \times 10^{-8}$
T.IC 5b	30-ft end drop, with 4-degree off-vertical orientation	5.77%	$<1 \times 10^{-8}$	$<1 \times 10^{-8}$	$<1 \times 10^{-8}$	$<1 \times 10^{-8}$
T.IC 5c	30-ft end drop, with 45-degree off-vertical orientation	6.41%	$<1 \times 10^{-8}$	$<1 \times 10^{-8}$	$<1 \times 10^{-8}$	$<1 \times 10^{-8}$
T.IC 5d	30-ft end drop, with center of gravity over corner (i.e., point of impact)	6.63%	$<1 \times 10^{-8}$	$<1 \times 10^{-8}$	$<1 \times 10^{-8}$	$<1 \times 10^{-8}$

NOTE: ^a“T” stands for transportation cask. “IC” stands for impact condition, which are defined in Table D1.2-1.

^bValues of Max EPS and failure probability are applicable to the SNF canister.

Source: Ref. D4.1.27, Table 6.3.7.6-2

Table D1.2-5. Failure Probabilities with and without Triaxiality Factor, with and without the Fragility Curve Adjustment, for the Transportation Cask

Container Type/ Impact Condition ^a	Impact Condition Description	Max EPS ^b	Failure Probability	
			CDF Fragility Curve Adjusted for Minimum Elongation (-8.3% Shift)	
			w/o Triaxiality	with Triaxiality
T.IC 1a	12-ft end drop, with 4-degree off-vertical orientation	9.20%	$<1 \times 10^{-8}$	$<1 \times 10^{-8}$
T.IC 1b	13.1-ft end drop, with 4-degree off-vertical orientation	9.37%	$<1 \times 10^{-8}$	$<1 \times 10^{-8}$
T.IC 1c	30-ft end drop, with 4-degree off-vertical orientation	11.25%	$<1 \times 10^{-8}$	9×10^{-7}
T.IC 2a	13.1-ft end drop, with 4-degree off-vertical orientation, and approximated slapdown	9.94%	$<1 \times 10^{-8}$	3×10^{-8}
T.IC 2b	Approximated slapdown from vertical orientation	5.30%	$<1 \times 10^{-8}$	$<1 \times 10^{-8}$
T.IC 3	6-ft side drop, with 3-degree off-horizontal orientation	7.42%	$<1 \times 10^{-8}$	$<1 \times 10^{-8}$
T.IC 4	10-ft drop of 10-metric-ton load onto top of cask	1.76%	$<1 \times 10^{-8}$	$<1 \times 10^{-8}$
T.IC 5a	30-ft end drop, with vertical orientation	3.17%	$<1 \times 10^{-8}$	$<1 \times 10^{-8}$
T.IC 5b	30-ft end drop, with 4-degree off-vertical orientation	11.25%	$<1 \times 10^{-8}$	9×10^{-7}
T.IC 5c	30-ft end drop, with 45-degree off-vertical orientation	70.56%	1	1
T.IC 5d	30-ft end drop, with center of gravity over corner (i.e., point of impact)	44.88%	0.9	1

NOTE: ^a“T” stands for transportation cask. “IC” stands for impact condition, which are defined in Table D1.2-1.
^bValues of Max EPS and failure probability are applicable to the structural body of the transportation cask, which excludes the shield and shield shell.

Source: Probabilities calculated using Table D1.1-1 based on strains reported in *Seismic and Structural Container Analyses for the PCSA* (Ref. D4.1.27, Table 6.3.7.6-2)

Table D1.2-6. Strains at Various Canister Locations Due to Drops

Canister	Component	Maximum PEEQ Strains (%)			Load Case/ Conditions
		Outside Surface	Mid- Surface	Inside Surface	
18-inch DOE STD canister	Lower head	8	3	6	300°F, 23-foot drop, 3 degrees off-vertical Material: ASME Code minimum strengths
	Lower head-to- main shell weld	2	2	3	
	Main shell	2	2	3	
	Upper head-to- main shell weld	0	0	0	
	Upper head	1	0.2	2	
24-inch DOE STD canister	Lower head	2	0.7	1	300°F, 23-foot drop, 3 degrees off-vertical Material: ASME Code minimum strengths
	Lower head-to- main shell weld	0.2	0.3	0.5	
	Main shell	0.2	0.3	0.5	
	Upper head-to- main shell weld	0	0	0	
	Upper Head	0	0	0	
MCO	Lower head	35	16	14	70°F, 23-foot drop, 3 degrees off-vertical Material: Actual material properties (significantly higher than ASME Code minimums)
	Lower head-to- main shell weld	21	11	11	
	Main shell	13	15	29	
	Upper head-to- main shell weld	0	0	0	
	Upper head	0	0	0	

NOTE: ASME = The American Society of Mechanical Engineers; DOE STD = U.S. Department of Energy standard; MCO = multicanister overpack; PEEQ = peak equivalent.

Source: Ref. D4.1.64, Tables 13, 14, and 16

Table D1.2-7. Failure Probabilities for the DOE Spent Nuclear Fuel (DSNF) Canisters and Multicanister Overpack (MCO)

Component	Peak Equivalent Plastic Strain (%)			Probability of Failure					
				Original CDF			CDF adjusted to min elongation		
	Outside Surface	Middle	Inside Surface	Outside Surface	Middle	Inside Surface	Outside Surface	Middle	Inside Surface
18-inch standard canister containment PEEQ strains, 3 degrees off vertical drop, 300°F									
Lower Head	8	3	6	<1E-08	<1E-08	<1E-08	<1E-08	<1E-08	<1E-08
Lower Head-to-Main Shell Weld	2	2	3	<1E-08	<1E-08	<1E-08	<1E-08	<1E-08	<1E-08
Main Shell	2	2	3	<1E-08	<1E-08	<1E-08	<1E-08	<1E-08	<1E-08
Upper Head-to-Main Shell Weld	0	0	0	<1E-08	<1E-08	<1E-08	<1E-08	<1E-08	<1E-08
Upper Head	1	0.2	2	<1E-08	<1E-08	<1E-08	<1E-08	<1E-08	<1E-08
24-inch standard canister containment PEEQ strains, 3 degrees off vertical drop, 300°F									
Lower Head	2	0.7	1	<1E-08	<1E-08	<1E-08	<1E-08	<1E-08	<1E-08
Lower Head-to-Main Shell Weld	0.2	0.3	0.5	<1E-08	<1E-08	<1E-08	<1E-08	<1E-08	<1E-08
Main Shell	0.2	0.3	0.5	<1E-08	<1E-08	<1E-08	<1E-08	<1E-08	<1E-08
Upper Head-to-Main Shell Weld	0	0	0	<1E-08	<1E-08	<1E-08	<1E-08	<1E-08	<1E-08
Upper Head	0	0	0	<1E-08	<1E-08	<1E-08	<1E-08	<1E-08	<1E-08
4 MCO containment PEEQ strains, 3 degrees off vertical drop, 70°F									
Bottom	35	16	14	3.74E-03	<1E-08	<1E-08	8.99E-02	<1E-08	<1E-08
Bottom-to-Main Shell	21	11	11	<1E-08	<1E-08	<1E-08	1.16E-07	<1E-08	<1E-08
Main Shell	13	15	29	<1E-08	<1E-08	1.09E-06	<1E-08	<1E-08	3.85E-03
Collar	0	0	0	<1E-08	<1E-08	<1E-08	<1E-08	<1E-08	<1E-08
Cover	0	0	0	<1E-08	<1E-08	<1E-08	<1E-08	<1E-08	<1E-08

NOTE: ASME = The American Society of Mechanical Engineers; CDF = cumulative distribution function; DOE STD = U.S. Department of Energy standard; MCO = multicanister overpack; PEEQ = peak equivalent.

Source: Ref. D4.1.27, Tables 6.3.7.6-4 and 6.3.7.6-5

D1.3 PROBABILITIES OF FAILURE OF HIGH LEVEL WASTE CANISTERS DUE TO DROPS

The probability of failure for drops of high-level radioactive waste (HLW) canisters was assessed by evaluating actual drop test data. Several series of tests were conducted including vertical, top, and corner drops of steel containers. The reports on these tests are summarized in *Leak Path Factors for Radionuclide Releases from Breached Confinement Barriers and*

Confinement Areas (Ref. D4.1.17). No leaks were found after 27 tests, 14 of which were from 23 feet and 13 of which were from 30 feet. These tests can be interpreted as a series of Bernoulli trials, for which the outcome is the breach, or not, of the tested canister. The observation of zero failures in 13 tests was interpreted using a beta-binomial conjugate distribution Bayes analysis.

A uniform prior distribution, which indicates prior knowledge that the probability of failure is between 0 and 1, may be represented as a Beta(r,s) distribution in which both r and s equals 1. The conjugate pair likelihood function for a Beta(r,s) distribution is a Binomial(n, N) where n represents the number of failures within the tests and N represents the number of tests. The posterior distribution resulting from the conjugate pairing is also a Beta distribution with parameters r' and s', which are defined as follows:

$$r' = r + n \quad \text{and} \quad s' = s + N - n \quad (\text{Eq. D-1})$$

The mean, μ , and standard deviation, σ , of the posterior distribution are determined using the following equations:

$$\mu = r' / (r' + s') \quad \text{and} \quad \sigma = \{r's' / [(r' + s' + 1) (r' + s')^2]\}^{1/2} \quad (\text{Eq. D-2})$$

For n = 0 and N = 13, Equation D-2 results in $\mu = 0.067$ and $\sigma = 0.062$. For n = 0 and N = 27, $\mu = 0.034$ and $\sigma = 0.033$. These values are used for the failure probability of a dropped HLW canister, for example during its transfer by a canister transfer machine.

One element of the Nuclear Safety Design Basis (Section 6.9) requires that the transportation cask, which will deliver HLW and DOE standardized canisters, be designed to preclude contact between the canister and a transportation cask lid or other heavy object that might fall. Similarly, other large heavy objects are precluded from damaging these canisters, when residing within a co-disposal waste package by the design of the waste package, which includes separator plates that extend well above the canisters. These scenarios are not quantitatively analyzed herein.

The combined INL and LLNL analyses discussed previously conclude that a DOE SNF canister has a probability of breach less than 1E-08 for a 23 foot drop, 4 degrees off-normal (i.e., 4 degrees from vertical) onto an unyielding rigid surface. The LLNL results demonstrate that generally strains from impact and probability of failure is higher for off-normal drops than normal (i.e., vertical) drops for the same height. The LLNL results further show that a 10 ton load dropped from 10 feet onto a representative canister also results in a probability of breach of less than 1E-08. INL analysis EDR-NSNF-087 entitled Qualitative Analysis of the Standardized DOE SNF Canister for Specific Canister-on-Canister Drop Events at the Repository states that canister integrity was maintained for a 30 foot drop test onto a rigid, unyielding surface. The report discusses drop of a HLW canister on a DOE SNF canister and drop of a DOE SNF canister onto another one. Drops of these canisters onto canisters in the IHF or CRCF would occur with drop heights of less than 10 feet. Two main differences are noted between a drop of a DOE SNF and a drop of a HLW canister onto a DOE SNF. The first is that substantially lower kinetic energy of impact of the latter drop would result in significantly less skirt deformation. The non-flat bottom nature of the HLW/DOE SNF interaction would have a different skirt

deformation pattern that the flat bottomed drop. INL concludes that the skirt would be expected to absorb the bulk of the heaviest HLW canister (4.6 tons) drop energy and DOE SNF canister integrity would be maintained. A difference between a 10 ton drop of a load onto a representative canister and a drop onto a DOE SNF canister results from the difference diameters of the target as well as different materials and lid thicknesses. Nevertheless, INL concludes that the impact from 10 feet of a HLW canister onto a DOE SNF canister is less challenging than impact from a 30 foot drop. Since the probability from a 23 foot drop was calculated to be less than 1E-08, it is conservative to use a value of 1E-05 for the probability of failure of an HLW on DOE SNF impact. The increased value is assigned to account for uncertainties owing to the differences noted above.

D1.4 PROBABILITIES OF FAILURE OF WASTE PACKAGES DUE TO DROPS AND IMPACTS

The probabilities of containment failure are evaluated by comparing the challenge load with the capacity of the waste package to withstand that challenge in a manner similar to that described in *Interim Staff Guidance HLWRS-ISG-02, Preclosure Safety Analysis - Level of Information and Reliability Estimation*. HLWRS-ISG-02 (Ref. D4.1.56), and summarized in Section 4.3.2.2. Three scenarios are evaluated for the potential loss of containment by waste packages due to drops and impacts:

- Two-foot horizontal drop
- 3.4-mph end-to-end impact
- Rockfall on waste package in subsurface tunnels.

An additional scenario, drop of a waste package shield ring onto a waste package, is considered in Section D1.4.4.

For this assessment, the potential load has been determined by FEA in the calculations cited below as the sources of inputs. The load is expressed in terms of stress intensities and as expended toughness fraction (ETF), which is the ratio of the stress intensity to the true tensile strength. The ETF is used to obtain the failure probability by the following:

$$P = \int_{-\infty}^x N(t) dt \quad \text{and} \quad x = \frac{ETF - 1}{COV} \quad (\text{Eq. D-3})$$

where

P = probability of failure

$N(t)$ = standard normal distribution with mean of zero and standard deviation of one

t = variable of integration

ETF = expended toughness fraction

COV = coefficient of variation = ratio of standard deviation to mean for strain capacity distribution, applied here to stress capacity or true tensile strength

The capacity is the true tensile strength of the material, the stress the material can withstand before it separates. The minimum true tensile strength, σ_u , for the Alloy 22 typically used for the outer corrosion barrier (OCB) of the waste package is 971 MPa (Ref. D4.1.20, Section 7.7, p. 162). The variability in the capacity is expressed as the standard deviation of a normal distribution that includes strength variation data and variability of the toughness index, I_T , computed without triaxiality adjustments (uniaxial test data). The standard deviation as percent of the mean of σ_u is 25% (Ref. D4.1.20, Section 7.6, p. 162). The distribution of elongations used for defining the fragility curve in the LLNL analysis was expressed as two normal distributions, the larger of which was with a mean of 59.3% elongation and a standard distribution of 4.22% elongation, or a COV of 0.0712 (Ref. D4.1.27, Section 6.3.7.3). Thus the 0.073 reported for the OCB material is conservative compared with the LLNL data and is used for the COV in the expression above. The possibility of waste package weld defects is not explicitly considered in the analysis. However, as noted in Section D.1.4.5, weld defects are not expected to contribute significantly to the probability of waste package failure due to drops or other impacts.

D1.4.1 Waste Package Drop

A study investigating the structural response of the naval long waste package to a drop while it is being carried on the emplacement pallet, found the ETF for the outer corrosion barrier (OCB) to be 0.29 for a 10 m/s flat impact (Ref. D4.1.20, Table 7-15, pg. 117), equivalent to a 16.7-foot drop. This corresponds to a failure probability of less than 1×10^{-8} . The failure of the OCB is used to define the loss of containment, taking no credit for the inner vessel and the canister within. The description of the transport and emplacement vehicle (TEV) provided in *Mechanical Handling Design Report: Waste Package Transport and Emplacement Vehicle* (Ref. D4.1.12) mentions that the floor plate is lifted by four jacks and guided by a roller. The guide roller precludes tilted drops of the flat bed of the TEV. As was done for the results from LLNL, to introduce an additional measure of conservatism, a failure probability of 1×10^{-5} is used for the probability that the waste package containment would fail due to a two-foot horizontal drop, which is much less severe than the modeled 16.7-foot drop.

D1.4.2 Rockfall onto a Waste Package

A seismic event during the preclosure period could cause rocks to fall from the ceiling of a drift onto the waste packages stored there prior to deployment of the drip shields. The extent of damage has been predicted for several levels of impact energy of falling rocks (Ref. D4.1.26). The maximum credible impact energy from a falling rock is about 1×10^6 joules (J) (Ref. D4.1.21, p. 57). The maximum ETF resulting from rockfall impacting with approximately 1×10^6 J is about 0.11 (Ref. D4.1.26, p. 54, Table 5), corresponding to a failure probability less than 1×10^{-8} . As was done for the results from LLNL, to introduce an additional measure of conservatism, a failure probability of 1×10^{-5} should be used for the probability that the waste package containment would fail due to rockfall on the waste package.

D1.4.3 Results for the Three Assessed Scenarios

The failure probabilities for the three scenarios, derived from the results in the cited reports, are summarized in Table D1.4-1.

Table D1.4-1. Waste Package Probabilities of Failure for Various Drop and Impact Events

Event	Probability of Failure
2-Foot Horizontal Drop	$< 1 \times 10^{-5}$
3.4-mph end-to-end impact	$< 1 \times 10^{-5}$
20 metric ton Rockfall on Waste Package with and without Rock Bolt ^a Impacting the Waste Package	$< 1 \times 10^{-5}$

NOTE: ^aA rock bolt is a long anchor bolt, for stabilizing rock excavations, which may be tunnels or rock cuts.

Source: Original.

D1.4.4 Drop of a Waste Package Shield Ring onto a Waste Package

After the co-disposal waste package has been welded closed in the Waste Package Positioning Room, the shield ring is lifted from it before the waste package transfer trolley is moved into the load out area. Grapple failures might cause the drop to occur at a variety of orientations relative to the top of the waste package. A frequency of canister breach from a potential drop as high as 10 feet is considered here. For a canister breach to occur, the shield ring must penetrate the 1-inch thick outer lid made of SB 575 (Alloy 22) and the 9 inch thick stainless steel inner lid (SA 240) before having an opportunity to impact the canister (Ref. D4.1.13). There are six inches separating the inner and outer lids. In the radial center area of that space, which would be directly above the DOE SNF canister, is a stainless steel lifting device attached to the inner lid. This adds another layer of energy absorption.

The shield ring weighs approximately 15 tons and is made of stainless steel with a lighter weight neutron absorber material. The impact energy of a 15-ton shield ring dropping 10 feet would be 0.4 MJ. The frequency of penetration of the sides of a waste package from a 20 metric ton rock impacting the side of the waste package with impact energy of 1 MJ is less than 1×10^{-8} (Table D1.4-1). The sides of a waste package are approximately three inches thick compared to a cumulative thickness (excluding lifting fixture) of 10 inches at the top. Although the impact energy could be more focused, the impact energy for the shield ring against the top of the waste package is less than the impact energy of the rockfall against the side and the top is much thicker than the side. The probability of failure due to shield ring impact against the top of the waste package is expected to be no worse than for the impact of a rock against the side. A conservative value of 1×10^{-5} is used in the analysis for this probability.

D1.4.5 Waste Package Weld Defects

Waste package closure involves engaging and welding the inner lid spread ring, inerting the waste package with helium, setting and welding the outer lid to the outer corrosion barrier, performing leak testing on the inner vessel closure, performing nondestructive examination of welds, and conducting postweld stress mitigation on the outer lid closure weld.

The weld process of the waste package closure subsystem is controlled as a special process by the Quality Assurance Program (Ref. D4.1.29, Section 9.0). The activities performed by the system are controlled by approved procedures.

The principal components of the system include welding equipment; nondestructive examination equipment for visual, eddy current, and ultrasonic inspections of the welds and leak detection; stress mitigation equipment for treatment of the outer lid weld; inerting equipment; and associated robotic arms. Other equipment includes the spread ring expander tool, leak detection tools, cameras, and the remote handling system. The system performs its functions through remote operation of the system components.

The capability of the waste package closure subsystem will be confirmed by demonstration testing of a full-scale prototype system. The prototype includes welding, nondestructive examinations, inerting, stress mitigation, material handling, and process controls subsystems. The objective of the waste package closure subsystem prototype program is to design, develop, and construct the complete system required to successfully close the waste package. An iterative process of revising and modifying the waste package closure subsystem prototype will be part of the design process. When prototype construction is finalized, a demonstration test of the closure operations will be performed on only the closure end of the waste package; thus, the mock-up will be full diameter but not full height as compared to the waste package. The purpose of the demonstration test is to verify that the individual subsystems and integrated system function in accordance with the design requirements and to establish closure operations procedures. This program is coordinated with the waste package prototype fabrication program.

The principal functions of the waste package closure subsystem are to:

- Perform a seal weld between the spread ring and the inner lid, the spread ring and the inner vessel, and the spread ring ends; perform a seal weld between the purge port cap and the inner lid; and perform a narrow groove weld between the outer lid and the outer corrosion barrier.
- Perform nondestructive examination of the welds to verify the integrity of the welds and repair any minor weld defects found.
- Purge and fill the waste package inner vessel with helium gas to inert the environment.
- Perform a leak detection test of the inner lid seals to ensure the integrity of the helium environment in the inner vessel.
- Perform stress mitigation of the outer lid groove closure weld to induce compressive residual stresses.

The gas tungsten arc welding process is used for waste package closure welds and weld repairs. Welding is performed in accordance with procedures qualified to the *2001 ASME Boiler and Pressure Vessel Code* (Ref. D4.1.5, Section IX), as noted below:

- The spread ring and purge port cap welds are two-pass seal welds.
- The outer lid weld is a multipass full-thickness groove weld.

Welding process procedures will be developed that identify the required welding parameters. The process procedures will:

- Identify the parameters necessary to consistently achieve acceptable welds.
- State the control method for each weld parameter and the acceptable range of values.

The welds are inspected in accordance with examination procedures developed using *2001 ASME Boiler and Pressure Vessel Code* (Ref. D4.1.5, Section V and Section III, Division 1, Subsection NC) as a guide, with modification as appropriate:

- Seal welds—visual inspection
- Groove welds—visual, eddy current, and ultrasonic inspection.

A weld dressing end effector is used for weld repairs. The defect is removed, resulting in an excavated cavity of a predetermined contour. The excavated cavity surface is inspected using the eddy current inspection end effectors. Then the cavity is welded and inspected in accordance with the welding and inspection procedures.

The stress mitigation process for the outer lid closure weld is controlled plasticity burnishing. Controlled plasticity burnishing is a patented method of controlled burnishing to develop specifically tailored compressive residual stress with associated controlled amounts of cold work at the outer surface of the waste package outer lid closure weld.

The inner vessel of the waste package is evacuated and backfilled with helium through a purge port on the inner lid. The inerting process is in accordance with the inerting process described in NUREG-1536 (Ref. D4.1.54, Sections 8.0 and V.1). After the waste package inner vessel is backfilled by helium, both the spread ring welds and the purge port plug are leak tested in accordance with *2001 ASME Boiler and Pressure Vessel Code* (Ref. D4.1.5, Section V, Article 10, Appendix IX) to verify that no leakage can be detected that exceeds the rate of 10^{-6} std cm³/s.

Waste package closure welding, nondestructive examination, stress mitigation, and inerting are conducted in accordance with approved administrative controls. The processes for waste package closure welding, nondestructive examination, stress mitigation, and inerting will be developed in accordance with the codes and standards identified below. The processes are monitored by qualified operators, and resulting process data are checked and verified as acceptable by qualified individuals.

Waste package closure welding, nondestructive examination, stress mitigation, and inerting normal operating procedures will specify, for example, the welding procedure specification, nondestructive examination procedure, qualification and proficiency requirements for operators and inspectors, and acceptance and independent verification records for critical process steps.

The waste package closure subsystem-related welds, weld repairs, and inspections are performed in accordance with *2001 ASME Boiler and Pressure Vessel Code* (Ref. D4.1.5, Section II, Part C; Section III, Division I, Subsection NC; Section IX; Section V).

The inerting of the waste package is performed in accordance with the applicable sections of NUREG-1536 (Ref. D4.1.54).

PCSA event sequences involving waste packages include challenges ranging from low velocity collisions to a 20 metric ton rockfall to a spectrum of fires. Waste package failure probabilities are calculated to be very low. Furthermore, a significant conservatism in the analysis is that the containment associated with the canister is not included in the probability of containment breach. In other words, if the waste package breaches, radionuclide release is analyzed as if the canister has breached (if the event sequence is in Category 1 or 2). Analytically, the canister is not relied upon for event sequences involving waste packages. The analytical results from the LLNL analysis show a significant reduction in canister strains is achieved by transportation cask and aging overpack protection. Although not analyzed, a similar ameliorating effect on the canister would be expected to be provided by the waste package.

The weld, inspection and repair process ensures no significant defects to a high reliability. The event sequence analysis shows that all event sequences associated with waste package breach are Beyond Category 2. In the context of the event sequence analysis, a significant defect is one that would have increased the probability of breach of the canister within the waste package by orders of magnitude. Even for significant weld defects, the protection offered by the waste package to the canister containment function would remain. Therefore, the effect of waste package weld failure on loss of canister containment during event sequences is not further considered.

D1.4.6 Waste Package End-to-End Impact

An oblique impact of a long naval SNF waste package inside TEV) was modeled to assess the structural response (Ref. D4.1.19). Most of the runs were with initial impact velocity of 3.859 m/s corresponding to a drop height of 0.759 m (2.49 ft). The maximum ETF for the 3.859 m/s (12.66 ft/sec) oblique impact in the OCB is about 0.7 (Ref. D4.1.19, page 37, Table 7-3, runs 1, 2, and 3), corresponding to a failure probability of about 2×10^{-5} . The oblique impact should be bounding for a direct end impact. Using equation D-4, an ETF of 0.11 is estimated for the hypothesized 3.4 mph end-to-end collision (two TEVs each traveling 1.7 mph), corresponding to a failure probability of less than 1×10^{-8} . The failure of the OCB is used to define the loss of containment, taking no credit for the inner vessel and the canister within. As was done for the results from LLNL, to introduce an additional measure of conservatism, a failure probability of 1×10^{-5} is used for the probability that the waste package containment would fail due to a 3.4-mph end-to-end impact.

D1.5 PREDICTING OUTCOMES OF OTHER SITUATIONS BY EXTRAPOLATING STRAINS FOR MODELED SCENARIOS

Equation 17 in Section 6.3.2.2 demonstrates use of the probability of failure at a given drop height together with the COV to predict probabilities at other drop heights. A similar approach can be used to extrapolate from one strain to another to find the corresponding failure probability. The work done on damaging the container expressed in the form of strain should be roughly proportional to the energy input to the material due to the impact. The impact energy is proportional to the drop height or to the square of the impact velocity. Finite element modeling

demonstrated that the increase in strain is actually less than proportional to increase in drop height (Tables D1.2-3 and D1.2-4), so increasing the strain proportionally with drop height or the square of impact velocity is conservative. The strain is extrapolated by multiplying it by the square of the ratio of the velocity of interest to the reference velocity.

$$\tau_i = \tau_{ref} \left(\frac{v_i}{v_{ref}} \right)^2 \quad (\text{Eq. D-4})$$

where

- τ_i = strain at velocity of interest (dimensionless)
- τ_{ref} = strain at reference velocity (dimensionless)
- v_i = velocity of interest (same units as v_{ref})
- v_{ref} = reference velocity (same units as v_i)

In case D.IC.3, a 0.16% strain (τ_{ref}) was predicted for a side impact of 40 ft/min (v_{ref}). Using Equation D-4 to extrapolate for an impact velocity of 2.5 miles/hr gives an estimated strain of 4.84%.

The estimated strain is then compared with the fragility curve tabulated in D1.1-1. A failure rate of less than 1×10^{-8} is predicted for a strain of 4.84%. Probabilities of failure for a range of impact velocities are listed in Table D1.5-1.

Table D1.5-1. Calculated Strains and Failure Probabilities for Given Side Impact Velocities

Impact Velocity		% strain	Probability of failure
(ft/sec)	(ft/min)		
0.67	40	0.16	$< 1 \times 10^{-8}$
1	60	0.36	$< 1 \times 10^{-8}$
2	120	1.44	$< 1 \times 10^{-8}$
4	240	5.76	$< 1 \times 10^{-8}$
6	360	13	$< 1 \times 10^{-8}$
8	480	23	$< 1 \times 10^{-5}$

Source: Original

A similar approach is applied to estimate failure probabilities for vertical drops greater than 40 feet. The strains are extrapolated using the ratio of drop heights rather than the squared ratio of impact velocities in Equation D-4.

For the DPC, the maximum EPS is 2.65% for a 40-foot end drop (case D.IC.1b in Table D1.2-3). Strains of 2.98% and 3.31% are estimated for 45- and 50-foot drops, respectively. Doubling the strains to account for triaxiality and comparing these strains with Table D1.1-1 shows the probabilities of failure are both $< 1 \times 10^{-8}$. As before, conservative probabilities of 1×10^{-5} are used in the event sequence quantification.

For the DOE standard canister the maximum strain is 8% in the lower head of the 18-inch canister resulting from a 23-foot drop 3 degrees off vertical (Table D1.2-6). By the same approach as above, 10.4%, 15.7%, and 17.4% strains are estimated for 30-foot, 45-foot, and 50-foot drops. Doubling these strains and comparing with Table D1.1-1 yields the failure probabilities of 1×10^{-7} , 3×10^{-2} , and 9×10^{-2} for the 30-foot, 45-foot, and 50-foot drops, respectively. A conservative probability of 1×10^{-5} is used for the 30-foot drop of the DOE standardized canister.

D1.6 MISCELLANEOUS SCENARIOS

D1.6.1 Localized Side Impact on a Transportation Cask

One of the requirements specified for transportation casks is they be robust enough to survive a 40-inch horizontal drop onto an unyielding 6-inch diameter upright cylinder (Ref. D4.2.2, Paragraph 71.73). The impact energy for such a scenario involving a 250,000 pound cask (a typical weight for a loaded cask) – the NAC STC has a loaded weight of 260,000 pounds (Ref. D4.1.50, p. 1.1-1) is about 1.1 MJ. The maximum weight of a forklift is considerably less than 20,000 kg. At a maximum speed of 2.5 mph (1.12 m/s), the maximum impact energy would be 12.5 kJ, a factor of 90 less than the impact energy for the 40-inch drop of the cask. If the resultant strain is proportional to the impact energy and the drop event in the Safety Analysis Report (SAR) is just below the failure threshold (i.e. the median impact energy for failure), the impact energy due to the 2.5-mph impact would be a maximum of $1/90^{\text{th}}$ of the median failure impact energy, or $1 - 1/90$ COVs less than a normalized median of 1. Equation D-3 is applicable substituting the ratio of impact energy to median failure impact energy for the factor ETF. Using $1/90$ (=0.011) in place of the ETF in Equation D-3 gives a probability of failure of much less than 1×10^{-8} due to impact of a forklift against a transportation cask. If the impact speed were 9 mph instead of 2.5 mph, the impact energy would be about $1/7^{\text{th}}$ of the energy in the SAR drop event, 0.14 would be used in place of the ETF in Equation D-3, and the probability of failure would still be less than 1×10^{-8} .

D1.6.2 Screening Argument for TAD Weld Defects

TAD canister closure is the process that closes the loaded TAD canister by welding the shield plug and fully draining and drying the TAD canister interior, followed by backfilling the TAD canister with helium and fully welding the TAD canister lid around its circumference onto the body of the TAD canister.

The process control program for the closure welds produced by the TAD canister closure system is controlled as a special process by the Quality Assurance Program (Ref. D4.1.29, Section 9.0).

TAD canister closure is done at the TAD canister closure station in the cask preparation area. The shielded transfer cask containing a loaded TAD canister is transferred from the pool to the TAD canister closure station using the cask handling crane. The shielded transfer cask lid is unbolted and then removed using the TAD canister closure jib crane. The TAD canister is then partially drained via the siphon port in order to lower the water level below the shield plug in preparation for welding. The TAD canister welding machine is positioned onto the TAD canister shield plug using the TAD canister closure jib crane, and the shield plug is welded in

place. After a weld is completed, visual examination of the weld is performed in addition to the eddy current testing and ultrasonic testing that are performed by the TAD canister welding machine.

A draining, drying, and inerting system is connected to the siphon and vent ports in the shield plug and used to dry the interior of the TAD canister, followed by backfilling it with helium gas. Port covers are then placed over the siphon and vent ports and welded in place using the TAD canister welding machine. The TAD canister welding machine is removed, and the outer lid is placed onto the TAD canister using the TAD canister closure jib crane. The TAD canister welding machine is positioned onto the TAD canister outer lid, and the lid is welded in place. The TAD canister welding machine is removed, and the shielded transfer cask lid is placed onto the shielded transfer cask using the TAD canister closure jib crane and installed. Hoses are connected to the fill and drain ports on the shielded transfer cask, and the water is sampled for contamination. If the water is clean, the ports are opened to drain the annulus between the TAD canister and the shielded transfer cask. If the water is contaminated, then the annulus is flushed with treated borated water as needed. A drying system is then used to dry the annulus. The potential for contamination is kept to a minimum by the use of the inflatable seal.

The qualification of the TAD canister final closure welds is in accordance with ISG-18 (Ref. D4.1.55) as specified in *Basis of Design for the TAD Canister-Based Repository Design Concept* (Ref. D4.1.15, Section 33.2.2.36). Adherence to this guidance is deemed to provide reasonable assurance that weld defects occur at a low rate. However, TAD canister weld cracks are considered an initiating event after the TAD canister welding process in the Wet Handling Facility (WHF). If this occurs, the radionuclide release would be minimal because the incoming casks and canisters have already been opened. After TAD canisters are welded, they are placed in aging overpacks and moved by the site transporter to the Canister Receipt and Closure Facility (CRCF). The probability of TAD canister failure during removal from the aging overpack handling in the CRCF and placement into a waste package is considered in the CRCF event sequence analysis. The conditional probability of TAD canister failures during handling in the CRCF has been shown to be small. The low probability of weld defects and their size would not alter this result. After the TAD canister is placed in the waste package, the containment is considered to be the waste package and the TAD canister is no longer relied upon in event sequences involving mechanical impacts.

D2 PASSIVE FAILURE DUE TO FIRE

A risk assessment must consider a range of fires that can occur, as well as variations in the dynamics of the heat transfer and uncertainties in the failure temperature of the target. This section presents an analysis to determine the probability that a waste container will lose containment integrity or lose shielding in a fire. Section D2.1 addresses loss of containment and Section D2.2 addresses loss of shielding.

D2.1 ANALYSIS OF CANISTER FAILURE DUE TO FIRE

A common approach to safety analysis in regards to the effect of a fire is to postulate a specific fire (in terms of duration, combustible loading, heat rate, and other fire parameters) and then apply it to a specific configuration of a target. Then, a simple comparison is made between the

temperature that the target reaches as a result of the fire, and the failure temperature of the target. Based on this comparison, a conclusion is made that either the target always fails, or never fails, or fails at some specific time. While such an approach may be appropriate for demonstrating that a specific design code has been met, it is not appropriate for a risk informed PCSA.

There are two parts to the assessment of the canister failure probability (sometimes referred to as the canister *fragility*): determining the thermal response of the canister to the fire and determining the temperature at which the canister will fail. In calculating the thermal response of the canister, variations in the intensity and duration of the fire are considered along with conditions that control the rate of heat transfer to the container (e.g., convective heat transfer coefficients, view factors, emissivities). In calculating the failure temperature of the canister, variations in the material properties of the canister material are considered along with variations in the loads that lead to failure.

D2.1.1 Uncertainty in Fire Severity

In the fragility analysis, fire severity is characterized by the fire temperature and duration, since these factors control the amount of energy that the fire could transfer to a target cask or canister. Uncertainty distributions were developed for the fire temperature and fire duration based on a review of generic and YMP-specific information.

D2.1.1.1 Uncertainty in Fire Duration

In the context of this study, this duration of the fire is from the perspective of the target (i.e., the cask or canister that could be compromised by the fire). Therefore, the fire duration used in the analysis is the amount of time a particular container is exposed to the fire, and not necessarily the amount of time a fire burns. As an example, a fire that propagates through a building over a four-hour period is not a four-hour hazard to a particular target. In calculating the exposure time for a specific target, it does not matter whether the fire started in the room where the target is, or it started in another room and ended where the target is, or the fire passed through the target room between its beginning and end. The exposure duration is how long the fire burns while consuming combustibles in the vicinity of the target. This allows a single probability distribution to be developed for the fire duration, regardless of how the fire arrived at the target, based on estimates of the duration of typical single-room fires.

In order to develop this curve, data on typical fire durations is required. A number of sources were used to derive insights regarding the range of expected durations of typical fires. The following sources were used:

- NUREG/CR-4679 (Ref. D4.1.53) reviewed the results of fire tests conducted by a number of organizations on a variety of types and amounts of combustible materials. Although focused on nuclear power plants, the materials assessed are typical of those found at a variety of industrial facilities.
- NUREG/CR-4680 (Ref. D4.1.52) reports on the results of a series of tests conducted by Sandia National Laboratories using a series of fuel source packages representative of

trash found around nuclear power plants. Once again, these packages are typical of what might be found around other types of industrial facilities.

The tests were not extensive, and represented only particular configurations. In general, the fire durations were found to depend upon the amount, type, and configuration of the available combustible material.

Based on a review of the available information, it was determined that two separate uncertainty distributions (i.e., probability distributions that represent uncertainty) would be needed: one for conditions without automatic suppression and one for conditions with automatic suppression. The derivation of these two distributions is discussed below.

D2.1.1.2 Fire Duration without Automatic Fire Suppression

The first uncertainty distribution was developed for fires in which automatic fire suppression is not available. The vast majority of the tests conducted were for this case. The following summarizes information presented in the three references listed above.

Sandia National Laboratories conducted two large-scale cable fire tests using an initial fire source of five gallons of heptane fuel, and an additional fuel loading of two vertical cable trays with a 12.5% fill consisting of 43-10-foot lengths of cable per tray (Ref. D4.1.53, Section 2.2.1). The only difference between the tests was that one test used unqualified cable and the other used IEEE-383 qualified cable. In the unqualified cable test, the cables reached peak heat release at approximately four minutes, and the rate decayed toward reaching zero at approximately 17 minutes. In the qualified cable test, the cables reached peak heat release at approximately seven minutes, and the rate decayed toward reaching zero at approximately 16 minutes.

Factory Mutual Research Corporation conducted tests for large-scale configurations of cable trays (Ref. D4.1.53, Section 2.2.3). One set of tests involved a configuration of 12 fully loaded horizontal trays in two stacked tiers. NUREG/CR-4679 (Ref. D4.1.53) provides detailed results for three of the “free-burn” tests (no automatic fire suppression). The first test reached and maintained the peak heat release rate at six minutes to 20 minutes, and reached zero at 25 minutes. The second test reached and maintained the peak heat release rate at seven minutes to 25 minutes, and reached zero at 34 minutes. The third test reached and maintained the peak heat release rate at 26 minutes to 40 minutes, and reached zero at 60 minutes.

Lawrence Berkeley Laboratory conducted tests on electrical cabinets (Ref. D4.1.53, Section 2.2.5). Two tests were conducted. The first was a single cabinet with only thermocouple wire and leads and no internal cabinet fuel loading. The fire that exposed the cabinet was two trash bags with loosely packed paper in a 32-gallon polyethylene trash receptacle, plus two cardboard boxes of packing “peanuts.” This fire reached a peak heat release rate at seven minutes, and reached zero at 19 minutes. The second test involved two cabinets separated by a steel barrier. The cabinets contained a total of 64 lengths of cable (48 and 16). The source fire in this test was similar in nature to the first test, but had a heavier container and loose paper instead of the “peanuts.” This fire had two peaks, at six minutes and 18 minutes, with the second being much larger than the first. The fire decayed toward reaching zero between 25 minutes and 30 minutes.

The Department of Health and Human Services sponsored a series of tests on various types of furnishing materials (Ref. D4.1.53, Section 3). While the specific types of furnishings are unlikely to be found in a YMP preclosure facility, these results are instructive for combinations of combustible materials that could be found. The first test was on a molded fiberglass chair with a metal frame. The fire reached a peak heat release rate in two minutes, and reached zero at 10 minutes. The second test was for a wood frame chair with latex foam cushions. This fire reached a peak heat release rate in four minutes and reached zero at 40 minutes. The final test was on four stackable, metal frame chairs with cushions that appeared to consist of a wood base, foam core, and vinyl cover. The fire reached a relatively steady state peak heat release rate from four minutes to 23 minutes, and reached zero at 38 minutes.

Sandia National Laboratories performed a series of nine tests on representative transient fuel fires (Ref. D4.1.52). Five different fuel packages were used for the tests. The first two fuel packages used mixed wastes representative of cleaning materials that might be left by maintenance personnel during routine operations. The first package was about 1.8 kilograms, and the second about 2.2 kilograms. The other difference between the two packages was the first package had more cardboard, whereas the second had more plastic. In both tests on the first package, the fire reached a peak heat release rate at approximately four minutes. However, they reached zero at different times (greater than 30 minutes versus approximately 20 minutes). In the two tests on the second package, the time of peak heat release was different (a high peak at four minutes versus a relatively low peak at 10 to 20 minutes), but they both reached zero at approximately the same time (50 minutes).

The third fuel package was designed to represent normal combustibles that might be in control or computer rooms, and consisted primarily of cardboard and stacked paper, with some crumpled paper. Total mass was about 7.9 kilograms. In both tests, the fire reached a peak heat release rate in approximately two minutes, but reached zero at different times (16 minutes versus 20 minutes).

The fourth fuel package was designed to represent mixed waste that might be found in a control room, computer room, security room, or similar location. It consisted primarily of a plastic trash can filled with paper and rags. Total mass was about 1.6 kilograms. In both tests, the fire reached a peak heat release rate in approximately three minutes and remained relatively steady for most of the duration of the fire, but reached zero at different times (54 minutes versus 70 minutes).

The fifth fuel package was designed to represent larger industrial waste containers that might be found in a variety of places in an industrial facility. It consisted primarily of a large plastic receptacle filled with wood, cardboard, paper, and oily rags. Total mass was about 6.5 kilograms. Only one test was conducted with this fuel package, and the fire reached two separate peak heat release rates (at 35 and 50 minutes) and decayed toward reaching zero at 80 minutes.

The preceding test data were reviewed and a probability distribution for the fire duration was developed based on engineering judgment. This distribution is characterized by 10% to 90% hazard levels of 10 minutes and 60 minutes, respectively (i.e., it was concluded that 10% of the fires would result in a target exposure duration of less than 10 minutes and 90% of the fires

would result in a target exposure duration of less than 60 minutes). These values were fitted to a lognormal distribution with a mean and standard deviation of 3.192 and 0.6943, respectively. The mean of this distribution is approximately 31 min, the median (50th percentile) is approximately 24 min, and the error factor (i.e., the ratio of the 95th percentile over the median) is about 3.1. The resultant probability distribution is presented in Table D2.1-1 as the probability of target exposure durations over a set of discrete intervals. The 30-minute design basis fire duration mandated in 10 CFR 71.73 (Ref. D4.2.2) corresponds to the 62nd percentile value of this distribution.

Table D2.1-1. Probability Distribution for Fire Duration - Without Automatic Fire Suppression

Fire Duration (min)	Cumulative Probability	Fire Duration Interval (minutes)	Interval Probability ^a
10	0.1	0 to 10	0.1
20	0.39	10 to 20	0.29
30	0.62	20 to 30	0.23
40	0.76	30 to 40	0.14
50	0.85	40 to 50	0.09
60	0.903	50 to 60	0.053
70	0.936	60 to 70	0.033
90	0.97	70 to 90	0.034
120	0.989	90 to 120	0.019
150	0.9956	120 to 150	0.0066
180	0.998	150 to 180	0.0024
210	0.999	180 to 210	0.001
270	0.99974	210 to 270	0.00074
360	0.99995	270 to 360	0.00021
∞	1	>360	5E-05

NOTE: ^a The interval probability is the difference between the cumulative probability at the top of the interval and the cumulative probability at the bottom of the interval.

Source: Original

D2.1.1.3 Fire Duration with Automatic Suppression

The second uncertainty distribution that was developed is for fires where automatic suppression is available. There were only a limited number of tests conducted for this case.

Factory Mutual Research Corporation conducted tests for large-scale configurations of cable trays, as discussed in the previous sections. In addition to the tests conducted without suppression, a number of tests were conducted with suppression. NUREG/CR-4679 (Ref. D4.1.53, pp. 26-31) provides detailed results for six of these “extinguishment tests.” All these tests involved a configuration of 12 fully loaded horizontal trays in two stacked tiers. Two of the six also involved the addition of two fully loaded vertical cable trays. The cables were polyvinyl chloride (PVC) - jacket with polyethylene insulation. The results of the first four tests were that the fires reached their peak heat release rates at 8, 9, 12, and 12 minutes. The associated times when the heat release rate dropped to zero were 10, 12, 16, and 29 minutes,

respectively. The results of the final two tests were peak heat release rates at 9 and 16 minutes, with zero being reached at 24 and 36 minutes, respectively.

These were the only extinguishment tests reported in the references. Therefore, an analysis of a wooden box-type fire conducted by Parsons also was examined. This is not an actual test, but rather a calculation of a “typical” fire where credit was given for the actuation of fire suppression. The calculation gave a peak heat release rate occurring at 7 minutes and extending to 15 minutes. The calculation showed the fire decaying towards zero at approximately 20 minutes.

These test data were reviewed and a probability distribution for the fire duration was developed based on engineering judgment. Although the data are somewhat sparse, they were taken in the overall context of how the actuation of suppression affected the tests conducted and how that compared to the free-burn tests. This was extrapolated to the other free-burn tests. It was judged likely that the operation of automatic suppression would have little effect on the lower end of the distribution, as such fires would likely burn out without actuating suppression. However, there would be a significant effect for the longer fires. It was concluded that a reasonable estimate of the 10 to 90% hazard levels was 10 minutes and 30 minutes (i.e., it was concluded that it was a reasonable interpretation of the data to state that 10% of the fires would result in target exposure duration of less than 10 minutes and 90% of the fires would result in target exposure duration of less than 30 minutes). These values were fitted to a lognormal distribution with a mean and standard deviation of 2.849 and 0.4286, respectively. The resultant uncertainty distribution is presented in Table D2.1-2 as the probability of target exposure durations over a set of discrete intervals.

Table D2.1-2. Probability Distribution for Fire Duration - With Automatic Fire Suppression

Fire Duration (min)	Cumulative Probability	Fire Duration Interval (min)	Interval Probability ^a
10	0.1	0 to 10	0.1
15	0.37	10 to 15	0.27
20	0.63	15 to 20	0.26
25	0.81	20 to 25	0.18
30	0.901	25 to 30	0.091
40	0.975	30 to 40	0.074
50	0.993	40 to 50	0.018
60	0.9982	50 to 60	0.0052
80	0.9998	60 to 80	0.0016
100	0.99998	80 to 100	0.00018
∞	1	>100	2E-05

NOTE: ^a The interval probability is the difference between the cumulative probability at the top of the interval and the cumulative probability at the bottom of the interval.

Source: Original

D2.1.2 Uncertainty in Fire Temperature

As used in the fire fragility analysis, the fire temperature is the effective blackbody temperature of the fire. This temperature implicitly accounts for the effective emissivity of the fire, which for large fires approaches a value of 1.0 (Ref. D4.1.61, p. 2-56). A review of the available fire temperature data for liquid and solid fuels is discussed below.

Experimental measurements of liquid hydrocarbon pool fires with radii from 0.25 to 40.0 m indicate effective blackbody radiation temperatures between 1,200°K and 1,600°K (927°C and 1,327°C) (Ref. D4.1.61, p. 2-56). Testing of rail tank cars engulfed in a liquid hydrocarbon pool fire indicates an effective blackbody temperature of 816°C to 927°C (1,089°K to 1,200°K) (Ref. D4.1.2).

Heat release data for combustible solid materials such as wood, paper, or plastic are plentiful, but fire temperature data have generally not been presented. However, *The SFPE Handbook of Fire Protection Engineering* (Ref. D4.1.61, pp. 3-82 to 3-87) discusses the hot gas temperatures associated with fully-developed compartment fires that do include combustion of solid materials. Fully-developed fires involve essentially all combustible material in a compartment, so the peak hot gas temperature should be reasonably indicative of the *effective* fire temperature. The data indicate typical peak temperatures between 400°C and 1,200°C (750°F and 2,190°F). (The 400°C value applies to small, short duration fires and is too low to represent a true fire temperature.)

Fires within one of the YMP facilities are likely to involve both combustible solid and liquid materials. Judgment suggests that most postulated fires should generally resemble the compartment fires discussed in *The SFPE Handbook of Fire Protection Engineering* (Ref. D4.1.61, Section 2, Chapter 7). This implies that the assigned temperature distribution should be strongly influenced by the 400°C and 1,200°C range. However, combustible liquids (e.g., diesel fuel in a site transporter) may also contribute significantly to some fires, so the upper bound of the fire temperature distribution should include the higher temperatures indicated by the pool fire data. Based on this reasoning, the fire temperature distribution is normally distributed with a mean of 1,072°K (799°C) and a standard deviation of 172°K. The mean of this distribution is approximately equal to the transportation cask design basis fire temperature of 800°C mandated in 10 CFR 71.73 (Ref. D4.2.2).

This fire temperature probability distribution has a value of 400°C for the 5th percentile and 1,327°C for the 99.9th percentile. The first value represents the lower end of the compartment fire temperature range while the second corresponds to the upper end of the liquid pool fire effective blackbody temperature range. Therefore, the distribution applies to fires involving both liquid and solid fuels.

It should be noted that data from fire testing indicate that the fire temperature is not constant over the duration of the fire. The fire temperature generally increases to a peak value and then decreases considerably as the combustible material is consumed. In the fire fragility analysis, herein, the fire temperature is treated as constant, which tends to increase the maximum target temperature.

D2.1.3 Correlation of Fire Temperature and Duration

Testing has shown that fire temperature and duration are negatively correlated. Intense fires with high fire temperatures tend to be short-lived because the high temperature results from very rapid burning of the combustible material. In contrast, long duration fires generally result from slower burning of the combustible material. In the probabilistic fire fragility analysis discussed below, the fire temperature and duration were correlated with a conservative correlation coefficient of -0.5. It is conservative because this correlation allows some fires that have both a high temperature and long duration.

D2.1.4 Uncertainty in the Thermal Response of the Canister

The probability distributions discussed in Section D2.1.1 characterize the uncertainty in the fire severity. In order to determine the probability that a canister fails due to a fire, models are needed to calculate the uncertainty in the thermal response of the container to a fire and the uncertainty in the failure temperature of the container.

The following sections describe the two simplified heat transfer models used to determine the thermal response of the canister to the fire. The heat transfer models have been simplified in order to allow a probabilistic analysis using Monte Carlo sampling. The two models discussed below apply to bare canisters or canisters inside a waste package, transportation cask, or a canister transfer machine (CTM) shielded bell. The simplified model was validated by comparison with a more complete model as discussed in Section D2.1.4.3.

D2.1.4.1 Heat Transfer to Bare Canisters

Bare canisters near or engulfed in a fire can be heated primarily by two heat transfer mechanisms: convection and radiation. Convection heating occurs when hot gases from the fire circulate and come into contact with the canister surface. Due to gravitational effects, the hot gases from the fire are expected to rise and collect near the ceiling of the room. Thus, unless a canister is engulfed in the fire, the hot gases are unlikely to come into direct contact with the canister, and radiation should be the dominant mode of heating. Further, radiation from the flame (luminous portion of the fire gases) is expected to far exceed radiation from the hot gas layer near the ceiling. For that reason, radiative heating by the hot gas layer is not considered in the fragility analysis. The heat transfer model described in the following sections are believed to capture the important aspects of the heat transfer from the fire.

Due to substantial conduction within the metal wall of the canister, the canister wall is modeled as a single effective temperature (thin-wall approximation) during heatup. Using this approach, the canister temperature (T_c) was advanced in time using the following Euler finite-difference formulation:

$$T_c = \frac{q_{c,net} \Delta t}{m_c c_{p,c}} + T_{c,i} \quad (\text{Eq. D-5})$$

where

- m_c =mass of the canister wall
- $c_{p,c}$ =specific heat of the canister material
- Δt = time step
- $T_{c,i}$ =canister temperature at the beginning of the time step, and
- $q_{c,net}$ =net rate of energy deposition into the canister.

The net rate of energy deposition into the canister during the fire is given by the following equation:

$$q_{c,net} = q_{r,fire} + q_{c,fire} - q_{r,f} \quad (\text{Eq. D-6})$$

where

- $q_{r,fire}$ =radiative heat transfer to the canister from the fire
- $q_{c,fire}$ =net convective heat transfer to the canister (positive if the canister is engulfed by the fire and negative if the canister is not engulfed by the fire)
- $q_{r,f}$ =radiative heat transfer from the canister to material stored in the canister.

The terms on the right-hand-side of this equation are defined below.

An earlier formulation of Equation D-6 included convective heat transfer from the canister wall to the gas inside the canister and from this gas to the spent fuel inside the canister. The addition of this heat transfer term did not significantly affect the heating rate of either the canister or the fuel, but did significantly increase the calculation time for the analysis. For that reason, convective heat transfer to the gas inside the canister was not included in the subsequent probabilistic analysis.

In this analysis, the important parameters are: (1) the fire temperature, size, and location relative to the canister, (2) treatment of the fire surface as a blackbody, and (3) treatment of the canister surface as diffuse and gray. Thus, the net rate of radiative heat transfer to the canister surface, $q_{r,fire}$, is given by:

$$q_{r,fire} = \epsilon_c A_c F_{c-fire} F_s \sigma (T_{fire}^4 - T_c^4) \quad (\text{Eq. D-7})$$

where

- ϵ_c =emissivity of the canister surface
- A_c =surface area of the canister
- F_{c-fire} =view factor between the canister and the fire, which is related to the fraction of radiation leaving the fire that strikes the canister surface

- F_s = suppression scale factor (discussed below)
 σ = Stefan-Boltzmann constant
 T_{fire} = effective blackbody temperature of the fire
 T_c = canister temperature.

In Equation D-6, $q_{c,\text{fire}}$ is the energy input due to convective heating from the fire, which is given by:

$$q_{c,\text{fire}} = A_c F_s h_{\text{conv}} (T_{\text{fire}} - T_c) \quad (\text{Eq. D-8})$$

where h_{conv} is the convective heat transfer coefficient and all other terms are defined as above.

The final term in Equation D-6 is the rate of heat transfer from the canister to the spent fuel or high level waste. This term is given by the following equation:

$$q_{r,f} = \frac{A_c F_{c-f} \sigma (T_c^4 - T_f^4)}{1/\epsilon_c + 1/\epsilon_f - 1} \quad (\text{Eq. D-9})$$

where F_{c-f} is the view factor between the canister and the fuel, ϵ_f is the emissivity of the fuel, and T_f is the temperature of the fuel being heated by the canister (outer portion of the fuel).

As the canister becomes hotter and heat is transferred to the fuel, the fuel temperature will also increase according to the following equation:

$$T_f = \frac{(q_{r,f} + q_{\text{DH}}) \Delta t}{m_f c_{p,f}} + T_{f,i} \quad (\text{Eq. D-10})$$

where q_{DH} is the decay heat generated in the fuel, m_f is the mass of fuel heated by the canister (outer portion of the fuel), $c_{p,f}$ is the specific heat of the fuel, and $T_{f,i}$ is the fuel temperature at the beginning of the time step.

Equation D-10 uses the mass of fuel being heated by the canister and the corresponding decay heat in this portion of the fuel. This equation ignores heat transfer from the heated fuel to unheated fuel. That is, there is no energy exchange between the outer fuel and the inner fuel.

The fuel mass to use in Equation D-10 can be estimated by calculating the thermal penetration depth within the fuel during the fire. In a number of previous studies (for example, (Ref. D4.1.25)), the fuel region inside the canister has been treated as a homogeneous material with effective thermal properties. The effective thermal properties used in these studies were determined for many different fuel configurations based on the results from detailed thermal analyses. Table D2.1-3 presents the effective thermal properties for 21-PWR fuel in the TAD canister (Ref. D4.1.25).

Table D2.1-3. Effective Thermal Properties for 21-PWR Fuel in a TAD

Property	Value
Density, ρ	3,655 kg/m ³
Specific Heat, c_p	438 J/kg K
Thermal Conductivity, k	4.29 W/m K
Thermal Diffusivity, α	2.6×10^{-6} m ² /s

NOTE: PWR = pressurized water reactor; TAD = transportation, aging, and disposal (canister)

Source: Ref. D4.1.25, Table 17, and Equation 2 of Section 6.2.2.

Based on the effective thermal properties listed in the table, estimation of the thermal penetration depth during a typical fire is given by the following equation:

$$\delta = \sqrt{\alpha t} \quad (\text{Eq. D-11})$$

where α is the effective thermal diffusivity and t is the time (3,600 seconds). Based on the effective thermal diffusivity shown in the table, a thermal penetration depth of approximately 9.5 cm is calculated. The fuel volume corresponding to this penetration depth is calculated by multiplying the canister interior surface area by the penetration depth. The effective fuel mass is then calculated by multiplying this volume by the effective density of the fuel. The resulting fuel mass is approximately 9,700 kg.

D2.1.4.2 Heat Transfer to a Canister inside a Cask, Waste Package, or Shielded Bell

The calculation of the heating of a canister inside another container or structure is slightly more complex than that for a canister directly exposed to fire. When inside another container, the canister is not directly heated by the fire. Rather, the container is first heated by the fire and then the interior surface of the heated container radiates heat to the canister and also convects heat to any air or other gas in the annular region between the outer container and canister. When there are multiple heat transfer barriers (e.g., the waste package, which has an outer barrier and an inner barrier), heat transfer between the barriers must also be considered. The following discussion includes the presence of an inner and outer barrier, as is the case for a waste package.

The calculation of canister heating was accomplished by first calculating the temperature of the outer barrier when exposed to a fire. Then, the energy radiated from the outer barrier to the inner barriers was calculated. Next, the energy radiated from the inner barrier to the canister was calculated. Models that included convective heat transfer to and from the gas in the annular spaces between these regions demonstrated that convective heating and cooling had little effect on the heating of the canister, but caused calculation times to be significantly longer. As a result, the convective heat transfer was removed from the models and the temperature increase of the inner barrier and canister were calculated based on radiative heating only.

It should also be noted that many transportation casks have neutron or gamma shielding composed of a low melting point material such as borated polyethylene. This material is likely to melt very quickly so its effect on heat transfer was not considered in the model. In reality, this

layer of material would have a substantial resistance to heat transfer, at least initially. Ignoring this thermal resistance is therefore conservative.

The heating of the outer barrier is calculated in the same general manner as that of a bare canister exposed directly to a fire. Due to the substantial conduction within the metal barrier, the thin-wall approximation was applied. Using this approach, the outer barrier temperature (T_{ob}) was advanced in time using the following Euler finite-difference formulation:

$$T_{ob} = \frac{(q_{ob} - q_{ib})\Delta t}{m_{ob}c_{p,ob}} + T_{ob,i} \quad (\text{Eq. D-12})$$

where

q_{ob} = radiation and convection to the outer barrier from the fire

q_{ib} = radiation to the inner barrier from the outer barrier

m_{ob} = mass of the outer barrier

$c_{p,ob}$ = specific heat of the outer barrier

Δt = time step

$T_{ob,i}$ = outer barrier temperature at the beginning of the time step.

Equation D-12 does not consider convective heat transfer to the air inside the container. Initial calculations showed that convective heat transfer to the air in the container would be small compared to the radiation heat loss term, so convective heat transfer was neglected.

If (1) the fire temperature, size, and location relative to a container are known, (2) the fire surface can be treated as a blackbody, and (3) the outer barrier surface can be considered diffuse and gray, then the net rate of radiative heat transfer to the outer barrier surface (q_{ob}) can be approximated as:

$$q_{ob} = \epsilon_{ob} A_{ob} F_{fc} F_s \sigma (T_f^4 - T_{ob}^4) \quad (\text{Eq. D-13})$$

where

ϵ_{ob} = emissivity of the outer barrier surface

A_{ob} = surface area of the outer barrier

F_{fc} = view factor for radiative heat transfer, which is related to the fraction of radiation leaving the fire that strikes the outer barrier surface

F_s = suppression scale factor (discussed below)

σ = Stefan-Boltzmann constant

T_f = fire (flame) temperature

T_{ob} = temperature of the outer barrier.

Once the temperature of the outer barrier is known, the heating of the inner barrier can be found in the same manner. Instead of a fire temperature, the temperature of the heated outer barrier is used and the net rate of radiative heat transfer from the outer barrier interior surface to inner barrier (q_{ib}) can be approximated as:

$$q_{ib} = \frac{A_{ob} F_{oi} \sigma (T_{ob}^4 - T_{ib}^4)}{1/\epsilon_{ib} + 1/\epsilon_{ib} - 1} \quad (\text{Eq. D-14})$$

where

ϵ_{ib} = emissivity for of the inner barrier

F_{oi} = view factor for radiation between the outer and inner barriers (discussed below)

T_{ib} = inner barrier surface temperature.

The temperature of the inner barrier is calculated using an equation similar to Equation D-12; however, in this equation, the thermal radiation incident on the inner barrier comes from the outer barrier rather than the fire and the heat loss from the inner barrier is to the spent fuel or high level waste canister.

Finally, the temperature of the canister is calculated using the following equation, which has a form similar to Equation D-12:

$$T_c = \frac{(q_{ib} + q_{DH})\Delta t}{m_c c_{p,c}} + T_{c,i} \quad (\text{Eq. D-15})$$

where q_{DH} is the total decay heat generated by the contents of the canister and all other terms are defined as in preceding equations.

In Equation D-15, the heat capacity of the contents of the canister is conservatively neglected so that all decay heat is transmitted to the canister wall. In reality, some fraction of the decay heat would be transmitted to the contents of the canister (e.g., the spent fuel or high level waste), increasing the temperature of the contents. Neglecting this term is conservative since it increases the temperature increase of the canister itself.

Note also that, in order to simplify the model, heat transfer from the canister to its contents is ignored in Equation D-15. In reality, some heat would be transferred from the canister wall to the spent fuel or high level waste inside the canister. Neglecting this heat removal is conservative since it increases the temperature increase of the canister.

Unlike the bare canister case in which heating of the canister ends when the fire ends, heating of a canister that is inside other containers will increase after the fire ends as heat is transmitted from the heated outer and inner barrier. After the fire has been extinguished, heat will be lost by the outer barrier due to a combination of radiation to cooler surfaces and convection to the air in the room. A temperature of 400°K was used as the surface and air boundary condition. The surfaces were modeled as blackbodies in the radiation heat transfer calculation. Convective heat transfer was calculated based on a heat transfer coefficient of 2.0 W/m² K. The fragility analysis

showed that the predicted canister failure probability was not sensitive to either the boundary condition temperature or the convective heat transfer coefficient.

D2.1.4.3 Validation of the Simplified Heat Transfer Models

In order to validate the simplified heat transfer models discussed above, results were compared to results calculated using more detailed models. In one such comparison, results calculated using the model for heating of a canister in a waste package were compared to the results from a similar ANSYS calculation (Ref. D4.1.25, Attachment V). ANSYS is a finite-element analysis software application use in nuclear facility and non-nuclear industrial applications to model temperature evolutions of complex systems. The simplified model was set up to match the inputs to the ANSYS calculation as closely as possible. The only differences between the two included:

- The ANSYS run was made with temperature-dependent specific heats whereas average specific heats were used in the simplified model.
- The ANSYS run treated the TAD canister and its contents as a homogeneous material with average properties, whereas the simplified model treated the TAD canister but ignored heat transfer to its contents.

Figure D2.1-1 shows a comparison of the calculated time-dependent temperatures from these two calculations. The figure shows that the simplified model accurately predicts the results from the more detailed analysis. Because heat transfer from the TAD canister to its contents is ignored in the simplified model, the canister reaches slightly higher temperatures with the simplified model compared to the more detailed model.

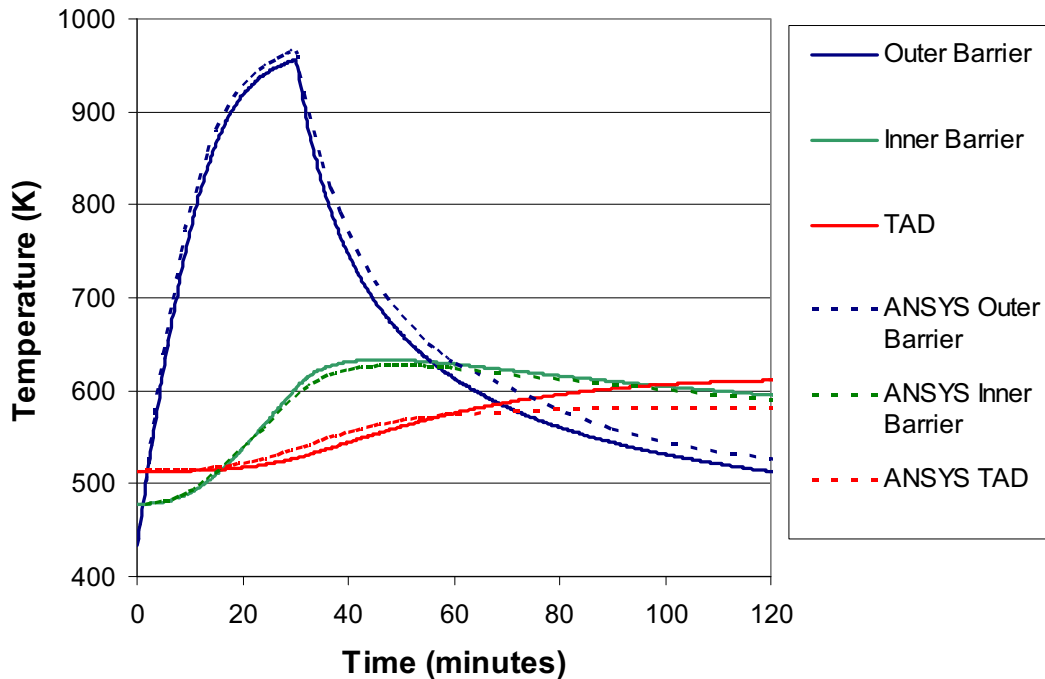

NOTE: TAD = transportation, aging, and disposal canister.

Source: Original

Figure D2.1-1. Comparison Between Results Calculated Using the Simplified Heat Transfer Model and ANSYS – Fire Engulfing a TAD Canister in a Waste Package

A similar comparison was made between the results reported in the HI-STAR safety analysis report (SAR) (Ref. D4.1.38, Table 3.5.4) and results calculated using the simplified model. These calculations simulated a design basis 30-minute fire. The maximum canister temperature reported in the HI-STAR SAR was 419°F (215°C). This temperature was predicted to occur approximately 3 hours after the start of the fire. The simplified model predicted a peak canister temperature of 213.5°C at approximately 4 hours after the start of the fire. This comparison again demonstrates the accuracy of the simplified model in predicting the maximum canister temperature due to the fire.

Detailed ANSYS calculations were not performed for the bare canister configuration. However, it is possible to infer the accuracy of the simplified bare canister model based on the accuracy of the simplified model in predicting the thermal response of the outer barrier in the waste package configuration. As shown in Figure D2.1-1, the simplified heat transfer accurately predicted the thermal response of the outer barrier both during the 30-minute fire and after.

D2.1.4.4 Heat Transfer Model Inputs and Uncertainties

The heat transfer models discussed in Sections D2.1.4.1 and D2.1.4.2 include a large number of input parameters. Some of these parameters are known to a high degree of confidence whereas

others are considered to be uncertain. This uncertainty was explicitly considered in the probabilistic analysis discussed in Section D2.1.1. The following sections discuss the major inputs to the models and the treatment of the uncertainty in these inputs.

D2.1.4.4.1 View Factor

The radiation view factor from the container (e.g., cask or waste package) to the fire can be calculated if the size of the fire and distance between the fire and the container can be determined. The size (height and width) of the fire can be approximated using published correlations in the SFPE handbook (Ref. D4.1.61, Section 1, Chapter 6). The distance between the fire and the container depends on the location of combustible materials and ignition sources relative to the container.

Since the location of combustible materials and ignition sources relative to the container is difficult to predict and would vary from one room to another, a conservative approach in which the container was engulfed by the fire is followed. For a container completely engulfed by the fire the view factor is essentially 1.0. This is conservative for the long vertically-oriented containers because even an engulfing fire may engulf only the lower portion of the container.

A view factor of 1.0 was applied only to the cask, waste package, or a shielded bell that encase a canister. Bare canisters are treated differently. Since a canister is only bare as it is being withdrawn from a cask or inserted into a waste package, only a portion of the canister could be exposed to the fire at any given time. In this case, the view factor is given by fraction of the canister actually exposed to the fire. This fraction depends on the space between the top of the cask or waste package and the ceiling of the loading or unloading room. Generally, this fraction would be considerably less than 50%.

The radiation view factor between concentric cylinders (e.g., the inner and outer barrier of a waste package) can be estimated very easily if the cylinders are very long compared to their diameters. Under this condition, which is true of most configurations of interest in the current study, the view factor can be approximated by D_i/D_o where D_i and D_o are the inner and outer diameters of the two cylinders (Ref. D4.1.63, Configuration C-63).

D2.1.4.4.2 Consideration of Fire Suppression on Canister Heating

The effect of fire suppression on canister heating is treated using a suppression scale factor. The suppression scale factor is included in the heat transfer equations as an adjustment to the rate of heat transfer to the canister from the fire. The value of the suppression scale factor used in the model is based on testing at the Building and Fire Research Laboratory, which is part of the National Institute of Standards and Technology (Ref. D4.1.31).

The Building and Fire Research Laboratory tests considered a range of fires and a range of sprinkler system spray densities. Results were presented for the net heat release rate from the fire both before and after actuation of the fire suppression system. The fire suppression scale factor implicitly includes consideration of the time delay before actuation of the fire suppression system and the effectiveness of the system. Rooms with early actuation and effective fire suppression would have a very small suppression scale factor, whereas rooms with delayed

actuation and/or ineffective fire suppression would have a large suppression scale factor (upper bound of 1.0 when no suppression is present).

Because no credit is taken for fire suppression in this analysis, the fire suppression scale factor was set equal to 1.0 in all of the analyses discussed in this document.

D2.1.4.4.3 Convective Heat Transfer Coefficient during the Fire

In testing of containers engulfed in a fire, considerable variations in the convective heat transfer coefficient have been measured. Values as high as $30 \text{ W/m}^2 \text{ K}$ have been measured in vigorously burning pool fires (Ref. D4.1.51, pp. 19-21), although values on the order of $20 \text{ W/m}^2 \text{ K}$ or less are considered more typical (Ref. D4.1.57, Table 3-2). For fire conditions in which the combustible material is burning more slowly, values on the order of $5 \text{ W/m}^2 \text{ K}$ or lower have been measured (Ref. D4.1.51, p. 19). To capture the potential variability in the convective heat transfer coefficient, a probability distribution for the convective heat transfer coefficient was included in the model. A normal distribution applies with a mean and standard deviation of $17.5 \text{ W/m}^2 \text{ K}$ and $4.2 \text{ W/m}^2 \text{ K}$, respectively. This distribution yields practical upper and lower bound values (0.1 and 99.9th percentiles) of approximately 5 and $30 \text{ W/m}^2 \text{ K}$.

D2.1.4.4.4 Decay Heat

The canisters processed through the preclosure facilities will contain spent fuel with varying decay heat levels. Based on information provided in the safety analysis reports for transportation casks, a probability distribution was developed for the decay heat level in the canister. A normal distribution applies with a mean and standard deviation of 17kW and 3kW, respectively. This distribution yields practical upper and lower bound values (0.1 and 99.9th percentiles) of approximately 8kW and 26kW.

D2.1.4.4.5 Other Model Inputs

Other inputs required by the heat transfer model include (1) the thermal and physical properties of all materials, (2) the dimensions of the canister, cask, waste package, or shielded bell, (3) the initial temperatures of each layer, (4) decay heat generated within the canister, and (5) the post-fire convective heat transfer coefficient and temperature. The values for these input parameters are provided in Tables D2.1-4 through D2.1-7. The tables also provide a brief rationale or a reference for the values used in the analysis.

As shown in the tables, calculations were performed for two spent fuel canister wall thicknesses: 0.5 inches (0.0127 m) and 1.0 inch (0.0254 m). This was done for two reasons. First, initial calculations showed that the wall thickness greatly influences both the heating and failure of the canister. Second, a review of the available canister information indicated a range of canister thicknesses from 0.5 inches to 1 inch. A substantial fraction of the older transport cask designs have spent fuel canisters with wall thicknesses of 0.5 or 0.625 inches, whereas newer designs (e.g., the naval spent fuel canister or TAD canister) are expected to have a wall thickness of 1.0 inch.

Table D2.1-4. Model Inputs – Bare Canister

Model Parameter	Value	Basis/Rationale
Canister Properties		
Outer Diameter (m)	1.68	Minimum outer diameter listed in <i>Transportation, Aging and Disposal Canister System Performance Specification</i> (Ref. D4.1.28, Section 3.1.1)
Wall Thickness (m)	0.0127 or 0.0254	0.5 inches is the thinnest canister wall thickness listed for current transport cask designs 1.0 inch is the anticipated TAD canister thickness and is also the thickness of the naval SFC
Length (m)	5.4	Typical length of TAD canister listed in <i>Transportation, Aging and Disposal Canister System Performance Specification</i> (Ref. D4.1.28, Section 3.1.1)
Density (kg/m ³)	7980	Density of Type 316 stainless steel (Ref. D4.1.7, Table X1.1)
Specific Heat (J/kg K)	560	Approximate value for Type 316 stainless steel at 400C (Ref. D4.1.25, Table 8)
Emissivity	0.8	Estimated value for stainless steel that has undergone some oxidation
Initial Temperature (K)	513	Initial temperature upon removal from the cask. Estimated from <i>Thermal Responses of TAD and 5-DHLW/DOE SNF Waste Packages to a Hypothetical Fire Accident</i> (Ref. D4.1.25, Figure 1)
Fuel Properties		
Heated Mass (kg)		Calculated based on thermal penetration depth (see text)
Specific Heat (J/kg K)	438	Average for fuel region taken from <i>Thermal Responses of TAD and 5-DHLW/DOE SNF Waste Packages to a Hypothetical Fire Accident</i> (Ref. D4.1.25, Table 15)
Effective Surface Area (m ²)	28.18	Projected area for radiation heat transfer. Calculated based on outer diameter of fuel region (1.67 m)
Emissivity	0.8	From <i>Thermal Responses of TAD and 5-DHLW/DOE SNF Waste Packages to a Hypothetical Fire Accident</i> (Ref. D4.1.25, Table 17)
Initial Temperature (K)	543	Estimated from <i>Thermal Responses of TAD and 5-DHLW/DOE SNF Waste Packages to a Hypothetical Fire Accident</i> (Ref. D4.1.25, Figure 1)
Post-Fire Conditions		
Ambient Temperature (K)	361	Post-fire temperature of 190°F - a value 100°F higher than the maximum interior facility temperature (Ref. D4.1.16, Section 3.2)
Heat Transfer Coefficient (W/m ² K)	2.0	Approximate value based on correlations in (Ref. D4.1.41, pp. 456-457) (Results not sensitive to this value)

NOTE: SFC = spent fuel canister; SNF = spent nuclear fuel; TAD = transportation, aging, and disposal.

Source: Original

Table D2.1-5. Model Inputs – Canister in a Waste Package

Model Parameter	Value	Basis/Rationale
Canister Properties		
Outer Diameter (m)	1.68	Minimum diameter listed in <i>Transportation, Aging and Disposal Canister System Performance Specification</i> (Ref. D4.1.28, Section 3.1.1)
Wall Thickness (m)	0.0127 or 0.0254	0.5 inches is the thinnest canister wall thickness listed for current transport cask designs 1.0 inch is the anticipated TAD canister thickness and is also the thickness of the naval SFC
Length (m)	5.4	Typical length of TAD canister listed in <i>Transportation, Aging and Disposal Canister System Performance Specification</i> (Ref. D4.1.28, Section 3.1.1)
Density (kg/m ³)	7980	Density of Type 316 stainless steel (Ref. D4.1.7, Table X1.1)
Specific Heat (J/kg K)	560	Approximate value for Type 316 stainless steel at 400°C (Ref. D4.1.25, Table 8)
Emissivity	0.62	Average value for Type 316 stainless steel in <i>Mark's Standard Handbook for Mechanical Engineers</i> (Ref. D4.1.8, Table 4.3.2)
Initial Temperature (K)	513	From <i>Thermal Responses of TAD and 5-DHLW/DOE SNF Waste Packages to a Hypothetical Fire Accident</i> (Ref. D4.1.25, Figure 1)
Outer Barrier of Waste Package		
Outer Diameter (m)	1.8816	Listed in <i>TAD Waste Package Configuration</i> (Ref. D4.1.22), (Ref. D4.1.23), and (Ref. D4.1.24)
Wall Thickness (m)	0.0254	Listed in <i>TAD Waste Package Configuration</i> (Ref. D4.1.22), (Ref. D4.1.23), and (Ref. D4.1.24)
Length (m)	5.4	Heated length adjacent to the TAD canister – same as TAD canister length
Density (kg/m ³)	8690	Value for Alloy 22 (Ref. D4.1.5, Section II, Part B, SB-575, Section 7.1)
Specific Heat (J/kg K)	476	Value for Alloy 22 at 400°C (Ref. D4.1.36, p. 13)
Emissivity	0.87	Value for Alloy 22 (Ref. D4.1.45, p. 10-297)
Initial Temperature (K)	433	From <i>Thermal Responses of TAD and 5-DHLW/DOE SNF Waste Packages to a Hypothetical Fire Accident</i> (Ref. D4.1.25, Figure 1)
Inner Barrier of Waste Package		
Outer Diameter (m)	1.8212	Listed in <i>TAD Waste Package Configuration</i> (Ref. D4.1.22), (Ref. D4.1.23), and (Ref. D4.1.24)
Wall Thickness (m)	0.0508	Listed in <i>TAD Waste Package Configuration</i> (Ref. D4.1.22), (Ref. D4.1.23), and (Ref. D4.1.24)
Length (m)	5.4	Heated length adjacent to the TAD canister – same as TAD canister length
Specific Heat (J/kg K)	560	Approximate value for Type 316 stainless steel at 400°C (Ref. D4.1.25, Table 8)
Emissivity	0.62	Average value for Type 316 stainless steel in <i>Mark's Standard Handbook for Mechanical Engineers</i> (Ref. D4.1.8, Table 4.3.2)

Table D2.1-5. Model Inputs – Canister in a Waste Package (Continued)

Model Parameter	Value	Basis/Rationale
Initial Temperature (K)	478	From <i>Thermal Responses of TAD and 5-DHLW/DOE SNF Waste Packages to a Hypothetical Fire Accident</i> (Ref. D4.1.25, Figure 1)
Post-Fire Conditions		
Ambient Temperature (K)	361	Post-fire temperature of 190°F - a value 100°F higher than the maximum interior facility temperature (Ref. D4.1.16, Section 3.2)
Heat Transfer Coefficient (W/m ² K)	2.0	Approximate value based on correlations in <i>Introduction to Heat Transfer</i> (Ref. D4.1.41, pp. 456-457) (Results not sensitive to this value)

NOTE: SFC = spent fuel canister; SNF = spent nuclear fuel; TAD = transportation, aging, and disposal.

Source: Original

Table D2.1-6. Model Inputs – Canister in Transportation Cask

Model Parameter	Value	Basis/Rationale
Canister Properties		
Outer Diameter (m)	1.68	Minimum diameter listed in <i>Transportation, Aging and Disposal Canister System Performance Specification</i> (Ref. D4.1.28, Section 3.1.1)
Wall Thickness (m)	0.0127 or 0.0254	0.5 inches is the thinnest canister wall thickness listed for current transport cask designs 1.0 inch is the anticipated TAD canister thickness and is also the thickness of the naval SFC
Length (m)	5.4	Typical length of TAD canister listed in <i>Transportation, Aging and Disposal Canister System Performance Specification</i> (Ref. D4.1.28, Section 3.1.1)
Density (kg/m ³)	7980	Density of Type 316 stainless steel (Ref. D4.1.7, Table X1.1)
Specific Heat (J/kg K)	560	Approximate value for Type 316 stainless steel at 400°C (Ref. D4.1.25, Table 8)
Emissivity	0.62	Average value for Type 316 stainless steel in <i>Mark's Standard Handbook for Mechanical Engineers</i> (Ref. D4.1.8, Table 4.3.2)
Initial Temperature (K)	513	From <i>Thermal Responses of TAD and 5-DHLW/DOE SNF Waste Packages to a Hypothetical Fire Accident</i> (Ref. D4.1.25, Figure 1)
Transportation Cask Outer Shell		
Outer Diameter (m)	2.438	From HI-STAR Transportation Cask SAR (Ref. D4.1.38, p. 1.2-3)
Wall Thickness (m)	0.0127	Minimum outer shell thickness listed in cask SARs
Length (m)	5.4	Length adjacent to the TAD canister
Density (kg/m ³)	7850	Density of 516 carbon steel (Ref. D4.1.6, Section II, Part A, SA-20, 14.1)

Table D2.1-6. Model Inputs – Canister in Transportation Cask (Continued)

Model Parameter	Value	Basis/Rationale
Specific Heat (J/kg K)	604	Approximate value for 516 carbon steel at 400°C (Ref. D4.1.25, Table 10)
Emissivity	0.8	Average value for carbon steel in <i>Mark's Standard Handbook for Mechanical Engineers</i> (Ref. D4.1.8, Table 4.3.2)
Initial Temperature (K)	381	Initial temperature in HI-STAR SAR (Ref. D4.1.38, Figure 3.5.3)
Transportation Cask Gamma Shield		
Outer Diameter (m)	2.148	From HI-STAR Transportation Cask SAR (Ref. D4.1.38, Drawing No.3913)
Wall Thickness (m)	0.19	A lower value for the combined thickness of gamma shield and inner containment listed in cask SARs
Length (m)	5.4	Length adjacent to the TAD canister
Density (kg/m ³)	7850	Density of 516 carbon steel (Ref. D4.1.6, Section II, Part A, SA-20, 14.1)
Specific Heat (J/kg K)	604	Approximate value for 516 carbon steel at 400°C (Ref. D4.1.25, Table 10)
Emissivity	0.8	Average value for carbon steel in <i>Mark's Standard Handbook for Mechanical Engineers</i> (Ref. D4.1.8, Table 4.3.2)
Initial Temperature (K)	405	Approximate average initial temperature in HI-STAR SAR (Ref. D4.1.38, Figure 3.5.3)
Ambient Temperature (K)	361	Post-fire temperature of 190°F - a value 100°F higher than the maximum interior facility temperature (Ref. D4.1.16, Section 3.2)
Heat Transfer Coefficient (W/m ² K)	2.0	Approximate value based on correlations in <i>Introduction to Heat Transfer</i> (Ref. D4.1.41, pp. 456-457) (Results not sensitive to this value)

NOTE: SAR = Safety Analysis Report; SFC = spent fuel canister; SNF = spent nuclear fuel;
TAD = transportation, aging, and disposal.

Source: Original

Table D2.1-7. Model Inputs – Canister in a Shielded Bell

Model Parameter	Value	Basis/Rationale
Canister Properties		
Outer Diameter (m)	1.68	Minimum diameter listed in <i>Transportation, Aging and Disposal Canister System Performance Specification</i> (Ref. D4.1.28, Section 3.1.1)
Wall Thickness (m)	0.0127 or 0.0254	0.5 inches is the thinnest canister wall thickness listed for current transport cask designs 1.0 inch is the anticipated TAD canister thickness and is also the thickness of the naval SFC
Length (m)	5.4	Typical length of TAD canister listed in <i>Transportation, Aging and Disposal Canister System Performance Specification</i> (Ref. D4.1.28, Section 3.1.1)

Table D2.1-7. Model Inputs – Canister in a Shielded Bell (Continued)

Model Parameter	Value	Basis/Rationale
Density (kg/m ³)	7980	Density of Type 316 stainless steel (Ref. D4.1.7, Table X1.1)
Specific Heat (J/kg K)	560	Approximate value for Type 316 stainless steel at 400°C (Ref. D4.1.25, Table 8)
Emissivity	0.62	Average value for Type 316 stainless steel in <i>Mark's Standard Handbook for Mechanical Engineers</i> (Ref. D4.1.8, Table 4.3.2)
Initial Temperature (K)	513	From <i>Thermal Responses of TAD and 5-DHLW/DOE SNF Waste Packages to a Hypothetical Fire Accident</i> (Ref. D4.1.25, Figure 1)
Shielded Bell		
Outer Diameter (m)	2.388	From <i>CRCF, IHF, RF, and WHF Canister Transfer Machine Mechanical Equipment Envelope</i> (Ref. D4.1.11)
Wall Thickness (m)	0.273	From <i>CRCF, IHF, RF, and WHF Canister Transfer Machine Mechanical Equipment Envelope</i> (Ref. D4.1.11)
Length (m)	7.62	From <i>CRCF, IHF, RF, and WHF Canister Transfer Machine Mechanical Equipment Envelope</i> (Ref. D4.1.11)
Density (kg/m ³)	7980	Density of Type 316 stainless steel (Ref. D4.1.7, Table X1.1)
Specific Heat (J/kg K)	560	Approximate value for Type 316 stainless steel at 400°C (Ref. D4.1.25, Table 8)
Emissivity	0.67	Approximate value at elevated temperature (corresponds to little oxidation of the surface)
Initial Temperature (K)	306	Maximum interior facility temperature of 90°F (Ref. D4.1.16, Section 3.2)
Post-Fire Conditions		
Ambient Temperature (K)	367	Post-fire temperature of 190°F - a value 100°F higher than the maximum operating temperature listed above
Heat Transfer Coefficient (W/m ² K)	2.0	Approximate value based on correlations in <i>Introduction to Heat Transfer</i> (Ref. D4.1.41, pp. 456-457) (Results not sensitive to this value)

NOTE: SFC = spent fuel canister; SNF = spent nuclear fuel; TAD = transportation, aging, and disposal.

Source: Original

D2.1.4.5 Uncertainty in Canister Failure Temperature

Using the models discussed in Sections D2.1.4.1 and D2.1.4.2, the temperature increase of a canister due to a fire can be calculated. In order to determine whether the temperature is sufficient to cause the canister to fail, it is necessary to determine the canister temperature at which failure would occur. Two failure modes were considered:

1. *Creep-Induced Failure.* Creep is the plastic deformation that takes place when a material is held at high temperature for an extended period under tensile load. This mode of failure is possible for long duration fires.
2. *Limit Load Failure.* This failure mode occurs when the load exerted on a material exceeds its structural strength. As the temperature of the canister increases in temperature, its strength decreases. Failure is generally predicted at some fraction (usually around 70 percent) of the ultimate strength.

The modeling associated with these failure modes is described in the following subsections.

D2.1.4.5.1 Modeling Creep-Induced Failure

Creep failure could occur if the canister is maintained at a high temperature for a lengthy period of time. One way to predict creep failure is to calculate a creep damage index, which defines the ratio of the creep damage to the cumulative creep required for failure. Such a model has been used by researchers at Argonne National Laboratory to predict failure of steam generator tubes under accident conditions (Ref. D4.1.46). In the Argonne National Laboratory model, failure occurs when the creep damage index reaches a value of 1. Written in the form of an equation, this condition is given by:

$$\int_0^{t_f} \frac{dt}{t_R(T, \sigma)} = 1 \quad (\text{Eq. D-16})$$

where

T = the temperature experienced by the canister (a function of time)

σ = the tensile stress exerted on the canister wall, and

t_f = the canister failure time (the time at which the equality is satisfied).

The function in the denominator of Equation D-16 is

$$t_R = 10^{\frac{P_{LM}-20}{T}} \quad (\text{Eq. D-17})$$

where P_{LM} is the Larson-Miller parameter (Ref. D4.1.44), which is a material property of the canister material and is a function of the applied stress.

Since the canisters are pressurized to varying degrees with a combination of helium or air used to backfill the canister and gases released when the fuel fails, the pressure inside the canister will increase as the canister gets hotter. The internal pressure exerts a hoop stress in the radial direction that puts the canister wall under tension. It is this stress that controls failure of the canister wall. The hoop stress, σ , is calculated using the following equation:

$$\sigma = \frac{Pr_c}{h} \quad (\text{Eq. D-18})$$

where

h = the thickness of the canister wall

r_c = the mean radius of the canister

P = the pressure difference across the canister wall.

D2.1.4.5.2 Modeling Limit Load Failure

Limit load failure occurs when the load on a structure exceeds its ability to withstand that load. As with the creep failure mode, the load on the canister wall is a hoop stress and is calculated using Equation D-18.

The capability of the canister to withstand a load is given by a flow stress, which is defined by (Ref. D4.1.46, p. 3):

$$\bar{\sigma} = k(\sigma_y + \sigma_u) \quad (\text{Eq. D-19})$$

where

k = a multiplication factor (0.5 in the current analysis)

σ_y = the yield strength (temperature dependent)

σ_u = the ultimate strength (temperature dependent).

The yield and ultimate strength are both temperature-dependent properties, so the flow stress is also a temperature-dependent property. For a typical 316 stainless steel, a value of 0.5 for k yields a flow stress that is approximately 0.7 times the ultimate strength. Failure is predicted if the hoop stress exceeds the flow stress.

This failure condition is consistent with the failure condition outlined in *2004 ASME Boiler and Pressure Vessel Code* (Ref. D4.1.6, Appendix F, paragraph F-1331). The ASME code specifies that for ferritic steels, the primary membrane stress intensity shall not exceed $0.7 \sigma_u$. For austenitic steels, the primary membrane stress intensity shall not exceed the greater of $0.7 \sigma_u$ or $\sigma_y + (\sigma_u + \sigma_y)/3$. As is noted below, for type 316 stainless steels, $0.7 \sigma_u$ is always the controlling condition.

D2.1.4.5.3 Inputs to the Canister Failure Models

The canister failure models require the following inputs:

- the value for the Larson-Miller parameter (a function of temperature and stress)
- the value for the flow stress (a function of temperature)
- the time-dependent internal pressure and temperature experienced by the canister.

The following discussion outlines how these values were determined.

D2.1.4.5.3.1 Larson-Miller Parameter

The value for the Larson-Miller parameter can be determined based on creep data provided by material suppliers. In the absence of data specific to the steels used for the spent fuel and high level waste canisters to arrive at Yucca Mountain, a literature review was performed to obtain representative creep rupture data for steels of the type expected to be used.

The primary focus of this data search was type 316 stainless steel since that is the steel most likely to be used for the spent fuel or high level waste canisters. Data were collected from the following sources:

- “Properties and Selection of Metals.” Volume 1 of *Metals Handbook* (Ref. D4.1.3).
- Reliability and Longevity of Furnace Components as Influenced by Alloy of Construction. H-3124 (Ref. D4.1.35).
- *Creep of the Austenitic Steel AISI 316L(N) -Experiments and Models* (Ref. D4.1.58).
- Assessment of Creep Behaviour of Austenitic Stainless Steel Welds (Ref. D4.1.59).
- *Materials Selection for High Temperature Applications* (Ref. D4.1.60).

The creep data provides the time required for creep rupture given a specified constant temperature and applied tensile stress.

Using this data, the value for the Larson-Miller parameter (Ref. D4.1.44) can be determined from the following equation:

$$P_{LM} = T[C + \log(t_f)] \quad (\text{Eq. D-20})$$

where

- T = temperature (K)
- t_f = failure time (hours) determined in testing
- C = a constant that is approximately 20 for most stainless steels

Using this equation and the data collected in the literature review, values for the Larson-Miller parameter were calculated. The calculated values for the Larson-Miller parameter are shown in Figure D2.1-2. As shown in the figure, the Larson-Miller parameter decreases as the applied stress increases.

In order to apply the results shown in the table outside the range of stresses considered in the table, it is necessary to determine a correlation that best fits the data. The best-fit curve, which is also plotted in Figure D2.1-2, is given by the following equation:

$$P_{LM} = 33,845 - 2,423 \ln(\sigma) \quad (\text{Eq. D-21})$$

As shown in Figure D2.1-2, the value for the Larson-Miller parameter varies from one metal specimen to the next and from one vendor to the next. This variability is illustrated, in part, by the variability in the data shown in the figure. In addition, the research by Sasikala, et al. (Ref. D4.1.59) showed that stainless steel weld material is generally less creep-resistant than the base metal (this is illustrated by the five outlier points on the figure which were determined for the weld material rather than the base metal). The variability in the Larson-Miller parameter must be reflected in the uncertainty analysis for the canister failure temperature.

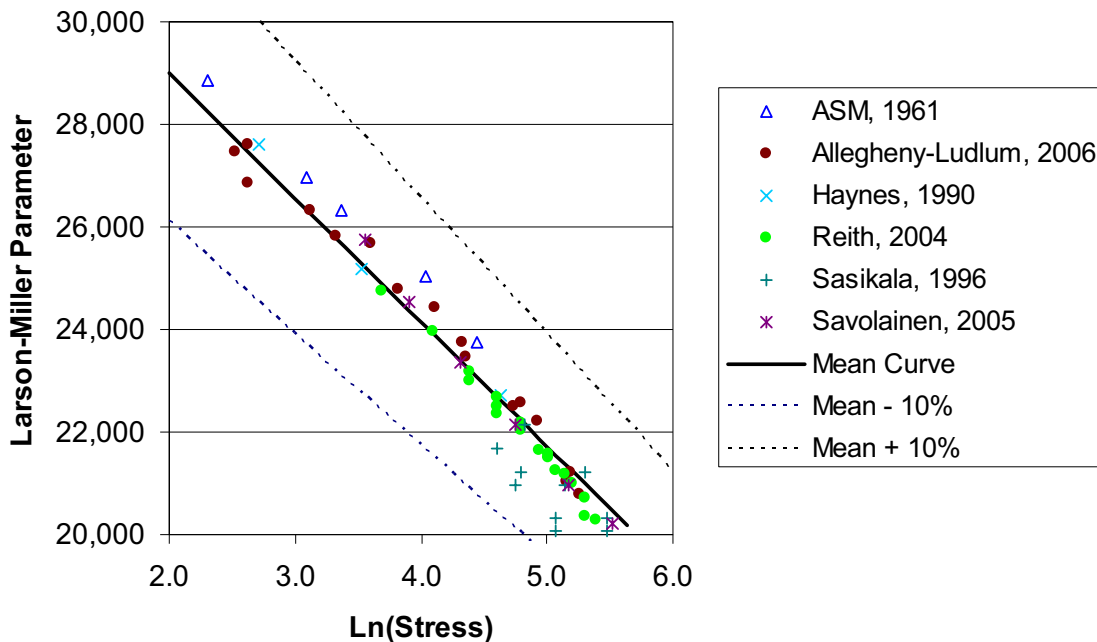

Source: Excel Spreadsheet *Creep rupture - Fast Heatup 1 inch.xls* found in Attachment H.

Figure D2.1-2. Plot of Larson-Miller Parameter for Type 316 Stainless Steel

The uncertainty in the Larson-Miller parameter is treated within the canister failure analysis by multiplying the calculated value for P_{LM} by a factor $(1+a)$, where the value for a is normally distributed with a mean of 0.0 and a standard deviation of 0.038. Using this formulation, 99% of all canister steels would have P_{LM} values within approximately 10% of the calculated value.

This uncertainty is believed to reflect the variability between different canister steels as well as the variability between the base metal and the weld material.

D2.1.4.5.3.2 Flow Stress

In the canister failure analysis, the flow stress is the average of the yield and ultimate strength. Both the yield and ultimate strength are temperature-dependent and decrease rapidly above a temperature of about 800°K. Figure D2.1-3 presents typical curves for the yield and ultimate strength of Type 316 stainless steel as a function of temperature (Ref. D4.1.1). The figure also presents the calculated flow stress curve. For temperatures with no yield strength data, the flow stress equals 0.7 times the ultimate strength.

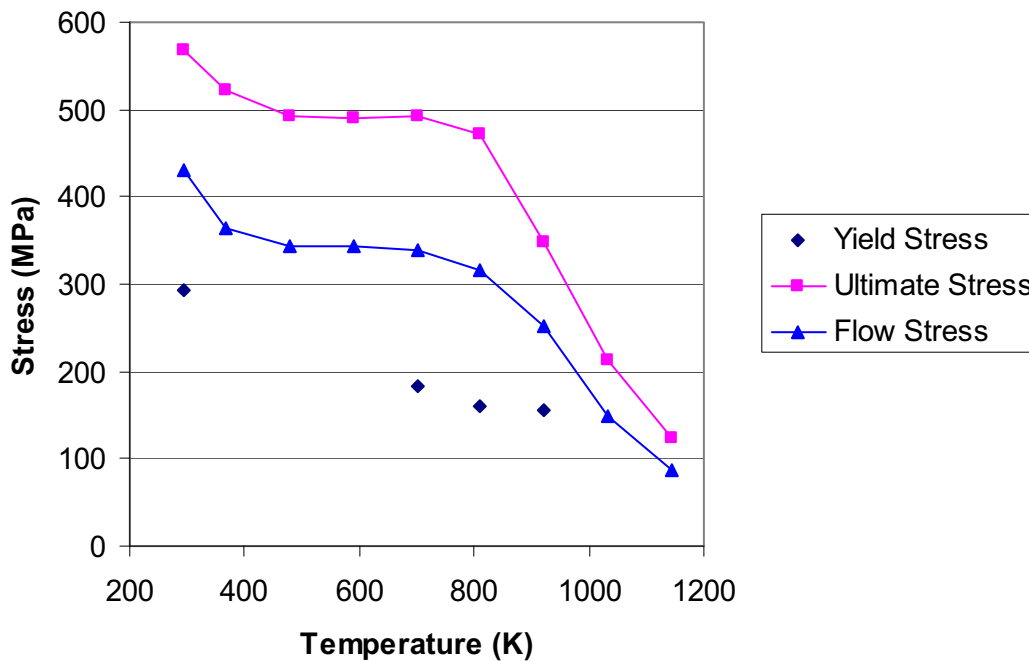

NOTE: MPa = megapascals.

Source: Original

Figure D2.1-3. Yield, Ultimate, and Flow Stress for Type 316 Stainless Steel

For the temperature range of interest, the flow stress curve can be fit to two straight lines: one line for temperatures between 350°K and 800°K and another for temperatures above 800°K. The equations for these two lines are provided below:

$$\bar{\sigma} = 395.9 - 0.0925T \quad \text{for } T < 800 \text{ K} \quad (R^2 = 0.889) \quad (\text{Eq. D-22a})$$

$$\bar{\sigma} = 899.1 - 0.7139T \quad \text{for } T \geq 800 \text{ K} \quad (R^2 = 0.989) \quad (\text{Eq. D-22b})$$

Note that the fit is particularly good for the upper temperature range, which is of greatest interest in the current analysis.

As with the value for the Larson-Miller parameter, the value for the flow stress is uncertain. The uncertainty in the flow stress was treated in the same manner as the uncertainty in the Larson-Miller parameter. Specifically, the mean value described by the equations provided above was multiplied by a factor $(1 + a)$ where the value for a is normally distributed with a standard deviation of 0.038. This distribution results in 99% of all canister steels having a flow stress within 10% of the mean value given by the equations. This adequately reflects the variability in the material properties of Type 316 steels, the variability between the properties of the base metal and weld material, and the potential for other types of steel with lower or higher tensile strength to be used in manufacture of the canisters.

D2.1.4.5.3.3 Pressure Difference and Temperature Histories

Creep failure and limit load failure depend on the time-dependent internal pressure and canister temperature. The canister temperature depends on the fire severity and also on whether the canister is bare or enclosed in a waste package or cask. The canister temperature is calculated using a separate analysis, as discussed above. Rather than attempting to couple the canister failure and canister heatup analyses into a single calculation, a separate canister failure analysis was completed. This analysis required the following inputs: the rate of temperature increase of the canister wall and the relationship between the internal canister pressure and the temperature of the canister wall.

Based on a series of runs with the canister heat transfer models discussed above, it was determined that the rate of temperature increase for a bare canister was likely to range from a low of around 25°K/min to a high of around 175°K/min. This range was input as a normal distribution with a mean of 100°K/min and a standard deviation of 25°K/min. Similar runs for the non-bare canister cases indicated a much slower heatup rate. For these cases, the canister heatup rate was input as a normal distribution with a mean of 10°K/min and a standard deviation of 2.5°K/min.

Analyses with a special version of the bare canister heat transfer model were also used to characterize the rate at which the temperature of the gas inside the canister would increase as a result of heating of the canister wall. This version of the model included convective heat transfer from the canister wall to the gas, from the canister wall to fuel assemblies inside the canister, and from the fuel assemblies to the gas inside the canister. These analyses showed a substantial lag in temperature between the canister wall and the gas.

The following equation was used to calculate the internal pressure of the canister based on the canister temperature:

$$P = P_0 \left[1 + C \left(\frac{T_{\text{can}} - T_{\text{can},0}}{T_{\text{can},0}} \right) \right] \quad (\text{Eq. D-23})$$

where

- P_0 = initial pressure inside the canister (including potential fuel failures)
- $T_{\text{can},0}$ = initial temperature of the canister wall
- T_{can} = canister temperature at the current timestep
- C = a constant that depends on the canister heating rate.

Note that if the value for C is set equal to 1.0 in this equation, the proportional change in pressure is equal to the proportional change in temperature. This would be true if the gas and canister temperatures increased at the same rate. Because the gas temperature lags behind the canister temperature, the value for C is always less than 1. Rather than attempting to model the variability in the value for C , the analysis used a bounding value of 0.5 for all analyses. This value bounded the range of values calculated in the separate heat transfer analysis.

The initial pressure, P_0 , in Equation D-23 varies over a wide range depending on the amount of overpressure supplied when the canister is sealed, the extent of fuel rod failures, and the type of fuel stored in the canister. Since the canister failure analysis considers only the increase in gas temperature due to the fire, the initial pressure must reflect potential fuel failures during the fire.

The SARs prepared by transportation cask vendors were consulted for information on internal pressure under normal and accident conditions (see for example, Section 3.6.6 of *GA-9 Legal Weight Truck From-Reactor Spent Fuel Shipping Cask, Final Design Report* (Ref. D4.1.34)). The SARs provide information on the initial overpressure in the canister and the pressure increase associated with fuel rod failures. Based on this information, an uncertainty distribution for the initial pressure in the canister was developed. The uncertainty is characterized by a Weibull distribution with a minimum of 5 psig, a scale factor of 45 psig, and a shape factor of 2.4. This distribution is applied to all canisters considered in the preclosure safety analysis (PCSA).

D2.1.5 Probabilistic Fragility Analysis

The mechanistic models described above produce results that are deterministic. That is, for a given set of input values, they yield a single answer. However, as has been shown, the inputs to the models are uncertain. Uncertainty in the input parameters could lead to a substantial variation in the predicted canister thermal response and failure temperature. Therefore, it is necessary to treat the analysis in a probabilistic manner. It is in the fragility analysis that all the parameters that affect the failure of the spent fuel or high level waste canister are addressed in a probabilistic fashion.

The fragility analysis consists of two separate probabilistic analyses: (1) an analysis to determine the probability distribution for the canister failure temperature, and (2) an analysis to determine the maximum temperature reached by the canister due to the fire. These two analyses are combined to determine the probability that the canister fails as a result of the fire.

Calculations were performed for canisters inside a waste package, a cask, or a shielded bell. As discussed earlier, two canister wall thicknesses were evaluated: 0.5 inches (hereafter referred to

as *thin-walled* canisters) and 1.0 inch (hereafter referred to as *thick-walled* canisters). The following sections describe how these analyses are performed and present the calculated failure probabilities for the various canister configurations of interest.

D2.1.5.1 Probabilistic Analysis of Canister Failure Temperature

The first step in the fragility analysis was to determine the probability distribution for the canister failure temperature. The probability distribution was determined using a Monte Carlo analysis in which the failure models outlined in Section D2.1.4 were repeatedly solved with parameter values sampled from the uncertainty distributions discussed in that section. The failure temperature for each sample was the lower of the two temperatures calculated based on creep rupture or limit load failure.

A Microsoft Excel add-in product, Crystal Ball, was used to perform Monte Carlo simulation. Latin hypercube sampling was used to ensure that parameter samples represented the assigned distributions adequately.

Figure D2.1-4 shows the calculated canister failure temperature distribution for canisters inside a waste package, transportation cask, or shielded bell. This calculation used the lower heating rate discussed in Section D2.1.4.5.3.3. The probability distribution shown in Figure D2.1-4 is well-characterized by a normal distribution with a mean of 1,203°K and a standard deviation of 22.85°K. This normal distribution provides a particularly good fit to the lower failure temperature portion of the distribution which is the most important for the canister failure analysis.

A similar analysis was performed for bare canisters. This calculation used the higher heating rate discussed in Section D2.1.4.5.3.3. The resulting probability distribution was nearly identical to the one shown in Figure D2.1-4. The reason for this is that canister failure was nearly always due to limit load failure rather than creep failure, so the difference in heating rates for the two configurations was not important.

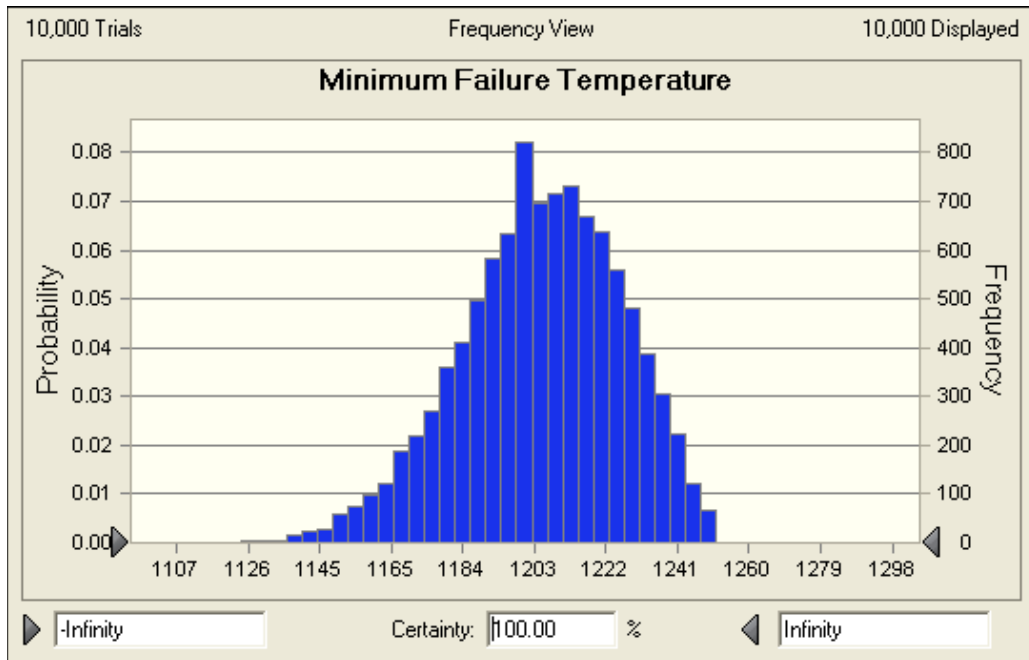

Source: Original

Figure D2.1-4. Probability Distribution for the Failure Temperature of Thin-Walled Canisters

A similar analysis was performed for thick-walled canisters. As with the thin-walled canisters, the probability distribution for the canister failure temperature was found to be nearly independent of the canister heating rate. Figure D2.1-5 shows the calculated probability distribution. This probability distribution is well-characterized by a normal distribution with a mean of 1,232°K and a standard deviation of 12.3°K. This normal distribution provides a particularly good fit to the lower failure temperature portion of the distribution which is the most important for the canister failure analysis.

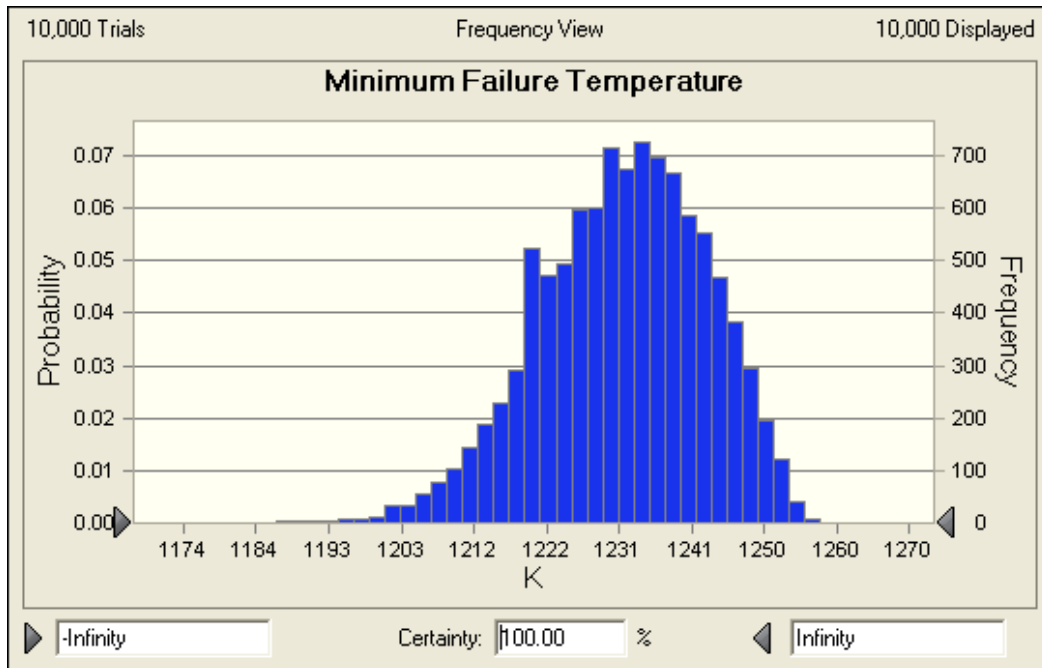

Source: Original

Figure D2.1-5. Probability Distribution for the Failure Temperature of Thick-Walled Canisters

D2.1.5.2 Probabilistic Analysis to Determine the Maximum Canister Temperature and Canister Failure Probability

The next step in the fragility analysis was to determine the maximum temperature of the canister as a result of the fire. In this analysis, Monte Carlo techniques were used to repeatedly sample from the uncertainty distributions discussed in Section D2.1.4 while applying the canister heating models to determine the maximum temperature of the canister due to the fire. As with the failure temperature analysis, Crystal Ball was used to perform the Monte Carlo simulation.

For each Monte Carlo sample, the calculated maximum canister temperature was then compared to a canister failure temperature sampled from the probability distribution discussed in Section D2.1.5.1. The canister is considered failed if the maximum temperature of the canister exceeded the sampled failure temperature for that Monte Carlo sample. The failure probability was determined as the fraction of the samples for which failure was calculated.

This process was repeated for a sufficient number of samples to provide a good statistical basis for the failure probability. The rule of thumb used in determining the required number of samples was that at least 10 failures had to be calculated. Thus, if the failure probability was on the order of 10^{-4} , 100 thousand (10^5) samples were needed. The maximum number of samples for any run was set at 1 million. If no failures were calculated for one million samples, the failure probability was recorded as being less than 10^{-6} .

Since each Monte Carlo sample has two possible outcomes (failure or no failure), each sample represents a Bernoulli trial. Since the probability of failure or no failure is the same for each trial, the outcome from the sampling process can be represented by a binomial distribution. The

binomial distribution is closely approximated by a normal distribution if the number of failures is greater than about five. The mean of the normal distribution is simply the number of failures divided by the total number of samples. The standard deviation of the normal distribution is given by the following equation:

$$\sigma = \sqrt{\frac{\frac{n_{\text{fail}}}{N} \left(\frac{N - n_{\text{fail}}}{N} \right)}{N}} \quad (\text{Eq. D-24})$$

where n_{fail} is the number of failures, N is the total number of Monte Carlo samples, and p_{fail} is the calculated mean failure probability (n_{fail}/N).

Figure D2.1-6 shows the calculated distribution for the maximum temperature reached by a thin-walled canister inside a waste package. The figure shows that the vast majority of the Monte Carlo samples had maximum temperatures well below 950°K. Only under extreme combinations of fire temperature and duration did the calculated maximum temperature approach the failure temperatures shown in Figure D2.1-4. Consequently there were only 32 calculated canister failures out of a total of 100,000 Monte Carlo samples. The resulting mean value for the canister failure probability is therefore 32/100,000 or 3.2×10^{-4} . The standard deviation calculated using Equation D-24 is 5.7×10^{-5} . The mean and standard deviation of the failure probability are shown in Table D2.1-8.

A similar analysis was performed for a thick-walled canister inside a waste package. Because of the thicker wall, the failure temperature of the canister is higher than for the thin-walled canister. In addition, the thick-walled canister heats up more slowly than the thin-walled canister because of its greater mass. These two factors combine to substantially lower the probability of failure for these canisters. In the Monte Carlo analysis, 20 failures were calculated for 200,000 samples, which results in a mean failure probability of 1×10^{-4} and a standard deviation of 2.2×10^{-5} .

Similar calculations have been performed for a canister inside a transportation cask and a canister inside the shielded bell of the CTM. The resulting mean and standard deviation for the canister failure probability are provided in Table D2.1-8.

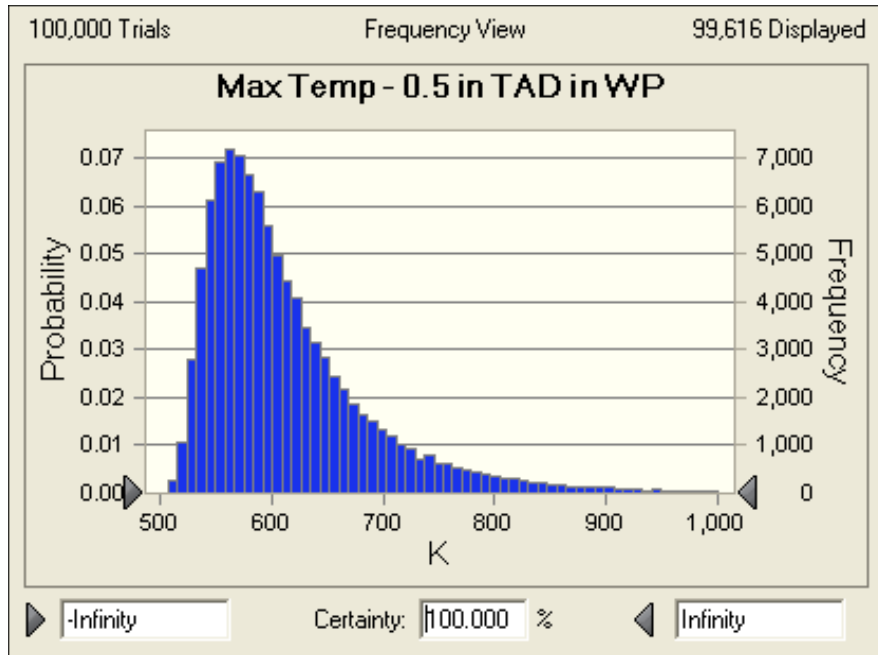

Source: Original

Figure D2.1-6. Probability Distribution for Maximum Canister Temperature – Thin-Walled Canister in a Waste Package

Table D2.1-8. Summary of Canister Failure Probabilities in Fire

Configuration ^b	Monte Carlo Results		Failure Probability	
	Total Failures	Total Trials	Mean	Standard Deviation
Thin-Walled Canister in a Waste Package ^a	32	100,000	3.2×10^{-4}	5.7×10^{-5}
Thick-Walled Canister in a Waste Package ^a	20	200,000	1.0×10^{-4}	2.2×10^{-5}
Thin-Walled Canister in a Transport Cask	2	1,000,000	2.0×10^{-6}	1.4×10^{-6}
Thick-Walled Canister in a Transport Cask	1	1,000,000	1.0×10^{-6}	1.0×10^{-6}
Thin-Walled Canister in a Shielded Bell	27	200,000	1.4×10^{-4}	2.6×10^{-5}
Thick-Walled Canister in a Shielded Bell	27	300,000	9.0×10^{-5}	1.7×10^{-5}

NOTE: ^aFor the 5-DHLW/DOE SNF waste package, this probability applies only to the DOE HLW canisters located on the periphery of the waste package. The DOE SNF canister in center of the waste package would not be heated appreciably by the fire.

^bConfigurations not addressed in this table include, any canister in a waste package that is inside the transfer trolley or any canister inside an aging overpack. In these configurations, the canister is protected from the fire by the massive steel transfer trolley or by the massive concrete overpack. Calculations have shown that the temperatures experienced by the canister in these configurations are well below the canister failure temperature. Although failures for these configurations could be screened on this basis, a conservative screening probability of 1×10^{-6} is used in the PCSA.

Source: Original

Note that Table D2.1-8 contains no failure probability for a bare canister configuration. The reason for this is that the canister is outside of a waste package or cask for only a short time. During that time, the canister is usually inside the shielded bell of the CTM. The preceding analysis addressed a fire outside the shielded bell. When in that configuration, the canister is shielded from the direct effects of the fire. A fire inside the shielded bell, which could directly heat the canister, was not considered to be physically realizable for two reasons. First, the hydraulic fluid used in the CTM equipment is non-flammable (Ref. D4.1.48, p 30) and no other combustible material could be present inside the bell to cause a fire. Second, the annular gap between the canister and the bell only 3 inches wide, but is approximately 27 feet long. Given this configuration, it is unlikely that there would be sufficient inflow of air to sustain a large fire. There may be sufficient inflow to sustain a localized fire, but such a fire would not be adequate to heat the canister to failure.

The canister is also outside of a cask, waste package, or shielded bell as it is being moved from a cask into the shielded bell or from the shielded bell into a waste package. The time during which the canister would be in this configuration is extremely short (a matter of minutes) so a fire that occurs during this time is extremely unlikely. In addition, because the gap between the top of the waste package or cask and ceiling of the transfer cell is generally much shorter than the height of the canister, only a small portion of the canister surface would be exposed to the fire. Furthermore, this exposure would only be for the short time that the canister was in motion.

For these reasons, failure of a bare canister was not considered a physically realizable threat to breach of a canister and was not treated further.

The notes to Table D2.1-8 mention two other configurations for which fire-induced canister failure is not credible: a fire outside a waste package inside a waste package transfer trolley (WPTT) and a fire outside an aging overpack. These two special cases are discussed below.

The failure probability for a waste package in the WPTT was determined using the probabilistic methodology discussed above. For this calculation, the waste package calculation discussed earlier was modified by simply adding a thermal barrier outside the waste package to represent the WPTT. The fire heats the WPTT which then transfers heat by radiation to the outer barrier of the waste package. The WPTT was modeled as having an equivalent external diameter of 3.05 meters, a thickness of 20.3 cm (steel thickness only¹), and a mass of 89,000 kg. The transfer trolley was considered to be made of a stainless steel with an average specific heat of 476 J/kg K. The probabilistic analysis was run for 1 million Monte Carlo samples and no failures were calculated. Though the maximum temperature calculated in this analysis was well below the failure temperatures shown in Figures D2.1-4 and D2.1-5, a conservative failure probability of 1×10^{-6} is used in the PCSA.

The probabilistic methodology discussed above could not be used for analysis of canister failure for a fire outside an aging overpack. The reason for this is that the concrete that comprises the majority of the aging overpack has a very low thermal conductivity. Therefore, the underlying premise of a relatively uniform temperature in each cylindrical region would be incorrect. Instead, a simple heat conduction calculation was performed to determine how far into the concrete heat could be conducted during a fire. The thermal penetration depth (from Equation D-11) was estimated based on a bounding 2-hour fire and concrete with the following average properties: thermal conductivity = 1.2 W/m K; density = 2,200 kg/m³; and specific heat = 1,000 J/kg K. The thermal penetration depth calculated for these conditions was 6.3 cm. Since the aging overpack is expected to be at least 24 inches (61 cm) thick, the canister inside the aging overpack will not be heated significantly by the fire. A conservative failure probability of 1×10^{-6} is used in the PCSA.

Note that, in this calculation, the fire was modeled as being only on the outside of the aging overpack. Though the overpack has ventilation openings for natural circulation, this flow path is expected to provide sufficient resistance to airflow that (1) combustion could not be sustained inside the overpack even if fuel entered through the openings, and (2) hot gases would likely flow over the outer surface of the overpack rather than enter the ventilation openings and flow up through the annulus inside the overpack. In fact, because oxygen would be consumed by the fire near the bottom of the overpack, air may actually flow downward through the ventilation openings to supply air to the fire.

D2.1.5.3 Analysis To Determine Failure Probabilities For Bare Fuel in Casks Exposed To Fire

Another fire-induced failure mode is of interest in the PCSA; namely, failure of a transport cask containing bare spent fuel assemblies. The analysis uses GA-4/GA-9 transportation casks to represent casks of this type. Should a transportation cask containing uncanistered spent nuclear

¹ There is also a 7.5-inch layer of borated polyethylene. Because this layer is likely to melt early in the fire transient, it is ignored in the analysis.

fuel fail in a fire, it is of interest for determining the source term to know if the fuel cladding is heated above its failure temperature (approximately 700°C to 800°C).

A modified version of the model for failure of a canister in a transportation cask was used to determine the probability that fuel will exceed this failure temperature. In the modified spreadsheet, the canister was replaced by the mass of fuel that would be heated during the fire. As in the bare canister analysis discussed in Section D2.1.4.1, this mass was estimated based on the calculated thermal penetration depth. Based on the information provided in the GA-9 SAR report (Ref. D4.1.34, p. 3.6-3), the following average spent fuel properties were determined: thermal conductivity = 1.5 W/m K, density × specific heat = 9.9×10^5 J/m³ K. For a 1-hour fire, the calculated thermal penetration depth is 7.4 cm and the effective fuel mass is 1,910 kg. Since the severe fires of greatest concern have durations of 1 hour or longer, this fuel mass represents a reasonable, but probably conservative, estimate.

Other modifications to the model included changes to model the geometry and materials used in the GA-4/GA-9 casks. The inputs to the model are presented in Table D2.1-9. As in the previous analyses, the model does not rely on neutron shield because it is liable to melt early in the transient.

The model was run for three different fuel failure temperatures: 700°C, 750°C, and 800°C. This range of failure temperatures represents the lower end of the values reported in the literature (Ref. D4.1.65, pp. 7-20 to 7-21). As shown in Table D2.1-10, the calculated fuel failure probabilities were less than 0.001.

Table D2.1-9. Model Inputs – Bare Fuel Cask

Model Parameter	Value	Basis/Rationale
Fuel Properties		
Heated Mass (kg)	1,910	Calculated based on thermal penetration depth (see text)
Specific Heat (J/kg K)	438	Average for fuel region taken from <i>Thermal Responses of TAD and 5-DHLW/DOE SNL Waste Packages to a Hypothetical Fire Accident</i> (Ref. D4.1.25, Table 15)
Effective Surface Area (m ²)	10.0	Projected area for radiation heat transfer. Calculated based on equivalent outer diameter of fuel region (0.66 m)
Emissivity	0.8	From <i>Thermal Responses of TAD and 5-DHLW/DOE SNL Waste Packages to a Hypothetical Fire Accident</i> (Ref. D4.1.25, Table 17)
Initial Temperature (K)	400	Estimated from fig 3.4-4 in GA-9 SAR (Ref. D4.1.34)
Transportation Cask Outer Shell		
Outer Diameter (m)	1.12	Equivalent diameter estimated based on GA-9 SAR (Ref. D4.1.34, Figure 1.2-9)
Wall Thickness (m)	0.0032	Minimum outer shell thickness listed in cask SAR (Ref. D4.1.34)
Length (m)	4.25	Length adjacent to the fuel region
Density (kg/m ³)	7850	Density of 516 carbon steel (Ref. D4.1.6, Section II, Part A, SA-20, 14.1)
Specific Heat (J/kg K)	604	Approximate value for 516 carbon steel at 400°C (Ref. D4.1.25, Table 10)

Table D2.1-9. Model Inputs – Bare Fuel Cask (Continued)

Model Parameter	Value	Basis/Rationale
Emissivity	0.8	Average value for carbon steel in Avallone and Baumeister, (Ref. D4.1.8, Table 4.3.2)
Initial Temperature (K)	344	Estimated from fig 3.4-4 in GA-9 SAR (Ref. D4.1.34)
Transportation Cask Gamma Shield^a		
Outer Diameter (m)	0.902	Equivalent diameter estimated based on GA-9 SAR (Ref. D4.1.34, Figure 1.2-9)
Wall Thickness (m)	0.107	Combined thickness of stainless steel and depleted uranium shields (steel: 0.0445 m; DU: 0.0622 m)(Ref. D4.1.34)
Length (m)	4.25	Length adjacent to the fuel region
Mass × Specific Heat (J/K)	3.45×10^6	Based on calculated masses of steel and DU and specific heats listed in GA-9 SAR (Ref. D4.1.34, Tables 2.2-1 and 3.2-2)
Emissivity	0.8	Average value for carbon steel in Avallone and Baumeister, (Ref. D4.1.8, Table 4.3.2)
Initial Temperature (K)	360	Estimated from fig 3.4-4 in GA-9 SAR (Ref. D4.1.34)
Post-Fire Conditions		
Ambient Temperature (K)	361	Post-fire temperature of 190°F from <i>Discipline Design Guide and Standards for Surface Facilities HVAC Systems</i> Ref. D4.1.16, Section 3.2). This value is 100 °F higher than the maximum interior facility temperature
Heat Transfer Coefficient (W/m ² K)	2.0	Natural convection based on anticipated post-fire surface temperature and standard convective heat transfer correlations (Results not sensitive to this value)

NOTE: ^a Composite properties representing both the stainless steel cask wall and depleted uranium gamma shield. DU = depleted uranium

Source: Original

Table D2.1-10. Summary of Fuel Failure Probabilities

Fuel Failure Temperature	Monte Carlo Results		Failure Probability	
	Total Failures	Total Trials	Mean	Standard Deviation
700°C	54	100,000	5.4×10^{-4}	7.4×10^{-5}
750°C	27	100,000	2.7×10^{-4}	5.2×10^{-5}
800°C	13	100,000	1.3×10^{-4}	3.6×10^{-6}

Source: Original

D2.1.5.4 Analysis To Determine Failure Probabilities For Casks Exposed To Fire

NUREG/CR-6672 (Ref. D4.1.65, Section 6) provides an analysis of seal failure in bare fuel transportation casks. The analysis uses a simple 1-D axisymmetric heat transfer model that is similar to the simple model used in the fire fragility analysis presented in Section D2. The simple model is used to determine the length of time the cask could be exposed to an 800°C or 1,000°C fire before seal failure would be predicted.

The report notes that the elastomer seals used in many transportation casks degrade completely at 500°C, but that the degradation rate increases significantly at 350°C (Ref. D4.1.65, p. 2-9). Other seal degradation information provided by cask vendors indicates that the maximum design temperature for the metallic o-ring seals in the TN-68 casks is 536°F (280°C) (Ref. D4.1.66, p. 3-2). This is the maximum safe temperature for continuous operation. The actual failure temperature for these seals would be much higher. Based on this information, seal failure is anticipated at temperatures of around 350°C to 450°C.

NUREG/CR-6672 indicates that the seals in a steel/depleted uranium (DU) truck cask would reach 350°C if exposed to a 1,000°C fire for 0.59 hours (Ref. D4.1.65, Table 6.5). In a steel/lead/steel (SLS) truck cask, this temperature would be reached in 1.04 hours. The times for rail casks were longer at 1.06 hours for an SLS rail cask and 1.37 hours for a monolithic steel rail cask.

The probability distributions for fire temperature and fire duration discussed in section D2.1.1 can be used to determine the probability that the fire conditions listed in the preceding paragraph would be exceeded. This is accomplished by first determining the probability distribution (using Crystal Ball) for the maximum thermal radiation energy from the fire using the following equation:

$$Q_{\text{rad}} = \sigma A T_{\text{fire}}^4 t_{\text{fire}} \quad (\text{Eq. D-25})$$

where:

- σ = the Stefan-Boltzmann constant ($5.668 \times 10^{-8} \text{ W/m}^2 \text{ K}^4$)
- A = cask surface area exposed to the fire
- T_{fire} = fire temperature (sampled from the probability distribution)
- t_{fire} = fire duration (sampled from the probability distribution)

The probability distribution for Q_{rad} is shown in the figure below:

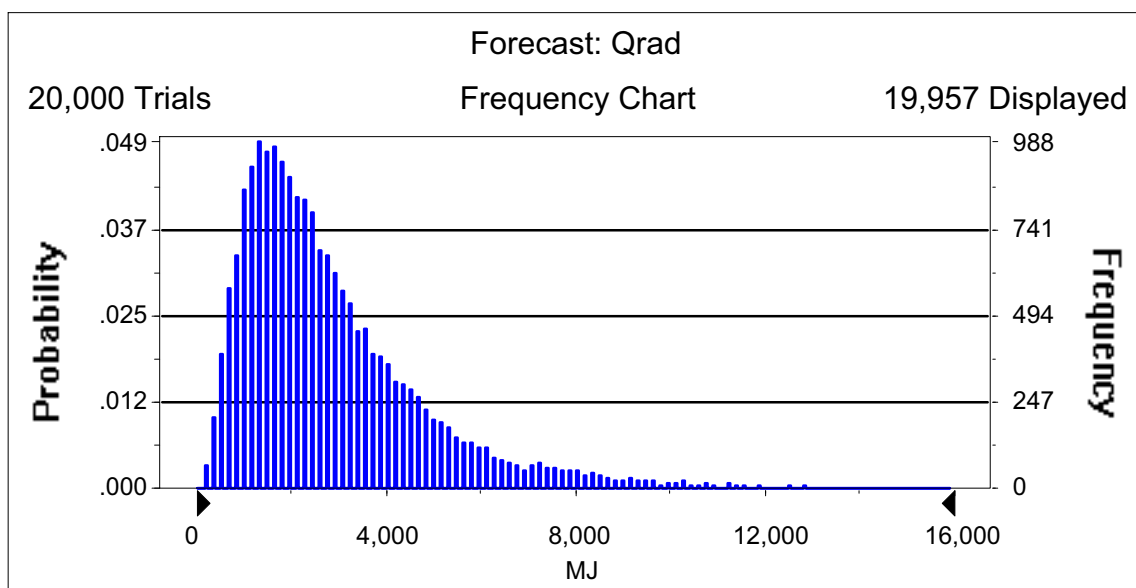

Source: Original

Figure D2.1-7. Distribution of Radiation Energy from Fire

Next, the value for Q_{rad} corresponding to the NUREG/CR-6672 fire temperature and duration for seal failure is calculated. The probability distribution for Q_{rad} can then be used to determine the probability that the fire will be severe enough to cause seal failure (i.e., will exceed the value for Q_{rad} calculated based on the NUREG/CR-6672 conditions).

The values for Q_{rad} corresponding to a 1,000°C fire and the fire durations reported in NUREG/CR-6672 are listed below along with the probability of exceedance determined from the probability distribution. The exceedance probabilities can be used as an estimate of the seal failure probability for seals that fail at the temperature, T_{fail} , listed in Table D2.1-11. For example, for a SLS truck cask that has seals that fail at 350°C, the probability that the seals fail due to a fire is 6.9×10^{-3} .

By multiplying the highest seal failure probability in Table D2.1-11 (0.05) by the highest probability of fire-induced cladding failure in Table D2.1-11 (5.4×10^{-4}), it is shown that the joint conditional probability of a fire that causes additional cladding failure in a truck cask, given a fire, is less than 3×10^{-5} . Because the fire initiating event frequency over the preclosure period of such truck cask fires is less than 1 (see Attachment F for the facilities that contain these, i.e., WHF and Intra-Site operations), such fires are beyond Category 2 and not analyzed further.

Table D2.1-11. Probabilities that Radiation Input Exceeds Failure Energy for Cask

Cask Type	T _{fail} (°C)	Temperature (°C)	Duration (hrs)	Q _{rad} (MJ)	P _{exceed}
Steel/DU Truck Cask	350	1,000	0.59	7,208	5.0 × 10 ⁻²
Steel/Lead/Steel Truck Cask	350	1,000	1.04	12,405	6.9 × 10 ⁻³
Steel/Lead/Steel Rail Cask	350	1,000	1.06	12,950	5.6 × 10 ⁻³
Monolithic Steel Rail Cask	350	1,000	1.37	16,737	1.7 × 10 ⁻³
Steel/DU Truck Cask	500	1,000	≈ 1.0 ^a	≈ 12,200	7.1 × 10 ⁻³
Steel/Lead/Steel Truck Cask	500	1,000	≈ 1.3 ^a	≈ 15,900	2.2 × 10 ⁻³

NOTE: ^a Estimated from Figure 6.6 in NUREG/CR-6672 (Ref. D4.1.65).

Source: Original

D2.2 SHIELDING DEGRADATION IN A FIRE

The NUREG/CR-6672 (Ref. D4.1.65) transportation study performed analyses on the internal temperatures of cask for long duration fires of 1,000°C. The transportation study included scenarios for fire-only and fire-plus-impact in the calculation of the probability of loss of shielding (LOS).

D2.2.1 Analysis of Loss of Shielding for Transportation Casks

All transportation casks contain separate gamma and neutron shields. The neutron shields are generally composed of a low melting point polymer material that would melt and offgas very quickly when exposed to a fire. For that reason, it is given that the neutron shield is always lost in fire scenarios. The composition of the gamma shield varies between cask designs, with some designs having layers of steel and depleted uranium, others having layers of steel and lead, or and others with layers of steel. Only casks containing lead could lose their gamma shielding in a fire.

As previously discussed, the thermal analyses for the transportation casks (Ref. D4.1.65, Table 6.5) shows that the internal regions of the cask reach the 350°C range in the range of 0.59 to 1.37 hours for the long duration 1,000°C fire. The least time represents the steel-depleted uranium casks and the longest the monolithic steel. The time to reach 350°C for steel-lead-steel (SLS) casks is about one hour. The time to reach the lead melting temperature (327.5°C) should be somewhat less than one hour but is not specified. However, NUREG/CR-6672 (Ref. D4.1.65) indicates that lead melting in itself does not result in significant LOS but the melting must be accompanied by outer shell puncture that permits the lead to flow out of the shield configuration.

NUREG/CR-6672 states that there are four characteristic fires of interest in the transportation risk analysis: 10 minutes as the duration of a typical automobile fire; 30 minutes for a regulatory fires; 60 minutes for an experimental pool fire for fuel from one tanker truck; and 400 minutes for an experimental pool fire from one rail tank car. These typical durations suggest that a real fire is unlikely to last long enough to result in a LOS condition for transportation scenarios.

D2.2.2 Probability of LOS in Fire Scenarios

Melting of the lead shielding and loss of containment of the molten lead results in loss of shielding for SLS casks. Two mechanisms for escape of the molten lead are considered:

- Puncture of the outer shell
- Rupture lead containment due to internal pressure

Puncture of the 2-inch thick (or more) outer shell, in addition to exposure to fire, would allow molten lead to escape, resulting in LOS. The shell puncture would be an independent failure with a probability of 10^{-8} for the low speeds at which the cask would be moving (Table 6.3-4). With the additional failure of exposure to fire, the LOS probability would be even less.

Containment of the molten lead could be lost due to thermal expansion of the lead coincident with the thermal weakening of the steel. Molten lead is cast into the cavity bounded by the inner and outer shells and the bottom plate ((Ref. D4.1.50, p. 1.1-4); (Ref. D4.1.49, p. 1.2-2); (Ref. D4.1.9, p. 1.2-5); and (Ref. D4.1.47, p. 1-5)). The lead contracts as it cools and solidifies. When the cask is exposed to a fire and the lead melts, it expands to reoccupy the volume when originally cast. When heated beyond the melting point, the liquid lead could continue to expand, exerting hoop stresses upon the inner and outer shells. The shells are thick and strong, e.g. the inner and outer shell thicknesses for the MP197 are 1.25 and 2.5 inches, respectively (Ref. D4.1.47, Drawing 1093-71-4, rev. 1), and the bottom plate thickness is 6.5 inches (Ref. D4.1.47, Drawing 1093-71-2, rev. 1). Consequently, failure of the steel is considered very unlikely.

As part of the PCSA, an attempt was made to analyze hydraulic failure of the molten lead containment due to a fire. Unfortunately, the thermal and physical properties of lead necessary for this analysis could not be found. Thus, hydraulic failure cannot be conclusively disproved. For that reason, a probability of 1.0 is used for LOS by transportation casks due to fire.

D2.2.3 Bases for Screening of Loss of Shielding Pivotal Events for Aging Overpacks in Fire Scenarios

This section summarizes the rationale for screening loss of shielding pivotal events associated with heating of aging overpacks in a fire. Loss of shielding could occur if the concrete that comprises the majority of the aging overpack spalled as a result of the fire. Spalling would reduce the thickness of the concrete and, if sufficient spalling occurs, the thickness could be reduced below the level required for adequate shielding.

D2.2.3.1 Thickness of Concrete Required for Adequate Shielding

The concrete thickness needed for adequate shielding can be estimated by determining the dose outside the overpack for different concrete thicknesses and comparing that dose to the exposure limits for radiation workers. For this calculation, the exposure rate on the surface of the aging overpack prior to the fire is 40 mrem/hr (Ref. D4.1.15, Section 33.2.4.17).

The dose outside the aging overpack is primarily due to Co-60 gamma radiation, the gamma attenuation due to concrete can be estimated based on data available from the National Institute

of Standards and Technology (NIST) (Ref. D4.1.40). This reference lists a value for the mass attenuation coefficient of the concrete divided by the concrete density (μ/ρ) of $0.058 \text{ cm}^2/\text{g}$ for the gammas produced by Co-60. Multiplying this value by an approximate concrete density of 2.3 g/cm^3 (Ref. D4.1.39, Table 4.2.5) yields a value for the mass attenuation coefficient of 0.133 cm^{-1} . Based on this value, there is approximately a factor of 10 reduction in the gamma dose for each 17.2 cm (6.8 inches) of concrete.

If the outer 6.8 inches of concrete were to spall as a result of the fire, the dose at the surface of the aging overpack would increase to 400 mrem/hr. If an additional 6.8 inches of concrete were to spall, the dose on the surface would be 4 rem/hr. The original concrete thickness is 34 inches based on existing aging overpack drawings (Ref. D4.1.14). There is 27.2 inches of concrete remaining after the first 6.8 inches of spallation and 20.4 inches of concrete remaining after the second 6.8 inches of spallation.

The dose outside the aging overpack can be estimated by noting that the dose decreases as the square of the distance from the source. After 13.6 inches of concrete has spalled, the dose 20.4 inches from the surface of the aging overpack would be 1 rem/hr, and the dose 61.2 inches from the surface would be 250 mrem/hr. Therefore, even in the case of extensive concrete spalling, workers involved in fire fighting or post-fire activities could be in close proximity to the degraded aging overpack for a lengthy period of time without exceeding either the annual exposure limit of 5 rem or special exposure limits outlined in 10 CFR Part 20 (Ref. D4.2.1, Paragraph 20.1206).

D2.2.3.2 Extent of Concrete Spalling in a Fire

The current aging overpack design has a steel liner outside the concrete shielding. Consequently, spalling and removal of concrete from the surface cannot occur unless the steel liner is removed or fails catastrophically. However, because alternative aging overpack designs have been considered without a steel outer liner, the potential for substantial spallation with a bare concrete shield was assessed.

Extensive spalling of structural concrete has been observed under some conditions when the structural concrete is exposed to intense fires. The most extensive spalling has been observed in tunnel fires, such as the Channel Tunnel fire in 1996. In such cases, a significant fraction of the concrete spalled when exposed to the intense heat from the long-duration fires.

Due to the potential significance of spalling in reducing the strength of concrete support structures, spallation of concrete has been the subject of considerable study. "Limits of Spalling of Fire-Exposed Concrete." (Ref. D4.1.37) provides a good overview of the factors that control concrete spalling due to fire. Hertz indicates that there are three types of spalling that can occur: (1) aggregate spalling, (2) explosive spalling, and (3) corner spalling. Aggregate spalling occurs with some aggregates (such as flint or sandstone) and results in superficial craters on the surface of the concrete. Corner spalling occurs only on the convex corners of beams or other structures and is caused by a localized weakening and cracking of the concrete such that the corner breaks off under its own weight. This mode of spalling is not relevant for the aging overpacks. Explosive spalling occurs when sufficient pressure builds up inside the concrete to cause pieces of concrete to be ejected from the surface. Explosive spalling is believed to account

for the extensive concrete loss observed in the Channel Tunnel fire. Of the three modes of spalling, only explosive spalling could produce the loss of concrete necessary to significantly reduce the shielding capability of the aging overpack.

“Predicting the fire resistance behaviour of high strength concrete columns,” (Ref. D4.1.43) notes that explosive spalling occurs when sufficient pressure builds up in the pores of the concrete to cause ejection of concrete from the surface. Buildup of such a high pressure requires three things: (1) low concrete permeability, (2) high moisture content in the concrete, and (3) rapid heating and resulting large thermal gradients. In addition, "Limits of Spalling of Fire-Exposed Concrete." (Ref. D4.1.37) notes that spallation is more pronounced in concrete structures undergoing high compressive stress, such as support columns.

Low permeability prevents gas migration and allows pressure to build. High structural strength concretes, such as those used in tunnel construction, are known to have very low permeability and are therefore more prone to spalling. In contrast, normal strength concretes do not have low permeability and spallation is not observed (Ref. D4.1.43). Because the concrete used for shielding in the aging overpacks is not counted on for structural strength and is therefore classified as normal strength concrete², spallation is unlikely to occur.

Moisture content is a major factor in pressure buildup because water vapor is the gas primarily responsible for high pore pressures in the concrete. The concrete in the aging overpacks is unlikely to have a high moisture content because it is heated both internally by decay heat and externally by solar heat. In addition, it is likely to have been sitting in the Nevada desert for a lengthy period of time.

Thus, although the fire will produce large thermal gradients in the concrete, these gradients are unlikely to result in pressure buildup sufficient to cause extensive spallation due to the expected high permeability and low moisture content of the aging overpack concrete. This would be true regardless of whether the outer steel liner is present or not.

D2.2.3.3 Conclusion

The preceding discussion has shown that a substantial amount of concrete would have to spall during a fire to produce a hazard to workers involved in either fire fighting or post-fire activities. In addition, it was shown that spallation is very unlikely given the type of concrete to be used in the aging overpacks and the likelihood that the aging overpacks will have an outer steel liner. For these reasons, loss of aging overpack shielding in a fire is considered Beyond Category 2 and need not be analyzed further.

D3 SHIELDING DEGRADATION DUE TO IMPACTS

Neutrons emitted from transportation casks are shielded by a resin surrounded by a steel layer. The neutron shielding is present in the top lid, bottom and shell. Neutron shields designed to 10 CFR Part 71 (Ref. D4.2.2) are robust against 10 CFR Part 71 hypothetical accident conditions

² For example, the compressive strength of the concrete used in the HI-STORM storage overpack (Ref. D4.1.39, Table 1.D.1) is listed as 3,300 psi or 22.75 MPa, which is well below the strength of 55 MPa usually defined as necessary for high strength concrete (Ref. D4.1.43).

related to impacts or drops, exhibiting factors of safety greater than 1 for Service Level D allowables. Meeting *2004 ASME Boiler and Pressure Vessel Code* Service Level D (Subsection NF) (Ref. D4.1.6) provides for twice the allowable stress intensity as normal operation but still results in an extremely low failure probability. In addition, neutron dose typically attenuates quickly with distance from the transportation cask so it is only a small fraction of the gamma dose to personnel more than two meters away. Evacuation to that distance is the way to reduce personnel dose from neutrons. For these reasons, the analysis below focuses on the principle threat to workers on the site, which is degradation of gamma shielding.

This section summarizes information on loss of shielding mechanisms that could occur in event sequences for repository waste handling operations. The information is derived from transportation cask accident risk analyses. This information provides insights and bases for estimating probabilities of passive failures that result in LOS for casks and overpacks in waste handling event sequences.

The repository facilities process three categories of waste containers that provide shielding: transportation casks (truck and rail) and aging overpacks. The event sequence diagrams for operations involving processing of transportation casks and aging overpacks include the pivotal event “loss of shielding” for event sequences that are initiated by physical impact or fire. LOS due to fire was addressed previously in section D2.2 of this attachment. The following discussion focuses specifically on LOS due to drops and impacts.

The information in this section is based in large part on results of finite-element analysis (FEA) performed for four generic transportation cask types for transportation accidents as reported in NUREG/CR-6672 (Ref. D4.1.65) and NUREG/CR-4829 (Ref. D4.1.32). The results of the FEA were used to estimate threshold drop heights and thermal conditions at which LOS may occur in repository event sequences, using damage severity levels keyed to the FEA results to determine the challenge needed to cause LOS. The four cask types included one steel monolith rail cask, one steel/depleted uranium truck cask, one SLS truck cask and one SLS rail cask. NUREG/CR-6672 states that the steel in any of the cask is thick enough to provide some shielding, but the depleted uranium and lead provide the primary gamma shielding for the multi-shell cask types. The referenced study performed structural and thermal analyses for both failure of containment boundaries and loss of shielding for accident scenarios involving rail cask and truck cask impacting unyielding targets at impact speeds of 30-60, 60-90, 90-120, and greater than 120 mph. The impact orientations included side (0–20 degrees), corner (20 degrees–85 degrees), and end (85 degrees–90 degrees). The referenced study also correlated the damage from impacts on real targets including soil and concrete.

The event sequences used in the transportation accident analyses included impact-only, impact plus-fire, and fire-only conditions. The results of the FEA indicate that LOS could occur in the impact-only at speeds as low as 30 mph with an unyielding target and in fire scenarios of sufficient intensity and duration. The structural analyses did not credit the energy absorption capability of impact limiters. Therefore, the results are deemed applicable to approximate the structural response of transportation and similar casks in drop scenarios.

The primary reference NUREG/CR-6672 (Ref. D4.1.65), however, does not provide a threshold below which no LOS could be assured. Therefore, information quoted in an evaluation by the

Association of American Railroads (AAR) (Ref. D4.1.30) was used to establish thresholds for LOS conditions based on damage categories that are correlated to plastic strain in the inner shell of a cask. That information is based on a prior transportation accident analysis known as the Modal Study (Ref. D4.1.32). For potential PCSA applications, FEA results for inner shell strain versus impact speed were extended to estimate the lower bound of impact speed or drop heights to establish conditions at which LOS may occur in cask-drop scenarios in repository operations.

NUREG/CR-6672 (Ref. D4.1.65) addresses two modes of LOS in accident scenarios: deformations of lid and closure geometry that permit direct streaming of radiation; and/or reductions in cask wall thickness or relocation of the depleted uranium or lead shielding. The LOS due to lid/closure distortion can be accompanied by air-borne releases if the inner shell of the cask is also breached.

The results of the FEA reported in NUREG/CR-6672 (Ref. D4.1.65) provides some definitive results that are deemed to be directly applicable to the repository event sequence analyses:

- Monolithic steel rail casks do not exhibit any LOS, but there may be some radiation streaming through gaps in closure in any of the impact scenarios. This result can be applied to both transportation casks.
- Steel/depleted uranium/steel truck cask exhibited no LOS, explained by modeling that included no gaps between forged depleted uranium segments so that no displacement of depleted uranium could occur.
- The SLS rail and truck casks exhibit LOS due to lead slumping. Lead slump occurs mostly on end-on impact with a lesser amount in corner orientation. For side-on orientation, there is no significant reduction in shielding.

Therefore, this analysis focuses on LOS for SLS casks to estimate the drop or collision conditions that could result in LOS from lead slumping. Figure D3.2-1 illustrates the effect of cask deformation and lead slumping for a SLS rail cask following an end-on impact at 120 mph onto an unyielding target from the result of the FEA reported in NUREG/CR-6672 (Ref. D4.1.65).

D3.1 DAMAGE THRESHOLDS FOR LOS

The AAR study (Ref. D4.1.30) is used as a reference for this report. The information cited, however, was derived from an earlier transportation cask study known as the “Modal Study,” (Ref. D4.1.32). The Modal Study assigned three levels of cask response characterized by the maximum effective plastic strain within the inner shell of a transport cask. The severity levels are defined as:

- S1—implies strain levels < 0.2%
- S2—implies strains between 0.2 and 2.0%
- S3—implies strain levels between 2.0 and 30%.

The amount of damage to a cask for the respective severity levels is summarized in the following:

S1:

- No permanent dimensional change
- Seal and bolts remain functional
- Little if any radiation release
- Less than 40 g axial force on lead for all orientations
- No lead slump
- Fuel basket functional; up to 3% of fuel rods may release into cask cavity
- Loads/releases within regulatory criteria.

S2:

- Small permanent dimensional changes
- Closure and seal damage; may result in release
- Limited lead slump
- Up to 10% of fuel rods release to cask cavity.

S3:

- Large distortions
- Seal leakage likely
- Lead slump likely
- 100% fuel rods release to cask cavity.

As stated above, limited lead slumping may occur at damage level S2, but is likely to occur at damage level S3. The respective strain levels associated with damage levels S2 and S3 were applied to the results from NUREG/CR-6672 (Ref. D4.1.65) to establish a threshold impact speed for the onset of LOS.

D3.2 SEVERITY OF DAMAGE VERSUS IMPACT VELOCITY

The FEA results given in Table 5.3 of NUREG/CR-6672 (Ref. D4.1.65) are summarized in Table D3.2-1. The strain in the inner shell of the SLS casks are shown in Table D3.2-1 and illustrated in Figure D3.2-1. These data were plotted (Figures D3.2-2 and D3.2-3). The data points start at the lowest speed range of 30 to 60 mph. The data were plotted as points using the lower boundary of each of the four speed ranges on the abscissa. The strain plots were extended to the origin by including the point (0, 0) with the Table D3.2-1 data.

Two horizontal lines were superimposed on Figures D3.2-2 and D3.2-3 to plot the 0.2% and 2.0% strain to represent the respective S2 and S3 thresholds for inner shell strain. The intersections of the strain curves with the respective threshold values indicate the minimum impact speed at which the respective S2 and S3 strain thresholds appear to be exceeded.

Table D3.2-1. Maximum Plastic Strain in Inner Shell of Sandwich Wall Casks

Cask Type	Orientation: Speed, mph	Corner Impact Strain, %	End Impact Strain, %	Side Impact Strain, %
SLS Truck	30	12	3.9	N/A
	60	29	12	16
	90	33	18	24
	120	47	27	27
SDUS Truck	30	11	1.8	6
	60	27	4.8	13
	90	43	8.3	21
	120	55	13	30
SLS Rail	30	21	1.9	5.9
	60	34	5.5	11
	90	58	13	15
	120	70	28	N/A

NOTE: SDUS = steel-depleted uranium-steel; SLS = steel-lead-steel.

Source: From Ref. D4.1.65, Table 5.3.

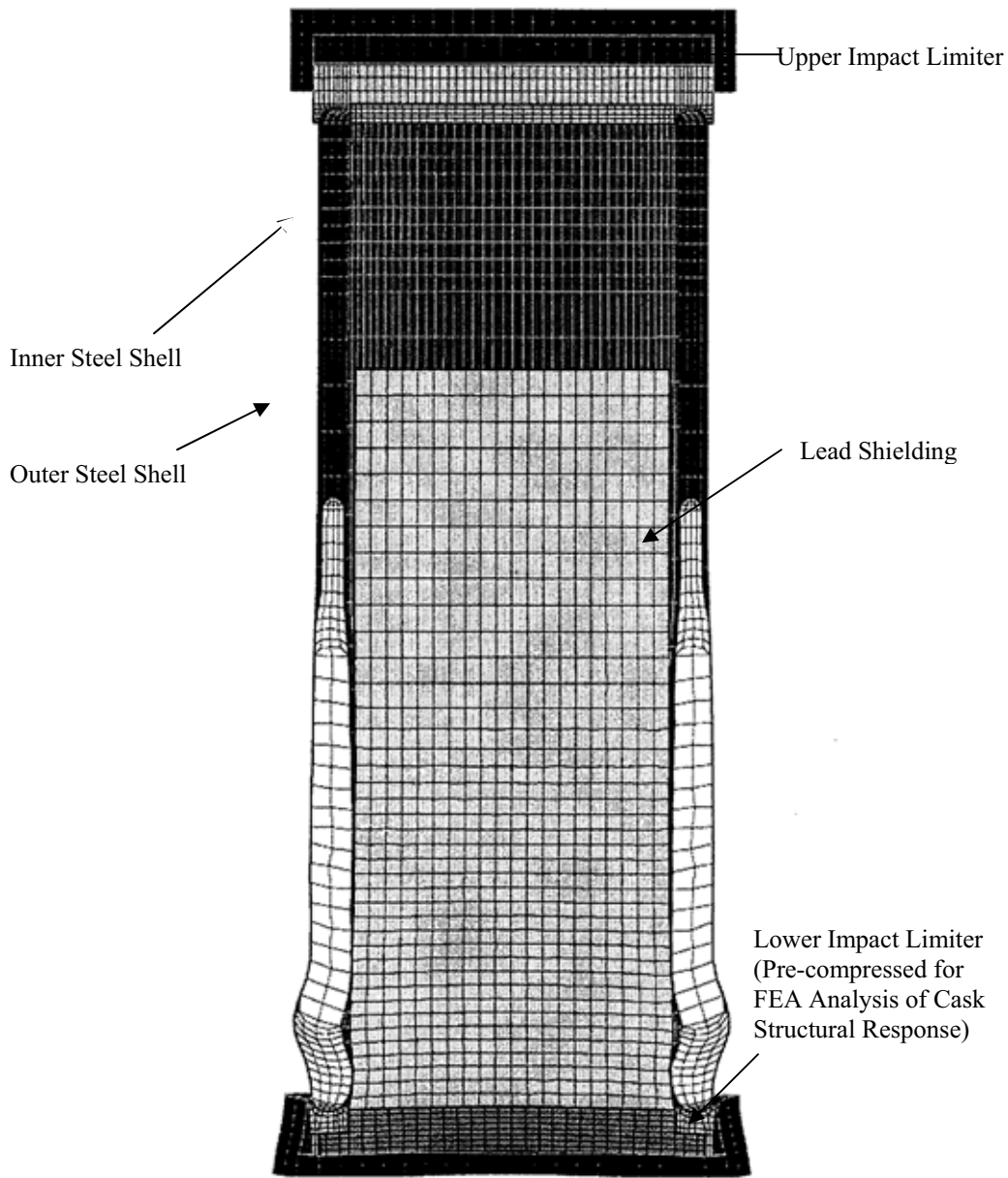

Source: From Ref. D4.1.65, Figure 5.9

Figure D3.2-1. Illustration of Deformation and Lead Slumping for a SLS Rail Cask Following End-on Impact at 120 mph

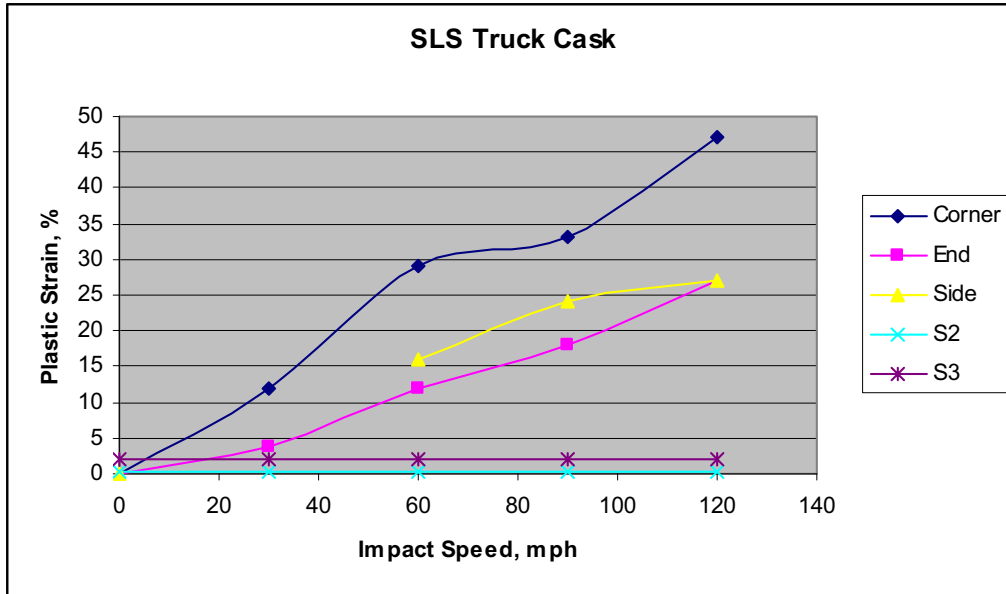

NOTE: ¹ Data points for strain versus speeds greater than 30 mph taken directly from NUREG/CR-6672, Table 5.3: plots extended to origin (0,0) to determine crossover for S2 and S3 threshold strains.

² S2 and S3 threshold strains based on information in *A Railroad Industry Critique of the Model Study* (Ref. D4.1.30). mph = miles per hour; SLS = steel-lead-steel.

Source: Original

Figure D3.2-2. Truck Steel/Lead/Steel Inner Shell Strain versus Impact Speed

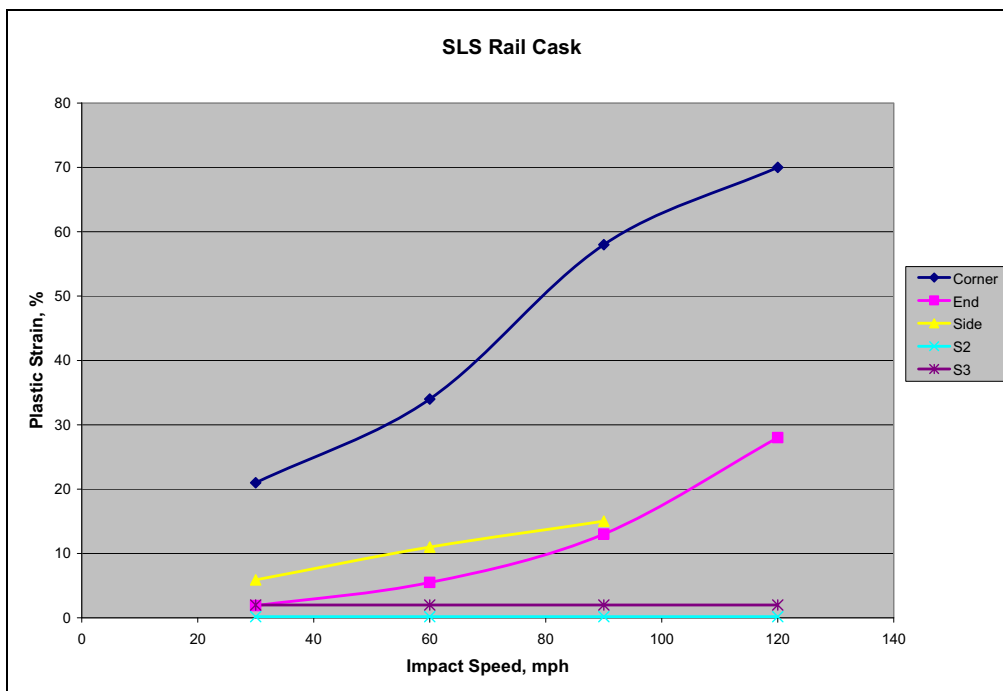

NOTE: ¹ Data points for strain versus speeds greater than 30 mph taken directly from NUREG/CR-6672 (Ref. D4.1.65, Table 5.3): plots extended to origin (0,0) to determine crossover for S2 and S3 threshold strains. ² S2 and S3 threshold strains based on information in *A Railroad Industry Critique of the Model Study* (Ref. D4.1.30). mph = miles per hour; SLS = steel-lead-steel.

Source: Original

Figure D3.2-3. Rail Steel/Lead/Steel Strain versus Impact Speed

D3.3 ESTIMATE OF THRESHOLD SPEEDS FOR LOSS OF SHIELDING DUE TO IMPACTS

The plots in Figures D3.2-2 and D3.2-3, and Table D3.2-1 illustrate that the S2 threshold is exceeded for both the truck and rail SLS casks for all four speed ranges and all orientations. Since NUREG/CR-6672 (Ref. D4.1.65) does not report LOS conditions for low impact speeds, it is concluded that the S2 criterion is not a valid threshold for LOS in SLS casks. Therefore, the remainder of this analysis applies the S3 criterion (2% shell strain) as a basis for estimating LOS threshold impact speeds.

Figures D3.2-2 and D3.2-3, and Table D3.2-1 indicate that the S3 threshold is exceeded for both truck and rail SLS casks for all orientations. The intersections of the strain curves and the 2% strain line in Figures D3.2-2 and D3.2-3 illustrate the impact speed at where the S3 threshold is reached for each case. A small exception being the end drop of a SLS rail cask in the 30-60 mph range for which the shell strain of 1.9% is just below the lower bound for S3 damage. However, this margin is too small to exclude that case. Although the strains for the side drop cases exceed the threshold for lead slumping, NUREG/CR-6672 (Ref. D4.1.65) states that lead slumping does not occur in side drops. Therefore, LOS for side drops is excluded from the remainder of this report.

Using the 2% shell strain condition as the threshold for LOS in SLS casks, the following is observed:

- LOS for the truck SLS cask would occur at impact speeds of about 5 mph for corner impact and about 18 mph for end impact
- LOS for the rail SLS cask would occur at about 3 mph for corner impact and about 30 mph for end impact.

It is observed that the corner drop cases give the largest shell strain at a given impact speed but the finite element analyses indicate that the extent of lead slumping is less in corner drops than for end impacts.

Table D3.3-1 shows the drop height equivalents for impact speed onto a horizontal unyielding surface. Thus, to exceed 5 mph, for example, a drop height greater than 0.8 ft is required; to exceed 30 mph impact, a drop height greater than 30 ft is required. Using the results cited above:

- LOS for the truck SLS cask would occur at impact speeds of about 0.8 ft (5 mph) for corner impact and about 10 ft (18 mph) for end impact
- LOS for the rail SLS cask would occur at about 0.5 ft (3 mph) for corner impact and about 30 ft (30 mph) for end impact.

Such drop heights could occur in some GROA handling operations.

However, when the effect of the energy absorption by real targets is considered, much greater impact speeds are required to impose the damage equivalent to impacts on unyielding targets. NUREG/CR-6672 (Ref. D4.1.65) provides a correlation of impact speeds for real versus unyielding target, but provides only bounding values for a large number of cases as presented in Table D3.3-2. Therefore, if LOS occurs at 30 mph for an end drop of a SLS train cask on unyielding surface, a speed of greater than 150 mph is required for an impact on concrete. This impact speed would require a drop of over 500 ft. Such drop heights cannot be achieved in repository handling.

Some of the LOS cases, including corner drops of truck and rail SLS casks, appear to result in LOS for impact speeds less than 10 mph. If the corner drops are onto concrete, a speed of 2 to 3 times the threshold speed for LOS for impact on an unyielding target. This implies a threshold impact speed of 20 to 30 mph for a corner drop onto concrete. The corresponding drop height is 13 feet to 30 feet. Such drops could occur in event sequences for repository handling.

Table D3.3-1. Drop Height to Reach a Given Impact Speed

Impact Speed, mph	Equivalent Drop Height, ft
2	0.1
5	0.8
10	3.3
20	13.4
30	30.1
40	53.4
50	83.5
60	120.2
70	163.7
80	213.8
90	270.6
100	334.0
110	404.2
120	481.0

Source: Original

Table D3.3-2. Impact Speeds on Real Target for Equivalent Damage for Unyielding Targets

Cask Type	Real Target type	Impact Type\Orientation w/o Impact Limiters	Impact Speed , mph			
			30	60	90	120
Rail SLS	Soil	End	>>150	>>150	>>150	>>150
		Side	72	>150	>>150	>>150
		Corner	68	133	>150	>150
	Concrete slab	End	>150	>>150	>>150	>>150
		Side	85	>150	>>150	>>150
		Corner	>>150	>>150	>>150	>>150
Truck SLS	Soil	End	>150	>>150	>>150	>>150
		Side	70	>150	>>150	>>150
		Corner	61	>150	>>150	>>150
	Concrete slab	End	123	180	>>150	>>150
		Side	35	86	135	>150
		Corner	56	123	>150	>>150

NOTE: mph = miles per hour; SLS = steel-lead-steel.

Source: Based on NUREG/CR-6672 (Ref. D4.1.65, Tables 5.10 and 5.12)

D3.4 PROBABILITY OF LOSS OF SHIELDING

NUREG/CR-6672 (Ref. D4.1.65) develops probabilities for LOS in transportation accidents. The probability of LOS uses event tree analysis with split fractions for various types of transportation accidents and frequencies based on accident rates per mile of travel for cask-bearing truck trailers or rail cars. The results of probability analyses of LOS as derived in

NUREG/CR-6672 (Ref. D4.1.65) do not have any direct relevance to event sequences for waste handling operations. However, the basic approach that breaks down the overall probability of an event sequence involving LOS into conditional probabilities for occurrence of various physical conditions that lead to LOS can be adapted for PCSA.

The vulnerability to LOS for repository event sequences varies with the container type:

1. Concrete overpack with no containment boundary (aging overpack)
2. Sandwich type with steel containment boundary and lead in the annulus between the steel shells (transportation cask).
3. All other casks including monolithic steel casks or casks with layers of steel or steel and depleted uranium (transportation cask, shielded transfer cask (STC)).

Concrete Overpacks

Aging overpacks provide shielding but not containment. They are used within the GROA to transport DPCs and TAD canisters between buildings and to and from the aging pads. The event sequences that involve both are of the form shown in Figure D3.4-1 below.

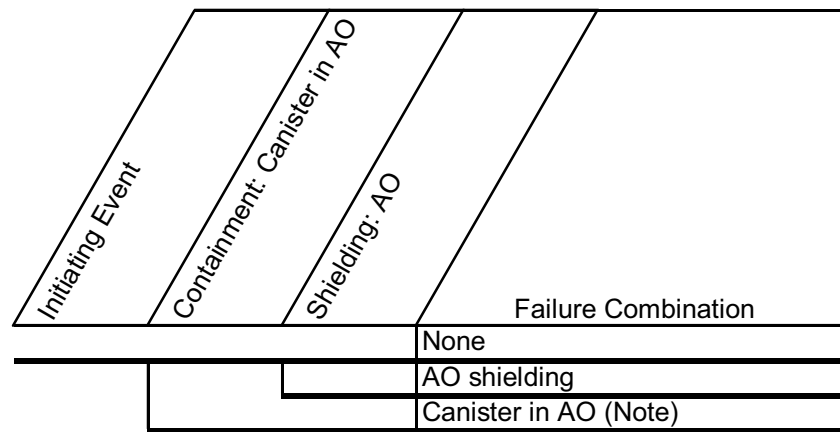

Note: Implies shielding is ineffective because of radionuclide release

NOTE: AO = aging overpack

Source: Original

Figure D3.4-1. Summary Event Tree Showing Model Logic for Canisters and Aging Overpacks

A site transporter transports aging overpacks with canisters within the GROA. The transporter is designed for a maximum speed of 2.5 mph (Ref. D4.1.18, Sections 3.2.1 and 3.2.4) and will elevate the aging overpack no more than 3 feet from the ground (equipment limit is 12 inches (Ref. D4.1.18, Section 2.2, item 9)), additional two feet is allowed for potential drop off edge of aging pad). Expanding the probability of success (no breach) of a canister within an aging overpack yields:

$$p_{AO}(C) = p_{AO}(C|O)p_{AO}(O) + p_{AO}(C|\bar{O})p_{AO}(\bar{O}), \quad (\text{Eq. D-26})$$

where

$p_{AO}(C)$ = probability of canister success within an AO.

$p_{AO}(C|O)$ = probability of canister success given AO shielding does not fail.

$p_{AO}(O)$ = probability that AO shielding does not fail.

$p_{AO}(C|\bar{O})$ = probability of canister success given AO shielding fails.

$p_{AO}(\bar{O})$ = probability that AO shielding fails.

The inner and outer steel lined 3 foot concrete aging overpack is much more robust against impact loads than a DPC. Therefore, if the overpack fails, it is much more likely that the canister will breach. This yields: $p_{AO}(C|O) \gg p_{AO}(C|\bar{O})$. Furthermore, the probability of aging overpack breach is much less than probability of aging overpack success at the above drop and speed conditions. Therefore: $p_{AO}(O) \gg p_{AO}(\bar{O})$. The second term on the right hand side of Equation D-26 is much less than the first term and need not be considered further in this analysis.

This leaves

$$p_{AO}(C) \cong p_{AO}(C|O)p_{AO}(O) \quad (\text{Eq. D-27})$$

Note that

$$p_{AO}(C) = 1 - p_{AO}(\bar{C}) \quad \text{and} \quad p_{AO}(O) = 1 - p_{AO}(\bar{O}) \quad \text{and}$$

$$p_{AO}(C|O) = 1 - p_{AO}(\bar{C}|O) \quad (\text{Eq. D-28})$$

Substituting Equations D-28 into D-27 and rearranging yields:

$$p_{AO}(\bar{O}) \cong 1 - \frac{1 - p_{AO}(\bar{C})}{1 - p_{AO}(\bar{C}|O)} \quad (\text{Eq. D-29})$$

LLNL has developed a mean probability of failure for a canister within an aging overpack, $p_{AO}(\bar{C})$, for a 3-foot drop onto a rigid surface with an initial velocity of 2.5 mph (Ref. D4.1.27).

This analysis uses a conservative value of 1E-05 relative to the 1E-08 value in the referenced LLNL report. The probability of canister failure given the aging overpack does not fail, $p_{AO}(\bar{C} | O)$, must be less than the overall probability of canister failure within an aging overpack, $p_{AO}(\bar{C})$. It is, therefore, reasonable to use a range of values of 1E-06 to 1E-05 for this, both of which are conservative relative to the value in the reference. The LLNL (Ref. D4.1.27) value, itself, has a conservative element in that it analyzes impact onto a rigid surface. The more realistic concrete surface would have a lower canister failure probability. Using the average between 1E-06 and 1E-05 of 5E-06 for $p_{AO}(\bar{C} | O)$ and also substituting the aforementioned value for $p_{AO}(\bar{C})$ into Equation D-29, there obtains:

$$p_{AO}(\bar{O}) \cong 1 - \frac{1 - p_{AO}(\bar{C})}{1 - p_{AO}(\bar{C} | O)} = 1 - \frac{1 - 10^{-5}}{1 - 5 \times 10^{-6}} = 5 \times 10^{-6} \quad (\text{Eq. D-30})$$

Steel/Lead/Steel Sandwich-Type Casks

For these sandwich-type casks, the probability of LOS due to lead slumping can be estimated from results of transportation cask studies that can be coupled to event sequence probability analysis and insights from the passive failure analyses. Since the speed of transport of transportation casks to, and within, the processing facilities is limited to a few mph, it is judged that LOS of SLS casks (and the other types) may be screened out from collision scenarios. However, LOS for SLS casks due to drops cannot be ruled out, if SLS casks are processed in the repository.

For SLS casks, the probability of LOS is derived from the probability that the drop height or impact speed exceeds the threshold at which lead shielding may slump. For all cask types, the probability of LOS is derived from the probability that the drop height or impact speed exceeds the threshold at which cask closure and/or seals fail in such a way to permit to permit direct streaming. A simplified conservative approach to estimating the probability of LOS due to lead slumping resulting from a drop of an SLS cask is summarized in the next section.

The PCSA considers drop and collision event sequences of transportation casks. Should a canister rupture occur, the analysis conservatively models the shielding as also lost. In such event sequences the probability of loss of shielding is taken to be 1.0 given canister rupture. This applies to all types of casks.

Event sequences also include LOS without canister rupture. That is, the drop or collision was not severe enough to cause a rupture but a LOS is possible in some casks. Such an event sequence can not occur in the steel/depleted uranium truck casks. The loss of shielding associated with streaming through the head of steel monolith rail casks is due to structural failure of the casks. The probability of this is estimated by taking the breach/rupture probability of a steel monolith transportation cask at the weakest location and applying it as a head rupture probability.

Collisions of casks will occur at less than 5 mph. Drops can occur as high as 30 feet. Drops may be at any orientation: side, bottom, and end. A conservative approach to estimation of the probability of SLS LOS is to use the information associated with end drops, which can cause bulging of the steel containment that allows the lead to collect towards one end. Although the corner impact can cause greater strain in the steel containment, it does not cause the spreading that increases collection of the lead at one end. All surfaces in the repository upon which a transportation cask can be dropped (concrete or soil) are concrete or softer. Therefore, the concrete related drop height vs. LOS information may be accurately used.

An impact of at least 123 mph against a real surface such as concrete or soil is required in order to cause the same damage as an impact of 30 mph against an unyielding surface (Table D3.3-2). The vast majority of casks are to be delivered to the repository by rail. The maximum strain due to an end impact of 30 mph against an unyielding surface, or 123 mph against a real surface, is about 3.9% for a truck cask (greater than the 1.9% strain for a rail cask) (Table D3.2-1). Noting in Figure D3.2-3 that the amount of strain is roughly linear with the impact velocity, a velocity of 63 mph is estimated to correspond to the strain of 2% indicative of S3 damage and lead slumping. A 63 mph collision, equivalent to a 133-foot drop, is the threshold for causing enough damage to indicate potential loss of shielding due to lead slumping.

In order to develop fragility over height, the available information described herein indicates that an estimate of a median threshold for a failure drop height is 133 feet. This would yield 2% strain. A coefficient variation (the ratio of standard deviation to the median) is 0.1. This is an estimate derived from the distribution of capacity associated with the tensile strength elongation data described in Section D1.1. The probability of LOS due to lead slumping resulting from a 15-foot vertical drop would be less than 1×10^{-8} , given the drop event. For a 30-foot drop resulting from a 2-blocking event, the computed failure probability based on the 133-foot median drop height is also less than 1×10^{-8} . LOS due to lead slumping applies only to those casks using lead for shielding but the PCSA applied this analysis to all casks. A conservative value of 1×10^{-5} is used to be consistent with the probabilities based on the LLNL (Ref. D4.1.27) results.

Results are shown in Tables D3.4-1.

Table D3.4-1. Probabilities of Degradation or Loss of Shielding

	Probability	Note
Sealed transportation cask and shielded transfer casks shielding degradation after structural challenge	1×10^{-5}	Section D3.4
Aging overpack shielding loss after structural challenge	5×10^{-6}	Section D3.4
CTM shielding loss after structural challenge	0	Structural challenge sufficiently mild to leave the shielding function intact ^a
WPTT shielding loss after structural challenge	0	Structural challenge sufficiently mild to leave the shielding function intact ^a
TEV shielding loss (shield end)	0	Structural challenge sufficiently mild to leave the shielding function intact ^a
Shielding loss by fire for waste forms in transportation casks or shielded transfer casks	1	Lead shielding could potentially expand and degrade. This probability is conservatively applied to transportation casks and STCs that do not use lead for shielding
Shielding loss by fire of aging overpacks, CTM shield bell, and WPTT shielding	0	Type of concrete used for aging overpacks is not sensitive to spallation; Uranium used in CTM shield bell and WPTT shielding does not lose its shielding function as a result of fire

NOTE: ^aIn the event sequence diagrams of the PCSA, the shielding function for the CTM, WPTT and TEV is queried for the challenges that do not lead to a radioactive release. Such challenges, which were not sufficiently severe to cause a breach of containment of the waste form container, are also deemed mild enough to leave the shielding function of the CTM, WPTT and TEV intact.

CTM = canister transfer machine; STC = shielded transfer cask; TEV=transport and emplacement vehicle; WPTT = waste package transfer trolley.

Source: Original

All Other Cask Types

For all other cask types, the results of the transportation cask study indicate that the only mechanism for LOS is streaming via closure failures and closure geometry changes. Therefore, the probability of LOS can be equated to the probability of rupture/breach of such casks.

D4 REFERENCES

D4.1 DESIGN INPUTS

The PCSA is based on a snapshot of the design. The reference design documents are appropriately documented as design inputs in this section. Since the safety analysis is based on a snapshot of the design, referencing subsequent revisions to the design documents (as described in EG-PRO-3DP-G04B-00037, *Calculations and Analyses* (Ref. 2.1.1, Section 3.2.2.F)) that implement PCSA requirements flowing from the safety analysis would not be appropriate for the purpose of the PCSA.

The inputs in this Section noted with an asterisk (*) indicate that they fall into one of the designated categories described in Section 4.1, relative to suitability for intended use.

- D4.1.1* Allegheny Ludlum 2006. "Technical Data Blue Sheet, Stainless Steels Chromium-Nickel-Molybdenum, Types 316 (S31600), 316L (S31603), 317 (S31700), 317L (S31703)." Technical Data Blue Sheet. [Brackenridge, Pennsylvania]: Allegheny Ludlum. TIC: 259471. LC Call Number: TA 486 .A4 2006.
- D4.1.2* A.M. Birk Engineering 2005. *Tank Car Thermal Protection Defect Assessment: Updated Thermal Modelling with Results of Fire Testing*. TP 14367E. Ontario, Canada: Transportation Development Centre of Transport Canada. ACC: MOL.20071113.0095.
- D4.1.3* ASM (American Society for Metals) 1961. "Properties and Selection of Metals." Volume 1 of *Metals Handbook*. 8th Edition. Lyman, T.; ed. Metals Park, Ohio: American Society for Metals. TIC: 257281. LC Call Number: TA459 .M43 1961 Vol.1.
- D4.1.4* ASM 1976. *Source Book on Stainless Steels*. Metals Park, Ohio: American Society for Metals. TIC: 259927. LC Call Number: TA479 .S7 S64 1976.
- D4.1.5* ASME (American Society of Mechanical Engineers) 2001. *2001 ASME Boiler and Pressure Vessel Code (includes 2002 addenda)*. New York, New York: American Society of Mechanical Engineers. TIC: 251425.
- D4.1.6* ASME 2004. *2004 ASME Boiler and Pressure Vessel Code*. 2004 Edition. New York, New York: American Society of Mechanical Engineers. TIC: 256479.
- D4.1.7* ASTM (American Society for Testing and Materials) G 1-03. 2003. *Standard Practice for Preparing, Cleaning, and Evaluating Corrosion Test Specimens*. West Conshohocken, Pennsylvania: American Society for Testing and Materials. TIC: 259413.
- D4.1.8* Avallone, E.A. and Baumeister, T., III, eds. 1987. *Marks' Standard Handbook for Mechanical Engineers*. 9th Edition. New York, New York: McGraw-Hill. TIC: 206891. ISBN: 0-07-004127-X.

- D4.1.9* BNFL Fuel Solutions 2003. *FuelSolutions™ TS125 Transportation Cask Safety Analysis Report, Revision 5*. Document No. WSNF-120. Docket No. 71-9276. Campbell, California: BNFL Fuel Solutions. TIC: 257634.
- D4.1.10 Not Used.
- D4.1.11 BSC 2006. *CRCF, IHF, RF, and WHF Canister Transfer Machine Mechanical Equipment Envelope*. 000-MJ0-HTC0-00201-000 REV 00A. Las Vegas, Nevada: Bechtel SAIC Company. ACC: ENG.20061120.0011.
- D4.1.12 BSC 2007. *Mechanical Handling Design Report: Waste Package Transport and Emplacement Vehicle*. 000-30R-HE00-00200-000 REV 001. Las Vegas, Nevada: Bechtel SAIC Company. ACC: ENG.20071205.0002.
- D4.1.13 BSC 2007. *5-DHLW/DOE SNF - Long Co-Disposal Waste Package Configuration*. 000-MW0-DS00-00203-000 REV 00C. Las Vegas, Nevada: Bechtel SAIC Company. ACC: ENG.20070719.0007.
- D4.1.14 BSC 2007. *Aging Facility Vertical DPC Aging Overpack Mechanical Equipment Envelope Sheet 1 of 2*. 170-MJ0-HAC0-00201-000 REV 00B. Las Vegas, Nevada: Bechtel SAIC Company. ACC: ENG.20070928.0032.
- D4.1.15 BSC 2007. *Basis of Design for the TAD Canister-Based Repository Design Concept*. 000-3DR-MGR0-00300-000-001. Las Vegas, Nevada: Bechtel SAIC Company. ACC: ENG.20071002.0042.
- D4.1.16* BSC 2007. *Discipline Design Guide and Standards for Surface Facilities HVAC Systems*. 000-3DG-GEHV-00100-000-00A. Las Vegas, Nevada: Bechtel SAIC Company. ACC: ENG.20070514.0007.
- D4.1.17 BSC 2007. *Leak Path Factors for Radionuclide Releases from Breached Confinement Barriers and Confinement Areas*. 000-00C-MGR0-01500-000-00A. Las Vegas, Nevada: Bechtel SAIC Company. ACC: ENG.20071018.0002.
- D4.1.18 BSC 2007. *Mechanical Handling Design Report - Site Transporter*. 170-30R-HAT0-00100-000-000. Las Vegas, Nevada: Bechtel SAIC Company. ACC: ENG.20071217.0015.
- D4.1.19 BSC 2007. *Naval Long Oblique Impact Inside TEV*. 000-00C-DNF0-01200-000-00A. Las Vegas, Nevada: Bechtel SAIC Company. ACC: ENG.20070806.0016.
- D4.1.20 BSC 2007. *Naval Long Waste Package Vertical Impact on Emplacement Pallet and Invert*. 000-00C-DNF0-00100-000-00C. Las Vegas, Nevada: Bechtel SAIC Company. ACC: ENG.20071017.0001.
- D4.1.21 BSC 2007. *Probabilistic Characterization of Preclosure Rockfalls in Emplacement Drifts*. 800-00C-MGR0-00300-000-00A. Las Vegas, Nevada: Bechtel SAIC Company. ACC: ENG.20070329.0009.

- D4.1.22 BSC 2007. *TAD Waste Package Configuration*. 000-MW0-DSC0-00101-000 REV 00B. Las Vegas, Nevada: Bechtel SAIC Company. ACC: ENG.20070301.0010.
- D4.1.23 BSC 2007. *TAD Waste Package Configuration*. 000-MW0-DSC0-00102-000 REV 00B. Las Vegas, Nevada: Bechtel SAIC Company. ACC: ENG.20070301.0011.
- D4.1.24 BSC 2007. *TAD Waste Package Configuration*. 000-MW0-DSC0-00103-000 REV 00B. Las Vegas, Nevada: Bechtel SAIC Company. ACC: ENG.20070301.0012.
- D4.1.25 BSC 2007. *Thermal Responses of TAD and 5-DHLW/DOE SNF Waste Packages to a Hypothetical Fire Accident*. 000-00C-WIS0-02900-000-00A. Las Vegas, Nevada: Bechtel SAIC Company. ACC: ENG.20070220.0008.
- D4.1.26 BSC 2007. *Waste Package Capability Analysis for Nonlithophysal Rock Impacts*. 000-00C-MGR0-04500-000-00A. Las Vegas, Nevada: Bechtel SAIC Company. ACC: ENG.20071113.0017.
- D4.1.27 BSC 2008. *Seismic and Structural Container Analyses for the PCSA*. 000-PSA-MGR0-02100-000-00A. Rev. 00A. Las Vegas, NV: Bechtel SAIC Company. ACC: ENG.20080220.0003.
- D4.1.28 DOE (U.S. Department of Energy) 2007. *Transportation, Aging and Disposal Canister System Performance Specification*. WMO-TADCS-000001, Rev. 0. Washington, D.C.: U.S. Department of Energy, Office of Civilian Radioactive Waste Management. ACC: DOC.20070614.0007. (DIRS 181403)
- D4.1.29 DOE 2007. *Quality Assurance Requirements and Description*. DOE/RW-0333P, Rev. 19. Washington, D. C.: U.S. Department of Energy, Office of Civilian Radioactive Waste Management. ACC: DOC.20070717.0006. (DIRS 182051)
- D4.1.30* English, G.W.; Moynihan, T.W.; Worswick, M.J.; Birk, A.M. 1999. *A Railroad Industry Critique of the Model Study*. 96-025-TSD. Kingston, Ontario, Canada: Association of American Railroads Safety & Operations. TIC: 260032. LC Call Number: TK9152.17 .T73 1999.
- D4.1.31* Evans, D.D. 1993. "Sprinkler Fire Suppression Algorithm for HAZARD." *Fire Research and Safety, 12th Joint Panel Meeting, October 27-November 2, 1992, Tsukuba, Japan*. Pages 114-120. Tsukuba, Japan: Building Research Institute and Fire Research Institute. ACC: MOL.20071114.0163.
- D4.1.32* Fischer, L.E.; Chou, C.K.; Gerhard, M.A.; Kimura, C.Y.; Martin, R.W.; Mensing, R.W.; Mount, M.E.; and Witte, M.C. 1987. *Shipping Container Response to Severe Highway and Railway Accident Conditions*. NUREG/CR-4829. Two volumes. Washington, D.C.: U.S. Nuclear Regulatory Commission. ACC: NNA.19900827.0230; NNA.19900827.0231.

- D4.1.33* Friedrich, T. and Schellhaas, H. 1998. *Computation of the percentage points and the power for the two-sided Kolmogorov-Smirnov one sample test*. Statistical Papers 39:361-75. TIC: 260013.
- D4.1.34* General Atomics. 1995. *GA-9 Legal Weight Truck From-Reactor Spent Fuel Shipping Cask, Final Design Report (FDR)*. 910354 N/C. San Diego, California: General Atomic. ACC: MOV.20000106.0003.
- D4.1.35* Haynes International 1990. Reliability and Longevity of Furnace Components as Influenced by Alloy of Construction. H-3124. Kokomo, Indiana: Haynes International. TIC: 256362.
- D4.1.36* Haynes International 1997. Hastelloy C-22 Alloy. Kokomo, Indiana: Haynes International. TIC: 238121.
- D4.1.37* Hertz, K.D. 2003. "Limits of Spalling of Fire-Exposed Concrete." *Fire Safety Journal*, 38, 103-116. [New York, New York]: Elsevier. TIC: 259993.
- D4.1.38* Holtec International 2003. *Storage, Transport, and Repository Cask Systems, (Hi-Star Cask System) Safety Analysis Report, 10 CFR 71, Docket 71-9261*. HI-951251, Rev. 10. [Marlton, New Jersey]: Holtec International. ACC: MOL.20050119.0271.
- D4.1.39* Holtec International 2005. *Final Safety Analysis Report for the HI-STORM 100 Cask System*. USNRC Docket No.: 72-1014. Holtec Report No.: HI-2002444. Marlton, New Jersey: Holtec International. TIC: 258829.
- D4.1.40* Hubbell, J.H. and Seltzer, S.M., *Tables of X-Ray Mass Attenuation Coefficients and Mass Energy-Absorption Coefficients* (version 1.4). National Institute of Standards and Technology, Gaithersburg, MD, 2004. (Originally published as NISTIR 5632, National Institute of Standards and Technology, Gaithersburg, MD, 1995) (Available online at: <http://physics.nist.gov/PhysRefData/XrayMassCoef/tab4.html>) ACC: MOL.20080303.0046.
- D4.1.41* Incropera, F.P. and DeWitt, D.P. 1996. *Introduction to Heat Transfer*. 3rd Edition. New York, New York: John Wiley and Sons. TIC: 241057. ISBN: 0-471-30458-1.
- D4.1.42 Not used.
- D4.1.43* Kodur, V.K.R.; Wang, T.C.; and Cheng, F.P. 2004. "Predicting the Fire Resistance Behaviour of High Strength Concrete Columns." *Cement & Concrete Composites*, 26, 141-153. [New York, New York]: Elsevier. TIC: 259996.
- D4.1.44* Larson, F.R. and Miller, J. 1952. "A Time-Temperature Relationship for Rupture and Creep Stresses." *Transactions of the American Society of Mechanical Engineers*, 74, 765-775. New York, New York: American Society of Mechanical Engineers. TIC: 259911.

- D4.1.45 Lide, D.R., ed. 1995. *CRC Handbook of Chemistry and Physics*. 76th Edition. Boca Raton, Florida: CRC Press. TIC: 216194. ISBN: 0-84930476-8.
- D4.1.46* Majumdar, S.; Shack, W.J.; Diercks, D.R.; Mruk, K.; Franklin, J.; and Knoblich, L. 1998. *Failure Behavior of Internally Pressurized Flawed and Unflawed Steam Generator Tubing at High Temperatures – Experiments and Comparisons with Model Predictions*. NUREG/CR-6575. Washington, D.C.: Nuclear Regulatory Commission. ACC: MOL.20071106.0053.
- D4.1.47* Mason, M. 2001. “NUHOMS-MP197 Transport Packaging Safety Analysis Report.” Letter from M. Mason (Transnuclear) to E.W. Brach (NRC), May 2, 2001, E-21135, with enclosures. TIC: 255258.
- D4.1.48* Morris Material Handling 2008. *Mechanical Handling Design Report - Canister Transfer Machine*. Morris Material Handling. V0-CY05-QHC4-00459-00018-001-004; ACC: ENG.20080121.0010.
- D4.1.49* NAC (Nuclear Assurance Corporation) 2000. *Safety Analysis Report for the NAC Legal Weight Truck Cask*. Revision 29. Docket No. 71-9225. T-88004. [Norcross, Georgia]: Nuclear Assurance Corporation International. ACC: MOL.20070927.0003.
- D4.1.50* NAC (Nuclear Assurance Corporation) 2004. "NAC-STC NAC Storage Transport Cask, Revision 15." Volume 1 of *Safety Analysis Report*. Docket No. 71-9235. Norcross, Georgia: NAC International. TIC: 257644.
- D4.1.51* Nakos, J.T. 2005. *Uncertainty Analysis of Steady State Incident Heat Flux Measurements in Hydrocarbon Fuel Fires*. SAND2005-7144. Albuquerque, New Mexico: Sandia National Laboratories. ACC: MOL.20071106.0054.
- D4.1.52* Nowlen, S.P. 1986. *Heat and Mass Release for Some Transient Fuel Source Fires: A Test Report*. NUREG/CR-4680. SAND86-0312. Washington, D.C.: U.S. Nuclear Regulatory Commission. ACC: MOL.20071113.0099.
- D4.1.53* Nowlen, S.P. 1987. *Quantitative Data on the Fire Behavior of Combustible Materials Found in Nuclear Power Plants: A Literature Review*. NUREG/CR-4679. SAND86-0311. Washington, D.C.: U.S. Nuclear Regulatory Commission. ACC: MOL.20071113.0100.
- D4.1.54* NRC (U.S. Nuclear Regulatory Commission) 1997. *Standard Review Plan for Dry Cask Storage Systems*. NUREG-1536. Washington, D.C.: U.S. Nuclear Regulatory Commission. ACC: MOL.20010724.0307.
- D4.1.55* NRC 2003. *Interim Staff Guidance - 18. The Design/Qualification of Final Closure Welds on Austenitic Stainless Steel Canisters as Confinement Boundary for Spent Fuel Storage and Containment Boundary for Spent Fuel Transportation*. ISG-18. Washington, D.C.: U.S. Nuclear Regulatory Commission. TIC: 254660.

- D4.1.56* NRC 2007. *Interim Staff Guidance HLWRS-ISG-02, Preclosure Safety Analysis - Level of Information and Reliability Estimation*. HLWRS-ISG-02. Washington, D.C.: U.S. Nuclear Regulatory Commission. ACC: MOL.20071018.0240.
- D4.1.57* Quintiere, J.G. 1998. *Principles of Fire Behavior*. Albany, New York: Delmar Publishers. TIC: 251255. ISBN: 0-8273-7732-0.
- D4.1.58* Rieth, M.; Falkenstein, A.; Graf, P.; Heger, S.; Jäntschi, U.; Klimiankou, M.; Materna-Morris, E.; and Zimmermann, H. 2004. *Creep of the Austenitic Steel AISI 316L(N), Experiments and Models*. FZKA 7065. Karlsruhe, Germany: Forschungszentrum Karlsruhe GmbH. TIC: 259943.
- D4.1.59* Sasikala, G.; Mathew, M.D.; Bhanu Sankara Rao, K.; and Mannan, S.L. 1997. "Assessment of Creep Behaviour of Austenitic Stainless Steel Welds." *Creep-Fatigue Damage Rules for Advanced Fast Reactor Design, Proceedings of a Technical Committee Meeting, Manchester, United Kingdom, 11-13 June 1996*. IAEA-TECDOC-993. Pages 219-227. Vienna, Austria: International Atomic Energy Agency. TIC: 259880.
- D4.1.60* Savolainen, K.; Mononen, J.; Ilola, R.; Hanninen, H. 2005. *Materials Selection for High Temperature Applications [TKK-MTR-4/05]*. TKK-MTR-4/05. Helsinki, Finland, Espoo, Finland: Helsinki University of Technology, Laboratory of Engineering Materials; Otamedia Oy. TIC: 259896. ISBN: 951-22-7892-8.
- D4.1.61* Society of Fire Protection Engineering (SFPE) 1988. *The SFPE Handbook of Fire Protection Engineering, Society of Fire Protection Engineers*. Edition 1. Boston, MA: Society of Fire Protection Engineering (SFPE). TIC: 101351. ISBN: 0-87765-353-4 .
- D4.1.62* Shapiro, S. S. and Wilk, M. B. 1965. "An analysis of variance test for normality (complete samples)", *Biometrika*, 52 (3 - 4), pages 591-611. TIC: 259992.
- D4.1.63* Siegel, R. and Howell, J.R. 1992. *Thermal Radiation Heat Transfer*. 3rd Edition. Washington, D.C.: Taylor & Francis. TIC: 236759. ISBN: 0-89116-271-2. (Radiation view factors also available online at: <http://www.me.utexas.edu/~howell/index.html>.)
- D4.1.64* Snow, S.D. 2007, *Structural Analysis Results of the DOE SNF Canisters Subjected to the 23-Foot Vertical Repository Drop Event to Support Probabilistic Risk Evaluations*, EDF-NSNF-085, Rev. 0. [Idaho Falls, Idaho: Idaho National Laboratory]. ACC: MOL.20080206.0062.
- D4.1.65* Sprung, J.L.; Ammerman, D.J.; Breivik, N.L.; Dukart, R.J.; Kanipe, F.L.; Koski, J.A.; Mills, G.S.; Neuhauser, K.S.; Radloff, H.D.; Weiner, R.F.; and Yoshimura, H.R. 2000. *Reexamination of Spent Fuel Shipment Risk Estimates*. NUREG/CR-6672. Two volumes. Washington, D.C.: U.S. Nuclear Regulatory Commission. ACC: MOL.20001010.0217.
- D4.1.66* Transnuclear 2001. *TN-68 Transport Packaging Safety Analysis Report, Revision 4*. Hawthorne, New York: Transnuclear. TIC: 254025.

D4.2 DESIGN CONSTRAINTS

D4.2.1 10 CFR 20. 2007. Energy: Standards for Protection Against Radiation. Internet Accessible

D4.2.2 10 CFR 71. 2007. Energy: Packaging and Transportation of Radioactive Material. ACC: MOL.20070829.0114.

ATTACHMENT E
HUMAN RELIABILITY ANALYSIS

CONTENTS

	Page
ACRONYMS AND ABBREVIATIONS	E-11
E1 INTRODUCTION	E-13
E1.1 SUMMARY	E-13
E2 SCOPE AND BOUNDARY CONDITIONS	E-16
E2.1 SCOPE	E-16
E2.2 BOUNDARY CONDITIONS	E-17
E3 METHODOLOGY	E-18
E3.1 METHODOLOGY BASES	E-18
E3.2 GENERAL APPROACH.....	E-18
E3.2.1 Step 1: Define the Scope of the Analysis.....	E-18
E3.2.2 Step 2: Describe Base Case Scenarios	E-19
E3.2.3 Step 3: Identify and Define HFEs of Concern	E-19
E3.2.3.1 Identifying Pre-initiator HFEs	E-20
E3.2.3.2 Identifying Human-Induced Initiator HFEs.....	E-20
E3.2.3.3 Identifying Non-recovery Post-initiator HFEs.....	E-20
E3.2.3.4 Identifying Recovery Post-initiator HFEs	E-21
E3.2.4 Step 4: Perform Preliminary Analysis and Identify HFEs for Detailed Analysis.....	E-21
E3.2.5 Step 5: Identify Potential Vulnerabilities.....	E-22
E3.2.6 Step 6: Search for HFE Scenarios.....	E-23
E3.2.7 Step 7: Quantify Probabilities of HFEs	E-23
E3.2.7.1 Qualitative Analysis.....	E-24
E3.2.7.2 Selection of Quantification Model.....	E-24
E3.2.7.3 Quantification	E-25
E3.2.7.4 Verification of Human Error Probabilities	E-26
E3.2.8 Step 8: Incorporate HFEs into PCSA.....	E-26
E3.2.9 Step 9: Evaluation of HRA/PCSA Results and Iteration with Design.....	E-27
E3.3 DEPENDENCY	E-27
E3.3.1 Capturing Dependency.....	E-27
E3.3.2 Sources of Dependency.....	E-28
E3.4 UNCERTAINTY	E-29
E3.5 DOCUMENTATION OF RESULTS	E-30
E4 INFORMATION COLLECTION AND USE OF EXPERT JUDGMENT	E-30
E4.1 FACILITY FAMILIARIZATION AND INFORMATION COLLECTION	E-30
E4.1.1 General Information Sources	E-30
E4.1.2 Industry Data Reviewed by the HRA Team	E-32
E4.2 USE OF EXPERTS AND ENGINEERING JUDGMENT IN THE HRA.....	E-33
E4.2.1 Role of HRA Team Judgment.....	E-33

CONTENTS (Continued)

	Page
E4.2.1.1 HRA Team	E-34
E4.2.2 Role of Subject Matter Expert Judgment.....	E-36
E5 TERMINOLOGY AND OVERVIEW OF HUMAN PERFORMANCE ISSUES	E-37
E5.1 TERMINOLOGY	E-37
E5.1.1 Classification of HFES	E-37
E5.1.1.1 Temporal Phases of HFES.....	E-38
E5.1.1.2 Error Modes	E-39
E5.1.1.3 Human Failure Type	E-39
E5.1.1.4 Informational Processing Failures	E-40
E5.1.2 Personnel Involved in CRCF Operations.....	E-40
E5.2 OVERVIEW OF HUMAN PERFORMANCE ISSUES	E-42
E6 ANALYSIS.....	E-43
E6.0 BACKGROUND	E-43
E6.0.1 Reader’s Guide to the HRA Analysis	E-43
E6.0.2 Topics Common to Multiple HFE Groups.....	E-47
E6.0.2.1 Interlocks.....	E-47
E6.0.2.2 Crane Drops—Drop of Cask or Drop of Object onto Cask	E-48
E6.0.2.3 Preliminary Analysis of Cross-Cutting HFES.....	E-48
E6.1 ANALYSIS OF HUMAN FAILURE EVENT GROUP #1: RECEIPT OF SPENT NUCLEAR FUEL IN THE TRANSPORTATION CASK VESTIBULE AND MOVEMENT INTO THE CASK PREPARATION ROOM	E-52
E6.1.1 Group #1 Base Case Scenario.....	E-52
E6.1.1.1 Initial Conditions and Design Considerations Affecting the Analysis.....	E-52
E6.1.1.2 Prejob Plan	E-53
E6.1.1.3 Receipt of Loaded Transportation Cask in the Transportation Cask Vestibule.....	E-53
E6.1.1.4 Movement of Loaded Transportation Cask into Cask Preparation Room	E-53
E6.1.1.5 MAP Movement over Conveyance.....	E-53
E6.1.2 HFE Descriptions and Preliminary Analysis	E-54
E6.1.3 Detailed Analysis	E-56
E6.2 ANALYSIS OF HUMAN FAILURE EVENT GROUP #2: CASK UPENDING AND REMOVAL FROM CONVEYANCE	E-57
E6.2.1 Group #2 Base Case Scenario.....	E-57
E6.2.1.1 Initial Conditions and Design Considerations Affecting the Analysis.....	E-57
E6.2.1.2 Removal and Storage of Personnel Barrier (if required)	E-59
E6.2.1.3 Cask Inspection	E-59
E6.2.1.4 Preparation of VTC for Transfer to the CTT	E-60
E6.2.1.5 Preparation of a TTC for Transfer to the CTT	E-62

CONTENTS (Continued)

	Page
E6.2.1.6 Cask Unbolting from Pivot Point and Movement to CTT (both Variations).....	E-67
E6.2.2 HFE Descriptions and Preliminary Analysis	E-68
E6.2.3 Detailed Analysis	E-71
E6.3 ANALYSIS OF HUMAN FAILURE EVENT GROUP #3: CASK PREPARATION AND MOVEMENT TO CASK UNLOADING ROOM	E-72
E6.3.1 Group #3 Base Case Scenario.....	E-72
E6.3.1.1 Initial Conditions and Design Considerations Affecting the Analysis.....	E-72
E6.3.1.2 Gas Sampling of Cask.....	E-73
E6.3.1.3 Removal of Transportation Cask Lid Bolts	E-74
E6.3.1.4 Attaching Transportation Cask Lid Lift Fixture to Cask Lid.....	E-74
E6.3.1.5 Other Preparation Activities (DPC Only).....	E-74
E6.3.1.6 Cask Transfer Via CTT to Cask Unloading Room (All Casks).....	E-76
E6.3.2 HFE Descriptions and Preliminary Analysis	E-76
E6.3.3 Detailed Analysis	E-80
E6.3.3.1 HFEs Requiring Detailed Analysis	E-81
E6.3.3.2 Assessment of Potential Vulnerabilities (Step 5).....	E-81
E6.3.3.3 HFE Scenarios and Expected Human Failures (Step 6)	E-83
E6.3.3.4 Quantitative Analysis (Step 7).....	E-84
E6.3.4 Results of Detailed HRA for HFE Group #3	E-91
E6.4 ANALYSIS OF HUMAN FAILURE EVENT GROUP #4: SITE TRANSPORTER RECEIPT AND MOVEMENT INTO CASK PREPARATION ROOM; AGING OVERPACK PREPARATION AND MOVEMENT TO THE CASK UNLOADING ROOM.....	E-92
E6.4.1 Group #4 Base Case Scenario.....	E-92
E6.4.1.1 Initial Conditions and Design Considerations Affecting the Analysis.....	E-92
E6.4.1.2 Prejob Plan	E-93
E6.4.1.3 Aging Overpack Receipt in Cask Preparation Room— Loaded Site Transporter Receipt in Site Transporter Vestibule	E-93
E6.4.1.4 Site Transporter Movement into Cask Preparation Room	E-93
E6.4.1.5 Cask Inspection.....	E-93
E6.4.1.6 Aging Overpack Lid Bolt Removal	E-94
E6.4.1.7 Aging Overpack/Site Transporter Movement into the Cask Unloading Room.....	E-94
E6.4.2 HFE Descriptions and Preliminary Analysis	E-94
E6.4.3 Detailed Analysis	E-98
E6.5 ANALYSIS OF HUMAN FAILURE EVENT GROUP #5: CTM ACTIVITIES: TRANSFER OF A CANISTER INTO OR OUT OF STORAGE,	

CONTENTS (Continued)

	Page
A TRANSPORTATION CASK, A WASTE PACKAGE, OR AN AGING OVERPACK WITH THE CTM.....	E-99
E6.5.1 Group #5 Base Case Scenario.....	E-100
E6.5.1.1 Initial Conditions and Design Considerations Affecting the Analysis.....	E-101
E6.5.1.2 Removal of Transportation Cask or Aging Overpack Lid with CTM (for TAD Canister or DOE SNF).....	E-105
E6.5.1.3 Move Canister to New Receptacle (All Variations).....	E-106
E6.5.1.4 Preparing Waste Package for Closure.....	E-107
E6.5.1.5 Preparing Aging Overpack to Leave Cask Unloading Room.....	E-108
E6.5.2 HFE Descriptions and Preliminary Analysis.....	E-108
E6.5.3 Detailed Analysis.....	E-114
E6.5.3.1 HFEs Requiring Detailed Analysis.....	E-115
E6.5.3.2 Assessment of Potential Vulnerabilities (Step 5).....	E-115
E6.5.3.3 HFE Scenarios and Expected Human Failures (Step 6).....	E-119
E6.5.3.4 Quantitative Analysis (Step 7).....	E-121
E6.5.4 Results of Detailed HRA for HFE Group #5.....	E-167
E6.6 ANALYSIS OF HUMAN FAILURE EVENT GROUP #6: WASTE PACKAGE ASSEMBLY AND CLOSURE.....	E-168
E6.6.1 Group #6 Base Case Scenario.....	E-168
E6.6.1.1 Initial Conditions and Design Considerations Affecting the Analysis.....	E-168
E6.6.1.2 WPTT Movement with Loaded Waste Package under the Waste Package Closure Room.....	E-169
E6.6.1.3 Closure Process Initiation (Loaded Waste Package with TAD Canister /HLW/SNF).....	E-169
E6.6.1.4 Waste Package Inner Lid Retrieval and Placement on Waste Package (Waste Package with TAD Canister Only).....	E-169
E6.6.1.5 Waste Package Welding.....	E-169
E6.6.2 HFE Descriptions and Preliminary Analysis.....	E-171
E6.6.3 Detailed Analysis.....	E-174
E6.6.3.1 HFEs Requiring Detailed Analysis.....	E-175
E6.6.3.2 Assessment of Potential Vulnerabilities (Step 5).....	E-175
E6.6.3.3 HFE Scenarios and Expected Human Failures (Step 6).....	E-177
E6.6.3.4 Quantitative Analysis (Step 7).....	E-177
E6.6.4 Results of Detailed HRA for HFE Group #6.....	E-181
E6.7 ANALYSIS OF HUMAN FAILURE EVENT GROUP #7: WASTE PACKAGE EXPORT.....	E-182
E6.7.1 Group #7 Base Case Scenario.....	E-182
E6.7.1.1 Initial Conditions and Design Considerations Affecting the Analysis.....	E-182

CONTENTS (Continued)

	Page
E6.7.1.2 Loaded Sealed Waste Package Movement to Waste Package Loadout Room and WPTT Docking Station Engagement.....	E-183
E6.7.1.3 Waste Package Shield Ring Removal and Shield Ring Movement to Waste Package Shield Ring Stand.....	E-183
E6.7.1.4 Horizontal Rotation of the WPTT.....	E-183
E6.7.1.5 Waste Package Inspection and Loading into TEV.....	E-183
E6.7.2 HFE Descriptions and Preliminary Analysis	E-184
E6.7.3 Detailed Analysis	E-187
E6.7.3.1 HFEs Requiring Detailed Analysis	E-188
E6.7.3.2 Assessment of Potential Vulnerabilities (Step 5).....	E-188
E6.7.3.3 HFE Scenarios and Expected Human Failures (Step 6)	E-191
E6.7.3.4 Quantitative Analysis (Step 7).....	E-192
E6.7.4 Results of Detailed HRA for HFE Group #7	E-200
E6.8 ANALYSIS OF HUMAN FAILURE EVENT GROUP #8: CLOSURE AND EXPORT OF AN AGING OVERPACK.....	E-202
E6.8.1 Group #8 Base Case Scenario.....	E-202
E6.8.1.1 Initial Conditions and Design Considerations Affecting the Analysis.....	E-202
E6.8.1.2 Aging Overpack Movement to Cask Preparation Room	E-203
E6.8.1.3 Aging Overpack Lid Bolt Installation.....	E-203
E6.8.1.4 Aging Overpack Inspection	E-203
E6.8.1.5 Aging Overpack Movement from Cask Preparation Room to Outside	E-203
E6.8.2 HFE Descriptions and Preliminary Analysis	E-204
E6.8.3 Detailed Analysis.....	E-207
E7 RESULTS: HUMAN RELIABILITY ANALYSIS DATABASE.....	E-208
E8 REFERENCES	E-213
E8.1 DESIGN INPUTS.....	E-213
E8.2 DESIGN CONSTRAINTS	E-216
APPENDIX E.I RECOMMENDED INCORPORATION OF HUMAN FAILURE EVENTS IN THE YMP PCSA.....	E-217
APPENDIX E.II GENERAL STRUCTURE OF POST-INITIATOR HUMAN ACTIONS	E-218
APPENDIX E.III PRELIMINARY (SCREENING) QUANTIFICATION PROCESS FOR HUMAN FAILURE EVENTS	E-219
APPENDIX E.IV SELECTION OF METHODS FOR DETAILED QUANTIFICATION.....	E-224
APPENDIX E.V HUMAN FAILURE EVENTS NAMING CONVENTION.....	E-229

FIGURES

	Page
E6.0-1. HFE Groups Associated with Facility Operations.....	E-44
E6.1-1. Activities Associated with HFE Group #1.....	E-52
E6.2-1. Activities Associated with HFE Group #2.....	E-57
E6.3-1. Activities Associated with HFE Group #3.....	E-72
E6.3-2. 060-OpDPCShield1-HFI-NOW Operator Failure Scenario.....	E-85
E6.4-1. Activities Associated with HFE Group #4.....	E-92
E6.5-1. Activities Associated with HFE Group #5.....	E-99
E6.5-2. CTM Operations Process Flow.....	E-100
E6.5-3. Canister Transfer Machine—Side View.....	E-104
E6.5-4. Canister Transfer Machine—End View.....	E-105
E6.6-1. Activities Associated with HFE Group #6.....	E-168
E6.7-1. Activities Associated with HFE Group #7.....	E-182
E6.7-2. Waste Package Positioning Room and Waste Package Loadout Room Conceptual Configuration.....	E-190
E6.8-1. Activities Associated with HFE Group #8.....	E-202
E.I-1. Incorporation of Human Reliability Analysis within the PCSA.....	E-217
E.II-1. Post Initiator Operator Action Event Tree.....	E-218
E.V-1. Basic Event Naming Convention.....	E-229

TABLES

	Page
E3.2-1. Human Performance Limiting Values	E-26
E3.3-1. Formulae for Addressing HFE Dependencies	E-28
E3.4-1. Lognormal Error Factor Values	E-29
E6.0-1. Correlation of HFE Groups to ESDs and HAZOP Evaluation (PFD) Nodes.....	E-45
E6.0-2. Summarizing Preliminary Values for the Cross-group Generic HFEs.....	E-51
E6.1-1. HFE Group #1 Descriptions and Preliminary Analysis.....	E-55
E6.2-1. HFE Group #2 Descriptions and Preliminary Analysis.....	E-69
E6.3-1. HFE Group #3 Descriptions and Preliminary Analysis.....	E-77
E6.3-2. Group #3 HFE Requiring Detailed Analysis	E-81
E6.3-3. HFE Scenarios and Expected Human Failures for HFE Group #3.....	E-83
E6.3-4. HEP Model for HFE Group #3 Scenario 1(a) for 060-OpDPCShield1-HFI- NOW	E-87
E6.3-5. HEP Model for HFE Group #3 Scenario 1(b) for 060-OpDPCShield1-HFI- NOW	E-90
E6.3-6. Summary of HFE Detailed Analysis for HFE Group #3	E-91
E6.4-1. HFE Group #4 Descriptions and Preliminary Analysis.....	E-95
E6.5-1. HFE Group #5 Descriptions and Preliminary Analysis.....	E-109
E6.5-2. Group #5 HFEs Requiring Detailed Analysis.....	E-115
E6.5-3. HFE Scenarios and Expected Human Failures for HFE Group #5.....	E-119
E6.5-4. HEP Model for HFE Group #5 Scenario 1(a) for 060-OpCTMdrop001-HFI- COD	E-126
E6.5-5. HEP Model for HFE Group #5 Scenario 1(b) for 060-OpCTMdrop001-HFI- COD	E-129
E6.5-6. HEP Model for HFE Group #5 Scenario 1(c) for 060-OpCTMdrop001-HFI- COD	E-133
E6.5-7. HEP Model for HFE Group #5 Scenario 1(d) for 060-OpCTMdrop001-HFI- COD	E-136
E6.5-8. HEP Model for HFE Group #5 Scenario 1(e) for 060-OpCTMdrop001-HFI- COD	E-138
E6.5-9. HEP Model for HFE Group #5 Scenario 2(a) for 060-OpCTMdrop002-HFI- COD	E-142

TABLES (Continued)

	Page
E6.5-10. HEP Model for HFE Group #5 Scenario 2(b) for 060-OpCTMdrop002-HFI-COD	E-144
E6.5-11. HEP Model for HFE Group #5 Scenario 2(c) for 060-OpCTMdrop002-HFI-COD	E-148
E6.5-12. HEP Model for HFE Group #5 Scenario 3(a) for 060-OpCTMImpact1-HFI-COD	E-152
E6.5-13. HEP Model for HFE Group #5 Scenario 3(b) for 060-OpCTMImpact1-HFI-COD	E-156
E6.5-14. HEP Model for HFE Group #5 Scenario 3(c) for 060-OpCTMImpact1-HFI-COD	E-159
E6.5-15. HEP Model for HFE Group #5 Scenario 3(d) for 060-OpCTMImpact1-HFI-COD	E-161
E6.5-16. HEP Model for HFE Group #5 Scenario 4(a) for 060-OPCTMDirExp1-HFI-NOD	E-164
E6.5-17. HEP Model for HFE Group #5 Scenario 5(a) for 060-OPStageRack1-HFI-NOD	E-167
E6.5-18. Summary of HFE Detailed Analysis for HFE Group #5	E-167
E6.6-1. HFE Group #6 Descriptions and Preliminary Analysis	E-172
E6.6-2. Group #6 HFE Requiring Detailed Analysis	E-175
E6.6-3. HFE Scenarios and Expected Human Failures for HFE Group #6	E-177
E6.6-4. HEP Model for HFE Group #6 Scenario 1(a) for 060-OPWPInnerLid-HFI-NOD	E-180
E6.6-5. Summary of HFE Detailed Analysis for HFE Group #6	E-181
E6.7-1. HFE Group #7 Descriptions and Preliminary Analysis	E-185
E6.7-2. Group #7 HFE Requiring Detailed Analysis	E-188
E6.7-3. HFE Scenarios and Expected Human Failures for Group #7	E-192
E6.7-4. HEP Model for HFE Group #7 Scenario 1(a) for 060-OpDirExpose3-HFI-NOD	E-196
E6.7-5. HEP Model for HFE Group #7 Scenario 1(b) for 060-OpDirExpose3-HFI-NOD	E-199
E6.7-6. HEP Model for Group #7 Scenario 1(c) for 060-OpDirExpose3-HFI-NOD	E-200
E6.7-7. Summary of HFE Detailed Analysis for HFE Group #7	E-201
E6.8-1. HFE Group #8 Descriptions and Preliminary Analysis	E-205

TABLES (Continued)

	Page
E.7-1. HFE Data Summary	E-208
E.III-1. Examples of Information Useful to HFE Quantification	E-219
E.III-2. Types of HFEs	E-222
E.IV-1. Comparison between NPP and YMP Operations	E-225
E.V-1. Human Failure Event Type Codes and Failure Mode Codes	E-230

ACRONYMS AND ABBREVIATIONS

Acronyms

APOA	assessed proportion of affect
ASD	adjustable speed drive
ASEP	Accident Sequence Evaluation Program
ASME	American Society of Mechanical Engineers
ATHEANA	A Technique for Human Event Analysis
BSC	Bechtel SAIC Company, LLC
CBDT	Cause-Based Decision Tree
CFE	cognitive function failure
CPC	common performance condition
CRCF	Canister Receipt and Closure Facility
CREAM	Cognitive Reliability and Error Analysis Method
CTM	canister transfer machine
CTT	cask transfer trolley
DOE	U.S. Department of Energy
EFC	error forcing context
EOC	error of commission
EOO	error of omission
EPC	error-producing condition
EPRI	Electric Power Research Institute
ESD	event sequence diagram
GTT	generic task type
HAZOP	hazard and operability
HCR	Human Cognitive Reliability
HEART	Human Error Assessment and Reduction Technique
HEP	human error probability
HFE	human failure event
HLW	high-level radioactive waste
HRA	human reliability analysis
HVAC	heating, ventilation, and air-conditioning
INPO	Institute of Nuclear Power Operations
ISFSI	independent spent fuel storage installation
ITS	important to safety
LIS	Licensing Information Service
MLD	master logic diagram

ACRONYMS AND ABBREVIATIONS (Continued)

MAP	mobile access platform
MAUD	Multi-Attribute Utility Decomposition
MERMOS	Methode d'Evaluation de la Relisation des Missions Operateur pour la Surete
NARA	Nuclear Action Reliability Assessment
NASA	National Aeronautics and Space Administration
NDE	nondestructive examination
NPP	nuclear power plant
NRC	U.S. Nuclear Regulatory Commission
ORE	Operator Reliability Experiments
PCSA	preclosure safety analysis
PFD	process flow diagram
PIC	person in charge
PLC	programmable logic controller
PRA	probabilistic risk assessment
PSF	performance-shaping factor
RHS	remote handling system
SHARP	Systematic Human Action Reliability Procedure
SLIM	Success Likelihood Index Method
SPAR-H	Standardized Plant Analysis Risk Human Reliability Analysis
SPM	site prime mover
SSCs	structures, systems, and components
TEV	transport and emplacement vehicle
THERP	Technique for Human Error Rate Prediction
TRC	Time-Reliability Correlation
UT/ET	ultrasonic testing/eddy current testing
WPTT	waste package transfer trolley
YMP	Yucca Mountain Project

Abbreviations

in. inch

E1 INTRODUCTION

This document describes the work scope, definitions, terms, methods, and analysis for the human reliability analysis (HRA) task of the Yucca Mountain Project (YMP) preclosure safety analysis (PCSA) reliability assessment.

The HRA task identifies, models, and quantifies human failure events (HFEs) postulated in the PCSA to assess the impact of human actions on event sequences modeled in the PCSA. The HFEs evaluated and quantified by this task are identified during the following activities:

- Initiating event identification and grouping
- Event sequence development and categorization
- System analysis
- Sequence quantification and uncertainty analysis.

The HRA task ensures that the HFEs identified by the other tasks (e.g., hazard and operability (HAZOP) evaluation, event sequence diagram (ESD) development, event tree analysis, fault tree analysis) are quantified with HRA techniques. The ESD finding is that the human-induced initiating events dominate the HRA. No post-initiator human actions have been credited in this analysis. The HRA task also ensures that modeled HFEs are appropriately incorporated into the PCSA and provides appropriate human error probabilities (HEPs) for all modeled HFEs. It is important to note that YMP operations differ from those of traditional nuclear power plants (NPPs), and the HRA analysis reflects these differences; Appendix E.IV of this analysis provides further discussion on these differences and how they influenced the choice of methodology.

E1.1 SUMMARY

The HRA was carried out using a nine-step process that is derived from A Technique for Human Event Analysis (ATHEANA) (Ref. E8.1.22):

1. Define the scope of the analysis.
2. Describe the base case progression of actions and responses that constitute successful completion of the operations being evaluated (base case scenarios).
3. Identify and define HFEs of concern.
4. Perform preliminary (screening) analysis and identify HFEs requiring detailed analysis.
5. Identify potential vulnerabilities for the HFEs requiring detailed analysis.
6. Search for HFE scenarios (i.e., scenarios of concern).
7. Quantify probabilities of HFEs.

8. Incorporate HFEs into the PCSA.
9. Evaluate HRA/PCSA results and iterate with design.

After the scope was defined, the facility operations were split into logical groups that relate to the various phases of the Canister Receipt and Closure Facility (CRCF) operations. For each of these operational phase groups, a base case scenario was defined that describes in detail the normal operations for that group. Once the operations were defined and the base cases were documented, HFEs were identified through an iterative process whereby the human reliability analysts, in conjunction other PCSA analysts and Engineering and Operations personnel, met and discussed the design and operations in order to appropriately model the human interface. This process consisted of the HAZOP evaluation, master logic diagram (MLD) and event sequence development, fault tree and event tree modeling, and it culminated in the preliminary analysis and incorporation of HFEs into the model. The iteration with the event sequence and system reliability analysis also identified HFEs of potential concern. HFEs identified include both errors of omission (EOOs) and errors of commission (EOCs).

Included in this process was an extensive information collection process where the human reliability analysts reviewed industry data and interviewed subject matter experts to identify potential vulnerabilities and HFE scenarios.

The result of this identification process was a list of HFEs and a description of each HFE scenario, including system and equipment conditions and any resident or triggered human factor concerns (e.g., performance-shaping factors (PSFs)). This combination of conditions and human factor concerns then became the error forcing context (EFC) for a specific HFE. Additions and refinements to these initial EFCs were made during the preliminary and detailed analyses.

A preliminary, or screening-type, analysis was then performed to preserve HRA resources so that detailed analyses can be focused on only the most risk-significant HFEs. The preliminary analysis included verification of the validity of HFEs included in the initial PCSA model, assignment of a conservative screening value (mean value) to each HFE, and verification of preliminary values. The actual quantification of preliminary values was a six-step process that is described in detail in Appendix E.III of this analysis. Once the preliminary values were assigned, the PCSA model was quantified (initial quantification), and HFEs were identified for detailed analysis if: (1) the HFE was a risk-driver for a dominant sequence, and (2) using the preliminary values, that event sequence was above Category 1 or 2 according to the 10 CFR Part 63 (Ref. E8.2.1) performance objectives. The remaining HFEs retained their preliminary values. While most of the activities associated with preliminary analysis were time-consuming, extra care was taken to perform these tasks conscientiously since the results of the initial quantification were used to identify which HFEs require detailed analysis.

Although many of the HFEs are modeled in a simplified form in the event trees and fault trees for the preliminary analysis, each action is separated as much as possible for the detailed analysis. This separation is done to ensure that the detailed analysis is thorough and that the relationship between the system functionality and operations crew is transparent. First an HFE is broken down into the various scenarios that lead to the failure. Then, each scenario is further broken down into specific required actions and their applicable procedures, along with the

systems and components that must be operated during performance of each action. Each action in each scenario has its own unique context, dependencies, and set of PSFs, and each was thus quantified independently. The failure probabilities for these unsafe actions were quantified by the HRA method appropriate to the HFE, its classification (e.g., EOC, EOO, observation error, execution error), and the context. The HRA methods used in this analysis include the Technique for Human Error Prediction (THERP) (Ref. E8.1.26), Human Error Assessment and Reduction Technique (HEART) (Ref. E8.1.28), Nuclear Action Reliability Assessment (NARA) (Ref. E8.1.11), Cognitive Reliability and Error Analysis Method (CREAM) (Ref. E8.1.18), and the expert elicitation process from ATHEANA (Ref. E8.1.22).

As described in Appendix E.IV of this analysis, no single HEP quantification method is suitable for all HFEs identified in the event sequence quantification. For example, there are unsafe actions within the YMP HFEs that would best fit the HEART (Ref. E8.1.28)/NARA (Ref. E8.1.11) approach and others that would best fit the CREAM (Ref. E8.1.18) approach. The documentation of each HFE subjected to a detailed analysis defines the method used and the basis for its use.

After estimates for HFE probabilities were generated, these results were reviewed by the HRA team and, in some cases, by knowledgeable operations personnel as a “sanity check.” Principally, such checks were used, for example, to compare the probabilities of different HFEs and determine whether or not these probabilities were reasonable. A review of this type was particularly important for HFE probabilities that were generated using data from the THERP method (Ref. E8.1.26) because THERP does not account for PSFs in a standard formulaic way. In addition, the HFE probability estimates were reviewed to ensure that they did not exceed the lower limit of credible human performance as defined by NARA (Ref. E8.1.11).

For the preliminary analysis, HFEs were modeled at a high level in order to reduce dependencies that arise from modeling detailed actions. For a detailed assessment, where the various actions that constitute an HFE were explicitly quantified, dependencies were also explicitly addressed using the method described in THERP (Ref. E8.1.26), which is adopted by NARA (Ref. E8.1.11)

HFE probabilities produced in this analysis are mean values with associated error factors. Uncertainties in both the preliminary and detailed HEP quantification were accounted for by assigning a lognormal distribution and applying an error factor of 3, 5, or 10 to the distribution, depending on the mean value of the final HEP.

Because the YMP design and operations were still evolving during the course of this analysis, they could be changed in response to the analysis. This iteration was particularly necessary when an event sequence proved to be noncompliant with the performance objectives of 10 CFR Part 63 (Ref. E8.2.1) because the probability of a given HFE dominated the probability of that event sequence. In those cases, a design feature or procedural control was added to reduce the probability or completely eliminate the HFE, and the scenario was reanalyzed for human failures.

To guide the reader through the analysis, Section E6.0.1 explains how the HRA write-up is structured and how it interfaces with other parts of the PCSA, including a simplified diagram of

the facility operations (which defines analysis sections) and a map that links this analysis back to the MLD, the event sequence diagram (ESD), and the HAZOP evaluation.

E2 SCOPE AND BOUNDARY CONDITIONS

E2.1 SCOPE

The scope of the HRA is established in order to focus the analysis on the issues pertinent to the goals of the overall PCSA. Thus, the scope is as follows:

1. HFEs are only considered if they contribute to a scenario that has the potential to result in a release of radioactivity, a criticality event, or a radiation exposure to workers.
2. Pursuant to the above, the following types of HFEs are excluded:
 - A. HFEs resulting in standard industrial injuries (e.g., falls)
 - B. HFEs resulting in the release of hazardous nonradioactive materials, regardless of amount
 - C. HFEs resulting solely in delays to or losses of process availability, capacity, or efficiency.
3. The identification of HFEs is restricted to those areas of the facility that handle waste forms and only during the times that waste forms are being handled (e.g., HFEs are not identified for the Cask Preparation Room during the export of empty transportation casks).
4. The exception to #3 is that system-level HFEs are considered for support systems when those HFEs could result in a loss of a safety function related to the occurrence or consequences associated with the events specified in #1.
5. Recovery post-initiator actions (as defined in Section E5.1.1.1) are not credited in the analysis; therefore, HFEs associated with them are not considered.
6. In accordance with Section 4.3.10.1 (boundary conditions of the PCSA), initiating events associated with conditions introduced in structures, systems, and components (SSCs) before they reach the site are not, by definition of 10 CFR 63.2 (Ref. E8.2.1), within the scope of the PCSA nor, by extension, within the scope of the HRA.

E2.2 BOUNDARY CONDITIONS

Unless specifically stated otherwise, the following general conditions and limitations are applied throughout the HRA task. The first two conditions always apply. The remaining conditions apply unless the HRA analyst determines that they are inappropriate. This judgment is made for each individual action considered:

- Only HFEs made in the performance of assigned tasks are considered. Malevolent behavior (i.e., deliberate acts of sabotage and the like) are not considered in this task.
- All facility personnel act in a manner they believe to be in the best interests of operation and safety. Any intentional deviation from standard operating procedures is made because employees believe their actions to be more efficient or because they believe the action as stated in the procedure to be unnecessary.
- Since the YMP is currently in the design phase, facility-specific information and operating experience is generally not available. Instead, similar operations involving similar hazards and equipment are reviewed to establish surrogate operating experience to use in the qualitative analysis. Examples of reviewed information would include spent nuclear fuel (SNF) handling at reactor sites having independent spent fuel storage installations (ISFSIs), chemical munitions handling at U.S. Army chemical demilitarization facilities, and any other facilities whose primary function includes handling and disposal of very large containers of extremely hazardous material. Equipment design and operational characteristics at the geologic repository operations area facilities, once they are built and operating (including crew structures, training, and interactions), are adequately represented by these currently operating facilities.
- The facility is initially operating under normal conditions and is designed to the highest quality human factors specifications. The level of operator stress is optimal unless otherwise noted in the analysis.
- In performing the operations, the operator does not need to wear protective clothing unless the operation is similar to those performed in other comparable facilities where protective clothing is required.
- The tasks are performed by qualified personnel, such as operators, maintenance workers, or technicians. All personnel are certified in accordance with the training and certification program stipulated in the license. They are experienced and have functioned in their present positions for a sufficient amount of time to be proficient.
- The environment in the facility is not adverse. The levels of illumination and sound and the provisions for physical comfort are optimal. Judgment is required to determine what constitutes optimal environmental conditions. The analyst makes this determination and documents, as part of the assessment of performance influencing factors, when there is a belief that the action is likely to take place in a suboptimal environment.

- Personnel involved with the facility operations are expected to have the proper training commensurate with nuclear industry standards. As appropriate, this training is followed by a period of observation until the operator is proficient.
- While all personnel are trained to procedures, and procedures exist for all work required, the direct presence and use of procedures (including checklists) during operation is generally restricted to actions performed in the control room. Workers performing skill-of-craft operations do not carry written procedures on their person while performing their activities.

These factors are evaluated qualitatively for each situation being analyzed.

E3 METHODOLOGY

E3.1 METHODOLOGY BASES

The HRA task is performed in a manner that implements the intent of the high-level requirements for HRA in the American Society of Mechanical Engineers (ASME RA-S-2002 *Standard for Probabilistic Risk Assessment for Nuclear Power Plant Applications* (Ref. E8.1.4) and incorporates the guidance provided by the U.S. Nuclear Regulatory Commission (NRC) in *Preclosure Safety Analysis – Human Reliability Analysis* (Ref. E8.1.23).

E3.2 GENERAL APPROACH

The HRA consists of several steps, that follow the intent of ASME RA-S-2002 (Ref. E8.1.4) and the process guidance provided in *Technical Basis and Implementation Guidelines for a Technique for Human Event Analysis (ATHEANA)*, NUREG-1624 (Ref. E8.1.22). Detailed descriptions of each HRA step are provided in the following subsections to summarize the processes used by the analysts. The step descriptions are based on the ATHEANA documentation, with some passages taken essentially verbatim and others paraphrased to adapt the material based on NPPs to the YMP facilities. Additional information is available in the ATHEANA documentation (Ref. E8.1.22). Further discussion on information collection and use of expert judgment in this process can be found in Section E4.

HFE probabilities produced in this analysis are mean values. The HEPs are modeled as a lognormal distribution, where the error factors are defined based on the method presented in Section E3.4.

E3.2.1 Step 1: Define the Scope of the Analysis

The objective of the YMP HRA is to provide a comprehensive quantitative assessment of the HFES that can contribute to the facility's event sequences resulting in radiological release, criticality, or direct exposure. Any aspects of the work that provide a basis for bounding the analysis are identified in this step. In the case of the YMP, the scope is bounded by the design state of the facilities and equipment.

E3.2.2 Step 2: Describe Base Case Scenarios

In this step, the base case scenarios are defined and characterized for the operations being evaluated. In general, there is one base case scenario for each operation included in the model. The base case scenario:

- Represents the most realistic description of expected facility, equipment, and operator behavior for the selected operation.
- Provides a basis from which to identify and define deviations from such expectations (Step 6).

In the ideal situation (which is seldom achieved), the base case scenario:

- Has a consensus operator model¹
- Is well-defined operationally
- Has well-defined physics
- Is well-documented in public or proprietary references
- Is realistic.

Since operators and “as built, as operated” information are not currently available for YMP, this information is sought from comparable facilities with comparable operations. Documented reference analyses (e.g., engineering analyses) can assist in defining the scenario from the standpoint of physics and operations. The reference analyses may need to be modified to be more realistic. Expert judgment, engineering documents and applicable industry experience are the keys to defining realistic base case scenarios for YMP operations; Section E4 provides greater detail on how information was collected and the role of subject matter experts in this process.

E3.2.3 Step 3: Identify and Define HFEs of Concern

Possible HFEs and/or unsafe actions (i.e., actions inappropriately taken, or actions not taken when needed) that result in a degraded state are generally identified and defined in this step. After HFEs are identified they must be classified to support subsequent steps in the process. The classification process is described further in Section E5.1.1. The analyses performed in later steps (i.e., Steps 4 through 7) may identify the need to define an HFE or unsafe action not previously identified in Step 3.

Human errors were identified based upon the three temporal parts generally analyzed by probabilistic risk assessment (PRA) and are categorized as follows:

- Pre-initiator HFEs
- Human-induced initiator HFEs

¹ATHEANA (Ref. E8.1.22), Section 9.3.1 defines a consensus operator model in the following manner: “Operators develop mental models of plant responses to various PRA initiating events through training and experience. If a scenario is well defined and consistently understood among all operators (i.e., there is a consensus among the operators), then there is a consensus operator model.”

- Post-initiator HFEs²:
 - Non-recovery
 - Recovery.

Each of these types of HFEs is defined in Section E5.1.1.1; identification of the HFEs for each temporal phase is described in the following sections.

The result of this identification process is a list of HFEs and a description of each HFE scenario, including system and equipment conditions and any resident or triggered human factor concerns (e.g., PSFs). This combination of conditions and human factor concerns then becomes the EFC for a specific HFE. Additions to and refinements of these initial EFCs are made during the preliminary and detailed analyses.

E3.2.3.1 Identifying Pre-initiator HFEs

Pre-initiators are identified by the system analysts when modeling fault trees, while performing the system analysis task. Special attention is paid to the possibility that an error can be repeated in similar redundant components or trains, leading to a human common-cause failure.

E3.2.3.2 Identifying Human-Induced Initiator HFEs

Human-induced initiator HFEs are identified through an iterative process whereby the human reliability analysts, in conjunction with other PCSA analysts and engineering and operations personnel, meet and discuss the design and operations of the facility and SSCs in order to appropriately model the human interface. This iterative process begins with the HAZOP evaluation and MLD development, described and documented in *Canister Receipt and Closure Facility Event Sequence Development Analysis* (Ref. E8.1.10), followed by a second iteration during the initial fault tree and event tree modeling, and ending with a third iteration through the preliminary analysis and incorporation of HFEs into the model. Included in this process is an extensive information collection process where industry data was reviewed (Section E4.1) and subject matter experts were interviewed (Section E4.2) to identify potential vulnerabilities and HFE scenarios. HFEs identified include both EOOs and EOCs.

E3.2.3.3 Identifying Non-recovery Post-initiator HFEs

Non-recovery post-initiator HFEs are identified by examining the human contribution to pivotal events in the event tree analysis. The event sequence analysts, with support from the human reliability analysts, identify HFEs that represent the operator's failure to perform the proper action to mitigate the initiating event and/or the unavailability of automatic mitigation functions as called for in the emergency operating procedures or in accordance with their emergency response training. This identification includes all actions required, whether in a control room or locally. Post-initiator EOCs and EOOs are also considered. It should be emphasized that this section presents the methodology that is used to identify non-recovery post-initiator events. However, as shown in Section E6, none of these types of errors have been identified for the

²Terminology common to NPPs refer to non-recovery post-initiator events as Type C events and recovery events as Type CR events.

CRCF event sequence and categorization analysis. During the qualitative evaluation, non-recovery post-initiator events were considered and ruled out because it was unnecessary to credit non-recovery actions to demonstrate compliance with the performance objectives stated in 10 CFR 63.111 (Ref. E8.2.1).

E3.2.3.4 Identifying Recovery Post-initiator HFEs

Recovery actions are of limited relevance to YMP operations and, for conservatism, were not credited in this analysis. Recovery post-initiator HFEs are outside the scope of this analysis (Section E2.1).

E3.2.4 Step 4: Perform Preliminary Analysis and Identify HFEs for Detailed Analysis

The preliminary analysis is a type of screening analysis used to identify HFEs of concern. A screening analysis is commonly performed in HRA to conserve resources and focus the effort on the subsequent detailed analysis of those HFEs that are involved in the important event sequences. Preliminary values are assigned for the probabilities of HFEs based upon predetermined characteristics of each HFE. This analysis involves the following steps:

- Verification of the validity of HFEs included in the initial PCSA model
- Assignment of conservative preliminary values to all HFEs included in the initial PCSA model
- Verification of assigned preliminary probabilities to all HFEs in the PCSA
- Quantification of the initial PCSA model using preliminary values (i.e., the “initial quantification”)
- Identification of HFEs for detailed analysis.

The human reliability analyst performs the first three of these steps with the assistance of the PCSA quantification task leader, who also performs the last two steps. While most of the activities associated with this preliminary analysis are time-consuming, it is important to perform these tasks conscientiously since the results of the initial quantification are used to identify those HFEs requiring detailed analysis.

Analysts must strike a balance between conservatism and too much conservatism. Using too conservative a value for an HEP can overemphasize the importance of an HFE in the sequence quantification, perhaps masking a significant component failure event. By contrast, using a less conservative preliminary HEP may lead to inappropriately screening out a potentially significant event sequence. Instead of the usual screening process used in PRA, where relatively high screening values of 1.0 or 0.1 for an HEP are often inserted in initial fault tree and event sequence quantification, the PCSA applies an intermediate process where conservative preliminary values are assigned based on the context and failure modes of the HFE. Appendix E.III of this analysis provides specific details on guidelines for preliminary quantification.

Depending on the results obtained with the preliminary quantification, the event sequence and human reliability analysts may conclude that the preliminary results are sufficient for event sequence quantification and that a detailed analysis would not provide a better basis for event sequence categorization or more insights into the human factors issue for a particular waste handling operation. The preliminary quantification process is based on a characterization of each human action with respect to complexity and operational context using a judgment-based approach consisting of the following subtasks:

1. Complete the initial conditions required for quantification.
2. Identify the key or driving factors of the scenario context.
3. Generalize the context by matching it with generic, contextually anchored rankings or ratings.
4. Discuss and justify the judgments made in subtask 3.
5. Refine HFEs, associated contexts, and assigned HEPs.
6. Determine final preliminary HEPs for each HFE and associated context. These HEPs are then entered into the PRA logic structure to see which HFEs call for more detailed evaluation. HFEs are identified for a detailed analysis if (1) the HFE is a risk-driver for a given sequence, and (2) using the preliminary values, that sequence falls in a category (i.e., a Category 1 or Category 2) such that it does not meet 10 CFR 63.111 performance objectives (Ref. E8.2.1).

Appendix E.III of this analysis defines and provides technical bases for the HEP preliminary values recommended to be used in the YMP PRA for different categories of HFEs, depending on the general HFE characteristics. Section E4.2 provides a list of experts used in this process.

E3.2.5 Step 5: Identify Potential Vulnerabilities

This information collection step defines the context for Step 6 in which scenarios that deviate from the base case are identified. In particular, analysts search for potential vulnerabilities in the operators' knowledge and information base for the initiating event or base case scenario(s) under study that might result in the HFEs and/or unsafe actions identified in Step 4. Potential traps³ inherent in the ways operators may respond to the initiating event or base case scenario are identified through the following:

- Investigation of potential vulnerabilities in operator expectations for the scenario
- Understanding of the base case scenario time line and any inherent difficulties associated with the required response

³A "trap" is a human failure that is encouraged or enabled by the existence of a specific vulnerability. That is, vulnerabilities influence operators to fall into particular traps.

- Identification of operator action tendencies and informal rules
- Evaluation of formal rules and operating procedures expected to be used in the scenario.

The knowledge and information base is taken in the context of the specific HFE being evaluated. It includes not only the internal state of knowledge of the operator (i.e., what the operator inherently knows), but also the state of the information provided (e.g., available instrumentation, plant equipment status). Section E4 provides a description of the information types that comprise this knowledge base.

E3.2.6 Step 6: Search for HFE Scenarios

In this step, the analyst must identify deviations from the base case scenario that are likely to result in risk-significant unsafe action(s). These deviations are referred to as HFE scenarios. In serious accidents, these HFE scenarios are usually combinations of various types of unexpected conditions (which form the EFC).

The principal method for identifying HFE scenarios is a HAZOP evaluation-like search scheme, coupled with a means for relating scenario characteristics with error mechanisms for each stage in the information processing model (Ref. E8.1.1). The result of such a search is a description of the HFE scenarios, including system and equipment conditions, along with any resident or triggered human factor concerns (e.g., PSFs). Again, this combination of conditions and human factor concerns then becomes the EFC for a specific HFE. As defined by the ATHEANA document (Ref. E8.1.22), an EFC is the situation that arises when particular combinations of PSFs and plant conditions create an environment in which unsafe actions are more likely to occur. (Additions and refinements to this initial EFC are likely in later steps of the process).

E3.2.7 Step 7: Quantify Probabilities of HFEs

Detailed HRA quantification is performed for those HFEs that appear in dominant cut sets for event sequences that do not comply with 10 CFR 63.111 performance objectives (Ref. E8.2.1) after initial fault tree or event sequence quantification. The goal of the detailed analysis is to determine whether or not the preliminary HFE quantification is too conservative such that event sequences can be brought into compliance by a more realistic HRA. However, the detailed analysis may result in a requirement for additional design features or specification of a procedural control (Step 9, Section E3.2.9) that reduces the likelihood of a given HFE in order to achieve compliance with 10 CFR 63.111 (Ref. E8.2.1) performance objectives. The qualitative analysis in steps 3, 5, and 6 sets the stage for the detailed quantification by providing the accident progression(s) for a given HFE and its context. Specifically, the qualitative analysis provides a list of unsafe actions, along with their context, characteristics, and classification (i.e., EOO or EOC). For each unsafe action, the following steps are performed:

1. Qualitative analysis (e.g., identification of PSFs, definitions of important characteristics of the given unsafe action, assessment of dependencies)
2. Selection of a quantification model

3. Quantification

4. Verification that HFE probabilities are appropriately updated in the PCSA database.

The detailed quantification process relies on expert judgment to choose the most applicable HRA method or failure mode and identify the relevant PSFs. Section E4.2 provides detail on the experts used in this process and their qualifications.

E3.2.7.1 Qualitative Analysis

Before a given HFE can be quantified, a qualitative HRA analysis must be performed to fully describe each unsafe action for an HFE and to capture the dependencies between the unsafe actions. Much of this information was gathered in steps 3, 5, and 6 and is applied here. Qualitative analyses are also used to validate HRA approximations and required procedural controls, if any, for each HFE and associated event sequence to:

- Ensure that the general flow of the operator's response to dominant sequences is clearly understood from other information sources
- Confirm that the HFEs identified in the PRA models make sense relative to the actual experience and operating practice
- Identify potential influences or difficulties in implementing the procedures and making the decisions required in each event sequence
- Confirm that the cues for operator action are as identified in the HRA
- Qualitatively assess PSFs and other influences that might affect the reliability of responses.

E3.2.7.2 Selection of Quantification Model

Based on the characteristics and context of the unsafe action, expert judgment is used to pick the most applicable failure mode from the appropriate HRA method. There are four HRA methods that have been selected for this quantification:

1. CREAM (Basic and Extended)—*Cognitive Reliability and Error Analysis Method, CREAM* (Ref. E8.1.18)⁴
2. HEART/NARA—"HEART - A Proposed Method for Assessing and Reducing Human Error" (Ref. E8.1.28)/*A User Manual for the Nuclear Action Reliability Assessment (NARA) Human Error Quantification Technique* (Ref. E8.1.11)

⁴Extended CREAM (Ref. E8.1.18) creates a link between CREAM and HEART (Ref. E8.1.28), and enhances the ability of CREAM to quantify skill-based HFEs.

3. THERP (with some modifications)—*Handbook of Human Reliability Analysis with Emphasis on Nuclear Power Plant Applications Final Report*, NUREG/CR-1278 (Ref. E8.1.26).

When an applicable failure mode cannot be reasonably found in one of the above methods, then the following HRA method is used:

4. ATHEANA's expert elicitation approach—*Technical Basis and Implementation Guidelines for a Technique for Human Event Analysis (ATHEANA)*, NUREG-1624 (Ref. E8.1.22).

The selection of a specific quantification method for the failure probability of an unsafe action(s) is based upon the characteristics of the HFE quantified. The characteristics considered in the selection of the quantification method for each HFE include those discussed in Section E5.1.1.

Appendix E.IV of this analysis provides a discussion why these specific methods were selected for quantification, as well as a discussion of why some methods, deemed appropriate for HRA of NPPs, are not suitable for application in the PCSA. This discussion summarizes the main differences between NPPs and repository operations with respect to contexts and failure modes that affect potential HFEs. It also gives some background about when a given method is applicable based on the focus and characteristic of the method.

E3.2.7.3 Quantification

When the information collected is sufficient to allow the human reliability analyst to estimate the input parameters (i.e., failure mode and PSFs), these parameters are used in the selected quantification model to estimate the HEP for each unsafe action. The mean occurrence probability of the HFE is then obtained by combining the unsafe action HEPs with mechanical failure rates (as applicable) in a Boolean expression that expresses the logic of the HFE scenario. Dependencies are accounted for in this quantification process according to the method presented in Section E3.3, and uncertainties are accounted for by applying an error factor to the mean value of the overall HFE according to the guidelines presented in Section E3.4.

It should be noted, that when using NARA to calculate the HEP of a given unsafe action, the NARA HEP equation is used from *A User Manual for the Nuclear Action Reliability Assessment (NARA) Human Error Quantification Technique* (Ref. E8.1.11, p. 14).

In addition, it should also be noted that in CREAM there is a discrepancy in the values quoted for observation errors O2 and O3 (*Cognitive Reliability and Error Analysis Method, CREAM*, Table 9, Chapter 9, p. 252 (Ref. E8.1.18)). The National Aeronautics and Space Administration (NASA) shuttle PRA study (Ref. E8.1.16) cites a mean value of $3E-03$ for these failure modes, which is consistent with the value found in the CREAM example (*Cognitive Reliability and Error Analysis Method, CREAM*, Table 16, Chapter 9, p. 258 (Ref. E8.1.18)) for O3. The changes to the original CREAM values for observation errors O2 and O3 made in the NASA shuttle PRA study reflect the correction of a typographical error in the original CREAM value. These changes were made based on a conversation with the CREAM author (Ref. E8.1.27). The

HRA team in the current analysis therefore judged that the correct mean value for these failure modes to be $3E-03$, as cited in the shuttle PRA.

E3.2.7.4 Verification of Human Error Probabilities

After estimates for HFE probabilities are generated, these results are reviewed by the HRA analyst and operations personnel (whenever available) for a “sanity check.” Such checks can be used, for example, to compare the probabilities of different HFEs and to determine whether or not these probabilities are reasonable with respect to the associated operator actions. A review of this type is particularly important for HFE probabilities that are generated using data from the THERP (Ref. E8.1.26) method since it is difficult to identify all important PSFs.

In addition, the HFE probability estimates are reviewed to ensure that the combinations of unsafe actions within an HFE do not exceed the lower limit of credible human performance. In this regard, the human performance limiting values from NARA (Ref. E8.1.11) were applied. Table E3.2-1 is adapted from the NARA documentation (Ref. E8.1.11).

Table E3.2-1. Human Performance Limiting Values

Actions	HPLV
Actions taken by a single team.	$1E-5/d$
Actions taken by more than one team either when the significance of the goal is well understood and the time is adequate or when extended time is available.	$1E-6/d$
Actions taken by more than one team when the significance of the goal is well understood and a fundamental part of training. Extended time must also be available so that inaction would have to persist for several hours if no further attempts were made to achieve the desired goal.	$1E-7/d$

NOTE: d = demand; HPLV = human performance limiting values.

Source: Modified from *A User Manual for the Nuclear Action Reliability Assessment (NARA) Human Error Quantification Technique* (Ref. E8.1.11) p.17.

Overall HFE values can be lower than these values when there are other nonhuman events and/or failures that must occur in addition to operator unsafe actions in order for an HFE to occur. These events can include interlock failures, other mechanical failure, or physical phenomena that are independent of the unsafe actions. However, an absolute floor of $1E-8/d$ is applied regardless of these additional failures.

E3.2.8 Step 8: Incorporate HFEs into PCSA

After HFEs are identified, defined, and quantified, they must be incorporated into the PCSA. Section 10.3 of NUREG-1624 (Ref. E8.1.22) provides an overview of the state-of-the-art method for performing this step in PRAs. This process is done in conjunction with the PCSA analysts. Appendix E.I of this analysis provides the recommended approach for incorporation of human errors in the YMP PCSA, and Appendix E.V of this analysis provides the recommended naming conventions for HFEs incorporated in the fault tree models.

HFEs are incorporated, in the form of basic events, into the fault trees that support the initiating event and pivotal events of event trees. The HEP that is entered in a basic event is modeled as a lognormal distribution, whose mean value is the nominal value of the HEP, to which an error

factor is assigned (Section E3.4) to reflect the uncertainty in the probability estimate. In many cases, the equipment failures and the associated HFEs are calculated as part of an integrated HRA. The resulting probability of both equipment and human failures is then placed in the fault tree as a single basic event.

E3.2.9 Step 9: Evaluation of HRA/PCSA Results and Iteration with Design

This last step in HRA is performed each time the PCSA is quantified. The primary results are the HFEs in dominant cut sets and the associated qualitative inputs to such HFEs. Potential “fixes” to the design or operational environment can be supported by these results.

Because the YMP design and operations were still evolving during the course of this analysis, they could be changed in response to this analysis. This iteration is particularly necessary when an event sequence is noncompliant with the performance objectives of 10 CFR 63.111 (Ref. E8.2.1) because the probability of a given HFE dominates the probability of the event sequence. In those cases, a design feature or procedural safety control could be added to reduce the probability or to completely eliminate the HFE. In such cases, the modification is analyzed for potential new HFEs, and the applicable HFEs are requantified, along with the event sequences.

E3.3 DEPENDENCY

Dependency between human actions is defined to exist when the outcome of a particular human action is related to the outcome of a prior human action or actions. According to THERP (Ref. E8.1.26), the joint probability of human error for a set of dependent human actions is higher than if they were independent.

The possibility of dependencies between human actions and defined HFEs is recognized throughout the HRA task. The concern with respect to dependencies is that the joint probabilities separately assigned to a set of dependent HFEs treated as independent actions can result in a lower event sequence frequency than would result if dependencies among the HFEs were appropriately recognized and treated. This situation is especially important in the HRA activities leading up to and including preliminary analysis where an inappropriately low HEP might lead to an inappropriate screening out of a potentially significant cut set or event sequence. If dependence were properly identified and treated, the resulting HEP might then appear in dominant cut sets and, therefore, be identified for detailed analysis.

E3.3.1 Capturing Dependency

Dependencies between defined HFEs can exist for two reasons:

- Due to the characteristics of the event sequence in which the HFEs are modeled
- Due to the modeling style, especially the degree of decomposition, in HFE definition.

In the first case, dependencies are unavoidable due to the inherent characteristics of the initiator type or event sequence. In the second case, dependencies can be avoided by redefining dependent HFEs into a single HFE. In either case, dependencies can be treated by using a structured method for adjusting probabilities to account for dependencies. However, some HRA

quantification methods (e.g., ATHEANA (Ref. E8.1.22)) account for certain types of dependencies within their formulation by combining dependent events as part of the normal process of addressing the accident scenario as a whole. These methods do not require additional treatment.

All event sequences that contain multiple HFEs are examined for possible dependencies. If practical, HFEs that are completely dependent may be redefined and modeled as a single event.

For the preliminary analysis, HFEs are modeled at a high level where several subtasks are combined into a single task so that explicit consideration of dependencies between subtasks is eliminated. For a detailed assessment, where the various actions that constitute an HFE are explicitly quantified, dependencies are explicitly addressed using the formulae in Table E3.3-1 from THERP (Ref. E8.1.26), where N is the independently derived HEP. The THERP dependency model was selected for its formalism and reproducibility. The model itself is not dependent on what the source of the baseline (i.e., independent) HEP is; it can be obtained from any existing model or from expert elicitation. None of the other “objective” quantification approaches used (i.e., HEART (Ref. E8.1.28)/NARA (Ref. E8.1.11) or CREAM (Ref. E8.1.18) has its own dependency model, and NARA (Ref. E8.1.11) specifically endorses the use of the THERP (Ref. E8.1.26) approach.

Table E3.3-1. Formulae for Addressing HFE Dependencies

Level of Dependence	Zero	Low	Medium	High	Complete
Conditional Probability	N	$\frac{1 + 19N}{20}$	$\frac{1 + 6N}{7}$	$\frac{1 + N}{2}$	1.0

Source: Modified from *Handbook of Human Reliability Analysis with Emphasis on Nuclear Power Plant Applications*, NUREG/CR-1278 (Ref. E8.1.26), Table 20-17, p. 20-33.

E3.3.2 Sources of Dependency

The determination of the level of dependence between HFEs is left to the judgment of the HRA analyst. Certain factors typically are recognized as indicators of dependency. Examples of such factors are:

- Common time constraints for task performance
- Common cues or indicators for task performance
- Common diagnosis of situation
- Common facility function or system operation involved in task performance
- Common procedure steps for task performance
- Common personnel and location for task performance
- Common PSFs.

In addition, any human-induced failures of equipment that can directly or indirectly cause other equipment to fail through equipment dependencies are also identified as human dependencies.

E3.4 UNCERTAINTY

As with the values of failure probabilities used for active and passive components used in other parts of the PCSA, it is important that HFE quantification accounts for uncertainty. The HRA quantification, therefore, provides a mean HEP and an expression of the uncertainty. There are a number of ways to approach this task, as each of the HRA methods discussed in Section E3.2.7.2 provides recommendations on uncertainty parameters or bounds for HEPs. These recommendations run from the specific to the general and are often inconsistent. After a review of various recommendations, the HRA team has determined that to use any of them in their specific applications is both impractical and questionable. Rather, it was decided to develop a simple set of generic error factors developed through the use of the judgment by the HRA team, based on a holistic overview of the various recommendations presented in the following sources:

- Section 6 of NARA (Ref. E8.1.11)
- HEART (Ref. E8.1.28)
- Chapter 9 of CREAM (Ref. E8.1.18)
- Chapter 20 of THERP (Ref. E8.1.26).

Although ATHEANA (Ref. E8.1.22) does not provide specific recommendations regarding uncertainty estimation, it stresses that it is important to consider uncertainty in HRAs and that one way to approach it is through the use of expert judgment. To this extent, it can be said that the approach follows the guidance established in ATHEANA.

After review and due consideration of the uncertainty recommendations, the HRA team determined that for the purposes of this study it would be both reasonable and acceptable to establish a generic set of uncertainty parameters based on the calculated (total) HEP for any given HFE. The HRA team reached a consensus on the following error factor values to be applied to a lognormal distribution based on the mean HEP, as shown in Table E3.4-1. For each HEP range, the error factor reflects the HRA team’s degree of confidence in the probability estimate.

Table E3.4-1. Lognormal Error Factor Values

Calculated Mean HEP	Lognormal Error Factor
≥ 0.05	3
>0.0005–<0.05	5
≤0.0005	10

NOTE: HEP = human error probability.

Source: Original

The same error factors are applied to both preliminary values and results of detailed HRAs. Therefore, after the HRA team has decided on an appropriate mean value, the corresponding generic error factor is assigned unless there is a basis from the detailed analysis to do otherwise.

E3.5 DOCUMENTATION OF RESULTS

The following information is included in the documentation of the results for the YMP PCSA HRA:

- General discussion of the overall set of PSFs (e.g., error-producing conditions (EPCs), common performance condition (CPCs)) on human performance that are applicable to or especially important for the YMP PCSA and how they apply to the operations of the facility in question
- A list of all HFEs (by basic event name and category, along with a brief description of the HFE) included in the PCSA model, with their final assigned HFE probabilities
- Identification of preliminary values used for these HFEs
- Identification of the HFEs analyzed in detail
- A more detailed description of each HFE analyzed in detail
- Identification of all expected pertinent procedures or, if no procedures are expected to exist, alternative evidence that supports the identification and quantification of HFEs and recoveries or substantiates the likelihood of human actions (e.g., normal operating practices, formal training)
- For each HFE analyzed in detail, identification of the quantification method, associated input parameters (e.g., PSFs), and any approximations or required procedural controls used to determine probabilities for that HFE
- References to sources of input information (e.g., thermal-hydraulic calculations) used in detailed quantification
- Results of qualitative and preliminary analysis
- Results of detailed quantitative analysis.

E4 INFORMATION COLLECTION AND USE OF EXPERT JUDGMENT

This section addresses how and what information was collected to support the HRA analysis and how expert judgment was used in the identification and quantification of HFEs.

E4.1 FACILITY FAMILIARIZATION AND INFORMATION COLLECTION

E4.1.1 General Information Sources

As with all of the tasks in the PCSA, facility information is required to support the HRA. In addition to the information that is gathered to support the other modeling tasks (e.g., initiating events, systems), the analysts obtain specific additional information that is needed to support the HRA task.

Since the YMP is in the design phase, there are limits on facility-specific information available to support the HRA. Sources utilized in this analysis include the following:

- Design drawings and design studies
- Concept of operations documents
- Engineering calculations
- Discussions of event sequences with knowledgeable individuals
- Event trees and supporting documentation
- Fault trees and supporting documentation.

Information from similar facilities is used, including NPPs (particularly those with ISFSIs), chemical agent disposal facilities, and any other facilities whose primary function includes handling and disposal of very large containers of hazardous material. This was conducted primarily for ISFSI activities at NPPs. The use of this information in place of YMP plant-specific information is pursuant to the third analytical boundary condition specified in Section E2.2. Following are sources of information from ISFSI that are applied to support the YMP PCSA:

- Interviews with plant operators, operations personnel, and/or other ISFSI knowledgeable personnel
- Pertinent ISFSI procedures (e.g., operating procedures, test and maintenance procedures)
- Plant walk-downs (e.g., at locations where operations similar to those at repository may be performed) and operations reviews
- Studies, including PRAs and HRAs, conducted at these facilities that would substitute for the previously mentioned sources.

This information was acquired from two sources. First, information was obtained by the HRA team from outside sources specifically for use on the YMP, such as from NPPs, industry organizations, and governmental sources. Some of this information may have been obtained directly by the HRA team or may have been provided to the HRA team by members of the Licensing and Nuclear Safety, Engineering, or Operations departments who had obtained the information as a part of their regular duties on the YMP (Section E4.2.2). Second, information was obtained by the HRA team directly from internal sources, including members of the aforementioned departments who had past experience and information on ISFSIs from prior employment and projects before joining the YMP(Section E4.2.1).

Initially, information is gathered to support the identification of pre-initiator, human-induced initiator, and non-recovery post-initiator HFEs. This information is needed to:

- Identify test and maintenance activities performed for equipment included in the PCSA model
- Determine the frequency of test and maintenance activities

- Identify the procedures used to perform test and maintenance activities
- Determine what equipment is impacted by test and maintenance activities.

For human-induced initiator and post-initiator HFEs, such information is needed to:

- Identify important operator tasks
- Identify the specific actions required for each operator task
- Identify the procedures (e.g., normal operating and emergency operating procedures) and procedure steps associated with each operator task
- Identify the cues (e.g., procedure steps, alarms) for operator tasks
- Assess the procedures that support operator tasks as PSFs
- Assess the training that supports operator tasks as PSFs.

E4.1.2 Industry Data Reviewed by the HRA Team

The following sources of industry data were reviewed by the HRA team for potential vulnerabilities and HFE scenarios applicable to the YMP:

- *A Survey of Crane Operating Experience at U.S. Nuclear Power Plants from 1968 through 2002*, NUREG-1774 (Ref. E8.1.19)
- *Control of Heavy Loads at Nuclear Power Plants*, NUREG-0612 (Ref. E8.1.20)
- Navy Crane Center, Naval Facilities Engineering Command Internet Web Site. The database includes the following information:
 - Navy Crane Center Quarterly Reports (“Crane Corner”) 2001 through 2007
 - Fiscal Year 06 Crane Safety Report (covers fiscal years 2001 through 2006)
 - Fiscal Year 06 Audit Report
- U.S. Department of Energy (DOE) Operational Experience Summary (2002 through 2007) (<http://www.hss.energy.gov/CSA/analysis/orps/orps.html>).
- Institute of Nuclear Power Operations (INPO) database (<https://www.inpo.org>). The INPO database contains the following information:
 - Licensee Event Reports
 - Equipment Performance and Information Exchange System
 - Nuclear Plant Reliability Data System.
- *Savannah River Site Human Error Data Base Development for Nonreactor Nuclear Facilities (U)* (Ref. E8.1.5)

- All Scientech/Licensing Information Service data on ISFSI events (1994 through 2007) Scientech LIS Database and Dry Storage Information Forum (New Orleans, LA, May 2-3, 2001). This database includes the following information:
 - Inspection reports
 - Trip reports
 - Letters, etc.

E4.2 USE OF EXPERTS AND ENGINEERING JUDGMENT IN THE HRA

Subject matter experts were employed in the identification, verification, preliminary analysis, and detailed analysis of HFEs. Identification of HFEs, of which a HAZOP evaluation was a part, was performed as a combined effort by experts from a wide range of areas. This identification was not specifically a part of the HRA task, but it was used by the HRA team in the process of identifying HFEs. A description of the HAZOP evaluation process and a list of experts who specifically participated in the HAZOP evaluation is provided in the *Canister Receipt and Closure Facility Event Sequence Development Analysis* (Ref. E8.1.10).

E4.2.1 Role of HRA Team Judgment

Preliminary and detailed analyses were primarily performed by the HRA team in a consensus-based process. For the preliminary analysis, the judgment process can be summarized in the following fashion:

- Each HFE that was identified during the HAZOP evaluation and the operational experience review was characterized with input from the Engineering and Operations departments, including the context under which the HFE would occur.
- Once the individual members of the HRA team were confident that they understood the HFE and the context, they each independently assigned an HEP to the HFE and briefly documented the rationale relative to a set of anchor points established for the HRA (the basic anchor points can be found in Appendix E.III of this analysis).
- The values and rationales were combined into a single spreadsheet, and the team then met to discuss their values.
- The HRA team used their knowledge of the preclosure process and design to develop a consensus on the factors affecting the HFE and a resulting conservative estimate of the HEP. In most cases, the team ultimately reached a consensus on a value and a rationale. In a few cases a consensus could not be reached, and the most conservative value and rationale from that team member was used. The value and rationale applied was then documented.

This process is explained in much greater detail in Appendix E.III of this analysis.

The detailed analyses were performed by individual members of the HRA team and were reviewed by the rest of the HRA team. Judgment was used to identify the details of the scenarios

that could lead to the HFE, the appropriate quantification methodology to apply to each unsafe action, the actual quantification of the unsafe action, and any probabilities for other key failures within the HFE for which probabilities were not available in the active or passive failure database. However, in no instance was expert judgment used to quantify an entire HFE, so in the context of the ATHEANA concept of an expert elicitation approach to quantification, it was not necessary to utilize the strict formalism. Each HFE was broken down into various combinations of unsafe actions and mechanical failures. In all but one case, every unsafe action was quantified using one of the “structured” HRA quantification techniques (i.e., HEART (Ref. E8.1.28)/NARA (Ref. E8.1.11), CREAM (Ref. E8.1.18), or THERP (Ref. E8.1.26)), and so expert elicitation was not required. In the one exception, the process that was followed is that the team member who performed the detailed quantification of the HFE provided a detailed rationale for the selection of a value based on judgment. The entire HFE quantification, including the judgment value, was provided to the other team members for review and concurrence, and the resultant value and rationale were included in the final HFE quantification. In addition, there were cases where some of the mechanical failures within the HFE also required the use of judgment in selecting a probability of occurrence. These values were selected in accordance with the engineering judgment approach used throughout the PCSA for selection of such values. This approach anchors the selection of failure probability based on the level of understanding of the physical phenomena involved, rather than the use of anchors based on the context of the HFE. This approach is documented in Section 4.3.10.2.

The members of the HRA team are listed in the following section.

E4.2.1.1 HRA Team

Paul J. Amico—Mr. Amico is a nuclear engineer with 30 years of experience in risk, safety, regulation, and operation of NPPs, nuclear material production reactors, nuclear weapons research, production and storage facilities, nuclear fuel cycle facilities, chemical demilitarization facilities, and industrial chemical plants. He has been involved in the conduct and review of HRA since 1979. His experience includes the use of THERP, Time-Reliability Correlation (TRC), Systematic Human Action Reliability Procedure (SHARP), Human Cognitive Reliability (HCR), HEART, ATHEANA, CREAM and NARA, and he has been involved in projects related to methodology enhancements to some of these techniques. Prior to joining the YMP, he was involved in HRA for a number of NPP PRAs in the United States and overseas; for chemical process plants; and for SNF handling and storage at NPPs, including the development of project procedures for HRA. He developed a phased approach to the use of HRA during the design process of advanced NPPs and supported a project to expand HRA techniques for SNF handling operations.

Erin P. Collins—Ms. Collins is a risk analyst with over 20 years of experience in safety, reliability, and risk analysis for the U.S. Army chemical weapons destruction program, NASA, the Federal Aviation Administration, NPPs, and the chemical process industry. Her specialties are equipment reliability database development and HRA. Ms. Collins was a prime participant in a safety hazard analysis of an acrylic fiber spinning facility in northeastern Italy. This analysis evaluated worker risk in various areas of the facility through the use of hazard analysis techniques, including a HAZOP evaluation, and resulted in the recommendation of economical risk reduction measures. Her project experience in Spain includes technical review and support

of the HRAs for the Ascó and the Santa Maria de Garoña nuclear plant PRAs. She also supported the review of the Kola and Novovoronezh Russian nuclear reactor HRAs for the DOE. In the United States, Ms. Collins has participated in PRA-related HRAs of the Hanford N Reactor and the Robinson (using simulator exercises), Crystal River 3, and Catawba NPPs. Throughout these efforts, she has applied the HEART, CREAM, THERP, and TRC methods of quantification.

Douglas D. Orvis, Ph.D.—Dr. Orvis is a registered professional engineer (California, Nuclear No. 0925) with over 35 years of experience in nuclear engineering, regulation, and risk analysis of NPPs, alternative concepts for interim storage of SNF, and aerospace applications. Dr. Orvis has participated in the development of HRA techniques (e.g., SHARP for Electric Power Research Institute (EPRI), effects of organizational factors for the NRC) and has measured and analyzed data for evaluating the reliability of NPP control room operators during simulated accidents. These data-based analyses included the EPRI-sponsored Operator Reliability Experiments (ORE) (e.g., measurements performed at the Diablo Canyon, Kewaunee, and LaSalle simulators) and the follow-on programs performed at the Maanshan (Taiwan) simulator. Data collection and analysis included observing operator behavior, variability between crews, developing time-response correlations for key operator actions, and evaluating the numbers and kinds of errors and deviations committed. Postsimulation interviews with crew members and trainers were conducted to elicit information on conditions and factors that contributed to crew performance. The data analysis included comparisons of data to the HCR model and a statistical evaluation of the types and causes of errors and deviations. A similar data collection evaluated the efficacy of an expert system called the Emergency Operating Procedures Tracking System.

Dr. Orvis participated in a comprehensive review of HRA methods for a Swiss agency and was a consultant to the International Atomic Energy Agency to incorporate concepts of HRA and organizational factors into (Assessment of the Safety Culture in Organizations Team) guidelines for plant self-assessment of safety culture. Dr. Orvis has performed event tree and fault tree analyses of hazardous systems for both internal events and seismic initiators that included consideration of HRA. Dr. Orvis has participated in HAZOP evaluation sessions for repository operations.

Mary R. Presley—Ms. Presley is an engineer with 3 years of experience in risk analysis for NPPs, specializing in human reliability. Ms. Presley graduated in 2006 from the Massachusetts Institute of Technology with her M.S. in nuclear engineering, where she wrote her thesis *On the Assessment of Human Error Probabilities for Post Initiating Events*, which included an extensive review of current HRA methods. While her work focused on the EPRI HRA calculator and the NRC ATHEANA framework, she is also familiar with other HRA methods, including THERP, Accident Sequence Evaluation Program (ASEP), HEART, NARA, Failure Likelihood Index Methodology (FLIM), Success Likelihood Index Method/Multi-Attribute Utility Decomposition (SLIM/MAUD), Standardized Plant Analysis Risk Human Reliability Analysis (SPAR-H), CREAM, Methode d’Evaluation de la Relisation des Missions Operateur pour la Surete (MERMOS), Cause-Based Decision Tree (CBDT), and HCR/ORE.

E4.2.2 Role of Subject Matter Expert Judgment

Subject matter experts were also consulted during the compilation of the base case scenarios. The outline of the base case scenarios came from the mechanical handling block flow diagram. The details of human interaction with the mechanical systems were derived from expected operations inferred directly from the design by the subject matter experts. Where a detailed design was not available, the experts extrapolated these details from common industry practice for similar operations. These experts come from the YMP Engineering, Operations, and PCSA groups, as well as from outside the YMP project.

In addition to the development of base case scenarios, subject matter experts were regularly consulted during the analysis to provide clarification of design, clarification of expected operations, and insight into expected operating conditions and failure modes. These experts provided details about the design of systems that were relevant to human performance, such as the presence of job aids and interlocks and the intended design of control system interfaces. They also provided details regarding the concept of operations for the processes, such as the role of the humans versus the use of automatic systems, the operational controls, and the use of procedures. These experts would also review specific parts of the analysis for technical accuracy.

Below is a list of some areas where subject matter experts were consulted during the HRA for their expertise:

- PCSA models (i.e., facility or system fault trees)
- Site prime mover (SPM), railcar, truck trailer, cask transfer trolley (CTT), and site transporter design and operation
- Crane operations (critical lifts)
- Crane design – Single-failure proof cranes (i.e., gantry cranes designed to NOG-1 level 1 standards (Ref. E8.1.2) or jib cranes designed to NUM-1 Type 1A (Ref. E8.1.3))
- Crane design – Non-single failure proof cranes (i.e., gantry cranes designed to NOG-1 level 2 standards (Ref. E8.1.2) or jib cranes designed to NUM-1 Type 1B (Ref. E8.1.3))
- Platform operations (shield plate)
- Gas sampling process
- Canister transfer machine (CTM) design and operations
 - Adjustable speed drive (ASD) features and operations
 - Grapple interfaces
 - Interlocks

- Radiation protection (e.g., cask shielding/shield rings; locks, interlocks, and procedural controls for entering high radiation areas)
- General facility (including aging pad and drifts) layout and time line of operations
- Interlocks (general)
- Waste package welding equipment and process
- Waste package transfer trolley (WPTT) design and operations (including interface with the CTM and the transport and emplacement vehicle (TEV))
- TEV design and operations
- Aging overpack, TTC and VTC design and handling
- Other systems

E5 TERMINOLOGY AND OVERVIEW OF HUMAN PERFORMANCE ISSUES

Over the history of performance of HRAs, certain terminology has become commonplace and different classification schemes for human error has been developed. This section provides a background of this terminology and associates it to the YMP PCSA HRA. In addition, the description of operations includes references to different types of personnel. The functions of each classification of personnel are described in this section. Finally, a discussion is provided of the specific issues that relate to human performance at the YMP.

E5.1 TERMINOLOGY

E5.1.1 Classification of HFEs

As noted in the methodology (Section E3.2), HFEs are classified to support the HRA preliminary analysis, selection of HRA quantification methods, and detailed quantification. A combination of four classification schemes is used in the YMP HRA. The first three schemes are familiar standards in HRA. The fourth scheme has its basis in behavioral science and has been used in some second-generation HRA methods.⁵

⁵There is another classification not included here that has been often used in nuclear power plant PRAs: the behavior type taxonomy. This category classifies HFEs into skill-, rule-, or knowledge-type behavior. While this taxonomy has limited usefulness in addressing HFEs that take place in an NPP control room under time constraints, this distinction is not particularly useful for other types of actions. As a result, it is generally not used for HRAs in such applications as chemical process facilities, chemical demilitarization facilities, or NASA manned-mission risk assessments. Given the type of human actions and HFEs that are important at the YMP, use of this approach for the YMP PCSA HRA is not recommended.

The four classification schemes are based on the following:

1. The three temporal phases used in PRA modeling:
 - A. Pre-initiator
 - B. Human-induced initiator
 - C. Post-initiator
2. Error modes:
 - A. EOOs
 - B. EOCs
3. Human failure types:
 - A. Slips/lapses
 - B. Mistakes
4. Informational processing failures:
 - A. Monitoring and detection
 - B. Situation awareness
 - C. Response planning
 - D. Response implementation.

The following sections define these classification methods.

E5.1.1.1 Temporal Phases of HFEs

There are three temporal phases of HFEs:

- Pre-initiator HFE—An HFE that represents actions taken before the initiating event that causes systems or equipment to be unavailable. Examples of such HFEs are miscalibration of equipment or failure to restore equipment to an operable state after testing or maintenance activities.
- Human-Induced Initiator—An HFE that represents actions that cause or lead to an initiating event.
- Post-initiator HFE⁶—A post-initiator HFE represents those operator failures to manually actuate or manipulate systems or equipment, as required for accident response. Post-initiator HFEs can be further divided into recovery and non-recovery events.
 - A non-recovery post-initiator HFE (i.e., failure during response to an initiator) is when an operator does not operate frontline equipment in accordance with required procedural actions due to errors in diagnosis or implementation. For quantification

⁶ The HRA did not take credit for post-initiator human actions and no post-initiator HFEs were identified.

purposes, these HFEs are usually decomposed into cognitive and implementation parts, as shown in Appendix E.II of this analysis. In general, post-initiator HFEs associated with such actions are incorporated directly in the model prior to initial PRA quantification using preliminary values. The results of the initial event sequence quantification are used to determine if detailed modeling of these HFEs is needed.

- A recovery post-initiator HFE represents operator failure to manually actuate or manipulate frontline equipment (or alternatives to frontline equipment⁷) that has failed to automatically actuate as required. In general, post-initiator HFEs associated with correction or recovery of failed frontline systems from either equipment or human failures are not modeled until after initial PRA quantification. The results of initial event sequence quantification are used to determine if modeling of such recovery HFEs is needed.

E5.1.1.2 Error Modes

HFEs can be classified by error mode as either an EOO or EOC. EOOs and EOCs can occur in any temporal phase (i.e., pre-initiator, initiator, or post-initiator). This classification is highly dependent upon the specific event tree or fault tree model. In other words, the same operator action could be modeled as either an EOO (e.g., failed to actuate system x) or an EOC (e.g., actuated system y instead of x). The error mode model is chosen based on consistency with the PCSA model and at the discretion of the HRA analyst. In early PRAs, EOCs were often excluded. Current PRAs, however, address both EOOs and EOCs, although there are still few methods for identifying and quantifying EOCs. In the current analysis, EOO and EOC are defined as follows:

- EOO—An HFE that represents the failure to perform one or more actions that should have been taken and that then leads to an unchanged or inappropriately changed configuration with the consequences of a degraded state. Examples include the failure of a radiation protection worker to perform the radiologic survey before a cask is released from the facility.
- EOC—An HFE that represents one or more actions that are performed incorrectly or some other action(s) that is performed instead. It results from an overt, unsafe action that, when taken, leads to a change in configuration with the consequence of a degraded state. Examples include commanding a crane to lift when it should be lowered.

E5.1.1.3 Human Failure Type

Human failure types include the following:

- Slip/lapses—An action performed where the outcome of the action was not as intended due to some failure in execution. Slips are errors that result from attention failures, while lapses are errors that result from failures in memory recall.

⁷Alternatives to frontline equipment, include equipment that operators can use for performing the functions of frontline equipment in case of an impossibility to recover the failed frontline equipment in a timely manner.

- **Mistake**—An action performed as intended, but the intention is wrong. Mistakes are typically failures associated with monitoring (especially deciding what to monitor and how frequently to monitor), situation awareness, and response planning. Section E5.1.1.4 provides definitions of these terms.

E5.1.1.4 Informational Processing Failures

Assessment of HFEs can be guided by a model of higher-level cognitive activities, such as an information processing model. Several such models have been proposed and used in discussing pilot performance for aviation. The model that is recommended for the YMP HRA is based on the discussion in Chapter 4 of ATHEANA (Ref. E8.1.22) and consists of the following elements:

- **Monitoring and detection**—Both of these activities are involved with extracting information from the environment. Also, both are influenced by the characteristics of the environment and the person's knowledge and expectations. Monitoring that is driven by the characteristics of the environment is called data-driven monitoring. Monitoring initiated by a person's knowledge or expectations is called knowledge-driven monitoring. Detection can be defined as the onset of realization by operators that an abnormal event is happening.
- **Situation awareness**—This term is defined as the process by which operators construct an explanation to account for their observations. The result of this process is a mental model, called a situation model that represents operators' understanding of the present situation and their expectations for future conditions and consequences.
- **Response planning**—This term is defined as the process operators use to decide on a course of action, given their awareness of a particular situation. Often (but not always) these actions are specified in procedures.
- **Response implementation**—This term is defined as the activities involved with physically carrying out the actions identified in response planning.

When there are short time frames for response and the possibility of severely challenging operating conditions (e.g., environmental conditions) exists, then failures in all information processing stages must be considered. Also, slips/lapses and mistakes are considered for each information processing stage. Response implementation failures are expected to dominate the pre-initiator failures that are modeled. Post-initiator failures and failures that initiate event sequences can occur for all information processing stages, although detection failures are likely to be important only for events requiring response in very short time frames.

E5.1.2 Personnel Involved in CRCF Operations

A list of personnel involved in CRCF operations with a brief description of their duties is provided below:

Arm operator—The person who is designated to operate one of the robotic arms that are used to weld the waste package. This person welds the canister from a remote location.

Crane operator—The person who is designated to operate the crane for a given operation (i.e., the cask handling crane, the cask preparation crane, or the waste package handling crane).

Crew member—A generic term for personnel (not including crane operators, radiation protection workers, or supervisors) involved in the facility operations.

CTM operator—The person who is designated to operate the CTM for canister transfer activities. This person is located in the CRCF Control Room and controls the CTM remotely.

Level 2 and 3 NDE personnel—The person(s) who is certified to inspect the waste package welds and sign off on the process. This person(s) must have a level 2 and level 3 nondestructive examination (NDE) certification.

Person in charge (PIC)—The certified crew member who is in charge of coordinating and overseeing the facility operation. This is the person who is notified when a waste form is coming to the facility and who coordinates, according to this information, the appropriate personnel, procedures, and equipment to be used to process this cask type. This person is in charge of communicating this information to all the crew members involved in the processing of this cask and ensuring that the relevant equipment is properly staged and in proper operational condition.

Quality control—The certified crew member in charge of quality control. This person is involved in supervising critical operations and tracking the appropriate documentation (i.e., tracking the bar codes on the waste package and documenting the waste form identification with the bar code).

Radiation protection worker—The certified health physics technician, whose job is to monitor radiation during cask-related activities. This person is responsible for stopping operations if high radiation levels are detected.

RHS operator—The person who is designated to operate the remote handling system (RHS) and who is specifically trained to aid in the welding process. This person controls the RHS remotely.

Signaling crew member—The person who is designated to provide signals to the crane operator. This person is predesignated and is distinguished from the verification crew member (most likely through an orange hard hat, orange gloves, or an orange vest as per the high-level radioactive waste (HLW) *Hoisting and Rigging (Formerly Hoisting and Rigging Manual)* (Ref. E8.1.12)).

SPM operator—The person who is designated to operate the SPM to bring a railcar or truck trailer into the facility.

Site transporter operator—The person who is designated to operate the site transporter to move an aging overpack into and around the facility.

Supervisor—The person who is in charge of the given operation and who supervises and checks off critical operations in a given step. For steps requiring independent verification, this analysis uses the term supervisor as the person who provides the independent check. This analysis does not rely upon the fact that this check is performed by the actual supervisor, only that an

independent check is done by someone with the appropriate training and qualifications (i.e., the supervisor).

TEV operator—The person who is designated to operate the TEV. This person is in charge of ensuring that the TEV is in the appropriate configuration for waste package loading prior to the WPTT being moved into the Waste Package Loadout Room. This person is located in the Central Control Center and controls the TEV remotely.

Verification crew member—The person who is designated to assist with crane operations that require a second spotter. This person can only give the stop signal to the crane operator.

WPTT operator—The person who is designated to operate the WPTT. The WPTT is semiautonomous with all safety functions carried onboard. This person is located in the CRCF Control Room and controls the WPTT remotely.

E5.2 OVERVIEW OF HUMAN PERFORMANCE ISSUES

This section discusses the general human performance issues that characterize the human interaction with the YMP facilities.

Limited Automation (Significant Human Interaction)—The types of operations being performed in the CRCF are not always conducive to automation. In particular, crane and transport operations are generally performed both manually and locally. Even those that are performed remotely require significant interaction by the operators. The dependence on human performance is quite high, and that dependence provides many opportunities for unsafe actions.

Limited Nature of Procedures—Other than those operations that are performed remotely from a control room, YMP operations are not highly proceduralized, but rather they depend primarily on skills learned and training. That is, while written procedures exist for all activities and training of all personnel is thorough, the actual use of procedures and checklists during operation (i.e., the step-by-step following of written procedures) generally occurs only during operations in a control room. The vast majority of local operations (e.g., skill-of-craft activities performed outside the control room) does not use written procedures at all during the actual performance of the tasks and does not have formal checklists or verbal confirmation requirements spelled out in procedures physically in the possession of the crew performing the operation. This circumstance is consistent with observations of activities at NPPs during ISFSI operations.

Communication Difficulties—There are significant challenges in communication between the team members performing CRCF operations. The environment contains a not insignificant amount of background noise, predominantly machine noise. Although headsets may be used by key participants for communication, they do not eliminate the potential for misunderstanding. Garbled communication (due to system interference or background noise) is clearly possible, and in some cases it may not even be possible to clearly determine who is speaking. A belief that a particular individual is speaking, even if they are not, can bias the listeners into hearing what they expect to hear.

Visual Challenges—For most of the remote operations, successful completion of the operation requires a certain amount of visual acuity both for the performance of the operation and the confirmation of the status. Safety concerns require that visual observation be performed using cameras that provide images to screens in the control room. Even local crane operations create visual challenges. The crane operator can only be at one given distance and orientation with relation to the operation, and therefore cannot be viewed on all three axes. In addition, views may be obstructed, such as by the yoke, the load being moved, or some other structure or equipment. Thus, the operator is often put in the position of being the hands for someone else's eyes, which make the operations vulnerable to the communication vulnerabilities discussed previously.

Unchallenging Activities—The activities involved in CRCF operations are, in general, quite simple in nature. In addition, the speed of the movements is quite slow, so each action takes a long time to complete. Basically, this is mostly boring work, with a significant amount of downtime between actions for some individuals. There is ample opportunity for diversion and distraction, and an air of informality and complacency can easily exist within and amongst the crew members. From a psychological perspective, there is insufficient dynamic activity to generate an optimum stress level for performance.

E6 ANALYSIS

E6.0 BACKGROUND

E6.0.1 Reader's Guide to the HRA Analysis

Section E3.2 describes nine steps that comprise the HRA process. This section describes the implementation of Steps 2 through 8.

The HFEs were analyzed in logical groups that relate to the various phases of CRCF operations. For each group of operations, the following is presented:

- A base case scenario describing the normal operations for that group of operations (Step 2)
- Descriptions of the HFEs of concern identified for the group (Step 3)
- Preliminary values for each HFE identified (Steps 4 and preliminary Step 8)
- Detailed analysis for significant HFEs (Steps 5 through 7 and final Step 8).

Figure E6.0-1 is an overview of how the facility operations were grouped. For the CRCF, there are eight HFE groups analyzed, with each presented in a separate subsection of Section E6.

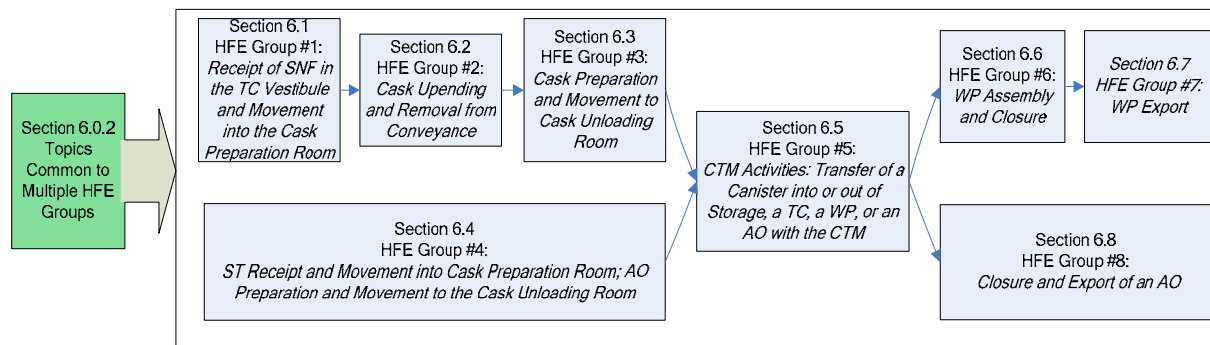

NOTE: AO = aging overpack; CTM = canister transfer machine; HFE = human failure event; ST = site transporter; TC = transportation cask; WP = waste package.

Source: Original

Figure E6.0-1. HFE Groups Associated with Facility Operations

The HRA is conducted to link the HFEs to the event sequence analysis for the operations in a given HFE group of the facility. When added to the generic information contained in the topics common to multiple HFEs (Section E6.0.2), each major section shown in Figure E6.0-1 (e.g., E6.1, E6.2) treats one set of operations in its entirety and is designed to stand alone and be complete with respect to the actions in that HFE group.

The ordering of the major sections follows the high-level flow diagram in Figure E6.0-1, and it is essential to note that, because this facility handles several types of waste forms, there may be multiple variations of the facility operations (i.e., multiple paths such as in Figure E6.2-1). At various points in this attachment, therefore, it may be necessary for the reader to “loop back” to evaluate an alternative path through the process. In these cases, an HFE group (Section E6.x, where x denotes a particular subsection) does not follow logically from the previous HFE group (Section E6.x-1, where x-1 denotes the subsection prior to x). This can happen multiple times in the course of analyzing the facility operations. It is intended that the reader begin by reviewing the material contained in this introductory section (as it applies to all groups) and then read each individual major section to understand the event sequence assessment of its associated operations.

Operations within a given HFE group may also have multiple variations. The reader is cautioned that an HFE group may also not flow cleanly in sequential order from beginning to end. A flow diagram is provided in the introduction to each major section to assist the reader in navigating through the operations of an HFE group.

Each HFE group begins with the flow diagram and a description of the base case scenario for that group. The flow diagram allows the reader to understand how any given part of the base case scenario relates to the rest of the base case scenario. A table is then provided that summarizes the HFE descriptions and the preliminary values assigned. Detailed analyses, where appropriate, are then explained in terms of the HFE scenarios (identified by a basic event name) and the unsafe actions within these scenarios. For these detailed analyses, an explanation of how each action was quantified is provided, indicating the specific quantification method and task type identifier used for the quantification. Each HFE group subsection concludes with a table

summarizing the final HEP values for the relevant HFE scenarios. Where no detailed analyses were performed, the HFE description and preliminary value table provides this information. By associating each scenario with a basic event name, the link between the HRA results and the PCSA models is clearly established because the HFE can be traced directly to its position(s) in the fault tree(s).

The HFEs listed in each HFE group were identified through an iterative process involving the HAZOP evaluation, development of the MLD, ESDs and initial event trees/fault tree models, and extensive conversations between subject matter experts (Section E4.2.2) and the HRA team (Section E4.2.1). Because the HRA was performed as part of an integrated process with the rest of the PCSA, to put this analysis in context, the reader must have an understanding of the other components of the PCSA, including:

- The process flow diagram
- HAZOP evaluation
- MLD
- Event trees
- Faults trees (including the pivotal event fault trees)
- ESDs

To provide traceability between the HRA and the rest of the PCSA, Table E6.0-1, provides a cross-reference between the HFE groups and the ESD and HAZOP evaluation node(s)⁸ applicable to a given group.

Each HFE group represented in Table E6.0-1 corresponds to a HAZOP evaluation node(s) addressing that group and the ESDs and event trees that represent the event sequences covering that group. In this way, a reader looking to understand how human failures affect the results of the event sequence quantification for the event tree in any specific event tree group need not move back and forth between the major sections of E6, but can find everything related to all HFEs within each set of operations for an HFE group in a single major section. There is some necessary repetition of similar information used in more than one major section when the operations performed in their respective groups are similar (or identical). Material on HRA methodology that is common to all HFE analyses is not repeated; however, cross-references to applicable sections and appendices are provided, as appropriate.

Table E6.0-1. Correlation of HFE Groups to ESDs and HAZOP Evaluation (PFD) Nodes

Activity	HAZOP Evaluation (PFD) Node	ESD
HFE Group #1: RC Receipt and Movement into Cask Preparation Room		
Move RC/Truck into Cask Preparation Room	1	1
Disengage and remove SPM from facility		

⁸ HAZOP nodes are defined by the PFD in the PCSA *Canister Receipt and Closure Facility Event Sequence Development Analysis* (Ref. E8.1.10).

Table E6.0-1. Correlation of HFE Groups to ESDs and HAZOP Evaluation (PFD) Nodes (Continued)

Activity	HAZOP Evaluation (PFD) Node	ESD
HFE Group #2: Cask Upending and Removal from Conveyance		
Remove personnel barriers	1	3
Cask upending, removal from conveyance and placement into CTT (VTC)	2-5	
Cask upending, removal from conveyance and placement into CTT (TTC)	2, 5, 6-8	
HFE Group #3: Cask Preparation and Movement to Transfer Bay		
Preparation activities – all (gas sampling and cask lid lift fixture installation)	9	4
Preparation activities – DPC (cask lid removal and DPC lift fixture installation)	10	
Move CTT to Cask Unloading Room	11	6
HFE Group #4: ST Receipt and Movement into Cask Preparation Room; AO Preparation and Movement to Transfer Bay		
Move ST with AO to Cask Preparation Room	1	2
Unbolt AO lid	9	5
Move ST to Cask Unloading Room	11	6
HFE Group #5: CTM Activities		
Remove cask lid	11	8, 9, 18
Transfer canister into WP, staging or AO	12-14	
Install AO lid	18	
Install WP inner lid	15	
HFE Group #6: WP Assembly and Closure		
Move WP to WP Positioning Room	15	10
Close WP	16	11
HFE Group #7: WP Export		
Move WP to WP Loadout Room	17	13
Transfer WP to TEV		15
HFE Group #8: Closure and Export of AO		
Move ST with AO to Cask Preparation Room	18	14
Bolt AO lid		12
Export AO		16

NOTE: AO = aging overpack; CTM = canister transfer machine; CTT = cask transfer trolley; DPC = dual-purpose canister; ESD = event sequence diagram; HAZOP = hazard and operability; HFE = human failure event; PFD = process flow diagram; RC = railcar; SPM = site prime mover; ST = site transporter; TEV = transport and emplacement vehicle; TTC = a transportation cask that is upended using a tilt frame; VTC = a transportation cask that is upended on a railcar; WP = waste package.

Source: Original

The following ESDs refer to actions that fall under several HFE groups and PFD nodes:

- ESD 7: Event Sequences Associated with Collision of CTT, Site Transporter, or WPTT with CRCF Shield Door (HFE groups 1, 3, 4, 7 and 8).

- ESD 17: Event Sequences for Activities Associated with Direct Exposure during Preparation Activities (HFE groups 3 and 4).
- ESD 19: Event Sequences for Activities Associated with Direct Exposure during Closure and Exporting Loaded Waste Package (HFE groups 6 and 7).
- ESD 20: Event Sequences for Fire Occurring in CRCF (Fire analysis is treated separately in Attachment F).

HFEs that are generic to several HFE groups can be found in Section E6.0.2; otherwise the HFEs that correspond to these ESDs are located in the appropriate HFE group. Section E7 provides a cross-reference linking these ESDs to their corresponding HFEs.

E6.0.2 Topics Common to Multiple HFE Groups

There are a number of cross-group generic issues and HFEs that were evaluated at the facility level and determined to be conducive to establishing ground rules (i.e., how the combination of interlocks and unsafe actions are modeled in the facility) for use throughout the analysis.

E6.0.2.1 Interlocks

For the HRA, interlocks were generally modeled explicitly in the fault tree instead of being embedded in the HRA for the preliminary analysis. The approach chosen by the team to assign preliminary HEPs when interlocks were present was simplified. Since the interlock would prevent the operator from completing an unsafe action (even if the operator tried to) it was conservatively analyzed as if the operator would always take the unsafe action (i.e., the HEP for the HFE containing the unsafe action was conservatively set to 1.0 as a first approximation of the HEP). Unless otherwise specified, this was done for all cases where the human cannot easily defeat the interlock that protects against the associated unsafe action and HFE. Therefore, the analysis is relying entirely upon the interlock to prevent the failure. The interlock failure probability is taken from the active component failure database (Attachment C), which gives a value of $2.7E-5$ per demand (approximately $3E-5$ /demand). It is recognized in using this approach that, despite the interlock not being easy to defeat, there is always a possibility that it could be defeated (either by the operator or by the maintenance crew and then not restored). However, if this were the case then it would still be necessary for the operator to erroneously conduct the unsafe action. The team considered that it was very unlikely that the screening combination of the bypass error and the unsafe action would approach or exceed the $3E-5$ value for the random failure of the interlock. The team judged that this preliminary value would implicitly account for the failure to restore an interlock after maintenance if that interlock is difficult to bypass and is not bypassed during normal maintenance. If this conservative approach was not adequate to demonstrate compliance with the performance objectives of 10 CFR 63.111 (Ref. E8.2.1), a more realistic preliminary value was applied and justified. That is, the team went back and took a further look at the unsafe action and its associated interlock, and determined whether a lower preliminary HEP for the unsafe action could be justified. If so, this is clearly discussed and documented in the preliminary analysis. Interlocks that humans can reasonably defeat were generally not explicitly modeled in the fault tree, but rather included in the HEP for the HFE since they are not independent of operator actions. Regardless of this

approach, in any case where the preliminary HEP was not sufficient to demonstrate compliance with 10 CFR Part 63 (Ref. E8.2.1) and a detailed analysis was needed, all interlocks and other mechanical failures or physical phenomena that contribute to the overall HFE were integrated into the HRA along with the contributing unsafe actions and evaluated within the overall HFE quantification as part of the context of the HFE and fully discussed and documented in the detailed analysis. In all cases, interlocks that rely on programmed logic controls (PLCs) were not credited in this analysis since they won't be declared important to safety (ITS).

E6.0.2.2 Crane Drops—Drop of Cask or Drop of Object onto Cask

There are several lifts in the CRCF operations, including lifts with the cask handling crane, cask handling crane auxiliary hook, the CTM, the RHS crane and the Waste Package Loadout Room crane. These lifts of canisters, casks and heavy objects can potentially result in a drop. Crane-drop-related HFEs were not explicitly quantified because the probability of a crane drop due to human failure is incorporated in the historical data used to provide general failure probabilities for drops involving various crane/rigging types. Documentation for this failure can be found in Attachment C (active component failure data). The only exception to this is drops from the CTM; these were explicitly modeled because the CTM is sufficiently different from standard industry cranes to warrant a separate analysis.

E6.0.2.3 Preliminary Analysis of Cross-Cutting HFEs

E6.0.2.3.1 Operator Introduces Moderator Source in to Moderator-Controlled Areas of the CRCF

The analysts have not found any way for operators to introduce significant quantities of moderator in the moderator-controlled areas of the CRCF; therefore, this failure was omitted from analysis.

E6.0.2.3.2 Load Lifted too Heavy for Crane

There are several lifts in the CRCF operations that may potentially result in the operator attempting to lift a load which is too heavy for the crane. Some of these opportunities include:

- Attempting to remove the cask lid with the CTM or auxiliary hook of the cask handling crane when all the lid bolts have not been removed
- Attempting to remove the impact limiters with the auxiliary hook of the cask handling crane when all the bolts have not been removed
- Attempting to lift the cask from the conveyance with the cask handling crane when the tie downs have not been removed
- Attempting to lift the cask from the tilting frame before disengaging the cask from the frame.

Of this set of HFEs, only the failure involving cask lid removal with the CTM was modeled explicitly in the fault trees because it is different than a typical crane. All other drops due to

attempting to lift a load that is too heavy for the crane have been omitted from analysis because they would require a combination of multiple human errors and mechanical errors. All cranes that handle casks are designed to a single-failure proof standard; in this case, there are at least two interlocks which prevent an overload (i.e., load cell and temperature interlock). In addition to the failure of the crane, the crew would have to fail to disconnect the cask/lid from what it is attached to, and then fail to notice that what is being lifted is not correct (i.e., that the railcar is being lifted with the cask); there are at least three crew members involved in all these operations that should be actively observing the lift.

E6.0.2.3.3 Operator Causes Collision between Shield Door and Waste Conveyance

There are several instances where a conveyance, containing a waste form, travels through a shield door. Shield doors are involved in the following transfers:

- The railcar or truck trailer carrying a transportation cask moves into the Cask Preparation Room
- The CTT carrying a transportation cask moves from the Cask Preparation Room into the Canister Transfer Room
- The site transporter carrying an aging overpack moves into the Cask Preparation Room from outside the facility, moves into the Canister Transfer Room from the Cask Preparation Room or moves into the Cask Preparation Room from the Canister Transfer Room
- The WPTT carrying a waste package moves from the Waste Package Positioning Room to the Waste Package Loadout Room
- The TEV, carrying a waste package, leaves the facility.

Each time a conveyance moves through a set of shield doors, two HFEs are possible: an operator can cause the conveyance to collide into the shield door or an operator can close the shield door on the conveyance. These collisions were considered separately from collision of the conveyance into other SSCs because if a conveyance impacts a shield door, the shield door itself can fall back onto the conveyance; these failures are encompassed in ESD 7: Event Sequences Associated with Collision of CTT, Site Transporter or WPTT with CRCF Shield Door. Collision into a shield door, as dictated by the Nuclear Safety Design Basis, does not result in the shield door falling onto the conveyance; therefore, the only failure considered for ESD 7 is operator closes shield door on conveyance. The collision into a shield door is accounted for in the generic collision value for a given conveyance. Each transfer was assessed separately for these failures, but the operations were considered sufficiently similar to allow for one common preliminary value to be applied to all transfers. This preliminary value is described below:

060-OpSDClose001-HFI-NOD: Operator Closes Shield Door on Conveyance

Preliminary Value: 1.0

Justification: The operator can inadvertently close the shield door on the conveyance as it travels through the door. In order to accomplish this, the anti-collision interlock on the shield door must fail. To be conservative, a preliminary HEP value of 1.0 has been assigned to all unsafe actions that require an equipment failure in addition to one or more unsafe actions to cause an initiating event.

E6.0.2.3.4 Heating, Ventilation, and Air Conditioning (HVAC) System

The HVAC system is a universal part of CRCF operations, and HFEs contributing to failure of the HVAC system are thus applicable to all CRCF operational groups. The following pre-initiating HFEs were identified and assigned preliminary values:

060-VCTO-DR00001-HFI-NOD: Operators Open Two or More Vestibule Doors in CRCF

Preliminary Value: 1E-02

Justification: Failure to properly restore an operating system to service when the degraded state is not easily detectable.

060-VCTO-HFIA000-HFI-NOM: Human Error Exhaust Fan Switch Wrong Position

Preliminary Value: 1E-01

Justification: Failure to properly restore a standby system to service.

060-VCTO-HEPALK-HFI-NOD: Operator Fails to Notice HEPA Filter Leak in Train A

Preliminary Value: 1.0

Justification: To be conservative, credit was not given for the operator noticing HEPA filter leaks.

E6.0.2.3.5 Electrical System

The electrical system is a universal part of CRCF operations, and HFEs contributing to failure of the electrical system are thus applicable to all CRCF operational groups. The following pre- and post-initiating HFEs were identified and assigned preliminary values:

060-#EEE-LDCNTRA-BUA-ROE and 060-#EEE-LDCNTRB-BUA-ROE: Operator Fails to restore ITS Load Center (Trains A and B) Post Maintenance

26D-#EEY-ITSDG-A-#DG-RSS and 26D-#EEY-ITSDG-B-#DG-RSS: Operator Fails to Restore Diesel Generator to Service

Preliminary Values and Justification: For electrical systems, the HFE assigned to operator failure to restore a system (i.e., load center or diesel generator) to service was assigned a conservative value of 0.1. The overall failure probability for load centers (060-#EEE-LDCNTRA-BUA-ROE and 060-#EEE-LDCNTRB-BUA-ROE) is 1.03E-05 and for diesel generators (26D-#EEY-ITSDG-A-#DG-RSS and 26D-#EEY-ITSDG-B-#DG-RSS) is 1.95E-04. These failure probabilities reflect the probability that the load center or diesel generator require service, and are further discussed in Attachment B.

E6.0.2.3.6 Summary of Preliminary Values for Cross-Cutting HFEs

Table E6.0-2 summarizes the preliminary values for the cross-group generic HFEs.

Table E6.0-2. Summarizing Preliminary Values for the Cross-group Generic HFEs

HFE ID	HFE Brief Description	Preliminary Value
Moderator	Operator Introduces Moderator Source in to Moderator-Controlled Areas of the CRCF	N/A
Load too Heavy	Operator attempts to lift load which is greater than crane rating	N/A
060-OpSDClose001-HFI-NOD	Operator Closes Shield Door on Conveyance	1.0
060-VCTO-DR00001-HFI-NOD	Operators Open 2 or More Vestibule Doors in CRCF	1E-02
060-VCTO-HFIA000-HFI-NOM	Human Error Exhaust Fan Switch Wrong Position	1E-01
060-VCTO-HEPALK-HFI-NOD	Operator Fails to Notice HEPA Filter Leak in Train A	1.0
060-#EEE-LDCNTRA-BUA-ROE 060-#EEE-LDCNTRB-BUA-ROE	Operator Fails to Restore Load Center Post Maintenance	1.03E-05
26D-#EEY-ITSDG-A-#DG-RSS 26D-#EEY-ITSDG-B-#DG-RSS	Operator Fails to Restore Diesel Generator to Service	1.95E-04

NOTE: CRCF = Canister Receipt and Closure Facility; HEPA = high-efficiency particulate air filter;
HFE = human failure event.

Source: Original

E6.1 ANALYSIS OF HUMAN FAILURE EVENT GROUP #1: RECEIPT OF SPENT NUCLEAR FUEL IN THE TRANSPORTATION CASK VESTIBULE AND MOVEMENT INTO THE CASK PREPARATION ROOM

HFE group #1 corresponds to the operations and initiating events associated with the ESD and HAZOP evaluation nodes listed in Table E6.0-1, covering receipt of a conveyance and movement into the Cask Preparation Room. The operations covered in this HFE group are shown in Figure E6.1-1. The activities covered in HFE group #1 begin where the railcar or truck trailer containing the transportation cask is just outside the door to the Transportation Cask Vestibule, just before the vestibule door is opened. It continues through the movement of the conveyance to its staging position in the Cask Preparation Room and ends when the mobile access platform (MAP) is in place around the conveyance.

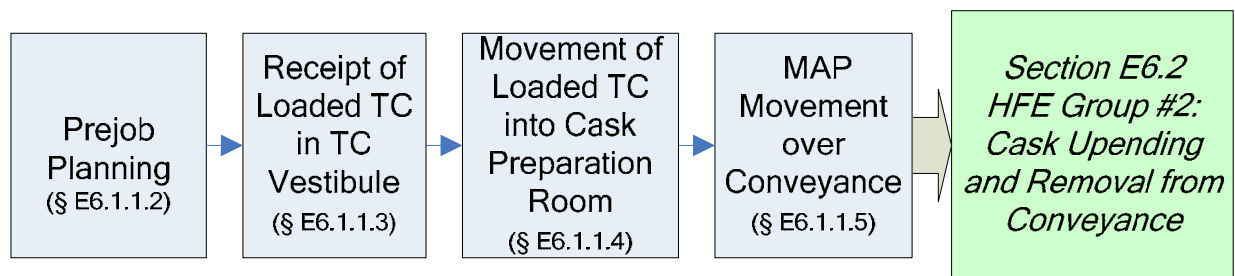

NOTE: § = Section; HFE = human failure event; MAP = mobile access platform; TC = transportation cask.

Source: Original

Figure E6.1-1. Activities Associated with HFE Group #1

E6.1.1 Group #1 Base Case Scenario

E6.1.1.1 Initial Conditions and Design Considerations Affecting the Analysis

The following conditions and design considerations were considered in evaluating HFE group #1 activities:

1. The conveyance is loaded with a transportation cask containing a transportation, aging, and disposal (TAD) canister, dual-purpose canister (DPC), or DOE canister (HLW/SNF) located outside the door to the CRCF Transportation Cask Vestibule.
2. The transportation cask is secured to the conveyance by tie-downs, with impact limiters surrounding the cask and a personnel barrier in place.
3. The railcar/truck trailer does not have speed governors or interlocks; the SPM does have a speed governor.
4. Wheel blocks are located at the end of the rail.

The following personnel are involved in this set of operations:

- Crewmember (two)
- PIC
- SPM operator.

Section E5.1.2 provides a more detailed description of the duties performed by each of these personnel.

E6.1.1.2 Prejob Plan

Before the transportation cask and conveyance reach the CRCF, a PIC is notified of the type of cask/conveyance to expect and how to process it. According to this information, the PIC determines the appropriate procedures and equipment to be used to process this cask type, and communicates this information to all the crew members involved in the processing of this cask. The PIC fills out a pre-lift safety checklist (Ref. E8.1.12) verifying that the equipment is properly staged and in proper operational condition. All crew members are properly trained and abide by the procedures of the facility.

E6.1.1.3 Receipt of Loaded Transportation Cask in the Transportation Cask Vestibule

Two crew members are at the Transportation Cask Vestibule. The railcar or truck trailer is pushed by a SPM (a diesel/electric vehicle with on board controls), and is driven by the SPM operator who is located in the cab of the SPM. When the railcar or truck trailer approaches the CRCF, the conveyance is visually inspected and one crew member opens the outside overhead door and the other crew member uses hand signals to direct the railcar or truck trailer into the Transportation Cask Vestibule, ensuring there are no vehicles or obstructions in the path. The crew members follow all relevant restrictions and procedures regarding railcar or truck trailer speed and direction of travel. Once the railcar or truck trailer has cleared the door, the first crew member closes the outside door.

E6.1.1.4 Movement of Loaded Transportation Cask into Cask Preparation Room

Once the railcar or truck trailer is in the Transportation Cask Vestibule, the inside overhead door is opened and the conveyance proceeds to the Cask Preparation Room and stops. A crew member sets the railcar or truck trailer brakes and chocks the wheels. The SPM detaches from the railcar or truck trailer and proceeds back to the Transportation Cask Vestibule. The inside overhead door is closed by a crew member. Closure of the inside door and setting the conveyance brakes are verified by checklist.

The inner and outer doors have an interlock that normally prevents both doors from being opened simultaneously; however, this interlock can be bypassed.

E6.1.1.5 MAP Movement over Conveyance

A crew member raises the MAP and moves it over the conveyance, positioning it for conveyance unloading activities.

E6.1.2 HFE Descriptions and Preliminary Analysis

This section defines and screens the HFEs that are identified for the base case scenario that can affect the probability of initiating events occurring, and that could lead to undesired consequences. Descriptions and preliminary analysis for the HFEs of concern during receipt of the railcar or truck trailer are summarized in Table E6.1-1. The analysis presented here includes the assignment of preliminary HEPs in accordance with the methodology described in Section E3.2 and Appendix E.III of this analysis. Section E4.2 provides details on the use of expert judgment in this preliminary analysis.

Table E6.1-1. HFE Group #1 Descriptions and Preliminary Analysis

HFE ID	HFE Brief Description	ESD	Preliminary Value	Justification
060-OpRCCollide1-HFI-NOD	<i>Operator Causes Low-Speed Collision between RC or TT and Facility SSCs:</i> Operator causes collision of railcar or truck trailer with facility structure or equipment while moving through the Transportation Cask Vestibule to the Cask Preparation Room, or operator of an auxiliary vehicle causes a collision of the auxiliary vehicle with the conveyance while the conveyance is parked in the Cask Preparation Room.	1	3E-3	In this step, the railcar or truck trailer moves into the Cask Preparation Room, passing through two doors. The railcar and truck trailer have the same failure modes and conditions for this step and therefore have the same preliminary values. There are three observers with clear visibility, the operation is simple, the travel distance is short, the conveyance (railcar or truck trailer) speed is low, and the operators are expected to perform this operation on a very regular (almost daily) basis. There are no interlocks, and it would be normal for an obstruction (e.g., door) to be in place during movement. The possibilities for collision involving a railcar/truck trailer are limited and include the following: <ul style="list-style-type: none"> • Improper motion (i.e., backward motion beyond the limit) could result in collision with the end stops, wall, or vestibule doors. • An improperly attached railcar/truck trailer could continue moving when the SPM stops, resulting in collision with the end stops, wall, or vestibule doors. • A forklift or other auxiliary vehicle could collide into the conveyance. The preliminary value was chosen based on the determination that this failure is “highly unlikely” (one in a thousand or 0.001) and was adjusted because there are several ways for a collision to occur, and there are potentially multiple other vehicles (forklifts) that can collide into the conveyance (×3). Also, in general, collisions were considered relatively more likely than drop events. The dominant contributor to this failure was assessed to be collision of a forklift into the conveyance.
060-OpTTCollide1-HFI-NOD		1	3E-3	
060-OpRCIntCol01-HFI-NOD	<i>Operator Causes High-Speed Collision between RC or TT and Facility SSCs:</i> Operator causes a collision of the railcar or truck trailer at a speed higher than design requirements. If the speed governor of the SPM fails, the operator could cause the railcar or truck trailer to collide into an SSC.	1	1.0	The operator can cause the SPM to over speed, resulting in a collision. In order to accomplish this, the speed governor must fail. To be conservative, all unsafe actions that require an equipment failure to cause an initiating event are assigned an HEP of 1.0.
060- OpTTIntCol01-HFI-NOD		1	1.0	
060-OpRCIntCol02-HFI-NOD	<i>Operator Causes MAP to Collide into RC or TT:</i> When the railcar or truck trailer is parked in the Cask Preparation Room and the operator normally moves the MAP over the conveyance. In this HFE, the operator fails to sufficiently raise the MAP and runs into the conveyance. The MAP has an anti-collision interlock which prevents movement of the platform if there is an obstruction in its path.	1	1.0	The operator can cause the MAP to collide into the railcar/truck trailer while moving it into position over the conveyance. In order to accomplish this, the MAP must be lowered, and the platform’s anti-collision interlock must fail. To be conservative, all unsafe actions that require an equipment failure to cause an initiating event are assigned an HEP of 1.0.
060-OpTTIntCol02-HFI-NOD		1	1.0	
060-OpTTRollover-HFI-NOD	<i>Operator Causes TT to rollover as it moves into the Cask Preparation Room:</i> Operator drives over a significantly uneven surface or jackknives while moving the truck trailer into the Cask Preparation Room, causing the truck trailer to roll over.	1	N/A	For a truck trailer to roll over, the center of mass has to shift laterally. This can be done by traversing a significantly uneven surface or running over a very large object. There are no significantly uneven surfaces in the CRCF Transportation Cask Vestibule/Cask Preparation Room; it is incredible for the truck to run over an object large enough necessary to shift its center of mass. The other mode of failure considered here is jackknifing the truck trailer. This failure mode was also seen as incredible because there is not enough room in the Transportation Cask Vestibule/Cask Preparation Room to physically cause the truck trailer to jackknife. The truck moves slowly and there are three observers, and if the truck and trailer were significantly out of alignment, the trailer might impact the building, but it won’t jackknife and roll over. Therefore, this HFE was omitted from analysis.
RC Derailment	<i>Operator Causes RC to Derail as It Travels to the Cask Preparation Room:</i> Operator causes railcar to derail as it travels into the Cask Preparation Room.	1	N/A ^a	In this step, the railcar moves from outside the facility, through the Transportation Cask Vestibule and into the Cask Preparation Room. During this travel, there is a probability that the railcar can derail, leading to a tipover of the railcar. This HFE was not explicitly quantified because the probability of derailment due to human failure is incorporated in the historical data used to provide a general failure probability for derailment. Documentation for this failure can be found in Attachment C.
060-OpSDClose001-HFI-NOD	<i>Operator Closes Shield Door on Conveyance:</i> The railcar or truck trailer passes through shield doors as it enters the Cask Preparation Room. During this transfer, the operator can close the shield door on the railcar or truck trailer.	7	1.0	The railcar or truck trailer passes through shield doors as it enters the Cask Preparation Room. During this transfer, the operator can cause the railcar or truck trailer to collide into the shield door or cause the shield door to close on the railcar or truck trailer. Cross-cutting HFE “Operator Causes Collision between Shield Door and Waste Conveyance” (Section E6.0.2.3.3) provides a justification of these preliminary values.

NOTE: ^a HRA value replaced by use of historic data.
HFE = human failure event; MAP = mobile access platform; RC = railcar; SPM = site prime mover; SSC = structure, system, or component; TT = truck trailer.

Source: Original

E6.1.3 Detailed Analysis

There are no HFEs in this group that require detailed analysis; the preliminary values in the facility model do not result in any Category 1 or Category 2 event sequences that fail to comply with the 10 CFR 63.111 performance objectives, therefore, the preliminary values were sufficient to demonstrate compliance with 10 CFR Part 63 (Ref. E8.2.1).

E6.2 ANALYSIS OF HUMAN FAILURE EVENT GROUP #2: CASK UPENDING AND REMOVAL FROM CONVEYANCE

HFE group #2 corresponds to the operations and initiating events associated with the ESD and HAZOP evaluation nodes listed in Table E6.0-1, which includes the upending of the cask and its transfer to the CTT. This process is shown in Figure E6.2-1. There are two types of casks handled in this process: (1) VTCs, which are transportation casks that are upended on the railcar and moved to the CTT, and (2) TTCs, which are casks that are upended on a tilting frame with an intermediate movement to a cask stand for removal of the impact limiters.

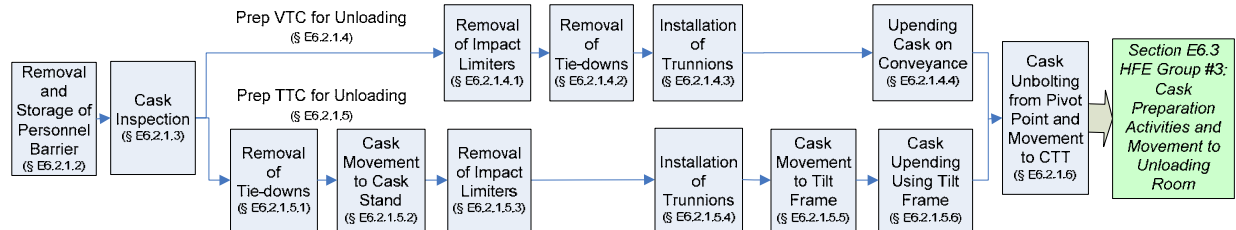

NOTE: §= section; CTT = cask transfer trolley; HFE = human failure event; TTC = a transportation cask that is upended using a tilt frame; VTC = a transportation cask that is upended on a railcar.

Source: Original

Figure E6.2-1. Activities Associated with HFE Group #2

E6.2.1 Group #2 Base Case Scenario

E6.2.1.1 Initial Conditions and Design Considerations Affecting the Analysis

The following conditions and design considerations were considered in evaluating HFE group #2 activities:

1. A railcar or truck trailer is parked in the Cask Preparation Room with brakes set and the transportation cask secure.
2. For DOE (short) casks, a cask pedestal is pre-staged in the CTT.
3. The MAP has an anti-collision interlock.
4. The cask handling crane (200-ton crane with 20-ton auxiliary hook) has the following safety features:
 - A. Upper limits—There are two upper limit marks: the initial is an indicator, and the final (which is set higher than the upper limit indicator) cuts off the power to the hoist. There is no bypass for the final limit interlock.
 - B. There are end-of-travel interlocks on the trolley and bridge.
 - C. There are speed limiters built into the motors.

- D. There is a weight interlock that cuts off power to the crane when the crane capacity is exceeded.
- E. There is a temperature interlock that cuts off power to the crane when the temperature is too high. An indicator comes on before this temperature is reached.
- F. There is an indicator to signal the operators that the cask handling yoke is fully engaged, and an interlock (yoke engagement) that prevents the crane from moving unless and the yoke is either fully engaged or disengaged..

Crane operations in this activity are not part of a specific procedure outlined in the YMP documentation, but rather reflect critical lift crane operations that are standard in the nuclear industry.

The following equipment is available for upending and transferring the cask:

1. Crane
 - A. 200-ton cask handling crane
 - B. 20-ton auxiliary hook
2. Lift fixtures
 - A. Impact limiter lifting device (uneven slings)
 - B. Personnel barrier lifting device (sling)
 - C. Cask sling (for TTCs)
 - D. Yoke (adjustable, for all casks)
3. Common tools and platform.

The following personnel are involved in this set of operations:

- Crane operator
- Signaling crew member
- Verification crew member
- Radiation protection worker⁹
- Supervisor.

Section E5.1.2 provides a more detailed description of the duties performed by each of these personnel.

⁹The radiation protection worker, or health physicist, is not mentioned specifically in each step of this operation; however, there is always at least one radiation protection worker present during this step.

E6.2.1.2 Removal and Storage of Personnel Barrier (if required)

Most personnel barriers are removed at the geologic repository operations area entrance; however, this facility retains the capacity to remove personnel barriers if necessary. In order to remove the personnel barrier from the transportation cask, the crew members must first unbolt the barrier from the cask. The crane operator retrieves the crane and removes the personnel barriers as follows:

Alignment of Crane to Personnel Barrier—The crane operator lowers the 20-ton auxiliary crane into position over the personnel barrier. The operator is positioned on the floor in view of the crew members on either side of the personnel barrier. A signaling crew member next to the personnel barrier uses hand signals to guide the crane operator (no hardwired or wireless communication system is used). A verification crew member on the opposite side of the personnel barrier checks the alignment of the crane. The verification crew member can only signal to stop the crane. Once positioned, a crew member connects the crane to the personnel barrier using the personnel barrier lifting device, which is expected to be a sling. In order to use a sling, a crew member must secure the sling around the personnel barrier, attach the sling to the crane, and ensure that, when lifted, the load is level. If the sling is not positioned and the load is not level, the signaling crew member signals the crane operator to stop and lower the personnel barrier so that the sling can be repositioned.

Vertical Lifting of the Personnel Barrier—Upon signal from the signaling crew member that all is well, the crane operator begins to raise the personnel barrier. Once the personnel barrier has been raised (i.e., is hanging free) to the proper height (based on visual inspection), the crane operator stops raising the personnel barrier. The crane operator clears the railcar/truck trailer and then lowers the personnel barrier to the movement height. This action is confirmed by hand signals from the signaling crew member. The proper height for movement is roughly 6 in. above the highest obstacle in the movement path.

Movement of Personnel Barrier to Staging Location—The crane operator moves the 20-ton auxiliary crane to locate the personnel barrier over the position where it is lowered in the staging area, following the indicated safe load path marked on the floor. The crane operator performs this task visually and also receives confirmatory hand signals from the signaling crew member. The crane operator can roughly align the crane, but final alignment is directed by the signaling crew member.

Lowering of Personnel Barrier and Disengagement of the Sling—When properly positioned in the staging area and the placement area is clear, the signaling crew member signals the crane operator to lower the personnel barrier. The crane operator then proceeds to lower the personnel barrier at or below the maximum allowable speed. Once the personnel barrier is stable on the floor of staging area, a crew member disengages the sling and the crane operator lifts the crane in preparation for the next operation.

E6.2.1.3 Cask Inspection

Once the conveyance is parked in the facility and the personnel barriers have been removed, the crew visually inspects and conducts radiological surveys of the exterior of the cask.

E6.2.1.4 Preparation of VTC for Transfer to the CTT

As illustrated in Figure E6.2-1, the upending processes for the two cask types are very similar, but not identical. At this point the processes for preparing the two types of casks for upending diverge. The VTC is discussed first, followed by a similar discussion for the TTC in Section E6.2.1.5. For a VTC, the cask is upended while on the conveyance.

E6.2.1.4.1 Removal and Storage of Impact Limiters

This section describes the removal and staging of impact limiters using the 20-ton auxiliary crane with standard rigging, common tools, and the MAP. This step is performed twice, as each cask has two impact limiters.

Crew members, working with the crane operator, attach the impact limiter lifting device (uneven slings) to the 20-ton auxiliary crane.

After the personnel barrier is removed and the cask is inspected, the crew removes and stores the impact limiters. This operation is performed on the conveyance with training and procedures. The first step is to remove the restraining bolts on the impact limiters. Depending on the cask type, there can be anywhere from 24 to 36 bolts to remove, with several crew members removing the bolts simultaneously. Once removed, the bolts are counted, and the crew supervisor uses a checklist to verify and document bolt removal. Once bolt removal is verified, the crane operator removes and stores the impact limiters using the 20-ton auxiliary hook on the cask handling crane as follows:

Movement of Crane to Impact Limiter Position—The crane operator positions the crane over the impact limiter, following the indicated safe load path marked on the floor. The crane operator performs this task visually and also receives confirmatory hand signals from the signaling crew member. The crane operator can roughly align the crane, but final alignment is directed by the signaling crew member.

Alignment of Crane to Impact Limiter—The crane operator lowers the crane into position over the impact limiter. The crane operator is positioned on the floor in view of the crew members on either side of the impact limiter. A signaling crew member, next to the impact limiter, uses hand signals to guide the movement of the crane operator (no hardwired or wireless communication system is used). There is a verification crew member on the opposite side of the impact limiter, checking alignment of the crane. The verification crew member can only signal the crane operator to stop. Once positioned, a crew member connects the crane to the impact limiter using the uneven sling and integral lift points.

Vertical Lifting of the Impact Limiter—Upon signal from the signaling crew member, the crane operator ensures the impact limiter is free of the transportation cask (this may include moving the impact limiters horizontally to free them) and then begins to raise the impact limiter. Once the impact limiter has been raised (i.e., is hanging free) such that it has cleared the conveyance, the crane operator stops raising the impact limiters. The crane operator bases this on a visual inspection and is confirmed by hand signals from the signaling crew member. Once past the conveyance, the crane operator lowers the impact limiter to the proper height for

movement. The proper height for movement is roughly 6 in. above the highest obstacle in the movement path. The crane operator bases this height estimation on a visual inspection, confirmed by hand signals from the signaling crew member.

Movement of Impact Limiter to Staging Area—The crane operator moves the crane so as to locate the impact limiter over the position where it should be lowered in the staging area, following the indicated safe load path marked on the floor. The crane operator performs this task visually and also receives confirmatory hand signals from the signaling crew member. The crane operator can roughly align the crane, but final alignment is directed by the signaling crew member.

Lowering of Impact Limiter and Disengagement of the Sling—When properly positioned and the placement area is clear, the signaling crew member signals the crane operator to lower the impact limiter. The crane operator then proceeds to lower the impact limiter at or below the maximum allowable speed. Once the impact limiter is lowered, a crew member disengages the sling, and the crane operator lifts the crane to the maximum height in preparation for the next operation.

E6.2.1.4.2 Removal of Tie-downs

Tie-downs are removed to secure the transportation cask to the conveyance using the MAP for access. Once the impact limiters are removed, the crew removes the cask tie-downs in preparation to lift the transportation cask off the conveyance. This operation is done on the conveyance according to written procedures. The crew removes all the bolts of the tie-down, with four crew members removing the bolts simultaneously. Once removed, the bolts are counted, and the crew supervisor checks off bolt removal. Once bolt removal is verified, the crane operator (using a 200-ton crane with yoke) can proceed to lift the cask if there are trunnions on the cask; if not, then the crew must install trunnions on the cask.

E6.2.1.4.3 Installation of Trunnions (if required)

Trunnions (if required) are installed onto the cask by using common tools, standard rigging, cask handling crane (auxiliary hook), and the MAP.

Crew members retrieve the trunnions to be installed. Trunnions are located in a package on the conveyance. If required, the 20-ton auxiliary crane is used to place the trunnions in the proper position. Crew members secure the trunnions according to training.

E6.2.1.4.4 Upending Transportation Cask on the Conveyance

The transportation is upended cask using the 200-ton cask handling crane with yoke.

Prior to attempting to upend the transportation cask on the conveyance, the crew members must properly attach the yoke to the 200-ton cask handling crane. Once that is done, the crew can proceed to initiate the upending.

Movement of Crane to Transportation Cask—The operator positions the crane over the transportation cask, following the indicated safe load path marked on the floor. The operator

performs a visual check, and also receives confirmatory hand signals from the signaling crew member. The crane operator can roughly align the crane, but final alignment is directed by the signaling crew member.

Alignment of Crane to Cask—The crane operator lowers the crane into position so that the yoke arms are lined up with the trunnion. The crane operator is positioned on the floor in view of the crew members on either side of the cask. There is a signaling crew member next to the cask using hand signals to guide the operator’s movement (no hardwired or wireless communication system is used). There is a verification crew member on the opposite side of the cask, checking alignment of the second trunnion. This worker can only signal the crane operator to stop.

Yoke Arms Engaged on Trunnions—Once the yoke is aligned, the signaling crew member signals the operator to close the yoke arms. The crew members check to see that the yoke arms have attained at least the minimum amount of engagement (minimum distance from edge of trunnion to edge of yoke arm). If the arms are sufficiently engaged on both sides, the crane operator knows by an indicator on the controller, and the signaling crew member signals the operator to raise the crane a slight amount to put pressure on the arms. The crane operator sees on the controller that the crane is bearing weight. Both crew members verify that the yoke remains level. If the arms do not engage on the initial attempt, either crew member signals to the operator to stop, and the crane operator sets the cask down and opens the yoke arms to disengage. The signaling crew member then directs movement of the crane (again with hand signals) to compensate and then signals the operator to close the yoke arms.

Vertical Positioning of Cask—Upon receiving a signal from the signaling crew member, the crane operator begins to raise the cask. Since the bottom of the cask remains stationary, the operator moves the crane to remain directly above the upper trunnions (i.e., to keep the cables straight). The operator performs this task visually. The operator also gets hand signals from the signaling crew member that the cask is “upending” properly. Once the cask is fully upright, the crane operator stops raising the cask. The crane operator bases this on a visual inspection, confirmed by hand signals from the signaling crew member.

This ends the discussion of upending a VTC. Section E6.2.1.5 discusses the process of upending a TTC, which includes an intermediate transfer to a cask preparation stand. Once the cask (VTC or TTC) is upright, it is then freed from its pivot point and moved to the CTT (Section E6.2.1.6).

E6.2.1.5 Preparation of a TTC for Transfer to the CTT

As illustrated in Figure E6.2-1, the upending process for a VTC and TTC are very similar, but not identical. The upending process for a TTC requires that the cask be removed from the conveyance and upended using a tilting frame with an intermediate transfer to a cask stand. This process is described in this section.

E6.2.1.5.1 Removal of Tie-downs

Crew members remove transportation cask tie-downs using common tools and handling equipment and the MAP. This step is identical to Section E6.2.1.4.2.

Once the impact limiters are removed, the crew removes the cask tie-downs in preparation to lift the transportation cask off the conveyance. This operation is done on the conveyance, according to training. The crew removes all the bolts of the tie-down, with several crew members removing the bolts simultaneously. Once removed, the bolts are counted, and the crew supervisor checks off bolt removal. Once bolt removal is verified, the crane operator (using the 200-ton cask handling crane with cask sling) proceeds to lift the cask.

E6.2.1.5.2 Movement of Transportation Cask with Impact Limiters to Cask Stand

In this step the crane operator moves the transportation cask with impact limiters attached to the cask stand using the 200-ton cask handling crane with standard rigging. Prior to this step the cask stand is pre-staged in the appropriate place, the slings used to move the personnel barrier are removed from the crane, and the cask sling is attached to the crane.

Crane Movement to Transportation Cask—The crane operator moves the 200-ton cask handling crane so as to locate the crane over the transportation cask, following the indicated safe load path marked on the floor. The operator does this visually and also receives confirmatory hand signals from the signaling crew member. The crane operator can roughly align the crane, but final alignment is directed by the signaling crew member.

Crane Alignment to Cask and Engagement of Sling—The crane operator lowers the crane into position so that the crew members can place the sling around the cask. Once in position, the crew members place the sling around the cask and shackle it to the crane. The supervisor verifies, via checklist, that the sling is properly attached. The crane operator is positioned on the floor in view of the crew members on either side of the cask. There is a signaling crew member next to the cask who uses hand signals to guide the operator's movement (no hardwired or wireless communication system is used). There is a verification crew member on the opposite side of the cask, checking the placement of the sling. The verification crew member can only signal the crane operator to stop. Once the sling is secured around the cask, the crane operator initiates the lift, and the crew members ensure that, when lifted, the load is level. If the sling is not positioned properly and the load is not level, either crew member signals the crane operator to stop and lower the cask so that the sling can be repositioned.

Vertical Lifting of Cask—The signaling crew member signals the crane operator to lift the cask. The crane operator lifts the cask vertically until it clears the conveyance. The crane operator bases this on a visual inspection, confirmed by hand signals from the signaling crew member. Once the transportation cask is past the conveyance, the crane operator lowers the cask to the proper height for movement. The proper height for movement is defined as roughly 6 in. above the highest obstacle in the movement path. The crane operator determines the proper height based on visual inspection, confirmed by hand signals from the signaling crew member.

Cask Positioning over the Cask Stand—The operator moves the 200-ton cask handling crane so as to locate the cask over the cask stand, following the indicated safe load path marked on the floor. The operator determines the path visually and also receives confirmatory hand signals from the signaling crew member. The crane operator can roughly align the crane, but final alignment is directed by the signaling crew member. Once aligned, the signaling crew member signals the crane operator to lower the cask. The crane operator lowers the cask, and then the

crew members, ensuring stable placement, detach the slings from the crane. The crane operator then lifts the crane to the appropriate height for movement, confirmed by the signaling crew member. The proper height for movement is defined as roughly 6 in. above the highest obstacle in the movement path. The crane operator, guided by the signaling crew member, moves the crane to the cask sling stand, where the crew member removes the cask sling.

E6.2.1.5.3 Removal of Impact Limiters from Cask while on Cask Stand

The removal of impact limiters is identical to the operations discussed in Section E6.2.1.4.1, other than that the impact limiter removal occurs on the cask pedestal.

Impact limiters are removed using the 20-ton auxiliary crane with standard rigging, common tools, and the cask access platform. This step is performed twice because each cask has two impact limiters.

In preparation for this step, the crew members and crane operator attach the impact limiter lifting device (uneven slings) to the 20-ton auxiliary crane.

Once the cask is positioned on the cask stand, the crew removes and stores the impact limiters. This operation is done on the cask stand according to training. The first step is to remove the restraining bolts on the impact limiters. Depending on the cask type, there can be anywhere from 24 to 36 bolts to remove, with several crew members removing the bolts simultaneously. Once removed, the bolts are counted, and the crew supervisor checks off bolt removal from the checklist. Once bolt removal is verified, the crane operator (using a 20-ton crane with auxiliary hook) removes and stores the impact limiters.

Positioning Crane over Impact Limiter—The crane operator positions the crane over the impact limiter, following the indicated safe load path marked on the floor. The crane operator performs this task visually and also receives confirmatory hand signals from the signaling crew member. The crane operator can roughly align the crane, but final alignment is directed by the signaling crew member.

Crane Alignment with Impact Limiter—The crane operator lowers the crane into position over the impact limiter. The crane operator is positioned on the floor in view of the crew members on either side of the impact limiter. There is a signaling crew member next to the impact limiter who uses hand signals to guide the crane operator's movements (no hardwired or wireless communication system is used). There is a verification crew member on the opposite side of the impact limiter, checking alignment of the crane. The verification crew member can only signal the crane operator to stop. Once positioned, one of the crew members connects the crane to the impact limiter using the uneven sling and integral lift points.

Vertical Lifting of Impact Limiter—Upon signal from the signaling crew member, the crane operator ensures that the impact limiter is free of the transportation cask (this may include moving the impact limiters horizontally to free them) and then begins to raise the impact limiter. Once the impact limiter has been raised (i.e., is hanging free) such that it has cleared the cask stand, the crane operator stops raising the impact limiters. The crane operator bases this on a visual inspection, and this is confirmed by hand signals from the signaling crew member. Once

past the cask stand, the crane operator lowers the crane to the proper height for movement. The proper height for movement is roughly 6 in. above the highest obstacle in the movement path. The crane operator determines the proper height based on a visual inspection, confirmed by hand signals from the signaling crew member.

Impact Limiter Positioning for Lowering—The crane operator moves the crane to locate the impact limiter over the position where it should be lowered in the staging area, following the indicated safe load path marked on the floor. The crew member does this visually and also receives confirmatory hand signals from the signaling crew member. The crane operator can roughly align the crane, but final alignment is directed by the signaling crew member.

Impact Limiter Lowering and Disengagement—When properly positioned and the placement area is clear, the signaling crew member signals the crane operator to lower the impact limiter. The crane operator lowers the impact limiter at or below the maximum allowable speed. Once the impact limiter is lowered, a crew member disengages the sling, and the crane is lifted to the maximum height in preparation for the next operation.

E6.2.1.5.4 Installation of Trunnions (if required)

Trunnions (if required) are installed onto the cask by using common tools, standard rigging, the cask handling crane (auxiliary hook), and the MAP. This step is identical to Section E6.2.1.4.3.

Crew members retrieve the trunnions to be installed. Trunnions are located in a package on the conveyance. If required, the 20-ton auxiliary crane is used to place the trunnions in the proper position. Crew members secure the trunnions according to training.

E6.2.1.5.5 Transportation Cask Movement to Cask Tilting Frame

In preparation for this step, the cask tilting frame is pre-staged in the preparation area. It is possible the cask stand is an integral component with the tilting frame, however, for this analysis they are considered separate entities, and the extra sling lift is required.

Transportation Cask Movement and Placement onto Tilting Frame—Once the tilting frame is in place and the impact limiters removed, the crane operator and crew members retrieve and attach the cask sling to the 200-ton cask handling crane.

Crane Alignment to Cask—The crane operator lowers the 200-ton cask handling crane into position so that the slings can be attached to the crane. The crane operator is positioned on the floor in view of the crew members on either side of the cask. There is a signaling crew member next to the cask who uses hand signals to guide the operator's movements (no hardwired or wireless communication system is used). There is a verification crew member on the opposite side of the cask, checking alignment of the second trunnion. The crew member signals the crane operator to stop. Once in position, the other crew members attach the sling to the crane and ensure that, when lifted, the load is level. If the sling is not positioned and the load is not level, the signaling crew member signals the crane operator to stop and lower the object so that the sling can be repositioned.

Vertical Lifting of the Cask—Upon signal from the signaling crew member, the crane operator begins to raise the cask. Once the cask is raised to roughly 6 in. above the cask stand, the crane operator stops raising the cask, based on a visual inspection and confirmation by hand signals from the signaling crew member. The crane operator clears the cask stand and lowers the crane to the proper height for movement. The crane operator bases this on a visual inspection and a confirmatory hand signals from the signaling crew member. The proper height for movement is defined as roughly 6 in. above the highest obstacle in the movement path.

Cask Positioning for Lowering—The crane operator moves the crane to position the cask over the tilting frame, following the indicated safe load path marked on the floor. The crane operator does this visually and also receives confirmatory hand signals from the signaling crew member. The crane operator can roughly align the crane, but final alignment is directed by the signaling crew member.

Cask Lowering and Disengagement of Sling—When properly positioned and the placement area is clear, the signaling crew member signals the crane operator to lower the cask onto the tilting frame. The crane operator proceeds to lower the cask at or below the maximum allowable speed. Once the cask is lowered and stable, a crew member disengages the sling, and the crane operator lifts the crane in preparation for the next operation.

Once the cask is on the tilting frame, the crew secures the transportation cask to the tilting frame using common tools and the cask handling platform. This step is guided by a procedure and is verified by a supervisor signature on a checklist before the cask is upended.

E6.2.1.5.6 Upending Transportation Cask Using Cask Tilting Frame

The transportation cask is upended using the tilting frame and 200-ton cask handling crane with yoke.

Once the cask is placed on the tilting frame, the crane operator and crew members place the cask sling on its stand and retrieve and attach the yoke. Once that is done, the crew proceeds to initiate the upending.

Crane Positioning over the Transportation Cask—The operator positions the crane over the transportation cask, following the indicated safe load path marked on the floor. The crane operator performs this task visually and also receives confirmatory hand signals from the signaling crew member. The crane operator can roughly align the crane, but final alignment is directed by the signaling crew member.

Crane Alignment with Cask—The crane operator lowers the crane into position so that the yoke arms are lined up with the trunnions. The crane operator is positioned on the floor in view of the crew members on either side of the cask. There is a signaling crew member next to the cask using hand signals to guide the operator's movement (no hardwired or wireless communication system is used). There is a verification crew member on the opposite side of the cask, checking alignment of the second trunnion. The verification crew member can only signal the crane operator to stop.

Engagement of Yoke Arms on Trunnions—Once the yoke is aligned, the signaling crew member signals the operator to close the yoke arms. Crew members check to see that the yoke arms have attained at least the minimum amount of engagement (minimum distance from edge of trunnion to edge of yoke arm). The crane operator knows if the arms are sufficiently engaged on both sides by an indicator on the controller, and the signaling crew member signals the operator to raise the crane a slight amount to put pressure on the arms. The crane operator can see on the controller that the crane is bearing weight. Crew members verify that the yoke remains level. If the arms do not engage on the initial attempt, either crew member signals the operator to stop, and the crane operator sets the cask down and opens the yoke arms to disengage. The signaling crew member then directs movement of the crane (again with hand signals) to compensate, and then signals the operator to close the yoke arms.

Vertical Positioning of Cask—Upon signal from the signaling crew member, the crane operator begins to raise the cask. Since the bottom of the cask remains stationary, the operator moves the crane to remain directly above the upper trunnions (i.e., to keep the cables straight). The crane operator visually performs this task and gets hand signals from the signaling crew member that the cask is “upending” properly. Once the cask is fully upended, the crane operator stops raising the cask, basing this on a visual inspection, confirmed by hand signals from the signaling crew member.

E6.2.1.6 Cask Unbolting from Pivot Point and Movement to CTT (both Variations)

Once upended, the cask is released from its pivot point and moved to the CTT using the cask handling crane. This step is the same for both VTCs and TTCs.

Cask Unbolting from Pivot Point—Without detaching the crane from the cask, the crew uses common tools and the MAP to unbolt the constraints on the bottom half of the cask or to remove the constraints from the tilting frame so the cask can be lifted. This step is verified.

Vertical Lifting of Cask—Once the cask is upended and unconstrained, the signaling crew member signals the crane operator to lift the cask vertically. The crane operator lifts the cask vertically until it reaches the proper height for movement, basing this on a visual inspection, confirmed by hand signals from the signaling crew member. The proper height for movement is defined as roughly 6 in. above the highest obstacle in the movement path. This requires the crane operator to clear the cask from the conveyance/tilting frame before lowering the cask to movement height.

Cask Positioning over CTT—The crane operator moves the crane to position the cask over the CTT, following the indicated safe load path marked on the floor. The crane operator does this visually and also receives confirmatory hand signals from the signaling crew member. The crane operator can roughly align the crane, but final alignment is directed by the signaling crew member since the operator’s view of the alignment “ring” on the CTT is obstructed. Once properly positioned, the signaling crew member signals the crane operator to lower the cask onto the CTT. The crane operator lowers the cask and, with the confirmation of the signaling crew member, disengages the yoke and lifts the crane to proper moving height.

Securing the Transportation Cask to the CTT—Once the cask is properly loaded, the crew member(s) secures the transportation cask to the CTT, which is like a cage that locks into position. There may be bumpers installed prior to closing the CTT door. This step is defined in training and must be signed off via a checklist prior to movement of the CTT.

E6.2.2 HFE Descriptions and Preliminary Analysis

This section defines and screens the HFEs that are identified for the base case scenario, that can affect the probability of initiating events occurring, and that could lead to undesired consequences. Descriptions and preliminary analysis for the HFEs of concern during cask upending and removal are summarized in Table E6.2-1. The analysis presented here includes the assignment of preliminary HEPs in accordance with the methodology described in Section E3.2 and Appendix E.III; Section E4.2 provides details on the use of expert judgment in this preliminary analysis.

Table E6.2-1. HFE Group #2 Descriptions and Preliminary Analysis

HFE ID	HFE Brief Description	ESD	Preliminary Value	Justification
Crane drops	<i>Operator Drops Cask during Upending and Removal:</i> To upend a cask and move it into the CTT, the operator must lift the cask using the cask handling crane. TTCs must be lifted three times: once to the cask stand using a sling, once to the tilting frame using a sling, and once to upend the cask and move it to the CTT using the yoke. VTCs only require one lift, using the cask handling yoke to upend the cask and move it to the CTT. During these lifts, the operator can cause the cask to drop by improperly engaging the sling or yoke, two-blocking the cask, or other such failures.	3	N/A ^a	In this step the operator uses the cask handling crane and auxiliary hook to move the cask and other heavy objects. All casks have one cask lift, using the cask handling crane with cask handling yoke; TTCs have two additional cask lifts, using the cask handling crane with sling. There are three heavy-object lifts (a personnel barrier and two impact limiters) using the auxiliary hook and slings. Each of these lifts can potentially result in a drop. These HFEs were not explicitly quantified because the probability of a crane drop due to human failure is incorporated in the historical data used to provide general failure probabilities for drops involving various crane/rigging types. Documentation for this failure can be found in Attachment C.
	<i>Operator Drops Object on Cask during Upending and Removal:</i> To upend a cask and move it into the CTT, the operator must lift several heavy objects over the cask using the cask handling crane auxiliary hook and standard rigging. These objects include the personnel barrier and the two impact limiters. During these lifts, the operator can drop the object onto the cask by improperly connecting the object to the crane, two-blocking the object, or other such failures.	3	N/A ^a	
060-OpTCImpact01-HFI-NOD	<i>Operator Causes an Impact between Cask and SSC during Upending and Removal:</i> While performing crane operations, the operator can impact the cask in the following ways: <ul style="list-style-type: none"> - Impact cask while moving object with crane - Impact cask with crane hook - Collide cask into SSC while moving cask with crane - Mobile access platform lowers into cask - Bridge or trolley impacts end stop. 	3	3E-03	In this step the cask is moved from the conveyance ultimately to the CTT. For crane operations in this step, there are three observers with clear visibility, the operations are simple, the travel distances are short, the crane speed is slow, the crew is well trained, and the operators are expected to perform these operations on a very regular (daily) basis. There are no interlocks to prevent this error. The dominant contributors to the impact of a cask include the following: <ul style="list-style-type: none"> - Crane moved outside its safe load path (e.g., operators cut corners) - Crane moved in wrong direction - Operator failed to maintain proper vertical and horizontal distance between cask and SSCs during crane operations - Mobile access platform lowered into cask - Bridge or trolley impacts end stop. <p>The operator must manually maintain movement within the safe load path. It is not unlikely that the operator would stray slightly from that path or that an object would be slightly within that path. However, the crane operations are very slow and within clear, direct view of three observers. The likelihood of impacting a cask was assessed to be comparable to the railcar collision HFE (060-OpRCCollide1-HFI-NOD; Section E6.1, HFE Group #1) and was accordingly assigned the same preliminary value with the same rationale: the preliminary value was chosen based on the determination that this failure is “highly unlikely” (one in a thousand or 0.001) and was adjusted because there are several ways for an impact to occur (×3).</p>
060-OpSpurMove01-HFI-NOD	<i>Operator Causes Spurious Movement of the CTT while Cask Is Loaded into the CTT:</i> The CTT is supposed to be deflated, with the control pendant stored during this operation. However, if the CTT is not in the proper configuration for loading, the operator can inadvertently cause the CTT to move. If this spurious movement occurs while the cask is being lowered into the CTT, the result is an impact to the cask.	3	1E-04	In this step the CTT is sitting in the Cask Preparation Room ready to be loaded with a cask; the CTT is deflated, with the control pendant stored. For operations in this step, there are three observers with clear visibility, the operations are simple, the crane speed is slow, the crew is well trained, and the operators are expected to perform these operations on a very regular (daily) basis. This error was considered to be extremely unlikely (0.0001) because it requires multiple human errors: it would require the CTT to be left inflated, the observers (i.e., the crane operator, two crew members or the radiation protection worker) would have to fail to notice or fail to stop operations and deflate the CTT, and an operator would have to access the pendant and signal the CTT to move.
060-OpTipover001-HFI-NOD	<i>Operator Causes Cask to Tip over:</i> If the crane rigging is attached to the cask, RC, TT, or CTT, either accidentally or purposefully, and the crane or conveyance moves, the cask can potentially tip over. The following are contributors to this HFE: <ul style="list-style-type: none"> - Crane hook, grapple, or rigging catches conveyance/cask - Horizontal movement with hook lowered and attached to cask - Crane travels in wrong direction - Cask not lifted high enough to clear conveyance. 	3	1E-04	In this step there are several crane operations using both the cask handling crane and the auxiliary crane. For crane operations in this step, there are three observers with clear visibility, the operations are simple, the travel distances are short, the time the cask is vertical is short, the crane speed is slow, the crew is well trained, and the operators are expected to perform these operations on a very regular (daily) basis. There are no interlocks to prevent this error. The contributors to cask tipover include the following: <ul style="list-style-type: none"> - Crane hook, grapple, or rigging catches conveyance/cask. - Horizontal movement with hook lowered and causes hook to attach to cask. - Crane travels in wrong direction. - Cask not lifted high enough to clear conveyance. <p>The dominant contributor is the crane hook catching the cask. While it may be unlikely (0.01) that a stray hook or grapple might be hanging from the crane, it would still need to catch on the cask securely enough to pull it over (0.1), and then the cask tipping would have to go unnoticed by all three observers. This is done in an open area with direct observation, and tipover is a slow process; therefore, the value was adjusted by a further 0.1.</p>

Table E6.2-1. HFE Group #2 Descriptions and Preliminary Analysis (Continued)

HFE ID	HFE Brief Description	ESD	Preliminary Value	Justification
060-OpCollide001-HFI-NOD	<i>Operator Causes Low-Speed Collision with RC, TT, CTT, or TTC:</i> Operator can cause an auxiliary vehicle to collide into a loaded RC, TT, or CTT while the conveyance is parked in the Cask Preparation Room. The operator can also cause the auxiliary vehicle to collide directly into a TTC while it is on the cask stand or in the tilting frame. If the speed governor of the auxiliary vehicle is properly functioning, it is a low-speed collision.	3	3E-03	In this step the cask is in several positions that are vulnerable to impact via collision: <ul style="list-style-type: none"> - The railcar or transfer trailer is parked in the Cask Preparation Room, loaded with a cask. - The CTT is parked in the Cask Preparation Room, loaded with a cask. - The TTC is on the cask stand or tilting frame on the floor of the Cask Preparation Room. Throughout this scenario there are three observers with clear visibility, the speed of auxiliary vehicles is low, the conveyance or cask is stationary and very visible. Procedural controls are expected to limit the number of other vehicles in the Cask Preparation Room during cask operations. The railcar and transfer trailer have their brakes set, and the CTT is deflated, so they cannot move to collide into something; however, if operators failed to set the brakes of the railcar or transfer trailer or failed to deflate the CTT, it is unlikely these conveyances, while loaded with a cask, would move significantly. As a result, the most likely possibility for a collision involving a cask is limited to collisions with forklifts or other auxiliary vehicles. This HEP was assigned the same preliminary value as railcar collision HFE (060-OpRCCollide1-HFI-NOD; Section E6.1, HFE Group #1) because the dominant mechanism of both failures is collision with an auxiliary vehicle. In this case, the screening value is conservative because the railcar or transfer trailer collision HFE has additional failure modes associated with movement of the SPM that are not applicable here.
060-OpFLCollide1-HFI-NOD	<i>Operator Causes High-Speed Collision of Loaded Conveyance or Cask with Auxiliary Vehicle:</i> Operator can cause an auxiliary vehicle to collide into a loaded RC, TT, or CTT while the conveyance is parked in the Cask Preparation Room. The operator can also cause the auxiliary vehicle to collide directly into a TTC while it is on the cask stand or in the tilting frame. If the collision is due to the auxiliary vehicle speed governor malfunctioning, it is a high-speed collision.	3	1.0	The operator can cause an auxiliary vehicle (e.g., forklift) to overspeed, resulting in collision with the railcar, transfer trailer, CTT, or TTC. In order to accomplish this, the speed governor of the colliding vehicle must fail. To be conservative, unsafe actions that require an equipment failure to cause an initiating event are generally assigned an HEP of 1.0.

NOTE: ^a HRA value replaced by use of historic data (Attachment C).

CTT = cask transfer trolley; ESD = event sequence diagram; HEP = human error probability; HFE = human failure event; ID = identification; N/A = not applicable; RC = railcar; SPM = site prime mover; SSC = structure, system, or component; SSCs = structures, systems, and components; TT = truck trailer; TTC = a transportation cask that is upended using a tilt frame; VTC = a transportation cask that is upended on a railcar.

Source: Original

E6.2.3 Detailed Analysis

There are no HFEs in this group that require detailed analysis; the preliminary values in the facility model do not result in any Category 1 or Category 2 event sequences that fail to comply with the 10 CFR 63.111 performance objectives; therefore, the preliminary values were sufficient to demonstrate compliance with 10 CFR Part 63 (Ref. E8.2.1).

E6.3 ANALYSIS OF HUMAN FAILURE EVENT GROUP #3: CASK PREPARATION AND MOVEMENT TO CASK UNLOADING ROOM

HFE group #3 corresponds to the operations and initiating events associated with the ESD and HAZOP evaluation nodes listed in Table E6.0-1, covering cask preparation activities and movement of the cask to the Cask Unloading Room. The operations covered in this HFE group are shown in Figure E6.3-1. This operation starts with the transportation cask upright and secured in the CTT. During this operation the cask undergoes gas sampling, equalization, and other preparation activities necessary to leave the Cask Preparation Room. All casks have their lid bolts removed and a lid lift fixture installed, but DPCs also have the cask lid removed and a canister lift fixture installed onto the DPC. Once the preparation activities are complete, the crew moves the transportation cask from the Cask Preparation Room to the Cask Unloading Room and positions the cask under the cask port, ready for CTM operations. This operation ends at this point, prior to any CTM activities.

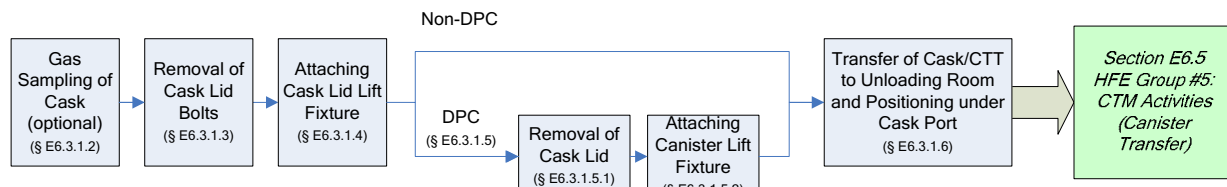

NOTE: § = section; CTM = canister transfer machine; CTT = cask transfer trolley; DPC = dual-purpose canister; HFE = human failure event.

Source: Original

Figure E6.3-1. Activities Associated with HFE Group #3

E6.3.1 Group #3 Base Case Scenario

E6.3.1.1 Initial Conditions and Design Considerations Affecting the Analysis

The following conditions and design considerations were considered in evaluating HFE group #3 activities:

1. The transportation cask is intact and secure in the CTT.
2. The cask handling crane (200-ton and 20-ton) has the following safety features:
 - A. Upper limits—There are two upper limit marks: the initial is an indicator, and the final (which is set higher than the upper limit indicator) cuts off the power to the hoist. There is no bypass for the final limit interlock.
 - B. There are end-of-travel interlocks on the trolley and bridge.
 - C. There are speed limiters built into the design of the motors.
 - D. There is a weight interlock that cuts off power to the hoist when the crane capacity is exceeded.

- E. There is a temperature interlock that cuts off power to the hoist when the temperature is too high; an indicator comes on before this temperature is reached.
- F. There is an indicator to signal the operators that the cask handling yoke is fully engaged, and an interlock (yoke engagement) that prevents the crane from moving unless and the yoke is either fully engaged or disengaged..

Crane operations in this step are not part of a specific procedure outlined in the YMP documentation, but rather reflect critical lift crane operations that are standard in the nuclear industry.

- The CTT is an air-pallet apparatus that is guided by two removable rails. The CTT also has end stops to aid in final positioning. A safe load path is marked for the CTT operations, and there are at least three crew members involved in its movement when loaded. The CTT is normally deflated, with pendant stowed, during preparation activities.
- The shield door to the Cask Unloading Room is closed. There is an interlock between the port slide gates and the shield doors; the port slide gate cannot be open while the shield doors are also open.

The following personnel are involved in this set of operations:

- Crane operator
- Signaling crew member
- Verification crew member
- Radiation protection worker¹⁰
- Supervisor.

Section E5.1.2 provides a more detailed description of the duties performed by each of these personnel.

E6.3.1.2 Gas Sampling of Cask

Platform is Lowered (if Required) and Shield Plate is Closed—Once the cask is loaded and secure in the CTT, the crew lowers the platform, if necessary, and moves the shield plate over the cask.

Gas Sampling and Equalization are Performed (if Required)—To sample the cask, a crew member must plug a hose into the quick-disconnect sampling port and then open the valve to start flow. Once connected, a crew member takes a reading in the gas sampling room of gas that is being removed and verifies that the cask is safe for opening. After the sample is taken, and if safe to do so, the remainder of the gas should be vented, the valve closed, and the hose taken off.

¹⁰The radiation protection worker, or health physicist, is not mentioned specifically in each step of this operation; however, there is always at least one radiation protection worker present during this step.

E6.3.1.3 Removal of Transportation Cask Lid Bolts

The crew uses common tools, the preparation platform, and the shield plate to remove all the cask lid bolts. Movement of the lid bolts may require the use of the auxiliary crane. Once removed, the bolts are counted, and the crew supervisor checks off bolt removal before the lid is removed or the lid lift fixture is attached.

E6.3.1.4 Attaching Transportation Cask Lid Lift Fixture to Cask Lid

The crane operator uses the cask preparation platform, common tools, and the 20-ton auxiliary crane, with lid lift fixture lifting device (expected to be a grapple), to retrieve and emplace the transportation cask lid lift fixture. Once in place, the crew members close the shield plate and attach the fixture to the lid with bolts. This step is verified via a checklist.

Lid Lift Fixture Retrieval—The crane operator lowers the 20-ton auxiliary crane into position over the lid lift fixture in the staging area, engages the fixture, and lifts the fixture to proper height for movement, based on a visual inspection and confirmation by the signaling crew member via hand signals. The proper height for movement is roughly 6 in. above the highest obstacle in the movement path.

Lid Lift Fixture Moved to Cask—The crane operator moves the 20-ton auxiliary crane so as to locate the fixture over the cask in the Cask Preparation Room, following the indicated safe load path marked on the floor. The crane operator does this visually and also receives confirmatory hand signals from the signaling crew member. There is a verification crew member opposite the signaling crew member that can (hand) signal the crane operator to stop at any time. At this time, a crew member opens the shield plate to allow the fixture to be positioned. The crane operator can roughly align the crane, but final alignment is directed by the signaling crew member.

Lid Lift Fixture Lowered and Disengaged—When properly positioned over the cask, the signaling crew member signals the crane operator to lower the fixture into place. The crane operator then proceeds to lower the fixture at or below the maximum allowable speed. Once the fixture is in place, the fixture is disengaged, and the crane is lifted to its maximum height in preparation for the next operation.

Shield Plate Closed and Lid Lift Fixture Bolted—The crew closes the shield plate and uses the cask preparation platform and common tools to emplace and tighten all the lid fixture bolts according to training and then verifies (via a checklist) that all the bolts have been properly installed.

As illustrated in Figure E6.3-1, for DPCs, additional preparation activities are needed (Section E6.3.1.5). All other waste forms can be transferred directly to the Cask Unloading Room (Section E6.3.1.6).

E6.3.1.5 Other Preparation Activities (DPC Only)

Casks containing DPCs must undergo additional preparation activities, including removal of the cask lid (Section E6.3.1.5.1) and attachment of a canister lift fixture (Section E6.3.1.5.2).

E6.3.1.5.1 Removal and Storage of the Transportation Cask Lid on the Cask Lid Stand

Once the lid lift fixture is attached to the cask lid, the crew opens the shield plate and removes the transportation cask lid using the 20-ton auxiliary crane and standard rigging.

Crane Aligned to Cask—The crane operator retrieves the lid lift fixture lifting device, and the crew opens the shield plate. The crane operator then lowers the 20-ton auxiliary crane into position over the transportation cask. The crane operator is positioned on the floor in view of the crew members on either side of the cask. There is a signaling crew member next to the personnel barrier that uses hand signals to guide the crane operator (no hardwired or wireless communication system is used). There is a verification crew member on the opposite side of the cask, checking alignment of the crane. The verification crew member can only signal to stop the crane. Once positioned, one of the crew members connects the crane to the cask lid using the grapple.

Lid is Lifted Vertically—Upon signal from the signaling crew member that all is well, the crane operator begins to raise the cask lid. Once the lid is raised (i.e., is hanging free), the crane operator clears the cask and CTT and then lowers the lid to the proper movement height based on visual inspection and confirmation by the signaling crew member via hand signals. The proper height for movement is roughly 6 in. above the highest obstacle in the movement path. Throughout this operation, the crew is standing several feet away from the platform opening. Once the lid is removed, a crew member then closes the shield plate.

Lid Moved to Staging Area—The crane operator moves the 20-ton auxiliary crane so as to locate the lid over the lid stand in the staging area. To do this, the crane operator follows the indicated safe load path marked on the floor based on visual cues and confirmatory hand signals from the signaling crew member. The crane operator then sets the lid down and disengages the hook.

E6.3.1.5.2 Retrieval and Attachment of DPC Lift Fixture

The lift fixture is attached to the DPC using the 20-ton auxiliary crane with a grapple or hook, cask preparation platform, and common tools. The crane operator and the signaling and verification crew members are positioned on the cask preparation platform for this step. There are several DPC types, and the DPC lift adapter is adjustable, with several mounting positions to accommodate all DPC types.

DPC Lift Fixture Retrieval—The crane operator lowers the 20-ton auxiliary crane into position over the DPC lift fixture in the staging area, engages the hook, and lifts the fixture to proper height for movement based on visual inspection and confirmation by the signaling crew member via hand signals. The proper height for movement is roughly 6 in. above the highest obstacle in the movement path.

DPC Lift Fixture Moved to Cask—The crane operator moves the 20-ton auxiliary crane so as to locate the fixture over the cask in the preparation area. To do this, the crane operator follows the indicated safe load path marked on the floor based on visual cues and confirmatory hand signals from the signaling crew member. There is a verification crew member opposite the signaling crew member that can (hand) signal the crane operator to stop at any time. At this

time, a crew member opens the shield plate to allow the fixture to be positioned. The crane operator can roughly align the crane, but final alignment is directed by the signaling crew member.

DPC Lift Fixture Lowered and Disengaged—When properly positioned over the DPC, the signaling crew member signals the crane operator to lower the fixture into place. The crane operator then proceeds to lower the fixture at or below the maximum allowable speed. Once the fixture is in place, the grapple is disengaged, and the crane is lifted to its maximum height in preparation for the next operation. The crane operator and crew stay several feet away from the platform opening while the shield plate is open.

Shield Plate Closed and DPC Lift Fixture Bolted—A crew member then closes the shield plate, uses the cask preparation platform and common tools to emplace and tighten all the lid fixture bolts according to training, and then verifies (via a checklist) that all the bolts have been properly installed.

E6.3.1.6 Cask Transfer Via CTT to Cask Unloading Room (All Casks)

Using the CTT, the crew member moves the transportation cask to the Cask Unloading Room and positions the cask under the cask port. To do this, the CTT operator inflates the CTT, moves the CTT to the Cask Unloading Room door, opens the shield door, moves the CTT through the door, positions it under the cask port, deflates the CTT, stores the pendant, disconnects the air hose, and closes the shield door. There are physical stop points in the Cask Unloading Room that the CTT must bump up against to ensure proper alignment.

E6.3.2 HFE Descriptions and Preliminary Analysis

This section defines and screens the HFEs that are identified for the base case scenario, that can affect the probability of initiating events occurring, and that could lead to undesired consequences. Descriptions and preliminary analysis for the HFEs of concern during cask preparation and movement to the Cask Unloading Room are summarized in Table E6.3-1. The analysis presented here includes the assignment of preliminary HEPs in accordance with the methodology described in Section E3.2 and Appendix III of this analysis. Section E4.2 provides details on the use of expert judgment in this preliminary analysis.

Table E6.3-1. HFE Group #3 Descriptions and Preliminary Analysis

HFE ID	HFE Brief Description	ESD	Preliminary Value	Justification
060-OpCaskDrop01-HFI-NOD	<i>Operator Drops Cask during Preparation Activities:</i> The cask is not lifted in this step, and no plausible scenarios that would lead to cask drop could be identified.	4	N/A	The cask is not lifted in this step, and the 200-ton crane is not used in this operation. For non DPCs, there is no possible configuration that can result in a cask drop. For DPCs, a cask drop would require several human failures during the same set of activities: during lid removal, the crew must fail to remove some fraction of the lid bolts (EOO), fail to properly use a checklist to verify bolt removal, and must use the wrong crane (EOC) to remove the partially attached lid. In addition to the human failures, the bolts would have to hold the weight of the cask long enough to lift the cask. The crane operator and at least two other crew members would be standing on the platform in direct view of the cask during lid removal, and they would also all have to fail to notice that the entire cask is being lifted before the bolts break. This failure was omitted from analysis.
Crane drop	<i>Operator Drops Object on Cask during Preparation Activities:</i> Preparation of a cask entails moving several heavy objects over the cask using the cask handling crane auxiliary hook. These objects include the lid lift fixture and, for DPCs, the cask lid and canister lift fixture. During these lifts, the operator can drop the object onto the cask or canister by improperly connecting the object to the crane, two-blocking the object, or other such failures.	4	N/A ^a	In this step the operator uses the cask handling crane auxiliary hook to move objects over the cask. There are three heavy-object lifts (i.e., the lid lift fixture, the cask lid, and the canister lift fixture) using the auxiliary hook. The lid lift and canister lift fixtures are moved with a grapple or hook, and the cask lid is moved with a sling; the canister lift fixture and cask lid lifts are only applicable to the preparation of DPCs. Each of these lifts can potentially result in a drop. These HFEs were not explicitly quantified because the probability of a crane drop due to human failure is incorporated in the historical data used to provide general failure probabilities for drops involving various crane and rigging types. Documentation for this failure can be found in Attachment C.
060-OpCTCollide1-HFI-NOD	<i>Operator Causes Low-Speed Collision of Auxiliary Vehicle with CTT:</i> During cask preparation, the CTT is loaded parked under the preparation platform for a long period of time. During this time, an operator can cause an auxiliary vehicle to collide with the CTT.	4	3E-03	In this step the CTT is loaded and parked under the preparation platform. The speed of auxiliary vehicles is slow, the CTT is very visible, and procedural controls are expected to limit the number of other vehicles in the Cask Preparation Room during cask operations. This HEP was assigned the same preliminary value as railcar collision HFE (060-OpRCCollide1-HFI-NOD; Section E6.1, HFE Group #1) because the dominant mechanism of both failures is collision with an auxiliary vehicle. In this case, the preliminary value is conservative because the CTT is staged under the platform, and the railcar-truck trailer collision HFE has additional failure modes associated with movement of the SPM that are not applicable here. The preliminary value was chosen based on the determination that this failure is "highly unlikely" (one in a thousand or 0.001) and was adjusted (×3) because there are several ways for a collision to occur.
060-OpFLCollide1-HFI-NOD	<i>Operator Causes High-Speed Collision of Auxiliary Vehicle with CTT:</i> During cask preparation, the CTT is loaded parked under the preparation platform for a long period of time. During this time, an operator can cause an auxiliary vehicle to collide with the CTT. If the collision is due to the auxiliary vehicle speed governor malfunctioning, this failure would be a high-speed collision.	4	1.0	The operator can cause the auxiliary vehicle to overspeed, resulting in collision. In order to accomplish this failure, the speed governor of the vehicle must fail. To be conservative, unsafe actions that require an equipment failure to cause an initiating event have been assigned an HEP of 1.0.
060-OpSpurMove01-HFI-NOD	<i>Operator Causes Spurious Movement of CTT during Preparation Activities:</i> The CTT is supposed to be deflated, with the control pendant stored during this operation. However, if the CTT is not in the proper configuration for cask preparation, the operator can inadvertently cause the CTT to move. This spurious movement can cause the CTT to collide into the preparation platform.	4	1E-04	In this step the CTT is parked under the preparation platform; the CTT is deflated, with the control pendant stored. For operations in this step there are several crew members on the preparation platform and no operators below the platform. This error was considered to be extremely unlikely (0.0001) because it requires multiple human errors: it would require the CTT to be left inflated, the observers (i.e., the crane operator, two crew members or the radiation protection worker) would have to fail to notice or fail to stop operations and deflate the CTT, and an operator would have to access the pendant and signal the CTT to move.
060-OpCTTImpact1-HFI-NOD	<i>Operator Causes an Impact Between SSC and Loaded CTT Due to Crane Operations:</i> While performing crane operations, the operator can potentially impact the cask if the crane is moved with the hook lowered below the platform.	4	3E-03	In this step the CTT is stationed under the Cask Preparation Room and the lid lift fixture, lid (DPC only), and canister lift fixture (DPC only) are moved over the cask. For crane operations in this step there are three observers with clear visibility, the operations are simple, the travel distances are short, and the crane speed is slow. There are no interlocks to prevent this error. No part of the cask is above preparation platform, and so the only way the CTT (containing a cask) can be impacted with the crane is if the crane is moved with the load and hook lower than the platform and the crane moves into the platform, causing the load and hook to swing into the CTT. The crane hook can also be improperly stowed such that the CTT, when moving to the Cask Unloading Room, collides with the crane hook. However, the CTT travels under the platform to the Cask Unloading Room, and the last preparation activity for both DPCs and non-DPCs requires the shield plate to be closed, so it is unlikely in this case that, if the crane is improperly stored, the hook would be in the path of the CTT. The likelihood of impacting a cask was assessed to be comparable to the "Crane Impact during Upending and Removal" HFE (060-OpTCImpact01-HFI-NOD; Section E6.2, HFE Group #2) and was accordingly assigned the same preliminary value. This assessment is considered conservative because, in comparison with upending and removal, there are fewer crane movements in this operation, and there is a platform around the CTT that makes it harder to impact the CTT. This failure is "highly unlikely" (one in a thousand or 0.001, which also corresponds to the generic failure rate for a simple operation that is performed daily) but is adjusted because there are several ways for an impact to occur (×3).

Table E6.3-1. HFE Group #3 Descriptions and Preliminary Analysis (Continued)

HFE ID	HFE Brief Description	ESD	Preliminary Value	Justification
060-OpTipover002-HFI-NOD	<i>Operator Causes Cask to Tip Over during Cask Preparation Activities:</i> The operator can improperly stow the crane rigging, and it can catch the CTT or cask. If this happens, movement of the crane or the CTT can cause the cask and CTT to tip over.	4	1E-04	In this step the CTT is stationed under the preparation station, the lid lift fixture is attached to the cask lid and the CTT is then moved to the Cask Unloading Room. In order to get a tipover of the cask or CTT, the crane must be attached to the cask or CTT, and the crane or CTT must also move. To be conservative, the 20-ton crane is considered capable of physically tipping over the cask while it is in a CTT underneath the platform. At no point in the operations is the crane attached to the cask; for DPC preparation, the crane is attached to the lid, but the lid is unbolted (Section E6.0.2.3.2 provides a discussion of failure to remove lid bolts). Therefore, the only way for the crane to be attached to the cask is if the crane rigging catches the cask or CTT, which is unlikely because the CTT is protected by the platform and shield plate during this operation. If the rigging is caught, it is unlikely that the crane operator would not notice while attempting to move the crane. It is also unlikely that, when the CTT begins movement to the Cask Unloading Room, the CTT operator and observers would not notice that the rigging is attached to the CTT. The dominant contributor is the crane hook catching the cask. While it may be unlikely (0.01) that a stray hook or grapple might be hanging from the crane, it would still need to catch on the cask securely enough to pull it over (0.1), and then the cask tipping would have to go unnoticed by all three observers. This task is done under direct observation, there is platform and shield plate to protect the cask from stray rigging, and tipover is a slow process; therefore, the value was adjusted by a further 0.1. This operation was given the same preliminary value as the "Cask Tipover during Upending and Removal" HFE (060-OpTipover001-HFI-NOD; Section E6.2, HFE Group #2) because it is a very similar operation (i.e., movement with crane using the same type of rigging and attachments). The difference between the two scenarios is that there are more crane operations and more failure modes during upending and removal, so there would be more opportunities for tipover in that scenario; also, there is no platform/shield plate in upending to protect the cask from stray rigging.
060-OpTipOver3-HFI-NOD	<i>Operator Causes Tipover of CTT during Movement to the Cask Unloading Room:</i> The operator can improperly stow the crane rigging, and it can catch the CTT or cask. If this happens while the CTT is moving to the unloading room, it can cause the CTT to tip over.	6	N/A	The CTT, loaded with a cask, undergoes a set of operations that includes operations under the preparation platform and then movement of the CTT away from the platform to the Cask Unloading Room. Tipover of the CTT during this set of activities constitutes one HFE because the most likely scenario is that the crane would be attached during preparation and tipover would happen during movement of the CTT away from the platform. The event sequences, however, model tipover during platform activities <i>and</i> tipover during CTT movement. Because this is only one human failure, the appropriate preliminary value was only modeled in the event sequence associated with platform activities (060-OpTipover002-HFI-NOD, modeled in ESD 4). The HEP for tipover in the event sequence associated with the subsequent movement of the CTT (060-OpTipOver3-HFI-NOD in ESD 6) was assigned a probability of zero to avoid double counting.
060-OpImpact0000-HFI-NOD	<i>Operator Causes Impact of Cask during Transfer from Cask Preparation Room to Cask Unloading Room:</i> While moving from the Cask Preparation Room to the Cask Unloading Room, the CTT can impact the crane hook or rigging if it is improperly stowed.	6	N/A	While moving from the Cask Preparation Room to the Cask Unloading Room, the CTT can impact the crane hook or rigging if it is improperly stowed. The last step in preparation activities for both DPCs and non-DPCs requires the shield plate of the platform to be closed. It is unlikely, then, that the crane rigging can be improperly stowed such that it would impact the site transporter while it is moving out of the Cask Unloading Room; it is more likely that rigging would impact the cask while the crane is actually in use. Therefore, any crane interference with the CTT is already covered by 060-OpCTTImpact1-HFI-NOD ("Operator Causes Impact between CTT and SSC during Cask Preparation with Lid On") and 060-OpTipover002-HFI-NOD ("Operator Causes Cask to Tip Over during Cask Preparation Activities").
060-OpCTCollide2-HFI-NOD	<i>Operator Causes Low-Speed Collision of CTT during Transfer from Cask Preparation Room to Cask Unloading Room:</i> Once the preparation activities are over, an operator inflates the CTT and moves the cask from the Cask Preparation Room to the Cask Unloading Room. The operator can cause the CTT to collide with the preparation platform structure during this transfer. The CTT is designed such that it physically cannot over speed; therefore, all CTT collisions are below the designed speed.	6	1E-03	In this step the CTT moves from the preparation station to the Cask Unloading Room; the doors of the preparation station must be opened to allow the CTT to pass through. There are three observers with clear visibility, the speed of the CTT and other vehicles is low, the CTT is very visible, and there are two guide rails and an end stop to keep the CTT on the safe load path. Procedural controls are expected to limit the number of other vehicles in the Cask Preparation Room during cask operations. The CTT could collide into a conveyance or a facility structure (e.g., the preparation station platform). This failure could happen if the guide rails were not installed properly. This operation is simple, is straightforward, is expected to occur very regularly (daily), and was assigned the default probability of a "highly unlikely" occurrence (0.001). It was considered reasonable and consistent that the preliminary value assigned for this HFE be less likely than a railcar-truck trailer collision because of the guide rail, number of observers, and short travel distance.
060-OpSDClose001-HFI-NOD	<i>Operator Closes Shield Door on Conveyance:</i> Once the preparation activities are over, an operator inflates the CTT and moves the cask from the Cask Preparation Room to the Cask Unloading Room. There is a shield door between the Cask Preparation Room and the Cask Unloading Room. The operator can impact the cask by inadvertently closing the shield door on the CTT as the CTT passes through the door.	7	1.0	The railcar or transfer trailer passes through shield doors as it enters the Cask Preparation Room. During this transfer, the operator can cause the CTT to collide into the shield door or can close the shield door on the CTT. Section E6.0.2.3.3 provides a justification of this preliminary value.

Table E6.3-1. HFE Group #3 Descriptions and Preliminary Analysis (Continued)

HFE ID	HFE Brief Description	ESD	Preliminary Value	Justification
060-OpDPCShield1-HFI-NOW	<i>Operator Causes Loss of Shielding while Installing DPC Lift Fixture:</i> In this step, the DPC canister lift fixture is attached to the canister. There are two ways for the crew to get a direct exposure during this activity: an operator can fail to properly close and verify the closure of the shield plate after the cask lid is removed and the crew continues with the installation, or an operator can inadvertently open the shield plate while the crew is installing the canister lift fixture.	17	1E-03	In this step the DPC canister lift fixture is attached to the canister. If an operator fails to properly close the shield plate after removing the DPC lid, then the crew can be directly exposed to the shine from the DPC while installing the canister lift fixture. Likewise, if an operator inadvertently opens the shield plate while the crew is installing the canister lift fixture, then the crew can be exposed. In this case, the crew is on top of the shield plate and would notice if the shield plate moved. The crew is highly trained and, although they only perform DPC preparation activities weekly, they are accustomed to operating the shield plate during preparation of other transportation casks. In addition to the crew members, there is also a radiation worker present who is monitoring activities. This error was assessed to be highly unlikely and was given a preliminary value of 0.001.
060-Liddisplace1-HFI-NOD	<i>Operator Inadvertently Displaces Lid:</i> The operator can improperly store the crane rigging such that it catches the lid lift fixture and pulls off the cask lid during cask preparation, resulting in a direct exposure.	17	N/A	In this step the lid is unbolted, and the lid lift fixture is attached. Due to design changes to the preparation platform, improperly stowed rigging during this operation would not catch the lid lift fixture. These design changes include raising the platform and adding a shield plate so the cask is recessed underneath the platform
Gas sampling	<i>Operator Improperly Performs Gas Sampling:</i> Gas sampling may be performed to determine if an incoming canister has been damaged by the transportation process. If the gas sampling process is incorrectly performed and a damaged canister goes undetected, a radiation release can occur by continuing with normal operations.	N/A	N/A	If the gas sampling process is incorrectly performed and a damaged canister goes undetected, a radiation release would occur by continuing with normal operations. Assessing accident scenarios with previously damaged canisters is beyond the scope of this analysis.

NOTE: ^a HRA value replaced by use of historic data.
 CTT = cask transfer trolley; DPC = dual-purpose canister; EOC = error of commission; EOO = error of omission; ESD = event sequence diagram;
 HEP = human error probability; HFE = human failure event; ID = identification; N/A = not applicable; SPM = site prime mover; SSC = structure, system, or component.

Source: Original

E6.3.3 Detailed Analysis

After the preliminary screening analysis and initial quantification are completed, those HFEs that appear in dominant cut sets for event sequences that do not comply with the 10 CFR 63.111 performance objectives are subjected to a detailed analysis. The overall framework for the HRA is based upon the process guidance provided in ATHEANA (Ref. E8.1.22). Consistent with that framework, the following four steps from the methodology described in Section E3.2 provide the structure for the detailed analysis portion of the HRA:

Step 5: Identify Potential Vulnerabilities

Prior to defining specific scenarios that can lead to the HFEs of interest (Step 6), information is collected to define the context in which the failures are most likely to occur. In particular, analysts search for potential vulnerabilities in the operators' knowledge and information base for the initiating event or base case scenario(s) under study that might result in HFEs or unsafe actions. This information collection step discussed in Section E6.3.3.2.

Step 6: Search for HFE Scenarios (Scenarios of Concern)

An HFE scenario is a specific progression of actions with a specific context that leads to the failure of concern; each HFE is made up of one or more HFE scenarios. In this step, documented in Sections E6.3.3.3 and E6.3.3.4, the analyst identifies deviations from the base case scenario that are likely to result in risk-significant unsafe action(s). These unsafe actions make up an HFE scenario. In serious accidents, these HFE scenarios are usually combinations of various types of unexpected conditions.

Step 7: Quantify Probabilities of HFEs

Detailed HRA quantification methods are selected as appropriate for the characteristics of each HFE and are applied as explained in Section E6.3.3.4. Four quantification methods are utilized in this quantification:

- CREAM (Ref. E8.1.18)
- HEART (Ref. E8.1.28)/NARA (Ref. E8.1.11)
- THERP (Ref. E8.1.26)
- ATHEANA expert judgment (Ref. E8.1.22).

There is no implication of preference in the order of listing these methods. They are jointly referred to as the "preferred methods" and are applied either individually or in combination as best suited for the unsafe action quantified. The ATHEANA (Ref. E8.1.22) expert judgment method (as opposed to the overall ATHEANA (Ref. E8.1.22) methodology that forms the framework and steps for the performance of this HRA) is used when the other methods are deemed to be inappropriate to the unsafe action, as is often the case for cognitive EOCs.

Appendix E.IV of this analysis explains why these specific methods were selected for quantification and gives some background on when a given method is applicable based on the focus and characteristic of the method.

All judgments used in the quantification effort are determined by the HRA team and are based on their own experience, augmented by facility-specific information and the experience of subject matter experts, as discussed in Section E4. If consensus can be reached by the HRA team on an HEP for an unsafe action, that value is used as the mean. If consensus cannot be reached, the highest opinion is used as the mean.

Step 8: Incorporate HFEs into the PCSA

After HFEs are identified, defined, and quantified, they must be incorporated into the PCSA. The summary table of HFEs by group that lists the final HEP by basic event name provides the link between the HRA and the rest of the PCSA. This table can be found in Section E6.3.4.

E6.3.3.1 HFEs Requiring Detailed Analysis

The detailed analysis methodology, Sections E3.2.5 through E3.2.9, states that HFEs of concern are identified for detailed quantification through the preliminary analysis (Section E3.2.4). An initial quantification of the CRCF PCSA model determined that there was one HFE in this group whose preliminary value was too high to demonstrate compliance with the performance objectives stated in 10 CFR 63.111. This HFE is presented in Table E6.3-2.

Table E6.3-2. Group #3 HFE Requiring Detailed Analysis

HFE	Description	Preliminary Value
060-OpDPCShield1-HFI-NOW	Operator fails to properly shield DPC while installing canister lift fixture, leading to direct exposure	1E-03

NOTE: DPC = dual-purpose canister; HFE = human failure event.

Source: Original

E6.3.3.2 Assessment of Potential Vulnerabilities (Step 5)

For those HFEs requiring detailed analysis, the first step in the ATHEANA approach to detailed quantification is to identify and characterize factors that could create potential vulnerabilities in the crew's ability to respond to the scenarios of interest and might result in HFEs or unsafe actions. In this sense, the "vulnerabilities" are the context and factors that influence human performance and constitute the characteristics, conditions, rules, and tendencies that pertain to all the scenarios analyzed in detail.

These vulnerabilities are identified through activities including but not limited to the following:

1. The facility familiarization and information collection process discussed in Section E4.1, such as the review of design drawings and concept of operations documents
2. Discussions with subject matter experts from a wide range of areas, as described in Section E4.2
3. Insights gained during the performance of the other PCSA tasks (e.g., initiating events analysis, systems analysis, and event sequence analysis).

The vulnerabilities discussed in this section pertain only to those aspects of the preparation operation that relate to potential human failure scenarios relevant to the HFE listed above. Other vulnerabilities exist that would be relevant to other potential HFEs that can occur during the preparation operation, but these have no bearing on this analysis.

E6.3.3.2.1 Operating Team Characteristics

Crew members—There are several crew members involved in the installation of the canister lift fixture. One predesignated crew member operates the platform shield plate. This crew member, referred to here as the shield plate operator, is trained as to when the shield plate must be opened or closed. When the operations require the shield plate to be moved, the crew member informs the other crew members on the platform that the shield plate is going to be moved. The other crew members confirm that the shield plate is in the proper position before continuing on to the next step of the operation. All crew members are expected to have the proper training commensurate with nuclear industry standards. This training is followed by a period of observation until the operator is proficient.

Radiation protection worker—The radiation protection worker is a fully certified health physics technician, whose job is to monitor radiation from the cask during movement. The radiation protection worker is responsible for stopping operations if high radiation levels are detected or if there is a situation that would lead to direct exposure.

E6.3.3.2.2 Operation and Design Characteristics

Preparation operations are slow and tedious, and they promote complacency.

The position of the shield plate is very visible. The shield plate is opened to place the canister lift fixture on the DPC, and it is then closed to bolt the fixture. The shield plate remains closed while the DPC is transferred to the Cask Unloading Room.

Shield plate operations—The shield plate has two modes: a normal travel mode (forward and reverse) and a jog mode (forward and reverse). The jog mode only allows the plate to move very slowly and in small increments. The shield plate operator uses the travel mode to move the shield plate completely over the cask port until it reaches the end stop. The jog function is then used for fine control of the shield plate to line up the shield plate with the bolt holes in the canister lift fixture. To open the shield plate, the shield plate operator again uses the normal travel mode until it reaches the end stop at the other end of the platform. Before opening or closing the shield plate, the shield plate operator ensures that the path of the shield plate is clear of personnel.

E6.3.3.2.3 Formal Rules and Procedures

Procedures—There are no written, formal procedures that the crew has in front of them during cask preparation; the procedures for how to handle a DPC come from training.

E6.3.3.2.4 Operator Tendencies and Informal Rules

Observation and communication—The shield plate crew member communicates the actions to other crew members throughout this operation. The entire crew should be aware of the procedure and order of operations.

E6.3.3.2.5 Operator Expectations

Anticipatory actions—The preparation process is simple but time consuming. There can be a tendency for the crew to focus on future tasks while preparing the DPC.

Consequences of Failure—The cask is not lifted in this step, and a shield plate is over the cask, so the threat of radiation release or physical injury is very low in this procedure. The crew expects failures to be relatively inconsequential, which promotes complacency in the operations.

E6.3.3.3 HFE Scenarios and Expected Human Failures (Step 6)

Given that the vulnerabilities that provide the operational environment and features that could influence human performance have been specified, then the HFE scenarios within this environment are identified. An HFE scenario is a specific progression of actions during normal operations (with a specific context) that lead to the failure of concern; each HFE is made up of one or more HFE scenarios. In accordance with the methodology, each scenario integrates the unsafe actions with the relevant equipment failures so as to provide the complete context for the understanding and quantification of the HFE.

The HAZOP evaluation is instrumental in initially scoping out the HFE scenarios, but they are then refined through discussions with subject matter experts from a wide range of areas, as described in Section E4.2.

Table E6.3-3 summarizes all of the HFE scenarios developed for the HFE in this group.

Table E6.3-3. HFE Scenarios and Expected Human Failures for HFE Group #3

HFE	HFE Scenarios
060-OpDPCShield1-HFI-NOW <i>Operator fails to properly shield DPC while installing canister lift fixture, leading to direct exposure</i>	HFE Scenario 1(a): (1) Shield plate crew member does not place shield plate entirely over the cask, or (2) crew fails to notice improper shield plate closure before approaching the shield plate. HFE Scenario 1(b): (1) Shield plate crew member opens shield plate while crew bolts canister lift fixture, or (2) crew fails to notice shield plate movement in time OR shield plate crew member fails to respond to warnings from crew.

NOTE: HFE = human failure event.

Source: Original

Since there is one HFE identified for detailed analysis in this group, the scenarios are organized under this HFE category, with the scenarios numbered as 1(a) and 1(b).

Each HFE scenario is in turn characterized by several unsafe actions, numbered sequentially as (1), (2), (3), etc. The Boolean logic of the HFE scenarios is expressed with an implicit AND connecting the subsequent unsafe actions and OR notation wherever two unsafe action paths are possible, as shown in Table E6.3-3.

The HFE scenarios summarized in Table E6.3-3 are discussed and quantified in detail below.

E6.3.3.4 Quantitative Analysis (Step 7)

Once the HFE scenarios and the unsafe actions within them are scoped out, it is then possible to review them in detail and apply the appropriate quantification methodology in each case that permits an HEP to be calculated for each HFE. Stated another way, each HFE is quantified through the analysis and combination of the contributing HFE scenarios. Dependencies between the unsafe actions and equipment responses within each scenario and across the scenarios are carefully considered in the quantification process.

This section provides a description of the quantitative analysis performed, structured hierarchically by each HFE category (identified by a basic event name); the HFE scenario; and then the unsafe actions under each scenario, as previously documented in Table E6.3-3.

Prior to the scenario-specific quantification descriptions, a listing is provided of the values used in the quantification that are common across many of the HFE scenarios.

In generating the final HEP values, the use of more than a single significant figure is not justified given the extensive use of judgment required for the quantification of the individual unsafe actions within a given HFE. For this reason, all calculated final HEP values are reduced to one significant figure. When doing this, the value is always rounded upwards to the next highest single significant figure.

E6.3.3.4.1 Common Values Used in the HFE Detailed Quantification

There are some mechanical failures that combine with unsafe actions to form HFEs. In general, these mechanical failures are independent of the specific HFE scenario, and so they can be quantified independently. These values are presented in this section.

Interlock Failures—There are a number of interlock failures in the HFE scenarios. While the status of these events can affect subsequent events in the scenarios in different ways, the likelihood of this event occurring is independent of the scenario. This event is an equipment failure and does not have a human component to its failure rate. The demand failure rate for an interlock, from Attachment C, Table C4-1, is approximately $2.7E-05$ per demand.

$$\text{Interlock fails to perform function} = 2.7E-05$$

**E6.3.3.4.2 Quantification of HFE Scenarios for 060-OpDPCShield1-HFI-NOW:
Operator Fails to Properly Shield DPC while Installing Canister Lift Fixture,
Leading to Direct Exposure**

Figure E6.3-2 is an illustration of this failure scenario; this figure is not to scale. The DPC itself is shielded on top. The radiation of concern in this scenario is streaming from the small portion of the annulus which is not covered by the preparation platform. Because the shield plate is so visible and because the crew cannot access the canister to bolt the canister lift fixture to the DPC without the shield plate, the only scenarios considered in this analysis are those in which the shield plate is partially open; failure to close the shield plate entirely has been omitted from analysis.

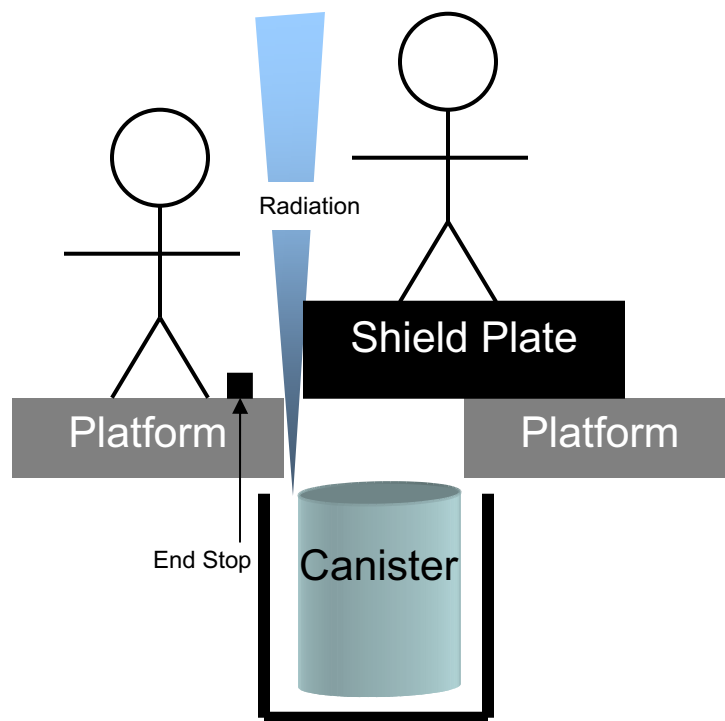

Source: Original

Figure E6.3-2. 060-OpDPCShield1-HFI-NOW Operator Failure Scenario

E6.3.3.4.2.1 HFE Group #3 Scenario 1(a) for 060-OpDPCShield1-HFI-NOW

1. Shield plate crew member fails to cover cask entirely with shield plate.
2. Crew fails to notice improper shield plate closure before approaching the shield plate.

Shield Plate Crew Member Fails to Cover Cask Entirely with Shield Plate—After the canister lift fixture is placed on the DPC, the shield plate operator ensures that the platform area around the shield plate path is clear, announces that the shield plate is closing, and holds down the forward control of the shield plate until it hits the end stop. At that point, the shield plate operator stops moving the shield plate and informs the crew that they can begin their bolting

procedure. This process may have some degree of automation; however, to be conservative, this process is analyzed as if it is entirely manual. This is a simple manual action that the operator performs on a regular basis based on training.

The shield plate operator action of closing the shield plate until it hits the end stop is a simple manual action that the operator performs several times a day based on training. Operation of the shield plate is always the same. The end stop provides an indication, or feedback, that the shield plate has been appropriately moved. This error most closely corresponds to the task execution error NARA (Ref. E8.1.11) generic task type (GTT) A1, and it is adjusted by the following EPCs:

- GTT A1: Carry out a simple single manual action with feedback. Skill-based and therefore not necessarily with procedures. The baseline HEP is 0.005.
- EPC 13: Operator under load/boredom. The full affect EPC would be $\times 3$, which applies to a routine task of low importance, carried out by a single individual for several hours. The assessed proportion of affect (APOA) anchor for 0.1 is for low difficulty, low importance, single individual, for less than one hour. This assessment appears reasonable for this task since the closure operation takes place in just minutes, so the APOA is set at 0.1.

$$\begin{aligned} &\text{Shield plate crew member fails to cover cask entirely} \\ &\text{with shield plate} = 0.005 \times [(3-1) \times 0.1 + 1] = 0.006 \end{aligned}$$

Crew Fails to Notice Improper Shield Plate Closure before Approaching the Shield Plate—

If the crew fails to notice that the shield plate is not entirely closed before they approach the shield plate to begin bolting operations, they can potentially get a direct exposure while getting onto the platform. The bolting crew has to get onto the shield plate in order to bolt the canister lift fixture. Part of their training is to visually confirm the shield plate position before approaching the plate. The shield plate, platform opening, and end stop are all easily visible from the preparation platform. This error most closely corresponds to the observation error CREAM (Ref. E8.1.18) cognitive function failure (CFF) O3, adjusted by the following CPCs with values not equal to 1.0.

- CFF O3: Observation not made. The baseline HEP is 0.003.
- CPC “Working Conditions”: The crew is physically present with a good view of the area, which qualifies as advantageous. The CPC for advantageous working conditions for an observation task is 0.8.
- CPC “Adequacy of Training/Preparation”: Training is adequate, with high experience. The CPC for an observation task with adequate training and high experience is 0.8.

Applying these factors yields the following:

$$\begin{aligned} &\text{Crew fails to notice improper shield plate closure before} \\ &\text{approaching the shield plate} = 0.003 \times 0.8 \times 0.8 = 0.002 \end{aligned}$$

This is the HEP if the action is completely independent on the part of the crew. However, there is a dependency between the shield plate operator’s failure to close the shield plate properly and the crew’s failure to notice based on a certain level of trust between the unbolting crew and their crewmate working the shield plate. In normal, low-consequence circumstances, this dependency might be considered “medium” or “high”; however, in this scenario, the crew is directly at risk if the shield plate operator fails, and thus more likely to actually perform the check. Therefore, this dependency was assessed to be “low.” From THERP (Ref. E8.1.26) Table 20-21, item (a)(2), the revised probability of this unsafe action follows:

Crew fails to notice improper shield plate closure
before approaching the shield plate = 0.05

HEP Calculation for Scenario 1(a)—The events in the HEP model for Scenario 1(a) are presented in Table E6.3-4.

Table E6.3-4. HEP Model for HFE Group #3 Scenario 1(a) for 060-OpDPCShield1-HFI-NOW

Designator	Description	Probability
A	Shield plate operator fails to cover cask entirely with shield plate	0.006
B	Crew fails to notice improper shield plate closure before approaching the shield plate	0.05

Source: Original

The Boolean expression for this scenario follows:

$$A \times B = 0.006 \times 0.05 = 0.0003 \quad (\text{Eq. E-1})$$

E6.3.3.4.2.2 HFE Group #3 Scenario 1(b) for 060-OpDPCShield1-HFI-NOW

1. Shield plate crew member opens the shield plate while the crew bolts the canister lift fixture.
2. The crew fails to notice the shield plate movement in time OR the shield plate crew member fails to respond to warnings from the crew.

Shield Plate Crew Member Opens Shield Plate while Crew Bolts Canister Lift Fixture—

While it is likely that the entire crew involved in cask preparation is trained in proper shield plate operations, during normal cask preparation operations, the only crew member authorized to open the shield plate is the predesignated shield plate operator. The shield plate operator is trained to ensure that the shield plate and shield plate path are cleared of personnel before moving the shield plate. Also, there is a direct view of the entire shield plate path from the shield plate control location.

The shield plate is not supposed to be moved again during cask preparation activities once the canister lift fixture has been placed on the DPC. The only operations that occur after the canister lift fixture is emplaced and the shield plate is closed are bolting of the fixture and then movement of the CTT to the Cask Unloading Room. Neither of these actions requires actions that can be

confused with the actions that correspond to operating the shield plate; bolting requires tools, and CTT movement is not done from the platform.

Once the canister lift fixture is placed on the DPC and the shield plate is closed, the shield plate is not supposed to be opened for the remainder of the operations. Therefore, this error is an EOC. The crew who are on the shield plate bolting the canister lift fixture would immediately notice that the shield plate was moving and would signal the person committing this error to stop. THERP (Ref. E8.1.26) Table 20-12 describes several EOCs. None of these errors, however, appropriately describes this error. EOCs described in THERP (Ref. E8.1.26) primarily refer to actions where the operator intends to perform an action (e.g., flip a switch or turn a knob) but performs a different action (e.g., flips the wrong switch or turns the knob the wrong way). In this case, none of crew members would be performing an action similar to opening the shield plate during this step. They would only be installing bolts in the canister lift fixture. The most appropriate error that corresponds with this HFE was determined to be the task execution error NARA (Ref. E8.1.11) GTT A5, adjusted by the following EPCs:

- NARA GTT A5: Task execution. Completely familiar, well-designed, highly practiced routine task performed to highest possible standards by highly motivated, highly trained and experienced person, totally aware of implications of failure, with time to correct potential errors. The baseline HEP is 0.0001. While this error is not a task execution error (because there is no task being performed) this error was considered the most appropriate because it describes the operations the best. This value is considered to be conservative when applied to this failure because there is no task being performed in this step.
- EPC 13: Operator under load/boredom. The full affect EPC would be $\times 3$, which applies to a routine task of low importance, carried out by a single individual for several hours. This EPC is applicable in its full effect because the whole set of cask preparation activities is slow and tedious, and the operator could get bored and distracted and believe it is time to open the shield before the workers are completely clear. This is the only relevant EPC, and the APOA is set at 1.0.

Using the NARA (Ref. E8.1.11) HEP equation yields the following:

$$\begin{aligned} &\text{Shield plate crew member opens shield plate while crew bolts canister lift fixture} \\ &= 0.0001 \times [(3-1) \times 1.0 + 1] = 0.0003 \end{aligned} \quad (\text{Eq. E-2})$$

Crew Fails to Notice Shield Plate Movement in Time—During this portion of the operation, there are several people on the shield plate bolting the fixture with long reach tools that go through the shield plate. If the shield plate is inadvertently opened, these crew members would notice and provide immediate feedback to the person operating the plate. The crew would have roughly 30 seconds to notice and try to warn the shield plate operator. If they failed to notice the movement or did not realize what it meant, they would be exposed.

The crew works on the platform and stands on the shield plate or very close to it. Their reaction to it is a very simple response to a very obvious indicator; in this case the indicator is movement of the shield plate. This would be very obvious to the workers present, and they would have on

the order of 30 seconds to react. While the NARA task execution error GTT C1 is primarily applicable to response to indicators in a control room, it is seen as the most applicable failure mode to this scenario because the basic action is, again, a very simple response to a very obvious indicator. Specifically, the portions of the description of GTT C1 related to “simple diagnosis required” and “response must be direct execution of simple actions” were considered applicable to this action. The other human failure quantification option for this action might be CREAM generic failure type I3 for “delayed interpretation”; however, the CREAM CPCs did not allow the influence of unfamiliarity to be fully addressed. Therefore, it is considered that NARA GTT C1 captures both the observation and interpretation characteristics of the action, adjusted by the following EPCs:

- GTT C1: Simple response to a range of alarms or indications providing clear indication of situation (simple diagnosis required). The baseline HEP is 0.0004.
- EPC 2: Unfamiliarity (a potentially important situation that occurs infrequently or is novel). The full affect EPC would be $\times 20$, which applies to a rare event not covered in training, but procedures exist. The APOA anchor for 0.5 is for a rare event covered once per year in training. The APOA anchor for 0.1 is for a rare event covered in regular training. Other considerations for a reduction from full affect is something rarely practiced but easy to carry out and for which the crew has some familiarity. This is covered in regular health physics training and in health physics procedures. Proper health physics practices and the importance of shielding is emphasized in the training. It appears reasonable for this task that the APOA be set at 0.1.
- EPC 3: Time pressure. The full affect would be $\times 11$, which applies if, in order to complete the required task, the operator would have to complete each task step correctly and as quickly as possible. The anchor example for the full effect of this EPC being applied (APOA of 1.0) is “just enough time to complete the task when working as quickly as possible,” while an APOA of 0.5 is anchored with “operator must work at a fast pace with reduced time for checking.” It was considered that the time would not be a full effect but more than half effect and was therefore assessed at an APOA of 0.7.

Using the NARA (Ref. E8.1.11) HEP equation yields the following:

$$\begin{aligned} &\text{Crew fails to notice shield plate movement in time} \\ &= 0.0004 \times [(20-1) \times 0.1 + 1] \times [(11-1) \times 0.7 + 1] = 0.01 \end{aligned} \quad (\text{Eq. E-3})$$

Shield Plate Crew Member Fails to Respond to Warnings from Crew—If the crew realized what was happening, they would need to get the attention of the operator in some manner. Their only means of communication is verbal, without the aid of any communication devices. They would need to be heard over the noise of the machinery in the preparation area. The plate control is in direct view of the shield plate, and the operator has roughly 30 to 60 seconds to stop moving the shield plate before a potential direct exposure can occur. If the operator fails to do so, the workers would not have sufficient time to avoid exposure.

The shield plate crew member is on the floor near the platform and is unlikely to be looking up at the workers on the platform, in particular because at this point the shield plate crew member is in

the process of opening the shield plate and expects that no one is on the platform. There is machinery noise from the platform and other things in the preparation area like the CTT. The other members of the crew are trying to communicate the error to the shield plate crew member verbally. The action itself (stopping the shield plate) is very simple, and there is plenty of time to execute it once the need is recognized. This error most closely corresponds to the communication error NARA (Ref. E8.1.11) GTT D1, adjusted by the following EPCs:

- GTT D1: Verbal communication of safety-critical data. The baseline HEP is 0.006.
- EPC 4: Low signal-to-noise ratio. This usually pertains to competing data or signals that obscure the most important ones, but it can also mean masking of the important information by other types of distractions. In this case, the masking affect is the abundance of machine noise and the distance between the crew on the platform and the crew member on the floor. The full affect EPC would be $\times 10$, which applies to a required signal being highly masked (such as when there is a proliferation of other signals). Given the level of noise that is expected and the difficulty in communicating above it, it appears reasonable for this task that the APOA be set at 1.0.

Using the NARA (Ref. E8.1.11) HEP equation yields the following:

$$\begin{aligned} &\text{Shield plate crew member fails to respond to warnings} \\ &\text{from crew} = 0.006 \times [(10-1) \times 1.0 + 1] = 0.06 \end{aligned} \quad (\text{Eq. E-4})$$

Calculation for Scenario 1(b)—The events in the HEP model for Scenario 1(b) are presented in Table E6.3-5.

Table E6.3-5. HEP Model for HFE Group #3 Scenario 1(b) for 060-OpDPCShield1-HFI-NOW

Designator	Description	Probability
A	Shield plate crew member opens shield plate while crew bolts canister lift fixture.	0.0003
B	Crew fails to notice shield plate movement in time.	0.01
C	Shield plate crew member fails to respond to warnings from crew.	0.06

Source: Original

The Boolean expression for this scenario follows:

$$A \times (B + C) = 0.0003 \times (0.01 + 0.06) = 2E-5 \quad (\text{Eq. E-5})$$

E6.3.3.4.2.3 HEP for HFE 060-OpDPCShield1-HFI-NOW

The Boolean expression for the overall HFE (all scenarios) follows:

$$\begin{aligned} \text{HFE 060-OpDPCShield1-HFI-NOW} &= \text{HEP 1(a)} + \text{HEP 1(b)} \\ &= 0.0003 + 2E-5 = 0.00032 \sim 0.0004 \end{aligned} \quad (\text{Eq. E-6})$$

E6.3.4 Results of Detailed HRA for HFE Group #3

The final HEPs for the HFEs that required detailed analysis in HFE Group #3 are presented in Table E6.3-6 (with the original preliminary value shown in parentheses).

Table E6.3-6. Summary of HFE Detailed Analysis for HFE Group #3

HFE	Description	Final Probability
060-OpDPCShield1-HFI-NOW	Operator fails to properly shield DPC while installing canister lift fixture, leading to direct exposure.	4E-04 (1E-3)

NOTE: DPC = dual-purpose canister; HFE = human failure event.

Source: Original

E6.4 ANALYSIS OF HUMAN FAILURE EVENT GROUP #4: SITE TRANSPORTER RECEIPT AND MOVEMENT INTO CASK PREPARATION ROOM; AGING OVERPACK PREPARATION AND MOVEMENT TO THE CASK UNLOADING ROOM

HFE group #4 corresponds to the operations and initiating events associated with the ESD and HAZOP evaluation nodes listed in Table E6.0-1, covering receipt of an aging overpack and movement into the Cask Unloading Room. The operations covered in this HFE group are shown in Figure E6.4-1. This is the beginning of CRCF operations for an aging overpack/TAD canister. In this operation, a site transporter, carrying an aging overpack, enters the Site Transporter Entrance Vestibule and moves under the preparation platform in the Cask Preparation Room. The aging overpack lid bolts are removed. Once the lid bolts are removed, the crew moves the site transporter with the aging overpack from the Cask Preparation Room to the Cask Unloading Room and positions the cask under the cask port, ready for CTM operations. This operation ends at this point, prior to any CTM activities.

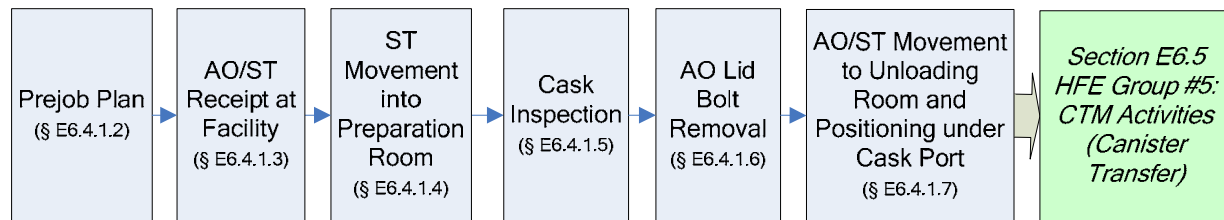

NOTE: § = Section; AO = aging overpack; CTM = canister transfer machine; HFE = human failure event; ST = site transporter.

Source: Original

Figure E6.4-1. Activities Associated with HFE Group #4

E6.4.1 Group #4 Base Case Scenario

E6.4.1.1 Initial Conditions and Design Considerations Affecting the Analysis

The following conditions and design considerations were considered in evaluating HFE group #4 activities:

- The site transporter is securely loaded with an intact aging overpack and is at the entrance of the Site Transporter Entrance Vestibule.

The following personnel are involved in this set of operations:

- Crew members (two people)
- PIC

- Site transporter operator
- Radiation protection worker¹¹.

Section E5.1.2 provides a more detailed description of the duties performed by each of these personnel.

E6.4.1.2 Prejob Plan

Before the aging overpack/site transporter reaches the CRCF, a PIC is notified of the type of cask/conveyance to expect and how to process it. According to this information, the PIC determines the appropriate procedures and equipment necessary to process this cask type and communicates this information to all the crew members involved in the processing of this cask. The PIC fills out a prelift safety checklist (Ref. E8.1.12) verifying that the equipment is properly staged and is in proper operational condition. All crew members are properly trained and abide by the procedures of the facility.

E6.4.1.3 Aging Overpack Receipt in Cask Preparation Room—Loaded Site Transporter Receipt in Site Transporter Vestibule

Two crew members are located at the Site Transporter Entrance Vestibule. When the site transporter approaches the CRCF, one crew member opens the outside overhead door and the other crew member directs the site transporter into the Site Transporter Entrance Vestibule, ensuring there are no vehicles/obstructions in the path. The crew members follow all relevant restrictions and procedures regarding site transporter speed and direction of travel. Once the site transporter has cleared the door, the first crew member closes the outside door.

E6.4.1.4 Site Transporter Movement into Cask Preparation Room

Once the site transporter is in the Site Transporter Vestibule, the inside overhead door is opened and the site transporter proceeds to the Cask Preparation Room, in position under the preparation platform, and stops. The inside overhead door is then closed by a crew member, the brakes for the site transporter are set, the forks are lowered, the power is turned off, and, if required, the platform is closed over the site transporter.

A checklist is signed to indicate that the inside door has been closed and the brakes set. The inner and outer doors have an interlock that normally prevents both doors from being opened simultaneously; however, this interlock can be bypassed. The inner door is a shield door.

E6.4.1.5 Cask Inspection

Once the conveyance is parked in the facility, the crew visually inspects and conducts radiological surveys of the exterior of the cask.

¹¹The radiation protection worker, or health physicist, is not mentioned specifically in each step of this operation; however, there is always at least one radiation protection worker present during this step.

E6.4.1.6 Aging Overpack Lid Bolt Removal

The crew closes the platform shield plate and removes all the cask lid bolts using the cask preparation platform and common tools. Movement of the lid bolts may require the use of the auxiliary crane. Once removed, the bolts are counted and the crew supervisor checks off bolt removal before the site transporter is moved into the Cask Unloading Room.

E6.4.1.7 Aging Overpack/Site Transporter Movement into the Cask Unloading Room

Once the lid bolts are removed, the site transporter operator turns on the site transporter, lifts the fork several inches, and moves the site transporter to the door of the Cask Unloading Room. A crew member opens the shield door and the site transporter operator moves the site transporter into position under the cask port in the Cask Unloading Room. There are physical stop points which the site transporter must bump up against to ensure proper alignment. The crew member lowers the site transporter forks, turns off the site transporter and closes the shield door.

E6.4.2 HFE Descriptions and Preliminary Analysis

This section defines and screens the HFES that are identified for the base case scenario that can affect the probability of initiating events occurring, and that could lead to undesired consequences. Descriptions and preliminary analysis for the HFES of concern during receipt of the site transporter are summarized in Table E6.4-1. The analysis presented here includes the assignment of preliminary HEPs in accordance with the methodology described in Section E3.2 and Appendix E.III of this analysis. Section E4.2 provides details on the use of expert judgment in this preliminary analysis.

Table E6.4-1. HFE Group #4 Descriptions and Preliminary Analysis

HFE ID	HFE Brief Description	ESD	Preliminary Value	Justification
ST Rollover	<i>Operator Causes the ST to Rollover in the Cask Preparation Room: Operator drives over a significantly uneven surface while moving the ST into the Cask Preparation Room, causing the ST to rollover.</i>	2	N/A	Although the center of mass for the ST is higher than that of the truck trailer, this failure mode was omitted from analysis for the same reasons as the truck rollover (Section E6.1). For a site transporter to rollover, the center of mass has to shift laterally. This can be done by traversing a significantly uneven surface or running over a very large object. There are no significantly uneven surfaces in the CRCF Entry Vestibule/Cask Preparation Room. It is incredible for the site transporter to run over an object large enough necessary to significantly shift its center of mass.
060-OpFailStop-HFI-NOD	<i>Operator Fails to Stop the ST if the Tread Fails: If the tread of the ST fails, it is possible the ST can rollover if the operator continues to operate the ST.</i>	2	1.0	If the tread of the site transporter fails, it is possible the site transporter can rollover if the operator continues to operate the site transporter. While it is unlikely that an operator would continue to operate a site transporter if such a significant and visible failure occurred, to be conservative, unsafe actions that require an equipment failure to cause an initiating event are assigned an HEP of 1.0.
060-OpSTCollide1-HFI-NOD	<i>Operator Causes Low-Speed Collision of ST with an SSC while Moving to the Cask Preparation Room: Operator causes collision of ST with facility structure or equipment while moving through the ST Vestibule to the Cask Preparation Room. The ST is physically unable to over speed, so any collision of the ST is a low-speed collision.</i>	2	3E-03	When the site transporter enters the CRCF it can collide into an SSC, such as the facility door, an auxiliary vehicle or improperly stowed crane rigging. Collision of a site transporter is a similar operation and has the same failure modes as the railcar collision HFE (060-OpRCCollide1-HFI-NOD; Section E6.1, HFE Group #1), and was accordingly assigned the same preliminary value. This failure is "highly unlikely" (one in a thousand or 0.001) and was adjusted because there are several ways for a collision to occur and potentially multiple other vehicles (forklifts) that can collide into the conveyance (x3)
060-OpCTCollide1-HFI-NOD	<i>Operator Causes Low-Speed Collision of Auxiliary Vehicle with ST during Preparation Activities: While the ST is parked under the Preparation Platform for Preparation activities, the operator of an auxiliary vehicle can collide into the ST. If the speed governor is functioning, this is a low-speed collision.</i>	5	3E-03	In this step the ST is loaded and parked under the cask preparation platform. The speed of auxiliary vehicles is slow, the site transporter is very visible and procedural controls are expected to limit the number of other vehicles in the Cask Preparation Room during cask operations. This HEP was assigned the same preliminary value as railcar collision HFE (060-OpRCCollide1-HFI-NOD; Section E6.1, HFE Group #1) because the dominant mechanism of both failures is collision with an auxiliary vehicle. This failure is "highly unlikely" (one in a thousand or 0.001) and was adjusted because there are several ways for a collision to occur and potentially multiple other vehicles (forklifts) that can collide into the conveyance (x3). In this case, the preliminary value is particularly conservative because the site transporter is staged under the platform and the railcar/transfer trailer collision HFE has additional failure modes associated with movement of the site prime mover which are not applicable here. This failure is identical for collision with an auxiliary vehicle during preparation activities in a CTT (060-OpCTCollide1-HFI-NOD; Section E6.3, HFE Group #3).
060-OpFLCollide1-HFI-NOD	<i>Operator Causes High-Speed Collision of ST with SSC: Operator can cause an auxiliary vehicle to collide into a loaded ST while the conveyance is parked in the Cask Preparation Room. If the collision is due to the auxiliary vehicle speed governor malfunctioning, then this is a high-speed collision.</i>	5	1.0	The operator can cause an auxiliary vehicle (i.e., forklift) to over speed, resulting in collision with the site transporter while the site transporter is parked under the preparation platform or in transit to or from the platform. In order to accomplish this, the speed governor of the auxiliary vehicle must fail. The site transporter itself is limited by design from going faster than the design speed. To be conservative, unsafe actions that require an equipment failure to cause an initiating event are assigned an HEP of 1.0.
060-OpSpurMove01-HFI-NOD	<i>Operator Causes Spurious Movement of ST during Preparation Activities: The ST is supposed to be turned off, with the control pendant stored during this operation. However, if the ST is not in the proper configuration for cask preparation, the operator can inadvertently cause the ST to move. This spurious movement can cause the ST to collide into the preparation platform.</i>	5	1E-04	In this step the site transporter is parked under the preparation platform; the power is off, with the control pendant stored. For operations in this step there are several crew members on the preparation platform and no operators below the platform. This error was considered to be extremely unlikely (0.0001) because it requires multiple human errors. It would require the site transporter to be left on, the observers (the crane operator, two crew members or the radiation protection worker) would have to fail to notice or fail to stop operations and turn off the site transporter, and an operator would have to access the pendant and signal the site transporter to move. This failure is very similar to spurious movement of the CTT during preparation activities (060-OpSpurMove01-HFI-NOD; Section E6.3, HFE Group #3).
060-OpSTCollide2-HFI-NOD	<i>Operator Causes Low-Speed Collision of ST with an SSC while Moving to the Cask Unloading Room: Operator causes collision of ST with facility structure or equipment while moving the ST under the platform to the Cask Unloading Room. This is a separate HFE from 060-OpSTCollide1-HFI-NOD because this movement of the ST is temporally separate from ST movement to the Cask Preparation Room. This movement is separated by lid unbolting activities.</i>	6	3E-03	The site transporter can collide into an SSC while in transit from the preparation station to the Cask Unloading Room. This operation is virtually identical to site transporter collision while moving into the Cask Preparation Room (060-OpSTCollide1-HFI-NOD; Section E6.4, HFE Group #4) and was thus given the same preliminary value. While in the same HFE group, this collision was considered a separate HFE from 060-OpSTCollide1-HFI-NOD because this action is temporally separate from site transporter movement to the Cask Preparation Room. This movement is separated by lid unbolting activities.
060-OpSDClose001-HFI-NOD	<i>Operator Closes Shield Door on ST: Once the preparation activities are over, an operator turns on the ST, lifts the forks and moves the cask from the Cask Preparation Room to the Cask Unloading Room. There is a shield door between the Cask Preparation Room and the Cask Unloading Room. The operator can impact the cask by inadvertently closing the shield door on the ST as the ST passes through the door.</i>	7	1.0	The site transporter passes through a shield door as it moves from the preparation station into the Cask Unloading Room. During this transfer, the operator can cause the site transporter to collide into the shield door or the operator can close the shield door on the site transporter. See Section E6.0.2.3.3 for a justification of this preliminary value.

Table E6.4-1. HFE Group #4 Descriptions and Preliminary Analysis (Continued)

HFE ID	HFE Brief Description	ESD	Preliminary Value	Justification
060-OpLoadDrop-HFI-NOD	<i>Operator Causes ST to Drop AO:</i> The ST is like a forklift, carrying the AO several inches above the ground on its forks. If the AO is improperly secured onto the ST, it can fall off the forks while in transit or during preparation activities.	2	N/A	There are no crane operations in this step, so the only way for an aging overpack to be dropped is if it falls off the site transporter. The site transporter is like a fork lift, which holds the aging overpack several inches above the ground while in transit. The site transporter cannot lift the aging overpack greater than one foot, so a drop greater than a foot is not plausible in this step. The aging overpack is prevented from moving on or falling off the site transporter by a securing mechanism which locks the aging overpack into place. The site transporter has traveled from the aging pad to the facility. It is highly unlikely that the aging overpack can drop in the facility due to human error, given it has not dropped in transit to the facility. Also, there are interlocks which prevent the site transporter from moving if the aging overpack is not properly secured. Therefore, drop of an aging overpack due to human failure was omitted from analysis.
060-OpAOImpact01-HFI-NOW	<i>Operator Causes AO Impact during Cask Preparation Activities:</i> While unbolting the AO lid, the operator may use the auxiliary crane to remove the bolts. If this occurs, the operator can potentially impact the cask if the crane is moved with the hook lowered below the platform.	5	3E-03	In this step the site transporter is stationed under the Preparation Station and the lid bolts are removed, with the aid of the auxiliary crane. For crane operations in this step there are three observers with clear visibility, the operations are simple, the travel distances are short, and the crane speed is slow. There are no interlocks to prevent this error. No part of the cask is above the preparation platform, and so the only way the site transporter (containing an aging overpack) can be impacted with the crane is if the crane is moved with the load/hook lower than the platform and the crane moves into the platform, causing the load/hook to swing into the site transporter. The likelihood of impacting a cask was assessed to be comparable to the crane impact during upending and removal HFE (060-OpTCImpact01-HFI-NOD; Section E6.2, HFE Group #2: Cask Upending and Removal from Conveyance) and was accordingly assigned the same preliminary value. This failure is "highly unlikely" (one in a thousand or 0.001) but is adjusted because there are several ways for an impact to occur (x3). This is considered a particularly conservative assessment because, in comparison with upending and removal, there are fewer crane movements in this operation, and there is a platform around the site transporter which makes it harder to impact the site transporter.
060-OpTipOver003-HFI-NOD	<i>Operator Causes Tipover of ST:</i> If the operator improperly stows the crane rigging during or after preparation activities, it can catch the ST or cask. If the crane becomes attached to the ST or cask and the operator continues to move the ST or crane, the ST could tip over.	5	1E-04	In this step the site transporter is moved from the site transporter entrance vestibule to the preparation station, the lid bolts are removed, and the site transporter is moved to the Cask Unloading Room. In order to get a tipover of the site transporter, the crane must be attached to the aging overpack or site transporter and the crane or site transporter must also move. At no point in the preparation activities is the crane attached to the aging overpack. The lid bolts may be removed with the aid of the auxiliary crane. Therefore, the only way for the crane to be attached to the cask is if the crane rigging catches the cask or site transporter, probably while moving to or away from the platform. This is unlikely because the site transporter is protected by the platform and shield plate during most of this operation. If the rigging is caught during preparation activities, it is unlikely that the crane operator won't notice while moving the crane. It is also unlikely that, when the site transporter is moving to or from the preparation platform, the site transporter operator and observers won't notice that the rigging has caught the site transporter because a tipover is a slow process. This operation was given the same preliminary value as the cask tipover during upending and removal HFE (060-OpTipover001-HFI-NOD; Section E6.2, HFE Group #2: Cask Upending and Removal from Conveyance) because it has the same dominant failure mode. The crane rigging is improperly stowed and the crew fails to notice before the cask is tipped over. The difference between the two scenarios is that there are more crane operations and more failure modes during upending and removal, and so there would be more opportunities for a tipover in that scenario.
060-OpTipOver3-HFI-NOD	<i>Operator Causes Tipover of ST during Movement to the Cask Unloading Room:</i> The operator can improperly stow the crane rigging and it can catch the ST or AO. If this happens while the ST is moving to the unloading room it can cause the ST to tip over.	6	N/A	The ST, loaded with an AO, undergoes a set of operations which includes operations under the preparation platform and then movement of the ST away from the platform. A tipover of the ST during this set of activities constitutes one HFE because the most likely scenario is that the crane would be attached during preparation and a tipover would happen during movement of the ST away from the platform. The event sequences, however, model a tipover during platform activities and a tipover during ST movement. Because this is only one human failure, the appropriate preliminary value was only modeled in the event sequence associated with platform activities (060-OpTipover003-HFI-NOD above, modeled in ESD 5). The HEP for a tipover in the event sequence associated with the subsequent movement of the ST (060-OpTipOver3-HFI-NOD in ESD 6) was assigned a probability of zero to avoid double counting.
060-OpImpact0000-HFI-NOD	<i>Operator Causes Impact of Cask during Transfer from Cask Preparation Room to the Cask Unloading Room:</i> While moving from the Cask Preparation Room to the Cask Unloading Room, the ST can impact the crane hook or rigging if it is improperly stowed.	6	N/A	While moving from the preparation station to the Cask Unloading Room, the site transporter can impact the crane hook or rigging if it is improperly stowed. The shield plate is closed through the entire set of aging overpack preparation activities. It is unlikely, then, that the crane rigging can be improperly stowed to cause an impact to the site transporter while it is moving to the Cask Unloading Room. It is more likely that rigging can be improperly stored before preparation activities begin and before the site transporter is under the protection of the platform and shield plate. Therefore, any crane interference with the site transporter is already covered by 060-OpAOImpact01-HFI-NOW (Operator Causes Impact between Site Transporter and SSC during Cask Preparation) and 060-OpTipover003-HFI-NOD (Operator Causes Tipover of Site Transporter).

Table E6.4-1. HFE Group #4 Descriptions and Preliminary Analysis (Continued)

HFE ID	HFE Brief Description	ESD	Preliminary Value	Justification
Drop of Object on AO	<i>During AO Preparation Activities the AO Lid Is Unbolted:</i> If the lid bolts are removed with the crane, it is possible that they can be dropped onto the cask.	N/A	N/A ^a	Aging overpack preparation activities simply entail removing the lid bolts. In this step the lid bolts or the tools used to remove the lid bolts can be dropped onto the aging overpack. This failure was omitted from analysis because the bolts and tools were not considered to be "heavy objects."
060-Liddisplace1-HFI-NOD	<i>Operator Inadvertently Displaces Lid:</i> During preparation activities the operator can improperly store the crane rigging such that it catches the lid lift fixture and pulls off the AO lid, resulting in a direct exposure.	17	N/A	In this step the lid is unbolted. Due to design changes to the preparation platform, improperly stowed rigging during this operation won't catch the lid lift fixture. These design changes include raising the platform and adding a shield plate so the cask is recessed underneath the platform.

NOTE: ^a Historical data was used to produce a probability for this HFE. This probability is not covered as part of the HRA, but rather addressed in Attachment C on active component reliability data.
AO= aging overpack; CRCF = Canister Receipt and Closure Facility; ESD = event sequence diagram; HEP = human error probability; HFE = human failure event; N/A = not applicable;
SNF = spent nuclear fuel; SSC = structure, system, or component; ST = site transporter.

Source: Original

E6.4.3 Detailed Analysis

There are no HFEs in this group that require detailed analysis; the preliminary values in the facility model do not result in any Category 1 or Category 2 event sequences that fail to comply with the 10 CFR 63.111 performance objectives; therefore, the preliminary values were sufficient to demonstrate compliance with 10 CFR Part 63 (Ref. E8.2.1).

E6.5 ANALYSIS OF HUMAN FAILURE EVENT GROUP #5: CTM ACTIVITIES: TRANSFER OF A CANISTER INTO OR OUT OF STORAGE, A TRANSPORTATION CASK, A WASTE PACKAGE, OR AN AGING OVERPACK WITH THE CTM

HFE group #5 corresponds to the operations and initiating events associated with the ESD and HAZOP evaluation nodes listed in Table E6.0-1, covering CTM operations. The overall process associated with these operations is graphically depicted in Figure E6.5-1, which shows how various waste forms are moved by the CTM from their transportation cask to their intermediate and final destinations.

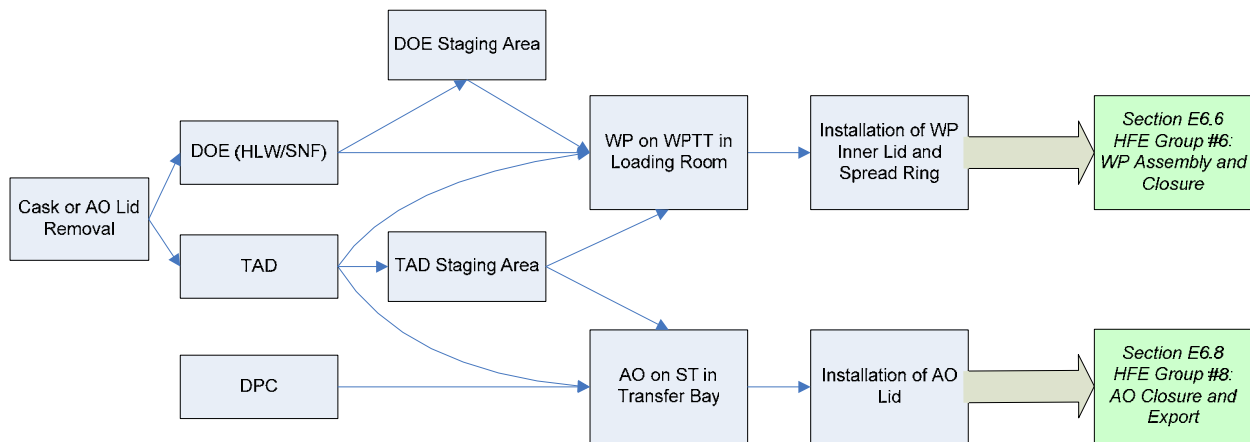

NOTE: § = section; AO = aging overpack; DPC = dual-purpose canister; DOE = U.S. Department of Energy; HFE = human failure event; HLW = high-level radioactive waste; SNF = spent nuclear fuel; ST = site transporter; TAD = transportation, aging, and disposal (canister); WP = waste package; WPTT = waste package transfer trolley.

Source: Original

Figure E6.5-1. Activities Associated with HFE Group #5

The activities covered in HFE group #5, which accomplish the transfers shown in Figure E6.5-1, are shown in Figure E6.5-2. The activities covered in this HFE group begin with a canister in position aligned with a port. The canister could be in a transportation cask, in an aging overpack, or in the staging area. Transportation casks containing TAD canisters and DOE SNF have their lids unbolting, ready for removal and storage by the CTM. Transportation casks containing DPCs have their lids already removed; there are no lids associated with the staging rack. CTM activities include preparing the CTM (attaching grapple and aligning CTM to port), removing the cask lid (if required), removing the canister from the old receptacle, and moving the canister to the appropriate receptacle. Depending on where the canister came from and where it is headed, the appropriate receptacle could be a waste package, an aging overpack, or the staging area. This operation ends when the canister has been placed in its intended location, the CTM has been withdrawn, and the port gate has been closed.

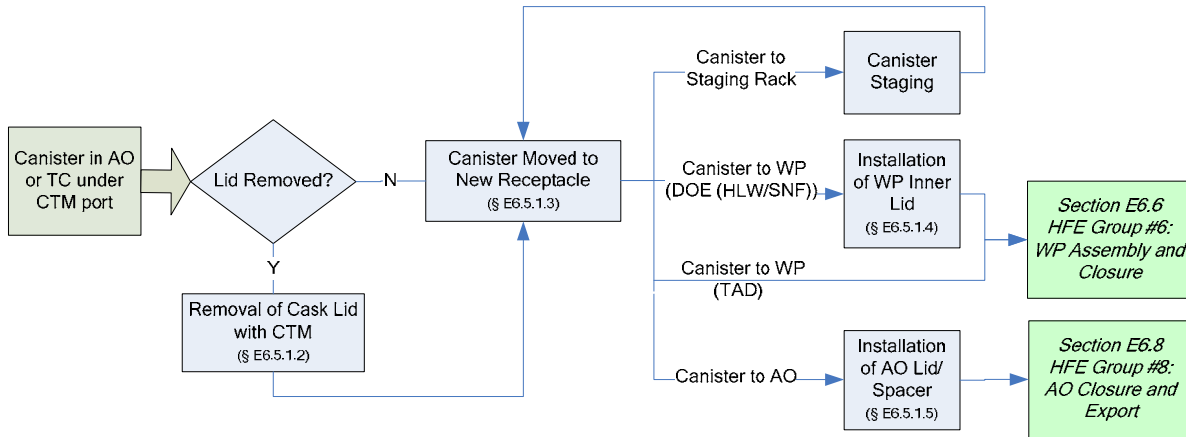

NOTE: § = section; AO = aging overpack; CTM = canister transfer machine; DOE = U.S. Department of Energy; HFE = human failure event; HLW = high-level radioactive waste; SNF = spent nuclear fuel; TAD = transportation, aging, and disposal (canister); TC = transportation cask; WP = waste package; WPTT = waste package transfer trolley.

Source: Original

Figure E6.5-2. CTM Operations Process Flow

E6.5.1 Group #5 Base Case Scenario

There are nine variations with three waste package loading possibilities for the Group #5 base case scenario:

1. Move TAD canister from aging overpack or transportation cask to waste package
2. Move TAD canister from aging overpack or transportation cask to TAD staging area
3. Move TAD canister from staging area to waste package
4. Move TAD canister from transportation cask to aging overpack
5. Move TAD canister from staging area to aging overpack
6. Move DOE (HLW/SNF) canister from transportation cask to DOE staging area
7. Move DOE (HLW/SNF) canister from transportation cask to waste package
8. Move DOE (HLW/SNF) canister from staging area to waste package
9. Move DPC to aging overpack.

Waste package loading configurations:

1. Waste package with one TAD
2. Waste package with one DOE SNF canister and four or five HLW canisters
3. Waste package with two HLW canisters and two DOE SNF canisters (multicanister overpacks)

E6.5.1.1 Initial Conditions and Design Considerations Affecting the Analysis

The following conditions and design considerations were considered in evaluating HFE group #5 activities:

1. From transportation cask/aging overpack—The transportation cask is secure in the CTT or the aging overpack is secure in the site transporter; the transportation cask or aging overpack is in position, aligned under the cask port in the Cask Unloading Room. For non-DPCs, the lid is sitting on the transportation cask or aging overpack, unbolted. The transportation cask and aging overpack have a lid lift fixture attached. For a DPC, the cask lid is removed.
2. From staging—The TAD or DOE canister is sitting in the TAD and DOE staging area, and the door to the staging area is closed.
3. Transfer to aging overpack or waste package—The aging overpack or waste package is stationed under the aging overpack or waste package port, secured, with the lid removed. The waste package is in a WPTT and has a waste package shield ring in place.
4. CTM operations are performed remotely from a control room unless otherwise specified.
5. The CTM has the following safety features and hardwired interlocks:
 - A. Vertical movement and upper limit—The CTM is raised and lowered with the use of an adjustable speed drive (ASD). The ASD has at least three settings: one for lift of canisters, one for lift of objects that do not fit inside the bell (e.g., cask lid), and a maintenance mode. The operator selects the setting and uses the controller to raise the hoist until it automatically stops at the selected setting height.
 - 1) For the canister mode, the ASD automatically stops once the canister clears the bottom of the bell. There is also an optical sensor at the bottom of the bell that, once cleared, stops the hoist and erases the lift command (i.e., can only lower the hoist).
 - 2) For the object mode, the ASD automatically stops the hoist once it clears the port gate. The operator can potentially restart the lift operation and further lift the object.
 - 3) The maintenance mode is fully manual; the ASD does not stop the lift. The optical sensor interlock itself is not to be bypassed; rather, the bell is uncoupled from the trolley, effectively bypassing this interlock. Once the bell and trolley are coupled, the sensor bypass is in effect.

Above the ASD stop point is an upper limit switch that, when reached, stops the hoist from lifting. This first limit switch (final hoist lower limit) effectively erases the lift command. The hoist still has power, but the operator

can only lower the hoist. Roughly a foot above that limit switch is another limit switch (i.e., the final hoist upper limit) that, when reached, cuts off the power to the CTM hoist.

- B. Horizontal movement and port alignment—There is a visually based system that aligns the CTM with the canister such that the grapple can properly engage the canister. The form of this system may use a scheme as simple as laser/target alignment or a more complex system including image recognition software coupled with PLCs. Likewise, horizontal movement and final alignment of the CTM with the cask, waste package, and staging ports is potentially a highly automated process. However, to be conservative, the manual horizontal movement process is analyzed here, generically relying on a visual alignment system and camera for alignment confirmation.
- C. There is an interlock between the shield skirt and the port gate that requires the shield skirt to be lowered in order for the port gate to open. If the automated system is used, the CTM alignment is based on a coordinate system, and the CTM would not be able to move at all if the port gate is open. However, if the process is manual, to get exact alignment, the CTM needs a “jog” feature that allows the CTM to move in small increments while the shield skirt is lowered. There is also a maintenance bypass for this interlock.
- D. There is an interlock between the CTM bridge and trolley travel and the shield skirt position. Neither the CTM bridge nor the trolley can travel while the skirt is lowered.
- E. There is an interlock between the slide gate and shield skirt; the shield skirt cannot be raised unless the slide gate is closed. This interlock can be bypassed for maintenance.
- F. There are interlocks preventing improper hoist movement. The hoist cannot move unless the shield skirt is lowered. This interlock is based on hoist movement, not position, so movement with the hoist too low is not precluded.
- G. There are speed limiters designed into the motors.
- H. There are end-of-travel interlocks on the trolley and bridge.
- I. There are anti-collision interlocks on the CTMs for the CRCF.
- J. There is a weight interlock that cuts off power to the hoist when the crane capacity is exceeded.
- K. There is an interlock that prevents CTM canister grapple (primary grapple) operation if the grapple is not properly connected to the hoist.

- L. There is an interlock between the grapple engagement/position (fully engaged or fully disengaged) and hoist movement. The secondary grapple has the same interlock that is enabled when the power is connected to the grapple.
 - M. The CTM is mechanically or electrically prevented from inadvertent canister disengagement.
 - N. The following grapples are associated with these CTM activities:
 - 1) Lid grapple (for transportation cask, aging overpack, and waste package lids)
 - 2) Shield plug grapple (for waste package shield plug and spread ring)
 - 3) DOE canister grapple (there are multiple types of DOE canister grapples, and the proper grapple depends on where the HLW/SNF came from)
 - 4) DPC canister and TAD canister grapple—The DPC lift adapter matches the TAD canister lifting feature interface.
 - O. It is expected that if the wrong grapple is used, the grapple designs preclude partial or full engagement (i.e., the wrong grapple would be too big, too small, or otherwise mechanically incompatible with the fixture)
 - P. Grapple installation—When the design is finalized, one option under consideration is that an automatic system would be used to remove and attach the grapples. It is expected that such a system would be more reliable than a local manual process. This analysis retains the local manual process so that compliance can be demonstrated without the automatic system.
6. The shield door is closed. There is an interlock between the port slide gates and the shield doors; the port slide gate cannot be open while the shield doors are also open.
7. There are interlocks between the waste package port slide gate and the WPTT. The gate cannot open unless the WPTT is properly aligned under the port and the waste package shield ring is in place. The power to the WPTT is removed when the waste package port gate is open; it reenergizes when the gate closes.

The following personnel are involved in this set of operations:

- CTM operator
- Crew members (two people)
- Supervisor.

Section E5.1.2 provides a more detailed description of the duties performed by each of these personnel.

Figure E6.5-3 and Figure E6.5-4 are simple diagrams illustrating the CTM.

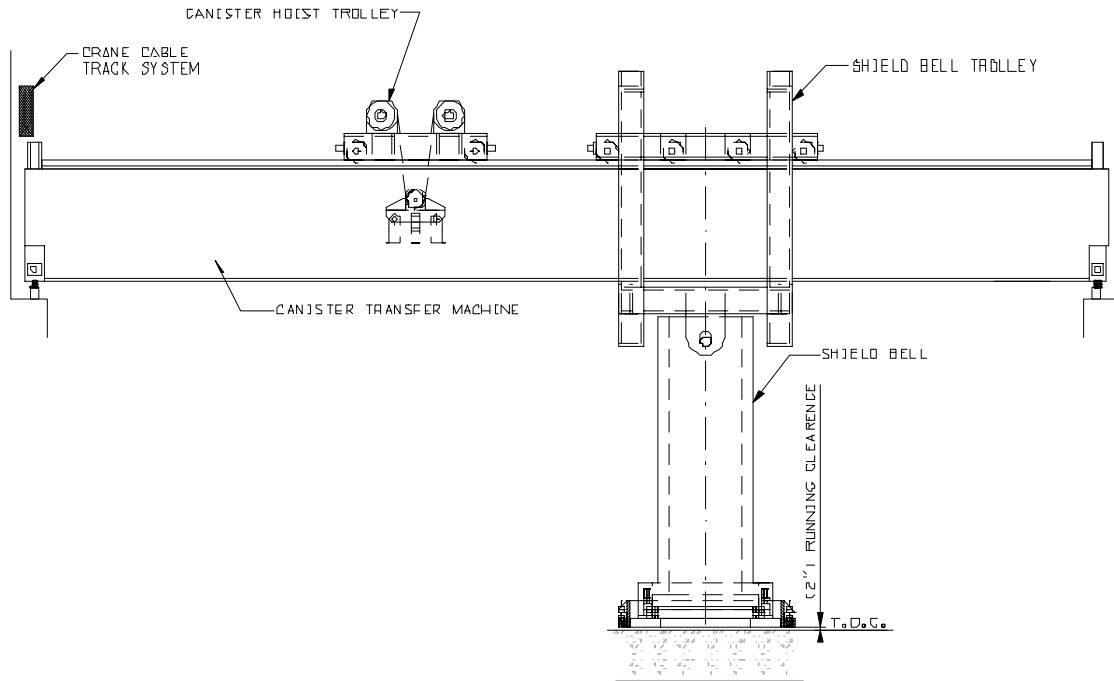

Source: Modified from *CRCF, IHF, RF, and WHF Canister Transfer Machine Mechanical Equipment Envelope* (Ref. E8.1.6)

Figure E6.5-3. Canister Transfer Machine—Side View

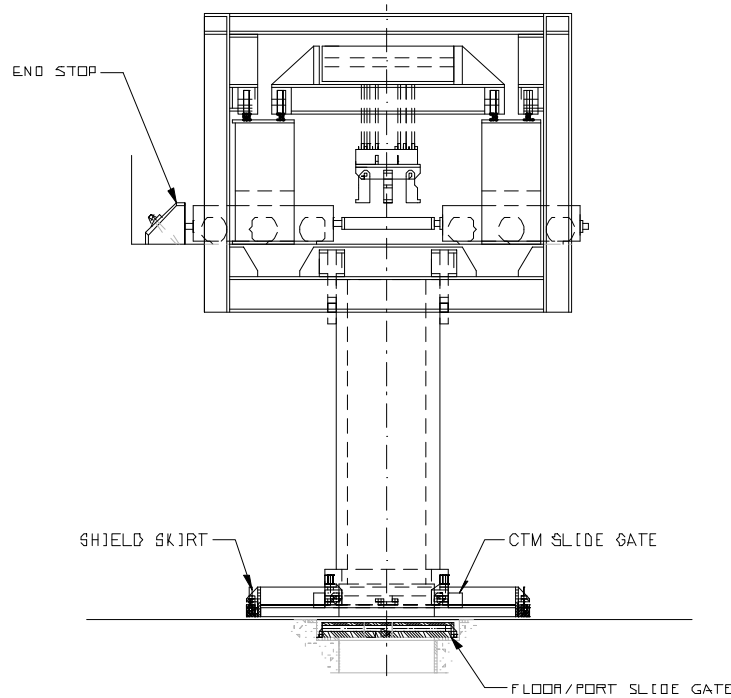

Source: Modified from *CRCF, IHF, RF, and WHF Canister Transfer Machine Mechanical Equipment Envelope* (Ref. E8.1.6)

Figure E6.5-4. Canister Transfer Machine—End View

E6.5.1.2 Removal of Transportation Cask or Aging Overpack Lid with CTM (for TAD Canister or DOE SNF)

Proper Grapple Installation—The CTM operator moves the CTM to the CTM maintenance area (Canister Transfer Room floor), where a crew member manually takes off and stores the grapple attached to the CTM (i.e., canister grapple) and replaces it with the lid grapple. The CTM operator also ensures that the ASD is set to the appropriate setting to lift the canister.

Moving CTM to Cask Port—The CTM operator uses a visual alignment system and a camera to position the CTM, with the lid grapple, over the cask port (or staging area). There is a position indicator, along with a camera view, so the operator knows when the CTM is in position.

Opening CTM Slide Gate and Port Slide Gate—The CTM operator remotely lowers the skirt shield, opens the CTM slide gate, and opens the cask port or TAD canister and DOE staging area slide gate once the CTM is in place.

Lifting Cask (Transportation Cask or Aging Overpack) Lid into CTM and Slide Gate Closure—The operator first sets the ASD to lid lift mode and then lowers and engages the lid grapple; the grapple does not lower unless the slide gate is open and skirt is lowered. Grapple engagement is manual and is verified visually via camera and via an indicator. Once the grapple

is engaged and verified, the operator then lifts the cask lid up to the bottom of the CTM bell just past the CTM slide gate. At this point the operator closes the port and CTM slide gates.

Moving CTM to Transportation Cask or Aging Overpack Lid Station and Lowering Lid to Lid Station—The CTM operator lifts the CTM skirt and moves the CTM with lid to the lid station. Once at the lid station, the operator lowers the lid, disengages the grapple, lifts the grapple, resets the ASD to canister lift setting, closes the slide gate, and lifts the skirt. A camera is used to ensure that the lid is staged in the proper location. Once the lid is removed, the lid lift grapple is replaced with the proper canister lifting grapple as described in step 1. The CTM is positioned above the correct port for removal of the canister.

E6.5.1.3 Move Canister to New Receptacle (All Variations)

Proper Grapple Installation—The CTM operator moves the CTM to the CTM maintenance area (Canister Transfer Room floor), where a crew member manually takes off and stores the grapple attached to the CTM (either a lid grapple or canister grapple) and replace it with the appropriate canister grapple (i.e., a DPC grapple, a TAD canister grapple, or one of five DOE grapples). The CTM operator also ensures that the ASD is set to the appropriate setting to lift the canister.

Moving CTM to Cask Port—The CTM operator uses a visual alignment system and camera to position the CTM, with lid grapple, over the cask port (or staging area). There is a position indicator, along with a camera view, so the operator knows when the CTM is in position. Once in position, the CTM operator then lowers the shield skirt.

Opening CTM Slide Gate and Port Slide Gate—Once the CTM is in position over the cask or staging location port, with the shield skirt lowered, the CTM operator remotely opens the CTM slide gate and the cask port slide gate.

Lifting Canister into CTM—The CTM operator again looks at the relative canister and hoist position and adjusts the alignment if necessary to ensure that the CTM is over the canister (some casks have several canisters). This final adjustment is done with the alignment system, in conjunction with a camera view. Once the CTM is appropriately aligned to the canister, the operator lowers the canister grapple and engages the grapple. Grapple engagement is automatic, but it is verified visually via camera and an indicator. The operator then lifts the canister by holding down a controller (i.e., joystick) until the ASD automatically stops the lift.

Closing CTM Slide Gate and Port Slide Gate—Once the canister is raised inside the bell, the operator closes the CTM slide gate, closes the port slide gate, and lifts the CTM skirt in preparation for movement.

Moving CTM to Destination Port—The CTM operator moves the CTM from the cask port into position over the waste package or aging overpack port or over the TAD and DOE staging area using a visual alignment system in conjunction with a camera view to ensure alignment with the port. Once positioned, the operator lowers the skirt of the CTM.

Opening CTM Slide Gate and Port Slide Gate—The CTM operator then opens the CTM slide gate and the waste package port, aging overpack port, or TAD canister and DOE staging area slide gate.

Lowering Canister—Once the port gate is open, the operator verifies alignment using a visual alignment system in conjunction with a camera view; if the canister is not properly aligned, the CTM operator makes fine adjustments of the CTM position until alignment is verified. The operator then lowers the canister into position in the waste package port, aging overpack port, or storage area (the TAD canister has two staging positions, and the DOE canister has 10 staging positions); disengages the grapple; verifies disengagement (via camera and indicator); and then retracts the grapple.

*Variation on grapple disengagement: To disengage the DOE grapple, the operator must set the load down, lift it up, and set it back down.

Closing CTM Slide Gate and Port Slide Gate—Once the grapple is raised, the operator closes the CTM Slide Gate; closes the waste package port, aging overpack port, or TAD canister and DOE staging area slide gate; and lifts the CTM skirt in preparation for movement.

E6.5.1.4 Preparing Waste Package for Closure

For unshielded canisters that were transferred to waste packages for export, the following steps are applicable (Note: This step is not applicable to TAD canisters in a waste package; they are moved directly to the Waste Package Closure Room without further preparation):

Grapple Exchange—The CTM operator moves the CTM to the CTM maintenance area, where a crew member manually removes the canister grapple and attaches the inner lid grapple. At this point, the CTM operator sets the ASD to the proper setting for lifting the waste package inner lid (shield plug with spread ring). The operator then closes the slide gate and lifts the skirt.

Moving CTM to Waste Package Inner Lid Station—Once the skirt is lifted, the operator remotely moves the empty CTM and positions it over the waste package inner lid station, lowers the skirt, and opens the CTM slide gate.

Lifting the Waste Package Inner Lid into the CTM—Once the CTM is positioned, the operator then lowers the grapple, engages the grapple, verifies the grapple engagement via camera and indicator, and lifts the waste package inner lid into the CTM. The CTM operator then closes the CTM slide gate and lifts the skirt. Quality assurance verifies this step.

Moving Waste Package Inner Lid to Waste Package—The operator remotely moves the CTM and positions it over the waste package. To do this, the operator uses a visual alignment system in conjunction with a camera view to ensure alignment with the center of the port.

Opening Waste Package Port Slide Gate, Placing Waste Package Inner Lid in Waste Package, and Closing Waste Package Slide Gate—The CTM operator lowers the skirt, opens the waste package port slide gate, opens the CTM slide gate, and lowers the inner lid into position. Once in position the operator disengages the grapple, verifies full disengagement (via

camera and indicator), retracts the grapple, and then closes the waste package and CTM slide gates.

E6.5.1.5 Preparing Aging Overpack to Leave Cask Unloading Room

For canisters that were transferred to aging overpacks for export, the following steps are applicable:

Grapple Exchange—The CTM operator moves the CTM to the CTM maintenance area, where a crew member removes the canister grapple and attaches the lid grapple. The operator then closes the slide gate and lifts the skirt. The CTM operator also sets the ASD to the proper setting for moving the aging overpack lid.

Install Aging Overpack Spacer (if required)—Once the skirt is lifted, the CTM operator retrieves the aging overpack spacer, moves the CTM to the aging overpack, lowers the shield skirt, opens the port and CTM slide gates, and lowers the hoist. Once the spacer is in place, the CTM operator disengages the grapple, retracts the hoist, closes the CTM port and slide gates, and lifts the shield skirt for movement.

Moving CTM to Aging Overpack Lid Station and Retrieving Lid—Once the skirt is lifted, the operator moves the CTM and positions it over the aging overpack lid station. The operator then lowers the grapple, engages the grapple, verifies the engagement (via camera and indicator), and lifts the aging overpack lid.

Moving CTM to Cask Port—The CTM operator positions the CTM, with lid, over the aging overpack cask port and lowers the skirt. The operator uses a visual alignment system in conjunction with a camera view to ensure alignment with the port.

Opening Cask Port Slide Gate and Placing Lid on Aging Overpack—Once the skirt is lowered, the operator remotely opens the cask port slide gate, confirms alignment (via the visual alignment system and camera), and lowers the lid into position. The CTM operator then disengages the grapple, verifies that the grapple is disengaged (via indicator and camera), and retracts the grapple.

Closing Cask Port Slide Gate—Once the grapple is retracted, the operator remotely closes the cask port slide gate.

E6.5.2 HFE Descriptions and Preliminary Analysis

This section defines and screens the HFES that are identified for the base case scenario, that can affect the probability of initiating events occurring, and that could lead to undesired consequences. Descriptions and preliminary analysis for the HFES of concern during canister transfer with the CTM are summarized in Table E6.5-1. The analysis presented here includes the assignment of preliminary HEPs in accordance with the methodology described in Section E3.2 and Appendix III of this analysis. Section E4.2 provides details on the use of expert judgment in this preliminary analysis.

Table E6.5-1. HFE Group #5 Descriptions and Preliminary Analysis

HFE ID	HFE Brief Description	ESD	Preliminary Value	Justification
060-OpCTMdrop001-HFI-COD	<i>Operator Drops Object onto Canister during CTM Operations:</i> Some variations of CTM activities require heavy objects to be moved over the canister; some TC and all AO lids are removed, and WP inner lids are also installed. It is possible that these objects can be dropped onto the canister while being lifted with the CTM.	9	2E-03	In this step, the operator can potentially drop the cask lid, waste package inner lid, or waste package spread ring onto the canister. There are several ways for this failure to occur, including the following: Operator fails to fully engage or disengage the grapple before lifting the hoist (i.e., resulting in partial engagement of the grapple). There is an indicator and camera view by which the operator is required to verify engagement. There is also an interlock that does not allow the hoist to move unless the grapple is fully engaged or fully disengaged. This interlock does not have a bypass. Operator fails to properly connect the grapple to the CTM when switching grapples. Operator lifts the lid with the CTT significantly misaligned with the cask port. This misalignment can cause part of the lid to be caught under the second floor. If the CTM keeps pulling, the cable can snap and the lid can drop. There are several electromechanical safeguards preventing this, including load cell interlock, motor temperature interlock, and the cable design. (A similar failure can occur if the CTM is moved with an object below the floor; however, this event is treated separately in 060-OpCTMImpact1-HFI-COD.) Operator lifts the object too high. The only object that is lifted over a canister is the lid. The bell is flared at the bottom to accommodate the cask lid; if the operator puts the ASD in maintenance mode or sets it in canister mode, then the lid can be lifted until it hits the inside of the bell. If the CTM operator continues trying to lift, the cable can snap, causing the lid to drop onto the canister. There are several electromechanical safeguards preventing this, including load cell interlock, motor temperature interlock, and the cable design. The preliminary value was chosen based on the determination that this failure is "highly unlikely" (0.001) and was adjusted because there are several ways for a drop to occur and, because the operation is performed remotely, this is a somewhat complex process (×2) as opposed to an extremely complex process (which would be ×3). This HFE was assessed to be less likely than a cask impact or an RC/TT collision, and the preliminary value reflects this.
060-OpCTMdrop002-HFI-COD	<i>Operator Drops Canister during CTM Operations:</i> All variations of CTM activities require the canister to be lifted and transferred to the staging area, to a WP, or to an AO. During this lift, the operator can drop the canister (e.g., by improper grapple engagement).	9	2E-03	Moving a canister with the CTM is very similar to moving an object with the CTM during cask transfer (060-OpCTMdrop001-HFI-COD) and has the same failure modes. The only difference between moving a canister and moving an object (specifically, the lid) is that a canister drop due to lifting too high results in a high drop (e.g., a two-block) as opposed to a design-limit drop, which is analyzed separately. Therefore, it was considered conservative to assign the same preliminary value to this HFE.
060-OpCTMDrInt01-HFI-COD	<i>Operator Lifts Object or Canister too High with CTM:</i> It is possible that, while lifting objects such as the canister or WP inner lid, the operator can cause a two-block by lifting the object too high.	9	1.0	When lifting the canister, the operator can lift it too high, resulting in a two-block event and drop of the canister. In order to accomplish this failure, the interlocks (e.g., optical sensor) and other anti-two-block equipment (e.g., limit switches) must also fail. To be conservative, unsafe actions that require an equipment failure to cause an initiating event have generally been assigned an HEP of 1.0.
060-OpNoUnBolt00-HFI-NOD	<i>Operator Fails to remove Lid Bolts, Resulting in Impact, Drop, or Tip Over:</i> If the operators failed to remove all or some of the lid bolts from the cask, when they attempted to remove the cask lid with the CTM, the load would be significantly heavier than the CTM is rated for, and result could be a drop of the cask.	9	1E-03	If the lid bolts were not all removed during preparation activities and the CTM operator does not notice, one of two things may happen: the operator may attempt to lift the cask and the bolts may break, or the CTM operator may attempt to lift the cask and the bolts may hold. If the bolts hold, the load cell stops the CTM from lifting before the cask can be lifted. This failure was not assigned a 1.0 like other failures, which are ANDed with mechanical failures because the load cell is never bypassed and the HFE requires several independent human failures. For this failure to occur, the preparation crew must fail to remove all the bolts and must fail to verify on the checklist that all the bolts have been removed. Independently, the CTM operator would also have to fail to notice that the entire cask is lifting as the lid is lifted into the CTM. This failure was assessed to be "highly unlikely" (0.001) because it involves two human failures by different teams and significant inattention to the operation. This operation is performed daily and also corresponds closely to the generic human-induced initiator, "failure to properly conduct an operation performed on a daily basis," which also has a default probability of 0.001.
060-OpNoUnBoltDP-HFI-NOD	<i>Operator Fails to Remove Lid Bolts, Resulting in Impact, Drop, or Tip Over (DPCs)</i>	9	N/A	There is no lid on casks containing a DPC; therefore, this failure mode was omitted from analysis.

Table E6.5-1. HFE Group #5 Descriptions and Preliminary Analysis (Continued)

HFE ID	HFE Brief Description	ESD	Preliminary Value	Justification
060-OpCTMImpact1-HFI-COD	<i>Operator Moves the CTM while Canister or Object is below or between Levels:</i> If the operator moves the trolley before the canister has cleared the port gate, then the canister can impact the floor if the canister is between levels. If the canister or the lid is completely below the floor, this failure can result in the cable snapping and the canister or object dropping. For canisters, the shear event (movement while the canister is between floors) is the bounding event.	9	1E-03	The operator can inappropriately move the CTM while the canister or lid is below the port gate or while the canister is between levels. If this inadvertent movement occurs while the canister is between levels, it can result in an impact and shear force to the canister. If the movement occurs while the canister is below the port gate, then the cable can snap, resulting in a drop. In order to accomplish this inadvertent movement, the operator would have to fail to follow proper lifting procedures and operate the ASD in manual or lid lift mode. If the lift is done in manual mode, then the CTM operator can fail to lift the canister or object high enough to clear the floor before horizontal movement. If it is in lid lift mode, it would automatically stop too soon, but the operator would have to fail to notice that the canister is not high enough when closing the port and CTM slide gates on the canister. For a canister, the operator would also have to fail to rely on the optical sensor and must also fail to close the slide gate to accomplish this HFE. There are interlocks, such as the load cell interlock, that prevent the CTM from exerting enough force to snap the cable and drop the canister or object. There is also an interlock that prevents horizontal motion if the slide gate is not closed, but this interlock can be bypassed during normal maintenance. Due to the complicated nature of this failure, the interlock was not separately modeled for this HFE. Rather, it was included in the preliminary value. This failure was considered highly unlikely and accordingly assigned a preliminary value of 0.001.
060-OpCICTMGate1-HFI-NOD	<i>Operator Inappropriately Closes Slide or Port Gate during Vertical Canister Movement and Continues Lifting:</i> If the operator signals the CTM slide gate or port gate to close while the canister is being raised, it can result in a canister impact if the door closes on the canister, or it can result in a canister drop if the door closes on the hoist, severing the cables. The NSDB requires the gate motors to be sized such that they cannot damage the canisters; the gate cannot sever the cables either. This failure can, however, result in a drop if the operator closes the slide gate on the cables and continues hoisting such that the canister is stuck and the cable snaps.	9	1E-03	In this operation, the CTM operator is lifting and lowering the canister. The slide gate cannot damage the canister or sever the hoist cables, so the failure required here is for the operator to prematurely close the slide gate and keep hoisting such that the canister catches on the slide gate and the hoist cable snaps. There are two slide gates for each motion—the CTM slide gate and the cask and waste package port slide gate. The operator performs CTM operations daily and has a camera view of the operations. There is no interlock to prevent this error, but if the canister is lifted per the procedure, the operator would use the ASD and not close the gate until the ASD has stopped. It is unlikely the operator would try to close the slide gate while lifting the canister; the most likely scenario is for the operator to fail to lift the canister high enough, close the slide gate as if to move the CTM, and then notice that the canister is too low and try to lift the canister without first opening the slide gate. In order for the operator to fail to lift the canister high enough, the ASD has to have a mechanical failure, or the ASD has to be in the wrong mode. The manual mode is only accessible by entering a password. Because lifting is a slow procedure, it is unlikely that the operator would, if it is even possible, put the ASD in manual mode. If the ASD is in manual mode, it is unlikely that the operator would stop the canister too soon because, independent of the ASD, the optical sensor in the bell stops the canister once it has cleared the bell. The more likely case is that the operator would fail to restore the ASD to canister lift mode after moving the lid. For all waste forms except the DPC, the lid is removed in the previous step. In addition to failing to change ASD mode, the operator must also fail to visually verify the height of the canister before closing the slide gate. In either case, if the operator does stop the canister too soon and closes the slide gate, the operator would still have to forget to reopen the slide gate before resuming the lift in an attempt to correct the error. This failure was assessed to be “highly unlikely” (0.001) because it involves several unlikely failures and significant inattention to the operation. This operation is performed daily and also corresponds closely to the generic human-induced initiator “failure to properly conduct an operation performed on a daily basis,” which also has a default probability of 0.001.
060-OpCTMImpact2-HFI-COD	<i>Operator Causes Canister Impact with Lid during CTM Operations (non-DPC):</i> The cask or AO lid, when removed by the CTM, is staged such that the canister must travel over it to move across the Cask Transfer Room. If the lid is improperly stowed, the CTM can collide with the lid. This failure mode is not applicable to DPCs because the cask lid is removed in the Cask Preparation Room.	9	N/A	The lid staging area is in the pathway of the CTM; if the lid is improperly stored, the CTM, carrying a canister, can potentially impact the lid. This failure was omitted from analysis because, if the lid was stored such that it was an obstruction to the CTM, the CTM would run into the lid as it returns to the cask from lid staging. At that point, the error would have to be corrected before operations continued.
060-OpCTMImpact5-HFI-COD	<i>Operator Causes Canister Impact with SSC during CTM Operations (All):</i> If the CTM is moved too far while transferring a canister, it can collide into an end stop and impact the inside of the CTM bell or hit an SSC.	9	1.0	In this step, the operator can potentially impact the canister in several ways: CTM bridge impacts end stops while moving canister CTM trolley impacts end stops while moving canister Bridge used to move canister impacts other bridge. In order to accomplish any of these, however, additional equipment failures must also occur. To be conservative, unsafe actions that require an equipment failure to cause an initiating event have generally been assigned an HEP of 1.0.
060-OpCTMImpact3-HFI-COD	<i>Operator Causes Two CTMs to Collide:</i> In the CRCF, there are two CTMs and two parallel lines for canister transfer. If two canisters are processed simultaneously and one operator moves the CTM bridge too far, the other CTM can potentially be impacted. There is an anti-collision interlock on the CTM to prevent this failure.	9	1E-01	In the CRCF, it is possible for two CTMs to run into each other during canister transfer. Both CTMs are equipped with an anti-collision interlock that must also fail for an initiating event to occur. Both CTM operators are in one control room, both are aware of the other’s operations, and any simultaneous CTM movement is pre-coordinated. This failure was assessed as a likely (0.1) failure because of the potential complexity of dual operations and the potential for poor communication. There are anti-collision interlocks on the CTM to prevent this error.

Table E6.5-1. HFE Group #5 Descriptions and Preliminary Analysis (Continued)

HFE ID	HFE Brief Description	ESD	Preliminary Value	Justification
060-OpDirExpose1-HFI-NOD	<i>Operator Causes Direct Exposure during CTM Activities (First Floor, All CTM Movements):</i> If an operator inadvertently opens the shield door and enters the Cask Unloading Room while the canister is being lifted out of the cask, that operator would get a direct exposure. Likewise, if the operator inadvertently opens the port gate when the CTM is not over the cask or WP with its shield skirt lowered, then an operator on the second floor (Canister Transfer Room) can get a direct exposure.	18	1E-01	Direct exposure during CTM activities can happen if an operator inadvertently opens the shield door to the Canister Transfer Room while the canister is being lifted, or if an operator opens the port gate (with a cask under it) while the shield skirt is not lowered over the port. In order to accomplish either of these scenarios, an interlock must also fail. The shield door cannot be easily bypassed and is never bypassed during normal operations or normal maintenance. As was previously discussed, the HRA team has generally assigned unsafe actions that are combined with interlocks an HEP of 1.0. As was also discussed, if this very conservative approach did not demonstrate compliance with the performance objectives of 10 CFR 63.111(Ref. E8.2.1) then the HRA team would consider whether a lower preliminary value was justified. That is the case here. In further considering this event, it would be very difficult to make it happen. An extraordinary bypass of the interlock or a random failure of the interlock would be required. Then, a worker would have to violate all administrative controls and training and attempt to enter the room without appropriate clearance from the control room. The operator would also have to conduct the operation improperly since failure of the interlock does not directly result in exposure potential if the operator still conducts the operation correctly (i.e., the interlock would not be challenged unless an additional error was made). To a large extent, all of these things are independent because they are unsafe actions by different individuals doing different things at different times. Therefore, the HRA team feels justified in assigning a lower preliminary value of 0.1 to the unsafe action (still believed to be quite conservative), which, in combination with the interlock failure value, results in an overall value of 3E-6/demand for an exposure.
060-OPCTMDirExp1-HFI-NOD	<i>Operator Causes Direct Exposure during CTM Activities (Second Floor, All CTM Movements):</i> If the CTM operator fails to close the port gate before lifting the shield skirt after placing a canister in a receptacle (e.g., staging rack, AO, or WP) and a worker violates the procedural control by entering the Cask Transfer Room during canister transfer activities, that worker would be exposed.	18	1E-04	Closure of the port gate is a simple action that is performed multiple times in a day. This action is performed every time the CTM is moved without deviation, and the operator is trained on the consequences associated with this failure. In addition to these failures, a completely independent failure, involving violation of a strict procedural control by inappropriately entering a radiation controlled area, by a person of a separate "team" must also occur. This HFE was considered extremely unlikely and assigned a preliminary value of 0.0001.
060-OpDirExpose2-HFI-NOD	<i>Operator Causes Direct Exposure during CTM Activities (Movement into AO):</i> For canister loading in an AO, if the AO is not pre-staged in the Cask Unloading Room, the operator can lower the canister to the floor of the Cask Unloading Room and then place the AO lid directly on the canister. The next step in operations is movement of the AO to the Cask Preparation Room. The ST operator would be exposed as part of the normal operations of this step (i.e., entering the Cask Unloading Room to retrieve the AO). There is an interlock that prevents the port gate from opening if a receptacle (AO) is not below the port.	18	1E-4	Operators can also cause direct exposure during CTM operations by failing to stage an aging overpack in the Cask Unloading Room and then placing the canister on the floor of the Cask Unloading Room and opening the shield door. Placing the aging overpack beneath the cask port is part of the staging activities before CRCF operations for aging overpack loading. Aging overpack staging is checked off by the staging crew and is also checked off by the operations crew directly before operations begin as part of the prejob plan. If the aging overpack is not staged, the CTM operator has the chance to notice when emplacing the canister inside the aging overpack (via a camera view looking down on the aging overpack). If the canister is emplaced on the floor, then the operator has an additional chance to notice that the aging overpack is missing when trying to put the aging overpack lid on the aging overpack with the CTM. This failure received a preliminary value of 0.01 for failure to pre-stage the aging overpack and 0.01 for failure to notice before a direct exposure occurs, resulting in a total preliminary value of 0.0001. This preliminary value is consistent with the preliminary value for failure to install a waste package shield ring (Section E6.7, HFE Group#7: Waste Package Export; 060-OpShieldRing-HFI-NOD), which has a very similar failure mode. There is an interlock that prevents this failure, but because this interlock may be bypassed during normal maintenance, the bypass is explicitly modeled in HFE 060-OpFailRstInt-HFI-NOM.
060-OpStageRack1-HFI-NOD	<i>Operator Causes Direct Exposure during Canister Staging:</i> For the canister staging, if the CTM operator fails to close the port gate and the supervisor fails to follow the procedural control and check that the port gates are closed before the end of canister transfer activities, when a worker enters the Transfer Room during normal activities, the worker would be exposed.	18	1E-03	Closure of the port gate is a simple action that is performed multiple times in a day. This action is performed every time the CTM is moved without deviation, and the operator is trained on the consequences associated with this failure. The supervisor has to double check the work of the CTM operator; however, the supervisor is part of the same "team" as the CTM operator. A preliminary value of 0.001 was assigned to this failure because it corresponds to the default probability of a "highly unlikely" error and also the default probability of a simple failure of an operation that is performed daily.
060-OpFailRstInt-HFI-NOM	<i>Operator Fails to Restore Interlock after Maintenance:</i> There are several interlocks that may be bypassed during normal maintenance. Failure to restore the interlock which prevents the port gate from opening before a receptacle is placed underneath the port is explicitly modeled here. If the bypass is not restored, this could result in a direct exposure due to the HFE above (HFE 060-OpDirExpose2-HFI-NOD)	18	1E-02	If the maintenance bypass for the interlock which prevents the cask port gate from opening before a waste package is placed underneath the port bypass is not restored, it could result in a direct exposure due to HFE 060-OpDirExpose2-HFI-NOD. This interlock would be bypassed during CTM maintenance. This failure would require the crew member to fail to reset the bypass and the crew member to fail to properly perform the prejob check of the CTM equipment. These failures were assigned a preliminary value of 0.01, which corresponds to the generic preliminary value for the pre-initiator "failure to properly restore an operating system to service when the degraded state is not easily detectable."

Table E6.5-1. HFE Group #5 Descriptions and Preliminary Analysis (Continued)

HFE ID	HFE Brief Description	ESD	Preliminary Value	Justification
060-OpFailSG-HFI-NOD	<i>Operator Fails to Close the CTM Slide Gate before Moving the CTM with the Canister inside the Bell:</i> If the canister is inside the CTM with the shield skirt raised and the slide gate open, then personnel on the Canister Transfer Room floor may get a direct exposure. This configuration is achieved if the operator fails to close the CTM slide gate and then raises the shield skirt to move the canister to a new receptacle. There is an interlock that does not allow the shield skirt to rise if the slide gate is open.	18	1E-03	Direct exposure during CTM activities can happen if there is a canister in the bell and the CTM slide gate is open while the shield skirt is raised. The most likely way to get this configuration is for the operator to forget to close the slide gate and then raise the shield skirt to move the CTM as per normal operations. There is an interlock that prevents this failure, but because this interlock may be bypassed during normal maintenance, the bypass is explicitly modeled in HFE 060-OpFailRstInt-HFI-NOM. This operation is performed multiple times a day and, for every CTM lift, the operator closes the slide gate before lifting the shield skirt. This operation is performed by a highly trained operator and also corresponds closely to the generic human-induced initiator "failure to properly conduct an operation performed on a daily basis," which also has a default probability of 0.001. No adverse PSFs were identified in this operation that would merit adjusting this preliminary value.
060-OpNoUnplugST-HFI-NOD	<i>Operator Fails to Disconnect Power Supply from ST in the Cask Unloading Room:</i> When the ST is moved to the Cask Unloading Room and positioned under the cask port, the operator is supposed to lower and turn off the ST. If the ST operator fails to disconnect the ST from the power source, the ST can get a spurious signal during canister lifting that can cause a collision of the ST into the canister.	9	1E-03	While in the Canister Transfer Room, the site transporter is off with the load lowered. The site transporter is controlled locally (i.e., via pendant), and there are no operators in the Canister Transfer Room during CTM operations. In order to cause a spurious movement of the site transporter, the operators must fail to disconnect the site transporter from the power source, and the controller must send a spurious signal to the site transporter. The connection point for the site transporter is outside of the Cask Unloading Room, in the Cask Preparation Room. In order for this failure to occur, when exiting the Cask Unloading Room and closing the shield door, the personnel would have to fail to notice the cord going in through the shield door. If the shield door does not sever the power cord, then there is an interlock that prevents this error: the interlock prevents the port gate from opening (and thus CTM activities commencing) if the shield door is not completely closed. The shield door cannot be easily bypassed and is never bypassed during normal operations or normal maintenance. This failure was assessed to be "highly unlikely" (0.001) because it involves several unlikely failures and significant inattention to the operation. This operation is performed daily and also corresponds closely to the generic human-induced initiator "failure to properly conduct an operation performed on a daily basis," which also has a default probability of 0.001.
060-OpNoDiscoAir-HFI-NOD	<i>Operator Fails to Disconnect Air Supply from CTT in the Cask Unloading Room:</i> When the CTT is moved to the Cask Unloading Room and positioned under the cask port, the operator is supposed to disconnect the air supply from the CTT. If the operator fails to do so, the CTT can get a spurious signal during canister lifting that can cause a collision of the CTT into the canister.	9	1E-03	While in the Canister Transfer Room, the CTT is parked with the air supply disconnected. The CTT is controlled locally (i.e., via pendant), and there are no operators in the Canister Transfer Room during CTM operations. In order to cause a spurious movement of the CTT, the operators must fail to disconnect the CTT from the air source, and the controller must send a spurious signal to the CTT. The connection point for the CTT is outside of the Cask Unloading Room in the Cask Preparation Room. In order for this failure to occur, when exiting the Cask Unloading Room and closing the shield door, the personnel would have to fail to notice the hose going in through the shield door. If the shield door does not sever the air hose, then there is an interlock that prevents this error: the interlock prevents the port gate from opening (and thus CTM activities commencing) if the shield door is not completely closed. The shield door cannot be easily bypassed and is never bypassed during normal operations or normal maintenance. This failure was assessed to be "highly unlikely" (0.001) because it involves several unlikely failures and significant inattention to the operation. This operation is performed daily and also corresponds closely to the generic human-induced initiator "failure to properly conduct an operation performed on a daily basis," which also has a default probability of 0.001.
Spurious movement of CTT or ST during CTM activities	<i>Operator Causes Spurious Movement of CTT or ST while Canister is Being Loaded</i>	9	N/A	The CTT is locally controlled and sitting in the Unloading Room deflated. The ST is locally controlled and sitting in the Unloading Room disconnected from a power source. There are no personnel in the Unloading Room during this operation, and there is an interlock on the shield door that prevents access to the room while the canister is being removed from the cask. This failure was omitted from analysis because it involves several mechanical and human failures, including violation of the procedural control which restricts access to the Unloading Room. Furthermore, if a person enters the Unloading Room during canister removal, they would receive a direct exposure; this failure is captured in 51A-OpDirExpose1-HFI-NOD.
060-OpWPTTSpur01-HFI-NOD	<i>Operator Causes Spurious Movement of WPTT while Canister is Being Loaded:</i> The WPTT is controlled remotely. If the operator sends a signal for the WPTT to move during canister lowering, the WPTT would impact the canister.	9	1E-03	While the canister is being lifted with the CTM, an operator can inadvertently signal the WPTT to move. The controls for the WPTT are on a separate control board, and the WPTT operator is not involved in the CTM operations. The WPTT operator does not begin work until after the CTM operator is done and hands off the checklist to the WPTT operator. This failure would require a significant departure from normal operations; the analysts could not identify any contexts in which the WPTT or CTM operator would believe it was appropriate to move the WPTT during this operation. In order for the WPTT to move while a canister is being loaded, an interlock must also fail. This failure was assessed to be "highly unlikely" (0.001) because it involves several unlikely failures and significant inattention to the operation. This operation is performed daily and also corresponds closely to the generic human-induced initiator "failure to properly conduct an operation performed on a daily basis," which also has a default probability of 0.001.
060-OpTiltDown01-HFI-NOD	<i>Operator Initiates Premature Tilt-Down during Transfer to Closure Area:</i> The WPTT is controlled remotely. If the operator sends a signal for the WPTT to tilt-down during canister lowering, the WPTT would impact the canister.	9	1.0	The operator can cause the WPTT to prematurely tilt down. The WPTT operator is not supposed to be operating or near the controls for the WPTT during CTM operations. The WPTT operator has no reason to be near the controllers, much less to begin tilt-down. Tilt-down only occurs during waste package loadout in the Waste Package Loadout Room, and the controller for the WPTT tilt-down is distinct from other WPTT controls. In order to accomplish this failure, several interlocks must also fail. These interlocks, including an interlock taking power away from the WPTT when the port gate is open and an interlock between the tilt-down mechanism and the docking station, have no bypass. To be conservative, unsafe actions that require an equipment failure to cause an initiating event have generally been assigned an HEP of 1.0.

Table E6.5-1. HFE Group #5 Descriptions and Preliminary Analysis (Continued)

HFE ID	HFE Brief Description	ESD	Preliminary Value	Justification
060-OpDSNFLoad-HFI-NOD	<i>Operator Misloads DSNF:</i> Due to potential criticality implications, no more than four DSNF canisters can be put together in a single WP or in a staging rack. The only way to get into this configuration is if the operator loads five or more DSNF canisters into a TAD canister WP or places them in a TAD canister staging rack.	N/A	1E-03	Due to potential criticality implications, no more than four DSNF canisters can be put together in a single WP or in a staging rack. The only way to get into this configuration is if the DSNF canisters are loaded into a TAD canister, loaded into a waste package, or placed in a TAD canister staging rack. Misloading a TAD requires the setup crew to prepare and stage the wrong waste package, the operating crew to fail to notice it is the wrong WP during their preoperational check, and the CTM operator to fail to notice it is the wrong waste package while loading the waste package. In addition to that set of failures, the CTM operator would also have to violate procedures and try to fit more than the standard four DSNF canisters in the waste package. For mistaging a DSNF canister in a TAD canister staging rack, the CTM operator must fail to pick the appropriate staging rack. The TAD canister and DSNF staging racks are sufficiently different in size and location that this failure would require significant inattention, particularly because the DSNF racks are expected to be used frequently, but the TAD canister staging racks have no expected use during normal operations. In addition to this failure, to cause a potential criticality problem, the CTM operator would have to repeat the same failure four times, each time putting the DSNF canister in the same TAD canister staging rack. This event was considered highly unlikely and given the default preliminary value of 0.001.

NOTE: AO = aging overpack; ASD = adjustable speed drive; CRCF = Canister Receipt and Closure Facility; CTM = canister transfer machine; CTT = cask transfer trolley; DPC = dual-purpose canister; DSNF = U.S. Department of Energy spent nuclear fuel; ESD = event sequence diagram; HFE = human failure event; HRA = human reliability analysis; ID = identification; NSDB = nuclear safety design basis; PSF = performance shaping factor; RC = railcar; SSC = structure, system, or component; ST = site transporter; TAD = transportation, aging, and disposal (canister); TC = transportation cask; TT = truck trailer; WP = waste package; WPTT = waste package transfer trolley.

Source: Original

E6.5.3 Detailed Analysis

After the preliminary screening analysis and initial quantification are completed, those HFES that appear in dominant cut sets for event sequences that do not comply with the 10 CFR 63.111 performance objectives are subjected to a detailed analysis. The overall framework for the HRA is based upon the process guidance provided in ATHEANA (Ref. E8.1.22). Consistent with that framework, the following four steps from the methodology described in Section E3.2 provide the structure for the detailed analysis portion of the HRA.

Step 5: Identify Potential Vulnerabilities

Prior to defining specific scenarios that can lead to the HFES of interest (Step 6), information is collected to define the context in which the failures are most likely to occur. In particular, analysts search for potential vulnerabilities in the operators' knowledge and information base for the initiating event or base case scenario(s) under study that might result in HFES or unsafe actions. This information collection step is discussed in Section E6.5.3.2.

Step 6: Search for HFE Scenarios (Scenarios of Concern)

An HFE scenario is a specific progression of actions with a specific context that leads to the failure of concern; each HFE is made up of one or more HFE scenarios. In this step, documented in Sections E6.5.3.3 and E6.5.3.4, the analyst identifies deviations from the base case scenario that are likely to result in risk-significant unsafe action(s). These unsafe actions make up an HFE scenario. In serious accidents, these HFE scenarios are usually combinations of various types of unexpected conditions.

Step 7: Quantify Probabilities of HFES

Detailed HRA quantification methods are selected as appropriate for the characteristics of each HFE and are applied as explained in Section E6.5.3.4. Four quantification methods are utilized in this quantification:

- CREAM (Ref. E8.1.18)
- HEART (Ref. E8.1.28)/NARA (Ref. E8.1.11)
- THERP (Ref. E8.1.26)
- ATHEANA expert judgment (Ref. E8.1.22).

There is no implication of preference in the order of listing these methods. They are jointly referred to as the "preferred methods" and are applied either individually or in combination as best suited for the unsafe action quantified. The ATHEANA (Ref. E8.1.22) expert judgment method (as opposed to the overall ATHEANA (Ref. E8.1.22) methodology that forms the framework and steps for the performance of this HRA) is used when the other methods are deemed to be inappropriate to the unsafe action, as is often the case for cognitive EOCs.

Appendix E.IV of this analysis explains why these specific methods were selected for quantification and gives some background on when a given method is applicable based on the focus and characteristic of the method.

All judgments used in the quantification effort are determined by the HRA team and are based on their own experience, augmented by facility-specific information and the experience of subject matter experts, as discussed in Section E4. If consensus can be reached by the HRA team on an HEP for an unsafe action, that value is used as the mean. If consensus cannot be reached, the highest opinion is used as the mean.

Step 8: Incorporate HFEs into the PCSA

After HFEs are identified, defined, and quantified, they must be incorporated into the PCSA. The summary table of HFEs by group that lists the final HEP by basic event name provides the link between the HRA and the rest of the PCSA. This table can be found in Section E6.5.4.

E6.5.3.1 HFEs Requiring Detailed Analysis

The detailed analysis methodology, Sections E3.2.5 through E3.2.9, states that HFEs of concern are identified for detailed quantification through the preliminary analysis (Section E3.2.4). An initial quantification of the CRCF PCSA model determined that there were five HFEs in this group whose preliminary values were too high to demonstrate compliance with the performance objectives stated in 10 CFR 63.111. These HFEs are presented in Table E6.5-2.

Table E6.5-2. Group #5 HFEs Requiring Detailed Analysis

HFE	Description	Preliminary Value
060-OpCTMdrop001-HFI-COD	Operator causes drop of object onto canister during CTM operations	2E-03
060-OpCTMdrop002-HFI-COD	Operator causes drop of canister during CTM operations (low-level drop).	2E-03
060-OpCTMImpact1-HFI-COD	Operator moves the CTM while canister or object is below or between levels	1E-03
060-OPCTMDirExp1-HFI-NOD	Operator Causes Direct Exposure during CTM Activities (Second Floor)	1E-04
060-OpStageRack1-HFI-NOD	Operator Causes Direct Exposure during Canister Staging	1E-03

NOTE: CTM = canister transfer machine; HEP = human error probability.

Source: Original

E6.5.3.2 Assessment of Potential Vulnerabilities (Step 5)

For those HFEs requiring detailed analysis, the first step in the ATHEANA approach to detailed quantification is to identify and characterize factors that could create potential vulnerabilities in the crew's ability to respond to the scenarios of interest and might result in HFEs or unsafe actions. In this sense, the "vulnerabilities" are the context and factors that influence human performance and constitute the characteristics, conditions, rules and tendencies that pertain to all the scenarios analyzed in detail.

These vulnerabilities are identified through activities including but not limited to the following:

1. The facility familiarization and information collection process discussed in Section E4.1, such as the review of design drawings and concept of operations documents
2. Discussions with subject matter experts from a wide range of areas, as described in Section E4.2
3. Insights gained during the performance of the other PCSA tasks (e.g., initiating event analysis, system analysis, and event sequence analysis).

The vulnerabilities discussed in this section pertain only to those aspects of the CTM operation that relate to potential human failure scenarios relevant to the three HFEs listed above. Other vulnerabilities exist that would be relevant to other potential HFEs that can occur during CTM operations, but these have no bearing on this analysis.

E6.5.3.2.1 Operating Team Characteristics

The operating team consists of the following personnel:

CTM operator—The CTM operator is located in the CRCF Control Room. The CTM operator receives standard training for crane operations and observes operations prior to being allowed to operate the CTM on a dry run. After training, the CTM operator is signed off to operate the CTM based on an evaluation of proficiency in a dry run. The CTM operator is observed on initial operations until signed off for solo operation. A single operator is assigned to the CTM operation.

Crew members (two)—Maintenance crew members are trained in tasks required for preparing the CTM for canister transfer, including affixing the appropriate grapple for the canister. Training consists of observation and “hands-on” instruction for the CTM preparation process. The CTM is prepared by a team of two workers.

Supervisor—The supervisor, or some other personnel with comparable training and certification, is in the CRCF control room watching CTM operations. This person is in charge of completing an end-of-operations checklist and independently verifying that the Canister Transfer Room is in a safe configuration after canister transfer activities have been completed.

E6.5.3.2.2 Operation and Design Characteristics

Control Panel—The panel consists of a joystick controller for two-dimensional movements of the bridge and trolley. Speed in both directions is fully variable within unit capabilities, based on the extent of joystick deflection. Buttons for the up–down movement of the hoist are spring returned and must be held in for hoist movement. The height of the hoist yoke is displayed digitally on the panel. There is a joystick for fine motion alignment of grapple (e.g., it can move the hoist within the bell). A flat screen display shows view from the camera mounted on the boom above the yoke. A control interface for the ASD is incorporated into the panel.

ASD—The ASD is equipped with a semi-automated system for lifts. The ASD has two normal modes and one maintenance (i.e., manual) mode. Normal modes have two settings: canister lift and lid lift. In the canister lift mode, the operator sets the mode and pushes/holds the lift button; the ASD lifts to the proper height and stops. The maintenance mode allows for full manual operation. The maintenance mode can be engaged only by entering a password.

Interlocks/Alarms—Only hardwired (non-PLC) interlocks are considered.

Hoist Operational Upper Limit—A light curtain located just above (~2 in.) the CTM slide gate. The interlock removes the power from the hoist lift circuit if nothing is sensed within the bell at this height (i.e., when the hoist cables, load cell, grapple, and any load have cleared this height). Indicators on the control panel (red/green lights) indicate whether the limit is cleared or blocked. The upper limit can be bypassed.

Grapple Engagement/Disengagement Interlock—The grapple interlock provides indication to the operator that the grapple is either fully engaged with the load or fully disengaged. Red and green lights indicate position. When both lights are on, this indicates that the grapple is between positions, and the interlock prevents hoist movement under this condition.

Grapple Interlock—The grapple interlock also prevents hoist movement if the secondary grapple is not properly attached to the primary grapple on the hoist. There is an interlock which prevents operation of the CTM canister grapple (primary grapple) if it is not properly attached to the hoist. .

Load Cell Overlimit—The load cell overlimit stops hoist movement when excessive force is applied to the hoist. This could shut down the hoist if the lid is pulled up against the bottom of the bell, but would not provide any protection against two-blocking because it is located below the lower block (i.e., between the block and the grapple).

Inadvertent Grapple Disengagement—The grapples are mechanically designed such that they cannot disengage while under a load; therefore, inadvertent grapple disengagement is precluded. However, to be conservative, this is modeled as an electric interlock.

Shield Skirt/Slide Gate Interlock—Prevents the shield skirt from lifting if the CTM slide gate is not closed. The failure mode of failing to reset the bypass for this interlock has not been modeled because there is no bypass for this interlock.

E6.4.3.2.3 Operational Conditions

There is no direct view of the CTM operation by any individual. Visual cues are hampered because all observations are made through cameras and observed on screens. The precise locations of the cameras have not been specified in the design, but the intent is to provide cameras that can view the grapple and canister (and move with the hoist) on the hoist trolley (that can see into the bell) and at other locations that can provide views of the outside of the bell and the Canister Transfer Room.

Control panel indications provide positive indication that the grapple has been deployed in the locked position (a red light) or the unlocked position (a green light), but the ability to provide a

direct (as opposed to indirect or inferred) confirmation of full engagement in the lift fixture is not proven.

The total operation of the CTM for a canister takes about two hours. The operator has a number of specific tasks to perform during that time, so the overall process can be considered reasonably active. However, the lifting task (relevant to drops) is one of the longest periods of inactivity for the operator (i.e., 10 minutes, of which only the last 30 seconds or so can be considered potentially active). The potential for the onset of boredom, complacency, or distraction is higher than normal during this task.

E6.5.3.2.4 Formal Rules and Procedures

Procedural Controls—Procedural controls ensure that the operators and maintenance personnel do not enter the Canister Transfer Room during CTM activities. Procedural controls also include a checklist that must be filled out at the end of transfer activities to ensure that all the port slide gates (including staging racks) are closed.

E6.5.3.2.5 Operator Tendencies and Informal Rules

Dependency on Hoist Interlocks and Alarms—The CTM operator should actively observe and confirm proper operation of the CTM and not depend on either alarms to be informed that limits are being reached or interlocks to stop or prevent improper motion. However, there can be a tendency for the operator to count on these devices to prevent human failure, in particular because the visual information received from the cameras is distorted.

Dependency on Grapple Engagement/Disengagement Indicator—In a similar fashion, the operator should confirm positive engagement of the grapple through the camera, but the lack of clarity expected in the camera view can create a tendency to depend solely on the indicator.

E6.5.3.2.6 Operator Expectations

Consequences of Failure—The CTM operations are performed remotely. No personnel are in the vicinity of the operation, and so the threat of physical injury is absent. Operators expect that failures are mitigated by design features without serious consequences, which promotes complacency in the operations.

Anticipatory Actions—The lifting process is simple, the goal is clear, and problems are not expected. There is a tendency for the CTM operator to focus on future tasks while the hoist is in motion rather than concentrate on the ongoing task. The operator expects that no one attempts to enter the Canister Transfer Room during CTM activities.

Expectation of Grappling Success—The grapple is a simple device. The operator can expect that once the grapple is actuated, it properly engages or disengages. The operator does not expect a failure or expect the engagement indicator to show a failure. The operator can also not expect that the grapple is not properly attached to the hoist (i.e., the operator can expect and trust that the crew members have properly prepared the CTM).

E6.5.3.3 HFE Scenarios and Expected Human Failures (Step 6)

Given that the vulnerabilities that provide the operational environment and features that could influence human performance have been specified, then the HFE scenarios within this environment are identified. An HFE scenario is a specific progression of actions during normal operations (with a specific context) leading to the failure of concern. Each HFE is made up of one or more HFE scenarios. In accordance with the methodology, each scenario integrates the unsafe actions with the relevant equipment failures to provide the complete context for understanding and quantification of the HFE.

The HAZOP is instrumental in initially scoping out the HFE scenarios, but they are then refined through discussions with subject matter experts from a wide range of areas, as described in Section E4.2.

Table E6.5-3 summarizes all of the HFE scenarios developed for the HFEs in HFE Group #5.

Table E6.5-3. HFE Scenarios and Expected Human Failures for HFE Group #5

HFE	HFE Scenarios
<p>060-OpCTMdrop001-HFI-COD <i>Operator causes drop of object onto canister during CTM operations</i></p>	<p>HFE Scenario 1(a): (1) A crew member improperly installs the grapple, (2) the preoperational check fails to note the improper installation, (3) the primary grapple interlock gives a false positive signal, (4) the operator fails to notice the bad connection between the hoist and the grapple through the camera, and (5) the grapple/lid drops from the hoist and strikes the canister.</p> <p>HFE Scenario 1(b): (1) The operator fails to fully engage the grapple, (2) the grapple engagement interlock gives a false positive signal, (3) the operator fails to notice that the grapple is not fully engaged through camera, and (4) the lid drops from the grapple and strikes the canister.</p> <p>HFE Scenario 1(c)^{a, b}: (1) The operator leaves the ASD in maintenance mode OR the operator places the ASD in canister mode OR the ASD height control fails, (2) the operator fails to notice that the lift is taking too long OR the operator “locks” the lift button into position, (3) the load cell overload interlock fails, and (4) mechanical failure of the hoist under overload causes the lid to drop.</p> <p>HFE Scenario 1(d)^{a, c}: (1) The CTT is not sufficiently centered under the port, (2) the operator fails to notice that the CTT is not sufficiently centered, (3) the operator fails to notice the lid tilt and continues the lift OR the operator “locks” the lift button into position, (4) the lid catches and jams in port, (5) the load cell overload interlock fails, and (6) mechanical failure of the hoist under overload causes the lid to drop.</p> <p>HFE Scenario 1(e): (1) The operator activates the grapple disengagement switch prematurely, (2) the load cell disengagement interlock fails, and (3) the lid drops from the grapple and strikes the canister.</p>
<p>060-OpCTMdrop002-HFI-COD <i>Operator causes drop of canister during CTM operations (low-level drop)</i></p>	<p>HFE Scenario 2(a): (1) A crew member improperly installs the grapple, (2) a primary grapple interlock gives a false positive signal, (3) the operator fails to notice the bad connection between the hoist and the grapple through the camera, and (4) the grapple/canister drops from the hoist.</p> <p>HFE Scenario 2(b): (1) The operator fails to fully engage the grapple, (2) the grapple engagement interlock gives a false positive signal, (3) the operator fails to notice that the grapple is not fully engaged through camera, and (4) the canister drops from the grapple.</p> <p>HFE Scenario 2(c)^d: (1) The CTT is not sufficiently centered under the port, (2) the operator fails to notice that the CTT is not sufficiently centered, (3) the operator fails to notice that the DPC contacting the ceiling and continues the lift OR the operator “locks” the lift button into position, (4) the load cell overload interlock fails, and (5) mechanical failure of the hoist under overload causes the DPC to drop.</p>

Table E6.5-3. HFE Scenarios and Expected Human Failures for HFE Group #5 (Continued)

HFE	HFE Scenarios
<p>060-OpCTMImpact1-HFI-COD <i>Operator moves the CTM while canister or object is below or between levels</i></p>	<p>HFE Scenario 3(a): (1) The operator leaves the CTM in the lid lift mode (for non-DPCs), (2) the operator fails to notice that the lift stops too soon, (3) the operator fails to close the port slide gate OR fails to notice that it does not fully close, (4) the operator fails to close the CTM slide gate OR fails to notice that it does not fully close, and (5) the CTM slide gate interlock fails.</p> <p>HFE Scenario 3(b): (1) The operator puts the CTM in the lid lift mode (for DPCs), (2) the operator fails to notice that the lift stops too soon, (3) the operator fails to close the port slide gate OR fails to notice that it does not fully close, (4) the operator fails to close the CTM slide gate OR fails to notice that it does not fully close, and (5) the CTM slide gate interlock fails.</p> <p>HFE Scenario 3(c): (1) The operator puts the CTM in the maintenance mode (for non-DPCs), (2) the operator terminates the lift prior to the automatic stop, (3) the operator fails to close the port slide gate OR fails to notice that it does not fully close, and (4) the operator fails to close the CTM slide gate OR fails to notice that it does not fully close, (5) the CTM slide gate interlock fails.</p> <p>HFE Scenario 3(d)^e: (1) The operator leaves the CTM in the maintenance mode (for DPCs), (2) the operator terminates the lift prior to the automatic stop, (3) the operator fails to close the port slide gate OR fails to notice that it does not fully close, and (4) the operator fails to close the CTM slide gate OR fails to notice that it does not fully close, (5) the CTM slide gate interlock fails.</p>
<p>060-OPCTMDirExp1-HFI-NOD <i>Operator Causes Direct Exposure during CTM Activities (Second Floor)</i></p>	<p>HFE Scenario 4(a): (1) A worker violates administrative control by entering the Canister Transfer Room during canister transfer, and (2) the operator fails to close port gate before raising the shield skirt.</p>
<p>060-OpStageRack1-HFI-NOD <i>Operator Causes Direct Exposure during Canister Staging</i></p>	<p>HFE Scenario 5(a): (1) The operator fails to close staging rack port gate, and (2) the supervisor fails to verify that the staging rack port gate is closed as part of end-of-operations check.</p>

NOTE: ^a Scenarios (1c) and (1d) in this event do not apply to DPCs since DPC lids are not removed in the CTM.
^b This scenario does not apply to placing the waste package inner lid since it can only occur over the canister when lifting a transportation cask/aging overpack lid.
^c This scenario does not apply to placing the waste package inner lid or the aging overpack lid since it can only occur over the canister when lifting a transportation cask/aging overpack lid.
^d This scenario only applies to DPCs because the transportation cask lid was removed in the preparation area.
^e Only scenario 3(d) is applicable for lids.
ASD = adjustable speed drive; CTM = canister transfer machine; CTT = cask transfer trolley; DPC = dual-purpose canister; HFE = human failure events.

Source: Original

Since there are five HFEs identified for detailed analysis in this group, the scenarios are organized under these three HFE categories, with the scenarios under the first HFE category numbered as 1(a), 1(b), etc.; those under the second category numbered 2(a), etc.; and similarly those under the third category numbered 3(a), 3(b), etc.

Each HFE scenario is in turn characterized by several unsafe actions, numbered sequentially as (1), (2), (3), etc. The Boolean logic of the HFE scenarios is expressed with an implicit AND connecting the subsequent unsafe actions and OR notation wherever two unsafe action paths are possible, as shown in Table E6.5-3.

The HFE scenarios summarized in Table E6.5-3 are discussed and quantified in detail in the following sections.

E6.5.3.4 Quantitative Analysis (Step 7)

Once the HFE scenarios and the unsafe actions within them are scoped out, it is then possible to review them in detail and apply the appropriate quantification methodology in each case that permits an HEP to be calculated for each HFE. Stated another way, each HFE is quantified through the quantification and combination of the contributing HFE scenarios. Dependencies between the unsafe actions and equipment responses within each scenario and across the scenarios are carefully considered in the quantification process.

This section provides a description of the quantitative analysis performed, structured hierarchically by each HFE category (identified by a basic event name), the HFE scenario, and the unsafe actions under each scenario, as previously documented in Table E6.5-3.

Prior to the scenario-specific quantification descriptions, a listing is provided of the values used in the quantification that are common across many of the HFE scenarios.

In generating the final HEP values, the use of more than a single significant figure is not justified given the extensive use of judgment required for the quantification of the individual unsafe actions within a given HFE. For this reason, all calculated final HEP values are reduced to one significant figure. When doing this, the value is always rounded upwards to the next highest single significant figure.

E6.5.3.4.1 Common Values Used in the HFE Detailed Quantification

There are some mechanical failures that combine with unsafe actions to form HFEs. In general, these mechanical failures are independent of the specific HFE scenario, and so they can be quantified independently. These values are presented in this section.

Interlock Failures—There are a number of interlock failures in the HFE scenarios. While the status of these events can affect subsequent events in the scenarios in different ways, the likelihood of this event occurring is independent of the scenario. This event is an equipment failure and does not have a human component to its failure rate. The demand failure rate for an interlock, from Attachment C, Table C4-1, is approximately $2.7E-05$ per demand.

$$\text{Interlock fails to perform function} = 2.7E-05$$

ASD Height Control Fails—This event is an equipment failure and does not have a human component to its failure rate. The demand failure rate for the ASD, from the Attachment C, Table C4-1, is approximately $3.4E-05$ per demand.

$$\text{ASD height control fails} = 3.4E-5$$

Load Drops from Hoist—This is the last event in a drop scenario. This event accounts for the safety margins built into the hoist system to accept overload without failure resulting in severed cables, failed clutches, and partially engaged grapples. The various events need to be quantified

in relation to each other, using engineering judgment to account for the load being applied to the system versus its capacity to bear the load.

The first drop considered is where a canister (DPC) is being lifted and it catches the ceiling of the Cask Unloading Room. In this case, an overload of the system is created by adding the additional force of the hoist motor straining to lift the unmoving canister (over and above the force created by the canister) to the system. The extent to which this exceeds the ultimate load-bearing capacity of the system is a function of the total force that can be generated by the motor and the amount of time that the motor can exert this force while not turning before the motor overheats. Typical design requirements for NOG-1 cranes (Ref. E8.1.2) provide a significant safety margin against overload failures. The probability of this event is based on analyst judgment in accordance with the PCSA approach to the use analyst judgment for probability estimation. There is limited analysis of this condition. Lacking or inconclusive analysis would argue for assignment of even odds (0.5) for this event. The weight of evidence for the inherent margin in a single failure-proof design could form an argument that the failure is unlikely (0.1). The HRA team is convinced that the best estimate from the available information (given the current state of knowledge) is somewhere in between. The HRA team assigns 0.5 as the 95% confidence level and 0.1 as the 5% confidence level. Using a lognormal distribution, the mean associated with these confidence limits follows:

Mechanical failure of hoist under overload causes DPC drop = 0.25

The other drops are evaluated relative to this. First considered is the similar case where the lid is jammed in the port and the hoist is straining to lift the jammed lid. In this case, the force generated by the hoist is the same, but the weight of the lid is less. The HRA team judges that it is reasonable to reduce the failure probability by a factor of two to account for this difference:

Mechanical failure of hoist under overload causes lid drop = 0.1

Considered next is the condition where the grapple is either not properly connected to the hoist or the grapple itself is only partially engaged with the canister or lid. This failure (i.e., drop of canister or lid from an improperly engaged grapple) is judged to be comparable to mechanical failure of the hoist under overload because in both cases the load-bearing capacity of the system is reduced. Therefore the resulting probability is as follows:

Grapple/canister drops from hoist = 0.25

Canister drops from grapple = 0.25

Regarding the case of a lid, again the force is lower than the canister case and also lower than the jammed lid case, with a similar situation in that the load-bearing capacity of the system is reduced. Using the logic above, this would argue for using the 0.1 value. However, in the case of the lid, there is always the possibility that the drop would occur when the lid was not over the canister, or it would occur in a manner that the lid would not impact the canister (i.e., it would only strike the structure of the transportation cask, aging overpack, or waste package). In the absence of analysis, the HRA team has applied a 50-50 chance of this occurring, which reduces the probability by a factor of two. Therefore:

Grapple/lid drops from hoist and strikes canister = 0.05

Lid drops from grapple and strikes canister = 0.05

Given the information available about the design, the analyses in existence, and the knowledge of the requirements of NOG-1 (Ref. E8.1.2) and other applicable standards to be applied to the CTM, the HRA team believes this to be both a reasonable assessment and at as fine a level of detail and differentiation as can be justified.

E6.5.3.4.2 Quantification of HFE Scenarios for 060-OpCTMdrop001-HFI-COD: Operator Causes Drop of Object onto Canister during CTM Operations

E6.5.3.4.2.1 HFE Group #5 Scenario 1(a) for 060-OpCTMdrop001-HFI-COD

1. Maintenance crew member improperly installs grapple.
2. Preoperational check fails to note improper installation.
3. Primary interlock gives false positive signal.
4. Operator fails to notice bad connection between hoist and grapple through camera.
5. Grapple/lid drops from hoist and strikes canister.

Crew Member Improperly Installs Grapple—Prior to a lift operation, a crew member prepares the CTM for the operation by installing the appropriate grapple for the type of cask lid to be processed. While it is possible that this operation need not be performed (it may be the cask lid grapple is the same grapple used for previous waste package and no other work on or with the CTM may have been performed), it is uncertain how often this can occur, so this analysis considers that this action needs to be performed each time. To install the grapple, the primary CTM grapple lowers and engages the secondary grapple. If the primary grapple is only partially engaged, the secondary grapple appears to be secured in place, but it is not.

The operator aligns the grapple visually using the camera view and then engages the grapple. If it is not aligned properly, the grapple does not fully engage. The crew members locally verify engagement and connect the appropriate wire connections from the secondary grapple to the primary grapple. This is a straightforward matter of task execution. The task is simple and routine and can be represented by NARA GTT A5, adjusted by the following EPCs:

- GTT A5: Completely familiar, well designed, highly practiced routine task performed to the highest possible standards by highly motivated, highly trained, and experienced person, totally aware of implications of failure, with time to correct potential errors. The baseline HEP is 0.0001.

- EPC 3: Time pressure. The full affect EPC would be $\times 11$, but this applies only in cases where there is barely enough time to complete a task, and rapid work is necessary. In this case, the time pressure is more abstract, in that there is a desire to keep the process moving for production reasons, but not a compelling one. The APOA anchor for 0.1 is that the operator feels some time pressure, but there is sufficient time to carry out the task properly with checking. The crew member probably feels a little more time pressure than that, so the APOA is set at 0.2.
- EPC 8: Poor environment. This EPC is applied not so much because the environment is poor, but rather that it is simply not optimal. The full affect EPC would be $\times 8$, but this applies when working in the plant with suit and breathing apparatus, possible access problems, and for more than 45 minutes so that fatigue sets in. The APOA anchor for 0.1 is for work in the plant with suit and breathing apparatus but none of the other environmental stressors. In this task no breathing apparatus is required, but the task is somewhat physically demanding. Given the tradeoffs, the APOA is set at 0.1.
- EPC 13: Operator under load/boredom. The full affect EPC would be $\times 3$, which applies to a routine task of low importance carried out by a single individual for several hours. The APOA anchor for 0.1 is for low difficulty, low importance, single individual, for less than one hour. This appears reasonable for this task, so the APOA is set at 0.1.

Using the NARA HEP equation yields the following:

$$\text{Crew member improperly installs grapple} = 0.0001 \times [(11-1) \times 0.2 + 1] \times [(8-1) \times 0.1 + 1] \times [(3-1) \times 0.1 + 1] = 0.0006 \quad (\text{Eq. E-7})$$

Preoperational Check Fails to Notice Improper Installation—There are two crew members responsible for preparing the CTM for each operation. Each crew member has a distinct set of assignments, although they collaborate when needed and are expected to check each other’s work. The second crew member checks the first crew member’s installation of the grapple, which provides an opportunity for the error to be detected. The second crew member also has a set of activities to perform, and so checking the first crew member is a secondary function. In addition, the existence of the grapple/hoist interlock provides an expectation that any error can be detected.

The second crew member would have helped initially with the connection of the grapple to line it up but would then move on to other things. At best, the second crew member performs a cursory check at the end of the job. Since the crew member was involved in the early stages, there is a bias that the job was done correctly. It is concluded that the level of dependence is high. The baseline HEP for the checking, for checking routine tasks without a checklist, is best determined from THERP (Ref. E8.1.26), Table 20-22, item (2), which is 0.2. The HEP for high dependence is from THERP (Ref. E8.1.26), Table 20-21, item (4)(e), which is 0.6.

$$\text{Preoperational check fails to note improper installation} = 0.6$$

Primary Interlock Gives False Positive Signal—Before beginning the lifting process, the operator should confirm engagement by checking the primary grapple engagement interlock.

The indicator could give a false positive signal. This could result from a failure in the indicator itself or as the result of a partial engagement that generates a positive signal by triggering the sensor even though only partial engagement has occurred. Since the indicator system has not yet been designed and the specific detection approach has not been defined, this cannot be ruled out.

This is a mechanical failure of the interlock. This event is quantified in Section E6.5.3.4.1.

Primary grapple interlock gives false positive signal = $2.7E-5$

Operator Fails to Notice Improper Connection between Hoist and Grapple through Camera—When the CTM operator is in the process of lifting the canister, the camera shows the operator the secondary grapple and its connection to the primary grapple. The operator is not focused on that connection but is focused on lining up the secondary grapple with the lifting device. However, as the lift begins, the operator is supposed to watch through the cameras. This gives the operator the opportunity to note that the grapple is not properly connected (e.g., unexpected lid movement to one side or tilting of the grapple). This also gives the operator the opportunity to question the stability of the connection and to lower the lid back down to recheck the connection. However, the operator is not expecting any problems in this simple operation, and the operator tends to believe that any perceived problems are illusions caused by the distortions of viewing through a camera.

This action is best represented by the CREAM CFF O3, adjusted by the following CPCs with values not equal to 1.0:

- CFF O3: Observation not made. The baseline HEP is 0.003.
- CPC “Adequacy of Man–Machine Interface”: For this particular observation, the use of a camera view (while the only practical means) is somewhere between tolerable and inappropriate. The CPC for an observation task with tolerable man–machine interface is 1.0, and for inappropriate is 5.0. With regard to being able to actually observe the condition of the grapple lock pin, the CPC is set as 4.0.
- CPC “Number of Simultaneous Goals”: The operator is primarily focusing on properly aligning the bell and hoist, opening the ports, and grappling the lid. While it could be argued that this is not “more than capacity,” it certainly relegates looking at the grapple/hoist connection to a secondary action. It is therefore deemed appropriate to apply the more than capacity CPC, which is 2.0.
- CPC “Adequacy of Training/Preparation”: Training is adequate with high experience. The CPC for an observation task with adequate training and high experience is 0.8.

The resulting value follows:

Operator fails to notice bad connection between hoist and grapple through camera
 $= 0.003 \times 4 \times 2 \times 0.8 = 0.02$

Grapple/Lid Drops from Hoist and Strikes Canister—Just because the lift is occurring with an improper grapple installation does not mean that the lid and grapple fall. The safety margins

build into these systems mean that it is possible that the lift and place can be completed successfully even with improper installation, especially given that it is sized for a canister, and the lid is much lighter. Additionally, even if the lid and grapple do fall, they could fall early (a weak connection) or later (sufficient connection that they need time and motion to cause them to break loose). These two cases can result in the lid and grapple breaking loose when they are not above the canister. In addition, it is not a certainty that the lid and grapple, once dropped, would fall in an orientation that would impact the canister in the transportation cask, aging overpack, or waste package, even if they are above the canister at the time of the drop (the orientation of the falling lid and grapple may cause them to only impact the transportation cask, aging overpack, or waste package structure).

This event is quantified in Section E6.5.3.4.1.

$$\text{Grapple/lid drops from hoist} = 0.05$$

HEP Calculation for Scenario 1(a)—The events in the HEP model for Scenario 1(a) are presented in Table E6.5-4.

Table E6.5-4. HEP Model for HFE Group #5 Scenario 1(a) for 060-OpCTMdrop001-HFI-COD

Designator	Description	Probability
A	Crew member improperly installs grapple	0.0006
B	Preoperational check fails to note improper installation	0.6
C	Primary grapple interlock gives false positive signal	2.7E-5
D	Operator fails to notice bad connection between hoist and grapple through camera	0.02
E	Grapple/lid drops from hoist and strikes canister	0.05

NOTE: HEP = human error probability.

Source: Original

The Boolean expression for this scenario follows:

$$A \times B \times C \times D \times E = 0.0006 \times 0.6 \times 2.7E-5 \times 0.02 \times 0.05 = 1E-11 \quad (\text{Eq. E-8})$$

According to NARA, the lower limit of credibility for an HFE accomplished by a single operator or team is 1E-5 per demand. Using this truncated value for the set of unsafe actions, the probability of this scenario is:

$$1E-5 \times 2.7E-5 < 1E-8 \quad (\text{Eq. E-9})$$

E6.5.3.4.2.2 HFE Group #5 Scenario 1(b) for 060-OpCTMdrop001-HFI-COD

1. Operator fails to fully engage grapple.
2. Grapple engagement interlock gives false positive signal.
3. Operator fails to notice grapple not fully engaged through camera.
4. Lid drops from grapple and strikes canister.

Operator Fails to Fully Engage Grapple—The operator engages the grapple from the control panel. The grapple can be roughly positioned using the alignment guides for the CTM and the hoist height indicator on the control panel, but final alignment must be done visually using the view from the cameras provided on the grapple. Once the operator believes the grapple is aligned, the operator engages the grapple with the lift fixture and confirms through the camera that the grapple has engaged. If the operator sees that the grapple has not properly engaged (generally by checking the interlock condition if it looks engaged visually), then the operator disengages it, repositions the grapple, and tries again to engage.

The operator aligns the grapple visually using the view from the camera and engages the grapple. If it is not aligned properly, it does not fully engage. This unsafe action can be best represented by the task execution error NARA GTT A1, adjusted by the following CPCs:

- NARA GTT A1: Carry out a simple manual task with feedback. Skill-based and therefore not necessarily with procedures. The baseline HEP is 0.005
- EPC 3: Time pressure. The full affect EPC would be $\times 11$, but this applies only in cases where there is barely enough time to complete a task and rapid work is necessary. In this case, the time pressure is more abstract, in that there is a desire to keep the process moving for production reasons, but not a compelling one. The APOA anchor for 0.1 is that the operator feels some time pressure, but there is sufficient time to carry out the task properly with checking. The crew member probably feels a little more time pressure than that, so the APOA is set at 0.2.
- EPC 11: Poor, ambiguous, or ill-matched system feedback. This EPC is applied to account for the need to observe the operation through cameras. The full affect EPC would be $\times 4$. The full effect is applicable when legibility is poor or label is obscured or where the layout of controls makes visual access and physical access difficult. The use of the camera view is deemed to represent full effect. The APOA is set at 1.0.
- EPC 13: Operator underload/boredom. The full affect EPC would be $\times 3$, which applies to a routine task of low importance, carried out by a single individual for several hours. The APOA anchor for 0.1 is for low difficulty, low importance, single individual, for less than one hour. This appears reasonable for this task, so the APOA is set at 0.1.

Using the NARA HEP equation yields the following:

$$\begin{aligned} &\text{Operator fails to fully engage grapple} = \\ &0.005 \times [(11-1) \times 0.2 + 1] \times [(4-1) \times 1.0 + 1] \times [(3-1) \times 0.1 + 1] = 0.07 \quad (\text{Eq. E-10}) \end{aligned}$$

Grapple Engagement Interlock Gives False Positive Signal—Before beginning the lifting process, the operator should confirm engagement by checking the grapple engagement interlock. The indicator could give a false positive signal. This could result from a failure in the indicator itself or as the result of a partial engagement that generates a positive signal by triggering the sensor even though only partial engagement has occurred. Since the indicator system has not yet been designed and the specific detection approach has not been defined, this cannot be ruled out.

This is a mechanical failure of the interlock. This event is quantified in Section E6.5.3.4.1.

Grapple engagement interlock gives false positive signal = $2.7E-5$

Operator Fails to Notice Grapple Not Fully Engaged through Camera—As the lift begins, the operator is supposed to watch through the cameras. This allows the opportunity to note that the grapple is not properly engaged (e.g., unexpected lid movement to one side or tilting of the grapple). This also gives the operator the opportunity to question the stability of the connection and to lower the lid back down to recheck the connection. However, the operator is not expecting any problems in this simple operation, and the tendency is to believe that any perceived problems are illusions caused by the distortions of viewing through a camera.

In this task, the operator is checking the actions taken through the camera. The operator believe that the action was initially performed correctly (because the action was performed by the operator), and this belief is confirmed by the false positive from the interlock, this last observation is deemed completely dependent on the prior actions. Using THERP (Ref. E8.1.26) Table 20-21 to assess dependency, item (5) for complete dependency:

Operator fails to notice grapple not fully engaged through camera = 1.0

Lid Drops from Grapple and Strikes Canister—Just because the lift is occurring with an incomplete engagement of the grapple does not mean that the grapple would fall. The safety margins build into these systems mean that it is possible that the lift and place can be completed successfully even with improper installation, especially given that it is sized for a canister, and the lid is much lighter. Additionally, even if the lid does fall, it could fall early (a weak connection) or later (sufficient connection that they need time and motion to cause them to break loose). These two cases can result in the lid breaking loose when it is not above the canister. In addition, it is not a certainty that the lid, once dropped, would fall in an orientation that would impact the canister in the transportation cask, aging overpack, or waste package even if it is above the canister at the time of the drop (the orientation of the falling lid may cause it to only impact the transportation cask, aging overpack, or waste package structure).

This event is quantified in Section E6.5.3.4.1.

Lid drops from grapple = 0.05

HEP Calculation for Scenario 1(b)—The events in the HEP model for Scenario 1(b) are presented in Table E6.5-5.

Table E6.5-5. HEP Model for HFE Group #5 Scenario 1(b) for 060-OpCTMdrop001-HFI-COD

Designator	Description	Probability
A	Operator fails to fully engage grapple	0.07
B	Grapple engagement interlock gives false positive signal	2.7E-5
C	Operator fails to notice grapple not fully engaged through camera	1.0
D	Lid drops from grapple and strikes canister	0.05

NOTE: HEP = human error probability.

Source: Original

The Boolean expression for this scenario follows:

$$A \times B \times C \times D = 0.07 \times 2.7E-5 \times 1.0 \times 0.05 = 1E-7 \quad (\text{Eq. E-11})$$

E6.5.3.4.2.3 HFE Group #5 Scenario 1(c) for 060-OpCTMdrop001-HFI-COD

1. Operator leaves ASD in maintenance mode OR operator places ASD in canister mode OR ASD height control fails.
2. Operator fails to notice lift is taking too long OR operator “locks” lift button into position.
3. Load cell overload interlock fails.
4. Mechanical failure of hoist under overload causes lid drop.

Operator Leaves ASD in Maintenance Mode—The ASD controls the height of the lift. Before beginning the lifting process, the operator should ensure that the ASD is in the lid lift mode. It could be in maintenance mode because of activities performed in the days between canister transfers. It is not clear how often this would occur, so for the purpose of this analysis, the bounding case is that the ASD is always in maintenance mode between canister transfers. Therefore, the operator must change the mode prior to the lid lift. In doing this, the operator could either fail to change the mode (miss this step in the process) or erroneously place it in the canister lift mode, either of which results in the ASD trying to lift the lid too high and impacting the bottom of the bell. The third way this could occur is simply a mechanical failure of the height control set point of the ASD.

The CTM operator is supposed to set the CTM system to the appropriate lift mode prior to performing a lift. This is fundamental to the operation, not simply a step in a procedure that can be missed. The initial action to set the mode is quite simple, so the only realistic way that the operator can leave the ASD in maintenance mode is to completely fail to take any actions to set the CTM system for a lift. This failure can be represented by NARA GTT B3, and adjusted by the following EPCs:

- GTT B3: Set system status as part of routine operations using strict administratively controlled procedures. The baseline HEP is 0.0007.

This operation is performed under optimal conditions. It is early in the operation, and the operator is active, so it is too early in the task for boredom to set in. The baseline HEP is used without adjustment.

Operator leaves ASD in maintenance mode = 0.0007

Operator Places ASD in Canister Lift Mode—Given that a CTM operator has correctly decided to set the CTM system status prior to operations, the appropriate operating mode also needs to be selected. There are only two modes to choose from: lid lift and canister lift. The ASD control is a screen where the operator can scroll between the choices to pick the appropriate lift mode. The act of selecting the wrong mode from these two can be best represented by task execution error NARA GTT A1, and adjusted by the following EPCs:

- NARA GTT A1: Carry out a simple single manual action with feedback. Skill-based and therefore not necessarily with procedures. The baseline HEP is 0.005.
- This operation is performed under optimal conditions. It is early in the operation, and the operator is active, so it is too early in the task for boredom to set in. The ASD control system requests confirmation from the operator (e.g., “You have selected canister lift. Confirm Y/N”). The baseline HEP is used without adjustment.

Operator places ASD in canister lift mode = 0.005

ASD Height Control Fails—This is a mechanical failure of the ASD controller. This event is quantified in Section E6.5.3.4.1.

ASD height control fails = $3.4E-5$

Operator Fails to Notice Lift is Taking Too Long—Lifting the lid takes on the order of a few minutes, whereas lifting the canister takes on the order of ten minutes. Because the operator holds the lift button or the lift stops, there is an opportunity to notice that the hoist has not stopped when expected and to release the button and stop the hoist, either before the lid contacts the interior of the bell or before it begins to overload the system. Realistically, the operator would have on the order of 30 seconds between when it should stop and when it would be too late. The hoist position indicator and camera view are in front of the operator on the control panel.

The operator is supposed to hold the lift button until the lift automatically stops. This operation has been performed many times in the past by the operator, and the operator has an instinctive feel for how long the lift takes. If an operator feels it is taking too long, the operator need only look at the camera and the indicators on the control panel for verification. Failing to recognize this situation can be represented by CREAM CFF I3, adjusted by the following CPCs with values not equal to 1.0:

- CFF I3: Delayed interpretation (not made in time). The baseline HEP is 0.01.

- CPC “Working Conditions”: The operator has optimal working conditions in the CRCF Control Room. The CPC for an interpretation task with advantageous working conditions is 0.8.

Applying these factors yields the following:

$$\text{Operator fails to notice lift is taking too long} = 0.01 \times 0.8 = 0.008$$

Operator “Locks” Lift Button into Position—Another way that the lift would go too long is if the operator were to use some inventive means to “lock” the button in place. The CTM lifts are a tedious task and require holding the button in place for long periods of time. There is no locking feature associated with the ASD that would keep the button in place; however, it is not inconceivable that, after many lifts have been done without an ASD failure, an operator would develop a creative technique to accomplish this. Since the operator develops trust in the ASD and the other system interlocks, the operator would not believe that the deviation is unsafe, and it would free up time to prepare for subsequent steps or to perform other duties.

The operator is supposed to hold the lift button until the lift automatically stops. However, it is always possible to rig something up that would hold the button in place, relieving the operator of the “inconvenience” of holding it. The HRA team believes that the preferred methods do not provide baseline HEPs for such unsafe actions. Therefore, the ATHEANA expert judgment approach is used. In considering the judgment, HEART and NARA do provide some insight into the existence of EPCs that can affect this unsafe action, such as the following:

- A mismatch between an operator’s model of the world and that imagined by a designer—The designer considers the “push-and-hold” as a safety feature that keeps the operator’s attention on the operation. The operator considers it as an unnecessary inconvenience in what should be an automated function.
- A mismatch between real and perceived risk—Locking the button removes a layer of safety provided by the operator monitoring operations, but the operator perceives the reliability of the limits and interlocks as such that there is no additional risk involved (HEART EPC 12).
- Little or no independent checking or testing of output—A single operator is operating the CTM from a remote location. No one is looking over the operator’s shoulder (HEART EPC 17).
- An incentive to use other, more dangerous procedures—Holding the button means that the operator’s ability to accomplish other work is limited. The operator can be more efficient (e.g., planning for future activities, completing paperwork) by trusting the control system to complete the task (HEART EPC 21, NARA EPC 15).
- Operator under load, boredom—Holding a button when one fully expects that the system automatically controls the operation is not very challenging (NARA EPC 13).

- Little or no intrinsic meaning in a task—The operator really has to wonder why the system wasn't designed to simply perform the operation on its own. The operator could come to consider the "push-and-hold" feature as a poorly thought out design flaw (HEART EPC 28).

Taking this as a whole, the HRA team judges that the operator locks the button in place about 10% of the time (which can be interpreted as some operators doing it quite frequently and other operators less or not at all, depending on their compunction to do so). However, this action is not unrelated to prior failures in this scenario. An operator who fails to set the CTM system status (leaves the ASD in maintenance mode) has already demonstrated a predilection towards rushing and perhaps a bias towards short-cuts for the particular lift. Therefore, the HRA team judges that the success or failure of this task is related to the way in which the ASD failure occurs. It is judged that if the failure occurs as a result of leaving the ASD in maintenance mode, the HEP for locking the button in place is twice the baseline (0.2). If it occurs for either of the other two reasons, the HEP is one-half the baseline (0.05).

Operator "locks" lift button into place (ASD left in maintenance) = 0.2

Operator "locks" lift button into place (ASD placed in canister mode or fails mechanically) = 0.05

Load Cell Overload Interlock Fails—The load cell has an interlock that shuts off the hoist if it senses that the load exceeds the approved load for the hoist. The hoist straining to lift the lid in contact with the bell (which would put the full load of the bell on the hoist) would be one such condition. Since this would shut the hoist down prior to exceeding the ultimate capacity of the system, it would have to fail in order to cause a drop.

This is a mechanical failure of the interlock. This event is quantified in Section E6.5.3.4.1.

Load cell interlock fails = $2.7E-5$

Mechanical Failure of Hoist under Overload Causes Lid Drop—There are three potential failure modes that could cause the lid to detach from the hoist. The cable could fail, the grapple could break free from the lower block, or the lifting fixture could break free from the grapple or lid. However, just because the hoist keeps pulling does not mean that the lid falls (the hoist motor could overload and fail before the lid becomes detached from the hoist) or that the lid, once dropped, falls in an orientation that would impact the canister in the transportation cask or aging overpack (the orientation of the falling lid may cause it to only impact the transportation cask or aging overpack structure).

This event is quantified in Section E6.5.3.4.1.

Mechanical failure of hoist under overload causes lid drop = 0.1

HEP Calculation for Scenario 1(c)—The events in the HEP model for Scenario 1(c) are presented in Table E6.5-6.

Table E6.5-6. HEP Model for HFE Group #5 Scenario 1(c) for 060-OpCTMdrop001-HFI-COD

Designator	Description	Probability
A	Operator leaves ASD in maintenance mode	0.0007
B	Operator places ASD in canister mode	0.005
C	ASD height control fails	3.4E-5
D	Operator fails to notice lift is taking too long	0.008
E1	Operator “locks” lift button into position (ASD left in maintenance)	0.2
E2	Operator “locks” lift button into position (ASD placed in canister mode or fails mechanically)	0.05
F	Load cell overload interlock fails	2.7E-5
G	Mechanical failure of hoist under overload causes lid drop	0.1

NOTE: ASD = allowable stress design; HEP = human error probability.

Source: Original

The Boolean expression for this scenario follows:

$$\{A \times (D + E1) + [(B + C) \times (D + E2)]\} \times F \times G = \{0.0007 \times (0.008 + 0.2) + [(0.005 + 3.4E-5) \times (0.008 + 0.05)]\} \times 2.7E-5 \times 0.1 < 1E-8 \quad (\text{Eq. E-12})$$

E6.5.3.4.2.4 HFE Group #5 Scenario 1(d) for 060-OpCTMdrop001-HFI-COD

1. CTT is not sufficiently centered under port.
2. Operator fails to notice CTT not sufficiently centered.
3. Operator fails to notice lid tilt and continues lift OR operator “locks” lift button into position.
4. Lid catches and jams in port.
5. Load cell overload interlock fails.
6. Mechanical failure of hoist under overload causes lid drop.

CTT Is Not Sufficiently Centered Under Port—This unsafe action actually occurs prior to this operation, during movement of the CTT (or site transporter) into the Cask Unloading Room. The CTT (or site transporter) operator brings the unit into the Cask Unloading Room and centers it directly under the cask port by aligning it against end stops that properly locate it and by using markings on the floor. If the cask is not properly centered, it is possible that the lid could strike the ceiling around the cask port rather than rising smoothly through the cask port. The cask would have to be off-center by more than a foot.

The unsafe action results from stopping the CTT prematurely and leaving it at least a foot short of the proper location. This can be represented by CREAM CFF E1, adjusted by the following CPCs with values not equal to 1.0:

- CFF E1: Execution of wrong type performed (with regard to force, distance, speed, or direction). The baseline HEP is 0.003.
- CPC “Available Time”: There is adequate time to perform this task. The only time pressure is the desire to keep the process moving, but the consequences are insignificant. The CPC for an execution task with adequate time is 0.5.
- CPC “Adequacy of Training/Preparation”: This routine task is well trained and practiced and performed quite frequently. The CPC for an execution task with adequate training and high experience is 0.8.

Applying these factors yields the following:

$$\text{CTT is not sufficiently centered under port} = \\ 0.003 \times 0.5 \times 0.8 = 0.002$$

Operator Fails to Notice that CTT Is Not Sufficiently Centered—The CTM operator centers the CTM grapple over the cask lid lift fixture using a two-step process. First, the CTM operator does a rough alignment using the bridge and trolley position indicators and sets the bell and shield skirt in place. Then the operator opens the cask port and performs a fine alignment using a camera alignment system. The operator is not looking for perfect alignment but would expect it to be close. At this point, the operator would have the opportunity to question the amount of distance needed to move the hoist into position. Possible responses include: (1) the position is not off by much, (2) the initial placement of the bell is in question and it is repositioned (which may be easier to accomplish than asking another crew member to move the CTT), or (3) a belief that the position of the CTT is not off center by enough to make a difference.

In this task, the CTM operator roughly centers the CTM over the cask port, lowers the shield, and opens the port and CTM gates. The operator needs to more accurately locate the grapple over the lid by moving the hoist within the bell. At this point, the operator has an opportunity to judge if the amount of movement required to align the grapple is too much for the lid to clear the edges of the port during the lift. In this case, it is not so much an observation error (the operator can't help but observe the relative locations of the grapple and lid) or a diagnosis error (the operator knows the canister is not perfectly centered), but rather a decision error, where the operator decides that it doesn't matter that the cask is not centered (it's “close enough”). This can be represented by CREAM CFF I2, adjusted by the following CPCs with values not equal to 1.0:

- CFF I2: Decision error (either not making a decision or making a wrong or incomplete decision). The baseline HEP is 0.01.
- CPC “Available Time”: With regard to the general level of time pressure for the task and the situation type, it would be easy to believe that there is adequate time since the consequences of taking more time are (from a safety perspective) insignificant. However, from a production perspective, this would be a significant setback since the CTM operator would have to get the CTT crew back to move the CTT, a time-consuming process. This time pressure could bias the operator towards a decision

that “it’s close enough.” The CPC for an interpretation task with continuously inadequate available time is 5.0.

Applying these factors yields the following:

Operator fails to notice that CTT is not sufficiently centered = $0.01 \times 5 = 0.05$

Operator Fails to Notice Lid Tilt—The CTM operator is able to see the lid through the camera display. When the lid strikes the ceiling, it begins to tilt as the hoist continues to rise. The operator has the opportunity to notice the lid tilting before it potentially jams and has the opportunity to stop the lift. The prior unsafe action of failing to notice that the cask is too far off center could still lead the operator to be somewhat more careful and observant during the lift than if it had been closer to center (e.g., like the extra care a driver might show while pulling into a narrower than normal parking space).

If the operator is looking at the camera view during the lift, then the operator has the opportunity to observe the lid contacting the ceiling of the Cask Unloading Room and tilting into the port rather than rising straight through. The most likely failure would be that the operator is not looking at the screen at the time that this occurs, which can be represented by CREAM CFF O3, adjusted by the following CPCs with values not equal to 1.0:

- CFF O3: Observation not made (omission). The baseline HEP is 0.003.
- CPC “Adequacy of Man–Machine Interface”: There are two vulnerabilities in the man–machine interface for this observation. First, there is no alarm or indicator to alert the operator. Second, the camera view is not perfect. These are inherent to this type of operation, but would make it more likely that the operator would not be looking at the screen at the time. Thus, the man–machine interface should be considered inappropriate with regard to success of this observation. The CPC for an observation task with inappropriate man–machine interface is 5.0.

Applying these factors yields the following:

Operator fails to notice lid tilt = $0.003 \times 5 = 0.02$

Operator “Locks” Lift Button into Position—Another way that the lift would go too long is if the operator were to use some inventive means to “lock” the button in place. The CTM lifts are a tedious task and require holding the button in place for long periods of time. There is no locking feature associated with the ASD that would keep the button in place; however, it is not inconceivable that, after many lifts have been done without an ASD failure, an operator would develop a creative technique to accomplish this. Since the operator develops trust in the ASD and the other system interlocks, the action would not be perceived as unsafe but rather as a clever way to free time to get ready for subsequent steps or perform other duties. Again, the operator might be less likely to do this if there are doubts about the positioning of the cask.

The quantification of this event is discussed in detail under Scenario 1(c). In this scenario, it is judged that there is no bias dependency towards this failure that results from prior failures in the scenario. Therefore, the value used for the non-bias case is applied here:

$$\text{Operator "locks" lift button into place} = 0.05$$

Lid Catches and Jams in Port—Given the size of the lid in relation to the port, it is entirely possible that when it strikes the ceiling and tilts sideways, it still goes through the port at an angle without jamming.

The lid is smaller than the port, and a round object passing through a large round hole would generally be expected not to jam (unlike, for example, a square lid and a square hole where there are a number of orientations where jamming could occur). Nevertheless, for the purpose of this analysis this is assessed as having “even-odds” of jamming versus not jamming.

$$\text{Lid catches and jams in port} = 0.5$$

Load Cell Overload Interlock Fails—The load cell has an interlock that shuts off the hoist if it senses that the load exceeds the approved load for the hoist. The hoist straining to lift the lid jammed in the port would be one such condition. Since this would shut the hoist down prior to exceeding the ultimate capacity of the system, it would have to fail in order to cause a drop.

This is a mechanical failure of the interlock. This event is quantified in Section E6.5.3.4.1.

$$\text{Load cell interlock fails} = 2.7E-5$$

Mechanical Failure of Hoist under Overload Causes Lid Drop—There are three potential failure modes that could cause the lid to detach from the hoist. The cable could fail, the grapple could break free from the lower block, or the lifting fixture could break free from the grapple or lid. However, just because the hoist keeps pulling does not mean that the lid falls (the hoist motor could overload and fail before the lid becomes detached from the hoist) or that the lid, once dropped, falls in an orientation that impacts the canister in the transportation cask or aging overpack (the orientation of the falling lid may cause it to only impact the transportation cask or aging overpack structure).

This event is quantified in Section E6.5.3.4.1.

$$\text{Mechanical failure of hoist under overload causes lid drop} = 0.1$$

HEP Calculation for Scenario 1(d)—The events in the HEP model for Scenario 1(d) are presented in Table E6.5-7.

Table E6.5-7. HEP Model for HFE Group #5 Scenario 1(d) for 060-OpCTMdrop001-HFI-COD

Designator	Description	Probability
A	CTT is not sufficiently centered under port	0.002
B	Operator fails to notice CTT not sufficiently centered	0.05
C	Operator fails to notice lid tilt and continues lift	0.02

Table E6.5-7. HEP Model for Scenario 1(d) (Continued)

Designator	Description	Probability
D	Operator “locks” lift button into position	0.05
E	Lid catches and jams in port	0.5
F	Load cell overload interlock fails	2.7E-5
G	Mechanical failure of hoist under overload causes lid drop	0.1

NOTE: CTT = cask transfer trolley; HEP = human error probability.

Source: Original

The Boolean expression for this scenario follows:

$$A \times B \times (C + D) \times E \times F \times G = 0.002 \times 0.05 \times (0.02 + 0.05) \times 0.5 \times 2.7E-5 \times 0.1 < 1E-8 \quad (\text{Eq. E-13})$$

E6.5.3.4.2.5 HFE Group #5 Scenario 1(e) for 060-OpCTMdrop001-HFI-COD

1. Operator activates grapple disengagement switch prematurely.
2. Load cell disengagement interlock fails.
3. Lid drops from grapple and strikes canister.

Operator Activates Grapple Disengagement Switch Prematurely—Once engaged with the lid, the grapple is supposed to remain engaged until the lid is placed in its staging area. The operator could prematurely activate grapple disengagement for one of two reasons. Either the wrong control could be activated (e.g., while closing the port slide gate), or a number of operational steps could be skipped and the operator could actuate the control.

This is a straightforward case of taking an action out of sequence. This can be represented by CREAM CFF E4, adjusted by the following CPCs with values not equal to 1.0:

- CFF E4: Action performed out of sequence (e.g., repetitions, jumps, reversals). The baseline HEP is 0.003.
- CPC “Working Conditions”: With regard to this potential unsafe action, the working conditions for the CTM operator are deemed to be advantageous. The CPC for an execution task with advantageous working conditions is 0.8.
- CPC “Adequacy of Training/Preparation”: This routine action is well trained and performed often. The CPC for an execution task with adequate training and high experience is 0.8.

Applying these factors yields the following:

$$\begin{aligned} &\text{Operator activates grapple disengagement switch prematurely} \\ &= 0.003 \times 0.8 \times 0.8 = 0.002 \end{aligned}$$

Load Cell Disengagement Interlock Fails—One of the load cell interlocks is designed to disable the grapple disengagement circuit if a load is sensed. This interlock would have to fail in order for the operator’s action to trigger the disengagement mechanism.

This is a mechanical failure of the interlock. This event is quantified in Section E6.5.3.4.1.

$$\text{Load cell disengagement interlock fails} = 2.7E-5$$

Lid Drops from Grapple and Strikes Canister—In order for the lid to actually drop, the grapple disengagement mechanism would need to overcome the dead weight friction caused by the weight of the lid. In the case of the canister, this is clearly expected to be true, but the lid weighs much less than the canister; thus, the same expectation is not clear. However, there is still a chance that the grapple would not disengage or would not disengage while the lid is over the open cask port.

There are a number of factors that affect the likelihood of this event. First, in order to strike the canister the disengagement must occur over the canister, including that the slide gates are open. Second, the design of the grapple is such that it may not have the force to disengage when it is loaded (this is certainly true when lifting a canister, but perhaps less so when lifting a lid). Finally, the lid has to fall in an orientation such that it strikes the canister. Taking this all into consideration, the HRA team judges that it is justifiable to assign a 10% chance that this event would occur.

$$\text{Lid drops from grapple and strikes canister} = 0.1$$

HEP Calculation for Scenario 1(e)—The events in the HEP model for Scenario 1(e) are presented in Table E6.5-8.

Table E6.5-8. HEP Model for HFE Group #5 Scenario 1(e) for 060-OpCTMdrop001-HFI-COD

Designator	Description	Probability
A	Operator activates grapple disengagement switch prematurely	0.002
B	Load cell disengagement interlock fails	2.7E-5
C	Lid drops from grapple and strikes canister	0.1

NOTE: HEP = human error probability.

Source: Original

The Boolean expression for this scenario follows:

$$A \times B \times C = 0.002 \times 2.7E-5 \times 0.1 < 1E-8 \quad (\text{Eq. E-14})$$

E6.5.3.4.2.6 HEP for HFE 060-OpCTMdrop001-HFI-COD

The Boolean expression for the overall HFE (all scenarios) for lifting a lid off a transportation cask or aging overpack follows:

$$\begin{aligned} &060\text{-OpCTMdrop001-HFI-COD (lid lift)} = \\ &\text{HFE 1(a)} + \text{HFE 1(b)} + \text{HFE 1(c)} + \text{HFE 1(d)} + \text{HFE 1(e)} = \\ &(<1\text{E-8}) + 1\text{E-7} + (<1\text{E-8}) + (<1\text{E-8}) + (<1\text{E-8}) = 2\text{E-7} \end{aligned} \quad (\text{Eq. E-15})$$

The Boolean expression for the overall HFE (all scenarios) for placing an inner lid on a waste package or a lid on an aging overpack follows:

$$\begin{aligned} &060\text{-OpCTMdrop001-HFI-COD (lid placement)} = \\ &\text{HFE 1(a)} + \text{HFE 1(b)} + \text{HFE 1(e)} = \\ &2\text{E-8} + 1\text{E-7} + (<1\text{E-8}) = 2\text{E-7} \end{aligned} \quad (\text{Eq. E-16})$$

Except for DPCs, which only have a lid placement, all canisters have one lid lift and one lid placement as part of their processing. For simplicity, DPCs were conservatively modeled the same as other canisters, and the Boolean expression for the overall HFE for a lid lift and a lid placement follows:

$$\begin{aligned} &060\text{-OpCTMdrop001-HFI-COD (total)} = 060\text{-OpCTMdrop001-HFI-COD (lid lift)} \\ &+ 060\text{-OpCTMdrop001-HFI-COD (lid placement)} = 2\text{E-7} + 2\text{E-7} = 4\text{E-7} \end{aligned} \quad (\text{Eq. E-17})$$

E6.5.3.4.3 Quantification of HFE Scenarios for 060-OpCTMdrop002-HFI-COD: Operator Causes Drop of Canister during CTM Operations

E6.5.3.4.3.1 HFE Group #5 Scenario 2(a) for 060-OpCTMdrop002-HFI-COD

1. Crew member improperly installs grapple.
2. Primary grapple interlock gives false positive signal.
3. Operator fails to notice bad connection between hoist and grapple through camera.
4. Grapple/canister drops from hoist.

Crew Member Improperly Installs Grapple—Prior to a lift operation, a crew member prepares the CTM for the operation by installing the appropriate grapple for the type of canister to be processed. While it is possible that this operation does not need to be performed (it may be the same grapple as for the cask lid), it is uncertain how often this occurs, so this analysis considers that this action needs to be performed each time. The crew member can improperly secure the grapple to the hoist. This makes the grapple appear to be secured in place when it is not.

This is a straightforward matter of task execution. The task is simple and routine and can be represented by NARA GTT A5, adjusted by the following EPCs:

- GTT A5: Completely familiar, well-designed, highly practiced routine task performed to the highest possible standards by highly motivated, highly trained, and experienced

person, totally aware of implications of failure, with time to correct potential errors. The baseline HEP is 0.0001.

- EPC 3: Time pressure. The full affect EPC would be $\times 11$, but this applies only in cases where there is barely enough time to complete a task, and rapid work is necessary. In this case, the time pressure is more abstract in that there is a desire to keep the process moving for production reasons, but not a compelling one. The APOA anchor for 0.1 is that the operator feels some time pressure, but there is sufficient time to carry out the task properly with checking. The crew member probably feels a little more time pressure, so the APOA is set at 0.2.
- EPC 8: Poor environment. This EPC is applied not so much that the environment is poor, but rather that it is simply not optimal. The full affect EPC would be $\times 8$, but this applies when working on the plant, with suit and breathing apparatus, possible access problems, and for more than 45 minutes so that fatigue sets in. The APOA anchor for 0.1 is for work in the plant with suit and breathing apparatus, but none of the other environmental stressors. In this task no breathing apparatus is required, but it is somewhat physically demanding. Given the tradeoffs, the APOA is set at 0.1.
- EPC 13: Operator underload/boredom. The full affect EPC would be $\times 3$, which applies to a routine task of low importance, carried out by a single individual for several hours. The APOA anchor for 0.1 is for low difficulty, low importance, single individual, for less than one hour. This appears reasonable for this task, so the APOA is set at 0.1.

Using the NARA HEP equation yields the following:

$$\begin{aligned} &\text{Crew member improperly installs grapple} = \\ &0.0001 \times [(11-1) \times 0.2 + 1] \times [(8-1) \times 0.1 + 1] \times [(3-1) \times 0.1 + 1] = 0.0006 \quad (\text{Eq. E-18}) \end{aligned}$$

Preoperational Check Fails to Note Improper Installation—There are two crew members responsible for preparing the CTM for each operation. The second crew member checks the first crew member’s installation of the grapple, which provides an opportunity for the error to be detected. The second crew member also has activities to perform, and so checking the first crew member is a secondary function. In addition, the existence of the grapple/hoist interlock provides an expectation that any error can be detected.

For the action being analyzed, the second crew member has helped initially with the connection of the grapple to line it up but then moves on to other things. At best, the second crew member performs a cursory check at the end of the job. Since the crew member was involved in the early stages, there is a bias that the job was done correctly. It is concluded that the level of dependence is high. The baseline HEP for the checking, for checking routine tasks without a checklist is best determined from THERP (Ref. E8.1.26), Table 20-22, item (2), which is 0.2 (Ref. E8.1.26). The HEP adjusted for high dependence is from THERP (Table 20-21, item (4)(e)), which is 0.6.

$$\text{Preoperational check fails to note improper installation} = 0.6$$

Grapple Interlock Gives False Positive Signal—Before beginning the lifting process, the operator should confirm engagement by checking the primary grapple engagement interlock. The indicator could give a false positive signal. This could result from a failure in the indicator itself or as the result of a partial engagement that generates a positive signal by triggering the sensor even though only partial engagement has occurred. Since the indicator system has not yet been designed and the specific detection approach has not been defined, this cannot be ruled out.

This is a mechanical failure of the interlock. This event is quantified in Section E6.5.3.4.1.

$$\text{Grapple interlock gives false positive signal} = 2.7E-5$$

Operator Fails to Notice Bad Connection between Hoist and Grapple through Camera—When the CTM operator is in the process of lifting the canister, the view through the camera shows the grapple and its connection to the hoist. The operator is not focused on that connection while lining up the grapple with the lifting device. However, as the lift begins, the operator is supposed to watch through the cameras. This gives the operator the opportunity to note that the grapple is not properly connected (e.g., unexpected canister movement to one side or tilting of the grapple). This is an opportunity to question the stability of the connection and to lower the canister back down to recheck the connection. However, the operator does not expect any problems in this operation and tends to believe that any perceived problems are illusions caused by the distortions of viewing through a camera.

This action is best represented by the CREAM CFF O3, adjusted by the following CPCs with values not equal to 1.0:

- CFF O3: Observation not made. The baseline HEP is 0.003.
- CPC “Adequacy of Man–Machine Interface”: For this particular observation, the use of a camera view (while the only practical means) is somewhere between tolerable and inappropriate. The CPC for an observation task with tolerable man–machine interface is 1.0, and for inappropriate is 5.0. With regard to being able to actually observe the condition of the grapple lock pin, the CPC is set as 4.0.
- CPC “Number of Simultaneous Goals”: The operator is primarily focusing on properly aligning the bell and hoist, opening the ports, and grappling the lid. While it could be argued that this is not “more than capacity,” it certainly relegates looking at the grapple/hoist connection to a secondary action. It is therefore deemed appropriate to apply the more than capacity CPC, which is 2.0.
- CPC “Adequacy of Training/Preparation”: Training is adequate with high experience. The CPC for an observation task with adequate training and high experience is 0.8.

$$\begin{aligned} \text{Operator fails to notice bad connection between hoist and grapple through} = \\ 0.003 \times 4 \times 2 \times 0.8 = 0.02 \end{aligned}$$

Grapple/Canister Drops from Hoist—Just because the lift is occurring with an improper grapple installation does not mean that the lid and grapple fall. The design safety margins built

into these systems mean that it is possible that the lift and place can be completed successfully even with improper installation.

This event is quantified in Section E6.5.3.4.1.

$$\text{Grapple/canister drops from hoist} = 0.25$$

HEP Calculation for Scenario 2(a)—The events in the HEP model for Scenario 2(a) are presented in Table E6.5-9.

Table E6.5-9. HEP Model for HFE Group #5 Scenario 2(a) for 060-OpCTMdrop002-HFI-COD

Designator	Description	Probability
A	Crew member improperly installs grapple	0.0006
B	Preoperational check fails to note improper installation	0.6
C	Grapple interlock gives false positive signal	2.7E-5
D	Operator fails to notice bad connection between hoist and grapple through camera	0.02
E	Grapple/canister drops from hoist	0.25

NOTE: HEP = human error probability.

Source: Original

The Boolean expression for this scenario follows:

$$A \times B \times C \times D \times E = 0.0006 \times 0.6 \times 2.7E-5 \times 0.02 \times 0.25 < 1E-8 \quad (\text{Eq. E-19})$$

E6.5.3.4.3.2 HFE Group #5 Scenario 2(b) for 060-OpCTMdrop002-HFI-COD

1. Operator fails to fully engage grapple.
2. Grapple engagement interlock gives false positive signal.
3. Operator fails to notice grapple not fully engaged through camera.
4. Canister drops from grapple.

CTM Operator Fails to Fully Engage Grapple—The operator engages the grapple from the control panel. The grapple can be roughly positioned using the alignment guides for the CTM and the hoist height indicator on the control panel, but final alignment must be done visually using the view from the cameras provided on the grapple. Once the operator believes the grapple is aligned, the operator engages the grapple with the lift fixture and confirms through the camera. If the operator sees that the grapple has not properly engaged, then the operator disengages and repositions the grapple and tries again to engage.

In this task, the operator aligns the grapple visually using the camera view and then engages the grapple. If it is not aligned properly, it does not fully engage. This unsafe action can be best represented by the task execution error NARA GTT A1, adjusted by the following CPCs:

- NARA GTT A1: Carry out a simple manual task with feedback. Skill-based and therefore not necessarily with procedures. The baseline HEP is 0.005

- EPC 3: Time pressure. The full affect EPC would be $\times 11$, but this applies only in cases where there is barely enough time to complete a task and rapid work is necessary. In this case, the time pressure is more abstract, in that there is a desire to keep the process moving for production reasons, but not a compelling one. The APOA anchor for 0.1 is that the operator feels some time pressure, but there is sufficient time to carry out the task properly with checking. The crew member probably feels a little more time pressure than that, so the APOA is set at 0.2.
- EPC 11: Poor, ambiguous or ill-matched system feedback. This EPC is applied to account for the need to observe the operation through cameras. The full affect EPC would be $\times 4$. The full effect is applicable when legibility is poor or label is obscured, or where the layout of controls makes visual access and physical access difficult. The use of camera view is deemed to represent full effect. The APOA is set at 1.0.
- EPC 13: Operator underload/boredom. The full affect EPC would be $\times 3$, which applies to a routine task of low importance, carried out by a single individual for several hours. The APOA anchor for 0.1 is for low difficulty, low importance, single individual, for less than one hour. This appears reasonable for this task, so the APOA is set at 0.1.

Using the NARA HEP equation yields the following:

$$\begin{aligned} &\text{Operator fails to fully engage grapple} = \\ &0.005 \times [(11-1) \times 0.2 + 1] \times [(4-1) \times 1.0 + 1] \times [(3-1) \times 0.1 + 1] = 0.07 \quad (\text{Eq. E-20}) \end{aligned}$$

Grapple Engagement Interlock Gives False Positive Signal—Before beginning the lifting process, the operator should confirm engagement by checking the grapple engagement interlock. The indicator could give a false positive signal. This could result from a failure in the indicator itself or as the result of a partial engagement that generates a positive signal by triggering the sensor even though only partial engagement has occurred. Since the indicator system has not yet been designed and the specific detection approach has not been defined, this cannot be ruled out.

This is a mechanical failure of the interlock. This event is quantified in Section E6.5.3.4.1.

$$\text{Grapple engagement interlock gives false positive signal} = 2.7\text{E}-5$$

CTM Operator Fails to Notice Grapple Not Fully Engaged through Camera—As the lift begins, the operator is supposed to watch through the cameras. This gives the operator the opportunity to note that the grapple is not properly engaged (e.g., unexpected canister movement to one side or tilting of the grapple), which allows the operator the opportunity to question the stability of the connection and to lower the canister back down to recheck the connection. However, the operator does not expect any problems in this operation and tends to believe that any perceived problems are illusions caused by the distortions of viewing through a camera.

In this case, the operator’s check is a self-check, again through the camera. The CTM operator believes that the correct action was performed initially, and this was confirmed by the false positive from the interlock, so this observation is deemed completely dependent on the prior

actions. Using THERP (Ref. E8.1.26) Table 20-21 (Ref. E8.1.26) to assess dependency, item (5) for complete dependency:

Operator fails to notice grapple not fully engaged through camera = 1.0

Canister Drops from Grapple—Just because the lift is occurring with an improper grapple engagement does not mean that the canister falls. The safety margins built into these systems mean that it is possible that the lift and place are completed successfully even with improper installation.

This event is quantified in Section E6.5.3.4.1.

Canister drops from grapple = 0.25

HEP Calculation for Scenario 2(b)—The events in the HEP model for Scenario 2(b) are presented in Table E6.5-10.

Table E6.5-10. HEP Model for HFE Group #5 Scenario 2(b) for 060-OpCTMdrop002-HFI-COD

Designator	Description	Probability
A	Operator fails to fully engage grapple	0.07
B	Grapple engagement interlock gives false positive signal	2.7E-5
C	Operator fails to notice grapple not fully engaged through camera	1.0
D	Canister drops from grapple	0.25

NOTE: HEP = human error probability.

Source: Original

The Boolean expression for this scenario follows:

$$A \times B \times C \times D = 0.07 \times 2.7E-5 \times 1.0 \times 0.25 = 5E-7 \quad (\text{Eq. E-21})$$

E6.5.3.4.3.3 HFE Group #5 Scenario 2(c) for 060-OpCTMdrop002-HFI-COD (Applies to DPC/Transportation Cask Only)

1. CTT is not sufficiently centered under port.
2. Operator fails to notice CTT not sufficiently centered.
3. Operator fails to notice DPC contacting ceiling and continues lift OR operator “locks” lift button into position.
4. Load cell overload interlock fails.
5. Mechanical failure of hoist under overload causes DPC drop. (NOTE: This scenario only applies to DPCs because the transportation cask lid was removed in the preparation area).

CTT Is Not Sufficiently Centered under Port—This unsafe action actually occurs prior to this operation, during movement of the CTT into the Cask Unloading Room. The CTT operator brings the unit into the Cask Unloading Room and locates it centered directly under the cask port by aligning it against end stops that properly locate it and by using markings on the floor. If the cask is not properly centered, it is possible that the DPC could strike the ceiling around the cask port rather than rising smoothly through the cask port. This only applies to DPCs because their transportation cask lids are removed in the preparation area. For all other waste forms any misalignment would be discovered during the lid lift by the CTM. In order for the DPC to hit the Cask Unloading Room ceiling during lift, the cask would have to be off-center by more at least a few feet.

The unsafe action results from stopping the CTT prematurely and leaving it at least a number of feet short of the proper location. This can be represented by CREAM CFF E1, adjusted by the following CPCs with values not equal to 1.0:

- CFF E1: Execution of wrong type performed (with regard to force, distance, speed, or direction). The baseline HEP is 0.003.
- CPC “Available Time”: There is adequate time to perform this task. The only time pressure is the desire to keep the process moving, but the consequences are insignificant. The CPC for an execution task with adequate time is 0.5.
- CPC “Adequacy of Training/Preparation”: This routine task is well trained and practiced and performed quite frequently. The CPC for an execution task with adequate training and high experience is 0.8.

The above parameters were the same as those applied to failure to properly center the CTT for a lid, where only being about a foot or two out of position could cause a problem. For the case of a canister, the miss must be by at least a few feet in order for the canister to strike the ceiling on the way up. The HRA team believes it is inappropriate to apply the same number to both unsafe actions, and deems it reasonable to further reduce the HEP for the unsafe action by a factor of two to account for this (a multiplier of 0.5).

Applying these factors yields the following:

$$\text{CTT is not sufficiently centered under port (DPC/transportation cask)} = \\ 0.003 \times 0.5 \times 0.8 \times 0.5 = 0.001$$

Operator Fails to Notice that CTT Is Not Sufficiently Centered—The CTM operator centers the CTM grapple over the cask lid lift fixture using a two-step process. First the CTM operator does a rough alignment using the bridge and trolley position indicators and sets the bell and shield skirt in place. Then the operator opens the cask port and performs a fine alignment using a camera alignment system. The operator is not looking for perfect alignment but would expect it to be close. At this point, the operator would have the opportunity to question the amount of distance needed to move the hoist into position. Possible responses include: (1) the position is not off by much, (2) the initial placement of the bell is in question and it is repositioned (which

may be easier to accomplish than asking another crew member to move the CTT), or (3) a belief that the position of the CTT is not off center by enough to make a difference.

In this task, the CTM operator roughly centers the CTM over the cask port, lowers the shield, and opens the port and CTM gates. The operator needs to more accurately locate the grapple over the lid by moving the hoist within the bell. At this point, the operator has an opportunity to judge if the amount of movement required to align the grapple is too much for the lid to clear the edges of the port during the lift. In this case, it is not so much an observation error (the operator can't help but observe the relative locations of the grapple and lid) or a diagnosis error (the operator knows the canister is not perfectly centered), but rather a decision error, where the operator decides that it doesn't matter that the cask is not centered (it's "close enough"). This can be represented by CREAM CFF I2, adjusted by the following CPCs with values not equal to 1.0.

- CFF I2: Decision error (either not making a decision or making a wrong or incomplete decision). The baseline HEP is 0.01.
- CPC "Available Time": With regard to the general level of time pressure for the task and the situation type, it would be easy to believe that there is adequate time since the consequences of taking more time are (from a safety perspective) insignificant. However, from a production perspective, this would be a significant setback since the CTM operator would have to get the CTT crew back to move the CTT, a time-consuming process. This time pressure could bias the operator towards a decision that "it's close enough." The CPC for an interpretation task with continuously inadequate available time is 5.0.

Applying these factors yields the following:

$$\text{Operator fails to notice that CTT is not sufficiently centered} = 0.01 \times 5 = 0.05$$

Operator Fails to Notice DPC Contacting Ceiling and Continues Lift—The CTM operator is able to see the DPC through the camera display. When the DPC strikes the ceiling, it will stop as the hoist continues to try to rise. The operator has an opportunity to notice the stopped CTM before it stops the lift. The prior unsafe action of failing to notice that the cask is too far off center could lead the operator to be somewhat more careful and observant during the lift than if it had been closer to center (e.g., like the extra care a driver might show while pulling into a narrower than normal parking space).

If the operator is looking at the camera view during the lift, there is an opportunity to observe the DPC contacting the ceiling of the Cask Unloading Room and stopping rather than rising straight through. The most likely failure is not looking at the screen at the time this occurs, which can be represented by CREAM CFF O3, adjusted by the following CPCs with values not equal to 1.0:

- CFF O3: Observation not made (omission). The baseline HEP is 0.003.
- CPC "Adequacy of Man–Machine Interface": There are two vulnerabilities in the man–machine interface for this observation. First, there is no alarm or indicator to alert the

operator. Second, the camera view is not perfect. These are inherent to this type of operation, but would make it more likely that the operator would not be looking at the screen at the time. Thus, the man-machine interface could be considered inappropriate with regard to success of this observation (as it was for scenario 1(e)). However, the fact that the magnitude of the CTT offset required to cause a problem is so much greater in this case argues for a somewhat lesser adjustment. That is, the man-machine interface is somewhat better with regard to this failure, and it is more likely that the operator is looking and sees the contact. The CPC for an observation task with inappropriate man-machine interface is 5.0. The HRA team has determined that a CPC of 3.0 is more appropriate in this case.

Applying these factors yields the following:

$$\text{Operator fails to notice DPC contacting ceiling and continues lift} = 0.003 \times 3 = 0.01$$

Operator “Locks” Lift Button into Position—Another way that the lift would go too long is if the operator were to use some inventive means to “lock” the button in place. The CTM lifts are a tedious task and require holding the button in place for long periods of time. There is no locking feature associated with the ASD that would keep the button in place; however, it is not inconceivable that, after many lifts have been done without ASD failure, an operator would develop a creative technique to accomplish this. Since the operator develops trust in the ASD and the other system interlocks, the action would not be perceived as unsafe but rather as a clever way to free time to get ready for subsequent steps or perform other duties. Again, the operator might be less likely to do this if there are doubts about the positioning of the cask.

The quantification of this event is discussed in detail under Scenario 1(c). In this scenario, it is judged that there is no bias dependency towards this failure that results from prior failures in the scenario. Therefore, the value used for the non-bias case (0.05) could be applied here. However, similar to the previous discussion, the HRA team believes that the magnitude of the CTT offset required to cause a problem actually creates a bias in the operator against taking any shortcuts (as opposed to no bias), so that a further reduction of 0.5 should be applied.

$$\text{Operator “locks” lift button into place} = 0.05 \times 0.5 = 0.03$$

Load Cell Overload Interlock Fails—The load cell has an interlock that shuts off the hoist if it senses that the load exceeds the approved load for the hoist. The hoist straining to lift the DPC in contact with the ceiling would be one such condition. Since this would shut the hoist down prior to exceeding the ultimate capacity of the system, it would have to fail in order to cause a drop.

This is a mechanical failure of the interlock. This event is quantified in Section E6.5.3.4.1.

$$\text{Load cell interlock fails} = 2.7E-5$$

Mechanical Failure of Hoist under Overload Causes DPC Drop—There are three potential failure modes that could cause the canister to detach from the hoist. The cable could fail, the grapple could break free from the lower block, or the lifting fixture could break free from the

grapple or DPC. However, just because the hoist keeps pulling does not mean that the DPC falls (the hoist motor could overload and fail before the DPC becomes detached from the hoist).

This event is quantified in Section E6.5.3.4.1.

Mechanical failure of hoist under overload causes DPC drop = 0.25

HEP Calculation for Scenario 2(c)—The events in the HEP model for Scenario 2(c) are presented in Table E6.5-11.

Table E6.5-11. HEP Model for HFE Group #5 Scenario 2(c) for 060-OpCTMdrop002-HFI-COD

Designator	Description	Probability
A	CTT is not sufficiently centered under port	0.001
B	Operator fails to notice CTT not sufficiently centered	0.05
C	Operator fails to notice DPC contacting ceiling and continues lift	0.01
D	Operator “locks” lift button into position	0.03
E	Load cell overload interlock fails	2.7E-5
F	Mechanical failure of hoist under overload causes DPC drop	0.25

NOTE: CTT = cask transfer trolley; DPC = dual-purpose canister; HEP = human error probability.

Source: Original

The Boolean expression for this scenario follows:

$$A \times B \times (C + D) \times E \times F = 0.001 \times 0.05 \times (0.01 + 0.03) \times 2.7E-5 \times 0.25 < 1E-8 \quad (\text{Eq. E-22})$$

E6.5.3.4.3.4 HEP for HFE 060-OpCTMdrop002-HFI-COD

The Boolean expression for the overall HFE (all scenarios) for lifting a DPC/transportation cask follows:

$$060\text{-OpCTMdrop002-HFI-COD (DPC/TC)} = \text{HFE 2(a)} + \text{HFE 2(b)} + \text{HFE 2(c)} = (<1E-8) + 5E-7 + (<1E-8) = 5E-7 \quad (\text{Eq. E-23})$$

The Boolean expression for the overall HFE (all scenarios) for lifting all other canisters follows:

$$060\text{-OpCTMdrop002-HFI-COD (non-DPC/TC)} = \text{HFE 2(a)} + \text{HFE 2(b)} = (<1E-8) + 5E-7 + (<1E-8) = 5E-7 \quad (\text{Eq. E-24})$$

E6.5.3.4.4 Quantification of HFE Scenarios for 060-OpCTMImpact1-HFI-COD: Operator Moves the CTM while Canister or Object Is Below or Between Levels

E6.5.3.4.4.1 HFE Group #5 Scenario 3(a) for 060-OpCTMImpact1-HFI-COD

1. Operator leaves CTM in lid lift mode (non-DPCs).
2. Operator fails to notice that lift stops too soon.

3. Operator fails to close port slide gate OR fails to notice that it does not fully close.
4. Operator fails to close CTM slide gate OR fails to notice it does not fully close.
5. CTM slide gate interlock fails.

Operator Leaves CTM in Lid Lift Mode (Non-DPCs)—The operator is supposed to set the ASD to canister lift mode prior to lifting the canister. It should be in lid lift mode because the lid was lifted right before the canister. Failing to reset for a canister lift would result in the canister stopping part way through the port.

Setting the CTM system to the appropriate lift mode prior to performing a lift is fundamental to the operation, not simply a step in a procedure that can be missed. The initial action to set the mode is quite simple, so the only realistic way that the operator can leave the ASD in lid lift mode is to completely fail to take any actions to set the CTM system for a lift. This failure can be represented by NARA GTT B3, adjusted by the following EPCs.

- GTT B3: Set system status as part of routine operations using strict administratively controlled procedures. The baseline HEP is 0.0007.

This operation is performed under optimal conditions. It is early in the operation, and the operator is active, so it is too early in the task for boredom to set in. The baseline HEP is used without adjustment.

Operator leaves CTM in lid lift mode = 0.0007

Operator Fails to Notice that Lift Stops too Soon—Lifting the canister takes on the order of ten minutes, whereas lifting the lid takes only on the order of three minutes. Since the operator has to hold the lift button in or the lift stops, there is an opportunity to notice that the hoist has stopped sooner than expected. On the control panel the operator would have the camera view and also the hoist position indication, either of which can confirm that the canister has not been fully lifted. Failure to do so would result in continuing the operations with the canister between floors.

The operator is supposed to hold the lift button until the lift automatically stops. The operator has performed this operation many times in the past and has an instinctive feel for how long the lift takes. A canister lift should take around three times as long as a lid lift. If the operator feels it has not taken long enough, the camera and the indicators on the control panel can provide confirmation that the lift was prematurely terminated. Failing to recognize the short lift (and thus an implied failure to question the result of the action) could be an observation error (CREAM CFF O2, wrong identification made, or O3, observation not made). But the more conservative and more applicable approach is represented by the interpretation error CREAM CFF I1, adjusted by the following CPCs with values not equal to 1.0:

- CFF I1: Faulty diagnosis (either a wrong diagnosis or an incomplete diagnosis). The baseline HEP is 0.2.
- CPC “Working Conditions”: The operator has optimal working conditions in the control room. The CPC for an interpretation task with advantageous working conditions is 0.8.

- CPC “Available Time”: The operator clearly has adequate time before beginning the next steps in the process to realize that the amount of time spent in the lift is not reasonable for a canister lift. The CPC for an interpretation task with adequate available time is 0.5.
- CPC “Adequacy of Training/Preparation”: Training is adequate with high experience. The CPC for an observation task with adequate training and high experience is 0.8.

Applying these factors yields the following:

$$\text{Operator fails to notice lift is taking too long} = 0.2 \times 0.8 \times 0.5 \times 0.8 = 0.07$$

Operator Fails to Close Port Slide Gate—The operator is supposed to close the port slide gate as soon as the lift is completed. This gives the operator an opportunity to determine that the canister is not fully withdrawn. The operator would fail to notice this if either the operator skipped this step or if the operator performed the action and failed to notice that the gate had not closed all the way (e.g., because it is blocked from doing so by the canister). In the latter case, the slide gate open/close indicator lights are in an incorrect state (either both on or both off, depending on design).

The operator is supposed to close the port slide gate prior as a part of the lift and transfer process. This is an EOO that can most closely be represented by CREAM CFF E5, adjusted by the following CPCs with values not equal to 1.0:

- CFF E5: Action missed, not performed (omission), including the omission of the last actions in a series. The baseline HEP is 0.03.
- CPC “Available Time”: There is adequate time available. The CPC for an execution task with adequate time is 0.5.
- CPC “Adequacy of Training/Preparation”: Training is adequate with high experience. The CPC for an execution task with adequate training and high experience is 0.8.

Applying these factors yields the following:

$$\text{Operator fails to close port slide gate} = 0.03 \times 0.5 \times 0.8 = 0.01$$

Operator Fails to Notice that Port Slide Gate Does Not Fully Close—The action of closing the port slide gate is simple. In this scenario, the gate does not close all the way because the canister is in the way. The operator has visible feedback on the failure of the gate to close because the “open” (or “green”) light on the control panel stays on and the “closed” (or “red”) light also comes on and stays on. Both lights on at the same time signifies that the port is neither fully open nor fully closed. The problem can be easily confirmed by looking at the camera or checking the status of the light curtain at the bottom of the bell. This unsafe action can be represented by NARA GTT C1, adjusted by the following EPCs.

- GTT C1: Simple response to a range of alarms/indications providing clear indication of situation (simple diagnosis required). The baseline HEP is 0.0004.

- EPC 3: Time pressure. The full affect EPC would be $\times 11$, but this applies only in cases where there is barely enough time to complete a task, and rapid work is necessary. In this case, the time pressure is more abstract in that there is a desire to keep the process moving for production reasons, but not a compelling one. The APOA anchor for 0.1 is that the operator feels some time pressure, but there is sufficient time to carry out the task properly with checking. This appears reasonable for this task, so the APOA is set at 0.1.
- EPC 13: Operator underload/boredom. The full affect EPC would be $\times 3$, which applies to a routine task of low importance, carried out by a single individual for several hours. The APOA anchor for 0.1 is for low difficulty, low importance, single individual, for less than one hour. This appears reasonable for this task, so the APOA is set at 0.1.

Using the NARA HEP equation yields the following:

$$\begin{aligned} &\text{Operator fails to notice that port slide gate does not fully close} \\ &= 0.0004 \times [(11-1) \times 0.1 + 1] \times [(3-1) \times 0.1 + 1] = 0.001 \quad (\text{Eq. E-25}) \end{aligned}$$

Operator Fails to Close CTM Slide Gate—The operator is supposed to close the CTM slide gate as soon as the port slide gate is closed. This gives the operator another opportunity to determine that the canister is not fully withdrawn. The operator would fail to notice this if either the operator skipped this step or if the operator performed the action and failed to notice that the gate had not closed all the way (e.g., because it is blocked from doing so by the hoist cables or load cell). In the latter case, the slide gate open/close indicator lights would be an incorrect state (either both on or both off, depending on design).

The baseline HEP for failure to close this gate would be the same as for the similar unsafe action for the port slide gate.

$$\text{Operator fails to close CTM slide gate (independent)} = 0.01$$

However, this would only apply in the case where the earlier unsafe action was failure to notice that the port slide gate had failed to close. In the case where the earlier unsafe action was failure to close the port slide gate, there is a dependence on the failure to perform a similar task next in the sequence. It is judged that the dependence between these two actions is high. Using item (4)(a) from THERP (Ref. E8.1.26) Table 20-21, the HEP follows:

$$\text{Operator fails to close CTM slide gate (given failure to close the port slide gate)} = 0.5$$

Operator Fails to Notice CTM Slide Gate Does Not Fully Close—The baseline HEP for failure to notice that this gate did not fully close would be the same as for the similar unsafe action for the port slide gate.

$$\text{Operator fails to notice CTM slide gate does not fully close (independent)} = 0.001$$

However, this would only apply in the case where the earlier unsafe action was failure to close the port slide gate. In the case where the earlier unsafe action was failure to notice that the port slide gate did not fully close, there is a dependence on the failure to perform a similar task next

in the sequence. It is judged that the dependence between these two actions is high. Using item (4)(a) from THERP (Ref. E8.1.26) Table 20-21, the HEP follows:

Operator fails to notice CTM slide gate does not fully close
(given failure notice that port slide gate did not fully close) = 0.5

CTM Slide Gate Interlock Fails—The CTM slide gate interlock prevents CTM movement with the slide gate open (the shield skirt cannot be raised). If the interlock itself fails, the operator can move the CTM with the canister between levels.

This is a mechanical failure of the interlock. This event is quantified in Section E6.5.3.4.1.

CTM slide gate interlock fails = 2.7E-5

HEP Calculation for Scenario 3(a)—The events in the HEP model for Scenario 3(a) are presented in Table E6.5-12.

Table E6.5-12. HEP Model for HFE Group #5 Scenario 3(a) for 060-OpCTMImpact1-HFI-COD

Designator	Description	Probability
A	Operator leaves CTM in lid lift mode	0.0007
B	Operator fails to notice that lift stops too soon	0.07
C	Operator fails to close port slide gate	0.01
D	Operator fails to notice that port slide gate does not fully close	0.001
E1	Operator fails to close CTM slide gate (independent)	0.01
E2	Operator fails to close CTM slide gate (given failure to close the port slide gate)	0.5
F1	Operator fails to notice CTM slide gate does not fully close (independent)	0.001
F2	Operator fails to notice CTM slide gate does not fully close (given failure to notice that port slide gate did not fully close)	0.5
G	CTM slide gate interlock fails	2.7E-05

NOTE: CTM = canister transfer machine; HEP = human error probability.

Source: Original

The Boolean expression for this scenario follows:

$$\begin{aligned}
 & A \times B \times \{ [C \times (E2 + F1)] + [D \times (E1 + F2)] \} \times G = \\
 & 0.0007 \times 0.07 \times \{ [0.01 \times (0.5 + 0.001)] + [0.001 \times (0.01 + 0.5)] \} \times 2.7E-05 = \\
 & \qquad \qquad \qquad 0.0007 \times 0.07 \times 0.006 \times 2.7E-05 = (<1E-8) \qquad \qquad \qquad \text{(Eq. E-26)}
 \end{aligned}$$

E6.5.3.4.4.2 HFE Group #5 Scenario 3(b) for 060-OpCTMImpact1-HFI-COD

1. Operator places CTM in lid lift mode (DPCs).
2. Operator fails to notice that lift stops too soon.
3. Operator fails to close port slide gate OR fails to notice that it does not fully close.
4. Operator fails to close CTM slide gate OR fails to notice it does not fully close.
5. CTM slide gate interlock fails.

Operator Inadvertently Places CTM in Lid Lift Mode (DPCs)—The operator is supposed to set the ASD to canister lift mode prior to lifting the canister. For DPC operations, the ASD is in maintenance (or manual) lift mode because this is the default positioning. Failing to reset for canister lift would result in the canister stopping part way through the port.

The CTM operator is supposed to set the CTM system to the appropriate lift mode prior to performing a lift. This is fundamental to the operation, not simply a step in a procedure that can be missed. For the situation involving DPCs, the ASD has been in maintenance mode as a default condition; therefore, the operator must inadvertently set the ASD to lid lift mode rather than canister lift mode. There are only two modes to choose from: lid lift and canister lift. The ASD control is a screen where the operator can scroll between the choices to pick the appropriate lift mode. The act of selecting the wrong mode from these two can be best represented by the task execution error NARA GTT A1, adjusted by the following CPCs:

- NARA GTT A1: Carry out a simple single manual action with feedback. Skill-based and therefore not necessarily with procedures. The baseline HEP is 0.005.
- This operation is performed under optimal conditions. It is early in the operation, and the operator is active, so it is too early in the task for boredom to set in. The ASD control system requests confirmation from the operator (e.g., “You have selected canister lift. Confirm Y/N”). The baseline HEP is used without adjustment.

Operator inadvertently places CTM in lid lift mode (DPCs) = 0.005.

Operator Fails to Notice that Lift Stops too Soon—Lifting the canister takes on the order of ten minutes, whereas lifting the lid takes only on the order of three minutes. Since the operator has to hold the lift button in or the lift stops, the operator has an opportunity to notice that the hoist has stopped sooner than expected. In front on the control panel there is a camera view and also the hoist position indication, either of which can confirm the suspicion that the canister has not been fully lifted. Failure to do so would result in a continuation of the operations with the canister between floors.

The operator is supposed to hold the lift button until the lift automatically stops. The operator has performed this operation many times in the past, and has an instinctive feel for how long the lift takes. A canister lift should take around three times as long as a lid lift. If the operator feels it has not taken long enough, the operator need only look at the camera and the indicators on the control panel. Failing to recognize the short lift (and thus an implied failure to question the result of the action) can be represented by CREAM CFF I1, adjusted by the following CPCs with values not equal to 1.0:

- CFF I3: Faulty diagnosis (either a wrong diagnosis or an incomplete diagnosis). The baseline HEP is 0.2.
- CPC “Working Conditions”: The operator has optimal working conditions in the control room. The CPC for an interpretation task with advantageous working conditions is 0.8.

- CPC “Available Time”: The operator clearly has adequate time before beginning the next steps in the process to realize that the amount of time spent in the lift is not reasonable for a canister lift. The CPC for an interpretation task with adequate available time is 0.5.
- CPC “Adequacy of Training/Preparation”: Training is adequate with high experience. The CPC for an observation task with adequate training and high experience is 0.8.

Applying these factors yields the following:

$$\text{Operator fails to notice lift is taking too long} = 0.2 \times 0.8 \times 0.5 \times 0.8 = 0.07$$

Operator Fails to Close Port Slide—The operator is supposed to close the port slide gate as soon as the lift is completed as a part of the lift and transfer process. This gives the operator an opportunity to determine that the canister is not fully withdrawn. The operator would fail to notice this if either the operator skipped this step or if the operator performed the action and failed to notice that the gate had not closed all the way (e.g., because it is blocked from doing so by the canister). In the latter case, the slide gate open/close indicator lights would be in an incorrect state (either both on or both off, depending on design).

This is an EOO that can most closely be represented by CREAM CFF E5, adjusted by the following CPCs with values not equal to 1.0:

- CFF E5: Action missed, not performed (omission), including the omission of the last actions in a series. The baseline HEP is 0.03.
- CPC “Available Time”: There is adequate time available. The CPC for an execution task with adequate time is 0.5.
- CPC “Adequacy of Training/Preparation”: Training is adequate with high experience. The CPC for an execution task with adequate training and high experience is 0.8.

Applying these factors yields the following:

$$\text{Operator fails to close port slide gate} = 0.03 \times 0.5 \times 0.8 = 0.01$$

Operator Fails to Notice that Port Slide Gate Does Not Fully Close—The action of closing the port slide gate is simple. In this scenario, the gate does not close all the way because the canister is in the way. The operator has visible feedback on the failure of the gate to close because the “open” (or “green”) light on the control panel stays on and the “closed” (or “red”) light also comes on and stays on. Both lights on at the same sign signify that the port is neither fully open nor fully closed. The problem can be easily confirmed by looking at the camera or checking the status of the light curtain at the bottom of the bell. This unsafe action can be represented by NARA GTT C1, adjusted for the following EPCs:

- GTT C1: Simple response to a range of alarms/indications providing clear indication of situation (simple diagnosis required). The baseline HEP is 0.0004.

- EPC 3: Time pressure. The full affect EPC would be $\times 11$, but this applies only in cases where there is barely enough time to complete a task, and rapid work is necessary. In this case, the time pressure is more abstract, in that there is a desire to keep the process moving for production reasons, but not a compelling one. The APOA anchor for 0.1 is that the operator feels some time pressure, but there is sufficient time to carry out the task properly with checking. This appears reasonable for this task, so the APOA is set at 0.1.
- EPC 13: Operator underload/boredom. The full affect EPC would be $\times 3$, which applies to a routine task of low importance, carried out by a single individual for several hours. The APOA anchor for 0.1 is for low difficulty, low importance, single individual, for less than one hour. This appears reasonable for this task, so the APOA is set at 0.1.

Using the NARA HEP equation yields the following:

$$\begin{aligned} \text{Operator fails to notice that port slide gate does not fully close} = \\ 0.0004 \times [(11-1) \times 0.1 + 1] \times [(3-1) \times 0.1 + 1] = 0.001 \end{aligned} \quad (\text{Eq. E-27})$$

Operator Fails to Close CTM Slide Gate—The operator is supposed to close the CTM slide gate as soon as the port slide gate is closed. This gives the operator another opportunity to determine that the canister is not fully withdrawn. This failure would go unnoticed if the operator either skipped this step or performed the action and failed to notice that the gate had not closed all the way (e.g., because it is blocked from doing so by the hoist cables or load cell). In the latter case, the slide gate open/close indicator lights would be an incorrect state (either both on or both off, depending on design).

The baseline HEP for failure to close this gate would be the same as for the similar unsafe action for the port slide gate.

$$\text{Operator fails to close CTM slide gate (independent)} = 0.01$$

However, this would only apply in the case where the earlier unsafe action was failure to notice that the port slide gate had failed to close. In the case where the earlier unsafe action was failure to close the port slide gate, there is a dependence on the failure to perform a similar task next in the sequence. It is judged that the dependence between these two actions is high. Using item (4)(a) from THERP (Ref. E8.1.26) Table 20-21, the HEP follows:

$$\text{Operator fails to close CTM slide gate (given failure to close the port slide gate)} = 0.5$$

Operator Fails to Notice CTM Slide Gate Does Not Fully Close—The baseline HEP for failure to notice this gate did not fully close would be the same as for the similar unsafe action for the port slide gate.

$$\text{Operator fails to notice CTM slide gate does not fully close (independent)} = 0.001$$

However, this would only apply in the case where the earlier unsafe action was failure to close the port slide gate. In the case where the earlier unsafe action was failure to notice that the port slide gate did not fully close, there is a dependence on the failure to perform a similar task next

in the sequence. It is judged that the dependence between these two actions is high. Using item (4)(a) from THERP (Ref. E8.1.26) Table 20-21, the HEP follows:

Operator fails to notice CTM slide gate does not fully close
(given failure notice that port slide gate did not fully close) = 0.5

CTM Slide Gate Interlock Fails—The CTM slide gate interlock prevents CTM movement with the slide gate open (i.e., the shield skirt cannot be raised). If the interlock itself fails, the operator can move the CTM with the canister between levels.

This is a mechanical failure of the interlock. This event is quantified in Section E6.5.3.4.1.

CTM slide gate interlock fails = 2.7E-5

HEP Calculation for Scenario 3(b)—The events in the HEP model for Scenario 3(b) are presented in Table E6.5-13.

Table E6.5-13. HEP Model for HFE Group #5 Scenario 3(b) for 060-OpCTMImpact1-HFI-COD

Designator	Description	Probability
A	Operator inadvertently places CTM in lid lift mode	0.005
B	Operator fails to notice that lift stops too soon	0.07
C	Operator fails to close port slide gate	0.01
D	Operator fails to notice that port slide gate does not fully close	0.001
E1	Operator fails to close CTM slide gate (independent)	0.01
E2	Operator fails to close CTM slide gate (given failure to close the port slide gate)	0.5
F1	Operator fails to notice CTM slide gate does not fully close (independent)	0.001
F2	Operator fails to notice CTM slide gate does not fully close (given failure to notice that port slide gate did not fully close)	0.5
G	CTM slide gate interlock fails	2.7E-05

NOTE: CTM = canister transfer machine; HEP = human error probability.

Source: Original

The Boolean expression for this scenario follows:

$$A \times B \times \{[C \times (E2 + F1)] + [D \times (E1 + F2)]\} \times G = 0.005 \times 0.07 \times \{[0.01 \times (0.5 + 0.001)] + [0.001 \times (0.01 + 0.5)]\} \times 2.7E-05 = 0.005 \times 0.07 \times 0.006 \times 2.7E-05 = (<1E-8) \quad (\text{Eq. E-28})$$

E6.5.3.4.4.3 HFE Group #5 Scenario 3(c) for 060-OpCTMImpact1-HFI-COD

1. Operator puts CTM in maintenance mode (non-DPCs).
2. Operator terminates lift prior to automatic stop.
3. Operator fails to close port slide gate OR fails to notice that it does not fully close.
4. Operator fails to close CTM slide gate OR fails to notice it does not fully close.
5. CTM slide gate interlock fails.

Operator Puts CTM in Maintenance Mode (Non-DPCs)—The operator is supposed to set the ASD to canister lift mode prior to lifting the canister. It should be in lid lift mode because the lid was lifted right before the canister. Placing it in the maintenance mode instead of the canister lift mode removes the ASD height control set point and also defeats the CTM slide gate interlock (since maintenance mode would allow CTM movement with the slide gate open). In order to place it into maintenance mode, the operator is required to enter a password.

In this case, the operator commits the unsafe action of placing the CTM in maintenance mode. This is not easy to do; if the operator inadvertently selects this mode, the operator is asked to confirm the selection and is also required to enter a password, which is not required for the selection of canister mode. This can be represented by NARA GTT A5, adjusted for the following EPCs:

- GTT A5: Completely familiar, well-designed, highly practiced routine task performed to highest possible standards by highly motivated, highly trained, and experienced personnel, totally aware of implications of failure, with time to correct potential errors. The baseline HEP is 0.0001.
- EPC 6: A means of suppressing or overriding information or features that are too easily accessible. In this case, while a warning is given and a password is required, the operator still can still override the feature and enter manual mode. The full affect is $\times 9$. The APOA anchor for 0.5 is for something overridden on a regular basis. The APOA anchor for 0.1 is for something overridden once in a while. Other considerations for a reduction from full affect are a good interface design and good safety culture. Since maintenance mode is required on a regular basis, but there are other mitigating factors, it appears reasonable for this task that the APOA be set at 0.3.

Using the NARA HEP equation yields the following:

$$\begin{aligned} \text{Operator puts CTM in maintenance mode} = \\ 0.0001 \times [(9-1) \times 0.3 + 1] = 0.0004 \end{aligned} \quad (\text{Eq. E-29})$$

Operator Terminates Lift Prior to Automatic Stop—The operator is supposed to hold the lift button until the lift automatically stops. This happens even in the maintenance mode since the interlocks that prevent two-blocking are still active, and the CTM transfer sequence can still be completed successfully. However, if the operator terminates the lift prematurely, the canister could still be between floors.

The unsafe action results from stopping the hoist prematurely and leaving the canister below or between the floors (i.e., a number of feet short of the proper location). This can be represented by CREAM CFF E1, adjusted by the following CPCs with values not equal to 1.0:

- CFF E1: Execution of wrong type performed (with regard to force, distance, speed, or direction). The baseline HEP is 0.003.

There are no CPCs that are deemed to have values not equal to 1.0 for this action.

Applying these factors yields the following:

Operator terminates lift prior to automatic stop = 0.003

Operator Fails to Close Port Slide Gate—The operator is supposed to close the port slide gate as soon as the lift is completed. This gives the operator an opportunity to determine that the canister is not fully withdrawn. The operator would fail to notice this if either the operator skipped this step or if the operator performed the action and failed to notice that the gate had not closed all the way (e.g., because it is blocked from doing so by the canister). In the latter case, the slide gate open/close indicator lights would be in an incorrect state (either both on or both off, depending on design).

This value is the same as for Scenario 3(a):

Operator fails to close port slide gate = 0.01

Operator Fails to Notice that Port Slide Gate Does Not Fully Close—This value is the same as for Scenario 3(a):

Operator fails to notice that port slide gate does not fully close = 0.001

Operator Fails to Close CTM Slide Gate—The operator is supposed to close the CTM slide gate as soon as the port slide gate is closed. This gives the operator another opportunity to determine that the canister is not fully withdrawn. The operator would fail to notice this if either the operator skipped this step or if the operator performed the action and failed to notice that the gate had not closed all the way (e.g., because it is blocked from doing so by the hoist cables or load cell). In the latter case, the slide gate open/close indicator lights would be an incorrect state (either both on or both off, depending on design).

This value is the same as for Scenario 3(a):

Operator fails to close CTM slide gate (independent) = 0.01

Operator fails to close CTM slide gate (given failure to
close the port slide gate) = 0.5

Operator Fails to Notice CTM Slide Gate Does Not Fully Close—This value is the same as for Scenario 3(a):

Operator fails to notice CTM slide gate does not fully close (independent) = 0.001

Operator fails to notice CTM slide gate does not fully close
(given failure notice that port slide gate did not fully close) = 0.5

CTM Slide Gate Interlock Fails

The CTM slide gate interlock prevents CTM movement with the slide gate open (the shield skirt cannot be raised). If the interlock itself fails, the operator can move the CTM with the canister between levels. Note: the maintenance mode does not bypass the shield skirt/slide gate interlock; this interlock cannot be bypassed.

This is a mechanical failure of the interlock. This event is quantified in Section 6.5.3.4.1.

$$\text{CTM slide gate interlock fails} = 2.7\text{E}-5$$

HEP Calculation for Scenario 3(c)—The events in the HEP model for Scenario 3(c) are presented in Table E6.5-14.

Table E6.5-14. HEP Model for HFE Group #5 Scenario 3(c) for 060-OpCTMImpact1-HFI-COD

Designator	Description	Probability
A	Operator puts CTM in maintenance mode	0.0004
B	Operator terminates lift prior to automatic stop	0.003
C	Operator fails to close port slide gate	0.01
D	Operator fails to notice that port slide gate does not fully close	0.001
E1	Operator fails to close CTM slide gate (independent)	0.01
E2	Operator fails to close CTM slide gate (given failure to close the port slide gate)	0.5
F1	Operator fails to notice CTM slide gate does not fully close (independent)	0.001
F2	Operator fails to notice CTM slide gate does not fully close (given failure notice that port slide gate did not fully close)	0.5
G	CTM slide gate interlock fails	2.7E-05

NOTE: CTM = canister transfer machine; HEP = human error probability.

Source: Original

The Boolean expression for this scenario follows:

$$\begin{aligned}
 &A \times B \times \{[C \times (E2 + F1)] + [D \times (E1 + F2)]\} \times G = 0.0004 \times 0.003 \\
 &\times \{[0.01 \times (0.5 + 0.001)] + [0.001 \times (0.01 + 0.5)]\} \times 2.7\text{E}-05 = 0.0004 \\
 &\times 0.003 \times .006 \times 2.7\text{E}-05 = 7\text{E}-09 \times 2.7\text{E}-05 = (<1\text{E}-08) \quad (\text{Eq. E-30})
 \end{aligned}$$

Truncating the human failure component, the HEP for this scenario becomes:

$$1\text{E}-5 \times 2.7\text{E}-5 = (<1\text{E}-08) \quad (\text{Eq. E-31})$$

E6.5.3.4.4 HFE Group #5 Scenario 3(d) for 060-OpCTMImpact1-HFI-COD

1. Operator leaves CTM in maintenance mode (DPCs).
2. Operator terminates lift prior to automatic stop.
3. Operator fails to close port slide gate OR fails to notice that it does not fully close.
4. Operator fails to close CTM slide gate OR fails to notice it does not fully close.
5. CTM slide gate interlock fails.

Operator Leaves CTM in Maintenance Mode (DPCs)—The operator is supposed to set the ASD to canister lift mode prior to lifting the canister. For DPC operations, the ASD is in maintenance (or manual) lift mode because this is the default positioning. Leaving it in the maintenance mode instead of the canister lift mode removes the ASD height control set point and also defeats the CTM slide gate interlock (since maintenance mode allows CTM movement with the slide gate open).

In this case, this leaves the ASD in maintenance mode, which is the default position for DPC operations. The initial action to set the mode is quite simple, so the only realistic way that the operator can leave the ASD in maintenance mode is to completely fail to take any actions to set the CTM system for a lift. This failure can be represented by NARA GTT B3, and adjusted by the following EPCs:

- GTT B3: Set system status as part of routine operations using strict administratively controlled procedures. The baseline HEP is 0.0007.

This operation is performed under optimal conditions. It is early in the operation, and the operator is active, so it is too early in the task for boredom to set in. The baseline HEP is used without adjustment.

Operator leaves CTM in maintenance mode = 0.0007

Operator Terminates Lift Prior to Automatic Stop—The operator is supposed to hold the lift button in until the lift automatically stops. This happens even in the maintenance mode since the interlocks that prevent two-blocking are still active, and the CTM transfer sequence can still be completed successfully. However, if the operator terminates the lift prematurely, the canister could still be between floors.

The unsafe action results from stopping the hoist prematurely and leaving the canister below or between the floors (i.e., a number of feet short of the proper location). This can be represented by CREAM CFF E1, adjusted by the following CPCs with values not equal to 1.0:

- CFF E1: Execution of wrong type performed (with regard to force, distance, speed, or direction). The baseline HEP is 0.003.

There are no CPCs that are deemed to have values not equal to 1.0 for this action.

Applying these factors yields the following:

Operator terminates lift prior to automatic stop = 0.003

Operator Fails to Close Port Slide Gate—The operator is supposed to close the port slide gate as soon as the lift is completed. This gives the operator the opportunity to determine that the canister is not fully withdrawn. This failure would go unnoticed if the operator either skipped this step or performed the action and failed to notice that the gate had not closed all the way (e.g., because it is blocked from doing so by the canister). In the latter case, the slide gate open/close indicator lights would be in an incorrect state (either both on or both off, depending on design).

This value is the same as for Scenario 3(a):

Operator fails to close port slide gate = 0.01

Operator Fails to Notice that Port Slide Gate Does Not Fully Close—This value is the same as for Scenario 3(a):

$$\text{Operator fails to notice that port slide gate does not fully close} = 0.001$$

Operator Fails to Close CTM Slide Gate—The operator is supposed to close the CTM slide gate as soon as the port slide gate is closed. This gives the operator another opportunity to determine that the canister is not fully withdrawn. This would go unnoticed if the operator either skipped this step or performed the action and failed to notice that the gate had not closed all the way (e.g., because it is blocked from doing so by the hoist cables or load cell). In the latter case, the slide gate open/close indicator lights would be an incorrect state (either both on or both off, depending on design).

This value is the same as for Scenario 3(a):

$$\text{Operator fails to close CTM slide gate (independent)} = 0.01$$

$$\text{Operator fails to close CTM slide gate (given failure to close the port slide gate)} = 0.5$$

Operator Fails to Notice CTM Slide Gate Does Not Fully Close—This value is the same as for Scenario 3(a):

$$\text{Operator fails to notice CTM slide gate does not fully close (independent)} = 0.001$$

$$\begin{aligned} &\text{Operator fails to notice CTM slide gate does not fully close} \\ &\text{(given failure notice that port slide gate did not fully close)} = 0.5 \end{aligned}$$

CTM Slide Gate Interlock Fails

The CTM slide gate interlock prevents CTM movement with the slide gate open (the shield skirt cannot be raised). If the interlock itself fails, the operator can move the CTM with the canister between levels. Note: the maintenance mode does not bypass the shield skirt/slide gate interlock; this interlock cannot be bypassed.

This is a mechanical failure of the interlock. This event is quantified in Section 6.5.3.4.1.

$$\text{CTM slide gate interlock fails} = 2.7\text{E-}5$$

HEP Calculation for Scenario 3(d)—The events in the HEP model for Scenario 3(d) are presented in Table E6.5-15.

Table E6.5-15. HEP Model for HFE Group #5 Scenario 3(d) for 060-OpCTMImpact1-HFI-COD

Designator	Description	Probability
A	Operator leaves CTM in maintenance mode	0.0007
B	Operator terminates lift prior to automatic stop	0.003
C	Operator fails to close port slide gate	0.01
D	Operator fails to notice that port slide gate does not fully close	0.001
E1	Operator fails to close CTM slide gate (independent)	0.01

Table E6.5-15. HEP Model for Scenario 3(d) (Continued)

Designator	Description	Probability
E2	Operator fails to close CTM slide gate (given failure to close the port slide gate)	0.5
F1	Operator fails to notice CTM slide gate does not fully close (independent)	0.001
F2	Operator fails to notice CTM slide gate does not fully close (given failure to notice that port slide gate did not fully close)	0.5
G	CTM slide gate interlock fails	2.7E-05

NOTE: CTM = canister transfer machine; HEP = human error probability.

Source: Original

The Boolean expression for this scenario follows:

$$\begin{aligned}
 & A \times B \times \{ [C \times (E2 + F1)] + [D \times (E1 + F2)] \} \times G = \\
 & 0.0007 \times 0.003 \times \{ [0.01 \times (0.5 + 0.001)] + [0.001 \times (0.01 + 0.5)] \} \times 2.7E-05 = \\
 & 0.0004 \times 0.003 \times 0.006 \times 2.7E-05 = 7E-09 \times 2.7E-05 = (<1E-08) \quad (\text{Eq. E-32})
 \end{aligned}$$

Truncating the human failure component, the HEP for this scenario becomes:

$$1E-5 \times 2.7E-5 = (<1E-08) \quad (\text{Eq. E-33})$$

E6.5.3.4.4.5 HEP for HFE 060-OpCTMImpact1-HFI-COD

The Boolean expression for the overall HFE (all scenarios) follows:

$$\begin{aligned}
 & 060\text{-OpCTMImpact1-HFI-COD} = \text{HFE 3(a)} + \text{HFE 3(b)} + \text{HFE 3(c)} + \\
 & \text{HFE 3(d)} = (<1E-8) + (<1E-8) + (<1E-8) + (<1E-08) = 4E-8 \quad (\text{Eq. E-34})
 \end{aligned}$$

NOTE: For lifting objects (transportation cask, aging overpack, and waste package lids), the only failure mode that is applicable is 3(d); therefore, 4E-8 conservatively models movement with the lid below the floor.

E6.5.3.4.5 Quantification of HFE Scenarios for 060-OPCTMDirExp1-HFI-NOD: Operator Causes Direct Exposure during CTM Activities (Second Floor)

E6.5.3.4.5.1 HFE Group #5 Scenario 4(a) for 060-OPCTMDirExp1-HFI-NOD

1. Worker violates administrative control by entering the Canister Transfer Room during canister transfer.
2. Operator fails to close port gate before raising shield skirt.

Worker Violates Administrative Control by Entering the Canister Transfer Room during Canister Transfer—If a worker enters the Canister Transfer Room during canister transfer operations, there is a potential for direct exposure. There are several administrative controls restricting personnel from entering the Canister Transfer Room during canister transfer. These controls include the following:

- Personnel are only allowed in the Canister Transfer Room during prescheduled times.
- All personnel must check in with the control room (where the CTM is controlled) before entering the Canister Transfer Room.

If these controls are violated and a person enters the Canister Transfer Room when transfer operations are occurring, that person increases the potential to be exposed.

Any worker that wishes to enter the Canister Transfer Room needs to get permission to do so from a supervisor. If a worker violates this requirement, there is nothing that stops the worker from entering the room. However, this administrative control is fundamental to the operation of the facility and applies to entry to all important (i.e., radiation-controlled) areas of the facility. This is best represented by NARA GTT A5, adjusted by the following EPCs:

- GTT A5: Completely familiar, well-designed, highly practiced routine task performed to highest possible standards by highly motivated, highly trained, and experienced personnel, totally aware of implications of failure, with time to correct potential errors. The baseline HEP is 0.0001.
- EPC 7: No obvious means of reversing an unintended action. The GTT HEP is based on there being time to correct potential errors. This does not exist for this task. The maximum effect of the EPC is 9, which applies when there is no means of recovering from an unintended action once executed. Given that the error is not correctable, the APOA is set at 1.0.

This assessment does not give credit for the worker believing that there is a need to enter the Canister Transfer Room in the first place.

Applying the NARA HEP equation yields the following:

$$\begin{aligned} &\text{Worker violates administrative control by entering the Canister Transfer Room} \\ &\text{during canister transfer} = 0.0001 \times [(9-1) \times 1.0 + 1] = 0.0009 \quad (\text{Eq. E-35}) \end{aligned}$$

Operator Fails to Close Port Gate before Lifting Shield Skirt—Just entering the Canister Transfer Room during canister transfer cannot result in an exposure since the entire operation is shielded. Therefore, to result in an exposure, the shielding must be compromised. After the canister is placed in a receptacle (e.g., waste package, aging overpack, staging rack), the CTM operator is supposed to close the port gate and then raise the shield skirt and move the CTM. If the operator fails to close the port gate before the shield skirt is raised and before the CTM is moved, then the crew members on the floor of the Canister Transfer Room would get a direct exposure. This is a skill-based action that is performed as part of every CTM movement over a port gate. This action is completely independent of the worker entering the room.

This is a task execution error with no feedback and its consequences are immediate (i.e., no potential for recovery). This most closely corresponds to the task execution error CREAM CFF E5, adjusted for the following CPCs with values not equal to 1.0.

- CFF E5: Missed action. The baseline HEP is 0.03.
- CPC “Working Conditions”: The working conditions for the operator are in a control room with a favorable environment. The CPC for advantageous working conditions for an execution task is 0.8.
- CPC “Availability of Procedures”: With regard to the notification step, the procedures and checklist clearly list that this task needs to be performed. The CPC for appropriate availability of procedures for an execution task is 0.8.
- CPC “Available Time”: There is more than enough time to successfully perform this task. The CPC for adequate available time for an execution task is 0.5.
- CPC “Adequacy of Training/Preparation”: This is a routine task that is clearly trained and emphasized in training. Because it is routine, there is a high level of experience. The CPC for adequate training and high experience for an execution task is 0.8.

Applying these factors yields the following:

$$\begin{aligned} &\text{Operator fails to close port gate before lifting} \\ &\text{shield skirt} = 0.03 \times 0.8 \times 0.8 \times 0.5 \times 0.8 = 0.008 \end{aligned}$$

HEP Calculation for Scenario 4(a)—The events in the HEP model for Scenario 4(a) are presented in Table E6.5-16.

Table E6.5-16. HEP Model for HFE Group #5 Scenario 4(a) for 060-OPCTMDirExp1-HFI-NOD

Designator	Description	Probability
A	Worker violates administrative control by entering the Canister Transfer Room during canister transfer	0.0009
B	Operator fails to close port gate before lifting shield skirt	0.008

NOTE: HEP = human error probability.

Source: Original

The Boolean expression for this scenario follows:

$$A \times B = 0.0009 \times 0.008 = 8E-06 \quad (\text{Eq. E-36})$$

E6.5.3.4.5.2 HEP for HFE 060-OpCTMDirExp1-HFI-NOD

The Boolean expression for the overall HFE (all scenarios) follows:

$$060\text{-OpCTMDirExp1-HFI-NOD} = \text{HEP 4(a)} = 8E-6 \quad (\text{Eq. E-37})$$

E6.5.3.4.6 Quantification of HFE Scenarios for 060-OPStageRack1-HFI-NOD: Operator Causes Direct Exposure during Canister Staging

E6.5.3.4.6.1 HFE Group #5 Scenario 5(a) for 060-OPStageRack1-HFI-NOD

1. Operator fails to close staging rack port gate before raising shield skirt.
2. Supervisor fails to check that the port gate is closed at the end of canister transfer operations.

Operator Fails to Close Staging Rack Port Gate—If the CTM operator fails to close the staging rack port gate in the staging area after placing a canister in the staging rack, then during the course of normal operations, a worker entering the Canister Transfer Room after the canister transfer operations have ended would be exposed. After the canister is placed in the staging rack, the CTM operator is supposed to close the port gate, raised the shield skirt, and moved the CTM. The operator can fail to close the port gate and not notice that the port gate has remained open. This is a skill-based action that is performed as part of every CTM movement over a port gate. There is more than enough time to successfully perform this task.

This is a task execution error with no feedback, and its consequences are immediate (i.e., no potential for recovery). This most closely corresponds to the task execution error CREAM CFF E5, adjusted for the following CPCs with values not equal to 1.0:

- CFF E5: Missed action. The baseline HEP is 0.03.
- CPC “Working Conditions”: The working conditions for the operator are in a control room with a favorable environment. The CPC for advantageous working conditions for an execution task is 0.8.
- CPC “Availability of Procedures”: With regard to the notification step, the procedures and checklist clearly list that this task needs to be performed. The CPC for appropriate availability of procedures for an execution task is 0.8.
- CPC “Available Time”: There is more than enough time to successfully perform this task. The CPC for adequate available time for an execution task is 0.5.
- CPC “Adequacy of Training/Preparation”: This is a routine task that is clearly trained and emphasized in training. Because it is routine, there is a high level of experience. The CPC for adequate training and high experience for an execution task is 0.8.

Applying these factors yields the following:

$$\begin{aligned} \text{Operator fails to close staging rack port gate after canister transfer} = \\ 0.03 \times 0.8 \times 0.8 \times 0.5 \times 0.8 = 0.008 \end{aligned}$$

Supervisor Fails to Check Port Gates—Once the canisters are in their proper receptacle (i.e., waste package, aging overpack, or staging rack) and the loaded WPTT/site transporter has moved to the Waste Package Positioning Room/Cask Preparation Area, the supervisor must

complete an end-of-operations checklist. Before the canister transfer activities can be considered complete, the supervisor must verify per the checklist that all the port gates, particularly the staging rack port gates, are closed. The supervisor is likely only to check the port gates that were involved in the transfer(s) involved in that shift (e.g., if canisters were only moved to a staging rack, then the supervisor would only be inclined to check that staging rack). The check is done remotely via camera; however, the port gates are clearly visible. It is expected that, if the supervisor performs the check, the supervisor would notice that the port gate was open because the supervisor would be looking specifically for that. The failure of concern, then, is the omission of this check. Because this is a procedural control and is emphasized in training, this is not classified as a simple EOO. The most appropriate failure mode was considered to be a NARA GTT B3, failure to “set system status as part of routine operations using strict administratively controlled procedures.” The example given for this GTT was “a main control room operator does not adhere to administrative controls (including daily checks) and fails to maintain specified reserve feed water stocks.” While the supervisor is not actually setting a system as part of this check, this failure mode was considered most applicable because the context of the error and type of error was the most similar to the unsafe action being quantified. The baseline HEP for this failure is 0.0007, adjusted for the following EPCs:

- EPC 14: A conflict between immediate and long-term objectives. There is more than enough time to successfully perform this task; however, the most likely context for this particular error is if the supervisor feels rushed (e.g., it is the end of the shift and the supervisor is impatient to get home). The full affect of this EPC is $\times 2.5$. The full affect of this EPC was considered applicable, and was assigned an APOA of 1.
- EPC 18: Low workforce morale or adverse organizational environment. This EPC was considered relevant because there maybe some complacency on the part of the supervisor, who trusts the CTM operator and may be less likely to take the check seriously. The full affect of this EPC is $\times 2$. The example given for the full affect is “members of the workforce perceive no value in the tasks they undertake or the values of the organization...” The full affect can be reduced if “personnel have some sense of their value in the context of organization and in the tasks they are undertaking.” While complacency may be a factor, the supervisor understands the consequences associated with a failure to close the port gates in the staging rack, and so the APOA was assessed to be 0.5.

Applying these factors yields the following:

$$\begin{aligned} &\text{Supervisor fails to check port gates} = \\ &0.0007 \times [(2.5-1) \times 1 + 1] \times [(2-1) \times 0.5 + 1] = 0.003 \qquad \text{(Eq. E-38)} \end{aligned}$$

HEP Calculation for Scenario 5(a)—The events in the HEP model for Scenario 5(a) are presented in Table E6.5-17.

Table E6.5-17. HEP Model for HFE Group #5 Scenario 5(a) for 060-OPStageRack1-HFI-NOD

Designator	Description	Probability
A	Operator fails to close staging rack port gate after canister transfer	0.008
B	Supervisor fails to check port gates	0.003

NOTE: HEP = human error probability.

Source: Original

The Boolean expression for this scenario follows:

$$A \times B = 0.008 \times 0.003 = 3E-05 \quad (\text{Eq. E-39})$$

E6.5.3.4.6.2 HEP for HFE 060-OPStageRack1-HFI-NOD

The Boolean expression for the overall HFE (all scenarios) follows:

$$060\text{-OpCTMDirExp1-HFI-NOD} = \text{HEP 5(a)} = 3E-5 \quad (\text{Eq. E-40})$$

E6.5.4 Results of Detailed HRA for HFE Group #5

The final HEPs for the HFEs that required detailed analysis in HFE Group #5 are presented in Table E6.5-18 (with the original preliminary value shown in parentheses).

Table E6.5-18. Summary of HFE Detailed Analysis for HFE Group #5

HFE	Description	Final Probability
060-OpCTMdrop001-HFI-COD	Operator causes drop of object onto canister during CTM operations	4E-7 (2E-03)
060-OpCTMdrop002-HFI-COD	Operator causes drop of canister during CTM operations (low level drop)	5E-7 (2E-03)
	Applied to removing a DPC from a TC	5E-7 (2E-03)
	Applied to removing any other canister from a TC or any canister from an AO	5E-7 (2E-03)
060-OpCTMImpact1-HFI-COD	Operator moves the CTM while canister or object is below or between levels	4E-8 (1E-03)
060-OpCTMDirExp1-HFI-NOD	Direct exposure during CTM activities (Second Floor)	8E-6 (1E-4)
060-OPStageRack1-HFI-NOD	Direct exposure during canister staging	3E-5 (1E-3)

NOTE: AO = aging overpack; CTM = canister transfer machine; DPC = dual-purpose canister; HFE = human failure event; TC = transportation cask.

Source: Original

E6.6 ANALYSIS OF HUMAN FAILURE EVENT GROUP #6: WASTE PACKAGE ASSEMBLY AND CLOSURE

HFE group #6 corresponds to the operations and initiating events associated with the ESD and HAZOP evaluation nodes listed in Table E6.0-1, covering waste package assembly and closure. The operations covered in this HFE group are shown in Figure E6.6-1. Closure activities begin with the canister in the waste package, aligned with the waste package port with the port closed. The WPTT moves the loaded waste package from underneath the Canister Transfer Room into position underneath the Waste Package Closure Room where the waste package is closed in preparation for export to the drifts. Closure activities include installing an inner lid (TAD canister only), spread ring, and outer lid, inerting the package, and sealing (welding and polishing) the package. This operation ends with the waste package ready for emplacement, but still in a vertical position in the Waste Package Closure Room.

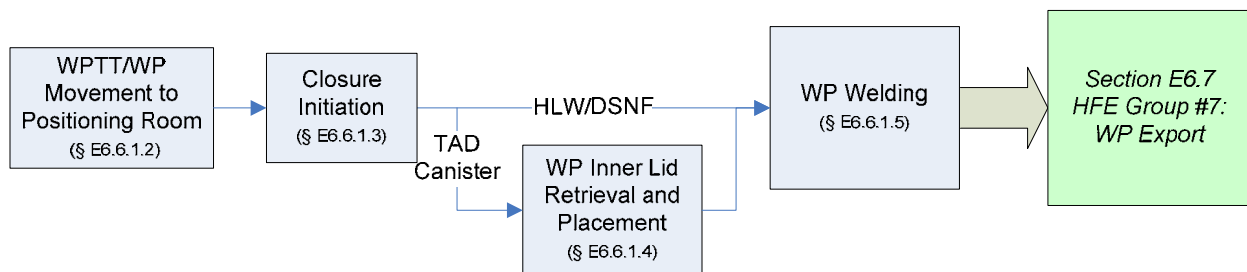

NOTE: § = Section; DSNF = Department of Energy spent nuclear fuel; HFE = human failure event; HLW = high-level radioactive waste; TAD = transportation, aging, and disposal; WP = waste package; WPTT = waste package transfer trolley.

Source: Original

Figure E6.6-1. Activities Associated with HFE Group #6

E6.6.1 Group #6 Base Case Scenario

E6.6.1.1 Initial Conditions and Design Considerations Affecting the Analysis

The following conditions and design considerations were considered in evaluating HFE group #6 activities:

1. The waste package is secured to the WPTT and is positioned in the Waste Package Positioning Room under the Waste Package Closure Room.
2. The waste package has both the inner lid and spread ring already in place.
3. The waste package port slide gate is closed. There is an interlock between the port slide gates and the Waste Package Positioning Room shield doors. The port slide gate cannot be open while the shield doors to the Waste Package Positioning Room are also open.
4. All operations involving waste package assembly and closure are performed remotely. Operators have an adequate view of all operations via camera.

The following personnel are involved in this set of operations:

- RHS operator
- Arm operators (two)
- WPTT operator
- Quality control
- Level 2 and 3 NDE personnel
- Supervisor.

Section E5.1.2 provides a more detailed description of the duties performed by each of these personnel.

E6.6.1.2 WPTT Movement with Loaded Waste Package under the Waste Package Closure Room

The operator remotely controls the WPTT with a loaded waste package and moves it underneath the Waste Package Closure Room. The WPTT rides on rails, travels at one speed, and has preprogrammed paths to follow. The operator can only start the WPTT movement or make it stop. There is no shield door to traverse in this transfer across the Waste Package Positioning Room.

E6.6.1.3 Closure Process Initiation (Loaded Waste Package with TAD Canister /HLW/SNF)

The operator uses the camera and the bumpy bar code reader to read the bar code on the waste package to ensure it is the correct waste package. At this time, the operator puts the waste package serial number into the tracking chart. This step is verified by quality control.

E6.6.1.4 Waste Package Inner Lid Retrieval and Placement on Waste Package (Waste Package with TAD Canister Only)

The waste package inner lid (which includes the spread ring) is placed on the waste package in the Waste Package Closure Room for waste packages containing shielded waste forms (i.e., TAD canisters). The RHS operator moves the remote handling crane to the waste package inner lid staging area, lifts the inner lid, moves it to the waste package, lowers the inner lid onto the waste package and disengages the grapple.

E6.6.1.5 Waste Package Welding

E6.6.1.5.1 Spread Ring Expansion for Seal Weld

Once the spread ring position is verified, the operator uses the RHS and camera to engage the spread ring expander tool. The RHS operator uses the expander tool to expand the spread ring.

E6.6.1.5.2 Spread Ring Welding to Inner Vessel and Inner Lid; NDE of Weld

The welding team is comprised of two arm operators, an RHS operator, a quality control person, and level 2 and 3 NDE personnel. Each arm operator is responsible for welding half the

circumference of the spread ring. The RHS operator is in charge of changing the end effectors as needed for the process. The processes include normal welding, grinding out the weld, and dressing the weld. The arm operators use the robotic arm to do the actual welding, and quality control supervises, visually inspects, and verifies the weld. For this weld, there is a constant stainless steel weld wire spool feed. Level 2 and 3 NDE personnel must sign off this step.

E6.6.1.5.3 Waste Package Inerting and Leak Test at Spread Ring and Purge Port Plug

All operations in this step are performed remotely. The RHS operator remotely retrieves the purge port tool and places it on top of the purge port. Once properly positioned, the RHS operator initiates the port tool and allows the helium to flow until sufficient time has passed and the pressure gage gives the proper reading. The RHS operator then sends the signals for the port tool to stop helium flow, closes the cap and performs leak detection, and then checks the indicators to ensure there are no leaks before continuing. Quality control verifies this step.

E6.6.1.5.4 Purge Port Cap Retrieval and Placement

The RHS operator retrieves the purge port cap from its staging area, scans it with the bumpy bar code reader, documents the serial number, and places it onto the purge port. This is verified by quality control.

E6.6.1.5.5 Purge Port Cap Welding and NDE of Weld

The RHS operator installs the end effector on the robotic arm. The weld material is the same stainless steel used to weld the spread ring. The arm operator welds the cap in place while quality control visually inspects the process. Once welded, the RHS operator switches out the end effector for a dressing end effector, and the arm operator dresses the weld while quality control visually inspects. Level 2 and 3 NDE personnel must sign off this step.

E6.6.1.5.6 Outer Lid Retrieval and Placement on the Waste Package from the Waste Package Closure Room

The RHS operator uses the camera and bumpy bar code reader to read the bar code on the waste package outer lid. At this time, the operator puts the waste package serial number into the tracking chart. This step is verified by quality control. Once the outer lid is documented, the operator retrieves the lid, engages the lid grapple, moves the lid to the proper position and then disengages the grapple.

E6.6.1.5.7 Outer Lid Welding to Outer Barrier and NDE of Weld

In preparation for this step, the RHS operator switches out the stainless steel weld feed spool for Alloy 22. This step is nearly identical to welding the inner lid (Section E6.6.1.5.2). The difference is that the end effector used has an ultrasonic testing/eddy current testing (UT/ET) attachment that follows and tests the weld. The weld and UT/ET testing is verified by level 2 and 3 NDE personnel.

E6.6.1.5.8 Stress Mitigation and NDE on Outer Lid

The RHS operator places the stress mitigation tool on the outer lid, and the operator and quality control visually inspect the polish using a camera. Once the stress mitigation tool is done, the RHS operator removes the tool and places a UT/ET end effector on the robotic arm. The arm operator commences testing. The sealed waste package is verified again by level 2 and 3 NDE personnel.

E6.6.2 HFE Descriptions and Preliminary Analysis

This section defines and screens the HFEs that are identified for the base case scenario that can affect the probability of initiating events occurring, and that could lead to undesired consequences. Descriptions and preliminary analysis for the HFEs of concern during waste package assembly and closure are summarized in Table E6.6-1. The analysis presented here includes the assignment of preliminary HEPs in accordance with the methodology described in Section E3.2 and Appendix E.III of this analysis. Section E4.2 provides details on the use of expert judgment in this preliminary analysis.

Table E6.6-1. HFE Group #6 Descriptions and Preliminary Analysis

HFE ID	HFE Brief Description	ESD	Preliminary Value	Justification
060-OpWPCollide1-HFI-NOD	<i>Operator Causes Low-Speed Collision of WPTT during Transfer to Closure Area:</i> As the WPTT is moved from the WP Loading Room to the WP Closure Room, the operator can cause the WPTT to collide into an SSC. The WPTT speed is physically limited by motor design, so all collisions of the WPTT are low-speed.	10	3E-03	The WPTT is on rails, but an operator can cause a collision of the WPTT with an object in its path or into an SSC. The WPTT speed is physically limited by motor design, so all collisions of the WPTT are low-speed collisions. This failure is nearly identical to collision of the railcar while entering the facility (060-OpRCCollide1-HFI-NOD; Section E6.1, HFE Group #1: Receipt of SNF in the Railcar Entrance Vestibule and movement into the Cask Preparation Room), and was assigned the same probability. This is a conservative preliminary value because the path the WPTT travels is expected to have fewer obstructions (doors, potential objects in the path) to collide into. The preliminary value was chosen based on the determination that this failure is "highly unlikely" (one in a thousand or 0.001) and was adjusted because there are several ways for a collision to occur (×3).
060-OpTiltDown01-HFI-NOD	<i>Operator Initiates Premature Tilt-Down during Transfer to Closure Area:</i> The operator can inadvertently initiate tilt-down of the WP during transfer to the WP Closure Room. If the WP is near a facility structure then this could result in a collision of the WP.	10	1.0	The operator can cause the WPTT to prematurely tilt down. The WPTT operator is in the process of driving the WPTT to the Waste Package Positioning Room. Tilt-down only occurs during waste package loadout in the Waste Package Loadout Room, and the controller for the WPTT tilt-down is distinct from other WPTT controls. In order to accomplish this failure, several interlocks must also fail. These interlocks, including an interlock taking power away from the WPTT when the port gate is open and interlock between the tilt-down mechanism and the docking station, have no bypass. To be conservative, unsafe actions that require an equipment failure to cause an initiating event are generally assigned an HEP of 1.0.
WPTT Derailment	<i>Operator Causes Derailment of WPTT:</i> The WPTT travels on rail from the WP Loading Room to the WP Positioning Room. During this transfer the operator can cause the WPTT to derail by running over a large object left on the rail or through other such mechanisms.	10	N/A ^a	In this step, the WPTT moves on rails from outside the Waste Package Loadout Room to the closing position in the Waste Package Positioning Room below the Waste Package Closure Room. During this travel, there is a probability that the WPTT can derail, leading to a tipover of the WPTT. This HFE was not explicitly quantified because the probability of derailment due to human failure is incorporated in the historical data used to provide a general failure probability for derailment. Documentation for this failure can be found in Attachment C.
060-OPWPInnerLid-HFI-NOD	<i>Operator Fails to Install WP Inner Lid (HLW/SNF Only):</i> If the CTM operators fail to install the WP inner lid (Section E6.5.1.4) and a person violates the procedural controls and enters the WP closure area when the WPTT is transferred into the room, that person gets a direct exposure. This failure only applies to waste packages with HLW/SNF; TAD canisters are shielded on top, and do not expose personnel to radiation if the waste package inner lid is not in place.	19	1E-04	The CTM operator fails to install the WP inner lid during CTM operations (Section E6.5, HFE Group #5); however, the actual direct exposure does not occur unless there is an additional unsafe action during closure operations performed in this section. If the CTM operator fails to install the waste package inner lid during CTM operations (Section E6.5.1.4) and a worker enters the Waste Package Closure Room against procedural controls during waste package assembly and closure operations, then that worker gets a direct exposure. The CTM operator would have to omit a major step in CTM operations to fail to install the waste package inner lid. Once the CTM operations are over, the waste package is moved into the Waste Package Positioning Room for waste package closure. If there is a worker in the Waste Package Closure Room, they are exposed. There are no interlocks to prevent this error, however, there is a procedural control associated with the radiation protection program that restricts access to the Waste Package Closure Room while a cask is in the Positioning Room. The closure operation begins with verification and documentation of the inner lid serial number. If the inner lid is missing, it is most likely to be noticed during this procedure. However, if this procedure is omitted, the waste package proceeds to welding. A team of at least four people weld the inner lid to the waste package and the weld is then verified and signed off by quality control after a UT/ET inspection of the weld. The UT/ET weld inspection is an integral part of the welding process and cannot be omitted. During this closure process, the missing inner lid can be detected. This HFE was considered extremely unlikely, requiring two independent human failures (including failing to abide by a serious procedural control) and was accordingly assigned a preliminary value of 0.0001.
Improper WP Closure	<i>Operator Damages Canister during Welding:</i> The WP inner and outer lids are welded closed as part of WP closure activities. This is a remote operation with a high level of automation; however, it may be possible that the welder can improperly weld the canister such that the canister becomes damaged. Note: Improper welding may also have postclosure implications. However, HFEs which have no safety consequences over the preclosure period, but may have consequences postclosure that are out of the scope of this analysis and are addressed in the postclosure safety assessment.	11	N/A	The analysts could not identify any human actions which would contribute to canister damage during welding. Latent conditions due to bad welds may have consequences postclosure, but these conditions are out of the scope of this analysis and are addressed in the postclosure safety assessment.

Table E6.6-1. HFE Group #6 Descriptions and Preliminary Analysis (Continued)

HFE ID	HFE Brief Description	ESD	Preliminary Value	Justification
Drop of Object	<i>Operator Drops Object on Canister with RHS:</i> The WP inner and outer lids are welded closed as part of WP closure activities. The RHS is used to move objects over the canister, including the outer lid, as part of this task. The operator could drop an object onto the canister during these lifts.	11	N/A ^a	In this activity the operator uses the RHS to move several objects over the waste package and canister. The outer lid is moved over the waste package and, for TAD canisters, the inner lid is also moved over the waste package. Other objects, such as spools of welding material, may also be moved over the waste package during this operation; however, the inner and outer lids are the only objects that are heavy enough to potentially damage the waste package or canister. These HFEs were not explicitly quantified because the probability of a crane drop due to human failure is incorporated in the historical data used to provide general failure probabilities for drops involving various crane and rigging types. Documentation for this failure can be found in Attachment C.
WPTT uncontrolled tilt-down	Operator causes uncontrolled tilt-down of WPTT	10	N/A	No human actions were identified that would contribute to an uncontrolled tilt-down.

NOTE: ^a HRA preliminary value replaced by use of historic data (Attachment C)

CTM = canister transfer machine; CRCF = Canister Receipt and Closure Facility; ESD = event sequence diagram; HFE = human failure event; N/A = not applicable; RHS = remote handling system; SSC = structure, system, or component; TAD = transportation, aging, and disposal; TEV = transport and emplacement vehicle; UT/ET = ultrasonic testing/eddy current testing; WP = waste package; WPTT = waste package transfer trolley.

Source: Original

E6.6.3 Detailed Analysis

After the preliminary screening analysis and initial quantification are completed, those HFEs that appear in dominant cut sets for event sequences that do not comply with the 10 CFR 63.111 performance objectives are subjected to a detailed analysis. The overall framework for the HRA is based upon the process guidance provided in ATHEANA (Ref. E8.1.22). Consistent with that framework, the following four steps from the methodology described in Section E3.2 provide the structure for the detailed analysis portion of the HRA:

Step 5: Identify Potential Vulnerabilities

Prior to defining specific scenarios that can lead to the HFEs of interest (Step 6), information is collected to define the context in which the failures are most likely to occur. In particular, analysts search for potential vulnerabilities in the operators' knowledge and information base for the initiating event or base case scenario(s) under study that might result in HFEs or unsafe actions. This information collection step discussed in Section E6.6.3.2.

Step 6: Search for HFE Scenarios (Scenarios of Concern)

An HFE scenario is a specific progression of actions with a specific context that leads to the failure of concern; each HFE is made up of one or more HFE scenarios. In this step, documented in Sections E6.6.3.3 and E6.6.3.4, the analyst identifies deviations from the base case scenario that are likely to result in risk-significant unsafe action(s). These unsafe actions make up an HFE scenario. In serious accidents, these HFE scenarios are usually combinations of various types of unexpected conditions.

Step 7: Quantify Probabilities of HFEs

Detailed HRA quantification methods are selected as appropriate for the characteristics of each HFE and are applied as explained in Section E6.6.3.4. Four quantification methods are utilized in this quantification:

- CREAM (Ref. E8.1.18)
- HEART (Ref. E8.1.28)/NARA (Ref. E8.1.11)
- THERP (Ref. E8.1.26)
- ATHEANA expert judgment (Ref. E8.1.22)

There is no implication of preference in the order of listing these methods. They are jointly referred to as the "preferred methods" and are applied either individually or in combination as best suited for the unsafe action quantified. The ATHEANA (Ref. E8.1.22) expert judgment method (as opposed to the overall ATHEANA (Ref. E8.1.22) methodology that forms the framework and steps for the performance of this HRA) is used when the other methods are deemed to be inappropriate to the unsafe action, as is often the case for cognitive EOCs.

Appendix E.IV of this analysis explains why these specific methods were selected for quantification and gives some background on when a given method is applicable based on the focus and characteristic of the method.

All judgments used in the quantification effort are determined by the HRA team and are based on their own experience, augmented by facility-specific information and the experience of subject matter experts, as discussed in Section E4. If consensus can be reached by the HRA team on an HEP for an unsafe action, that value is used as the mean. If consensus cannot be reached, the highest opinion is used as the mean.

Step 8: Incorporate HFEs into the PCSA

After HFEs are identified, defined, and quantified, they must be incorporated into the PCSA. The summary table of HFEs by group that lists the final HEP by basic event name provides the link between the HRA and the rest of the PCSA. This table can be found in Section E6.6.4.

E6.6.3.1 HFEs Requiring Detailed Analysis

The detailed analysis methodology, Sections E3.2.5 through E3.2.9, states that HFEs of concern are identified for detailed quantification through the preliminary analysis (Section E3.2.4). An initial quantification of the CRCF PCSA model determined that there is one HFE in this group whose preliminary value was too high to demonstrate compliance with the performance objectives stated in 10 CFR 63.111. This HFE is presented in Table E6.6-2.

Table E6.6-2. Group #6 HFE Requiring Detailed Analysis

HFE	Description	Preliminary value
060-OpWPInnerLid-HFI-NOD	Operator causes direct exposure due to failure to properly install WP inner shield lid	1E-04

Source: Original

E6.6.3.2 Assessment of Potential Vulnerabilities (Step 5)

For those HFEs requiring a detailed analysis, the first step in the approach to conducting a detailed quantification is to identify and characterize the factors that could create potential vulnerabilities in the crew’s ability to respond to the scenarios of interest and might result in the HFEs or unsafe actions. In this sense, the “vulnerabilities” are the context and factors that influence human performance and constitute the characteristics, conditions, rules and tendencies that pertain to all the scenarios analyzed in detail.

These vulnerabilities are identified through activities including but not limited to, the following:

1. The facility familiarization and information collection process discussed in Section E4.1, such as the review of design drawings and concept of operations documents.
2. Discussions with subject matter experts from a wide range of areas, as described in Section E4.2.
3. Insights gained during the performance of the other PCSA tasks (e.g., initiating events analysis, systems analysis, and event sequence analysis).

The vulnerabilities discussed in this section pertain only to those aspects of the closure operation that relate to potential human failure scenarios relevant to the HFE listed above. Other vulnerabilities exist that would be relevant to other potential HFEs that can occur during the closure operation, but these have no bearing on this analysis. In addition, the potential vulnerabilities presented below are those that relate to the actions relevant to the above HFE and that pertain to those parts of the HFE scenarios that occur during this phase of the CRCF process. Note that the occurrence of this HFE begins with unsafe actions during CTM operations (i.e., the placing of the inner lid into the waste package after loading the canister). Therefore, the vulnerabilities associated with that operation also apply. These vulnerabilities are discussed in Section E6.5.3.2.

E6.6.3.2.1 Operating Team Characteristics

WPTT Operator—Located in the Operations Room, the WPTT operator has received training for the WPTT and has observed operations prior to being allowed to operate the WPTT on a dry run. The WPTT operator has signed off to operate the WPTT based on an evaluation of proficiency during a dry run. The WPTT operator has been observed on initial operations before being signed off for solo operation. A single operator is assigned to the WPTT operation.

Supervisor—The supervisor is located in the Operations Room. The supervisor watches over operations, and verifies the hand over from the CTM operator to the WPTT operator. The supervisor also grants or denies permission for personnel to enter the Waste Package Closure Room.

E6.6.3.2.2 Operation and Design Characteristics

The door to the Waste Package Closure Room is unshielded and unlocked. Radiation control signs and flashing lights (non-ITS equipment) are provided outside the door during waste package closure.

A checklist that must be filled out before the waste package is transferred to the Waste Package Closure Room to ensure the correct canisters are in a waste package and, as appropriate, ensure that the inner lid is installed on the waste package.

Personnel may be located in the Waste Package Closure Room before the WPTT is moved to the Waste Package Positioning Room.

E6.6.3.2.3 Formal Rules and Procedures

Procedural Controls—Procedural controls ensure that the operators and maintenance personnel do not enter the Waste Package Closure Room except during scheduled times. A personnel accountability system is associated with entering and exiting the Waste Package Closure Room. Personnel are required to check in with the supervisor and tag in and tag out before entering or after leaving the Waste Package Closure Room.

E6.6.3.2.4 Operator Tendencies and Informal Rules

Consequences of Failure—The operations are performed remotely. No personnel are in the vicinity of the operation, and so the threat of physical injury is absent. The WPTT operator expects that failures are mitigated by design features without serious consequences, which promotes complacency in the operations.

E6.6.3.2.5 Operator Expectations

Anticipatory Actions—The operator expects that no one attempts to enter the Waste Package Closure Room without a compelling reason.

E6.6.3.3 HFE Scenarios and Expected Human Failures (Step 6)

Given that the vulnerabilities that provide the operational environment and features that could influence human performance have been specified, then the HFE scenarios within this environment are identified. An HFE scenario is a specific progression of actions during normal operations (with a specific context) that lead to the failure of concern; each HFE is made up of one or more HFE scenarios. In accordance with the methodology, each scenario integrates the unsafe actions with the relevant equipment failures so as to provide the complete context for the understanding and quantification of the HFE.

The HAZOP evaluation is instrumental in initially scoping out the HFE scenarios, but they are then refined through discussions with subject matter experts from a wide range of areas, as described in Section E4.2.

Table E6.6-3 summarizes all of the HFE scenarios developed for the HFE in this group.

Table E6.6-3. HFE Scenarios and Expected Human Failures for HFE Group #6

HFE	HFE Scenarios
060-OpWPInnerLid-HFI-NOD <i>Operator Fails to Install WP Inner Lid</i>	HFE Scenario 1(a): (1) Operator fails to install the WP inner shield lid, (2) Worker violates administrative control by entering the WP Closure Room prior to the start of welding activities.

NOTE: HFE = human failure event; WP = waste package.

Source: Original

The Boolean logic of this HFE scenario is expressed with an implicit AND connecting the subsequent unsafe actions and OR notation wherever two unsafe action paths are possible, as shown in Table E6.6-3.

The HFE scenarios summarized in Table E6.6-3 are discussed and quantified in detail below.

E6.6.3.4 Quantitative Analysis (Step 7)

Once the HFE scenarios and the unsafe actions within them are scoped out, it is then possible to review them in detail and apply the appropriate quantification methodology in each case that permits an HEP to be calculated for each HFE. Stated another way, each HFE is quantified

through the analysis and combination of the contributing HFE scenarios. Dependencies between the unsafe actions and equipment responses within each scenario, and across the scenarios, are carefully considered in the quantification process.

This section provides a description of the quantitative analysis performed, and is structured hierarchically by each HFE category (identified by a basic event name), the HFE scenario, and then the unsafe actions under each scenario, as previously documented in Table E6.6-3.

Prior to the scenario-specific quantification descriptions, a listing is provided of the values used in the quantification that are common across many of the HFE scenarios.

In generating the final HEP values, the use of more than a single significant figure is not justified given the extensive use of judgment required for the quantification of the individual unsafe actions within a given HFE. For this reason, all calculated final HEP values are reduced to one significant figure. When doing this, the value is always rounded upwards to the next highest single significant figure.

E6.6.3.4.1 Common Values Used in the HFE Detailed Quantification

There is only one HFE scenario associated with this HFE.

E6.6.3.4.2 Quantification of HFE Scenario for 060-OPWPInnerLid-HFI-NOD: Operator Causes Direct Exposure Due to Failure to Properly Install Waste Package Inner Shield Lid

E6.6.3.4.2.1 HFE Group #6 Scenario 1(a) for 060-OPWPInnerLid-HFI-NOD

1. Operator fails to install the waste package inner shield lid
2. Worker violates administrative control by entering the Waste Package Closure Room prior to the start of welding activities.

Operator Fails to Install the Waste Package Inner Shield Lid—For waste forms with unshielded canisters (DOE standardized canisters, multicanister overpacks, and HLW), the waste package inner lid is placed on the waste package with the CTM. For these waste forms, after the canister is placed in the waste package, the CTM operator must then retrieve, verify, document and install the waste package inner lid. The CTM operator can fail to perform this set of activities. Although this is an important and major part of CTM activities, it is the last step in CTM operations (Section E6.5). However, not all waste forms require the waste package inner lid to be installed in the CTM room; the inner lid for waste packages containing a TAD canister is installed during waste package closure in the Waste Package Closure Room. The waste package loading process for TAD canisters also differs from other waste forms in that all other waste forms require several canisters to fill a waste package, while TAD canisters only require one. Waste packages with unshielded canisters are also visually different from those with TAD canisters because they have gridded partitions on the interior which can be seen when looking down from the port.

Waste Package inner lids for unshielded canisters are staged in the Canister Transfer Room, while those for shielded canisters (TAD canisters) are staged in the Waste Package Closure Room. The two lids are physically different: the former lids are roughly eight inches thick while the latter is only about two inches thick; they also have different grapple attachments. If the inner lid for the unshielded canister is mistakenly staged in the Waste Package Closure Room, this may contribute to the operator's failure to install the waste package inner lid.

Failure of the operator to install the waste package inner lid is a significant EOO. This can occur if the CTM operator mistakes a waste package containing an unshielded waste form for a waste package containing a TAD canister. However, it is more likely that the CTM operator could confuse the procedures and believe the appropriate action is to put the lid on a waste package containing an unshielded waste form in the Waste Package Closure Room. Also, because there are roughly three times as many waste packages containing TAD canisters than other waste forms and the operator is on autopilot, the operator could believe that the lid will be emplaced in the Waste Package Closure Room (i.e., given that the majority of waste packages are TAD canisters, the operator would have a bias towards the TAD canister procedure). The CTM operator could also entirely forget to install the inner lid because of other factors (i.e., distraction). This is the last CTM operation for the waste package, so it is likely this is close to the end of the CTM operator's shift. This failure mode corresponds to the task execution error NARA CTT A4, adjusted for the following EPCs as follows:

- CTT A4: Judgment needed for the appropriate procedure to be followed, based on interpretation of a situation which is covered by training at appropriate intervals. The baseline HEP is 0.006.

While there are EPCs that could affect successful completion of the procedure, there are no applicable EPCs that are felt to make it more likely to select the wrong procedure. Failure to successfully follow the wrong procedure could actually have a beneficial effect in terms of correcting the error, but no credit is taken for that.

Operator fails to install the waste package inner shield lid = 0.006

Worker Violates Administrative Control by Entering the Waste Package Closure Room Prior to the Start of Welding Activities—Failing to install the waste package inner lid by itself does not cause a direct exposure because, in the Canister Transfer Room the port gate and shielded floor protects personnel. However, once the waste package is moved to the Waste Package Closure Room, there is a potential for direct exposure. There are several administrative controls (associated with the radiation protection program) restricting personnel from entering the Waste Package Closure Room during waste package closure. These controls include:

- Personnel are only allowed in the Waste Package Closure Room during prescheduled times
- All personnel must check in with the CRCF Control Room (where the WPTT is controlled) before entering the Waste Package Closure Room.

If these controls are violated and a person enters the Waste Package Closure Room when the waste package inner lid is missing, then that person is exposed. This unsafe action is entirely independent from the failure to install the waste package inner lid.

There is a small window of opportunity for this failure because in the Waste Package Closure Room the waste package inner lid serial number is verified and documented, and if the error is not discovered then, once the welding crew tries to weld the inner lid they discover it is missing.

Any worker that wishes to enter the Waste Package Closure Room needs to get permission to do so from a supervisor. If the worker violates this requirement there is nothing to prevent the worker from entering the room. However, this administrative control is fundamental to the operation of the facility and applies to entry to all important areas of the facility. This is best represented by NARA GTT A5 and is adjusted by the following EPCs:

- GTT A5: Completely familiar, well designed, highly practiced, and routine task performed to the highest possible standards by highly motivated, highly trained, and experienced personnel. Personnel are totally aware of the implications of failure and have time to correct potential errors. The baseline HEP is 0.0001.
- EPC 7: No obvious means of reversing an unintended action. The GTT HEP is based on their being time to correct potential errors. This does not exist for this task. The maximum effect of the EPC is 9, which applies when there is no means of recovering from an unintended action once executed. Given that the error is not correctable, the APOA is set at 1.0.

This assessment does not give credit to the worker for believing that there is a legitimate need to enter the Waste Package Closure Room in the first place. The analysts could not find a compelling context where this would be the case.

Applying the NARA HEP equation yields the following:

$$\begin{aligned} &\text{Worker violates administrative control by entering the} \\ &\text{Waste Package Closure Room prior to the start of welding activities} \\ &= 0.0001 \times [(9-1) \times 1.0 + 1] = 0.0009 \qquad \qquad \qquad (\text{Eq. E-41}) \end{aligned}$$

HEP Calculation for Scenario 1(a)—The events in the HEP model for scenario 1(a) are presented in Table E6.6-4.

Table E6.6-4. HEP Model for HFE Group #6 Scenario 1(a) for 060-OPWPInnerLid-HFI-NOD

Designator	Description	Probability
A	Operator fails to install the WP inner shield lid	0.006
B	Worker violates administrative control by entering the WP Closure Room prior to the start of welding activities	0.0009

NOTE: WP = waste package.

Source: Original

The Boolean expression for this scenario follows:

$$A \times B = 0.006 \times 0.0009 = 6E-06 \quad (\text{Eq. E-42})$$

E6.6.3.4.2.2 HEP for HFE 060-OpWPInnerLid-HFI-NOD

The Boolean expression for the overall HFE (all scenarios) follows:

$$060\text{-OpWPInnerLid-HFI-NOD} = \text{HEP 1(a)} = 6E-06 \quad (\text{Eq. E-43})$$

E6.6.4 Results of Detailed HRA for HFE Group #6

The final HEPs for the HFEs that required detailed analysis in HFE Group #6 are presented in Table E6.6-5 (with the original preliminary value shown in parentheses).

Table E6.6-5. Summary of HFE Detailed Analysis for HFE Group #6

HFE	Description	Final Probability
060-OpWPInnerLid-HFI-NOD	Direct exposure due to improper installation of inner lid	6E-6 (1E-4)

Source: Original

E6.7 ANALYSIS OF HUMAN FAILURE EVENT GROUP #7: WASTE PACKAGE EXPORT

HFE group #7 corresponds to the operations and initiating events associated with the ESD and HAZOP evaluation nodes listed in Table E6.0-1, covering waste package export. The operations covered in this HFE group are shown in Figure E6.7-1. The activities covered in HFE group #7 begin with the sealed waste package ready for emplacement, sitting vertically in the WPTT below the Waste Package Closure Room. The WPTT is moved to the Waste Package Loadout Room, where the waste package shield ring is removed, the WPTT enclosure is rotated to a horizontal position, and the waste package is transferred to the TEV. The operation ends when the TEV is loaded and ready for export.

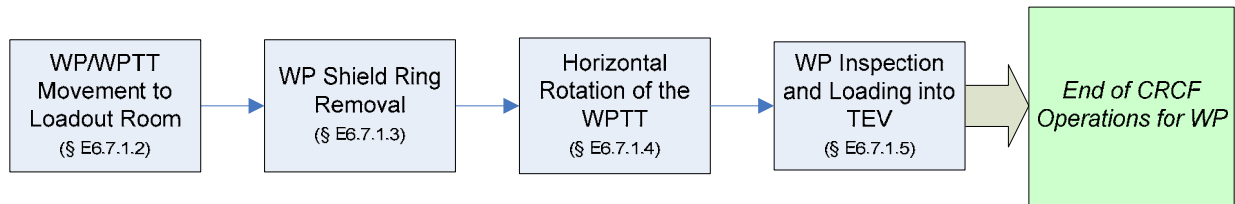

NOTE: § = section; CRCF = Canister Receipt and Closure Facility; TEV = transport and emplacement vehicle; WP = waste package; WPTT = waste package transfer trolley.

Source: Original

Figure E6.7-1. Activities Associated with HFE Group #7

E6.7.1 Group #7 Base Case Scenario

E6.7.1.1 Initial Conditions and Design Considerations Affecting the Analysis

The following conditions and design considerations were considered in evaluating HFE group #7 activities:

1. The waste package is secured to the WPTT and positioned under the Waste Package Closure Room.
2. The waste package is sealed, inspected, and has a shield ring resting on top.
3. The TEV is staged in the Waste Package Loadout Room ready to be loaded. The shield door is open and the bottom plate is lowered.
4. There is an interlock between the shield door and the personnel access doors. If there is a loaded waste package in the Waste Package Closure Room (load cell), the shield door can not open and the WPTT cannot move into the Waste Package Loadout Room until the personnel access doors are closed and locked.

The following personnel are involved in this set of operations:

- WPTT operator
- Crane operator

- Signaling crew member
- Verification crew member
- Radiation protection worker
- Supervisor
- TEV operator.

Section E5.1.2 provides a more detailed description of the duties performed by each of these personnel.

E6.7.1.2 Loaded Sealed Waste Package Movement to Waste Package Loadout Room and WPTT Docking Station Engagement

This operation is performed remotely. The operator opens the Waste Package Closure Room shield door and moves the WPTT (on rail) to the docking station in the Waste Package Loadout Room. Once the WPTT has cleared the Waste Package Closure Room shield door, an operator closes it. When in the proper position by the docking station, the WPTT engages the docking station by moving an arm down. Engagement is automatic. The operator checks the indicator to ensure proper engagement before continuing.

E6.7.1.3 Waste Package Shield Ring Removal and Shield Ring Movement to Waste Package Shield Ring Stand

At this point, the operator removes the waste package shield ring from the WPTT. This operation may be performed remotely or locally. In this analysis, a local operation is described since it is believed to have the greater potential for error.

The operator installs a lifting device (sling or hooks which connect to eye holes) on the waste package shield ring. Once the fixture is secure, the operator moves several yards away from the WPTT and signals the crane operator to lift the ring and place it on the stand. Once the shield ring is on the stand, all crew members must leave the area and close the shield door. A predesignated person, such as the radiation protection worker, is responsible for ensuring via checklist that all personnel have left the Waste Package Loadout Room and relays that information to the WPTT operator in the control room.

E6.7.1.4 Horizontal Rotation of the WPTT

This step is performed remotely. The WPTT operator confirms that the Waste Package Loadout Room is empty and signals the transfer trolley machine to down end the waste package.

E6.7.1.5 Waste Package Inspection and Loading into TEV

The WPTT operator signals the transfer carriage to move the waste package under the TEV. As the waste package is moving under the TEV, the WPTT and TEV operators visually inspect the waste package for damage. Once the waste package is under the TEV, the TEV operator signals the TEV to pick up the waste package, lift the bottom shield plate, and close the shield door. The TEV operator and WPTT operator are located in separate rooms; the TEV operator is in the Central Control Center and the WPTT operator is in the CRCF Control Room.

This is the end of CRCF operations for canisters exported in a waste package.

E6.7.2 HFE Descriptions and Preliminary Analysis

This section defines and screens the HFEs that are identified for the base case scenario that can affect the probability of initiating events occurring, and that could lead to undesired consequences. Descriptions and preliminary analysis for the HFEs of concern during waste package export are summarized in Table E6.7-1. The analysis presented here includes the assignment of preliminary HEPs in accordance with the methodology described in Section E3.2 and Appendix E.III of this analysis. Section E4.2 provides details on the use of expert judgment in this preliminary analysis see.

Table E6.7-1. HFE Group #7 Descriptions and Preliminary Analysis

HFE ID	HFE Brief Description	ESD	Preliminary Value	Justification
060-OpWPCollide1-HFI-NOD	<i>Operator Causes Low-Speed Collision of WPTT during Transfer to Loadout Room:</i> As the WPTT is moved from the WP Positioning Room to the WP Loadout Room, the operator can cause the WPTT to collide into an SSC. Due to the WPTT motor design all collisions of the WPTT are low-speed.	13	3E-03	The WPTT is on rails, but an operator can cause a collision of the WPTT with an object in its path or with an SSC. The WPTT speed is limited by motor design; therefore, all collisions of the WPTT are low-speed collisions. This failure is nearly identical to collision of the railcar while entering the facility (060-OpRCCollide1-HFI-NOD; Section E6.1, HFE Group #1: Receipt of SNF in the Railcar Entrance Vestibule and Movement into the Cask Preparation Room), and was assigned the same probability. This is a conservative preliminary value because the path the WPTT travels is expected to have less obstructions (doors, potential objects in the path) to collide into. This is the same failure as collision of the WPTT during transfer to the Waste Package Closure Area (060-OpWPCollide1-HFI-NOD; Section E6.6, HFE Group #6: Waste Package Assembly and Closure).
060-OpTiltDown01-HFI-NOD	<i>Operator Initiates Premature Tilt Down during Transfer to WP Loadout Room:</i> The operator can inadvertently initiate a tilt-down of the WP during transfer to the WP Loadout Room. If the WP is near a facility structure then this could result in a collision of the WP.	13	1.0	The operator can cause the WPTT to prematurely tilt down. The WPTT operator is in the process of driving the WPTT to the Waste Package Loadout Room. Tilt-down only occurs during waste package loadout in the Waste Package Loadout Room, and the controller for the WPTT tilt-down is distinct from other WPTT controls. In order to accomplish this failure, several interlocks must also fail. These interlocks, including an interlock taking power away from the WPTT when the port gate is open and an interlock between the tilt-down mechanism and the docking station, have no bypass. To be conservative, unsafe actions that require an equipment failure to cause an initiating event are assigned an HEP of 1.0.
WPTT Derailment	<i>Operator Causes Derailment of WPTT:</i> The WPTT travels on rail from the WP Positioning Room to the WP Loadout Room. During this transfer the operator can cause the WPTT to derail by running over a large object left on the rail or through other such mechanisms.	13	N/A ^a	In this step, the WPTT moves on rail from the Waste Package Positioning Room to the Waste Package Loadout Room. During this travel, there is a probability that the WPTT can derail, leading to a tipover of the WPTT. This HFE was not explicitly quantified because the probability of derailment due to human failure is incorporated in the historical data used to provide a general failure probability for derailment. Documentation for this failure can be found in Attachment C.
060-OpSDClose001-HFI-NOD	<i>Operator Closes Shield Door on Conveyance:</i> The WPTT passes through shield doors as it enters the WP Loadout Room. During this transfer, the operator can close the shield door on the WPTT.	7	1.0	The WPTT passes through shield doors as it enters the Waste Package Loadout Room. During this transfer, the operator can cause the WPTT to collide into the shield door or can close the shield door on the WPTT. See Section E6.0.2.3.3 for a justification of these preliminary values.
TEV_Collision	<i>Operator Drives TEV into WP:</i> The TEV is pre-staged in the WP Loadout Room with power off, ready to receive a WP. Because the TEV is not moved in this operation, this failure was omitted from analysis.	15	N/A	The TEV is pre-staged in the Waste Package Loadout Room with power off, ready to receive a waste package. Because the TEV is not moved in this operation, this failure was omitted from analysis.
060-OpTEVDrClosd-HFI-NOD	<i>Operator begins WP Extraction before TEV Doors Open:</i> If the operator extracts the WP before opening the TEV shield doors, then the WP runs into the TEV.	15	1E-03	The TEV is pre-staged and TEV operations in this respect are very standard, so it is unlikely that the TEV operator can not open the TEV shield door and extend the bed plate (0.01). The shield doors and bedplate are very visible, and there is adequate time between WPTT tilt-down and TEV loading for the operators to notice the TEV has not been properly staged before tilt-down (fail to notice, 0.1). Therefore, the preliminary value for waste package impact due to extraction before TEV doors are open is 0.001.
060-OpCraneIntfr-HFI-NOD	<i>Operator Causes Crane to Interfere with TEV or WPTT:</i> If the operator fails to properly stow the crane rigging, then the WPTT can impact the crane hook while tilting down.	15	1E-04	This operation was given the same preliminary value as the cask tipover during upending and removal HFE (060-OpTipover001-HFI-NOD; Section E6.2, HFE Group #2: Cask Upending and Removal from Conveyance) because it is a similar operation (movement with crane using same type of rigging and attachments) and has similar failure modes (i.e., failure to properly stow crane rigging).
060-OpWPTiltUp01-HFI-NOD	<i>Operator Causes Premature Tilt-up of WPTT:</i> If the operator signals the WPTT to tilt up while the WP is being extracted, this results in a drop of the WP.	15	1.0	While moving a waste package into the TEV, the operator can inadvertently cause the WPTT to tilt up, resulting in a drop of the waste package. In order to accomplish this, there are interlock(s) that must also fail. To be conservative, unsafe actions that require an equipment failure to cause an initiating event are assigned an HEP of 1.0.
Drop of Object on WP	<i>Operator Drops Heavy Object on WP:</i> During WP Export the WP Shield Ring is removed. It is possible that the shield ring can be dropped onto the WP during this operation.	15	N/A	In this step the operator moves the waste package shield ring over the waste package; the operator can potentially drop the shield ring onto the waste package. This HFE was not explicitly quantified because the probability of a crane drop due to human failure is incorporated in the historical data used to provide general failure probabilities for drops involving various crane and rigging types. Documentation for this failure can be found in Attachment C.
060-OpDirExpose3-HFI-NOD	<i>Operator Opens Facility Door during TEV Loading:</i> There is a gap between the tilted down WPTT and the TEV. The operator gets a direct exposure by opening the facility door while the WP is pulled into the TEV.	19	1E-03	In the process of TEV loading, the waste package is purposefully exposed to the Waste Package Loadout Room. Because of this "shine by design" mode of TEV loading, there are many safeguards to prevent personnel from being in the Waste Package Loadout Room during TEV loading. There are two general ways for a person to be in the Waste Package Loadout Room during this operation: an operator is left in the Waste Package Loadout Room when the operation begins or an operator enters the room after operations begin. There are procedural controls associated with the radiation protection program which limit who and when people can be in the Waste Package Loadout Room. There are also at least two separate checks of the room before operations begin: one locally and one from the control room via camera. Finally, there are radiation lights and alarms (non-ITS) which activate when the operations

Table E6.7-1. HFE Group #7 Descriptions and Preliminary Analysis (Continued)

				<p>begin. If a person is left in the Waste Package Loadout Room, they have several minutes to exit the room through clearly marked exits.</p> <p>For an operator to enter the room after operations begin, the door must be unlocked. There is an interlock which ensures the shield doors are locked before the WPTT enters the Waste Package Loadout Room. For the shield doors to be unlocked, the interlock would have to fail, or a worker must ask the control room supervisor for permission to enter. If the supervisor chooses to grant permission, then the following actions must be taken to allow someone in the room: stop operations, move the waste package to a safe and shielded state, and then unlock the shield door. If the supervisor fails to stop operations before letting the worker in, or if the operations are prematurely restarted before the worker leaves, then the worker gets a direct exposure. This failure was assessed to be "highly unlikely" and assigned a preliminary value of 0.001.</p>
060-OpShieldRing-HFI-NOD	<p><i>Operator Fails to Install WP Shield Ring in WPTT:</i> If a WP shield ring is not preinstalled in the WPTT before the canister is placed inside the WP during CTM activities, then when operators approach the WP to remove the shield ring in the WP Loadout Room, they get a direct exposure.</p>	19	1E-04	<p>The waste package shield ring is installed as part of the staging activities before CRCF operations for waste package loading begin. Shield ring installation is checked off by the staging crew and is also checked off by the operations crew directly before operations begin as part of the prejob plan. If the shield ring is not installed, the CTM operator has the chance to notice when emplacing the canister inside the waste package (camera view looking down on missing shield ring). If the canister is emplaced in the waste package, then, when operators approach the waste package to remove the shield ring in the Loadout Room, they get a direct exposure. This failure received a preliminary value of 0.01 for failure of the staging crew to install the shield ring and 0.01 for failure of the CTM operator to notice before a direct exposure occurs, resulting in a total preliminary value of 0.0001.</p>
060-OpFailRstInt-HFI-NOM	<p><i>Operator Fails to Restore Interlock after Maintenance:</i> There is an interlock which prevents the WP port gate from opening if a WP containing a shield ring is not below the port. This interlock may be bypassed during normal maintenance. If the bypass is not restored, this could contribute to the HFE above (060-OpShieldRing-HFI-NOD).</p>	18	1E-02	<p>There is an interlock which prevents the port gate from opening if a waste package containing a waste package shield ring is not below the port. This interlock may be bypassed during normal maintenance. If the bypass is not restored by the maintenance crew member and not discovered by the prejob check, this could contribute to the HFE above (060-OpShieldRing-HFI-NOD). This failure was assigned a preliminary value of 0.01, which corresponds to the generic preliminary value for the pre-initiator "failure to properly restore an operating system to service when the degraded state is not easily detectable."</p>
WPTT uncontrolled tilt-down	Operator causes uncontrolled tilt-down of WPTT	15	N/A	No human actions were identified that would contribute to an uncontrolled tilt-down.

NOTE: ^a HRA value replaced by use of historic data (Attachment C).
 CRCF = Canister Receipt and Closure Facility; CTM = canister transfer machine; ESD = event sequence diagram; HEP = human error probability; HFE = human failure event;
 ITS = important to safety; SNF = spent nuclear fuel; SSC = structure, system, or component; TEV transport and emplacement vehicle; WP = waste package; WPTT = waste package transfer trolley.

Source: Original

E6.7.3 Detailed Analysis

After the preliminary screening analysis and initial quantification are completed, those HFES that appear in dominant cut sets for event sequences that do not comply with the 10 CFR 63.111 performance objectives are subjected to a detailed analysis. The overall framework for the HRA is based upon the process guidance provided in ATHEANA (Ref. E8.1.22). Consistent with that framework, the following four steps from the methodology described in Section E3.2 provide the structure for the detailed analysis portion of the HRA:

Step 5: Identify Potential Vulnerabilities

Prior to defining specific scenarios that can lead to the HFES of interest (Step 6), information is collected to define the context in which the failures are most likely to occur. In particular, analysts search for potential vulnerabilities in the operators' knowledge and information base for the initiating event or base case scenario(s) under study that might result in HFES or unsafe actions. This information collection step discussed in Section E6.7.3.2.

Step 6: Search for HFE Scenarios (Scenarios of Concern)

An HFE scenario is a specific progression of actions with a specific context that leads to the failure of concern; each HFE is made up of one or more HFE scenarios. In this step, documented in Sections E6.7.3.3 and E6.7.3.4, the analyst identifies deviations from the base case scenario that are likely to result in risk-significant unsafe action(s). These unsafe actions make up an HFE scenario. In serious accidents, these HFE scenarios are usually combinations of various types of unexpected conditions.

Step 7: Quantify Probabilities of HFES

Detailed HRA quantification methods are selected as appropriate for the characteristics of each HFE and are applied as explained in Section E6.7.3.4. Four quantification methods are utilized in this quantification:

- CREAM (Ref. E8.1.18)
- HEART (Ref. E8.1.28)/NARA (Ref. E8.1.11)
- THERP (Ref. E8.1.26)
- ATHEANA expert judgment. (Ref. E8.1.22)

There is no implication of preference in the order of listing these methods. They are jointly referred to as the "preferred methods" and are applied either individually or in combination as best suited for the unsafe action quantified. The ATHEANA (Ref. E8.1.22) expert judgment method (as opposed to the overall ATHEANA (Ref. E8.1.22) methodology that forms the framework and steps for the performance of this HRA) is used when the other methods are deemed to be inappropriate to the unsafe action, as is often the case for cognitive EOCs.

Appendix E.IV of this analysis explains why these specific methods were selected for quantification and gives some background on when a given method is applicable based on the focus and characteristic of the method.

All judgments used in the quantification effort are determined by the HRA team and are based on their own experience, augmented by facility-specific information and the experience of subject matter experts, as discussed in Section E4. If consensus can be reached by the HRA team on an HEP for an unsafe action, that value is used as the mean. If consensus cannot be reached, the highest opinion is used as the mean.

Step 8: Incorporate HFEs into the PCSA

After HFEs are identified, defined, and quantified, they must be incorporated into the PCSA. The summary table of HFEs by group that lists the final HEP by basic event name provides the link between the HRA and the rest of the PCSA. This table can be found in Section E6.7.4.

E6.7.3.1 HFEs Requiring Detailed Analysis

The detailed analysis methodology, Sections E3.2.5 through E3.2.9, states that HFEs of concern are identified for detailed quantification through the preliminary analysis (Section E3.2.4). An initial quantification of the CRCF PCSA model determined that there was one HFE in this group whose preliminary value was too high to demonstrate compliance with the performance objectives stated in 10 CFR 63.111. This HFE is presented in Table E6.7-2.

Table E6.7-2. Group #7 HFE Requiring Detailed Analysis

HFE	Description	Preliminary Value
060-OpDirExpose3-HFI-NOD	Operator causes Direct Exposure while loading TEV	1E-03

NOTE: HFE = human error probability; TEV transport and emplacement vehicle.

Source: Original

E6.7.3.2 Assessment of Potential Vulnerabilities (Step 5)

For those HFEs requiring detailed analysis, the first step in the ATHEANA approach to detailed quantification is to identify and characterize factors that could create potential vulnerabilities in the crew's ability to respond to the scenarios of interest and might result in HFEs or unsafe actions. In this sense, the "vulnerabilities" are the context and factors that influence human performance and constitute the characteristics, conditions, rules, and tendencies that pertain to all the scenarios analyzed in detail.

These vulnerabilities are identified through activities including but not limited to the following:

1. The facility familiarization and information collection process discussed in Section E4.1, such as the review of design drawings and concept of operations documents
2. Discussions with subject matter experts from a wide range of areas, as described in Section E4.2

3. Insights gained during the performance of the other PCSA tasks (e.g., initiating events analysis, systems analysis, and event sequence analysis).

E6.7.3.2.1 Operating Team Characteristics

WPTT operator—Located in the Operations Room, the WPTT operator has received training for the WPTT and observed operations prior to being allowed to operate the WPTT on a dry run. The WPTT operator has been signed off to operate the WPTT based on an evaluation of proficiency during a dry run. The WPTT operator has been observed on initial operations before being signed off for solo operation. A single operator is assigned to the WPTT operation.

Waste package handling crane operator—Located in the Operations Room for this set of operations, the waste package handling crane operator has received training for crane operations and has observed operations prior to being allowed to operate the crane on a dry run. The waste package handling crane operator has been signed off to operate crane based on an evaluation of proficiency in dry run. The waste package handling crane operator has been observed on initial operations before being signed off for solo operation. A single operator is assigned the waste package handling crane operation.

Radiation protection worker—The radiation worker is a fully certified health physics technician, whose job is to monitor radiation during cask-related activities. The radiation protection worker is responsible for stopping operations if high radiation levels are detected.

Supervisor—The supervisor is in the CRCF Control Room during TEV loading. The supervisor is in charge of verifying proper operations and is also the only one who can grant other personnel access to the Waste Package Loadout Room (via pass code and key) from the CRCF Control Room.

E6.7.3.2.2 Operation and Design Characteristics

There are no humans in the Waste Package Loadout Room during this operation; all operators are located remotely in the CRCF Control Room. Crew members only enter this room for waste package preparation, which happens before the waste package is loaded.

All doors from the Waste Package Loadout Room can be opened from the inside in case of an emergency.

To open the facility shield door to the Waste Package Loadout Room, two people are required: one person has to unlock the shield door locally, and the other (a supervisor) has to unlock the door from the CRCF Control Room.

The personnel access door can only be opened from the CRCF Control Room and requires two separate actions (i.e., entering a pass code and then inserting a key). Only a supervisor is able to perform this action. However, the personnel access door is unlocked during waste package preparation, and must be relocked before TEV loading begins.

Radiation control signs and flashing lights are provided outside the door during TEV loading. These are non-ITS equipment.

After the personnel have removed the waste package shield ring and left the Waste Package Loadout Room, the radiation protection worker or other predesignated person ensures the Waste Package Loadout Room is vacant and signals the WPTT operator that it is safe to begin tilt-down.

A public address announcement is made inside the area to alert workers to clear the area before the WPTT is tilted. Intercom communications and television monitoring between workers and the CRCF Control Room ensure that the operator knows if exit is delayed.

Interlocks—The Waste Package Positioning Room has a load cell that can differentiate between an empty waste package and a loaded waste package. If there is a loaded waste package in the Waste Package Positioning Room, the Waste Package Positioning Room shield door cannot open to allow the WPTT to move to the Waste Package Loadout Room for export unless the facility shield door and the personnel shield doors are locked. Figure E6.7-2 is an illustration of the location of the various shield doors; this illustration is conceptual, and does not provide a precise representation of the actual configuration.

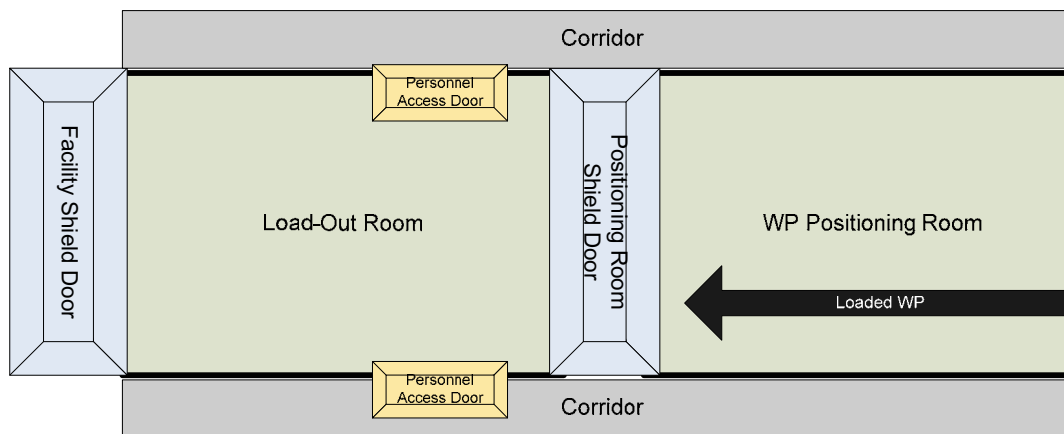

NOTE: WP = waste package.

Source: Original

Figure E6.7-2. Waste Package Positioning Room and Waste Package Loadout Room Conceptual Configuration

E6.7.3.2.3 Formal Rules and Procedures

Procedural controls—Procedural controls associated with the radiation protection program ensure that the operators and maintenance personnel do not enter the Waste Package Loadout Room except during scheduled times. A personnel accountability system is associated with entering and exiting the Waste Package Loadout Room. Personnel are required to check in with the supervisor and tag in and out before entering or after leaving the Waste Package Loadout Room.

E6.7.3.2.4 Operator Tendencies and Informal Rules

Consequences of Failure—The operations are performed remotely. No personnel are in the vicinity of the operation, and so the threat of physical injury is absent. The WPTT operator expects that failures are mitigated by design features without serious consequences, which promotes complacency in the operations.

Anticipatory Actions—The loadout process is remote, has a high degree of automation, and problems of any kind are not expected. There is a tendency for the WPTT operator to focus on future tasks while waste package is being loaded into the TEV.

Requests to enter Waste Package Loadout Room—The supervisor is present in the CRCF Control Room and aware of the stage of TEV loading. Serious consequences are associated with personnel being present in the Waste Package Loadout Room while a TEV is being loaded. Therefore, the supervisor would be very cautious not to admit anyone into the Waste Package Loadout Room during this time. If access to the room is necessary, the supervisor either stops operations and tilts up the WPTT or makes sure the TEV is fully loaded with shield doors closed before admitting a worker into the room.

E6.7.3.2.5 Operator Expectations

Anticipatory Actions—No one attempts to enter the Waste Package Loadout Room without a compelling reason.

E6.7.3.3 HFE Scenarios and Expected Human Failures (Step 6)

Given that the vulnerabilities that provide the operational environment and features that could influence human performance have been specified, then the HFE scenarios within this environment are identified. An HFE scenario is a specific progression of actions during normal operations (with a specific context) leading to the failure of concern; each HFE is made up of one or more HFE scenarios. In accordance with the methodology, each scenario integrates the unsafe actions with the relevant equipment failures so as to provide the complete context for the understanding and quantification of the HFE.

The HAZOP is instrumental in initially scoping out the HFE scenarios, but they are then refined through discussions with subject matter experts from a wide range of areas, as described in Section E4.2.

Table E6.7-3 summarizes all of the HFE scenarios developed for each HFE.

Table E6.7-3. HFE Scenarios and Expected Human Failures for Group #7

HFE	HFE Scenarios
060-OpDirExpose3-HFI-NOD <i>Operator causes Direct Exposure while loading TEV</i>	HFE Scenario 1(a): (1) A crew member remains in the Waste Package Loadout Room after evacuation ordered OR the WPTT operator fails to order an evacuation; (2) radiation protection worker fails to check if room is empty or radiation protection worker fails to recognize that someone is still in room; (3) crew member fails to notice that load-out is occurring OR Crew member fails to exit the room in time to avoid exposure. HFE Scenario 1(b): (1) Crew member requests reentry into enter the Waste Package Loadout Room; (2) supervisor agrees to allow access. HFE Scenario 1(c): (1) Personnel access shield door left open, (2) interlock OR Load Cell fails and WPTT enters the Waste Package Loadout Room.

NOTE: HFE = human failure events; WPTT = waste package transfer trolley.

Source: Original

Since there is one HFE identified for detailed analysis in this group, the scenarios are organized under this HFE category, with the scenarios numbered as 1(a), 1(b), and 1(c). Each HFE scenario is in turn characterized by several unsafe actions, numbered sequentially as (1), (2), (3), etc. The Boolean logic of the HFE scenarios is expressed with an implicit AND connecting the subsequent unsafe actions and OR notation wherever two unsafe action paths are possible, as shown in Table E6.7-3.

The HFE scenarios summarized in Table E6.7-3 are discussed and quantified in detail below.

E6.7.3.4 Quantitative Analysis (Step 7)

Once the HFE scenarios and the unsafe actions within them are scoped out, it is then possible to review them in detail and apply the appropriate quantification methodology in each case that permits an HEP to be calculated for each HFE. Stated another way, each HFE is quantified through the analysis and combination of the contributing HFE scenarios. Dependencies between the unsafe actions and equipment responses within each scenario and across the scenarios are carefully considered in the quantification process.

This section provides a description of the quantitative analysis performed, structured hierarchically by each HFE category (identified by a basic event name), the HFE scenario, and the unsafe actions under each scenario, as previously documented in Table E6.7-3

Prior to the scenario-specific quantification descriptions, a listing is provided of the values used in the quantification that are common across many of the HFE scenarios.

In generating the final HEP values, the use of more than a single significant figure is not justified given the extensive use of judgment required for the quantification of the individual unsafe actions within a given HFE. For this reason, all calculated final HEP values are reduced to one significant figure. When doing this, the value is always rounded upwards to the next highest single significant figure.

E6.7.3.4.1 Common Values Used in the HFE Detailed Quantification

There are some mechanical failures that combine with unsafe actions to form HFEs. In general, these mechanical failures are independent of the specific HFE scenario, and so they can be quantified independently. These values are presented in this section.

Interlock Failures—There are a number of interlock failures in the HFE scenarios. While the status of these events can affect subsequent events in the scenarios in different ways, the likelihood of this event occurring is independent of the scenario. This event is an equipment failure, and does not have a human component to its failure rate. The demand failure rate for an interlock, from Attachment C, Table C4-1, is approximately $2.7E-05$ per demand.

$$\text{Interlock fails to perform function} = 2.7E-05$$

E6.7.3.4.2 Quantification of HFE Scenarios for 060-OpDirExpose3-HFI-NOD: Operator Causes Direct Exposure during TEV Loading

E6.7.3.4.2.1 HFE Group #7 Scenario 1(a) for 060-OpDirExpose3-HFI-NOD

1. A crew member remains on the second floor of the Waste Package Loadout Room after evacuation ordered OR the WPTT operator fails to order an evacuation.
2. Radiation protection worker fails to check if the room is empty OR fails to recognize that someone is still in the room.
3. Crew member fails to notice that loadout is occurring OR a crew member fails to exit the room in time to avoid exposure.

A Crew Member Remains on the Second Floor of the Waste Package Loadout Room after an Evacuation Is Ordered—Prior to moving a loaded waste package to the Waste Package Loadout Room there may be maintenance or (empty) waste package preparation activities going on in the Waste Package Loadout Room. Once the WPTT is ready to be moved to the Waste Package Loadout Room, the WPTT operator makes an announcement for all personnel to leave the Waste Package Loadout Room.

Even if the WPTT operator notifies workers to leave the Waste Package Loadout Room, it is possible that they won't leave. The action of leaving itself is quite simple, but the communication of the request could be missed by virtue of the person being engrossed in the task. This can be represented by NARA GTT D1, adjusted for the following EPCs:

- GTT D1: Verbal communication of safety-critical data. The baseline HEP is 0.006.
- EPC 4: Low signal-to-noise ratio. This usually applies to a proliferation of information, but can be applied to masking by any distracting mechanism. The full effect is $\times 10$, which applies to significant levels of distraction. In this case, the level of distraction is small as there is not a significant amount of machine noise to mask the public announcement. The APOA is judged to be minimal, and thus is set to 0.1.

Using the HEP equation yields the following:

$$\begin{aligned} &\text{Crew member remains on the second floor of the Waste Package Loadout Room} \\ &\text{after evacuation ordered} = 0.006 \times [(10-1) \times 0.1 + 1] = 0.01 \quad (\text{Eq. E-44}) \end{aligned}$$

WPTT Operator Fails to Order Evacuation—The WPTT operator is required to announce that all personnel are to leave the Waste Package Loadout Room prior to initiating movement of the WPTT into the room. This action is part of the process procedure. The WPTT operator is required to make the announcement whether or not the operator believes anyone is in the room, so this can be represented by CREAM (Ref. E8.1.18) execution CFF E5, adjusted for the following CPCs with value not equal to 1.0:

- CFF E5: Action missed, not performed (omission). The baseline HEP is 0.03.
- CPC “Working Conditions”: The working conditions for the operator are in the CRCF Control Room with a favorable environment. The CPC for advantageous working conditions for an execution task is 0.8.
- CPC “Availability of Procedures”: With regard to the notification step, the procedures and checklist clearly list that this task needs to be performed. The CPC for appropriate availability of procedures for an execution task is 0.8.
- CPC “Available Time”: There is more than enough time to successfully perform this task. The CPC for adequate available time for an execution task is 0.5.
- CPC “Adequacy of Training/Preparation”: This is a routine task that is clearly trained and emphasized in training. Because it is routine, there is a high level of experience. The CPC for adequate training and high experience for an execution task is 0.8.

Applying these factors yields the following:

$$\begin{aligned} &\text{WPTT operator fails to order evacuation} = \\ &0.03 \times 0.8 \times 0.8 \times 0.5 \times 0.8 = 0.008 \quad (\text{Eq. E-45}) \end{aligned}$$

Radiation Protection Worker Fails to Check if Room Is Empty—This is an EOO by the radiation protection worker, (or another predesignated person) who fails to personally ensure that the Waste Package Loadout Room has been cleared of personnel. This is considered to be represented by CREAM (Ref. E8.1.18) execution CFF E5, adjusted for the following CPCs:

- CFF E5: Action missed, not performed (omission). The baseline HEP is 0.03.
- CPC “Working Conditions”: The working conditions are in the Waste Package Loadout Room with less favorable environment than the control room due to controlled access. The CPC for incompatible working conditions for an execution task is 2.0.

- CPC “Availability of Procedures”: With regard to the notification step, the procedures and checklist clearly list that this task needs to be performed. The CPC for appropriate availability of procedures for an execution task is 0.8.
- CPC “Available Time”: It is anticipated there is some time pressure to successfully perform this task so that loadout can proceed. The CPC for temporarily inadequate available time for an execution task is 1.0.
- CPC “Adequacy of Training/Preparation”: This is a routine task that is clearly trained and emphasized in training. Because it is routine, there is a high level of experience. The CPC for adequate training and high experience for an execution task is 0.8.

Applying these factors yields the following:

$$\begin{aligned} \text{Radiation protection worker fails to check if room is empty} = \\ 0.03 \times 2.0 \times 0.8 \times 1.0 \times 0.8 = 0.04 \end{aligned} \quad (\text{Eq. E-46})$$

Radiation Protection Worker Fails to Recognize that Someone Is Still in the Room—An EOC is considered to occur due to a lack of attention or perhaps a distraction that causes the Radiation protection worker to fail to perform the check properly. It is considered to be covered by HEART (Ref. E8.1.28) generic task (D) modified by the following EPC:

- GT (D): Fairly simple task performed rapidly or given scant attention with a baseline HEP of 0.09.
- EPC 17: Inadequate checking (HEART EPC 17). Little or no independent checking. The full effect is $\times 3$. In this case, since the radiation protection worker is completely unsupervised, the APOA is judged to be complete and is set at 1.0.

$$\begin{aligned} \text{Radiation protection worker fails to recognize that someone is still} \\ \text{in the room} = 0.09 \times [(3-1) \times 1.0 + 1] = 0.27 \end{aligned} \quad (\text{Eq. E-47})$$

Crew Member Fails to Notice that Loadout Is Occurring—While the WPTT operator does a remote check of the Waste Package Loadout Room, credit is not given for this check. It is up to the crew member, then, to notice that the WPTT is tilting down and to exit the room. The WPTT is large, and its movement is obvious. The crew member has just sufficient time to exit the room if the WPTT tilt-down is immediately noticed (within the first 30 seconds). The response is simple and no significant diagnosis is required. This error most closely corresponds to the CREAM (Ref. E8.1.18) observation error O3, observation not made.

- CFF O3: Observation not made (omission). The baseline HEP is 0.001.
- CPC “Working Conditions”: The working conditions are in the Waste Package Loadout Room with a less favorable environment than the CRCF Control Room due to controlled access. The CPC for incompatible working conditions for an observation task is 2.0.

- CPC “Available Time”: It is anticipated there is some time pressure to successfully perform this task so that load out can proceed. The CPC for temporarily inadequate available time for an observation task is 1.0.
- CPC “Adequacy of Training/Preparation”: This is a task that is clearly trained, and the risks of loadout is emphasized in training. Because it is performed frequently, there is a high level of experience. The CPC for adequate training and high experience for an observation task is 0.8.

Applying these factors yields the following:

$$\begin{aligned} \text{Crew member fails to notice that loadout is occurring} = \\ 0.001 \times 2.0 \times 1.0 \times 0.8 = 0.002 \end{aligned} \quad (\text{Eq. E-48})$$

Crew Member Fails to Exit the Room in Time to Avoid Exposure—Training indicates the need for action in such a case. A few minutes are available to exit through clearly marked doors. This can be represented by NARA GTT C1, adjusted for the following EPCs:

- GTT C1: Simple response to a range of alarms/indications providing clear indication of situation (simple diagnosis required). Response might be direct execution of simple actions or initiating other actions separately assessed. The baseline HEP is 0.0004.
- EPC 3: Time pressure. The full effect is $\times 11$, which corresponds to the operator having just enough time. In this case, there are some minutes left to act. The APOA anchor for 0.5 is that the operator must work at a fast pace. The situation is judged to be between these two anchors, and thus the APOA is set to 0.75.

Using the NARA HEP equation yields the following:

$$\begin{aligned} \text{Crew member fails to exit the room in time to avoid exposure} = \\ 0.0004 \times [(11-1) \times 0.75 + 1] = 0.003 \end{aligned} \quad (\text{Eq. E-49})$$

HEP Calculation for Scenario 1(a)—The events in the HEP model for Scenario 1(a) are presented in Table E6.7-4.

Table E6.7-4. HEP Model for HFE Group #7 Scenario 1(a) for 060-OpDirExpose3-HFI-NOD

Designator	Description	Probability
A	A crew member remains on the second floor of the Waste Package Loadout Room after evacuation ordered	0.01
B	WPTT operator fails to order evacuation	0.008
C	Radiation protection worker fails to check if room is empty	0.04

Table E6.7-4. HEP Model for Scenario 1(a) (Continued)

Designator	Description	Probability
D	Radiation protection worker fails to recognize that someone is still in room	0.27
E	Crew member fails to notice that loadout is occurring	0.002
F	Crew member fails to exit the room in time to avoid exposure	0.003

NOTE: WPTT = waste package transfer trolley.

Source: Original

The Boolean expression for this scenario follows:

$$(A + B) \times (C + D) \times (E + F) = (0.01 + 0.008) \times (0.04 + 0.27) \times (0.002 + 0.003) = (0.018) \times (0.31) \times (0.005) = 3E-5 \quad (\text{Eq. E-50})$$

E6.7.3.4.2.2 HFE Group #7 Scenario 1(b) for 060-OpDirExpose3-HFI-NOD

1. Crew member requests reentry into enter the Waste Package Loadout Room
2. Supervisor agrees to allow access.

Crew Member Requests Reentry into the Waste Package Loadout Room—TEV loading is a normal part of operations that takes less than a few hours and is performed about twice a week. Workers are trained not to enter the Waste Package Loadout Room unless necessary for a prescheduled activity. There is a posted schedule which all the workers, including the supervisor, are aware of. Also, during loadout, there are indicators in the CRCF Control Room and outside both the personnel access door and the shield door that turn on when TEV loading is in progress. These indicators, however, are non-ITS equipment, and no credit is given for their function.

Entry would have to be for some perceived urgent need in order to countermand training. This is believed to be best represented by NARA GTT A4, adjusted for the following EPCs:

- GTT A4: Judgment needed for appropriate procedure to be followed, based on interpretation of a situation which is covered by training at appropriate intervals. The baseline HEP is 0.006.
- EPC 14: Conflict between immediate and long-term objectives. The full effect is $\times 2.5$, which corresponds to deciding between two extremely significant problems, one of which is clearly more urgent than the other. The APOA anchor for 0.5 can be interpreted as suggesting situations of balancing an urgent plant need with an urgent personal need. The APOA anchor for 0.1 is that an individual has immediate personal needs, but there is an obvious safety task which requires completion. Other reasons for reducing from full effect include training and procedures that dictate a hierarchy of goals (which, in this case, may or may not actually help). The situation in this case is judged to be between 0.1 and 0.5, and thus the APOA is set to 0.3.

Using the NARA HEP equation yields the following:

$$\begin{aligned} \text{Crew member requests reentry into the Waste Package Loadout Room} = \\ 0.006 \times [(2.5-1) \times 0.3 + 1] = 0.009 \end{aligned} \quad (\text{Eq. E-51})$$

Supervisor Agrees to Allow Access—The supervisor believes that the reason for reentry is sufficiently compelling to stop the operation and allow the reentry to take place. The supervisor tells the WPTT operator to stop the operation, which does not prevent exposure upon reentry.

The supervisor knows that the TEV is being loaded and is aware of the consequences associated with entering the Waste Package Loadout Room during TEV loading. However, if the need is legitimate, the supervisor may choose to grant access. Given that the supervisor understands the consequences associated with direct exposure to the waste package, granting access to the Waste Package Loadout Room while the WPTT is being tilted down requires an act of great negligence; the likelihood of this was assessed to be very low and corresponds to NARA GTT A5; and adjusted by the following EPCs:

- NARA A5: Task Execution. Completely familiar, well designed highly practiced, routine task performed to highest possible standards by highly motivated, highly trained and experienced person, totally aware of implications of failure, with time to correct potential errors. The baseline HEP is 0.0001.
- EPC 14: A conflict between immediate and long-term objectives. The full effect would be $\times 2.5$. This EPC is applicable because there is a conflict between getting the worker in and out safely and keeping on schedule. To reduce the full affect of this EPC, training and clear procedures must dictate the hierarchy of goals and make operators aware of the dangers of ‘short-termism.’ Safety is expected to be a much higher priority in this case because the consequences are high and immediate and training emphasizes prioritizing safety over schedule. However, the paperwork associated with stopping the TEV loading operation provides the supervisor an additional incentive to violate the procedure if the supervisor believes it can be safely done. Therefore, the APOA is assessed to be 0.5.

$$\begin{aligned} \text{Supervisor agrees to allow access} = \\ 0.0001 \times [(2.5-1) \times 0.5 + 1] = 0.0002 \end{aligned} \quad (\text{Eq. E-52})$$

It should be noted that there are other possible unsafe actions for this scenario, such as the supervisor either failing to request stop of the loadout operation, failing to verify that the operation has stopped before opening the door, or prematurely restarting the operation while the worker is still in the Waste Package Loadout Room. In addition, it is possible that the WPTT operator could fail to stop the loadout operation as requested. However, these actions were considered much less likely than the primary unsafe actions cited above and, further, would only serve to drive down the overall scenario HEP value. Therefore, the analysts decided to conservatively constrain the analysis to the unsafe actions quantified above.

HEP Calculation for Scenario 1(b)—The event in the HEP model for Scenario 1(b) is presented in Table E6.7-5.

Table E6.7-5. HEP Model for HFE Group #7 Scenario 1(b) for 060-OpDirExpose3-HFI-NOD

Designator	Description	Probability
A	Crew member requests reentry into the Waste Package Loadout Room	0.009
B	Supervisor agrees to allow access	0.0002

Source: Original

The Boolean expression for this scenario follows:

$$A \times B = 0.009 \times 0.0002 = 2E-06 \quad (\text{Eq. E-53})$$

E6.7.3.4.2.3 HFE Group #7 Scenario 1(c) for 060-OpDirExpose3-HFI-NOD

1. Personnel access shield door left open
2. Interlock or load sensor fails and WPTT enters the Waste Package Loadout Room.

Personnel Access Door Left Open—Before the WPTT is moved from the Waste Package Positioning Room to the Waste Package Loadout Room, a designated radiation protection worker checks that the area is free from personnel and ensures that all the personnel access doors are closed and locked. (Note: if the personnel access doors are left unlocked, a person could potentially enter the room and incur direct exposure, but this is bounded by the current scenario.)

In this scenario, the unsafe action that occurs is that one of the shield doors is left open (i.e., the shield is not fully in place). This scenario also includes radiation protection worker being successful in assuring that all personnel have left the room (the unsafe action of failing to assure the room is empty is addressed in Scenario 1(a)).

The failure to recognize that an access door is left open is believed to be best represented by NARA GTT B3:

- GTT B3: Set system status as part of routine operations using strict administratively controlled procedures. The baseline HEP is 0.0007.

In addition, the WPTT operator would have to fail to verify by camera that the door was left open and fail to check the tag in/tag out board to address accountability for the location of personnel. This error is presumed to have medium dependency. Based on Table 20-21 of THERP (Ref. E8.1.26), for a baseline HEP of <.01 and medium dependence, the appropriate dependence value would be Item (3)(a) or 0.15.

$$\text{Personnel access shield door left open} = 0.0007 \times 0.15 = 0.0001$$

Interlock or Load Cell Fails and WPTT Enters the Loadout Room—There is an interlock between the personnel access shield doors and the Waste Package Positioning Room shield door. If there is a loaded WPTT in the Waste Package Positioning Room (load sensor), in order for the Waste Package Positioning Room shield door to open (to allow the WPTT to move into the Waste Package Loadout Room), the personnel access doors must be closed and locked. A direct

exposure would occur if the interlock fails since nothing would stop the WPTT operator from moving the WPTT into the Waste Package Loadout Room, and nothing would prevent radiation from escaping the room. The following mechanical failures are discussed in Section E6.7.3.4.1.

The mechanical failure probability for an interlock, from Attachment C, Table C4-1, is approximately $2.7E-5$ /demand.

$$\text{Interlock fails} = 2.7E-5$$

The mechanical failure probability for a load cell, represented by a pressure sensor from Attachment C, Table C4-1, is approximately $4.0E-03$ /demand.

$$\text{Load cell fails} = 4.0E-03$$

$$\text{Interlock or load cell fails} = 2.7E-05 + 4.0E-03 = 0.004$$

HEP Calculation for Scenario 1(c)—The events in the HEP model for Scenario 1(c) are presented in Table E6.7-6.

Table E6.7-6. HEP Model for Group #7 Scenario 1(c) for 060-OpDirExpose3-HFI-NOD

Designator	Description	Probability
A	Personnel access shield door left open	0.0001
B	Interlock_or Load Cell fails and WPTT enters the Waste Package Loadout Room	$4E-03$

NOTE: WPTT = waste package transfer trolley.

Source: Original

The Boolean expression for this scenario follows:

$$A \times B = 0.0001 \times 4E-03 = 4E-07 \quad (\text{Eq. E-54})$$

E6.7.3.4.2.4 HEP for HFE 060-OPDIREXPOSE3-HFI-NOD

The Boolean expression for the overall HFE (all scenarios) follows:

$$\begin{aligned} 060\text{-OPDIREXPOSE3-HFI-NOD} &= \text{HEP 1(a)} + \text{HEP 1(b)} + \text{HEP 1(c)} = \\ &3E-05 + 2E-06 + 4E-07 = 3E-05 \quad (\text{Eq. E-55}) \end{aligned}$$

E6.7.4 Results of Detailed HRA for HFE Group #7

The final HEPs for the HFEs that required detailed analysis in HFE Group #7 are presented in Table E6.7-7 (with the original preliminary value shown in parentheses).

Table E6.7-7. Summary of HFE Detailed Analysis for HFE Group #7

HFE	Description	Final Probability
060-OpDirExpose3-HFI-NOD	Operator causes direct exposure while loading TEV	3E-05 (1E-3)

NOTE: TEV = transport and emplacement vehicle.

Source: Original

E6.8 ANALYSIS OF HUMAN FAILURE EVENT GROUP #8: CLOSURE AND EXPORT OF AN AGING OVERPACK

HFE group #8 corresponds to the operations and initiating events associated with the ESD and HAZOP evaluation nodes listed in Table E6.0-1, covering closure and export of aging overpacks. The operations covered in this HFE group are shown in Figure E6.8-1. This operation begins after the canister has been placed into the aging overpack by the CTM, the aging overpack is located below the cask port, and the cask port is closed. The operation proceeds with the site transporter operator moving the aging overpack under the preparation platform in the preparation area from the Cask Unloading Room. The aging overpack lid is bolted on and the aging overpack is exported from the CRCF through the Site Transporter Entrance Vestibule. This operation ends once the site transporter/aging overpack has exited the facility and the exterior entrance vestibule door is closed.

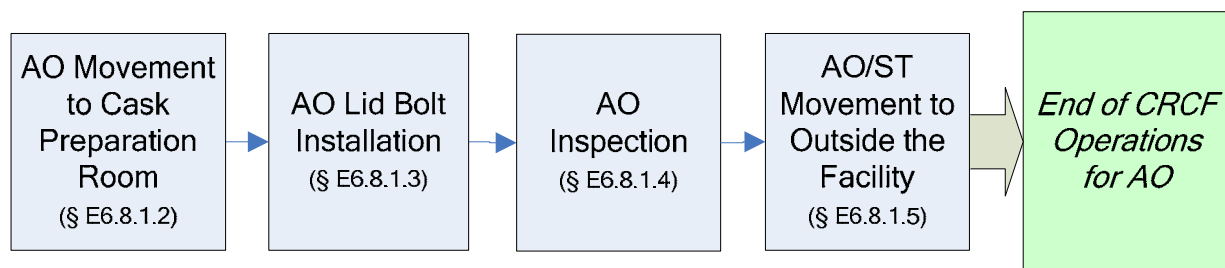

NOTE: § = Section; AO = aging overpack; CRCF = Canister Receipt and Closure Facility; HFE = human failure event; ST = site transporter.

Source: Original

Figure E6.8-1. Activities Associated with HFE Group #8

E6.8.1 Group #8 Base Case Scenario

E6.8.1.1 Initial Conditions and Design Considerations Affecting the Analysis

The following conditions and design considerations were considered in evaluating HFE group #8 activities:

1. The aging overpack (secured on a site transporter) is in the Cask Unloading Room, loaded with a TAD canister or DPC with a lid on top, unbolted.
2. The site transporter is off with forks lowered.
3. There is an interlock between the port slide gates and the Cask Unloading Room shield doors. The port slide gate cannot be open while the shield doors to the Cask Unloading Room are also open.

The following personnel are involved in this set of operations:

- Crew members (two people)
- Supervisor

- Site transporter operator
- Radiation protection worker¹².

Section E5.1.2 provides a more detailed description of the duties performed by each of these personnel.

E6.8.1.2 Aging Overpack Movement to Cask Preparation Room

A crew member opens the Cask Unloading Room shield door, and the site transporter operator turns on the site transporter, raises the site transporter forks and moves the loaded aging overpack out of the Cask Unloading Room to the Cask Preparation Room on the site transporter. The site transporter operator performs this task visually and also receives confirmatory hand signals from the crew member. Once the site transporter is cleared out of the Cask Unloading Room, the crew member closes the shield door.

E6.8.1.3 Aging Overpack Lid Bolt Installation

Using the cask preparation platform, shield plate and common tools, a crew member(s) closes the shield plate, emplaces and tightens all the aging overpack lid bolts according to the proper procedure and then verifies on the checklist that all the bolts have been properly installed.

E6.8.1.4 Aging Overpack Inspection

Once the cask is ready to leave the facility, the crew conducts a visual inspection and radiological survey of the exterior of the cask.

E6.8.1.5 Aging Overpack Movement from Cask Preparation Room to Outside

Movement of Loaded Site Transporter out of Cask Preparation Room—Once the site transporter is in the Cask Preparation Room and ready for export, the overhead door to the vestibule is opened and the site transporter proceeds to the Site Transporter Vestibule and stops. The inside door (shield door) is then closed by a crew member. A checklist is signed to indicate that the inside door has been closed.

Movement of Loaded Site Transporter out of Site Transporter Vestibule—Once the door to the Cask Preparation Room has been closed, a crew member opens the outside door of the Site Transporter Vestibule and the site transporter operator proceeds to move the site transporter to the outside. Once the site transporter has cleared the outside overhead door, a crew member closes the door.

¹²The radiation protection worker, or health physicist, is not mentioned specifically in each step of this operation; however, there is always at least one radiation protection worker present during this step.

E6.8.2 HFE Descriptions and Preliminary Analysis

This section defines and screens the HFEs that are identified for the base case scenario that can affect the probability of initiating events occurring, and that could lead to undesired consequences. Descriptions and preliminary analysis for the HFEs of concern during closure and export of an aging overpack are summarized in Table E6.8-1. The analysis presented here includes the assignment of preliminary HEPs in accordance with the methodology described in Section E3.2 and Appendix E.III of this analysis. Section E4.2 provides details on the use of expert judgment in this preliminary analysis.

Table E6.8-1. HFE Group #8 Descriptions and Preliminary Analysis

HFE ID	HFE Brief Description	ESD	Preliminary Value	Justification
060-OpSTCollide3-HFI-NOD	<i>Operator Causes Low-Speed Collision of ST with SSC while Moving from the Cask Unloading Room to the Cask Preparation Room:</i> Operator causes collision of ST with facility structure or equipment while moving the ST under the platform from the Cask Unloading Room.	14	3E-03	This operation is identical to site transporter collision while moving into the Cask Unloading Room (060-OpSTCollide2-HFI-NOD; Section E6.4, HFE Group #4: Site Transporter Receipt and Movement into the Cask Preparation Room; Aging Overpack Preparation and Movement to the Canister Transfer Room) and was therefore assigned the same preliminary value: this failure is "highly unlikely" (one in a thousand or 0.001) but was adjusted because there are several ways for a collision to occur (×3).
060-OpImpact0000-HFI-NOD	<i>Operator Causes Impact of Cask during Transfer from Cask Unloading room to Cask Preparation Room:</i> While moving from the Cask Unloading Room to the Cask Preparation Room, the ST can impact the crane hook or rigging if it is improperly stowed.	14	N/A	While moving from the Cask Unloading Room to the Cask Preparation Room, the site transporter can impact the crane hook or rigging if it is improperly stowed. The shield plate is closed at the end of every operation involving the preparation platform. It is unlikely, then, that the crane rigging can be improperly stowed such that it can impact the site transporter while it is moving out of the Cask Unloading Room; it is more likely that rigging will impact the cask while the crane is actually in use. Therefore, any crane interference with the site transporter is already covered by 060-OpAOImpact01-HFI-NOW (operator causes aging overpack impact during aging overpack closure) and 060-OpTipover003-HFI-NOD (Operator Causes Tipover of Site Transporter). This failure is identical to Operator Causes Impact of Cask during Transfer from Cask Unloading Room to Cask Preparation Room (060-OpImpact0000-HFI-NOD; Section E6.4, HFE Group #4: Site Transporter Receipt and Movement into Cask Preparation Room; Aging Overpack Preparation and Movement to the Cask Unloading Room).
060-OpSDClose001-HFI-NOD	<i>Operator Closes Shield Door on Conveyance:</i> Once the CTM activities are over, an operator opens the shield door, turns on the ST, lifts the forks and moves the cask from the Cask Unloading Room to the Cask Preparation Room. There is a shield door between the Cask Preparation Room and the Cask Unloading Room. Also, while exporting the ST, the ST must pass through the shield door between the Cask Preparation Room and the ST Entrance Vestibule. The operator can impact the cask by inadvertently closing the shield door on the ST as the ST passes through the door.	7	1.0	The site transporter passes through a shield door as it moves from the Cask Preparation Room into the Cask Unloading Room. During this transfer, the operator can cause the site transporter to collide into the shield door or close the shield door on the site transporter. See Section E6.0.2.3.3 for a justification of this preliminary value.
060-OpCTCollide1-HFI-NOD	<i>Operator Causes Low-Speed Collision of Auxiliary Vehicle with ST during Closure Activities:</i> While the ST is parked under the preparation platform for closure activities, the operator of an auxiliary vehicle can collide into the ST. If the speed governor is functioning, this is a low-speed collision.	12	3E-03	In this step the site transporter is loaded and parked under the preparation platform. The speed of auxiliary vehicles is slow, the site transporter is very visible and procedural controls are expected to limit the number of other vehicles in the Cask Preparation Room during cask operations. This HEP was assigned the same preliminary value as railcar collision HFE (060-OpRCCollide1-HFI-NOD; Section E6.1, HFE Group #1: Receipt of SNF in the Railcar Entrance Vestibule and Movement into the Cask Preparation Room) because the dominant mechanism of both failures is collision with an auxiliary vehicle. In this case, the preliminary value is conservative because the site transporter is staged under the platform and the railcar/truck trailer collision HFE has additional failure modes associated with movement of the site prime mover which are not applicable here. This failure is identical for the preparation activities in a CTT or site transporter (060-OpCTCollide1-HFI-NOD; Section E6.3, HFE Group #3: Cask Preparation Activities and Movement to Cask Unloading Room and Section E6.4, HFE Group #4: Site Transporter Receipt and Movement into the Cask Preparation Room; Aging Overpack Preparation and Movement to the Canister Transfer Room)
060-OpFLCollide1-HFI-NOD	<i>Operator Causes High-Speed Collision of ST with SSC:</i> Operator can cause an auxiliary vehicle to collide into a loaded ST while the conveyance is parked in the Cask Preparation Room. If the collision is due to the auxiliary vehicle speed governor malfunctioning, this is a high-speed collision.	12	1.0	The operator can cause an auxiliary vehicle (i.e., forklift) to over speed, resulting in collision with the site transporter while the site transporter is parked under the preparation platform or in transit to or from the platform. In order to accomplish this, the speed governor of the auxiliary vehicle must fail. The site transporter itself is limited by design from going too fast. To be conservative, unsafe actions that require an equipment failure to cause an initiating event are generally assigned an HEP of 1.0.
060-OpTipOver003-HFI-NOD	<i>Operator Causes Tipover of ST:</i> If the operator improperly stows the crane rigging, during AO preparation it can catch the ST or cask. If the crane becomes attached to the ST or cask and the operator continues to move the ST (i.e., exiting the Cask Preparation Room) or crane, the ST could tip over.	12	1E-04	In this step the site transporter is moved from the Cask Unloading Room to the Cask Preparation Room, the aging overpack lid bolts are installed, and then the site transporter is exported from the facility through the Site Transporter Entrance Vestibule. This operation is identical (but reverse) to receipt and preparation of the aging overpack and thus was given the same name and preliminary value as the site transporter tipover during receipt and preparation of the aging overpack (060-OpTipover003-HFI-NOD; Section E6.4, HFE Group #4: Site Transporter Receipt and Movement into the Cask Preparation Room; Aging Overpack Preparation and Movement to the Canister Transfer Room).
060-OpAOImpact01-HFI-NOW	<i>Operator Causes Impact of AO during AO Closure:</i> During AO closure the AO lid is bolted. If the lid bolts are installed with the crane, it is possible that AO/ST can be impacted by the crane hook due to improper crane operations.	12	3E-03	In this step, the aging overpack lid bolts are installed. If the crane is used to move the lid bolts, it is possible that the crane can impact the side of the site transporter/aging overpack. This operation is identical, but in reverse, of the preparation of the aging overpack and thus was given the same name and preliminary value as impact during preparation of the aging overpack (060-OpAOImpact01-HFI-NOD; Section E6.4, HFE Group #4: Site Transporter Receipt and Movement into the Cask Preparation Room; Aging Overpack Preparation and Movement to the Canister Transfer Room). This failure was assessed as "highly unlikely" (one in a thousand or 0.001) but is adjusted because there are several ways for an impact to occur (×3).
Drop of Object on AO	<i>Operator Drops Heavy Object on the AO during AO Closure:</i> During AO closure the AO lid is bolted. If the lid bolts are removed with the crane, it is possible that they can be dropped onto the cask.	N/A	N/A	Aging overpack closure activities simply entail installing the lid bolts. In this step the lid bolts or the tools used to install the lid bolts can be dropped onto the aging overpack. This failure was omitted from analysis because the bolts and tools were not considered to be "heavy objects."

Table E6.8-1. HFE Group #8 Descriptions and Preliminary Analysis (Continued)

HFE ID	HFE Brief Description	ESD	Preliminary Value	Justification
060-OpSpurMove01-HFI-NOD	<i>Operator Causes Spurious Movement of ST during Closure Activities:</i> The ST is supposed to be turned off, with the control pendant stored during this operation. However, if the ST is not in the proper configuration for AO closure, the operator can inadvertently cause the ST to move. This spurious movement can cause the ST to collide into the preparation platform.	12	1E-04	In this step the site transporter is parked under the preparation platform; the power is off, with the control pendant stored. For operations in this step there are several crew members on the preparation platform and no operators below the platform. This error was considered to be extremely unlikely (0.0001) because it requires multiple human errors: it would require the site transporter to be left on, the observers (the crane operator, two crew members or the radiation protection worker) would have to fail to notice or fail to stop operations and turn off the site transporter, and an operator would have to access the pendant and signal the site transporter to move. This failure is identical for the preparation activities in a CTT or site transporter (060-OpSpurMove01-HFI-NOD; Section E6.3, HFE Group #3: Cask Preparation Activities and Movement to Cask Unloading Room and Section E6.4, HFE Group #4: Site Transporter Receipt and Movement into the Cask Preparation Room; Aging Overpack Preparation and Movement to the Canister Transfer Room).
060-Liddisplace1-HFI-NOD	<i>Operator Inadvertently Displaces Lid:</i> The operator can improperly store the crane rigging such that it catches the lid lift fixture and pulls off the AO lid when bolts are installed, resulting in a direct exposure.	17	N/A	In this step the aging overpack lid is bolted with, perhaps, the use of the crane. Due to design changes to the preparation platform, improperly stowed rigging during this operation does not catch the lid lift fixture. These design changes include raising the platform and adding a shield plate so the cask is recessed underneath the platform and protected by the shield plate. Therefore this failure was omitted from analysis.
060-OpLoadDrop-HFI-NOD	<i>Operator Causes ST to drop AO:</i> The ST is like a forklift, carrying the AO several inches above the ground on its forks. If the AO is improperly secured onto the ST, it can fall off the forks while in transit or during closure activities.	16	N/A	The aging overpack is not purposefully lifted in this step. The only way for an aging overpack to be dropped is if it falls off the site transporter. The site transporter is like a fork lift which holds the aging overpack raised several inches above the ground while in transit. The site transporter cannot lift the aging overpack greater than one foot, so a drop greater than a foot is not plausible in this step. The aging overpack is prevented from moving on or falling off the site transporter by a securing mechanism which locks the aging overpack into place. The site transporter has traveled from the aging pad to the facility. It is highly unlikely that the aging overpack can drop in the facility due to human error given it has not dropped in transit to the facility because the aging overpack is not removed from the site transporter in the CRCF. Also, there are interlocks which prevent the site transporter from moving if the aging overpack is not properly secured. Therefore, drop of an aging overpack due to human failure was omitted from the analysis.
060-OpSTCollide4-HFI-NOD	<i>Operator Causes Low-Speed Collision of ST with SSC while Exporting the ST:</i> Operator causes collision of ST with facility structure or equipment while moving through the Cask Preparation Room to the ST Vestibule and then outside the facility. This is a separate HFE from 060-OpSTCollide3-HFI-NOD because this movement of the ST is temporally separate from ST movement to the Cask Preparation Room. Movement is separated by lid bolting activities.	16	3E-03	This operation is identical to (but reverse of) site transporter collision while moving into the facility (060-OpSTCollide1-HFI-NOD; Section E6.4, HFE Group #4: Site Transporter Receipt and Movement into the Cask Preparation Room; Aging Overpack Preparation and Movement to the Canister Transfer Room) and therefore has the same preliminary value.
ST Rollover	<i>Operator Causes ST to Rollover:</i> Operator drives over a significantly uneven surface while exporting the ST, causing the ST to rollover.	16	N/A	Although the center of mass for the site transporter is higher than that of the truck trailer, this failure mode was omitted from analysis for the same reasons as the truck rollover (Section E6.1). For a site transporter to rollover, the center of mass has to shift laterally. This can be done by traversing a significantly uneven surface or running over a very large object. There are no significantly uneven surfaces in the CRCF Entry Vestibule or Cask Preparation Room. It is incredible for the site transporter to run over an object large enough necessary to shift its center of mass.
060-OpFailStop-HFI-NOD	<i>Operator Fails to Stop ST if Tread Fails:</i> If the tread of the ST fails, it is possible the ST can rollover if the operator continues to operate the ST while trying to exit the facility.	16	1.0	If the tread of the site transporter fails, it is possible the site transporter can rollover if the operator continues to operate the site transporter. While it is unlikely that an operator would continue to operate a site transporter if such a significant and visible failure occurred, to be conservative, unsafe actions that require an equipment failure to cause an initiating event are assigned an HEP of 1.0.

NOTE: AO = aging overpack; CRCF = Canister Receipt and Closure Facility; CTT = cask transfer trolley; ESD = event sequence diagram; HEP = human error probability; HFE = human failure events; N/A = not applicable; SSC = structure, system, or component; ST = site transporter.

Source: Original

E6.8.3 Detailed Analysis

There are no HFEs in this group that require detailed analysis; the preliminary values in the facility model do not result in any Category 1 or Category 2 event sequences that fail to comply with the performance objectives of 10 CFR 63.111, therefore, the preliminary values were sufficient to demonstrate compliance with 10 CFR Part 63 (Ref. E8.2.1).

E7 RESULTS: HUMAN RELIABILITY ANALYSIS DATABASE

Table E7-1 presents a summary of all of the human failures identified in this analysis, and it provides a link between the HFE group and the ESD in which the human failure is modeled.

Table E7-1. HFE Data Summary

Basic Event Name	HFE Description	ESD	HFE Group	Basic Event Mean Probability	Error Factor	Type of Analysis
060-#EEE-LDCNTRA-BUA-ROE	Operator fails to restore ITS load center Train-A post maintenance	Electrical	OA (Pre-Initiator)	1.03E-05	10	Preliminary
060-#EEE-LDCNTRB-BUA-ROE	Operator fails to restore ITS load center Train-B post maintenance	Electrical	OA (Pre-Initiator)	1.03E-05	10	Preliminary
060-Liddisplace1-HFI-NOD	Operator inadvertently displaces cask lid during platform activities	17	3, 4, 8	N/A ^b	N/A	Omitted from Analysis
060-OpAOImpact01-HFI-NOW	Operator causes AO impact during AO platform activities (preparation or closure)	5, 12	4, 8	3.00E-03	5	Preliminary
060-OpCaskDrop01-HFI-NOD	Operator drops cask during cask preparation activities	4	3	N/A ^b	N/A	Omitted from Analysis
060-OpCICTMGate1-HFI-NOD	Operator inappropriately closes slide or port gate during vertical canister movement and continues lifting	9	5	1.00E-03	5	Preliminary
060-OpCollide001-HFI-NOD	Operator causes low-speed collision of auxiliary vehicle with RC, TT, CTT, or TTC	3	2	3.00E-03	5	Preliminary
060-OpCranelntfr-HFI-NOD	Operator causes WP handling crane to interfere with TEV or WPTT	15	7	1.00E-04	10	Preliminary
060-OpCTCollide1-HFI-NOD	Operator causes low-speed collision of auxiliary vehicle with ST/CTT	4, 5, 12	3, 4, 8	3.00E-03	5	Preliminary
060-OpCTCollide2-HFI-NOD	Operator causes low-speed collision of CTT with SSC during transfer from preparation station to Unloading Room	6	3	1.00E-03	5	Preliminary
060-OpCTMDirExp1-HFI-NOD	Operator causes direct exposure during CTM activities (Second Floor)	18	5	8E-06	10	Detailed

Table E7-1. HFE Data Summary (Continued)

Basic Event Name	HFE Description	ESD	HFE Group	Basic Event Mean Probability	Error Factor	Type of Analysis
060-OpCTMDrInt01-HFI-COD	Operator lifts object or canister too high with CTM (two-block)	9	5	1.0	N/A	Preliminary
060-OpCTMdrop001-HFI-COD	Operator drops object onto canister during CTM operations	9	5	4.00E-07	10	Detailed
060-OpCTMdrop002-HFI-COD	Operator drops canister during CTM operations	9	5	5.00E-07	10	Detailed
060-OpCTMImpact1-HFI-COD	Operator moves the CTM while canister or object is below or between levels	9	5	4.00E-08	10	Detailed
060-OpCTMImpact2-HFI-COD	Operator causes canister impact with lid during CTM operations (non-DPC)	9	5	N/A ^b	N/A	Omitted from Analysis
060-OpCTMImpact3-HFI-COD	Operator causes two CTMs to collide.	9	5	1.00E-01	3	Preliminary
060-OpCTMImpact5-HFI-COD	Operator causes canister impact with SSC during CTM operations	9	5	1.0	N/A	Preliminary
060-OpCTTImpact1-HFI-NOD	Operator causes an impact between cask and SSC due to crane operations	4	3	3.00E-03	5	Preliminary
060-OpDirExpose1-HFI-NOD	Operator causes direct exposure during CTM activities (first floor)	18	5	1.00E-01	3	Preliminary
060-OpDirExpose2-HFI-NOD	Operator causes direct exposure during CTM activities (transfer into an AO)	18	5	1.00E-04	10	Preliminary
060-OpDirExpose3-HFI-NOD	Operator causes direct exposure during TEV loading	19	7	3.00E-05	10	Detailed
060-OpDPCShield1-HFI-NOW	Operator causes loss of shielding while installing DPC lift fixture	17	3	4.00E-04	10	Detailed
060-OpDSNFLoad-HFI-NOD	Operator misloads DSNF	N/A	5	1.00E-03	5	Preliminary
060-OpFailRstInt-HFI-NOM	Operator fails to restore interlock after maintenance	18	5, 7	1.00E-02	3	Preliminary
060-OpFailSG-HFI-NOD	Operator fails to close the CTM slide gate moving CTM with canister inside bell (direct exposure)	18	5	1E-03	5	Preliminary

Table E7-1. HFE Data Summary (Continued)

Basic Event Name	HFE Description	ESD	HFE Group	Basic Event Mean Probability	Error Factor	Type of Analysis
060-OpFailStop-HFI-NOD	Operator fails to stop ST if tread fails	2, 16	4, 8	1.0	N/A	Preliminary
060-OpFLCollide1-HFI-NOD	Operator causes high-speed collision of auxiliary vehicle with RC, TT, ST, CTT or TTC	3, 4, 5, 12	2, 3, 4, 8	1.0	N/A	Preliminary
060-OpImpact0000-HFI-NOD	Operator causes impact of cask during transfer between preparation station and Unloading room	6, 14	3, 4, 8	N/A ^b	N/A	Omitted from Analysis
060-OpLoadDrop-HFI-NOD	Operator causes ST to drop AO	2, 16	4, 8	N/A ^b	N/A	Omitted from Analysis
060-OpNoDiscoAir-HFI-NOD	Operator fails to disconnect air supply from CTT in the Unloading Room	9	5	1.00E-03	5	Preliminary
060-OpNoUnBolt00-HFI-NOD	Operator fails to fully unbolt the cask lid before moving CTT into the Unloading Room (non-DPC)	9	5	1.00E-03	5	Preliminary
060-OpNoUnBoltDP-HFI-NOD	Operator fails to fully unbolt the cask lid before moving CTT into the Unloading Room (DPC)	9	5	N/A ^b	N/A	Omitted from Analysis
060-OpNoUnplugST-HFI-NOD	Operator fails to disconnect the power supply from the ST in the Unloading Room	9	5	1.00E-03	5	Preliminary
060-OpRCCollide1-HFI-NOD	Operator causes low-speed collision between RC and facility SSCs	1	1	3.00E-03	5	Preliminary
060-OpRCIntCol01-HFI-NOD	Operator causes high-speed collision between RC and facility SSCs	1	1	1.0	N/A	Preliminary
060-OpRCIntCol02-HFI-NOD	Operator causes MAP to collide into RC	1	1	1.0	N/A	Preliminary
060-OpSDClose001-HFI-NOD	Operator closes shield door on conveyance	7	OA (1, 3, 4, 7, 8)	1.0	N/A	Preliminary
060-OpShieldRing-HFI-NOD	Operator fails to install WP shield ring in WPTT (direct exposure)	19	7	1.00E-04	10	Preliminary
060-OpSpurMove01-HFI-NOD	Operator causes spurious movement of CTT or ST in the preparation area	3, 4, 5, 12	2, 3, 4, 8	1.00E-04	10	Preliminary

Table E7-1. HFE Data Summary (Continued)

Basic Event Name	HFE Description	ESD	HFE Group	Basic Event Mean Probability	Error Factor	Type of Analysis
060-OpStageRack1-HFI-NOD	Operator causes direct exposure during canister staging	18	5	3.00E-05	10	Detailed
060-OpSTCollide1-HFI-NOD	Operator causes low-speed collision of ST with SSC while moving to the Cask Preparation Room	2	4	3.00E-03	5	Preliminary
060-OpSTCollide2-HFI-NOD	Operator causes low-speed collision of ST with SSC while moving to the Cask Unloading Room	6	4	3.00E-03	5	Preliminary
060-OpSTCollide3-HFI-NOD	Operator causes low-speed collision of ST with SSC while moving from the Cask Unloading Room to the Cask Preparation Room	14	8	3.00E-03	5	Preliminary
060-OpSTCollide4-HFI-NOD	Operator causes low-speed collision of ST with SSC while exporting the ST	16	8	3.00E-03	5	Preliminary
060-OpTCImpact01-HFI-NOD	Operator causes an impact between cask and SSC during upending and removal	3	2	3.00E-03	5	Preliminary
060-OpTEVDrClosd-HFI-NOD	Operator begins WP extraction before TEV doors open	15	7	1.00E-03	5	Preliminary
060-OpTiltDown01-HFI-NOD	Operator causes premature tilt-down of the WPTT	9, 10, 13	5, 6, 7	1.0	N/A	Preliminary
060-OpTipover001-HFI-NOD	Operator causes cask to tip over during cask upending and removal	3	2	1.00E-04	10	Preliminary
060-OpTipover002-HFI-NOD	Operator causes cask to tip over during cask preparation activities	4	3	1.00E-04	10	Preliminary
060-OpTipOver003-HFI-NOD	Operator causes tipover of ST	5, 12	4, 8	1.00E-04	10	Preliminary
060-OpTipOver3-HFI-NOD	Operator causes tipover of ST or CTT during movement between the Cask Unloading Room and Cask Preparation Area	6	3, 4	N/A ^b	N/A	Omitted from Analysis
060-OpTTCollide1-HFI-NOD	Operator causes low-speed collision between TT and facility SSCs	1	1	3.00E-03	5	Preliminary

Table E7-1. HFE Data Summary (Continued)

Basic Event Name	HFE Description	ESD	HFE Group	Basic Event Mean Probability	Error Factor	Type of Analysis
060-OpTTIntCol01-HFI-NOD	Operator causes high-speed collision between TT and facility SSCs	1	1	1.0	N/A	Preliminary
060-OpTTIntCol02-HFI-NOD	Operator causes MAP to collide into TT	1	1	1.0	N/A	Preliminary
060-OpTTRollover-HFI-NOD	Operator causes rollover of TT	1	1	N/A ^b	N/A	Omitted from Analysis
060-OpWPCollide1-HFI-NOD	Operator causes low-speed collision of WPTT into SSC	10, 13	6, 7	3.00E-03	5	Preliminary
060-OpWPInnerLid-HFI-NOD	Operator fails to install WP inner lid (direct exposure)	19	6	6.00E-06	10	Detailed
060-OpWPTiltUp01-HFI-NOD	Operator prematurely tilts up the WPTT	15	7	1.0	N/A	Preliminary
060-OpWPTTSpur01-HFI-NOD	Operator causes spurious movement of WPTT during canister loading	9	5	1.00E-03	5	Preliminary
060-VCTO-DR00001-HFI-NOD	Operators open 2 or more Vestibule Doors in CRCF	HVAC	OA (Pre-Initiator)	1.00E-02	3	Preliminary
060-VCTO-HFIA000-HFI-NOM	Human error exhaust fan switch wrong position	HVAC	OA (Pre-Initiator)	1.00E-01	3	Preliminary
060-VCTO-HEPALK-HFI-NOD	Operator fails to notice HEPA filter leak in train A	HVAC	OA (Pre-Initiator)	1.0	N/A	Preliminary
26D-#EEY-ITSDG-A-#DG-RSS	Operator fails to restore Diesel Generator A to service	Electrical	OA (Pre-Initiator)	1.95E-04	10	Preliminary
26D-#EEY-ITSDG-B-#DG-RSS	Operator fails to restore Diesel Generator B to service	Electrical	OA (Pre-Initiator)	1.95E-04	10	Preliminary
Crane Drops (drop of cask or object onto cask)	Operator drops cask or drops object onto cask during crane operations	Various (3, 4, 11, 15)	OA (2, 3, 6, 7)	N/A ^a	N/A	Historical Data
Gas Sampling	Operator improperly performs gas sampling	N/A	3	N/A ^b	N/A	Omitted from Analysis
Improper WP Closure	Operator damages canister or fails to properly weld the WP	11	6	N/A ^b	N/A	Omitted from Analysis
Load too Heavy	Operator causes drop of cask by attempting to lift a load that is too heavy for the crane	N/A	OA	N/A ^b	N/A	Omitted from Analysis

Table E7-1. HFE Data Summary (Continued)

Basic Event Name	HFE Description	ESD	HFE Group	Basic Event Mean Probability	Error Factor	Type of Analysis
Moderator	Operator introduces moderator into a moderator-controlled area of the CRCF	N/A	OA	N/A ^b	N/A	Omitted from Analysis
RC Derailment	Operator causes the RC to derail	1	1	N/A ^a	N/A	Historical Data
Spurious Movement of CTT/ST during CTM Activities	Operator causes spurious movement of the CTT or ST during canister loading and unloading	9	5	N/A ^b	N/A	Omitted from Analysis
ST Rollover	Operator causes rollover of ST	2, 16	4, 8	N/A ^b	N/A	Omitted from Analysis
TEV_Collision	Operator causes TEV to collide with WP or WPTT	15	7	N/A ^b	N/A	Omitted from Analysis
WPTT Derailment	Operator causes WPTT to derail	10, 13	6, 7	N/A ^a	N/A	Historical Data
WPTT Uncontrolled Tilt-down	Operator causes an uncontrolled tilt-down of the WPTT	10, 15	6, 7	N/A ^b	N/A	Omitted from Analysis

NOTE: ^a Historical data was used to produce a probability of crane drops; this historical data is not included as part of the HRA, but is addressed in Attachment C.

^b These HFEs were initially identified, but omitted from analysis for various reasons, including a design change precluding the human failure, or the failure would require a series of unsafe actions in combination with mechanical failures, such that the event is no longer credible. See the appropriate HFE group in Attachment E for a case-by-case justification for these omissions.

AO = aging overpack; CRCF = Canister Receipt and Closure Facility; CTM = canister transfer machine; CTT = cask transfer trolley; DPC = dual-purpose canister; DSNF = U.S. Department of Energy spent nuclear fuel; ESD = event sequence diagram; HFE = human failure event; HVAC = heating, ventilation, and air conditioning; MAP = mobile access platform; MCC = motor control center; N/A = not applicable; OA = over arching (applies to multiple HFE groups, see Section 6.0.2); RC = railcar; SSC = structure, system, or component; SSCs = structures, systems, and components; ST = site transporter; TEV = transport and emplacement vehicle; TTC = a transportation cask that is upended using a tilt frame; TT = truck trailer; WP = waste package; WPTT = waste package transfer trolley.

Source: Original

E8 REFERENCES

E8.1 DESIGN INPUTS

The PCSA is based on a snapshot of the design. The reference design documents are appropriately documented as design inputs in this section. Since the safety analysis is based on a snapshot of the design, referencing subsequent revisions to the design documents (as described in EG-PRO-3DP-G04B-00037, *Calculations and Analyses* (Ref. 2.1.1, Section 3.2.2.F)) that implement PCSA requirements flowing from the safety analysis would not be appropriate for the purpose of the PCSA.

The inputs in this section noted with an asterisk (*) indicate that they fall into one of the designated categories described in Section 4.1, relative to suitability for intended use.

- E8.1.1* AIChE (American Institute of Chemical Engineers) 1992. *Guidelines for Hazard Evaluation Procedures*. 2nd Edition with Worked Examples. New York, New York: American Institute of Chemical Engineers. TIC: 239050. ISBN: 0-8169-0491-X.
- E8.1.2* ASME (American Society of Mechanical Engineers) NOG-1-2004. 2005. *Rules for Construction of Overhead and Gantry Cranes (Top Running Bridge, Multiple Girder)*. New York, New York: American Society of Mechanical Engineers. TIC: 257672. ISBN: 0-7918-2939-1
- E8.1.3* ASME NUM-1-2004. 2005. *Rules for Construction of Cranes, Monorails, and Hoists (with Bridge or Trolley or Hoist of the Underhung Type)*. New York, New York: American Society of Mechanical Engineers. TIC: 259317. ISBN: 0-7918-2938-3.
- E8.1.4* ASME RA-S-2002. *Standard for Probabilistic Risk Assessment for Nuclear Power Plant Applications*. New York, New York: American Society of Mechanical Engineers. TIC: 255508. ISBN: 0-7918-2745-3.
- E8.1.5* Benhardt, H.C.; Eide, S.A.; Held, J.E.; Olsen, L.M.; and Vail, R.E. 1994. *Savannah River Site Human Error Data Base Development for Nonreactor Nuclear Facilities (U)*. WSRC-TR-93-581. Aiken, South Carolina: Westinghouse Savannah River Company, Savannah River Site. ACC: MOL.20061201.0160.
- E8.1.6 BSC (Bechtel SAIC Company) 2006. *CRCF, IHF, RF, and WHF Canister Transfer Machine Mechanical Equipment Envelope*. 000-MJ0-HTC0-00201-000 REV 00A. Las Vegas, Nevada: Bechtel SAIC Company. ACC: ENG.20061120.0011.
- E8.1.7* BSC 2006. *Engineering Standard for Repository Component Function Identifiers*. 000-30X-MGR0-00900-000 REV 000. Las Vegas, Nevada: Bechtel SAIC Company. ACC: ENG.20060816.0001.
- E8.1.8* BSC 2007. *Engineering Standard for Repository Area Codes*. 000-3DS-MGR0-00400-000 REV 004. Las Vegas, Nevada: Bechtel SAIC Company. ACC: ENG.20070911.0015.
- E8.1.9* BSC 2007. *Repository System Codes*. 000-30X-MGR0-01200-000 REV 00E. Las Vegas, Nevada: Bechtel SAIC Company. ACC: ENG.20071101.0022.
- E8.1.10 BSC 2008. *Canister Receipt and Closure Facility Event Sequence Development Analysis*. 060-PSA-CR00-00100-000-00A. Las Vegas, Nevada: Bechtel SAIC Company. ACC: ENG.20080221.008.
- E8.1.11* CRA (Corporate Risk Associates) 2006. *A User Manual for the Nuclear Action Reliability Assessment (NARA) Human Error Quantification Technique*. CRA-BEGL-POW-J032, Report No. 2, Issue 5. Leatherhead, England: Corporate Risk Associates. TIC: 259873.

- E8.1.12 DOE-STD-1090-2004. 2004. *Hoisting and Rigging (Formerly Hoisting and Rigging Manual)*. 800-30R-SS00-00400-000-000. Washington, D.C.: U.S. Department of Energy. ACC: ENG.20060407.0002.
- E8.1.13* Dougherty, E.M., Jr. and Fragola, J.R. 1988. *Human Reliability Analysis: A Systems Engineering Approach with Nuclear Power Plant Applications*. New York, New York: John Wiley & Sons. TIC: 3986. ISBN: 0-471-60614-6.)
- E8.1.14* Gertman, D.; Blackman, H.; Marble, J.; Byers, J.; and Smith, C. 2005. *The SPAR-H Human Reliability Analysis Method*. NUREG/CR-6883. Washington, D.C.: U.S. Nuclear Regulatory Commission. ACC: MOL.20061103.0009.
- E8.1.15* Hall, R.E.; Fragola, J.R.; and Wreathall, J. 1982. *Post Event Human Decision Errors: Operator Action Tree/Time Reliability Correlations*. NUREG/CR-3010. Washington, D.C.: U.S. Nuclear Regulatory Commission. ACC: MOL.20071220.0211.
- E8.1.16* Hamlin, T.L. 2005. *Space Shuttle Probabilistic Risk Assessment - Human Reliability Analysis (HRA) Data Report*. VOL. III, Rev. 2.0. Washington, D.C.: NASA. ACC: MOL.20080311.0023.
- E8.1.17* Hannaman, G.W. and Spurgin, A.J. 1984. *Systematic Human Action Reliability Procedure (SHARP)*. EPRI-NP-3583. Palo Alto, California: Electric Power Research Institute. TIC: 252015.
- E8.1.18* Hollnagel, E. 1998. *Cognitive Reliability and Error Analysis Method, CREAM*. 1st Edition. New York, New York: Elsevier. TIC: 258889. ISBN: 0-08-0428487.
- E8.1.19* Lloyd, R.L. 2003. *A Survey of Crane Operating Experience at U.S. Nuclear Power Plants from 1968 through 2002*. NUREG-1774. Washington, D.C.: U.S. Nuclear Regulatory Commission. ACC: MOL.20050802.0185.
- E8.1.20 NRC (U.S. Nuclear Regulatory Commission) 1980. *Control of Heavy Loads at Nuclear Power Plants*. NUREG-0612. Washington, D.C.: U.S. Nuclear Regulatory Commission. TIC: 209017.
- E8.1.21 NRC 1983. *PRA Procedures Guide, A Guide to the Performance of Probabilistic Risk Assessments for Nuclear Power Plants*. NUREG/CR-2300. Two volumes. Washington, D.C.: U.S. Nuclear Regulatory Commission. TIC: 205084.
- E8.1.22 NRC 2000. *Technical Basis and Implementation Guidelines for a Technique for Human Event Analysis (ATHEANA)*. NUREG-1624, Rev. 1. Washington, D.C.: U.S. Nuclear Regulatory Commission. TIC: 252116.
- E8.1.23 NRC 2007. *Preclosure Safety Analysis - Human Reliability Analysis*. HLWRS-ISG-04. Washington, D.C.: Nuclear Regulatory Commission. ACC: MOL.20071211.0230.

- E8.1.24* Rasmussen, J. 1983. "Skills, Rules, and Knowledge; Signals, Signs, and Symbols, and Other Distinctions in Human Performance Models." *IEEE Transactions on Systems, Man, and Cybernetics, SMC-13*, (3), 257–266. New York, New York: Institute of Electrical and Electronics Engineers. TIC: 259863.
- E8.1.25* Swain, A.D. 1987. *Accident Sequence Evaluation Program Human Reliability Analysis Procedure*. NUREG/CR-4772. Washington, D.C.: U.S. Nuclear Regulatory Commission. ACC: MOL.20061103.0026.
- E8.1.26* Swain, A.D. and Guttman, H.E. 1983. *Handbook of Human Reliability Analysis with Emphasis on Nuclear Power Plant Applications Final Report*. NUREG/CR-1278. Washington, D.C.: U.S. Nuclear Regulatory Commission. TIC: 246563.
- E8.1.27* Vesely, W. 2008. "Re: CREAM Errata." E-Mail from W.Vesely to M.Presley, February 20, 2008. ACC: MOL.20080220.0081.
- E8.1.28* Williams, J.C. 1986. "HEART - A Proposed Method for Assessing and Reducing Human Error." *9th Advances in Reliability Technology Symposium - 1986*. Bradford, England: University of Bradford. TIC: 259862.
- E8.1.29* Williams, J.C. 1988. "A Data-Based Method for Assessing and Reducing Human Error to Improve Operational Performance." [*Conference Record for 1988 IEEE Fourth Conference on Human Factors and Power Plants*]. Pages 436–450. New York, New York: Institute of Electrical and Electronics Engineers. TIC: 259864.

E8.2 DESIGN CONSTRAINTS

- E8.2.1 10 CFR (Code of Federal Regulations) Part 63. 2007. Energy: Disposal of High-Level Radioactive Wastes in a Geologic Repository at Yucca Mountain, Nevada. U.S. Nuclear Regulatory Commission.

APPENDIX E.I RECOMMENDED INCORPORATION OF HUMAN FAILURE EVENTS IN THE YMP PCSA

Figure E.I-1 provides a graphical illustration of how HFEs are incorporated into the PCSA.

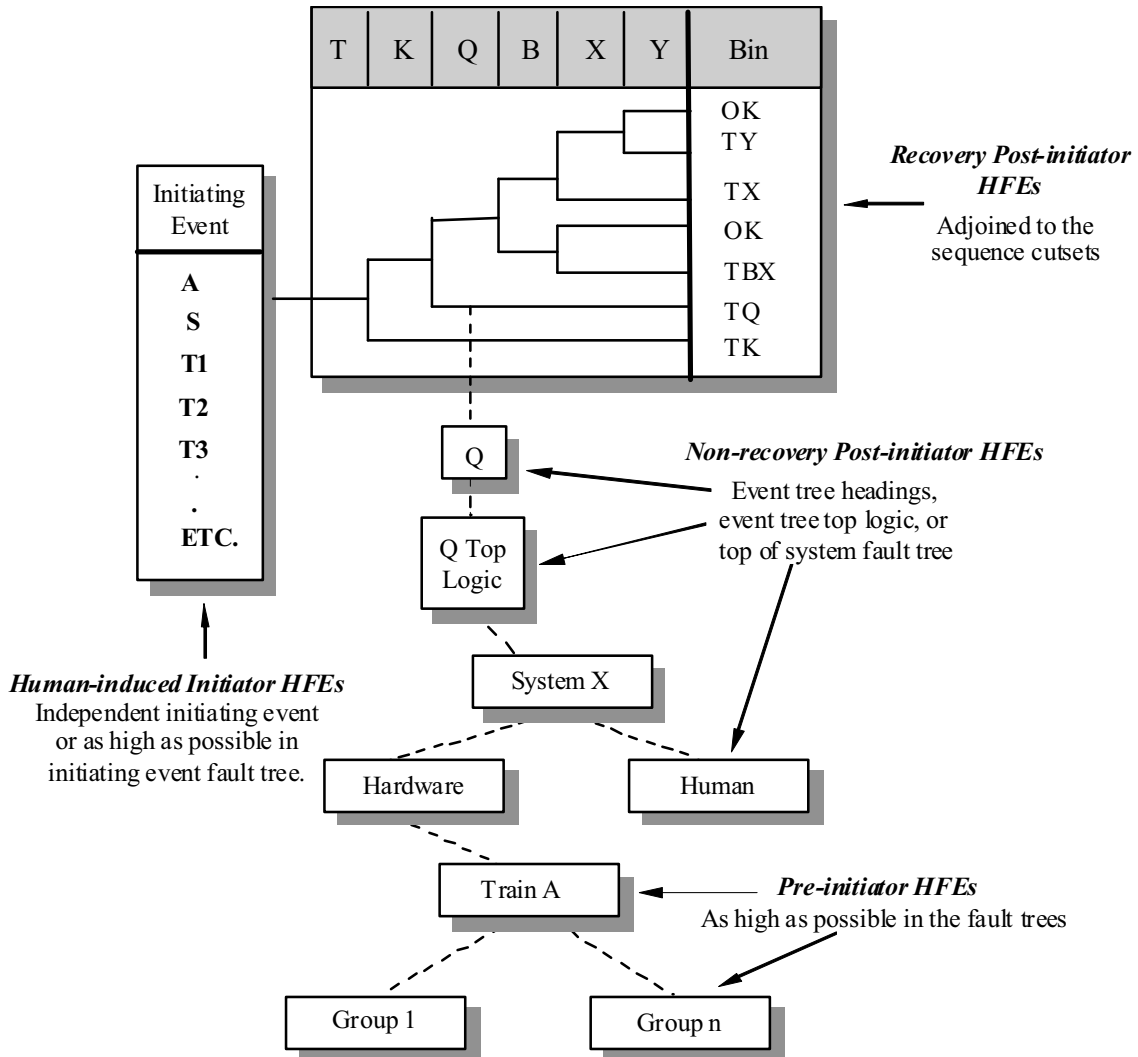

NOTE: HFE = human failure event.

Source: Original

Figure E.I-1. Incorporation of Human Reliability Analysis within the PCSA

**APPENDIX E.II
GENERAL STRUCTURE OF POST-INITIATOR HUMAN ACTIONS**

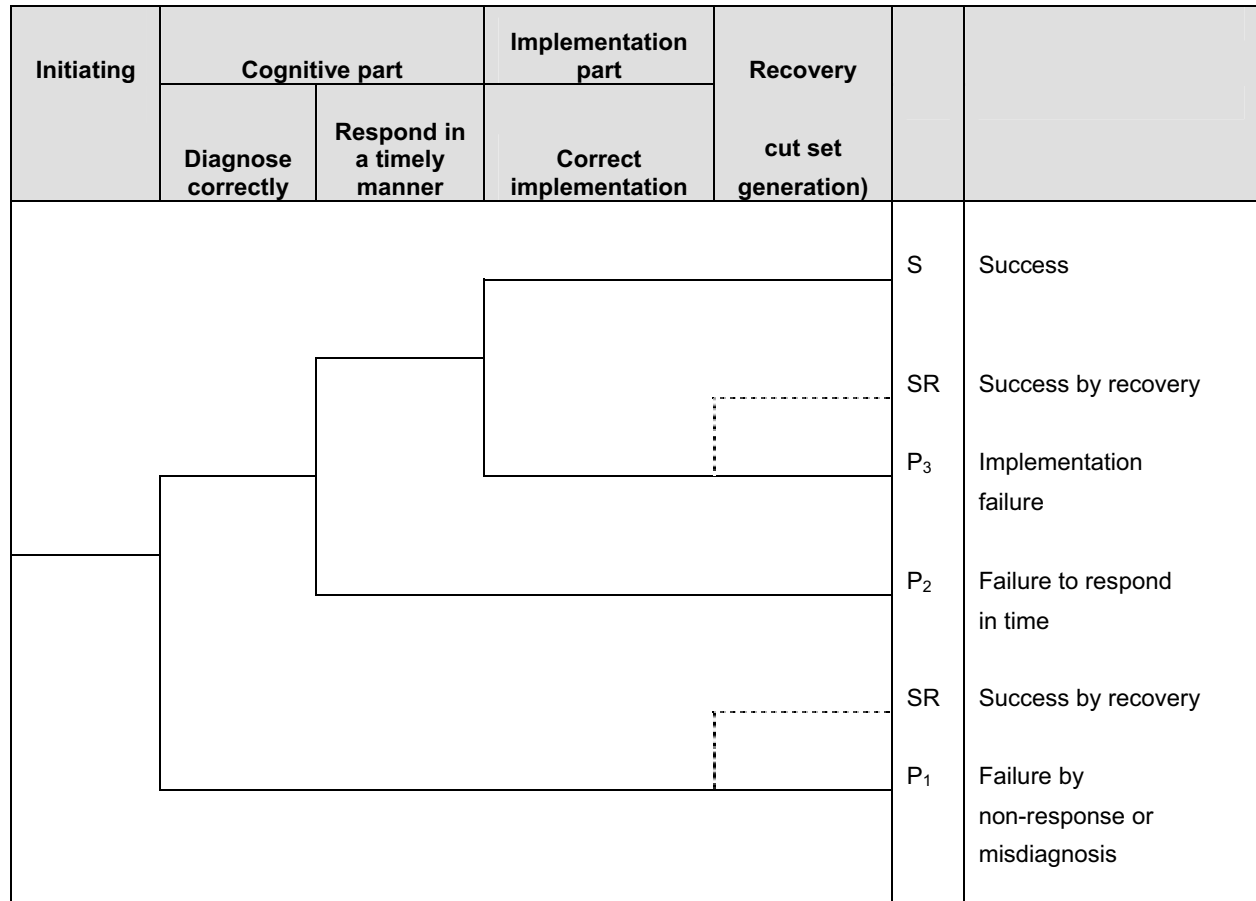

Source: Original

Figure E.II-1. Post Initiator Operator Action Event Tree

The representation in Figure E.II-1 consists of two elements, corresponding to a cognitive part (detection, diagnosis, and decision making) and an implementation (i.e., action) part.

P₁ represents the probability that operators make an incorrect diagnosis and decision and do not realize that they have done so. Some of the reasons for such mistakes are: incorrect interpretation of the procedures, incorrect knowledge of the plant state owing to communication difficulties, and instrumentation problems.

Given that the crew decides what to do correctly, there is still a possibility of failure to respond in time (represented by P₂) or making an error in implementation (represented by P₃).

However, it may be probable in certain scenarios that a recovery action can be taken. This consideration is taken into account after the initial quantification is completed and is applied as appropriate to the dominant cut sets.

**APPENDIX E.III
PRELIMINARY (SCREENING) QUANTIFICATION
PROCESS FOR HUMAN FAILURE EVENTS**

The preliminary quantification process consists of the following:

Step 1—Complete the Initial Conditions Required for Quantification.

The preliminary quantification process requires the following:

- The baseline scenarios are available.
- The HFEs and their associated context have been defined.
 - Collect any additional information that is not already collected and that is needed to describe and define the HFEs (and associated contexts).
 - Review all information for clarity, completeness, etc.
 - Interpret and prioritize all information with respect to relevance, credibility, and significance.

Table E.III-1 provides examples of information normally identified using the ATHEANA method (*Technical Basis and Implementation Guidelines for a Technique for Human Event Analysis* (Ref. E8.1.22) that serve as inputs to the quantification process. The HFE/context descriptions in Table E.III-1 touch briefly on the information that is relevant to the screening-level quantification of the HFE. Since the baseline scenario generally touches on much of this information, the point of including the HFE/context descriptions is to summarize the information that pertains to the specific HFE to minimize the need for the analysts to refer back to the baseline scenario, except to obtain additional detail.

Table E.III-1. Examples of Information Useful to HFE Quantification

Information Type	Examples
Facility, conditions, and behavior for possible deviations of the scenarios	Reasonably possible unusual plant behavior and failures of systems; equipment, and indications, especially those that may be unexpected or difficult to detect by operators. Includes presence of interlocks that would have to fail to promote the deviation.
Operating crew characteristics (i.e., crew characterization)	Crew structure, communication style, emphasis on crew discussion of the “big picture.”
Features of procedures	Structure, how implemented by operating crews, opportunities for “big picture” assessment and monitoring of critical safety functions, emphasis on relevant issue, priorities, any potential mismatches with deviation scenarios.
Relevant informal rules	Experience, training, practice, ways of doing things—especially those that may conflict with informal rules or otherwise lead operators to take inappropriate actions.
Timing	Plant behavior and requirements for operator intervention versus expected timing of operator response in performing procedure steps, etc.

Table E.III-1. Examples of Information Useful to HFE Quantification (Continued)

Information Type	Examples
Relevant vulnerabilities	Any potential mismatches between the scenarios and expected operator performance with respect to timing, formal and informal rules, biases from operator experience, and training, etc.
Error mechanisms	Any that may be particularly relevant by plant context or implied by vulnerabilities; applicable mechanisms depend upon whether HFE is a slip or mistake. Examples include: failures of attention, possible tunnel vision, conflicts in priorities, biases, missing or misleading indications, complex situations, lack of technical knowledge, timing mismatches and delays, workload, and human-machine interface concerns.
Performance-shaping factors	Those deemed associated with, or triggered by, the relevant plant conditions and error mechanisms.

NOTE: HFE = human failure event.

Source: Original

In Step 1, interpreting and prioritizing all information with respect to relevance, credibility, and significance is especially important if:

- Some information is applicable only to certain scenarios, HFEs, or contexts
- There are conflicts among information sources
- Information is ambiguous, confusing, or incomplete
- Information must be extrapolated, interpolated, etc.

Completion of the “lead-in” initial conditions is primarily performed by a single individual, using the results of the YMP HAZOP evaluation process and reviews of other relevant information sources. Discussions are also held with the Operations Department to augment that information, and the resulting write-ups are reviewed by the PCSA facility leads and the HRA team. The initial conditions are refined as part of an open discussion among the experts (in this case, the HRA team for the study) involved in the expert opinion elicitation process. The goal of this discussion is not to achieve a consensus but, rather, to advance the understanding of all the experts through the sharing of distributed knowledge and expertise. In each case, the scenario (or group of similar scenarios) and the HFE in question are described and the vulnerabilities and strong points associated with taking the right action are discussed openly among the HRA team.

Step 2—Identify the Key or Driving Factors of the Scenario Context.

The purpose of Step 2 is to identify the key or driving factors on operator behavior/performance for each HFE and associated context. Each expert participating in the elicitation process individually identifies these factors based on the expert’s own judgment. Usually, these factors are not formally documented until Step 4.

Typically, there are multiple factors deemed most important to assessing the probability for the HFE in question. This is due to the focus of the ATHEANA search process on combinations of factors that are more likely to result in an integrated context (Ref. E8.1.22). When there is only a single driving factor, it is usually one that is so overwhelming that it alone can easily drive the estimated probability. For example, if the time available is shorter than the time required to

perform the actions associated with the HFE, quantification becomes much simpler and other factors need not be considered.

Step 3—Generalize the Context by Matching it With Generic, Contextually Anchored Rankings, or Ratings.

In Step 3, each expert participating in the elicitation process must answer the following question for each HFE: based upon the factors identified in Step 2, how difficult or challenging is this context relative to the HFE being analyzed?

Answering this question involves independent assessments by each expert. In order to perform this assessment, the specifics of the context defined for an HFE must be generalized or characterized. These characterizations or generalizations then must be matched to general categories of failures and associated failure probabilities.

To assist the experts in making their judgments regarding the probability of events, some basic guidance is provided. In thinking about what a particular HEP associated with an HFE may be, they are encouraged to think about similar situations or experiences and use that to help estimate how many times out of 10, 100, 1,000, etc., would they expect crews to commit the HFE, given the identified conditions. The following examples of what different probabilities mean are provided to the experts to help them scale their judgments:

“Likely” to fail (extremely difficult/challenging)	~0.5	(5 out of 10 would fail)
“Infrequently” fails (highly difficult/challenging) ¹³	~0.1	(1 out of 10 would fail)
“Unlikely” to fail (somewhat difficult/challenging)	~0.01	(1 out of 100 would fail)
“Highly unlikely” to fail (not difficult/challenging)	~0.001	(1 out of 1000 would fail)

The experts are allowed to select any value to represent the probability of the HFE. That is, other values (e.g., $3E-2$, $5E-3$) can be used. The qualitative descriptions above are provided initially to give analysts a simple notion of what a particular probability means. For exceptional cases, the quantification approach allows an HEP of 1.0 to be used when failure was deemed essentially certain. The following general guidance in Table E.III-2 is also provided to help calibrate the assessment by providing specific examples that fall into each of the above bins, and is based on the elicited judgment and consensus of the HRA team based on their past experience. This guidance applies to contexts where generally optimal conditions exist during performance of the action. Therefore, the experts should modify these values if they believe that the action may be performed under non-optimal conditions or under extremely favorable conditions. Values may also be adjusted to take credit for design features, controls and interlocks, or procedural safety controls^{14,15}. Examples of such adjustments are also provided below; however

¹³ The default value is 0.1. This value is used if no preliminary assessment is performed.

¹⁴As an initial preliminary value, unsafe actions that are backed up by interlocks are assigned a human error probability of 1.0 such that no credit for human performance is taken (i.e., only the interlocks are relied upon to demonstrate 10 CFR Part 63 (Ref. E8.2.1) compliance). If this proves insufficient, a more reasonable preliminary value is assigned to the unsafe action in accordance with this Appendix.

these values are not taken to be firm in any sense of the word, but rather simply as examples of where in general terms HEPs may fall and how they may relate to each other. Types of HFES not listed here can be given values based on being “similar to” HFES that are listed. Whatever value is selected, the basis is briefly documented.

Table E.III-2. Types of HFES

PRE-INITIATOR HFES	
Fail to properly restore a standby system to service	0.1
Failure to properly restore an operating system to service when the degraded state is not easily detectable	0.01
Failure to properly restore an operating system to service when the degraded state is easily detectable	0.001
Calibration error	0.01
HUMAN-INDUCED INITIATOR HFES	
Failure to properly conduct an operation performed on a daily basis	0.001
Failure to properly conduct an operation performed on a very regular basis (on the order of once/week)	0.01
Failure to properly conduct an operation performed only very infrequently (once/month or less)	0.1
Operation is extremely complex OR conducted under environmental or ergonomic stress	×3
Operation is extremely complex AND conducted under environmental or ergonomic stress	×10
NON-RECOVERY POST-INITIATOR HFES	
Not trained or proceduralized, time pressure	0.5
Not trained or proceduralized, no time pressure	0.1
Trained and/or proceduralized, time pressure	0.1
Trained and/or proceduralized, no time pressure	0.01

Source: Original

Step 4—Discuss and Justify the Judgments Made in Step 3

In Step 3, each expert independently provides an estimate for each HFE. Once all the expert estimates are recorded, each expert describes the reasons why they chose a particular failure probability. In describing their reasons, each expert identifies what factors (positive and negative) are thought to be important to characterizing the context and how this characterization fit the failure category description and the associated HEP estimate.

¹⁵Note that if such credit is taken, then it may be necessary (based on the PCSA results) to include these items in the nuclear safety design basis or the procedural safety controls for the YMP facilities.

After the original elicited estimates are provided, a discussion is held that addresses not only the individual expert estimates but also differences and similarities among the context characterizations, key factors, and failure probability assignments made by all of the experts. This discussion allows the identification of any differences in the technical understanding or interpretation of the HFE versus differences in judgment regarding the assignment of failure probabilities. Examples of factors important to HFE quantification that might be revealed in the discussion include:

- Differences in key factors and their significance, relevance, etc., based upon expert-specific expertise and perspective.
- Differences in interpretations of context descriptions.
- Simplifications made in defining the context.
- Ambiguities and uncertainties in context definitions.

A consensus opinion is not required following the discussion.

Step 5—Refinement of HFEs, associated contexts, and assigned HEPs (if needed)

Based upon the discussion in Step 4, the experts form a consensus on whether or not the HFE definition must be refined or modified, based upon its associated context. If the HFE must be refined or redefined, this is done in Step 5. If such modifications are necessary, the experts “reestimate” based upon the newly defined context for the HFE (or new HFEs, each with an associated context).

The experts participating in the elicitation process are also allowed to change their estimate after the discussion in Step 4 based on the discussions during that step, whether or not the HFE definition and context are changed. Once again, a consensus is not required.

Step 6—Determine final preliminary HEP for HFE and associated context

The final preliminary value to be incorporated into the PCSA for each HFE is determined in Step 6.

The failure probabilities assigned in the preliminary HRA quantification are based on the context outlined in the base case scenarios and deemed to be “realistically conservative.” To help ensure this conservatism, if a consensus value could not be reached, the final failure probability that was assigned to each HFE was determined by choosing the highest assigned probability among the final estimates of the experts participating in the expert elicitation process.

APPENDIX E.IV SELECTION OF METHODS FOR DETAILED QUANTIFICATION

There are a number of methods available for the detailed quantification of HFEs (preliminary quantification is discussed in Appendix E.III of this analysis). Some are more suited for use for the YMP PCSA than others. A number of methods were considered, but many were rejected as inapplicable or insufficient for use in quantification. Several sources were examined as part of the background analysis for selecting a method for detailed quantification (Ref. E8.1.17; Ref. E8.1.13; Ref. E8.1.24; and Ref. E8.1.21). As discussed in Section E3.2 the following four were chosen:

- ATHEANA expert judgment (Ref. E8.1.22).
- CREAM (Ref. E8.1.18)
- HEART (Ref. E8.1.28)/NARA (Ref. E8.1.11)
- THERP (Ref. E8.1.26)

This appendix discusses the selection process.

Basis for Selection—The selection process was conducted with due consideration of the HRA quantification requirements set forth in the ASME Level 1 PRA standard (Ref. E8.1.4) to the extent that those requirements, which were written for application to NPP PRA, apply to the types of operations conducted at the YMP. Certainly, all of the high level HRA quantification requirements were considered to be applicable. Further, all of the supporting requirements to these high level requirements were considered applicable, at least in regards to their intent. In some cases, the specifics of the supporting requirements are only applicable to NPP HRA and some judgment is needed on how to apply them. This was particularly true of those supporting requirements that judged certain specific quantification methods acceptable. This appendix lays out the specific case for the methods selected for use at the YMP (or, more to the point, the exclusion of certain methods that would normally be considered acceptable under the standard, but are deemed inappropriate for use for the YMP PCSA).

Differences between NPP and the YMP Relevant to HRA Quantification—There are a number of contrasts between the operations at the YMP and the operations at a NPP that affect the selection of approaches to performing detailed HRA quantification (Table E.IV-1).

Table E.IV-1. Comparison between NPP and YMP Operations

NPP	YMP
Central control of operations maintained in control room.	Decentralized (local), hands on control for most operations.
Most important human actions are in response to accidents.	Most important human actions are initiating events.
Post-accident response is important and occurs in minutes to hours. Short time response important to model in HRA.	Post-accident response evolves more slowly (hours to days). Short time response not important to model.
Multiple standby systems are susceptible to pre-initiator failures.	Standby systems do not play major role in the YMP safeguards, therefore few opportunities for pre-initiator failures.
Auxiliary operators sent by central control room operators to where needed in the plant.	Local control reduces time to respond.
Most actions are controlled by automatic systems.	Most actions are controlled by operators.
Reliance on instrumentation /gauges as operators' "eyes."	Most actions are local, either hands on or televised. Less reliance on man-machine interface.
High complexity of systems, interactions, and phenomena. Actions may be skill, rule, or knowledge based.	Relatively simple process with simple actions. Actions are largely skill based.
Many in operation for decades; HRA may include walk-downs and consultation with operators.	First of a kind; HRA performed for construction application, therefore walk-downs and consultation with operators not feasible.

NOTE: HRA = human reliability analysis; NPP = nuclear power plant; YMP = Yucca Mountain Project.

Source: Original

Assessment of Available Methods—There are essentially four general types of quantification approaches available:

1. Procedure focused methods:
 - A. Basis: These methods concentrate on failures that occur during step-by-step tasks (i.e., during the use of written procedures). They are generally based on observations of human performance in the completion of manipulations without much consideration of the root causes or motivations for the performance (e.g., how often does an operator turn a switch to the left instead of to the right).
 - B. Methods considered: THERP (Ref. E8.1.26).
 - C. Applicability: This method is of limited use for the YMP because important actions are not procedure driven. Many operations are skill-based and/or semi-automated (e.g., crane operation, trolley operation, CTM operation, TEV operation). However, there are some instances where such an approach would be applicable to certain unsafe actions within an HFE. In addition, the THERP dependency model is adopted by NARA as being appropriate to use within a context-based quantification approach.

- D. Assessment: THERP is retained as an option in the detailed quantification for its dependency model and for limited use when simple, procedure-driven unsafe actions are present within an HFE.
2. Time-response focused methods:
 - A. Basis: These methods focus on the time available to perform a task, versus the time required, as the most dominant factor in the probability of failure. They are, for the most part, based on NPP control room observations, studies, and simulator exercises. They also tend to be correlated with short duration simulator exercises (i.e., where there is a clear time pressure in the range of a few minutes to an hour to complete a task in response to a given situation).
 - B. As discussed in *Human Reliability Analysis: A Systems Engineering Approach with Nuclear Power Plant Applications* (Ref. E8.1.13), examples of time-response methods include: HCR (Ref. E8.1.13) and TRCs (Ref. E8.1.15).
 - C. Applicability: These methods are not applicable to the YMP because most actions do not occur in a control room and, in addition, are generally not subject to time pressure. This is particularly true of the most important HFEs, those that are human-induced initiators. Other than a desire to complete an action in a timely fashion to maintain production schedules, time is irrelevant to these actions, especially in the context of the type of time pressure considered by these methods. Even those actions at the YMP that may take place in a control room in response to an event sequence and have time as a factor would only require response in the range of hours or days, which is outside the credible range for these methods.
 - D. Assessment: No use can be identified for these methods within the YMP PCSA. None of them are retained.
 3. Context and/or cognition driven methods:
 - A. Basis: These methods focus on the context and motivations behind human performance rather than the specifics of the actions, and as such are independent of the specific facility and process. To the extent that some of the methods are data-driven (i.e., they collect and use observations of human performance) the data utilized is categorized by GTT rather than by the type of facility or equipment where the human failure occurred. This makes them more broadly applicable to various industries, tasks, and situations, in large part because they allow context-specific PSFs to be considered. This allows for them to support a variety of contexts, individual performance factors (e.g., via PSFs) and human factor approaches.
 - B. Methods considered: HEART (Ref. E8.1.28; Ref. E8.1.29)/NARA (Ref. E8.1.11), CREAM (Ref. E8.1.18), and ATHEANA expert judgment (Ref. E8.1.22).

- C. **Applicability:** The broad applicability of these methods and their flexibility of application make them most suited for application at the YMP. The use of information from a broad range of facilities and other performance regimes (e.g., driving, flying) support their use as facility-independent methods. The generic tasks considered can be applied to the types of actions of most concern to the YMP (i.e., human-induced initiators) as opposed to the more narrow definitions used in other approaches that make it difficult to use them for other than post-initiator or pre-initiator actions.
- D. **Assessment:** Optimally it would be convenient to use only one of the three methods of this type for all the detailed quantification. However, HEART (Ref. E8.1.28)/NARA (Ref. E8.1.11) and CREAM (Ref. E8.1.18) approach their GTTs slightly differently and also use different PSFs and adjustment factors. There are unsafe actions within the YMP HFEs that would best fit the HEART (Ref. E8.1.28)/NARA (Ref. E8.1.11) approach and others that would best fit the CREAM (Ref. E8.1.18) approach. In addition, the union of the two approaches still has some gaps that would not cover a small subset of unsafe actions for the YMP (primarily in the area of unusual acts of commission). One gap relates to dependencies between actions, but in this case NARA (Ref. E8.1.11) specifically endorses the THERP (Ref. E8.1.26) approach and so this is used. However, other gaps exist. For these cases, the ATHEANA (Ref. E8.1.22) expert judgment approach provides a viable and structured framework for the use of judgment to establish the appropriate HEP values in a manner that would meet the requirements of the ASME RA-S-2002 (Ref. E8.1.4) standard. Therefore, all three of these methods are retained for use and the selection of one versus the other is made based on the specific unsafe action being quantified. This is documented as appropriate in the actual detailed quantification of each HFE.

4. Simplified methods:

- A. **Basis:** These methods use the results of past PRAs to focus attention on those HFEs that have dominated risk. These are essentially PRA results from NPPs. As such, they presuppose NPP situations and actions, and define important PSFs based on these past NPP PRAs. They have very limited (if any) ability to investigate context, individual and human factors that are beyond NPP experience. The HEPs that result from applying these methods are calibrated to other NPP methods.
- B. **Methods considered:** ASEP (Ref. E8.1.25), SPAR-H (Ref. E8.1.14).

- C. **Applicability:** These methods are clearly biased by their very close dependence on the results of past NPP PRAs. They are too limited for application beyond the NPP environment. They are not simply inappropriate for this application, but it would be extremely difficult to make a sound technical case regarding technical validity.

- D. **Assessment:** No use can be identified for these methods within the YMP PCSA or any technical case made supporting them for a non-NPP application. None of them are retained.

APPENDIX E.V HUMAN FAILURE EVENTS NAMING CONVENTION

Event names for HFEs in the YMP PCSA model follow the general structure of the naming convention for fault tree basic events. This is true whether the HFE is modeled in a fault tree, directly on an event tree, or as an initiating event. The convention, as adapted for HFEs, is as follows:

This basic event naming convention in Figure E.V-1 below is provided to ensure consistency with project standards and to permit this information to fit into a 24-character SAPHIRE field such that each basic event can be correlated to a unique component or human failure.

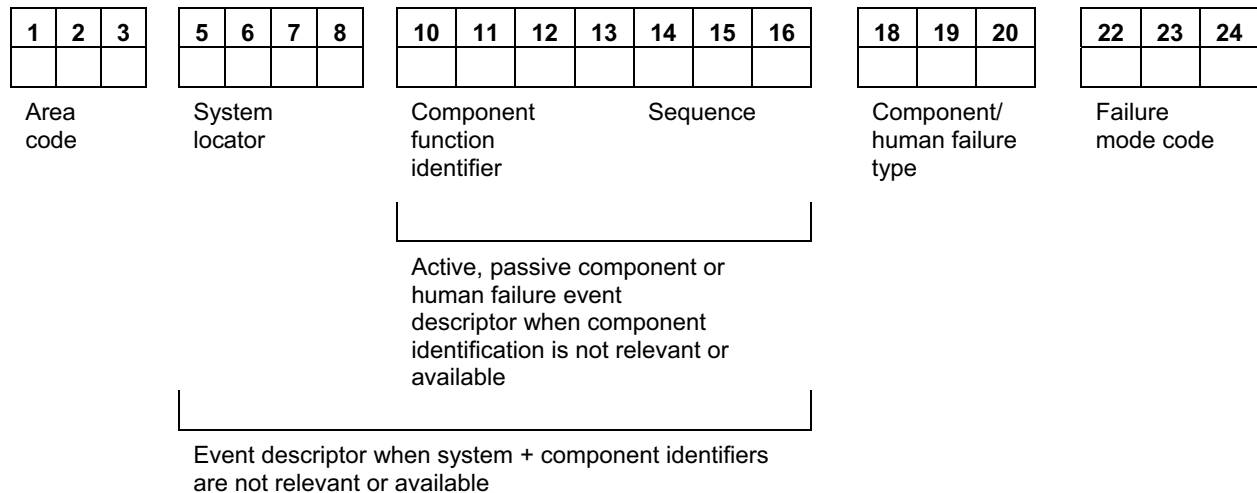

Source: Original

Figure E.V-1. Basic Event Naming Convention

The area code defines the physical design or construction areas where a component would be installed. Area codes are listed in *Engineering Standard for Repository Area Codes*, (Ref. E8.1.8). These codes are used rather than the facility acronyms to maintain consistency with Engineering. In this system, the CRCF is designated by area code 060, the Wet Handling Facility is 050, the Receipt Facility is 200, the Initial Handling Facility is 51A, and Subsurface is 800. Intra-Site Operations could fall under one of several repository area codes and therefore the most appropriate code to use was the repository general area code. However, this code was insufficient for the purposes of this analysis, and a designator of ISO was substituted instead. For the majority of cases, the area coding of HFEs in Attachment E reflects the location of the operations being evaluated, such as ISO for Intra-Site Operations. However, for certain HFEs, the coding corresponds to the location of the systems impacted by the human failure, such as HVAC, which is specific to the CRCF and therefore retains the 060 coding, and AC power, which retains the 26x and 27x coding. For these specific instances, such coding provides better traceability of the HFE back to the affected equipment.

The system locator code identifies operational systems and processes. System locator codes (four characters) are listed in Table 1 of *Repository System Codes* (Ref. E8.1.9). These are generally three or four characters long, such as VCT for tertiary confinement HVAC.

The component function identifiers identify the component function and are listed in the *Engineering Standard for Repository Component Function Identifiers* (Ref. E8.1.7). These are generally three or four characters long. Some BSC component function identifiers for typical components are shown in Table E.V-1, but in cases where there is not an equivalent match, the most appropriate PCSA type code should be used (also given in Table E.V-1).

The sequence code is a numeric sequence and train assignment (suffix), if appropriate, that uniquely identifies components within the same area, system, and component function.

If an HFE is related to the failure of an individual component with an existing component function identifier and sequence code, the naming scheme should utilize these codes in the event name. If an HFE is such that these codes do not apply, the basic event name can be a free form field for describing the nature of the event, such as HCSKSCF for operator topples cask during scaffold movement or HFCANLIDAJAR for operator leaves canister lid ajar, utilizing either seven characters when there is a relevant system locator code, or 12 characters when no system codes are applicable.

The human failure type and failure mode codes are three characters each, consistent with the coding provided in Table E.V-1 below.

For HFEs, the type code always begins with HF and continues with a one letter designator for the HFE temporal phase: P for pre-initiator, I for human-induced initiator, N for non-recovery post-initiator, R for recovery post-initiator (this latter code is not used during preliminary analysis).

Table E.V-1. Human Failure Event Type Codes and Failure Mode Codes

PRE-INITIATOR HFEs; TYP=HFP		FMC=
Fail to properly restore a standby system to service		RSS
Failure to properly restore an operating system to service when the degraded state is not easily detectable		ROH
Failure to properly restore an operating system to service when the degraded state is easily detectable		ROE
Calibration error		CAL
HUMAN-INDUCED INITIATOR HFEs; TYP=HFI		
Failure to properly conduct an operation	Operation is performed on a daily basis.	NOD
	Operation is performed on a very regular basis (on the order of once per week)	NOW
	Operation is performed only very infrequently (once per month or less)	NOM
Operation is extremely complex OR conducted under environmental or ergonomic stress	Operation is performed on a daily basis.	COD
	Operation is performed on a very regular basis (on the order of once per week)	COW
	Operation is performed only very infrequently (once per month or less)	COM

Table E.V-1. Human Failure Event Type Codes and Failure Mode Codes (Continued)

PRE-INITIATOR HFES; TYP=HFP		FMC=
Operation is extremely complex AND conducted under environmental or ergonomic stress	Operation is performed on a daily basis.	CSD
	Operation is performed on a very regular basis (on the order of once per week)	CSW
	Operation is performed only very infrequently (once per month or less)	CSM
NON-RECOVERY POST-INITIATOR HFES; TYP=HFN		
Not trained or proceduralized, time pressure		NPT
Not trained or proceduralized, no time pressure		NPN
Trained and/or proceduralized, time pressure		TPT
Trained and/or proceduralized, no time pressure		TPN
RECOVERY POST-INITIATOR HFES; TYP=HFR		
Not trained or proceduralized, time pressure		NPT
Not trained or proceduralized, no time pressure		NPN
Trained and/or proceduralized, time pressure		TPT
Trained and/or proceduralized, no time pressure		TPN

NOTE: FMC = failure mode code; HFE = human failure event; HFI = human-induced initiator HFE; HFN = human failure non-recovery post-initiator HFE; HFP = pre-initiator HFE; HFR = human failure recovery post-initiator HFE; TYP = type.

Source: Original

ATTACHMENT F
FIRE ANALYSIS

CONTENTS

	Page
ACRONYMS.....	F-7
F1 INTRODUCTION	F-8
F2 REFERENCES: DESIGN INPUTS.....	F-9
F3 BOUNDARY CONDITIONS	F-16
F3.1 INTRODUCTION	F-16
F3.2 PLANT OPERATIONAL STATE	F-16
F3.3 CREDIT FOR AUTOMATIC FIRE SUPPRESSION SYSTEMS	F-16
F3.4 NUMBER OF FIRE EVENT TO OCCUR	F-16
F3.5 IGNITION SOURCE COUNTING.....	F-16
F3.6 FIRE CABLE AND CIRCUIT FAILURE ANALYSIS	F-16
F3.7 HEATING, VENTILATION, AND AIR CONDITIONING FIRE ANALYSIS.....	F-16
F3.8 NO OTHER SIMULTANEOUS INITIATING EVENTS	F-16
F3.9 DATA COLLECTION SCOPE.....	F-17
F3.10 COMPONENT FAILURE MODES.....	F-17
F3.11 COMPONENT FAILURE PROBABILITY	F-17
F3.12 INTERNAL EVENTS PRECLOSURE SAFETY ANALYSIS MODEL	F-17
F4 ANALYSIS METHOD.....	F-18
F4.1 INTRODUCTION	F-18
F4.2 IDENTIFICATION OF INITIATING EVENTS	F-18
F4.3 QUANTIFICATION OF FIRE IGNITION FREQUENCY	F-20
F4.4 DETERMINE INITIATING EVENT FREQUENCY.....	F-22
F5 ANALYSIS.....	F-27
F5.1 INTRODUCTION	F-27
F5.2 INITIATING EVENT FREQUENCIES.....	F-27
F5.3 IGNITION SOURCE FREQUENCY	F-33
F5.4 IGNITION SOURCE DISTRIBUTION (EQUIPMENT LIST).....	F-35
F5.5 ROOM IGNITION FREQUENCY.....	F-65
F5.6 PROPAGATION PROBABILITIES.....	F-70
F5.7 INITIATING EVENT FREQUENCIES.....	F-72
F5.8 MONTE CARLO SIMULATION/UNCERTAINTY DISTRIBUTIONS	F-94
F5.9 RESULTS	F-94

CONTENTS (Continued)

	Page
APPENDIX F.I	DEFINITION OF IGNITION SOURCE CATEGORY F-99
APPENDIX F.II	DERIVATION OF IGNITION SOURCE DISTRIBUTION AND FIRE PROPAGATION PROBABILITIES F-100
APPENDIX F.III	DERIVATION OF IGNITION FREQUENCY DISTRIBUTION..... F-109
APPENDIX F.IV	PROOF OF LOGNORMAL DISTRIBUTION F-116
APPENDIX F.V	DERIVATION OF ERROR FACTORS F-118
APPENDIX F.VI	RESULTS FROM MONTE CARLO SIMULATION F-119

FIGURES

	Page
F5.7-1. Example of Crystal Ball Output for a Fire Initiating Event.....	F-98
F-III.1. Ignition Frequency Observations.....	F-109
F.III-2. Data Point Determination	F-110
F.III-3. Plot of Log(Ignition Frequency) as a Function of Log(Floor Area).....	F-112
F.III-4. Plot of Log(Ignition Frequency) as a Function of Log(Floor Area) Divided into Two Floor Area Ranges.....	F-112
F.III-5. Plot of the Ignition Frequency Data, the Predicted Ignition Frequency, and Confidence Limits for the Predicted Value	F-114

TABLES

	Page
F5.2-1. Room Areas and Total Ignition Frequency.....	F-29
F5.3-1. Ignition Frequency by Ignition Source	F-34
F5.4-1. Ignition Source Population by Room.....	F-36
F5.5-1. Fire Ignition Frequencies by Room	F-66
F5.6-1. Fire Propagation Probabilities.....	F-71
F5.7-1. TAD Residence Fractions	F-74
F5.7-2. HLW and DOE-SNF Residence Fractions	F-79
F5.7-3. DPC Residence Fractions	F-83
F5.7-4. Localized Fire Initiating Event Frequencies	F-87
F5.7-5. Localized Fire Initiating Events with Multiple Rooms of Origin.....	F-92
F5.7-6. Large Fire Initiating Event Frequencies	F-93
F5.7-7. Fire Initiating Events Results Summary	F-96
F.I-1. Definition of Ignition Source Category	F-99
F.II-1. Fires in Radioactive Material Working Facilities by Originating Equipment.....	F-100
F.II-2. Structure Fires in Radioactive Material Working Facilities and Nuclear Energy Plants of Non-Combustible Construction and in which No Automatic Suppression System Was Present or the Automatic Suppression System Failed to Operate.....	F-101
F.II-3. Structure Fires in Radioactive Material Working Facilities and Nuclear Energy Plants of Non-Combustible Construction and in which the Fire Was Too Small to Activate the Automatic Suppression System or the Automatic System Operated Properly	F-101
F.II-4. t-Distribution Value	F-102
F.II-5. Margin of Error Results at 95% Confidence Interval for Fires in Radioactive Material Working Facilities by Originating Equipment	F-104
F.II-6. Margin of Error Results at 99% Confidence Interval for Fires in Radioactive Material Working Facilities by Originating Equipment	F-104
F.II-7. Margin of Error Results at 95% Confidence Interval for Structure Fires in Radioactive Material Working Facilities and Nuclear Energy Plants of Non- Combustible Construction and in which No Automatic Suppression System Was Present or the Automatic Suppression System Failed to Operate	F-105

TABLES (Continued)

	Page
F.II-8. Margin of Error Results at 99% Confidence Interval for Structure Fires in Radioactive Material Working Facilities and Nuclear Energy Plants of Non-Combustible Construction and in which No Automatic Suppression System Was Present or the Automatic Suppression System Failed to Operate	F-106
F.II-9. Margin of Error Results at 95% Confidence Interval for Structure Fires in Radioactive Material Working Facilities and Nuclear Energy Plants of Non-Combustible Construction and in which the Fire Was Too Small to Activate the Automatic Suppression System or the Automatic System Operated Properly.....	F-107
F.II-10. Margin of Error Results at 99% Confidence Interval for Structure Fires in Radioactive Material Working Facilities and Nuclear Energy Plants of Non-Combustible Construction and in which the Fire Was Too Small to Activate the Automatic Suppression System or the Automatic System Operated Properly.....	F-108
F.III-1. Ignition Frequency Data from Figure F.III-1 and Equation F.III-1	F-111
F.III-2. Calculated Mean and Confidence Limits for the YMP Facility Ignition Frequency.....	F-115
F.IV-1. Comparison Between Crystal Ball and Excel Percentile Intervals.....	F-117

ACRONYMS

CRCF	Canister Receipt and Closure Facility
DCMIS	digital control and management information system
DOE	U.S. Department of Energy
HEPA	high-efficiency particulate air
HLW	high-level radioactive waste
HVAC	heating, ventilation, and air conditioning
MCC	motor control center
NFPA	National Fire Protection Association
PCSA	preclosure safety analysis
PRA	probabilistic risk assessment
RF	Receipt Facility
RWF	residence weighting factor
SNF	spent nuclear fuel
TAD	transportation, aging, and disposal
WPTT	waste package transfer trolley
YMP	Yucca Mountain Project

F1 INTRODUCTION

This document describes the work scope, definitions and terms, method, and results for the fire analysis performed as a part of the Yucca Mountain Project (YMP) preclosure safety analysis (PCSA). Fire analysis is divided into four major areas:

- Initiating event identification
- Initiating event quantification (including both ignition frequency and propagation probability)
- Fragility analysis (including convolution of fragility and hazard curves)
- Fire analysis model development and quantification.

Within the task, the internal events PCSA model is evaluated, with respect to fire initiating events, and modified as necessary to address fire-induced failures that lead to exposures. The lists of fire-induced failures that are included in the model are evaluated as to fire vulnerability, and fragility analyses are conducted as needed.

F2 REFERENCES: DESIGN INPUTS

The PCSA is based on a snapshot of the design. The reference design documents are appropriately documented as design inputs in this section. Since the safety analysis is based on a snapshot of the design, referencing subsequent revisions to the design documents (as described in EG-PRO-3DP-G04B-00037, *Calculations and Analyses* (Ref. 2.1.1, Section 3.2.2.F)) that implement PCSA requirements flowing from the safety analysis would not be appropriate for the purpose of the PCSA.

The inputs in this Section noted with an asterisk (*) indicate that they fall into one of the designated categories described in Section 4.1, relative to suitability for intended use.

- F2.2.1 ANSI/ANS (American National Standards Institute/American Nuclear Society) 58.23-2007. *Fire PRA Methodology*. La Grange Park, Illinois: American Nuclear Society. TIC: 259894
- F2.2.2 ASME (American Society of Mechanical Engineers) RA-S-2002. *Standard for Probabilistic Risk Assessment for Nuclear Power Plant Applications*. New York, New York: American Society of Mechanical Engineers. TIC: 255508. ISBN: 0-7918-2745-3.
- F2.2.3 *BSC (Bechtel SAIC Company) 2007. *Preliminary Throughput Study for the Canister Receipt and Closure Facility*, 060-30R-CR00-00100-000-001, Las Vegas, Nevada. Bechtel SAIC Company Inc., ACC: ENG.20071101.0001.
- F2.2.4 *BSC 2007. *Preliminary Throughput Study for the Receipt Facility*, 200-30R-RF00-00300-000 REV 002, Las Vegas, Nevada. Bechtel SAIC Company Inc., ACC: ENG.20071227.0021.
- F2.2.5 BSC 2007. *Waste Form Throughputs for Preclosure Safety Analysis*, 000-PSA-MGR0-01800-000-00A. Las Vegas, Nevada. Bechtel SAIC Company, ACC: ENG.20071106.0001.
- F2.2.6 BSC 2007. *Canister Receipt & Closure Facility #1 Equipment Layout Second Floor*. 060-E40-EEN0-00201-000-00A. Las Vegas, Nevada. Bechtel SAIC Company ACC: ENG.20070821.0012.
- F2.2.7 *BSC 2007. *Canister Receipt & Closure Facility #1 Equipment Layout Second Floor*. 060-E40-EEN0-00202-000-00A. Las Vegas, Nevada. Bechtel SAIC Company ACC: ENG.20070821.0013.
- F2.2.8 *BSC 2007. *Canister Receipt & Closure Facility #1 Equipment Layout Second Floor*. 060-E40-EEN0-00203-000-00A. Las Vegas, Nevada. Bechtel SAIC Company ACC: ENG.20070821.0014.
- F2.2.9 *BSC 2007. *Canister Receipt & Closure Facility #1 Equipment Layout Second Floor*. 060-E40-EEN0-00204-000-00A. Las Vegas, Nevada. Bechtel SAIC Company ACC: ENG.20070821.0015.

- F2.2.10 BSC 2007. *Canister Receipt & Closure Facility #1 ITS Train "A" Electrical Room Equipment Layout.* 060-E40-EEE0-00101-000-00A. Las Vegas, Nevada. Bechtel SAIC Company ACC: ENG.20070821.0003.
- F2.2.11 BSC 2007. *Canister Receipt & Closure Facility #1 ITS Train "B" Electrical Room Equipment Layout.* 060-E40-EEE0-00201-000-00A. Las Vegas, Nevada. Bechtel SAIC Company ACC: ENG.20070821.0004.
- F2.2.12 *BSC 2007. *Canister Receipt & Closure Facility #1 Normal Electrical Room Equipment Layout.* 060-E40-EEN0-00101-000-00A. Las Vegas, Nevada. Bechtel SAIC Company ACC: ENG.20070821.0005.
- F2.2.13 BSC 2008. *Canister Receipt and Closure Facility 1 General Arrangement Ground Floor Plan.* 060-P10-CR00-00102-000-00C. Las Vegas, Nevada. Bechtel SAIC Company ENG.20080122.0013.
- F2.2.14 BSC 2008. *Canister Receipt and Closure Facility 1 General Arrangement Second Floor Plan.* 060-P10-CR00-00103-000-00C. Las Vegas, Nevada. Bechtel SAIC Company ENG.20080122.0014.
- F2.2.15 BSC 2007. *Canister Receipt and Closure Facility 1 General Arrangement Third Floor Plan.* 060-P10-CR00-00104-000-00B. Las Vegas, Nevada. Bechtel SAIC Company ENG.20071212.0005.
- F2.2.16 *BSC 2008. *CRCF 1 480V Load Center 060-EEN0-LC-00001 Single Line Diagram.* 060-E10-EEN0-00101-000-00C. Las Vegas, Nevada. Bechtel SAIC Company ACC: ENG.20080208.0014.
- F2.2.17 *BSC 2007. *CRCF 1 480V Load Center 060-EEN0-LC-00002 Single Line Diagram.* 060-E10-EEN0-01001-000-00B. Las Vegas, Nevada. Bechtel SAIC Company ACC: ENG.20071129.0015.
- F2.2.18 *BSC 2008. *CRCF 1 480V Load Center 060-EEN0-LC-00003 Single Line Diagram.* 060-E10-EEN0-01101-000-00B. Las Vegas, Nevada. Bechtel SAIC Company ACC: ENG.20080208.0015.
- F2.2.19 BSC 2007. *CRCF 1 480V ITS MCC – Train A 060-EEE0-MCC-00001 Single Line Diagram.* 060-E10-EEE0-00101-000-00B. Las Vegas, Nevada. Bechtel SAIC Company ACC: ENG.20071129.0002.
- F2.2.20 BSC 2007. *CRCF 1 480V ITS MCC – Train B 060-EEE0-MCC-00002 Single Line Diagram.* 060-E10-EEE0-00201-000-00B. Las Vegas, Nevada. Bechtel SAIC Company ACC: ENG.20071129.0003.
- F2.2.21 BSC 2007. *CRCF 1 480V MCC 060-EEN0-MCC-00001 Single Line Diagram.* 060-E10-EEN0-00201-000-00B. Las Vegas, Nevada. Bechtel SAIC Company ACC: ENG.20071129.0007.

- F2.2.22 *BSC 2007. *CRCF 1 480V MCC 060-EEN0-MCC-00002 Single Line Diagram*. 060-E10-EEN0-00301-000-00B. Las Vegas, Nevada. Bechtel SAIC Company ACC: ENG.20071129.0008.
- F2.2.23 *BSC 2007. *CRCF 1 480V MCC 060-EEN0-MCC-00003 Single Line Diagram*. 060-E10-EEN0-00401-000-00B. Las Vegas, Nevada. Bechtel SAIC Company ACC: ENG.20071129.0009.
- F2.2.24 *BSC 2007. *CRCF 1 480V MCC 060-EEN0-MCC-00004 Single Line Diagram*. 060-E10-EEN0-00501-000-00B. Las Vegas, Nevada. Bechtel SAIC Company ACC: ENG.20071129.0010.
- F2.2.25 *BSC 2007. *CRCF 1 480V MCC 060-EEN0-MCC-00005 Single Line Diagram*. 060-E10-EEN0-00601-000-00B. Las Vegas, Nevada. Bechtel SAIC Company ACC: ENG.20071129.0011.
- F2.2.26 *BSC 2007. *CRCF 1 480V MCC 060-EEN0-MCC-00006 Single Line Diagram*. 060-E10-EEN0-00701-000-00B. Las Vegas, Nevada. Bechtel SAIC Company ACC: ENG.20071129.0012.
- F2.2.27 *BSC 2007. *CRCF 1 480V MCC 060-EEN0-MCC-00007 Single Line Diagram*. 060-E10-EEN0-00801-000-00B. Las Vegas, Nevada. Bechtel SAIC Company ACC: ENG.20071129.0013.
- F2.2.28 *BSC 2007. *CRCF 1 480V MCC 060-EEN0-MCC-00008 Single Line Diagram*. 060-E10-EEN0-00901-000-00B. Las Vegas, Nevada. Bechtel SAIC Company ACC: ENG.20071129.0014.
- F2.2.29 *BSC 2007. *CRCF 1 480V MCC 060-EEN0-MCC-00009 Single Line Diagram*. 060-E10-EEN0-01201-000-00A. Las Vegas, Nevada. Bechtel SAIC Company ACC: ENG.20071129.0017.
- F2.2.30 BSC 2007. *CRCF 1 480V MCC 060-EEN0-MCC-00010 Single Line Diagram*. 060-E10-EEN0-01301-000-00A. Las Vegas, Nevada. Bechtel SAIC Company ACC: ENG.20071129.0018.
- F2.2.31 *BSC 2007. *CRCF 1 480V MCC 060-EEN0-MCC-00011 Single Line Diagram*. 060-E10-EEN0-01401-000-00A. Las Vegas, Nevada. Bechtel SAIC Company ACC: ENG.20071129.0019.
- F2.2.32 *BSC 2007. *CRCF 1 480V MCC 060-EEN0-MCC-00012 Single Line Diagram*. 060-E10-EEN0-01501-000-00A. Las Vegas, Nevada. Bechtel SAIC Company ACC: ENG.20071129.0020.
- F2.2.33 *BSC 2007. *CRCF 1 480V MCC 060-EEN0-MCC-00013 Single Line Diagram*. 060-E10-EEN0-01601-000-00A. Las Vegas, Nevada. Bechtel SAIC Company ACC: ENG.20071129.0021.

- F2.2.34 *BSC 2007. *CRCF 1 Chilled Water System Piping & Instrument. Diagram.* 060-M60-PSC0-00101-000-00A. Las Vegas, Nevada. Bechtel SAIC Company ACC: ENG.20070918.0005.
- F2.2.35 *BSC 2007. *CRCF 1 Composite Vent Flow Diagram Non-Confinement Non-ITS HVAC Systems. Support & Operations.* 060-M50-VNI0-00101-000-00A. Las Vegas, Nevada. Bechtel SAIC Company ACC: ENG.20070802.0001.
- F2.2.36 BSC 2007. *CRCF 1 Composite Vent Flow Diagram Tertiary Conf ITS Exhaust & Non-ITS HVAC Supply Systems.* 060-M50-VCT0-00101-000-00B. Las Vegas, Nevada. Bechtel SAIC Company ACC: ENG.20071227.0013.
- F2.2.37 *BSC 2007. *CRCF 1 Composite Vent Flow Diagram Tertiary Confinement Non-ITS Exhaust & HVAC Supply Systems.* 060-M50-VCT0-00102-000-00B. Las Vegas, Nevada. Bechtel SAIC Company ACC: ENG.20071227.0014.
- F2.2.38 BSC 2007. *CRCF 1 Composite Vent Flow Diagram Tertiary Confinement Ground Floor HVAC Systems.* 060-M50-VCT0-00201-000-00B. Las Vegas, Nevada. Bechtel SAIC Company ACC: ENG.20071227.0015.
- F2.2.39 *BSC 2007. *CRCF 1 Composite Vent Flow Diagram Tertiary Confinement Non- ITS HVAC System Supply & Exhaust.* 060-M50-VCT0-00301-000-00B. Las Vegas, Nevada. Bechtel SAIC Company ACC: ENG.20071227.0016.
- F2.2.40 BSC 2007. *CRCF 1 Composite Vent Flow Diagram Tertiary Confinement ITS HVAC Systems. Elect & Battery RMS.* 060-M50-VCT0-00401-000-00A. Las Vegas, Nevada. Bechtel SAIC Company ACC: ENG.20070828.0019.
- F2.2.41 *BSC 2007. *CRCF 1 Confinement Utility Room HVAC System Ventilation & Instrumentation Diagram.* 060-M80-VCT0-00109-000-00A. Las Vegas, Nevada. Bechtel SAIC Company ACC: ENG.20071227.0002.
- F2.2.42 *BSC 2007. *CRCF 1 Confinement 2nd Floor North Areas HVAC Supply System Ventilation & Instrumentation Diagram.* 060-M80-VCT0-00202-000-00A. Las Vegas, Nevada. Bechtel SAIC Company ACC: ENG.20070904.0019.
- F2.2.43 *BSC 2007. *CRCF 1 Confinement 2nd Floor South HVAC Supply System Ventilation & Instrumentation Diagram.* 060-M80-VCT0-00205-000-00A. Las Vegas, Nevada. Bechtel SAIC Company ACC: ENG.20070904.0022.
- F2.2.44 *BSC 2007. *CRCF 1 Confinement Canister Transfer Room HVAC Supply System Ventilation & Instrumentation Diagram.* 060-M80-VCT0-00201-000-00B. Las Vegas, Nevada. Bechtel SAIC Company ACC: ENG.20071227.0006.
- F2.2.45 BSC 2007. *CRCF 1 Confinement Cask Prep Room HVAC Supply System Ventilation & Instrumentation Diagram.* 060-M80-VCT0-00105-000-00A. Las Vegas, Nevada. Bechtel SAIC Company ACC: ENG.20070829.0021.

- F2.2.46 *BSC 2007. *CRCF 1 Confinement Ground Floor Non-ITS HEPA Exhaust System Ventilation & Instrumentation Diagram*. 060-M80-VCT0-00113-000-00B. Las Vegas, Nevada. Bechtel SAIC Company ACC: ENG.20071227.0005.
- F2.2.47 *BSC 2007. *CRCF 1 Confinement Ground Flr North Areas HVAC Supply System Ventilation & Instrumentation Diagram*. 060-M80-VCT0-00107-000-00B. Las Vegas, Nevada. Bechtel SAIC Company ACC: ENG.20071227.0001.
- F2.2.48 *BSC 2007. *CRCF 1 Confinement Ground Flr South Areas HVAC Supply System Ventilation & Instrumentation Diagram*. 060-M80-VCT0-00111-000-00A. Las Vegas, Nevada. Bechtel SAIC Company ACC: ENG.20070910.0012.
- F2.2.49 BSC 2007. *CRCF 1 Confinement ITS Battery Room Exhaust System – Train A Ventilation & Instrumentation Diagram*. 060-M80-VCT0-00402-000-00C. Las Vegas, Nevada. Bechtel SAIC Company ACC: ENG.20071227.0011.
- F2.2.50 BSC 2007. *CRCF 1 Confinement ITS Battery Room Exhaust System – Train B Ventilation & Instrumentation Diagram*. 060-M80-VCT0-00404-000-00C. Las Vegas, Nevada. Bechtel SAIC Company ACC: ENG.20071227.0012.
- F2.2.51 BSC 2007. *CRCF 1 Confinement ITS Electrical Room HVAC System – Train A Ventilation & Instrumentation Diagram*. 060-M80-VCT0-00401-000-00B. Las Vegas, Nevada. Bechtel SAIC Company ACC: ENG.20071119.0023.
- F2.2.52 BSC 2007. *CRCF 1 Confinement ITS Electrical Room HVAC System – Train B Ventilation & Instrumentation Diagram*. 060-M80-VCT0-00403-000-00B. Las Vegas, Nevada. Bechtel SAIC Company ACC: ENG.20071119.0025.
- F2.2.53 *BSC 2007. *CRCF 1 Confinement LLW & Misc. Areas HVAC Supply System Ventilation & Instrumentation Diagram*. 060-M80-VCT0-00301-000-00A. Las Vegas, Nevada. Bechtel SAIC Company ACC: ENG.20070904.0025.
- F2.2.54 *BSC 2007. *CRCF 1 Confinement LLW & Misc. Areas Non-ITS HEPA Exhaust System Ventilation & Instrumentation Diagram*. 060-M80-VCT0-00303-000-00B. Las Vegas, Nevada. Bechtel SAIC Company ACC: ENG.20071227.0010.
- F2.2.55 *BSC 2007. *CRCF 1 Confinement Non-ITS Battery Room Exhaust System Ventilation & Instrumentation Diagram*. 060-M80-VCT0-00110-000-00B. Las Vegas, Nevada. Bechtel SAIC Company ACC: ENG.20071227.0003.
- F2.2.56 BSC 2007. *CRCF 1 Confinement Non-ITS HEPA Exhaust System – 2nd Floor Ventilation & Instrumentation Diagram*. 060-M80-VCT0-00207-000-00B. Las Vegas, Nevada. Bechtel SAIC Company ACC: ENG.20071227.0009.
- F2.2.57 *BSC 2007. *CRCF 1 Hot Water System Piping & Instrument. Diagram*. 060-M60-PSH0-00101-000-00A. Las Vegas, Nevada. Bechtel SAIC Company ACC: ENG.20070917.0012.

- F2.2.58 BSC 2007. *CRCF 1 ITS Confinement Areas HEPA Exhaust System - Train A Ventilation & Instrumentation Diagram*. 060-M80-VCT0-00103-000-00B. Las Vegas, Nevada. Bechtel SAIC Company ACC: ENG.20071204.0005.
- F2.2.59 BSC 2007. *CRCF 1 ITS Confinement Areas HEPA Exhaust System Train B Ventilation & Instrumentation Diagram*. 060-M80-VCT0-00104-000-00B. Las Vegas, Nevada. Bechtel SAIC Company ACC: ENG.20071204.0006.
- F2.2.60 *BSC 2007. *CRCF 1 ITS Confinement WP Loadout Room HVAC Supply System Ventilation & Instrumentation Diagram*. 060-M80-VCT0-00101-000-00A. Las Vegas, Nevada. Bechtel SAIC Company ACC: ENG.20070829.0017.
- F2.2.61 BSC 2007. *CRCF 1 ITS UPS – Train A 060-EEU0-UJX-00001 Single Line Diagram*. 060-E10-EEU0-00101-000-00B. Las Vegas, Nevada. Bechtel SAIC Company ACC: ENG.20071129.0024.
- F2.2.62 BSC 2007. *CRCF 1 ITS UPS – Train B 060-EEU0-UJX-00002 Single Line Diagram*. 060-E10-EEU0-00201-000-00B. Las Vegas, Nevada. Bechtel SAIC Company ACC: ENG.20071129.0025.
- F2.2.63 *BSC 2007. *CRCF 1 Non-Confinement Areas HVAC Supply System Ventilation & Instrumentation Diagram*. 060-M80-VNI0-00101-000-00A. Las Vegas, Nevada. Bechtel SAIC Company ACC: ENG.20070828.0020.
- F2.2.64 *BSC 2007. *CRCF 1 Non-Confinement Misc. Areas Air Distribution System Ventilation & Instrumentation Diagram*. 060-M80-VNI0-00102-000-00A. Las Vegas, Nevada. Bechtel SAIC Company ACC: ENG.20070828.0021.
- F2.2.65 *BSC 2007. *CRCF 1 Non-Confinement Site Transporter Vest. HVAC Syst Ventilation & Instrumentation Diagram*. 060-M80-VNI0-00105-000-00A. Las Vegas, Nevada. Bechtel SAIC Company ACC: ENG.20070828.0024.
- F2.2.66 *BSC 2007. *CRCF 1 Non-Confinement Transport, Cask/Annex Vest. HVAC System Ventilation & Instrumentation Diagram*. 060-M80-VNI0-00106-000-00A. Las Vegas, Nevada. Bechtel SAIC Company ACC: ENG.20070828.0025.
- F2.2.67 *BSC 2007. *CRCF 1 Non-Confinement WP Loadout Vestibule HVAC System Ventilation & Instrumentation Diagram*. 060-M80-VNI0-00104-000-00A. Las Vegas, Nevada. Bechtel SAIC Company ACC: ENG.20070828.0023.
- F2.2.68 *BSC 2007. *CRCF 1 UPS 060-EEP0-UJX-00001 Single Line Diagram*. 060-E10-EEP0-00101-000-00B. Las Vegas, Nevada. Bechtel SAIC Company ACC: ENG.20071129.0022.
- F2.2.69 *BSC 2007. *CRCF 1 UPS 060-EEP0-UJX-00002 Single Line Diagram*. 060-E10-EEP0-00201-000-00B. Las Vegas, Nevada. Bechtel SAIC Company ACC: ENG.20071129.0023.

- F2.2.70 *BSC 2007. *CRCF Cask Cavity Gas Sampling System Piping & Instrument. Diagram.* 060-M60-MRE0-00101-000-00A. Las Vegas, Nevada. Bechtel SAIC Company ACC: ENG.20070328.0008.
- F2.2.71 BSC 2007. *CRCF, RF, WHF, and IHF Cask Transfer Trolley Process and Instrumentation Diagram.* 000-M60-HM00-00301-000-00B. Las Vegas, Nevada. Bechtel SAIC Company ACC: ENG.20071119.0013.
- F2.2.72 BSC 2007. *Equipment Motor Horsepower and Electrical Requirements Analysis.* 000-M0A-H000-00100-000-00A. Las Vegas, Nevada. Bechtel SAIC Company ACC: ENG.20070816.0001.
- F2.2.73 *EPRI (Electric Power Research Institute) and NRC (Nuclear Regulatory Commission) 2005. *Detailed Methodology.* Volume 2 of *EPRI/NRC-RES Fire PRA Methodology for Nuclear Power Facilities.* EPRI TR-1011989 and NUREG/CR-6850. Palo Alto, California: Electric Power Research Institute. ACC: MOL.20070323.0062.
- F2.2.74 *EPRI and NRC 2005. *Summary & Overview.* Volume 1 of *EPRI/NRC-RES Fire PRA Methodology for Nuclear Power Facilities.* EPRI-1011989 and NUREG/CR-6850. Palo Alto, California: Electric Power Research Institute. ACC: MOL.20070323.0061.
- F2.2.75 *Ahrens, M, 2000. *Fires in or at Industrial Chemical, Hazardous Chemical, and Plastic Manufacturing Facilities: 1988 - 1997 Unallocated Annual Averages and Narratives,* Quincy, Massachusetts: National Fire Protection Association. TIC: 259997.
- F2.2.76 *Ahrens, M. 2007. *Structure Fires in Radioactive Material Working Facilities and Nuclear Energy Plants of Non-Combustible Construction, 1980-1998.* Quincy, Massachusetts: National Fire Protection Association. TIC: 259983.
- F2.2.77 *SAIC (Science Applications International Corporation) 2002. *Chemical Agent Disposal Facility Fire Hazard Assessment Methodology.* SAIC-01/2650. Abingdon, Maryland: Science Applications International Corporation. ACC: MOL.20080115.0138.
- F2.2.78 *Tillander, K. 2004. *Utilisation of Statistics to Assess Fire Risks in Buildings.* PhD Dissertation. Espoo, Finland: VTT Technical Research Centre of Finland. TIC: 259928. ISBN: 951-38-6392-1.
- F2.2.79 *Winkler, R. L., and Hays, W. L. 1975. *Statistics: Probability, Inference, and Decision.* Series in Quantitative Methods for Decision Making. 2nd Edition. Winkler, R.L., ed., New York, New York: Holt, Rinehart, and Winston. TIC:259976. ISBN: 0-03-014011-0.

F3 BOUNDARY CONDITIONS

F3.1 INTRODUCTION

The general boundary conditions used during the analysis of fire vulnerabilities and fire model development are clearly stated and documented. In general, the boundary conditions are compatible with those usually applied to fire events. The principal boundary conditions for the fire analysis are listed in the following sections:

F3.2 PLANT OPERATIONAL STATE

Initial state of the facility is normal, with each system operating within its limiting condition of operation.

F3.3 CREDIT FOR AUTOMATIC FIRE SUPPRESSION SYSTEMS

The automatic fire suppression systems, although designed to meet all requirements and standards for fire suppression systems in nuclear facilities, are considered not important to safety, and therefore no credit is taken for their operation.

F3.4 NUMBER OF FIRE EVENT TO OCCUR

The facility is analyzed to respond to one fire event at a given time. Additional fire events, as a result of independent causes or of re-ignition once a fire is extinguished are not considered.

F3.5 IGNITION SOURCE COUNTING

Ignition sources are counted in accordance with applicable counting guidance contained in NUREG/CR-6850 (Ref. F2.2.73 and Ref. F2.2.74).

F3.6 FIRE CABLE AND CIRCUIT FAILURE ANALYSIS

Unlike nuclear power plants, which depend on the continued operation of equipment to prevent fuel damage, the YMP facilities cease operating on loss of power or control. Therefore, fire damage in rooms that do not contain waste cannot result in an increased level of radiological exposure. Cable and circuit analysis in these rooms is not required.

F3.7 HEATING, VENTILATION, AND AIR CONDITIONING FIRE ANALYSIS

Heating, ventilation, and air conditioning (HVAC) is not relied upon to mitigate potential releases associated with large fire event sequences. In recognition of a large amount of fire generated, non-radiological particulates could render the HVAC filters ineffective. HVAC can be credited for localized fires unless HVAC control or power circuits are present in the area of the fire.

F3.8 NO OTHER SIMULTANEOUS INITIATING EVENTS

It is standard practice to not consider the occurrence of other initiating events (human-induced and naturally occurring) during the time span of an event sequence because (1) the probability of

two simultaneous initiating events within the time span is small, and (2) each initiating event will cease operations of the Canister Receipt and Closure Facility (CRCF), which further reduces the conditional probability of the occurrence of a second initiating event, given the first has occurred.

F3.9 DATA COLLECTION SCOPE

The fire ignition data collection and analysis are performed for locations relevant to waste handling in the facilities.

F3.10 COMPONENT FAILURE MODES

The failure mode of a structure, system, or component affected by a fire, is the most severe with respect to consequences. For example, the failure mode for a canister could be the overpressurization of a reduced-strength canister.

F3.11 COMPONENT FAILURE PROBABILITY

Fires large enough to fail waste containment components are large enough to fail all active components in the same room. Active components fail in a de-energized state for such fires.

F3.12 INTERNAL EVENTS PRECLOSURE SAFETY ANALYSIS MODEL

To implement the systems analysis guidance contained herein, the fire PCSA team uses the internal events PCSA model, which is developed concurrently with the fire PCSA. This internal events PCSA is used as the basis for the fire PCSA. The internal events PCSA is in general conformance with the American Society of Mechanical Engineers Probabilistic Risk Assessment standard (Ref. F2.2.2).

F4 ANALYSIS METHOD

F4.1 INTRODUCTION

Nuclear power plant fire risk assessment techniques, as discussed in the following sections, have limited applicability to facilities such as the CRCF or other facilities in the geologic repository operations area. The general methodological basis of this analysis is the *Chemical Agent Disposal Facility Fire Hazard Assessment Methodology*, (Ref. F2.2.77) which applies to facilities that are similar to the geologic repository operations area in that they are handling and disposal facilities for highly hazardous materials. This approach is data based, in that it utilizes actual fire ignition and fire propagation experience to determine fire initiating event frequencies. That approach has been adapted to utilize data applicable to the YMP waste handling facilities. To the extent applicable to a non-reactor facility, NUREG/CR-6850, *EPRI/NRC-RES Fire PRA Methodology for Nuclear Power Facilities, Volumes 1 and 2* (Ref. F2.2.73 and Ref. F2.2.74) are also considered in the development of this analysis method. The method complies with the applicable requirements of the American Nuclear Society fire Probabilistic Risk Assessment standard (Ref. F2.2.1) that are relevant to a nonreactor facility. Many of the definitions, modeling approximations, and requirements of these documents were used to develop this document.

F4.2 IDENTIFICATION OF INITIATING EVENTS

Current techniques in fire risk assessment for nuclear power plants focus on fire that can damage electrical and control circuits or impact other equipment that can compromise process and safety systems. This type of approach is not generally applicable to YMP because loss of electric power is a safe state, except for the need for HVAC after a release of radionuclides. In general, when systems are affected by fire, they cease to function. While at a nuclear power plant fire is of concern, at YMP fire means that fuel handling stops and initiating events capable of producing elevated levels of radioactivity are essentially unrealizable. While it is theoretically possible that a fire could inadvertently result in a drop of a cask or canister, it is difficult (if not impossible) to identify any mechanisms by which this would occur due to fire that would not be much more likely to occur by other means. Of much greater concern at YMP is the potential for a fire to directly affect the waste containers and cause a breach that would result in a release. The fire analysis, therefore, focuses on the potential for a fire to directly affect the waste containers and cause a breach that would result in a release, rather than analyzing fires that would remove power from fuel handling systems. After a release of radionuclides, the HVAC system, with its high-efficiency particulate air (HEPA) filtration, aids in the abatement of radioactivity that is released from buildings. However, the occurrence of fires tends to significantly reduce the effectiveness of HEPA filtration; the fire event sequence analysis, therefore, does not rely on this system. Consideration is given both to fires that start in rooms containing waste and fires that start in other rooms and propagate to where waste is located. The steps of this process are provided in the following sections.

F4.2.1 Identify Fire-Rated Barriers and Designate Fire Zones

The facility is broken into fire zones based on the location of fire-rated barriers. The rating of these barriers is not significant to the methodology, so all rated barriers are considered. In order

for a fire zone to exist, the penetrations, doorways, and ducts must also be limited to the perimeter of the zone. Note that a floor is always considered to be a fire barrier as long as it is solid. Zones are identified by a number, determined by the analyst, and will consist of one or more rooms.

F4.2.2 Identify the Rooms Where Waste can be Present

Each room where waste is present, even if only for a brief time, is listed. The first set of fire initiating events to be considered in the PCSA is fires that affect each of these rooms, but do not affect other rooms that could contain waste.

F4.2.3 Define Local Initiating Events

Fire ignition occurrences are identified for each room within a fire zone. The total occurrences of a fire within a room containing a waste form are composed of the occurrences of ignitions in that room plus the occurrences of ignitions in surrounding rooms within the fire zone, which propagate across room boundaries to the room containing the waste form. The locations of fire initiating events are identified in the master logic diagram.

F4.2.4 Define Large Fire Initiating Events

Traditional fire risk studies for nuclear power plants have tended to ignore large fires, arguing that the fire barriers in place will prevent such occurrences. However, actual observed historical data shows that large fires in buildings occur. Large fires are defined for this study as those that spread to encompass the entire building, as recognized in the latest fire risk guidance from *Fire PRA Methodology for Nuclear Power Facilities* (Ref. F2.2.73) and *Summary & Overview*. EPRI TR-1011989 and NUREG/CR-6850 (Ref. F2.2.74, Volume 1, Section 11.5.4, for example). There, potential large fire initiating events are identified. The general approach follows.

Except during the short time that waste forms are being lifted by a canister transfer machine, in the YMP facilities, waste forms are located on the ground floor. Continuing with the focus on rooms that contain waste forms, large fires may be divided two ways. One is associated with fires that start on the ground floor and spread to the entire building. The other is a fire that starts anywhere else in the building and spreads to the entire building.

As a practical analysis technique, any fire that spreads out of a fire area is considered a large fire.

F4.3 QUANTIFICATION OF FIRE IGNITION FREQUENCY

The quantification of initiating event frequency involves three steps. First, the overall frequency of fire ignition for the facility is determined, then that frequency is allocated to the individual room in the facility based on the number and types of ignition sources in the rooms. Types of ignition sources are characterized in general terms such as mechanical, electrical, combustible liquid. Finally, propagation probabilities are applied to determine the overall frequency that a fire reaches the area of the waste. Quantification uses data from the following sources for equipment ignition frequencies and conditional probabilities of propagation:

- *Detailed Methodology*, Volume 2 of *EPRI/NRC-RES Fire PRA Methodology for Nuclear Power Facilities*. (Ref. F2.2.73)
- *Summary & Overview*, Volume 1 of *EPRI/NRC-RES Fire PRA Methodology for Nuclear Power Facilities*. (Ref. F2.2.74)
- *Fires in or at Industrial Chemical, Hazardous Chemical, and Plastic Manufacturing Facilities: 1988 - 1997 Unallocated Annual Averages and Narratives* (Ref. F2.2.75)
- *Structure Fires in Radioactive Material Working Facilities and Nuclear Energy Plants of Non-Combustible Construction, 1980-1998* (Ref. F2.2.76)
- *Chemical Agent Disposal Facility Fire Hazard Assessment Methodology* (Ref. F2.2.77)
- *Utilisation of Statistics to Assess Fire Risks in Buildings* (Ref. F2.2.78).

F4.3.1 Determine the Overall Facility Fire Frequency

There is insufficient data available regarding the total frequency of fires in facilities comparable to YMP. NUREG/CR-6850 (Ref. F2.2.73 and Ref. F2.2.74) provides an overall frequency for a typical nuclear power plant, but these are much larger and complex than the YMP facilities. Therefore, it has been decided to use a more generic fire ignition frequency approach that relates building size to total fire frequency for various broad categories of facilities (*Utilisation of Statistics to Assess Fire Risks in Buildings* (Ref. F2.2.78)). This approach applies the following equation to overall fire ignition frequency.

Determine the Fire Frequency per Unit Area – The frequency per unit area is expressed by Equation F-1:

$$f_m(A) = c_1 A^r + c_2 A^s \quad (\text{Eq. F-1})$$

where f_m is the fire ignition frequency per $\text{m}^2\text{-yr}$, A is the floor area (in m^2) and c_1 , c_2 , r , and s are coefficients that were determined from historical data observations for different types of facilities.

For industrial buildings, the parameter values are as follows in Equation F-2:

$$c_1 = 3 \times 10^{-4}; c_2 = 5 \times 10^{-6}; r = -0.61; \text{ and } s = -0.05 \quad (\text{Eq. F-2})$$

This first equation relates the frequency per unit area to the total area of the facility. This correlation was determined from the historical data, which showed that total fire frequency was not linearly related to the size of the facility. Rather, the frequency per unit area was affected by the size of the facility, and the larger the facility the lower the frequency per unit area was.

Determine the Total Fire Frequency for the Facility – The total frequency of fire ignition for the building is thus represented by the Equation F-3:

$$f_{\text{fire}} = f_m(A) * A \quad (\text{Eq. F-3})$$

F4.3.2 Determine the Fire Ignition Frequency in Each Room

The approach to allocating the fire ignition frequency is based on the approach used in Ref. F2.2.73, Ref. F2.2.74, and Ref. F2.2.77. Both of these approaches determine the fraction of the total facility ignition frequency associated with various categories of equipment (i.e., ignition source category), then determine a facility-specific ignition frequency for each piece of equipment in each category, and then determine the total ignition frequency in the room based on the ignition source population in the room.

F4.3.2.1 Fraction of Fire Ignition Frequency Associated with Each Ignition Source Category

NUREG/CR-6850 (Ref. F2.2.73 and Ref. F2.2.77) has data for these frequencies for chemical process plants. Neither of these data sets is the best for the facilities at YMP. Therefore, the National Fire Protection Association (NFPA) was requested to provide an analysis (Ref. F2.2.76) of the data in their proprietary database on the distribution of fires by equipment type in all nuclear facilities of non-combustible construction. NFPA distinguishes between a large number of equipment types that can cause ignition of a fire. There is an insufficient amount of data to justify retaining this number of equipment types, so the equipment types were consolidated into a set of ignition source categories. These categories are defined in Appendix F.I.

Using the data by category, an analysis is performed to determine the fraction of fires that are caused by each category. That analysis is documented in Appendix F.II.

The total fire ignition frequency from Section F4.3.1 is multiplied by each of these factors to determine the total fire ignition frequency due to each equipment type. For example, the total ignition frequency due to electrical equipment for a given facility as follows in Equation F-4:

$$f_{\text{elec-all}} = f_{\text{fire}} * 0.086 \quad (\text{Eq. F-4})$$

F4.3.2.2 Individual Ignition Source Fire Ignition Frequency

The next step is to determine the fire ignition frequency from each piece of equipment in each category. As is done in NUREG/CR-6850 (Ref. F2.2.73 and Ref. F2.2.74) and *Chemical Agent Disposal Facility Fire Hazard Assessment Methodology* (Ref. F2.2.77), the frequency contribution for each equipment type is divided by the total number of pieces of equipment in the facility. For example, in the case following from the above example for the frequency of fire

ignition from electrical equipment, if there are 50 pieces of electrical equipment in the facility, the ignition frequency for each piece of equipment follows in Equation F-5:

$$f_{\text{elec-each}} = f_{\text{elec-all}} / 50 \quad (\text{Eq. F-5})$$

For the case of the category “no equipment involved” the ignition frequency is per unit area, so the total for this category is divided by the total floor area of the facility (which was already determined in Section F4.3.1).

F4.3.2.3 Allocation of Fire Ignition Frequency to Each Room

The final step is to use the per equipment values to allocate fire frequency to each room. This is done by counting the number of ignition sources of each type contained in each room, multiplying by the ignition frequency for each ignition source type, and summing across all types. For example, if Room 1 has six pieces of electrical equipment, then the ignition frequency in that room due to electrical equipment is as follows in Equation F-6:

$$f_{\text{elec-1}} = f_{\text{elec-each}} * 6 \quad (\text{Eq. F-6})$$

Determining this frequency for each ignition source type (including multiplying the “no equipment involved” per unit area by the floor area of the room) and summing them together yields the total fire ignition frequency for the room, as follows in Equation F-7:

$$f_1 = f_{\text{elec-1}} + f_{\text{hvac-1}} + f_{\dots-1} \quad (\text{Eq. F-7})$$

F4.4 DETERMINE INITIATING EVENT FREQUENCY

The definition of each initiating event includes the implicit condition that the fire actually threatens a target that contains radioactive material. Therefore, for each initiating event, the initiating event frequency considers two aspects; the fraction of time there is a waste container in the room, and the probability a fire propagates to that waste container.

F4.4.1 Probability of Presence of a Target

The probability of the presence of a target waste form is the fraction of time that the waste form(s) is in the area affected by the fire (e.g., for a room fire it is the fraction of time a waste form is in the room). For use in initiating event frequency equations, the probability is represented as follows:

- P_{wri} = probability that a particular waste form is in room i during the preclosure period
- P_{wzi} = probability that a particular waste form is in zone i during the preclosure period
- P_{wfi} = probability that a particular waste form is on floor i during the preclosure period
- P_{wb} = probability that a particular waste form is in the building during the preclosure period/

The specific phrasing is noted. This probability pertains to each individual waste form (i.e., one of the approximately 11,000 waste forms that are handled at YMP). For example, if each waste form that passes through the CRCF spends 60 minutes in the canister transfer room, the probability that it is present when a fire occurs is $60 \text{ min} / (50 \text{ yrs} \times 8760 \text{ hrs/yr} \times 60 \text{ min/hr})$. This probability is used to correct the final initiating event frequency for fires (normally expressed as per year) to be per operation over the preclosure period so that it is equivalent to the other internal initiating events (e.g., drops) and can be multiplied by the number of operations in same manner.

F4.4.2 Probability of Propagation to a Target

Of key interest for assessing the fire risk, is the extent to which fires that start in a “benign” area can spread to sensitive areas (i.e., areas where nuclear waste is present). The likelihood of fire propagation within the building is strongly dependent on the building construction and the presence of automatic fire suppression systems.

Both probabilities of exceedance and conditional probabilities were determined. The probabilities of exceedance are the probabilities that a fire propagates up to a specified limit or beyond. The conditional probabilities are probabilities that a fire spreads to a specified limit.

Probabilities of exceedance are not independent, but rather represent the total probability that a fire spreads up to the specified limit or beyond. These values are provided because, for many fire sequences there will only be one case of interest, (i.e., there is only one target of concern, and once the fire reaches that target the fact that the fire may propagate even further does not change the outcome of the sequence in terms of release). For example, this value could be applied to a case where a fire that spreads throughout a room affects the waste form in that room, and there are no additional waste forms in adjacent rooms or fire zones.

Conditional probabilities are independent, as they represent the probability that a fire spreads to precisely the specified limit. These values are provided to address those cases where the extent of propagation will define the number of targets involved in the fire. For example, these values are applied when a fire that spreads throughout a room affects a waste form in that room; but if it spreads to adjacent rooms, additional forms are involved.

There are two types of propagation that are considered; propagation within a room and propagation between rooms.

F4.4.2.1 Fire Propagation Within Rooms

An important consideration in the fire risk assessment is propagation within a given room. This is referred to as “in-room propagation.” Propagation within the room is important for fires initiated in a room where waste is present. In this case, the question is whether the fire, which can ignite wherever there is an ignition source in the room, reaches the area within the room in which the waste is located.

This section provides a table with the in-room propagation values for the cases with and without automatic fire suppression systems functioning. To use this table to determine whether the fire

spreads sufficiently to threaten waste forms, it is necessary to consider where the fire occurs in the room of interest. The steps in this process are as follows:

- Determine the distribution of the ignition sources (identified under Section F4.3.2.3) within the room by counting the total number of potential ignition sources that are “at,” “near,” or “far from” the target waste form.¹
- Calculate the fraction of ignition sources “at,” “near,” and “far from” the target waste form by dividing the number at each location by the total in the room.
- Calculate the frequency of the fire reaching the waste form using the Equation F-8:

$$f_{ier-i} = P_{wri} [f_i (FR_a + (FR_n \times (P_{pc} + P_{rc})) + (FR_f \times P_{rc}))] \quad (\text{Eq.F-8})$$

where

f_{ier-i}	=	frequency of fire affecting waste form, i-th room
P_{wri}	=	probability that a waste form is in the i-th room
f_i	=	frequency of ignition, i-th room
FR_a	=	fraction of ignition sources at the waste form
FR_n	=	fraction of ignition sources near the waste form
P_{pc}	=	conditional probability for fire confined to part of room of origin
FR_f	=	fraction of ignition sources far from the waste form
P_{rc}	=	conditional probability for confined to room of origin

The values for P_{pc} and P_{rc} in the previous equation were developed from the analysis performed by NFPA (Ref. F2.2.76). The derivation of the values is provided in Appendix F.II for two cases (automatic fire suppression available and automatic fire suppression unavailable). The frequency f_i is the sum of frequencies of ignition of all ignition sources in the room. The fraction of ignition sources at, near, and far from the waste form was developed from equipment layout drawings such as:

- *Canister Receipt & Closure Facility #1 ITS Train “A” Electrical Room Equipment Layout* (Ref. F2.2.10)
- *Canister Receipt and Closure Facility 1 General Arrangement Ground Floor Plan* (Ref. F2.2.13).

¹ In the context of this method, an ignition source within a few feet of the waste source is “at” the source, whereas an ignition source beyond this distance, but within a few yards of the waste source is “near” the source. Ignition sources more that a few yards distant would be “far from” the waste source. This definition coordinates with the fire response model given in Attachment D.

F4.4.2.2 Fire Propagation Beyond Rooms

This section provides propagation probabilities for fires spreading beyond the room in which they start. This type of propagation is referred to as “ex-room propagation.”

This section provides a table with the ex-room propagation values for the cases with and without automatic fire suppression systems functioning. To use this table to determine whether the fire spreads sufficiently to threaten waste forms, it is necessary to consider the various rooms where the fire could start and spread to the extent defined by the initiating event. The steps in this process are as follows:

- For each initiating event, identify all of the rooms within the area defined by the initiating event. For example, for a fire involving a specific fire zone, list all the rooms in that zone. For a fire involving an entire floor, list all the rooms on the floor. For a fire involving the entire building, list all rooms in the building.
- For each room, calculate the probability that a fire that starts within the room is not confined to the next smaller fire initiating event but is confined to less than the definition of the next largest initiating event by multiplying the ignition frequency for the room by the conditional probability (or sum of conditional probabilities) that the fire spreads at least as far as defined, but no further. For example, for a fire involving a floor where there is also an initiating event for a fire involving a zone on the floor and an initiating event involving the entire building (multiple floors or beyond), Equation F-9 is used:

$$f_{ief-fj-ri} = f_i \times P_{fc} \quad (\text{Eq. F-9})$$

where

- $f_{ief-fj-ri}$ = frequency of fire in zone j starting in room i
- f_i = frequency of ignition, i-th room
- P_{fc} = conditional probability for fire confined to the floor of origin

Similarly, for a fire involving a floor where there is an initiating event for a fire in a zone on the floor and no specific initiating event for a fire involving the entire building Equation F-10 is used:

$$f_{ief+-ri} = f_i \times (P_{fc} + P_{bc} + P_{b+c}) \quad (\text{Eq. F-10})$$

where

$f_{ief+-ri}$	=	frequency of fire involving an entire floor or greater starting in room i
f_i	=	frequency of ignition, i -th room
P_{fc}	=	conditional probability for fire confined to floor of origin
P_{bc}	=	conditional probability for fire confined to building of origin
P_{b+c}	=	conditional probability for fire extending beyond building of origin ² .

The total fire frequency of the defined severity is the sum across all rooms relevant to the initiating event, as discussed above.

F4.4.3 Initiating Event Frequency

The final initiating event frequency is determined by multiplying the frequency of the fire reaching the waste form (in occurrences over the 50-year preclosure period) times the probability that a waste form is present (fraction of time over the 50-year preclosure period per waste form) times 50 (years/preclosure period). This yields the initiating event frequency for a fire of a specific severity affecting a waste form, per waste form processed, over the preclosure period.

² Note that the definition of a fire extending beyond the building of origin does not imply that the fire crosses some distance to affect other buildings or objects, but rather that the fire (i.e., flame damage) affects the outside surfaces of the building and items attached thereto.

F5 ANALYSIS

F5.1 INTRODUCTION

Fire initiating event frequencies have been calculated for each initiating event identified for the CRCF. This section details the analysis performed to determine these frequencies, using the methodology documented in Section F4. The following discussion of the analysis presupposes that the reader has developed a thorough understanding of the details of that methodology, as those details are not repeated in this section. The tables presented in this section, unless otherwise noted, are images of the actual spreadsheets used to perform the calculations. Therefore, there are no typographical errors in the translation of the results of the calculations into this report. The spreadsheet cells are color-coded to aid the analyst. Green numbers indicate values that are input by the analyst specific to the facility. Black numbers result from “off-line” calculations performed for this study. That is, they are facility-specific parameters whose values were determined as part of this analysis, but are not directly linked to the cell (i.e., they needed to be entered by the analyst). The source for these values is indicated in the text description of the spreadsheet. Orange numbers are values based on the analysis of operational experience (e.g., NFPA data), and should generally not be changed unless the analysis of operational experience changes or is updated. Red numbers are calculated values and should never be changed by the analyst. Green shaded cells are parameters that are assigned distributions that are used for the Crystal Ball Monte Carlo simulation runs discussed in Section F5.8. The aqua shaded cells are the final initiating event frequencies. The values shown in the cells are the baseline, point estimate values. The Monte Carlo simulation runs convert these values into distributions for use in the event sequence quantification.

F5.2 INITIATING EVENT FREQUENCIES

Fire ignition frequencies are based upon the total floor area of the building. Thus, the assessment of the area of each room of the CRCF is the first step in obtaining initiating event frequencies. Table F5.2-1 shows the calculations that were performed to identify individual room areas, total ignition frequency, and uncertainty distributions.

F5.2.1 Room Area

Dimensions for room area calculations were obtained from the following CRCF general layout drawings:

- *Canister Receipt and Closure Facility 1 General Arrangement Ground Floor Plan* (Ref. F2.2.13)
- *Canister Receipt and Closure Facility 1 General Arrangement Second Floor Plan* (Ref. F2.2.14)
- *Canister Receipt and Closure Facility 1 General Arrangement Third Floor Plan* (Ref. F2.2.15).

In some cases, the dimension intervals shown on the general arrangement drawings matched the boundaries of the rooms. Where this was the case these values were used to define the dimensions of the rooms. In cases where these (the dimension intervals) did not accurately represent a room, the drawing scale and a straightedge was utilized to determine the dimensions. The length and width figures obtained were entered into the L1 (ft) and L2 (ft) columns of Table F5.2-1 and multiplied to produce the area in square feet. Rooms 1015 and 2004 occupy two floors of building space. The area obtained for these rooms was doubled to account for this. Similarly, rooms 1026, 1044, 1047, and 1049 occupy three floors of building space, and the area for these rooms was tripled. Rooms 1005B, 1005C, 1005D, 1005F, 1005G, 1005H, 1012, 1026, 1028, 1033, 1035, 1211-1213 and 1215 to 1222, 2001, 2005, 2006K, 2008, 2045, 2045A, 3045, and 3045A are not of a standard rectangular shape whose area can be calculated by a single length and width. Thus, these rooms were divided into two to three rectangles, each with a determined length and width. Addition of the area of these rectangles provides the total room area. Rooms 1007, 1013, 1045, 1047A, 1049A, 2003, and 2007 contain smaller room(s) within themselves. To account for this, the red text indicates a reference to the cells that contain the dimensions of the smaller room(s), the area of which is subtracted from the area of the room containing it. All areas calculated in square feet were multiplied by 0.09290304 to obtain the area in square meters, since Equation F-1 is based in square meters.

Table F5.2-1. Room Areas and Total Ignition Frequency

Room	L1(ft)	L2(ft)	A(sq-ft)	A(sq-m)	L3 (ft)	L4(ft)	L5(ft)	L6(ft)	L7(ft)	L8(ft)
1001	76	33	2508	233						
1001A	38	40	1520	141						
1002	24	33	792	74						
1002A	15	9	135	13						
1003	44	40	1760	164						
1004	32	40	1280	119						
1005A	138	8	1104	103						
1005B	7	72	728	68	28	8				
1005C	6	70	552	51	9	6	6	13		
1005D	53	8	720	67	12	12	8	19		
1005E	96	13	1248	116						
1005F	133	8	1176	109	14	8				
1005G	7	64	568	53	12	10				
1005H	8	55	624	58	8	23				
1005J	217	7	1519	141						
1007	60	78	4413	410	43	9	15	8		
1007A	43	9	387	36						
1008	30	59	1770	164						
1008A	30	9	270	25						
1009	10	50	500	46						
1010	24	58	1392	129						
1011	58	58	3364	313						
1012	28	48	1584	147	20	12				
1013	32	59	1768	164	12	10				
1013A	12	10	120	11						
1014	45	92	4140	385						
1015	83	86	14276	1326	*Area multiplied by two - Room extends two floors					
1016	36	10	360	33						
1017	40	10	400	37						
1018	82	28	2296	213						
1019	82	28	2296	213						
1020	36	10	360	33						
1021	30	11	330	31						
1022	30	10	300	28						

Table F5.2-1. Room Areas and Total Ignition Frequency (Continued)

Room	L1(ft)	L2(ft)	A(sq-ft)	A(sq-m)	L3 (ft)	L4(ft)	L5(ft)	L6(ft)	L7(ft)	L8(ft)			
1023	30	28	840	78									
1024	30	28	840	78									
1025	30	10	300	28									
1026	84	89	23070	2143	6	17	7	16	*Area (x3) - Room extends three floors				
1027	40	92	3680	342									
1028	57	78	4558	423	14	8							
1029	30	59	1770	164									
1029A	30	9	270	25									
1030	10	50	500	46									
1031	25	60	1500	139									
1032	57	58	3306	307									
1033	28	46	1554	144	19	14							
1034	32	16	512	48									
1035	40	44	1984	184	32	7							
1036	33	78	2574	239									
1036A	38	59	2242	208									
1036B	10	22	220	20									
1037	25	22	550	51									
1038	32	13	416	39									
1039	15	28	420	39									
1040	15	28	420	39									
1041	32	16	512	48									
1042	15	30	450	42									
1043	13	30	390	36									
1044	10	7	210	20	*Area multiplied by three - Room extends three floors								
1044A	10	8	80	7									
1045	32	16	292	27	10	7	10	7	10	8			
1046	10	7	70	7									
1047	17	16	816	76	*Area multiplied by three - Room extends three floors								
1047A	28	35	708	66	17	16							
1048	28	16	448	42									
1049	17	16	816	76	*Area multiplied by three - Room extends three floors								
1049A	28	35	708	66	17	16							
1050	28	16	448	42									
1051	15	23	345	32									
1052	15	23	345	32									

Table F5.2-1. Room Areas and Total Ignition Frequency (Continued)

Room	L1(ft)	L2(ft)	A(sq-ft)	A(sq-m)	L3 (ft)	L4(ft)	L5(ft)	L6(ft)	L7(ft)	L8(ft)		
1053	15	20	300	28								
1054	15	21	315	29								
1201 - 1210	76	32	2432	226								
1211 - 1213 & 1215 - 1222	43	58	3174	295	34	20						
1214	32	18	576	54								
2001	58	78	4659	433	15	9						
2002	29	68	1972	183								
2003	36	69	2276	211	13	16						
2003A	13	16	208	19								
2004	230	90	41400	3846	*Area multiplied by two - Room extends two floors							
2005	75	78	5500	511	25	14						
2005A	25	14	350	33								
2006A	138	7	966	90								
2006B	76	10	760	71								
2006D	88	11	968	90								
2006E	80	7	560	52								
2006F	68	6	408	38								
2006G	173	8	1384	129								
2006H	72	6	432	40								
2006J	87	11	957	89								
2006K	8	82	784	73	16	8						
2007	36	90	2664	247	24	12	24	12				
2007A	24	12	288	27								
2007B	24	12	288	27								
2008	58	78	4660	433	17	8						
2010	29	69	2001	186								
2011	36	67	2412	224								
2011A	17	12	204	19								
2012	78	68	5304	493								
2038	33	13	429	40								
2039	15	30	450	42								
2040	15	30	450	42								
2041	32	16	512	48								
2042	15	30	450	42								
2043	13	30	390	36								
2045	15	8	160	15	5	8						

Table F5.2-1. Room Areas and Total Ignition Frequency (Continued)

Room	L1(ft)	L2(ft)	A(sq-ft)	A(sq-m)	L3 (ft)	L4(ft)	L5(ft)	L6(ft)	L7(ft)	L8(ft)		
2045A	15	8	160	15	5	8						
2046	9	7	63	6								
2048	28	16	448	42								
2050	29	16	464	43								
3001	110	8	1298	121	38	11						
3002	36	11	652	61	8	32						
3038	33	13	429	40								
3041	32	16	512	48								
3045	15	8	160	15	5	8						
3045A	15	8	160	15	5	8						
3046	10	7	70	7								
3048	28	16	448	42								
3050	29	16	464	43								
Total Area (sq-m)				19611		50% Value		97.5% Value				
Ignition Frequency (per sq-m/yr)				3.77E-06	3.77E-06	3.77E-06		9.06E-06				
Ignition Frequency (per yr)				7.40E-02								
Ignition Frequency (50 years - preclosure period)				3.70E+00								

NOTE: ft = foot; m² = square meter; sq ft = square foot; yr = year.

Source: Original

F5.2.2 Building Ignition Frequency

Ignition frequency calculations are presented at the bottom of Table F5.2-1, and begin with the total area calculation. This is obtained by summing the areas (in square meters) of all rooms in the building. The ignition frequency per square meter per year line implements Equation F-1. The ignition frequency per year line implements Equation F-3. The ignition frequency over the 50 year period is obtained by multiplying the latter value by 50. As can be seen from the table, the expected number of ignition events over the preclosure period is approximately four.

The values shown are the baseline mean values for ignition frequency. An uncertainty analysis was performed on the results of Equation F-1 for the use of Crystal Ball software to run Monte Carlo simulations to obtain fire initiating event frequency distributions. The geometric mean and 97.5% values of the resulting distribution for Equation F-1 are shown on the table. Refer to Appendix F.III for the calculations performed to develop the uncertainty distribution.

F5.3 IGNITION SOURCE FREQUENCY

As discussed in Section F4.3.2.1, an industrial building fire can begin as the result of numerous types of ignition sources, which have been grouped into nine categories:

- Electrical
- HVAC
- Mechanical equipment
- Heat generating equipment
- Torches, welders, and burners
- Internal combustion engines
- Office/kitchen equipment
- Portable equipment
- No equipment involved.

Each category has a fraction representing the probability that, given an ignition, that category is the source of the ignition. The mean values of these fractions are shown in the column labeled Category Fraction in Table F5.3-1. The derivation of these values is discussed in Appendix F.II. The column labeled Category Frequency implements the generic form of Equation F-4 to determine the mean ignition frequency associated with each ignition source. The next column, category population, contains the total number of ignition sources in each category in the facility. This is either the actual count of sources, a weighted point score of sources, or (for the case of no equipment involved) the total floor area of the facility. The source of the count or score is presented in the next section. The floor area is taken from Table F5.2-1, fourth row from the bottom. The fifth column uses the previous two columns to implement Equation F-5 to determine the frequency per ignition source unit (i.e., per ignition source, per ignition source weighted point, or per square meter of floor area). These values are used in the next section to allocate fire ignition frequency to each room in the facility.

Table F5.3-1. Ignition Frequency by Ignition Source

Category	Category Fraction	Category Frequency (50 years)	Category Population	Frequency per Unit (50 years)	Normalized Value	Sampled Value	Mean Fraction	97.5% Value	97.5th percentile add
Electrical	0.086	3.11E-01	273	1.14E-03	0.086	0.086	0.086	1.26E-01	4.05E-02
HVAC	0.080	2.92E-01	64	4.56E-03	0.080	0.080	0.080	1.20E-01	3.93E-02
Mechanical Equipment	0.139	5.06E-01	68	7.44E-03	0.139	0.139	0.139	1.89E-01	5.01E-02
Heat Generating Equipment	0.155	5.64E-01	0	0.00E+00	0.155	0.155	0.155	2.07E-01	5.24E-02
Torches, welders, burners	0.219	7.97E-01	1381	5.77E-04	0.219	0.219	0.219	2.79E-01	5.99E-02
Internal combustion engines	0.021	7.64E-02	200	3.82E-04	0.021	0.021	0.021	4.23E-02	2.09E-02
Office/kitchen equipment	0.064	2.33E-01	10	2.33E-02	0.064	0.064	0.064	9.97E-02	3.55E-02
Portable Equipment	0.102	3.71E-01	60	6.19E-03	0.102	0.102	0.102	1.45E-01	4.37E-02
No equipment involved	0.134	4.88E-01	19234	2.54E-05	0.134	0.134	0.134	1.83E-01	4.93E-02
	1.000	3.6E+00			1.000				

NOTE: HVAC = heating, ventilation, and air conditioning.

Source: Original

As stated previously, these are mean values. The right hand group of columns is used by Crystal Ball to apply an uncertainty distribution to each of the category fraction values for the purpose of developing uncertainty distributions on initiating event frequency. The mean fraction, 97.5% value, and 97.5th percentile add columns show the parameters of these distributions. The development of all of the values is detailed in Appendix F.II. When Crystal Ball is run, it creates a sampled value for each fraction in the sampled value column. The spreadsheet then determines a normalized value by first assuring that each sampled value is not negative (minimum value of zero) and then normalizing the values so that the sum is always equal to one. The normalized value for each trial then replaces the category fraction value in the calculation. These probabilities must always add to one, as the groupings include all possible sources of ignition.

F5.4 IGNITION SOURCE DISTRIBUTION (EQUIPMENT LIST)

Compiling an initiating event frequency for the CRCF is dependant on identifying many characteristics of the building, to include ignition sources. Ignition sources are defined as items which exist in the rooms of the building that have the potential to contribute to the initiation and/or propagation of a fire. These sources are grouped into eight categories

- Electrical equipment
- HVAC equipment
- Mechanical process equipment
- Heat-generating process equipment
- Torches, welders, and burners
- Internal combustion engines
- Office and kitchen equipment
- Portable and special equipment.

Once the grouping for a source is determined, it is assigned a count (points), a number which specifies the significance of the source by its contribution to fire ignition. Counts are integral to the calculations, as the total count for each category and room are multiplied by the ignition source frequency and summed to obtain the room ignition frequency. Table F5.4-1 shows the results of the ignition source distribution assessment for the CRCF. The red numbers on this table highlight the actual count used, so as to make identification of the equipment count values easy to pick out from the other equipment identification information provided. Pieces of equipment that are in the room in question but do not count as ignition sources per the counting rules are shown as strikethrough text. The following sections describe how the equipment was identified, categorized, and counted for the building.

Table F5.4-1. Ignition Source Population by Room

Ignition Source Room Number	Electrical Equipment	Mechanical/ Electrical HVAC Equipment	Mechanical Process Equipment	Heat Generating Process Equipment	Torches, Welders, Burners	Internal Combustion Engines	Office/Kitchen Equipment	Portable and Special Equipment
1001 (LLW Staging Room)			LLW Staging Room Door • 2 hp		Portable Welding Receptacle – WWF = 5 point			
1001A (HVAC Room)		2 Air Handling Units 060-VNT0-AHU-00015 • 20 hp 060-VNT0-AHU-00016 • 20 hp						2.9% of all such equipment • 2 points
1002 (North Maintenance Vestibule)			2-N Maint. Vest. Doors • 2 hp (ea-)					
1002A (Personnel Vestibule)								
1003 (HVAC Room)		Air Handling Units, 4 motors 060-VCTO-AHU-00001 • 30 hp(supply) • 15 hp(return) 060-VCTO-AHU-00002 • 30 hp(supply) • 15 hp(return)						2.9% of all such equipment • 2 points
1004 (HVAC Room)	1 Lighting Panel • 480/277 VAC • 60 Hz	2 HEPA Filter Units (hpn/a) 060-VCT0-FLT-00015 060-VCT0-FLT-00016 2 Exhaust Fans 060-VCT0-EXH-00011 060-VCT0-EXH-00012 • 30 hp						2.9% of all such equipment • 2 points
1005A (Corridor)								
1005B (Corridor)								
1005C (Corridor)								
1005D (Corridor)								
1005E (Corridor)								
1005F (Corridor)								
1005G (Corridor)								
1005H (Corridor)								
1005J (Corridor)								

Table F5.4-1. Ignition Source Population by Room (Continued)

Ignition Source Room Number	Electrical Equipment	Mechanical/ Electrical HVAC Equipment	Mechanical Process Equipment	Heat Generating Process Equipment	Torches, Welders, Burners	Internal Combustion Engines	Office/Kitchen Equipment	Portable and Special Equipment
1007 (Electrical Room)	2 480V Load Centers EEN0-LC-00001 EEN0-LC-00002 <ul style="list-style-type: none"> • 7 cabs • 6 cabs 480V MCCs EEE0-MCC-00001 <ul style="list-style-type: none"> • 10 cabs EEE0-MCC-00002 <ul style="list-style-type: none"> • 10 cabs EEN0-MCC-00001 <ul style="list-style-type: none"> • 12 cabs EEN0-MCC-00002 <ul style="list-style-type: none"> • 17 cabs EEN0-MCC-00003 <ul style="list-style-type: none"> • 13 cabs EEN0-MCC-00004 <ul style="list-style-type: none"> • 19 cabs 13.8 kVA Dist Xfmr (A, B) XFMR-00001 XFMR-00002 XFMR-00001 XFMR-00002 <ul style="list-style-type: none"> • located outside 1 480-208/120V Maint. Bypass Xfmr 060-EEPO-XFMR-00001 <ul style="list-style-type: none"> • 160 kVA 1 208/120V Distribution Panel EEN0-PL-00001 EEN0-PL-00003 1 75 kVA Dist Xfmr 480-208/120V EEN0-XFMR-00003 1 480-208/120V Maint. Bypass Xfmr							2.9% of all such equipment <ul style="list-style-type: none"> • 2 points

Table F5.4-1. Ignition Source Population by Room (Continued)

Ignition Source Room Number	Electrical Equipment	Mechanical/ Electrical HVAC Equipment	Mechanical Process Equipment	Heat Generating Process Equipment	Torches, Welders, Burners	Internal Combustion Engines	Office/Kitchen Equipment	Portable and Special Equipment
1007 (Electrical Room) (Continued)	060-EEP0-XFMR-00002 2 480/277V Ltg. Panel EEN0-PL-00002 EEN0-PL-00003 • 71 kVA 1 480/277V Ltg. Panel EEN0-PL-00004 2 DCMS 2 PLC Panels							
1007A (Battery Room)	1 125 V DC Battery 060-EEP0-BTRY-00002 1 250 V DC Battery 060-EEP0-BTRY-00001							

Table F5.4-1. Ignition Source Population by Room (Continued)

Ignition Source Room Number	Electrical Equipment	Mechanical/ Electrical HVAC Equipment	Mechanical Process Equipment	Heat Generating Process Equipment	Torches, Welders, Burners	Internal Combustion Engines	Office/Kitchen Equipment	Portable and Special Equipment
1008 (Electrical Room)	480V Load Center EEE0-LC-00001 • 2 cabs 480V MCCs EEN0-MCC-00005 • 7 cabs EEN0-MCC-00006 • 5 cabs 1 13.8 kVA / 480V Xfmr EEE0-XFMR-00001 1 208/120V Distribution Panel EEE0-PL-00001 1 75 kVA Dist Xfmr 480-208/120V EEE0-XFMR-00003 1 480/277V LP EEN0-PL-00004 1 480-208/120V Maint. Bypass Xfmr 060-EEU0-XFMR-00001 1 120V UPS Panel 060-EEU0-PL-00001 1 208/120V UPS 060-EEU0-UJX-00001 2 DCMIS 2 PLC Panels	2 Fan coil units 060-VCT0-FCU-00001 060-VCT0-FCU-00002 • 20 hp(ea.)						2.9% of all such equipment • 2 points

Table F5.4-1. Ignition Source Population by Room (Continued)

Ignition Source Room Number	Electrical Equipment	Mechanical/ Electrical HVAC Equipment	Mechanical Process Equipment	Heat Generating Process Equipment	Torches, Welders, Burners	Internal Combustion Engines	Office/Kitchen Equipment	Portable and Special Equipment
1008A (Battery Room)	1 125 V DC Battery 060-EEU0-BTRY-00001							
1009 (HVAC Room)		2 HEPA Filter Units (hpn/a) 060-VCT0-FLT-00005 060-VCT0-FLT-00006 2 Exhaust Fan 060-VCT0-EXH-00005 060-VCT0-EXH-00006 • 5 hp(ea.)			Portable Welding Receptacle – WWF = 5 point			2.9% of all such equipment • 2 points
1010 (HVAC Room)		2 Air Handling Units 060-VCT0-AHU-00009 060-VCT0-AHU-00010 • 75 hp(ea.)						2.9% of all such equipment • 2 points
1011 (HVAC Room)		3 HEPA Filter Units (hpn/a) 060-VCT0-FLT-00009 060-VCT0-FLT-00010 060-VCT0-FLT-00011 1 Exhaust Fan 060-VCT0-EXH-00009 • 200 hp						2.9% of all such equipment • 2 points
1012 (Maintenance Room N)			Maintenance Room Door ○ 2 hp					
1013 (Operations Room)	Control Consoles – 12 Equipment Racks – 4						10% of all such equipment 1 point	
1013A (Operations Supervisor Room)								
1014 (WP Loadout Vestibule)		2 Fan coil units 060-VNI0-FCU-00001 060-VNI0-FCU-00002 • 15 hp(ea.)	2 WP Loadout Vestibule Doors • 1 motor each @ 5 hp					1.5% of all such equipment • 1 point

Table F5.4-1. Ignition Source Population by Room (Continued)

Ignition Source Room Number	Electrical Equipment	Mechanical/ Electrical HVAC Equipment	Mechanical Process Equipment	Heat Generating Process Equipment	Torches, Welders, Burners	Internal Combustion Engines	Office/Kitchen Equipment	Portable and Special Equipment
1015 (WP Loadout Room)	WP Handling Crane 060-HMP0-CRN-00001 1 electrical panel	2 Air Handling Units 060-VCT0-AHU-00013 060-VCT0-AHU-00014 50 hp(ea.)	WP Handling Crane 060-HMP0-CRN-00001 <ul style="list-style-type: none"> • 4 motors: 60, 45, 7.5, & 20 hp • 132.5 hp • 105 kVA 2 WP Transfer Carriage Docking Stations 060-HL00-75-00001 & 2 <ul style="list-style-type: none"> • 30 hp (ea.) • 30 kVA (ea.) 2 WP Loadout Platforms 060-HL00-PLAT-00004 060-HL00-PLAT-00003 <ul style="list-style-type: none"> • 1 motors (ea.) • 2 hp • 2 kVA (ea.) WP Loadout Platforms 060-HL00-PLAT-00002 <ul style="list-style-type: none"> • 2 motors • 4 hp • 4 kVA 2 WP Loadout Vestibule Shield Doors 060-CR00-DR-00005 060-CR00-DR-00006 <ul style="list-style-type: none"> • 10 hp (ea.) • 10 kVA 30% each WP Transfer Trolleys, 2 060-HL00-TRLY-00001 1018 060-HL00-TRLY-00002 1019 <ul style="list-style-type: none"> • 2 motors @ 75 & 30 hp x 2 x RWF 1.2 • 150 kVA (ea.) 105 hp (ea.) 					2.9% of all such equipment <ul style="list-style-type: none"> • 2 points

Table F5.4-1. Ignition Source Population by Room (Continued)

Ignition Source Room Number	Electrical Equipment	Mechanical/ Electrical HVAC Equipment	Mechanical Process Equipment	Heat Generating Process Equipment	Torches, Welders, Burners	Internal Combustion Engines	Office/Kitchen Equipment	Portable and Special Equipment
1016 (Unassigned)								
1017 (Canister Staging Area #1)								
1018 (WP Positioning Room North)			70% WP Transfer Trolley 060-HL00-TRLY-00001 1015 <ul style="list-style-type: none"> • 2 motors @ 75 & 30 hp x RWF 1.4 • 150 kVA • 105 hp Shield Door 060-CR00-DR-00003 <ul style="list-style-type: none"> • 1 motor • 15 hp 					1.5% of all such equipment <ul style="list-style-type: none"> • 1 point
1019 (WP Positioning Room South)			70% WP Transfer Trolley 060-HL00-TRLY-00002 1015 <ul style="list-style-type: none"> • 2 motors @ 75 & 30 hp x RWF 1.4 • 150 kVA • 105 hp Shield Door 060-CR00-DR-00004 <ul style="list-style-type: none"> • 1 motor @ 15 hp 					1.5% of all such equipment <ul style="list-style-type: none"> • 1 point
1020 (Unassigned)								
1021 (Canister Staging Area #2)								
1022 (Canister Staging Area #3)								

Table F5.4-1. Ignition Source Population by Room (Continued)

Ignition Source Room Number	Electrical Equipment	Mechanical/ Electrical HVAC Equipment	Mechanical Process Equipment	Heat Generating Process Equipment	Torches, Welders, Burners	Internal Combustion Engines	Office/Kitchen Equipment	Portable and Special Equipment
1023 (Cask Unloading Room North)			5% in 1023 Cask Transfer Trolley 060-HM00-TRLY-00001 1026 <ul style="list-style-type: none"> • 1 power drive x RWF 0.05 • 5 hp Shield Door 060-CR00-DR-00001 <ul style="list-style-type: none"> • 1 motor @ 15 hp 					1.5% of all such equipment <ul style="list-style-type: none"> • 1 point
1024 (Cask Unloading Room South)			5% in 1024 Cask Transfer Trolley 060-HM00-TRLY-00002 1026 <ul style="list-style-type: none"> • 1 power drive x RWF 0.05 • 5 hp Shield Door 060-CR00-DR-00002 <ul style="list-style-type: none"> 1 motor @ 15 hp 					1.5% of all such equipment <ul style="list-style-type: none"> • 1 point
1025 (Canister Staging Area #4)								

Table F5.4-1. Ignition Source Population by Room (Continued)

Ignition Source Room Number	Electrical Equipment	Mechanical/ Electrical HVAC Equipment	Mechanical Process Equipment	Heat Generating Process Equipment	Torches, Welders, Burners	Internal Combustion Engines	Office/Kitchen Equipment	Portable and Special Equipment
1026 (Cask Preparation Room)	Cask Handling Crane 060-HM00-CRN-00001 1 electrical panel		Cask Preparation Platform 060-HMH0-PLAT-00001 <ul style="list-style-type: none"> 8 motors @ 5 hp 40 kVA 40 hp Cask Handling Yoke 060-HM00-BEAM-00004 <ul style="list-style-type: none"> 2 hp Cask Handling Crane 060-HM00-CRN-00001 <ul style="list-style-type: none"> 4 motors @ 90, 45, 7.5, & 30 hp 120 hp 140 kVA Mobile Access Platform 060-HMC0-PLAT-00001 <ul style="list-style-type: none"> 44 kVA 6 + 4 motors <ul style="list-style-type: none"> 4 @ 1 hp 4 @ 5 hp 2 @ 10 hp 2 Site Transporter Doors <ul style="list-style-type: none"> 2 motors each @ 3 hp Cask Prep. Room Door <ul style="list-style-type: none"> 1 motors @ 2 hp 95% each in 1026 Cask Transfer Trolleys, 2 power drives (1/ea) 060-HM00-TRLY-00001 1023 060-HM00-TRLY-00002 1024 <ul style="list-style-type: none"> 2 power drives × RWF 1.9 5 hp (ea.) 			90% Site Transporter 1027 <ul style="list-style-type: none"> 90 units 40% Site Prime Mover <ul style="list-style-type: none"> 40 units Split with rooms 1036 and 1036A		5.9% of all such equipment <ul style="list-style-type: none"> 4 points
1027(Site Transporter Vestibule)		2 Fan coil units 060-VNI0-FCU-00003 060-VNI0-FCU-00004 <ul style="list-style-type: none"> 20 hp(ea.) 	2 Site Transporter Vestibule Doors <ul style="list-style-type: none"> 5 kVA (each) 1 motor each @ 5 hp 		Portable Welding Receptacle – WWF = 5 points	10% Site Transporter 1026 <ul style="list-style-type: none"> 10 units 		

Table F5.4-1. Ignition Source Population by Room (Continued)

Ignition Source Room Number	Electrical Equipment	Mechanical/ Electrical HVAC Equipment	Mechanical Process Equipment	Heat Generating Process Equipment	Torches, Welders, Burners	Internal Combustion Engines	Office/Kitchen Equipment	Portable and Special Equipment
1028 (Maintenance Room)	1 13.8 kVA / 480V Xfmr	2 Fan coil units 060-VCT0-FCU-00005 060-VCT0-FCU-00006 25 hp(ea.)	2 Chilled Water Pumps 060-PSC0-P-00001A 060-PSC0-P-00001B • 1 motor (ea.) • 100 hp(ea.) Hot Water Pump 060-PSH0-P-00001A • 1 motor • 25 hp Hot Water Pump 060-PSH0-P-00001B • 1 motor ○ 25 hp		Primary Welding Station 400 points			
1029 (Electrical Room)	480V Load Center EEE0-LC-00002 • 2 cabs 480V MCCs EEN0-MCC-00007 • 9 cabs 1 13.8 kVA / 480V Xfmr EEE0-XFMR-00002 1 208/120V Distribution Panel EEE0-PL-00003 1 75 kVA Dist Xfmr EEN0-XFMR-00004 1 480/277V Lighting Panel EEN0-PL-00006 1 480-208/120V 40 kVA Maint. Bypass Xfmr 060-EEU0-XFMR-00002 1 208/120V UPS Panel 060-EEU0-PL-00002 1 208/120V 40 kVA UPS 060-EEU0-UJX-00002 2 DCMIS 2 PLC Panels	2 Fan coil units 060-VCT0-FCU-00003 060-VCT0-FCU-00004 20 hp(ea.)						2.9% of all such equipment • 2 points

Table F5.4-1. Ignition Source Population by Room (Continued)

Ignition Source Room Number	Electrical Equipment	Mechanical/ Electrical HVAC Equipment	Mechanical Process Equipment	Heat Generating Process Equipment	Torches, Welders, Burners	Internal Combustion Engines	Office/Kitchen Equipment	Portable and Special Equipment
1029A (Battery Room)	1 125 V DC Battery 060-EEU0-BTRY-00002							
1030 (HVAC Room)		2 HEPA Filter Units (hpn/a) 060-VCT0-FLT-00007 060-VCT0-FLT-00008 2 Exhaust Fans 060-VCT0-EXH-00007 060-VCT0-EXH-00008 5 hp(ea.)						2.9% of all such equipment • 2 points
1031 (HVAC Room)		2 Air Handling Units 060-VCT0-AHU-00011 060-VCT0-AHU-00012 75 hp(ea.)						2.9% of all such equipment • 2 points
1032 (HVAC Room)		3 HEPA Filter Units (hpn/a) 060-VCT0-FLT-00012 060-VCT0-FLT-00013 060-VCT0-FLT-00014 1 Exhaust Fan 060-VCT0-EXH-00010 200 hp						2.9% of all such equipment • 2 points
1033 (Maintenance Room S)			Maintenance Room Door • 2 kVA 2 hp					
1034 (Gas Sampling Room)			Cask Cavity Gas Sampling System 060-MRE0-DET-00004 1 motor @ 2 hp					

Table F5.4-1. Ignition Source Population by Room (Continued)

Ignition Source Room Number	Electrical Equipment	Mechanical/ Electrical HVAC Equipment	Mechanical Process Equipment	Heat Generating Process Equipment	Torches, Welders, Burners	Internal Combustion Engines	Office/Kitchen Equipment	Portable and Special Equipment
1035 (HVAC Room)		2 HEPA Filter Units (hpn/a) 060-VCT0-FLT-00017 060-VCT0-FLT-00018 2 Exhaust Fans 060-VCT0-EXH-00013 060-VCT0-EXH-00014 15 hp(ea.)						2.9% of all such equipment • 2 points
1036 (Trans. Cask Vestibule)		2 Fan coil units 060-VNI0-FCU-00005 060-VNI0-FCU-00006 10 hp(ea.)	Transportation Cask Vestibule Door 2 hp			37% Site Prime Mover • 37 units Split with rooms 1026 and 1036A		
1036A (Vestibule Annex)		2 Fan coil units 060-VNI0-FCU-00007 060-VNI0-FCU-00008 10 hp(ea.)	Vestibule Annex Door • 2 kVA 2 hp			23% Site Prime Mover • 23 units Split with rooms 1026 and 1036		
1036B (Personnel Vestibule)								
1037 (South Maintenance Vestibule)			2 South Maint. Vest. Doors • 2 kVA (ea.) 2 hp					
1038 (Stair #1)								
1039 (Stair #2)								
1040 (Stair #3)								
1041 (Stair #4)								
1042 (Stair #5)								
1043 (Stair #6)								
1044 (Personnel Elevator)			5000 lb Passenger Elevator • 50 kVA 1 motor					
1044A (Elevator Mechanical Room)								
1045 (Corridor)								
1046 (Elevator Lobby)								

Table F5.4-1. Ignition Source Population by Room (Continued)

Ignition Source Room Number	Electrical Equipment	Mechanical/ Electrical HVAC Equipment	Mechanical Process Equipment	Heat Generating Process Equipment	Torches, Welders, Burners	Internal Combustion Engines	Office/Kitchen Equipment	Portable and Special Equipment
1047 (Freight Elevator – North)			20 Ton Freight Elevator • 100 kVA • 1 motor 2 Freight Elevator Doors 1 motor each @ 2hp					
1047A (Vestibule)			Freight Elevator Vestibule Door 1 motor @ 2 hp					
1048 (Elevator Lobby)			Freight Elevator Lobby Door 1 motor @ 2 hp					
1049 (Freight Elevator South)			20,000 lb Freight Elevator • 100 kVA • 1 motor 2 Freight Elevator Doors 1 motor each @ 2 hp					
1049A (Vestibule)			Vestibule Door • 2 kVA 1 motor @ 2 hp					
1050 (Elevator Lobby)			Elevator Lobby Door 1 motor @ 2 hp					
1051 (Fire Water Riser Valve Room #1)								
1052 (Fire Water Riser Valve Room #2)								
1053 (Fire Water Riser Valve Room #3)								
1054 (Fire Water Riser Valve Rm #4)								
1201 (Women's Locker/Shower/Restroom)		Exhaust Fan 060-VN10-EXH-00002 0.5 hp						
1202 (Security Post)							10% of all such equipment 1 point	
1203 (RP Staff Work Room)							10% of all such equipment 1 point	

Table F5.4-1. Ignition Source Population by Room (Continued)

Ignition Source Room Number	Electrical Equipment	Mechanical/ Electrical HVAC Equipment	Mechanical Process Equipment	Heat Generating Process Equipment	Torches, Welders, Burners	Internal Combustion Engines	Office/Kitchen Equipment	Portable and Special Equipment
1204 (Briefing Room)							10% of all such equipment 1 point	
1205 (Men's Locker/Shower/Restroom)		Exhaust Fan 060-VN10-EXH-00001 0.5 hp						
1206 (Janitor Closet)								
1207 (Break Room)							10% of all such equipment 1 point	
1208 (Vending Room)							10% of all such equipment 1 point	
1209 (Entrance Lobby)								
1210 (Entry/Exit Vestibule)								
1211 (RP Lab / Count Room)							10% of all such equipment 1 point	
1212 (Decontamination Room)								
1213 (Vestibule In/Out)								
1214 (RA Control Point)								
1215 (RP Lab/Count Room)							10% of all such equipment 1 point	
1216 (RP Instrument Room)							10% of all such equipment 1 point	
1217 (RA Exit/PCM Room)								
1218 (RP Gear Supply Room)								
1219 (RP Equipment Room)							10% of all such equipment 1 point	

Table F5.4-1. Ignition Source Population by Room (Continued)

Ignition Source Room Number	Electrical Equipment	Mechanical/ Electrical HVAC Equipment	Mechanical Process Equipment	Heat Generating Process Equipment	Torches, Welders, Burners	Internal Combustion Engines	Office/Kitchen Equipment	Portable and Special Equipment
1220 (Respirator Room)								
1221 (Change Room 1)								
1222 (Change Room 2)								
2001 (HVAC Room)	480V Load Center EEN0-LC-00003 • 5 cabs 2 480V MCCs EEN0-MCC-00008 • 9 cabs EEN0-MCC-00009 • 9 cabs 1 75 kVA / 480-208/120V Xfmr 060-EEEE0-XFMR-00004 1 480-208/120 Distr. Panel 060-EEEE0-PL-00004 1 277V Lighting Panel 060-EEN0-PL-00005	2 HEPA Filter Units (hpn/a) 060-VCT0-FLT-00001 060-VCT0-FLT-00002 2 Exhaust Fans 060-VCT0-EXH-00001 060-VCT0-EXH-00002 • 5 hp(ea.) 2 Air Handling Units 060-VCT0-AHU-00001 060-VCT0-AHU-00002 • 75 hp(ea.) 55 kVA						5.9% of all such equipment • 4 points
2002 (Unassigned)					Portable Welding Receptacle – WWF = 5 points			

Table F5.4-1. Ignition Source Population by Room (Continued)

Ignition Source Room Number	Electrical Equipment	Mechanical/ Electrical HVAC Equipment	Mechanical Process Equipment	Heat Generating Process Equipment	Torches, Welders, Burners	Internal Combustion Engines	Office/Kitchen Equipment	Portable and Special Equipment
2003 (Closure Support Room N)	WP Closure Spt. Rm. Crane 060-HW00-CRN-00002 <ul style="list-style-type: none"> • 1 Electrical Panel 10 Equipment Racks		WP Closure Spt. Rm. Crane 060-HW00-CRN-00002 <ul style="list-style-type: none"> • 1 + 2 motors @ 20, 1, & 3 hp • 24 hp • 48 kVA Closure Support Room Door <ul style="list-style-type: none"> • 2 kVA • 1 motor @ 2 hp 					1.5% of all such equipment <ul style="list-style-type: none"> • 1 point
2003A (Personnel Access Room)								

Table F5.4-1. Ignition Source Population by
Room (Continued)

Ignition Source Room Number	Electrical Equipment	Mechanical/ Electrical HVAC Equipment	Mechanical Process Equipment	Heat Generating Process Equipment	Torches, Welders, Burners	Internal Combustion Engines	Office/Kitchen Equipment	Portable and Special Equipment
2004 (Canister Transfer Room)		2 Air Handling Units 060-VCT0-AHU-00003 060-VCT0-AHU-00004 75 hp(ea.)	CTM Maintenance Cranes 060-HTC0-CRN-00001 060-HTC0-CRN-00002 <ul style="list-style-type: none"> • 2 +1 motors @ 35, 2, & 7.5 hp x 2 - 4 • 44.5 hp • 67.5 kVA Canister Trans. Machines 060-HTC0-FHM-00001 <ul style="list-style-type: none"> • 5 +1 motors @ 45, 3, 7.5, 7.5, 60, & 5 hp 060-HTC0-FHM-00002 <ul style="list-style-type: none"> • 5 +1 motors @ 45, 3, 7.5, 7.5, 60, & 5 hp • 120.5 hp (ea.) • 140 kVA (ea.) 5 DOE Canister Slide Gates 060-HTC0-HTCH-00005(thru 9) <ul style="list-style-type: none"> • 1 Motor @ 3 hp 2 TAD Slide Gates 060-HTC0-HTCH-00010 & 11 <ul style="list-style-type: none"> • 2 Motors @ 1.5 hp 2 Cask Port Slide Gates 060-HTC0-HTCH-00001 060-HTC0-HTCH-00002 <ul style="list-style-type: none"> • 1 hp (ea.) • 2 motors 2 Cask Port Slide Gates 060-HTC0-HTCH-00003 060-HTC0-HTCH-00004 <ul style="list-style-type: none"> • 1 kVA (ea.) • 1 hp (ea.) 		2 Portable Welding Receptacle – WWF = 10 points			1.5% of all such equipment <ul style="list-style-type: none"> • 1 point

Table F5.4-1. Ignition Source Population by Room (Continued)

Ignition Source Room Number	Electrical Equipment	Mechanical/ Electrical HVAC Equipment	Mechanical Process Equipment	Heat Generating Process Equipment	Torches, Welders, Burners	Internal Combustion Engines	Office/Kitchen Equipment	Portable and Special Equipment
2005 (HVAC Room)	2 480V MCCs EEN0-MCC-00011 • 9 cabs EEN0-MCC-00012 • 8 cabs 1 480-208/120V Xfmr 060-EEN0-XFMR-00005 1 480-208/120 Distribution Pnl 060-EEN0-PL-00006 1 277V Lighting Panel 060-EEN0-PL-00007 1 277V Lighting Panel 060-EEN0-PL-00008	2 Air Handling Units 060-VCT0-AHU-00005 060-VCT0-AHU-00006 75 hp(ea.)						5.9% of all such equipment • 4 points
2005A (Communications Room)								
2006A (Corridor)								
2006B (Corridor)								
2006D (Corridor)								
2006E (Corridor)								
2006F (Corridor)								
2006G (Corridor)								
2006H (Corridor)								
2006J (Corridor)								
2006K (Corridor)								

Table F5.4-1. Ignition Source Population by Room (Continued)

Ignition Source Room Number	Electrical Equipment	Mechanical/ Electrical HVAC Equipment	Mechanical Process Equipment	Heat Generating Process Equipment	Torches, Welders, Burners	Internal Combustion Engines	Office/Kitchen Equipment	Portable and Special Equipment
2007 (Waste Package Closure Room)			WP Closure Room Crane 060-HW00-CRN-00001 <ul style="list-style-type: none"> • 2 ± motors @ 35, 2, & 7.5 hp • 34.5 hp • 67.5 kVA Closure Support Cart 060-HL00-TRLY-00003 <ul style="list-style-type: none"> • 1 motor • 5 hp • 5 kVA Burnishing Tool HWS0-TOOL-00004 <ul style="list-style-type: none"> • low hp motors Weld Dressing End Effectors 060-HWW0-TOOL-00003 & 4 <ul style="list-style-type: none"> • 2 machining/sparks • 2 motors @ 4.5 hp Remote Handling System 060 HWH0 HEQ 00003 <ul style="list-style-type: none"> • various small motors 2 WP Closure System Robot Arms 060 HWH0 HEQ 00001 & 2 <ul style="list-style-type: none"> • various small motors 2 MP WP Inverting Vac Pump <ul style="list-style-type: none"> • 2 hp (ea.) WP Closure Sys. Chiller <ul style="list-style-type: none"> • 3 motors @ 1hp Waste Package Closure Room Door 1 <ul style="list-style-type: none"> • 2 kVA 1 motor @ 2 hp 		WPCS Weld End Effectors – WWF = 946 points HWW0-TOOL-00001 & 2			2.9% of all such equipment <ul style="list-style-type: none"> • 2 points

Table F5.4-1. Ignition Source Population by Room (Continued)

Ignition Source Room Number	Electrical Equipment	Mechanical/ Electrical HVAC Equipment	Mechanical Process Equipment	Heat Generating Process Equipment	Torches, Welders, Burners	Internal Combustion Engines	Office/Kitchen Equipment	Portable and Special Equipment
2007A (Closure Equipment Room N)	9 Equipment Racks							1.5% of all such equipment • 1 point
2007B (Closure Equipment Room S)								1.5% of all such equipment • 1 point
2008 (HVAC Room)	480V MCC 060-EEN0-MCC-00010 • 12 cabs 1 75 kVA 480-208/120V Xfmr 060-EEN0-XFMR-00006 1 75 kVA 480-208/120V Xfmr 060-EEN0-XFMR-00007 1 480-208/120 Distribution Pnl 060-EEN0-PL-00009 1 480-208/120 Distribution Pnl 060-EEN0-PL-00010	2 Air Handling Units 060-VCT0-AHU-00007 060-VCT0-AHU-00008 75 hp(ea.)						5.9% of all such equipment • 4 points
2010 (Unassigned)					Portable Welding Receptacle – WWF = 5 points			
2011 (Closure Support Room S)	WP Closure Spt. Rm. Crane 060-HW00-CRN-00003 • 1 Electrical Panel 10 Equipment Racks		WP Closure Spt. Rm. Crane 060-HW00-CRN-00003 • 1 + 2 motors @ 20, 1, & 3 hp • 24 hp • 48 kVA Closure Support Room Door • 2 kVA 1 motor @ 2 hp					1.5% of all such equipment • 1 point

Table F5.4-1. Ignition Source Population by Room (Continued)

Ignition Source Room Number	Electrical Equipment	Mechanical/ Electrical HVAC Equipment	Mechanical Process Equipment	Heat Generating Process Equipment	Torches, Welders, Burners	Internal Combustion Engines	Office/Kitchen Equipment	Portable and Special Equipment
2011A (Personnel Access Room)								
2012 (HVAC Room)	480V MCC 060-EEN0-MCC-00013 • 9 cabs 1 75 kVA 480-208/120V Xfmr 060-EEN0-XFMR-00008 1 480-208/120 Distribution Pnl 060-EEN0-PL-00011 1 480-208/120 Lighting Pnl 060-EEN0-PL-00012	2 HEPA Filter Units (hpn/a) 060-VCT0-FLT-00003 060-VCT0-FLT-00004 2 Exhaust Fans 060-VCT0-EXH-00003 060-VCT0-EXH-00004 40 hp(ea.)						5.9% of all such equipment • 4 points
2038 (Stair #1)								
2039 (Stair #2)								
2040 (Stair #3)								
2041 (Stair #4)								
2042 (Stair #5)								
2043 (Stair #6)								
2045 (Corridor)								
2045A (Storage Room)								
2046 (Elevator Lobby)								
2048 (Elevator Lobby)			2 Elevator Lobby Doors • 1 motor each @ 2 hp					
2050 (Elevator Lobby)			2 Elevator Lobby Doors 1 motor each @ 2 hp					
3001 (Corridor)								
3002 (Corridor)								
3038 (Stair #1)								
3041 (Stair #4)								
3045 (Corridor)								

Table F5.4-1. Ignition Source Population by Room (Continued)

Ignition Source Room Number	Electrical Equipment	Mechanical/ Electrical HVAC Equipment	Mechanical Process Equipment	Heat Generating Process Equipment	Torches, Welders, Burners	Internal Combustion Engines	Office/Kitchen Equipment	Portable and Special Equipment
3045A (Storage Room)								
3046 (Elevator Lobby)								
3048 (Elevator Lobby)			1 Elevator Lobby Door 1 motor @ 2 hp					
3050 (Elevator Lobby)			1 Elevator Lobby Door 1 motor @ 2 hp					

NOTE: 1. The equipment shown shaded in grey is included on the table to show completeness in the process of identifying equipment and locations. However, in accordance with the counting guidance cited in the methodology section these pieces of equipment are not considered as ignition sources because they are motors of less than 5hp.
 2. In accordance with the counting guidance, the cabinet count for each MCC is for energized cabinets only (i.e., cabinets that have a load assigned). De-energized (i.e., spare) cabinets are not counted.
 3. RWF is room weighting factor for equipment that can be in multiple rooms. Factor represents the percentage of exposure (i.e., waste residence) time that the piece of equipment spends in the particular room.
 4. WWF is the welding weighting factor, which represents the relative number of total welding activity (hours/year) that occurs in each location where welding is performed. The number of hours for maintenance-related welding is based on about 8 hours/week in the primary maintenance welding location and 5 hours per year in each satellite welding location (for repairs that must be performed locally). Waste package closure room welding is estimated based in the IHF throughput Gantt chart and the total number of waste packages expected to be handled, as follows: (1) the preclosure period is 50 years; (2) the welding machine actually operates for 13 hours per waste package; (3) here are three CRCFs, each with two closure welding machines, both of which are in the same room. Since they are both in the same room, the welding score for the room is 1/3 of the CRCF total; (4) the three CRCFs combined will process 10,911 waste packages. $(10,911 \times 13 / 50) / 3 = 946$ hours per year (both machines combined, 472 hrs/machine). Note that for any given waste package being processed, the total welding score is "at" the WP.
 5: Power ratings are for each motor unless otherwise noted.

HEPA = high-efficiency particulate air (filter); hp = horse power; HVAC = heating, ventilation, and air conditioning; kVA = kilo-volt amperes; LLW = low-level radioactive waste; MCC = motor control center; WP = waste package; WWF = ; Xfmr = transformer

Source: Original

F5.4.1 Electrical Equipment

Information regarding electrical equipment was gathered solely from the following single line diagrams and electrical room layout drawings.

- *Canister Receipt & Closure Facility #1 Normal Electrical Room Equipment Layout. (Ref. F2.2.12)*
- *Canister Receipt & Closure Facility #1 ITS Train "A" Electrical Room Equipment Layout. (Ref. F2.2.10)*
- *Canister Receipt & Closure Facility #1 ITS Train "B" Electrical Room Equipment Layout. (Ref. F2.2.11)*
- *Canister Receipt & Closure Facility #1 Equipment Layout Second Floor. (Ref. F2.2.6)*
- *Canister Receipt & Closure Facility #1 Equipment Layout Second Floor. (Ref. F2.2.7)*
- *Canister Receipt & Closure Facility #1 Equipment Layout Second Floor. (Ref. F2.2.8)*
- *Canister Receipt & Closure Facility #1 Equipment Layout Second Floor. (Ref. F2.2.9)*
- *CRCF 1 480 V Load Center 060-EEN0-LC-00001 Single Line Diagram. (Ref. F2.2.16)*
- *CRCF 1 480 V Load Center 060-EEN0-LC-00002 Single Line Diagram. (Ref. F2.2.17)*
- *CRCF 1 480V Load Center 060-EEN0-LC-00003 Single Line Diagram. (Ref. F2.2.18)*
- *CRCF 1 480V MCC 060-EEN0-MCC-00001 Single Line Diagram. (Ref. F2.2.21)*
- *CRCF 1 480V MCC 060-EEN0-MCC-00002 Single Line Diagram. (Ref. F2.2.22)*
- *CRCF 1 480V MCC 060-EEN0-MCC-00003 Single Line Diagram. (Ref. F2.2.23)*
- *CRCF 1 480V MCC 060-EEN0-MCC-00004 Single Line Diagram. (Ref. F2.2.24)*
- *CRCF 1 480V MCC 060-EEN0-MCC-00005 Single Line Diagram. (Ref. F2.2.25)*
- *CRCF 1 480V MCC 060-EEN0-MCC-00006 Single Line Diagram. (Ref. F2.2.26)*
- *CRCF 1 480V MCC 060-EEN0-MCC-00007 Single Line Diagram. (Ref. F2.2.27)*
- *CRCF 1 480V MCC 060-EEN0-MCC-00008 Single Line Diagram. (Ref. F2.2.28)*
- *CRCF 1 480V MCC 060-EEN0-MCC-00009 Single Line Diagram. (Ref. F2.2.29)*
- *CRCF 1 480V MCC 060-EEN0-MCC-00010 Single Line Diagram. (Ref. F2.2.30)*

- *CRCF 1 480V MCC 060-EEN0-MCC-00011 Single Line Diagram.* (Ref. F2.2.31)
- *CRCF 1 480V MCC 060-EEN0-MCC-00012 Single Line Diagram.* (Ref. F2.2.32)
- *CRCF 1 480V MCC 060-EEN0-MCC-00013 Single Line Diagram.* (Ref. F2.2.33)
- *CRCF 1 480V ITS MCC – Train A 060-EEE0-MCC-00001 Single Line Diagram.* (Ref. F2.2.19)
- *CRCF 1 480V ITS MCC – Train B 060-EEE0-MCC-00002 Single Line Diagram.* (Ref. F2.2.20)
- *CRCF 1 UPS 060-EEP0-UJX-00001 Single Line Diagram.* (Ref. F2.2.68)
- *CRCF 1 UPS 060-EEP0-UJX-00002 Single Line Diagram.* (Ref. F2.2.69)
- *CRCF 1 ITS UPS – Train A 060-EEU0-UJX-00001 Single Line Diagram.* (Ref. F2.2.61)
- *CRCF 1 ITS UPS – Train B 060-EEU0-UJX-00002 Single Line Diagram.* (Ref. F2.2.62)

The electrical equipment category consists of computers, equipment racks, load centers, motor control centers (MCCs), uninterruptable power supply (UPSs), transformers, lighting panels, digital control and management information system (DCMISs), programmable logic controller panels, batteries, and electrical panels. In general, each piece of electrical equipment constitutes a single ignition source and therefore has a count of one. However, MCCs, load centers, and equipment racks are assigned a count based on the total number of active vertical cabinets making up the overall unit. Every vertical cabinet in an equipment rack is treated as active. In the case of MCCs and load centers, a cabinet is considered active if the single line diagram shows that a load is attached (i.e., unused breakers are not counted).

F5.4.2 HVAC Equipment

HVAC equipment locations and horsepower were obtained from the following facility general layout drawings and HVAC equipment lists.

- *CRCF 1 Composite Vent Flow Diagram Tertiary Conf ITS Exhaust & Non-ITS HVAC Supply Systems.* (Ref. F2.2.36)
- *CRCF 1 Composite Vent Flow Diagram Tertiary Confinement Non-ITS Exhaust & HVAC Supply Systems.* (Ref. F2.2.37)
- *CRCF 1 Composite Vent Flow Diagram Tertiary Confinement Ground Floor HVAC Systems.* (Ref. F2.2.38)
- *CRCF 1 Composite Vent Flow Diagram Tertiary Confinement Non- ITS HVAC System Supply & Exhaust.* (Ref. F2.2.39)

- *CRCF 1 Composite Vent Flow Diagram Tertiary Confinement ITS HVAC Systems. Elect & Battery RMS. (Ref. F2.2.40)*
- *CRCF 1 Composite Vent Flow Diagram Non-Confinement Non-ITS HVAC Systems. Support & Operations. (Ref. F2.2.35)*
- *CRCF 1 ITS Confinement WP Loadout Room HVAC Supply System Ventilation & Instrumentation Diagram. (Ref. F2.2.60)*
- *CRCF 1 ITS Confinement Areas HEPA Exhaust System Train A Ventilation & Instrumentation Diagram. (Ref. F2.2.58)*
- *CRCF 1 ITS Confinement Areas HEPA Exhaust System - Train B Ventilation & Instrumentation Diagram. (Ref. F2.2.59)*
- *CRCF 1 Confinement Cask Prep Room HVAC Supply System Ventilation & Instrumentation Diagram. (Ref. F2.2.45)*
- *CRCF 1 Non-Confinement Transport. Cask/Annex Vest HVAC System Ventilation & Instrumentation Diagram. (Ref. F2.2.66)*
- *CRCF 1 Confinement Ground Flr North Areas HVAC Supply System Ventilation & Instrumentation Diagram. (Ref. F2.2.47)*
- *CRCF 1 Confinement Utility Room HVAC System Ventilation & Instrumentation Diagram. (Ref. F2.2.41)*
- *CRCF 1 Confinement Non-ITS Battery Room Exhaust System Ventilation & Instrumentation Diagram. (Ref. F2.2.55)*
- *CRCF 1 Confinement Ground Flr South Areas HVAC Supply System Ventilation & Instrumentation Diagram. (Ref. F2.2.48)*
- *CRCF 1 Confinement Ground Floor Non-ITS HEPA Exhaust System Ventilation & Instrumentation Diagram. (Ref. F2.2.46)*
- *CRCF 1 Confinement Canister Transfer Room HVAC Supply System Ventilation & Instrumentation Diagram. (Ref. F2.2.44)*
- *CRCF 1 Confinement 2nd Floor North Areas HVAC Supply System Ventilation & Instrumentation Diagram. (Ref. F2.2.42)*
- *CRCF 1 Confinement 2nd Floor South HVAC Supply System Ventilation & Instrumentation Diagram. (Ref. F2.2.43)*
- *CRCF 1 Confinement Non-ITS HEPA Exhaust System – 2nd Floor Ventilation & Instrumentation Diagram. (Ref. F2.2.56)*

- *CRCF 1 Confinement LLW & Misc. Areas HVAC Supply System Ventilation & Instrumentation Diagram.* (Ref. F2.2.53)
- *CRCF 1 Confinement LLW & Misc. Areas Non-ITS HEPA Exhaust System Ventilation & Instrumentation Diagram.* (Ref. F2.2.54)
- *CRCF 1 Confinement ITS Electrical Room HVAC System – Train A Ventilation & Instrumentation Diagram.* (Ref. F2.2.51)
- *CRCF 1 Confinement ITS Battery Room Exhaust System – Train A Ventilation & Instrumentation Diagram.* (Ref. F2.2.49)
- *CRCF 1 Confinement ITS Electrical Room HVAC System – Train B Ventilation & Instrumentation Diagram.* (Ref. F2.2.52)
- *CRCF 1 Confinement ITS Battery Room Exhaust System – Train B Ventilation & Instrumentation Diagram.* (Ref. F2.2.50)
- *CRCF 1 Non-Confinement Areas HVAC Supply System Ventilation & Instrumentation Diagram.* (Ref. F2.2.63)
- *CRCF 1 Non-Confinement Misc. Areas Air Distribution System Ventilation & Instrumentation Diagram.* (Ref. F2.2.64)
- *CRCF 1 Non-Confinement WP Loadout Vestibule HVAC System Ventilation & Instrumentation Diagram.* (Ref. F2.2.67)
- *CRCF 1 Non-Confinement Site Transporter Vest. HVAC Syst Ventilation & Instrumentation Diagram.* (Ref. F2.2.65)
- *CRCF 1 Non-Confinement Transport, Cask/Annex Vest. HVAC System Ventilation & Instrumentation Diagram.* (Ref. F2.2.66)

HVAC equipment consists of HEPA filters, exhaust fans, air handling units, fan coil units, and sump pumps. Because any motor with a horse power of five or more is considered to be an initiator, the number of motors and the horsepower of each motor is determined for all applicable HVAC equipment identified. A piece of equipment containing motors is assigned a count based on the number of motors with a horsepower of five or more. Because HEPA filter units are not applicable to this process, a count of one is assigned for each.

F5.4.3 Mechanical Process Equipment

Information regarding mechanical process equipment locations and horsepower were obtained from the following facility general layout drawings, mechanical equipment lists, and equipment process and instrumentation drawings:

- Canister Receipt and Closure Facility 1 General Arrangement Ground Floor Plan. (Ref. F2.2.13)

- Canister Receipt and Closure Facility 1 General Arrangement Second Floor Plan. (Ref. F2.2.14)
- Canister Receipt and Closure Facility 1 General Arrangement Third Floor Plan. (Ref. F2.2.15)
- Equipment Motor Horsepower and Electrical Requirements Analysis. (Ref. F2.2.72)
- CRCF, RF, WHF, and IHF Cask Transfer Trolley Process and Instrumentation Diagram. (Ref. F2.2.71)
- CRCF 1 Chilled Water System Piping & Instrument Diagram. (Ref. F2.2.34)
- CRCF 1 Hot Water System Piping & Instrument Diagram. (Ref. F2.2.57)
- CRCF Cask Cavity Gas Sampling System Piping & Instrument Diagram. (Ref. F2.2.70)

Mechanical process equipment includes most of the motorized equipment to include cranes, trolleys, doors, and platforms. These are counted in the method described in Section F5.4.2 (i.e., each motor of five horsepower or more contributes a count of one). Because some of the equipment in this category is mobile, and counts are done for each room individually, it was necessary to consider the counts for equipment which can occupy more than one room. To accomplish this, the amount of time a piece of equipment spends in each room was identified using the process throughput Gantt charts (Ref. F2.2.3). The two waste package transfer trolleys (WPTT) and two cask transfer trolleys were identified as the only pieces of mobile equipment that occupy more than one room.

The total time a cask transfer trolley spends in either the Cask Unloading Room North (1023) or South (1024) is calculated from the following procedures identified in the process throughput:

- Move WPTT into waste package Positioning Room under waste package port—15 minutes
- Move canister transfer to waste package or staging or aging overpack—119 minutes
- Close waste package—2,445 minutes
- Change rigging on waste package handling crane—25 minutes
- Move loaded, sealed waste package to Waste Package Loadout Room and engage WPTT docking station—20 minutes.

The total time the WPTT spends in the Waste Package Loadout Room (1015) is calculated by subtracting the total amount of time the WPTT is in either room 1018 or 1019 from the total time of the procedure (3,722 minutes).

The time a mobile equipment item spends in each room is utilized to determine the percentage of time the equipment occupies a room, which directly corresponds to the percentage of the total

count assigned to that room. This is represented on the equipment list as the residence weighting factor (RWF).

F5.4.4. Heat Generating Process Equipment

This equipment refers to such things as furnaces, dryers and other such equipment except for those associated with the HVAC, which are counted separately as discussed above. There is no equipment for any of the facilities that falls under this category.

F5.4.5 Torches, Welders, and Burners

Welding operations are the only contributors to this category. The assignment of residency in this case is based on the estimated number of hours per year that welding operations are expected to occur in the area. This provides a suitable relative weight for apportioning fire ignition caused by welding operations. Portable welding receptacles are provided in various areas of the facility for the purpose of occasional welding of stationary equipment that may show signs of cracking. These are provided for convenience, and are not expected to see significant use. Each station is estimated to see on the order of five hours of use per year, and so is assigned a score of five points each. The primary maintenance area also contains a welding receptacle (the “primary welding station”), intended to perform all of the maintenance related welding for repair and fabrication that does not require direct work on a stationary piece of equipment (including on components of stationary pieces of equipment that are easily removed). The primary welding station is estimated to be utilized about eight hours per week, and so is assigned a score of 400 points. The CRCF also has the waste package closure system, which has weld end effectors. The number of hours of operation per year for the weld end effectors on the waste package closure system is estimated based on the throughput time-and-motion study and the number of waste packages expected to be handled, as follows:

- The preclosure period is 50 years.
- The welding machine actually operates for 13 hours per waste package (*Preliminary Throughput Study for the Canister Receipt and Closure Facility* (Ref. F2.2.3)).
- The CRCF will process 11,668 waste packages (*Waste Form Throughputs for Preclosure Safety Analysis* (Ref. F2.2.5)); $11,668 \times 13/50/3$ is 1,011 hours per year (a score of 1,011).

The locations of portable welding receptacles were determined as an engineering judgment on the part of the design team based on preliminary electrical and general layout drawings. The resultant fire initiating event frequencies are insensitive to the precise distribution of the portable welding receptacles, so a more rigorous analysis of the distribution is not required.

F5.4.6 Internal Combustion Engines

There are two transporters that utilize internal combustion engines in the CRCF, which provide the entire contribution of fire ignition to the internal combustion engines category. The site transporter and site prime mover (SPM) are assigned a total of 100 points each. The points are

allocated to the rooms where these vehicles could be located by use of a RWF, as discussed in Section F5.4.3.

The site transporter occupies rooms 1027 (Site Transporter Vestibule) and 1026 (Cask Preparation Room). The times necessary to determine the percentage of time the site transporter spends in each room are given in Sections 1.3.1, 2.1, and 1.6 of the CRCF process throughput diagram. There are 28 total minutes that are assigned to both rooms because the doors between them are open. Resultant times are 56 minutes in the Site Transporter Vestibule (1027), and 510 minutes in the Cask Preparation Room (1026).

The SPM/tractor occupies rooms 1026 (Cask Preparation Room), 1036 (Transportation Cask Vestibule), and 1036A (Vestibule Annex). The times necessary to determine the percentage of time the SPM/tractor spends in each room are given in Sections 1.1.1a through 1.1.1c of the CRCF process throughput diagram. There are 18 total minutes that are assigned to both rooms 1036A and 1036 because the doors between them are open. Similarly, there are a total of 18 minutes that are assigned to both rooms 1036 and 1026. Resultant times are 22 minutes in the Vestibule Annex (1036A), 36 minutes in the Transportation Cask Vestibule (1036), and 38 minutes in the Cask Preparation Room (1026).

The times internal combustion engines spend in each room is utilized to determine the percentage of time the engine occupies a room, which directly corresponds to the percentage of the total count assigned to that room. This is represented on the equipment list as the RWF, or residence weighting factor.

Locations of the internal combustion engines were determined solely from the general layout drawings.

F5.4.7 Office/Kitchen Equipment

This category consists of miscellaneous office and kitchen equipment such as: shredders, vending machines, microwaves, computers, radios and printers. The location and quantity of such equipment was inferred by the description and layout of the rooms to come up with a reasonable distribution of such equipment in the facility. Work rooms, break rooms, briefing rooms, and offices were considered to possess such equipment. A judgment was made by the analysis team based on the function and size of the room as to how much of such equipment might reside in these rooms. Points were assigned to each room expected to contain office or kitchen equipment based on this judgment (one point per room). The resultant fire initiating event frequencies are quite insensitive to the precise distribution of this equipment, so a more rigorous analysis of the distribution is not required.

Locations of the office and kitchen equipment were determined solely from the general layout drawings.

F5.4.8 Portable and Special Equipment

This category consists of portable hand tools, monitoring devices, portable heaters, diagnostic equipment and the like. Rooms where there were significant amounts of equipment that would expect to be maintained on a regular basis or where monitoring would take place were

considered to possess such equipment. Determinations for the portable and special equipment category were inferred from the description and layout of the rooms, as described in Section F5.4.7. Each room containing such equipment was assigned one to four points, depending on the quantity expected in that room. The resultant fire initiating event frequencies are quite insensitive to the precise distribution of this equipment, so a more rigorous analysis of the distribution is not required.

F5.5 ROOM IGNITION FREQUENCY

Ignition Frequencies for each room are determined as a function of the number of units of ignition sources in the room, and the area of the room. The spreadsheet used to determine these frequencies is displayed as Table F5.5-1.

Table F5.5-1. Fire Ignition Frequencies by Room

Room	Ignition Source Category and Room-by-Room Population									Room Ignition Frequency
	Electrical	HVAC	Mechanical Equipment	Heat Generating Equipment	Torches, Welders, Burners	Internal Combustion Engines	Office/ Kitchen Equipment	Portable Equipment	No Equipment Involved	
1001					5				233	8.8E-03
1001A		2						2	141	2.5E-02
1002									74	1.9E-03
1002A									13	3.2E-04
1003		4						2	164	3.5E-02
1004	1	4						2	119	3.5E-02
1005A									103	2.6E-03
1005B									68	1.7E-03
1005C									51	1.3E-03
1005D									67	1.7E-03
1005E									116	2.9E-03
1005F									109	2.8E-03
1005G									53	1.3E-03
1005H									58	1.5E-03
1005J									141	3.6E-03
1007	105							2	410	1.4E-01
1007A	2								36	3.2E-03
1008	25	2						2	164	5.4E-02
1008A	1								25	1.8E-03
1009		4			5			2	46	3.5E-02
1010		2						2	129	2.5E-02
1011		4						2	313	3.8E-02
1012									147	3.7E-03
1013	16						1		164	4.6E-02
1013A									11	2.8E-04
1014		2	2					1	385	4.0E-02
1015	1	2	9.2					2	1326	1.3E-01
1016									33	8.5E-04
1017									37	9.4E-04
1018			2.4					1	213	3.0E-02
1019			2.4					1	213	3.0E-02

Table F5.5-1. Fire Ignition Frequencies by Room (Continued)

Room	Electrical	HVAC	Mechanical Equipment	Heat Generating Equipment	Torches, Welders, Burners	Internal Combustion Engines	Office/ Kitchen Equipment	Portable Equipment	No Equipment Involved	Room Ignition Frequency
1020									33	8.5E-04
1021									31	7.8E-04
1022									28	7.0E-04
1023			1.05					1	78	1.6E-02
1024			1.05					1	78	1.6E-02
1025									28	7.0E-04
1026	1		19.9			130		4	2143	2.8E-01
1027		2	2		5	10			342	4.0E-02
1028	1	2	4		400				423	2.9E-01
1029	22	2						2	164	5.0E-02
1029A	1								25	1.8E-03
1030		4						2	46	3.2E-02
1031		2						2	139	2.5E-02
1032		4						2	307	3.8E-02
1033									144	3.7E-03
1034									48	1.2E-03
1035		4						2	184	3.5E-02
1036		2				37			239	2.9E-02
1036A		2				23			208	2.3E-02
1036B									20	5.2E-04
1037									51	1.3E-03
1038									39	9.8E-04
1039									39	9.9E-04
1040									39	9.9E-04
1041									48	1.2E-03
1042									42	1.1E-03
1043									36	9.2E-04
1044			1						20	8.1E-03
1044A									7	1.9E-04
1045									27	6.9E-04
1046									7	1.6E-04
1047			1						76	9.5E-03
1047A									66	1.7E-03

Table F5.5-1. Fire Ignition Frequencies by Room (Continued)

Room	Electrical	HVAC	Mechanical Equipment	Heat Generating Equipment	Torches, Welders, Burners	Internal Combustion Engines	Office/ Kitchen Equipment	Portable Equipment	No Equipment Involved	Room Ignition Frequency
1048									42	1.1E-03
1049			1						76	9.5E-03
1049A									66	1.7E-03
1050									42	1.1E-03
1051									32	8.1E-04
1052									32	8.1E-04
1053									28	7.0E-04
1054									29	7.4E-04
1201 - 1210							5		226	1.2E-01
1211 - 1213 & 1215 - 1222							4		295	1.0E-01
1214									54	1.4E-03
2001	26	6						4	433	9.2E-02
2002					5				183	7.6E-03
2003	11		1					1	211	3.2E-02
2003A									19	4.9E-04
2004		2	14		10			1	3846	2.2E-01
2005	21	2						4	511	7.1E-02
2005A									33	8.2E-04
2006A									90	2.3E-03
2006B									71	1.8E-03
2006D									90	2.3E-03
2006E									52	1.3E-03
2006F									38	9.6E-04
2006G									129	3.3E-03
2006H									40	1.0E-03
2006J									89	2.2E-03
2006K									73	1.8E-03
2007			5		946			2	247	6.1E-01
2007A	9							1	27	1.7E-02
2007B								1	27	7.0E-03
2008	16	2						4	433	6.3E-02
2010					5				186	7.6E-03
2011	11		1					1	224	3.2E-02

Table F5.5-1. Fire Ignition Frequencies by Room (Continued)

Room	Electrical	HVAC	Mechanical Equipment	Heat Generating Equipment	Torches, Welders, Burners	Internal Combustion Engines	Office/ Kitchen Equipment	Portable Equipment	No Equipment Involved	Room Ignition Frequency
2011A									19	4.8E-04
2012	12	4						4	493	6.9E-02
2038									40	1.0E-03
2039									42	1.1E-03
2040									42	1.1E-03
2041									48	1.2E-03
2042									42	1.1E-03
2043									36	9.2E-04
2045									15	3.8E-04
2045A									15	3.8E-04
2046									6	1.5E-04
2048									42	1.1E-03
2050									43	1.1E-03
3001									121	3.0E-03
3002									61	1.5E-03
3038									40	1.0E-03
3041									48	1.2E-03
3045									15	3.8E-04
3045A									15	3.8E-04
3046									7	1.6E-04
3048									42	1.1E-03
3050									43	1.1E-03
TOTAL	282	66	68	0	1381	200	10	60		3.1E+00

NOTE: HVAC = heating, ventilation, and air conditioning.

Source: Original

The major input to the spreadsheet is the number of units per category for each room (green text). These values are taken from the equipment list Table F5.4-1, which is formulated from equipment and general layout drawings, and equipment lists (see Section F5.4). The total number of units in each category is the result of a sum across all rooms, and can be found in the bottom total row. It is this value that is used in Table F5.3-1 in the column entitled “Category Population” for all categories except no equipment involved, as explained in Section F5.3.

The no equipment involved column of Table 5.5-1 is the area of the rooms, as a unit in this category is represented by a single square meter. These values are taken from Table F5.2-1, in the “A” column (square meters).

The final column on Table F5.5-1, entitled “Room Ignition Frequency,” implements the generic forms of equations F-6 and F-7. It calculates the room ignition frequency, which utilizes the frequency per unit from Section F5.3. It takes the required per unit ignition frequencies directly from the spreadsheet represented by Table F5.3-1, the column entitled “Frequency per Unit”. Per Equation F-6, the number of units in each category (green text) is multiplied by the corresponding frequency per unit for that category. Per Equation F-7, summing these multiplications across a row provides the room ignition frequency for that room. The sum of all rooms is the building ignition frequency. This value is shown in the lower right hand column of the Table. Note that this value does not match the value shown at the bottom of Table F5.2-1. That value, which is based only on building area, pre-supposes that the ignition sources in the building cover each of entire ignition source categories used in the analysis. However, the CRCF does not have any equipment that fits the definition of heat generating equipment (welders have their own category), so this contribution does not apply to CRCF.

F5.6 PROPAGATION PROBABILITIES

Propagation probabilities are utilized in this analysis to define the probability of a fire spreading to various defined points. The first two columns of Table F5.6-1 define the maximum extent of propagation, and the conditional probability column is the probability associated with that extent of propagation. The remaining columns in Table F5.6-1 are utilized in the uncertainty distribution for the conditional probability. The structure of this spreadsheet is analogous to Table F5.3-1. The right hand group of columns is used by Crystal Ball to apply an uncertainty distribution to each of the propagation probability values for the purpose of developing uncertainty distributions on initiating event frequency. The mean fraction, 97.5% value, and 97.5th percentile add columns show the parameters of these distributions. The development of all of the values is detailed in Appendix F.II. When Crystal Ball is run, it creates a sampled value for each fraction in the sampled value column. The spreadsheet then determines a normalized value by first assuring that each sampled value is not negative (minimum value of zero) and then normalizing the values so that the sum is always equal to one. The normalized value for each trial then replaces the category fraction value in the calculation. These probabilities must always add to one, as the groupings include all possible propagation outcomes.

Table F5.6-1. Fire Propagation Probabilities

		Conditional Probability	Normalized Value	Sampled Value	Mean Fraction	97.5% Value	97.5th percentile add
Automatic Suppression Functional							
Extent of Propagation	Alternative Definition						
Confined to Object of Origin	No Propagation	0.551	0.551	0.551	0.551	0.667	0.117
Confined to Part of Room of Origin	Spreads Through Part of Room of Origin	0.317	0.317	0.317	0.317	0.426	0.109
Confined to Room of Origin	Spreads Throughout Room of Origin	0.028	0.028	0.028	0.028	0.066	0.038
Confined to Fire-Rated Area of Origin	Spreads Throughout Fire-Rated Area of Origin	0.005	0.005	0.005	0.005	0.020	0.016
Confined to Floor of Origin	Spreads Throughout Floor of Origin	0.069	0.069	0.069	0.069	0.128	0.059
Confined to Structure of Origin	Spreads Throughout Building	0.028	0.028	0.028	0.028	0.055	0.028
Extended Beyond Structure of Origin	Breaches Building Boundary	0.005	0.005	0.005	0.005	0.020	0.016
		1.000	1.000				
		0.101					
Automatic Suppression Fails							
Extent of Propagation	Alternative Definition						
Confined to Object of Origin	No Propagation	0.621	0.621	0.621	0.621	0.725	0.104
Confined to Part of Room of Origin	Spreads Through Part of Room of Origin	0.149	0.149	0.149	0.149	0.226	0.076
Confined to Room of Origin	Spreads Throughout Room of Origin	0.004	0.004	0.004	0.004	0.017	0.013
Confined to Fire-Rated Area of Origin	Spreads Throughout Fire-Rated Area of Origin	0.057	0.057	0.057	0.057	0.107	0.050
Confined to Floor of Origin	Spreads Throughout Floor of Origin	0.004	0.004	0.004	0.004	0.017	0.013
Confined to Structure of Origin	Spreads Throughout Building	0.161	0.161	0.161	0.161	0.240	0.079
Extended Beyond Structure of Origin	Breaches Building Boundary	0.004	0.004	0.004	0.004	0.017	0.013
		1.000	1.000				

Source: Original

F5.7 INITIATING EVENT FREQUENCIES

Initiating event frequencies are the final results of the fire hazard analysis, and are a factor of all of the previously discussed data and residence fractions. The following sections shall describe the culmination of this data to conclude with initiating event frequencies.

F5.7.1 Residence Fractions

Residence fractions have been developed from process throughputs to determine the length of time a waste form is vulnerable in a particular area of the building and in a particular configuration. The source for all of the times related to transportation, aging, and disposal (TAD) canister, high-level radioactive waste (HLW), and U.S. Department of Energy (DOE)-spent nuclear fuel (SNF) is the CRCF throughput study (Ref. F2.2.3). Table F5.7-1 shows the vulnerabilities for the TAD canister, and the times that contribute to the overall time of vulnerability. The column labeled BFD Task refers to the task number from the process block flow diagram that was used in the throughput study. These numbers appear directly on the Gantt charts and provide a reference for the task that was considered. The total shows the total number of minutes that the waste form was in the specified configuration in the specified location. The fraction column implements the approach discussed in Section F4.4.1 to calculate the fraction of time that a specific waste form spends in the particular configuration and location over the 50-year pre-closure period. Similarly to the TAD canister residence fractions, the process throughputs have been utilized to determine residence fractions for HLW and DOE SNF (see Table F5.7-2).

In addition to the processing of TAD canisters, HLW, and DOE SNF for emplacement, it is possible that the CRCF is used as a back-up to the Receipt Facility (RF) for moving dual-purpose canister from a transportation cask that is upended on a railcar to an aging overpack for transport to the aging pads. As this is not a primary function of the CRCF, this is not included in the CRCF throughput study. In order to incorporate this into the fire analysis, the information from the throughput study for the RF (Ref. F2.2.4) is used to determine the needed residence times. This is valid because the equipment design for both the RF and CRCF and the process for performing this function are identical in both facilities. The result of this analysis for dual-purpose canister is provided in Table F5.7-3.

F5.7.2 Localized Fires

Initiating event frequencies have been divided into two types of calculations; localized and large fires. Table F5.7-4 contains all of the calculations contributing to the localized fire initiating event frequencies.

F5.7.2.1 Room Groupings

The first column of Table F5.7-4 identifies the room(s) of origin. If the vulnerability is expected to occur in a single room with no gates or doors open and that is surrounded by qualified fire barriers (i.e., it is a single room fire area), this room is listed as the only room of origin. However, there are several cases in which the vulnerability takes place as the waste form moves between multiple rooms, or the room where the vulnerability occurs has open doors or gates with other rooms, or it shares a qualified fire area with other rooms. Table F5.7-5 lists all of the vulnerabilities that have more than one room of origin, and the justification for the multiple room listing. Whenever such a condition exists, the quantification of the localized fire considers not only fires that start in the room where the waste form resides, but also the contribution of other rooms that could directly communicate with that room through non-qualified or open fire barriers. Rooms within the same fire area of a room of origin are listed under each vulnerability in the column labeled “propagation from rooms in fire zone.”

For rooms of origin, the frequency per unit column is populated by the results in Section F5.3. This is discussed further in Section F5.7.2.2. Propagation rooms populate the frequency per unit column with the total ignition frequency for that room, as calculated and reviewed in Section F4.4 (Room Ignition Frequency).

Table F5.7-1. TAD Residence Fractions

Section I - Localized Fires							
BFD Task	Steps (if needed)	Time (m)	Fraction	BFD Task	Steps (if needed)	Time (m)	Fraction
TC/TAD on Rail Car in Vestibule/Prep Area w/SPM (Diesel Present)				TAD in AO in Vestibule/Prep Area (Diesel Present)			
1.1.1a	Steps 3-7	16		1.3.1		31	
1.1.1a (typo?)		10		1.3.2		169	
1.1.1b		10		1.3.3		20	
1.1.1c	Steps 1-6	18		Total		220	8.4E-06
Total		54	2.1E-06				
TC/TAD on Rail Car in Prep Area w/o SPM (No Diesel Present)							
1.1.1c	Step 7	2					
1.1.1d		0					
1.1.4a	Change rigging	25					
1.1.4b		73					
1.1.4c	Change rigging	15					
1.1.4d		78					
1.1.4e	Change rigging	15					
1.1.5		70					
1.1.6		52					
Not in BFD	Change rigging	35					
1.1.7		30					
Total		395	1.5E-05				

Table F5.7-1. TAD Residence Fractions (Continued)

BFD Task	Steps (if needed)	Time (m)	Fraction		BFD Task	Steps (if needed)	Time (m)	Fraction
TC/TAD on CTT in Prep Area								
1.1.8		35						
1.1.9		25						
Not in BFD	Change rigging	25						
Not in BFD	Helium Gas Sampling	45						
1.1.10		182						
1.1.11		2						
1.1.12		30						
Not in BFD	Prep Clean CHC	25						
1.1.13		2						
1.1.14		25						
1.1.20 (sic)		15						
Total		411	1.6E-05					
TC/TAD on CTT in Unloading Room					TAD in AO in Unloading Room (Diesel Present)			
1.1.20	again	15			1.3.3	Again	20	
2.1.1		10			2.1.1		10	
2.1.2		2			2.1.2		2	
2.1.3a		15			2.1.3a		15	
2.1.3b		2			2.1.3b		2	
2.1.4		17			2.1.4		17	
2.1.5		5			2.1.5		5	
2.1.6		2			2.1.6		2	
2.1.7		20			2.1.7		20	
Total		88	3.3E-06		Total		93	3.5E-06
TAD in CTM in Transfer Room					Same From This Point On			
2.1.7	Step 3 (again)	10						
2.1.8		2						
2.1.17		5						
2.1.18		2						
2.1.19	Step 1	10						
Total		29	1.1E-06					

Table 5.7-1. TAD Residence Fractions (Continued)

BFD Task	Steps (if needed)	Time (m)	Fraction
TAD in WP in Positioning/Closure Room			
2.1.19		20	
2.1.20		2	
2.1.21		15	
3.1		2445	
Not in BFD	Change rigging	25	
4.2.1		20	
Total		2527	9.6E-05
TAD in WP in Loadout Room			
4.2.1	Again	20	
Not in BFD	TEV into Facility	46	
4.2.2		40	
4.2.3		60	
4.2.4	Steps 1-4	20	
Total		186	7.1E-06
TAD/WP in TEV in Loadout Room			
4.2.4	Steps 5-11	31	
Total		31	1.2E-06
Section II - Large Fire			
TC/TAD w/SPM Present (Diesel)			
1.1.1a	Steps 3-7	16	
1.1.1a (typo?)		10	
1.1.1b		10	
1.1.1c	Steps 1-6	18	
Total		54	2.1E-06

Table 5.7-1. TAD Residence Fractions (Continued)

BFD Task	Steps (if needed)	Time (m)	Fraction
TC/TAD w/o SPM Present (No Diesel)			
1.1.1c	Step 7	2	
1.1.1d		0	
1.1.4a	Change rigging	25	
1.1.4b		73	
1.1.4c	Change rigging	15	
1.1.4d		78	
1.1.4e	Change rigging	15	
1.1.5		70	
1.1.6		52	
Not in BFD	Change rigging	35	
1.1.7		30	
1.1.8		35	
1.1.9		25	
Not in BFD	Change rigging	25	
Not in BFD	Helium Gas Sampling	45	
1.1.10		182	
1.1.11		2	
1.1.12		30	
Not in BFD	Prep Clean CHC	25	
1.1.13		2	
1.1.14		25	
1.1.20 (sic)		15	
2.1.1		10	
2.1.2		2	
2.1.3a		15	
2.1.3b		2	
2.1.4		17	
2.1.5		5	
2.1.6		2	
Total		859	3.3E-05
TAD in CTM			
2.1.7		30	
2.1.8		2	
2.1.17		5	
2.1.18		2	
Total		39	1.5E-06
TAD in WP in WPTT			
2.1.19		20	
2.1.20		2	
2.1.21		15	
3.1		2445	
Not in BFD	Change rigging	25	
4.2.1		20	
Not in BFD	TEV into Facility	46	
4.2.2		40	
4.2.3		60	
4.2.4		5	
Total		2678	1.0E-04

Table 5.7-1. TAD Residence Fractions (Continued)

BFD Task	Steps (if needed)	Time (m)	Fraction
TAD in WP in TEV			
4.2.4		46	
Total		46	1.8E-06
TAD in AO (Diesel Present)			
1.3.1		31	
1.3.2		169	
1.3.3		20	
2.1.1		10	
2.1.2		2	
2.1.3a		15	
2.1.3b		2	
2.1.4		17	
2.1.5		5	
2.1.6		2	
2.1.7		20	
Total		293	1.1E-05

NOTE: AO = aging overpack; BFD = block flow diagram; CTM = canister transfer machine;
CTT = cask transfer trolley; SPM = site prime mover; TAD = transportation, aging, and disposal;
TC = transportation cask; TEV = transport and emplacement vehicle; WP = waste package;
WPTT = waste package transfer trolley.

Source: Original

Table F5.7-2. HLW and DOE-SNF Residence Fractions

Section I - Localized Fires							
BFD Task	Steps (if needed)	Time (m)	Fraction	BFD Task	Steps (if needed)	Time (m)	Fraction
TC/HLW on Rail Car in Vestibule/Prep Area w/SPM (Diesel Present)				TC/DOE-SNF on Rail Car in Vestibule/Prep Area w/SPM (Diesel Present)			
1.1.1a	Steps 3-7	18		Same as HLW			
1.1.1a (typo?)		10					
1.1.1b		10					
1.1.1c	Steps 1-6	18					
Total		56	2.1E-06				
TC/HLW on Rail Car in Prep Area w/o SPM (No Diesel Present)				TC/DOE-SNF on Rail Car in Prep Area w/o SPM (No Diesel Present)			
1.1.1c	Step 7	2		1.1.1c	Step 7	2	
1.1.1d		75		1.1.1d		0	
1.1.4a	.	25		1.1.4a	.	25	
1.1.4b		73		1.1.4b		73	
1.1.4c	.	15		1.1.4c	.	15	
1.1.4d		78		1.1.4d		78	
1.1.4e	.	15		1.1.4e	.	15	
1.1.5		70		1.1.5		70	
1.1.6		52		1.1.6		52	
Not in BFD	Change rigging	35		Not in BFD	Change rigging	35	
1.1.7		30		1.1.7		30	
Total		470	1.8E-05	Total		395	1.5E-05
TC/HLW on CTT in Prep Area				TC/DOE-SNF on CTT in Prep Area			
1.1.8		35		1.1.8		35	
1.1.9		25		1.1.9		25	
Not in BFD	Secure CHC	25		Not in BFD	Helium Gas Sampling	45	
1.1.10		182		1.1.10		182	
1.1.11		2		1.1.11		2	
1.1.12		30		1.1.12		30	
Not in BFD	Prep Clean CHC	25		Not in BFD	Prep Clean CHC	25	
1.1.13		2		1.1.13		2	
1.1.14		25		1.1.14		25	
1.1.15		15		1.1.20		15	
Total		366	1.4E-05	Total		386	1.5E-05
TC/HLW on CTT in Unloading Room				TC/DOE-SNF on CTT in Unloading Room			
1.1.15	again	15		1.1.20	again	15	
2.1.1		10		2.1.1		10	
2.1.2		2		2.1.2		2	
2.1.3a		15		2.1.3a		15	
2.1.3b		2		2.1.3b		2	
2.1.4		17		2.1.4		17	
2.1.5-6, 34-35, 44-47	x5 (five canisters)	289		2.1.5-6 & 2.1.34-39	x9 (nine canisters)	493	
Total		350	1.3E-05	Total		554	2.1E-05

pja:
It takes 67 minutes to move each HLW canister from the TC to the WP (BFD tasks 2.1.5-6, 2.1.34-35 and 2.1.44-47, repeated five times). 67*5=335 minutes. For the last 46 minutes of this process there are no canisters in the TC (the last one is on its way to the WP upon completion of BFD task 2.1.5.34 for the fifth time). 335-46 = 289 minutes. This is the time period over which at least one canister would be in the TC during the unloading process.

pja:
It takes 58 minutes to move each DOE-SNF canister from the TC to the Staging Area (BFD tasks 2.1.5-6 and 2.1.34-39, repeated nine times). 58*9=522 minutes. For the last 29 minutes of this process there are no canisters in the TC (the last one is on its way to the WP upon completion of BFD task 2.1.5.34 for the fifth time). 522-29 = 493 minutes. This is the time period over which at least one canister would be in the TC during the unloading process.

Table F5.7-2. HLW and DOE-SNF Residence Fractions (Continued)

BFD Task	Steps (if needed)	Time (m)	Fraction		BFD Task	Steps (if needed)	Time (m)	Fraction											
HLW in CTM in Transfer Room (per HLW Canister!!)					DOE-SNF in CTM in Transfer Room (per SNF Canister!!!)					<p>pja: This timeframe is the same for bringing SNF from staging to WP, although BFD numbers are different (42-46)</p>									
2.1.34	Step 3 (again)	5		2.1.34	Step 3 (again)	10													
2.1.35		2		2.1.35		2													
2.1.44		15		2.1.36		5													
2.1.45		2		2.1.37		2													
2.1.46	Step 1	10		2.1.38	Step 1	10													
Total		34	1.3E-06	Total		29	1.1E-06												
HLW in WP in Positioning Room					<p>pja: As with the unloading room, the process of moving five canisters means that at least one canister will be in the WP from the time the first one enters until the last one enters. As previously stated, moving all five canisters takes 335 minutes. The first canister takes 40 minutes to reach the WP (BFD 2.1.5-6, 2.1.34-35, and 2.1.44-45 the first time). 335-40=295, which accounts for the entire time period that there is at least one canister in the WP during the loading process.</p>														
2.1.5-6, 34-35, 44-47	x5 (five canisters)	295																	
2.1.40		5		<p>pja: Steps 40-45 represent bringing the DOE-SNF canister from staging to above the WP. During this time there is only HLW in the WP.</p>															
2.1.41		2																	
2.1.42		20																	
2.1.43		2																	
2.1.44		5																	
2.1.45		2																	
		331	1.3E-05																
HLW and DOE-SNF in WP in Positioning Room																			
2.1.46		20																	
2.1.48 (sic)		5																	
2.1.49		17																	
2.1.50		5																	
2.1.51		22																	
2.1.20		2																	
2.1.21		15																	
3.1		2445																	
Not in BFD	Change rigging	25																	
4.2.1		20																	
Total		2576	9.8E-05																
HLW and DOE-SNF in WP in Loadout Room																			
4.2.1	Again	20																	
Not in BFD	TEV into Facility	46																	
4.2.2		40																	
4.2.3		60																	
4.2.4	Steps 1-4	20																	
Total		186	7.1E-06																
HLW and DOE-SNF in WP in TEV in Loadout Room																			
4.2.4	Steps 5-11	31																	
Total		31	1.2E-06																

Table F5.7-2. HLW and DOE-SNF Residence Fractions (Continued)

BFD Task	Steps (if needed)	Time (m)	Fraction			BFD Task	Steps (if needed)	Time (m)	Fraction						
Section II - Large Fire															
TC/HLW w/SPM Present (Diesel)								TC/DOE-SNF w/SPM (Diesel Present)							
1.1.1a	Steps 3-7	16				Same as HLW									
1.1.1a (typo?)		10													
1.1.1b		10													
1.1.1c	Steps 1-6	18													
Total		54	2.1E-06												
TC/HLW w/o SPM Present (No Diesel)								TC/DOE-SNF w/o SPM (No Diesel Present)							
1.1.1c	Step 7	2				1.1.1c	Step 7	2							
1.1.1d		75				1.1.1d		0							
1.1.4a	.	25				1.1.4a	.	25							
1.1.4b		73				1.1.4b		73							
1.1.4c	.	15				1.1.4c	.	15							
1.1.4d		78				1.1.4d		78							
1.1.4e	.	15				1.1.4e	.	15							
1.1.5		70				1.1.5		70							
1.1.6		52				1.1.6		52							
Not in BFD	Change rigging	35				Not in BFD	Change rigging	35							
1.1.7		30				1.1.7		30							
1.1.8		35				1.1.8		35							
1.1.9		25				1.1.9		25							
Not in BFD	Secure CHC	25				Not in BFD	Helium Gas Sampling	45							
1.1.10		182				1.1.10		182							
1.1.11		2				1.1.11		2							
1.1.12		30				1.1.12		30							
Not in BFD	Prep Clean CHC	25				Not in BFD	Prep Clean CHC	25							
1.1.13		2				1.1.13		2							
1.1.14		25				1.1.14		25							
1.1.15		15				1.1.20		15							
2.1.1		10				2.1.1		10							
2.1.2		2				2.1.2		2							
2.1.3a		15				2.1.3a		15							
2.1.3b		2				2.1.3b		2							
2.1.4		17				2.1.4		17							
2.1.5		5				2.1.5		5							
2.1.6		1				2.1.6		1							
Total		888	3.4E-05			Total		833	3.2E-05						
HLW in CTM in Transfer Room (per HLW Canister!!)								DOE-SNF in CTM in Transfer Room (per SNF Canister!!!)							
2.1.34		20				2.1.34	Step 3 (again)	10							
2.1.35		2				2.1.35		2							
2.1.44		5				2.1.36		5							
2.1.45		2				2.1.37		2							
2.1.46	Step 1	10				2.1.38	Step 1	10							
Total		39	1.5E-06			Total		29	1.1E-06						

pja:
The movement of multiple canisters must be handled differently for large fire. Considering all the possible combinations of canisters and locations during the movement phase would overly complicate the analysis. Since the assumption is being made that there are always DOE-SNF canisters in the staging area, the analysis will assume that all nine canisters are in the staging area from the time the first canister arrives, and that if any canister fails they will all fail. To add the residence time for the DOE-SNF canisters for the entire time they are in the TC would be to significantly double count the residence time, since we are already simplifying the analysis by double counting by considering nine DOE-SNF canisters to reside in the staging area while nine DOE-SNF canisters reside in other areas of the facility, so further double-counting is not appropriate. This is a conservative assumption that will bound the release frequency and magnitude from a large fire during DOE-SNF canister movement to staging.

pja:
The movement of multiple canisters must be handled differently for large fire. Considering all the possible combinations of canisters and locations during the movement phase would overly complicate the analysis. Since the canisters are most vulnerable when they are in a waste package, the analysis will assume that all five canisters are in the waste package from the time the first canister arrives, and that if any canister fails they will all fail. This is a conservative assumption that will bound the release frequency and magnitude from a large fire during HLW canister movement.

pja:
This timeframe is the same for bringing SNF from staging to WP, although BFD numbers are different (42-46)

Table F5.7-2. HLW and DOE-SNF Residence Fractions (Continued)

BFD Task	Steps (if needed)	Time (m)	Fraction		BFD Task	Steps (if needed)	Time (m)	Fraction							
HLW in WP					DOE-SNF in Staging Area										
2.1.5-6, 34-35, 44-47	x5 (five canisters)	295			Assume there is always DOE-SNF in the staging area.										
2.1.40		5			Residence time fraction is 1.0										
2.1.41		2													
2.1.42		20													
2.1.43		2													
2.1.44		5													
2.1.45		2													
Total		331	1.3E-05												
HLW and DOE-SNF in WP															
2.1.46		20													
2.1.48 (sic)		5													
2.1.49		17													
2.1.50		5													
2.1.51		22													
2.1.20		2													
2.1.21		15													
3.1		2445													
Not in BFD	Change rigging	25													
4.2.1		20													
Not in BFD	TEV into Facility	46													
4.2.2		40													
4.2.3		60													
4.2.4		51													
Total		2773	1.1E-04												

pja:
The operational approach for receiving DOE-SNF and HLW has not been established. It is unclear whether the process will be coordinated such that HLW will always follow DOE-SNF so that the staging area will be emptied soon after it is filled. It is conceivable that DOE-SNF will be staged and simply await HLW to arrive. The SNF could be in staging for extended periods.

pja:
The movement of multiple canisters must be handled differently for large fire. Considering all the possible combinations of canisters and locations during the movement phase would overly complicate the analysis. Since the canisters are most vulnerable when they are in a waste package, the analysis will assume that all five canisters are the waste package from the time the first canister arrives, and that if any canister fails they will all fail. This is a conservative assumption that will bound the release frequency and magnitude from a large fire during HLW canister movement. The process of moving five canisters means that at least one canister will be in the WP from the time the first one enters until the last one enters. As previously stated, moving all five canisters takes 290 minutes. The first canister takes 36 minutes to reach the WP (BFD 2.1.5-6 and 2.1.34-37, the first time). 290-36=254, which accounts for the entire time period that there is at least one canister in the WP during the loading process.

pja:
Steps 40-45 represent bringing the DOE-SNF canister from staging to above the WP. During this time there is only HLW in the WP.

NOTE: BFD = block flow diagram; CTM = canister transfer machine; CTT = cask transfer trolley; DOE = U.S. Department of Energy; HLW = high-level radioactive waste; SNF = spent nuclear fuel; SPM = site prime mover; TC = transportation cask; TEV = transport and emplacement vehicle; WP = waste package.

Source: Original

Table F5.7-3. DPC Residence Fractions

BFD Task	Steps (if needed)	Time (m)	Fraction			
TC/DPC (VTC) in Vestibule/Prep Area w/SPM/Truck (Diesel Present)						
1.1.1		56				
Total		56	2.1E-06			
TC/DPC (VTC) on Railcar/Trailer in Prep Area w/o SPM/Truck (No Diesel Present)						
1.1.4		138				
Not in BFD	Inspections and Survey	55				
1.1.5		83				
1.1.7		55				
1.3.1	Steps 1-2	15				
Total		346	1.3E-05			
<div style="border: 1px solid black; padding: 5px; background-color: #ffffcc;"> <p>L. Plumb: DPCs shall be processed at the CRCF if the RF is overwhelmed with DPCs. Because this function is not in the CRCF Process Throughput diagram, the residence times from the RF were used for this column.</p> </div>						
TC/DPC (VTC) on CTT in Prep Area						
1.3.1	Steps 3-8	50				
1.3.2		5				
1.3.3		108				
1.3.4		5				
1.3.5		35				
1.3.6		5				
1.3.7		40				
1.3.8		5				
1.3.9		50				
1.3.10		40				
1.3.11		5				
1.3.12		20				
1.3.13		20				
Total		388	1.5E-05			
TC/DPC (VTC) in CTT in Unloading Room						
1.1.13	Again	20				
2.1.5		6				
2.1.6		1				
2.1.11	Steps 1-3	20				
Total		47	1.8E-06			
DPC (VTC) in CTM in Transfer Room						
2.1.11	Step 3-4 (again)	15				
2.1.12		1				
2.1.13		5				
2.1.14		1				
2.1.15	Step 1	10				
Total		32	1.2E-06			

Table F5.7-3. DPC Residence Fractions (Continued)

BFD Task	Steps (if needed)	Time (m)	Fraction
DPC (VTC) in AO in Unloading Room (Diesel)			
2.1.15	again	21	
2.1.16		1	
2.1.17		22	
2.1.18		5	
2.1.19		17	
2.1.20		1	
1.5.1		20	
Total		87	3.3E-06
DPC (VTC) in AO in Vestibule/Preparation Area (Diesel)			
1.5.1	Again	20	
1.5.2		242	
Not in BFD	Rad Inspection	30	
1.5.3	Steps 1-5	26	
Total		318	1.2E-05
Section II - Large Fire			
TC/DPC (VTC) w/SPM (Diesel)			
1.1.1		56	
Total		56	2.1E-06
TC/DPC (VTC) w/o SPM Present (No Diesel)			
1.1.4		138	
Not in BFD	Inspections and Survey	55	
1.1.5		83	
1.1.7		55	
1.3.1	Steps 1-2	15	
1.3.1		65	
1.3.2		5	
1.3.3		108	
1.3.4		5	
1.3.5		35	
1.3.6		5	
1.3.7		40	
1.3.8		5	
1.3.9		50	
1.3.10		40	
1.3.11		5	
1.3.12		20	
1.3.13		20	
2.1.5		6	
2.1.6		1	
2.1.11	Steps 1-3	20	
Total		776	3.0E-05

Table F5.7-3. DPC Residence Fractions (Continued)

BFD Task	Steps (if needed)	Time (m)	Fraction
DPC (VTC) in CTM			
2.1.11	Step 3-4 (again)	15	
2.1.12		1	
2.1.13		5	
2.1.14		1	
2.1.15	Step 1	10	
Total		32	1.2E-06
DPC (VTC) in AO (Diesel Present)			
2.1.15	again	21	
2.1.16		1	
2.1.17		22	
2.1.18		5	
2.1.19		17	
2.1.20		1	
1.5.1		20	
1.5.2		242	
Not in BFD	Rad Inspection	30	
1.5.3	Steps 1-5	26	
Total		385	1.5E-05

NOTE: AO = aging overpack; BFD = block flow diagram; CTM = canister transfer machine; CTT = cask transfer trolley; DPC = dual-purpose canister; SPM = site prime mover; TC = transportation cask; VTC = a transportation cask that is upended on a railcar; WP = waste package; WPTT = waste package transfer trolley.

Source: Original

F5.7.2.2 Ignition Source Distribution Within a Room

Per the methodology discussion in Section F4.4.2.1, the location of the ignition sources within the room are identified relative to the target and assigned a location at the target, near the target, and away from the target. This is shown in the so-named columns of Table F5.7-4, and must sum to the ‘number in room’ column entry. These columns are designators of where the ignition sources are in relation to the vulnerable waste form.

For all categories except no equipment involved, the distribution is determined by analysis of the room layout to determine whether the ignition source unit is at a distance within about three meters (at target), between about 3 and 7 meters (near target), or further (away from target) of the vulnerable waste form. For vulnerable waste forms in motion (e.g., in the railcar), ignition sources within the aforementioned distances of any portion of the path of motion are counted in the class representing its closest point to the waste form.

The ignition source units for the no equipment involved category are the area of the room (square meters). For vulnerabilities that are not waste forms in motion, the numbers for at target and near target are 30 and 120, respectively (i.e., a floor area of approximately 30 square meters is considered at the target and the next 120 square meters near the target). The remaining square meters are entered as away from target. For vulnerable waste forms in motion, the “at target”

value is the total square meters covered by the full range of motion plus a three meter ring. Similarly, the number near target is figured to be a seven meter ring around the at target area. Remaining square meters are entered as away from target.

The distribution of ignition sources are used to determine how far a fire must spread before it reaches the vulnerable waste form. The propagation values are taken from Table F5.6-1 for the no suppression case, per the boundary conditions, in accordance with the guidance discussed in Section F4.4.2 (in particular, F4.4.2.1). The frequency per (ignition source) unit is taken from Table F5.3-1, the column labeled frequency per unit. The target exposure time (fraction), which is the probability that there is a waste form in the room is taken from Table F5.7-1, F5.7-2, and F5.7-3 as appropriate. The column labeled "Contribution to IE Frequency" implements Equation F-8 to provide the total initiating event frequency contribution from fire that start in the room where the waste form resides.

There is also a section of the Table F5.7-4 that addresses the contribution from nearby rooms in the same fire area (i.e., that are separated from the room by walls or doors, but those barriers are not qualified fire barriers). In this case, the location of the ignition sources within these rooms is not important, only the probability that the fire spreads beyond the room within the same fire area matters as to whether the fire reaches the target. In this case, the frequency per unit column refers to the overall frequency of ignition in the room, which comes from the last column in Table F5.5-1. In this case, the appropriate propagation value for spread of a fire beyond the room is taken from Table F5.6-1, again for the no suppression case, as discussed in Section F4.4.2 (in particular, F4.4.2.2). For these rooms, the Contribution to IE Frequency column implements the generic form of Equation F-9 as applied to a fire throughout a fire area (zone) where the next largest fire is a floor fire.

The overall fire initiating event frequency, provided in a shaded cell for each defined initiating event shown in bold, is the sum of all the individual contributors.

F5.7.3 Large Fires

Calculation of the initiating event frequencies is completed similarly to the localized fire contributions from other rooms. Table F5.7-6 provides the analysis. In this case, the fire can start in any room in the facility and become a large fire. Since the fire can start in any room, and the methodology applies the same probability of fire propagation to each room, the starting point is the total ignition frequency from all rooms, from Table F5.6-1. The propagation probability is applied as discussed in Section F4.4.2 (in particular, F4.4.2.2) to implement Equation F-10. The target exposure time (fraction) is once again taken from Tables F5.7-1, -2, and -3; that large fires always propagate beyond the fire area of the room of origin.

F5.7.4 Contribution to Initiating Event Frequency

The probability of a fire reaching the vulnerable waste form and the target exposure time (residence fractions; refer to Section F5.7.1) contribute to the final calculation of the contribution to initiating event frequency (cells highlighted in blue on Tables F5.7-4 and F5.7-6). Section F4.4 details the calculations performed to arrive at the initiating event frequency.

Table F5.7-4. Localized Fire Initiating Event Frequencies

Localized Fires That Threatens Waste Form																
Contributions from Rooms Containing Waste Form																
Room of Origin (includes comments field as needed)	Ignition Source (If Applicable)	Number in Room	Frequency per Unit (50 years)	Number at Target	Number Near Target	Propagation Probability to Target	Number Away from Target	Propagation Probability to Target	Target Exposure Time (Fraction)	Contribution to IE Frequency (50 years)	Target Exposure Time (Fraction)	Contribution to IE Frequency (50 years)	Target Exposure Time (Fraction)	Contribution to IE Frequency (50 years)	Target Exposure Time (Fraction)	Contribution to IE Frequency (50 years)
Entry represents a vulnerability due to the WP Transfer Trolley																
1018, 2004 & 2007	Electrical	0	1.16E-03			0.211			9.6E-05	0.0E+00	1.3E-05	0.0E+00	9.8E-05	0.0E+00		
	HVAC	2	4.64E-03			0.211	2	0.061	9.6E-05	5.5E-08	1.3E-05	7.2E-09	9.8E-05	5.6E-08		
	Mechanical Equipment	21.4	7.57E-03	2.4		0.211	19	0.061	9.6E-05	2.6E-06	1.3E-05	3.4E-07	9.8E-05	2.6E-06		
	Heat Generating Equipment	0	0.00E+00			0.211		0.061	9.6E-05	0.0E+00	1.3E-05	0.0E+00	9.8E-05	0.0E+00		
	Torches, welders, burners	956	5.87E-04	946		0.211	10	0.061	9.6E-05	5.3E-05	1.3E-05	7.0E-06	9.8E-05	5.4E-05		
	Internal combustion engines	0	3.89E-04			0.211		0.061	9.6E-05	0.0E+00	1.3E-05	0.0E+00	9.8E-05	0.0E+00		
	Office/kitchen equipment	0	2.37E-02			0.211		0.061	9.6E-05	0.0E+00	1.3E-05	0.0E+00	9.8E-05	0.0E+00		
	Portable Equipment	4	6.29E-03	1		0.211	3	0.061	9.6E-05	7.2E-07	1.3E-05	9.4E-08	9.8E-05	7.3E-07		
	No equipment involved	4307	2.53E-05	213	120	0.211	3974	0.061	9.6E-05	1.2E-06	1.3E-05	1.5E-07	9.8E-05	1.2E-06		
Propagation from rooms in Fire Zone																
1016			8.46E-04			0.057			9.6E-05	4.7E-09	1.3E-05	6.1E-10	9.8E-05	4.8E-09		
1017			9.40E-04			0.057			9.6E-05	5.2E-09	1.3E-05	6.8E-10	9.8E-05	5.3E-09		
1019			2.98E-02			0.057			9.6E-05	1.6E-07	1.3E-05	2.2E-08	9.8E-05	1.7E-07		
1020			8.46E-04			0.057			9.6E-05	4.7E-09	1.3E-05	6.1E-10	9.8E-05	4.8E-09		
1021			7.75E-04			0.057			9.6E-05	4.3E-09	1.3E-05	5.6E-10	9.8E-05	4.4E-09		
2003			3.20E-02			0.057			9.6E-05	1.8E-07	1.3E-05	2.3E-08	9.8E-05	1.8E-07		
2003A			4.89E-04			0.057			9.6E-05	2.7E-09	1.3E-05	3.5E-10	9.8E-05	2.8E-09		
2007A			1.74E-02			0.057			9.6E-05	9.6E-08	1.3E-05	1.3E-08	9.8E-05	9.8E-08		
2007B			6.97E-03			0.057			9.6E-05	3.9E-08	1.3E-05	5.0E-09	9.8E-05	3.9E-08		
2011			3.23E-02			0.057			9.6E-05	1.8E-07	1.3E-05	2.3E-08	9.8E-05	1.8E-07		
2011A			4.79E-04			0.057			9.6E-05	2.6E-09	1.3E-05	3.5E-10	9.8E-05	2.7E-09		
Localized Fire Threatens Waste Form in WP in Positioning/Closure Room																
Localized Fire Threatens TAD in WP in Positioning/Closure Room										5.9E-05						
Localized Fire Threatens HLW in WP in Positioning/Closure Room										7.7E-06						
Localized Fire Threatens HLW and DOE-SNF in WP in Positioning/Closure Room										6.0E-05						
Entry represents a vulnerability due to the Transportation Emplacement Vehicle																
1015 & 1014	Electrical	1	1.16E-03	1		0.211			1.2E-06	1.4E-09	1.2E-06	1.4E-09				
	HVAC	4	4.64E-03	2	2	0.211		0.061	1.2E-06	1.3E-08	1.2E-06	1.3E-08				
	Mechanical Equipment	11.2	7.57E-03	11.2		0.211		0.061	1.2E-06	1.0E-07	1.2E-06	1.0E-07				
	Heat Generating Equipment	0	0.00E+00			0.211		0.061	1.2E-06	0.0E+00	1.2E-06	0.0E+00				
	Torches, welders, burners	0	5.87E-04			0.211		0.061	1.2E-06	0.0E+00	1.2E-06	0.0E+00				
	Internal combustion engines	0	3.89E-04			0.211		0.061	1.2E-06	0.0E+00	1.2E-06	0.0E+00				
	Office/kitchen equipment	0	2.37E-02			0.211		0.061	1.2E-06	0.0E+00	1.2E-06	0.0E+00				
	Portable Equipment	3	6.29E-03	3		0.211		0.061	1.2E-06	2.2E-08	1.2E-06	2.2E-08				
	No equipment involved	1711	2.53E-05	880	300	0.211	531	0.061	1.2E-06	2.9E-08	1.2E-06	2.9E-08				
Localized Fire Threatens Waste Form in TEV in Loadout Room																
Localized Fire Threatens TAD/WP in TEV in Loadout Room										1.7E-07						
Localized Fire Threatens HLW and DOE-SNF in WP in TEV in Loadout Room										1.7E-07						

Table F5.7-4. Localized Fire Initiating Event
Frequencies (Continued)

Room of Origin (includes comments field as needed)	Ignition Source (If Applicable)	Number in Room	Frequency per Unit (50 years)	Number at Target	Number Near Target	Propagation Probability to Target	Number Away from Target	Propagation Probability to Target	Target Exposure Time (Fraction)	Contribution to IE Frequency (50 years)	Target Exposure Time (Fraction)	Contribution to IE Frequency (50 years)	Target Exposure Time (Fraction)	Contribution to IE Frequency (50 years)	Target Exposure Time (Fraction)	Contribution to IE Frequency (50 years)
Entry represents a vulnerability due to the WP Transfer Trolley										TAD	HLW & DOE-SNF					
1015	Electrical	1	1.16E-03	1		0.211		0.061	7.1E-06	8.2E-09	7.1E-06	8.2E-09				
	HVAC	2	4.64E-03		2	0.211		0.061	7.1E-06	1.4E-08	7.1E-06	1.4E-08				
	Mechanical Equipment	9.2	7.57E-03	9.2		0.211		0.061	7.1E-06	4.9E-07	7.1E-06	4.9E-07				
	Heat Generating Equipment	0	0.00E+00			0.211		0.061	7.1E-06	0.0E+00	7.1E-06	0.0E+00				
	Torches, welders, burners	0	5.87E-04			0.211		0.061	7.1E-06	0.0E+00	7.1E-06	0.0E+00				
	Internal combustion engines	0	3.89E-04			0.211		0.061	7.1E-06	0.0E+00	7.1E-06	0.0E+00				
	Office/kitchen equipment	0	2.37E-02			0.211		0.061	7.1E-06	0.0E+00	7.1E-06	0.0E+00				
	Portable Equipment	2	6.29E-03	1	1	0.211	0	0.061	7.1E-06	5.4E-08	7.1E-06	5.4E-08				
	No equipment involved	1326	2.53E-05	430	250	0.211	646	0.061	7.1E-06	9.3E-08	7.1E-06	9.3E-08				
Localized Fire Threatens Waste Form in WP in Loadout Room																
Localized Fire Threatens TAD in WP in Loadout Room										6.6E-07						
Localized Fire Threatens HLW and DOE-SNF in WP in Loadout Room											6.6E-07					
Entry represents a vulnerability due to the Cask Transfer Trolley										TAD	HLW		DOE-SNF		TC/DPC (VTC)	
1023	Electrical	0	1.16E-03			0.211		0.061	3.3E-06	0.0E+00	1.3E-05	0.0E+00	2.1E-05	0.0E+00	1.8E-06	0.0E+00
	HVAC	0	4.64E-03			0.211		0.061	3.3E-06	0.0E+00	1.3E-05	0.0E+00	2.1E-05	0.0E+00	1.8E-06	0.0E+00
	Mechanical Equipment	1.05	7.57E-03	1.05		0.211		0.061	3.3E-06	2.7E-08	1.3E-05	1.1E-07	2.1E-05	1.7E-07	1.8E-06	1.4E-08
	Heat Generating Equipment	0	0.00E+00			0.211		0.061	3.3E-06	0.0E+00	1.3E-05	0.0E+00	2.1E-05	0.0E+00	1.8E-06	0.0E+00
	Torches, welders, burners	0	5.87E-04			0.211		0.061	3.3E-06	0.0E+00	1.3E-05	0.0E+00	2.1E-05	0.0E+00	1.8E-06	0.0E+00
	Internal combustion engines	0	3.89E-04			0.211		0.061	3.3E-06	0.0E+00	1.3E-05	0.0E+00	2.1E-05	0.0E+00	1.8E-06	0.0E+00
	Office/kitchen equipment	0	2.37E-02			0.211		0.061	3.3E-06	0.0E+00	1.3E-05	0.0E+00	2.1E-05	0.0E+00	1.8E-06	0.0E+00
	Portable Equipment	1	6.29E-03	1		0.211		0.061	3.3E-06	2.1E-08	1.3E-05	8.4E-08	2.1E-05	1.3E-07	1.8E-06	1.1E-08
	No equipment involved	78	2.53E-05	30	48	0.211	0	0.061	3.3E-06	3.4E-09	1.3E-05	1.4E-08	2.1E-05	2.1E-08	1.8E-06	1.8E-09
Propagation from rooms in Fire Zone																
1022			7.05E-04			0.057			3.3E-06	1.4E-10	1.3E-05	5.4E-10	2.1E-05	8.5E-10	1.8E-06	7.2E-11
1024			1.62E-02			0.057			3.3E-06	3.1E-09	1.3E-05	1.2E-08	2.1E-05	2.0E-08	1.8E-06	1.7E-09
1025			7.05E-04			0.057			3.3E-06	1.4E-10	1.3E-05	5.4E-10	2.1E-05	8.5E-10	1.8E-06	7.2E-11
1026			2.82E-01			0.057			3.3E-06	5.4E-08	1.3E-05	2.2E-07	2.1E-05	3.4E-07	1.8E-06	2.9E-08
Localized Fire Threatens Waste Form on CTT in Unloading Room																
Localized Fire Threatens TC/TAD on CTT in Unloading Room										1.1E-07						
Localized Fire Threatens TC/HLW on CTT in Unloading Room											4.3E-07					
Localized Fire Threatens TC/DOE-SNF on CTT in Unloading Room												6.8E-07				
Localized Fire Threatens TC/DPC (VTC) in Cask Unloading Room																5.8E-08

Table F5.7-4. Localized Fire Initiating Event Frequencies (Continued)

Room of Origin (includes comments field as needed)	Ignition Source (If Applicable)	Number in Room	Frequency per Unit (50 years)	Number at Target	Number Near Target	Propagation Probability to Target	Number Away from Target	Propagation Probability to Target	Target Exposure Time (Fraction)	Contribution to IE Frequency (50 years)	Target Exposure Time (Fraction)	Contribution to IE Frequency (50 years)	Target Exposure Time (Fraction)	Contribution to IE Frequency (50 years)	Target Exposure Time (Fraction)	Contribution to IE Frequency (50 years)
Entry represents a vulnerability due to the Site Transporter										TAD	DPC (VTC)					
1023	Electrical	0	1.16E-03			0.211		0.061	3.5E-06	0.0E+00	3.3E-06	0.0E+00				
	HVAC	0	4.64E-03			0.211		0.061	3.5E-06	0.0E+00	3.3E-06	0.0E+00				
	Mechanical Equipment	1.05	7.57E-03	1.05		0.211		0.061	3.5E-06	2.8E-08	3.3E-06	2.6E-08				
	Heat Generating Equipment	0	0.00E+00			0.211		0.061	3.5E-06	0.0E+00	3.3E-06	0.0E+00				
	Torches, welders, burners	0	5.87E-04			0.211		0.061	3.5E-06	0.0E+00	3.3E-06	0.0E+00				
	Internal combustion engines	0	3.89E-04			0.211		0.061	3.5E-06	0.0E+00	3.3E-06	0.0E+00				
	Office/kitchen equipment	0	2.37E-02			0.211		0.061	3.5E-06	0.0E+00	3.3E-06	0.0E+00				
	Portable Equipment	1	6.29E-03	1		0.211		0.061	3.5E-06	2.2E-08	3.3E-06	2.1E-08				
	No equipment involved	78	2.53E-05	30	48	0.211	0	0.061	3.5E-06	3.6E-09	3.3E-06	3.4E-09				
Propagation from rooms in Fire Zone																
1022			7.05E-04			0.057			3.5E-06	1.4E-10	3.3E-06	1.3E-10				
1024			1.62E-02			0.057			3.5E-06	3.3E-09	3.3E-06	3.1E-09				
1025			7.05E-04			0.057			3.5E-06	1.4E-10	3.3E-06	1.3E-10				
1026			2.82E-01			0.057			3.5E-06	5.7E-08	3.3E-06	5.4E-08				
Localized Fire Threatens Waste Form in AO in Unloading Room (Diesel Present)																
	Localized Fire Threatens TAD in AO in Unloading Room (Diesel Present)									1.1E-07						
	Localized Fire Threatens DPC (VTC) in AO in Unloading Room (Diesel Present)											1.1E-07				
Entry represents a vulnerability due to the Site Prime Mover (Diesel Present)										TAD	HLW		DOE-SNF		TC/DPC (VTC)	
1026	Electrical	1	1.16E-03	1		0.211		0.061	2.1E-06	2.4E-09	2.1E-06	2.5E-09	2.1E-06	2.5E-09	2.1E-06	2.5E-09
1036	HVAC	4	4.64E-03	4		0.211		0.061	2.1E-06	3.8E-08	2.1E-06	4.0E-08	2.1E-06	4.0E-08	2.1E-06	4.0E-08
1036A	Mechanical Equipment	19.9	7.57E-03	4	15.9	0.211		0.061	2.1E-06	1.1E-07	2.1E-06	1.2E-07	2.1E-06	1.2E-07	2.1E-06	1.2E-07
	Heat Generating Equipment	0	0.00E+00			0.211		0.061	2.1E-06	0.0E+00	2.1E-06	0.0E+00	2.1E-06	0.0E+00	2.1E-06	0.0E+00
	Torches, welders, burners	0	5.87E-04			0.211		0.061	2.1E-06	0.0E+00	2.1E-06	0.0E+00	2.1E-06	0.0E+00	2.1E-06	0.0E+00
	Internal combustion engines	190	3.89E-04	190		0.211		0.061	2.1E-06	1.5E-07	2.1E-06	1.6E-07	2.1E-06	1.6E-07	2.1E-06	1.6E-07
	Office/kitchen equipment	0	2.37E-02			0.211		0.061	2.1E-06	0.0E+00	2.1E-06	0.0E+00	2.1E-06	0.0E+00	2.1E-06	0.0E+00
	Portable Equipment	4	6.29E-03	2		0.211	2	0.061	2.1E-06	2.7E-08	2.1E-06	2.8E-08	2.1E-06	2.8E-08	2.1E-06	2.8E-08
	No equipment involved	2591	2.53E-05	1526	120	0.211	945	0.061	2.1E-06	8.4E-08	2.1E-06	8.7E-08	2.1E-06	8.7E-08	2.1E-06	8.7E-08
Propagation from rooms in Fire Zone																
1022			7.05E-04			0.057			2.1E-06	8.3E-11	2.1E-06	8.6E-11	2.1E-06	8.6E-11	2.1E-06	8.6E-11
1023			1.62E-02			0.057			2.1E-06	1.9E-09	2.1E-06	2.0E-09	2.1E-06	2.0E-09	2.1E-06	2.0E-09
1024			1.62E-02			0.057			2.1E-06	1.9E-09	2.1E-06	2.0E-09	2.1E-06	2.0E-09	2.1E-06	2.0E-09
1025			7.05E-04			0.057			2.1E-06	8.3E-11	2.1E-06	8.6E-11	2.1E-06	8.6E-11	2.1E-06	8.6E-11
Localized Fire Threatens Waste Form in Vestibule/Preparation Area w/SPM (Diesel Present)																
	Localized Fire Threatens TC/TAD in Vestibule/Preparation Area w/SPM (Diesel Present)									4.2E-07						
	Localized Fire Threatens TC/HLW in Vestibule/Preparation Area w/SPM (Diesel Present)											4.4E-07				
	Localized Fire Threatens TC/DOE-SNF in Vestibule/Preparation Area w/SPM (Diesel Present)												4.4E-07			
	Localized Fire Threatens TC/DPC (VTC) in Vestibule/Preparation Area (Diesel Present)															4.4E-07

Table F5.7-4. Localized Fire Initiating Event Frequencies (Continued)

Room of Origin (includes comments field as needed)	Ignition Source (If Applicable)	Number in Room	Frequency per Unit (50 years)	Number at Target	Number Near Target	Propagation Probability to Target	Number Away from Target	Propagation Probability to Target	Target Exposure Time (Fraction)	Contribution to IE Frequency (50 years)	Target Exposure Time (Fraction)	Contribution to IE Frequency (50 years)	Target Exposure Time (Fraction)	Contribution to IE Frequency (50 years)	Target Exposure Time (Fraction)	Contribution to IE Frequency (50 years)
Entry represents a vulnerability due to the Railcar (No Diesel Present)										TAD	HLW	DOE-SNF	TC/DPC (VTC)			
1026	Electrical	1	1.16E-03	1		0.211		0.061	1.5E-05	1.7E-08	1.8E-05	2.1E-08	1.5E-05	1.7E-08	1.3E-05	1.5E-08
1036	HVAC	4	4.64E-03	4		0.211		0.061	1.5E-05	2.8E-07	1.8E-05	3.3E-07	1.5E-05	2.8E-07	1.3E-05	2.4E-07
1036A	Mechanical Equipment	19.9	7.57E-03	4	15.9	0.211		0.061	1.5E-05	8.4E-07	1.8E-05	9.9E-07	1.5E-05	8.4E-07	1.3E-05	7.3E-07
	Heat Generating Equipment	0	0.00E+00			0.211		0.061	1.5E-05	0.0E+00	1.8E-05	0.0E+00	1.5E-05	0.0E+00	1.3E-05	0.0E+00
	Torches, welders, burners	0	5.87E-04			0.211		0.061	1.5E-05	0.0E+00	1.8E-05	0.0E+00	1.5E-05	0.0E+00	1.3E-05	0.0E+00
	Internal combustion engines	0	3.89E-04			0.211		0.061	1.5E-05	0.0E+00	1.8E-05	0.0E+00	1.5E-05	0.0E+00	1.3E-05	0.0E+00
	Office/kitchen equipment	0	2.37E-02			0.211		0.061	1.5E-05	0.0E+00	1.8E-05	0.0E+00	1.5E-05	0.0E+00	1.3E-05	0.0E+00
	Portable Equipment	4	6.29E-03	2		0.211	2	0.061	1.5E-05	2.0E-07	1.8E-05	2.4E-07	1.5E-05	2.0E-07	1.3E-05	1.8E-07
	No equipment involved	2591	2.53E-05	1526	120	0.211	945	0.061	1.5E-05	6.1E-07	1.8E-05	7.3E-07	1.5E-05	6.1E-07	1.3E-05	5.4E-07
Propagation from rooms in Fire Zone																
1022			7.05E-04			0.057			1.5E-05	6.1E-10	1.8E-05	7.2E-10	1.5E-05	6.1E-10	1.3E-05	5.3E-10
1023			1.62E-02			0.057			1.5E-05	1.4E-08	1.8E-05	1.7E-08	1.5E-05	1.4E-08	1.3E-05	1.2E-08
1024			1.62E-02			0.057			1.5E-05	1.4E-08	1.8E-05	1.7E-08	1.5E-05	1.4E-08	1.3E-05	1.2E-08
1025			7.05E-04			0.057			1.5E-05	6.1E-10	1.8E-05	7.2E-10	1.5E-05	6.1E-10	1.3E-05	5.3E-10
Localized Fire Threatens Waste Form in Preparation Area w/o SPM (No Diesel Present)																
	Localized Fire Threatens TC/TAD in Preparation Area w/o SPM (No Diesel Present)									2.0E-06						
	Localized Fire Threatens TC/HLW in Preparation Area w/o SPM (No Diesel Present)										2.3E-06					
	Localized Fire Threatens TC/DOE-SNF in Preparation Area w/o SPM (No Diesel Present)												2.0E-06			
	Localized Fire Threatens TC/DPC (VTC) in Preparation Area (No Diesel Present)															1.7E-06
Entry represents a vulnerability due to the Site Transporter																
										TAD	DPC (VTC)					
1026 & 1027	Electrical	1	1.16E-03	1		0.211		0.061	8.4E-06	9.7E-09	1.2E-05	1.4E-08				
	HVAC	2	4.64E-03	2		0.211		0.061	8.4E-06	7.8E-08	1.2E-05	1.1E-07				
	Mechanical Equipment	21.9	7.57E-03	21.9		0.211		0.061	8.4E-06	1.4E-06	1.2E-05	2.0E-06				
	Heat Generating Equipment	0	0.00E+00			0.211		0.061	8.4E-06	0.0E+00	1.2E-05	0.0E+00				
	Torches, welders, burners	5	5.87E-04			0.211	5	0.061	8.4E-06	1.5E-09	1.2E-05	2.2E-09				
	Internal combustion engines	140	3.89E-04	140		0.211		0.061	8.4E-06	4.6E-07	1.2E-05	6.6E-07				
	Office/kitchen equipment	0	2.37E-02			0.211		0.061	8.4E-06	0.0E+00	1.2E-05	0.0E+00				
	Portable Equipment	4	6.29E-03	4		0.211		0.061	8.4E-06	2.1E-07	1.2E-05	3.0E-07				
	No equipment involved	2485	2.53E-05	2143		0.211	342	0.061	8.4E-06	4.6E-07	1.2E-05	6.6E-07				
Propagation from rooms in Fire Zone																
1022			7.05E-04			0.057			8.4E-06	3.4E-10	1.2E-05	4.9E-10				
1023			1.62E-02			0.057			8.4E-06	7.8E-09	1.2E-05	1.1E-08				
1024			1.62E-02			0.057			8.4E-06	7.8E-09	1.2E-05	1.1E-08				
1025			7.05E-04			0.057			8.4E-06	3.4E-10	1.2E-05	4.9E-10				
Localized Fire Threatens Waste Form in AO in Vestibule/Preparation Area (Diesel Present)																
	Localized Fire Threatens TAD in AO in Vestibule/Preparation Area (Diesel Present)									2.6E-06						
	Localized Fire Threatens DPC (VTC) in AO in Vestibule/Preparation Area (Diesel Present)										3.8E-06					

Table F5.7-4. Localized Fire Initiating Event Frequencies (Continued)

Room of Origin (includes comments field as needed)	Ignition Source (If Applicable)	Number in Room	Frequency per Unit (50 years)	Number at Target	Number Near Target	Propagation Probability to Target	Number Away from Target	Propagation Probability to Target	Target Exposure Time (Fraction)	Contribution to IE Frequency (50 years)	Target Exposure Time (Fraction)	Contribution to IE Frequency (50 years)	Target Exposure Time (Fraction)	Contribution to IE Frequency (50 years)	Target Exposure Time (Fraction)	Contribution to IE Frequency (50 years)
Entry represents a vulnerability due to the Cask Transfer Trolley																
1026	Electrical	1	1.16E-03	1		0.211		0.061	1.6E-05	1.8E-08	1.4E-05	1.6E-08	1.5E-05	1.7E-08	1.5E-05	1.7E-08
	HVAC	0	4.63E-03			0.211		0.061	1.6E-05	0.0E+00	1.4E-05	0.0E+00	1.5E-05	0.0E+00	1.5E-05	0.0E+00
	Mechanical Equipment	19.9	7.55E-03	4	15.9	0.211		0.061	1.6E-05	8.7E-07	1.4E-05	7.7E-07	1.5E-05	8.2E-07	1.5E-05	8.2E-07
	Heat Generating Equipment	0	0.00E+00			0.211		0.061	1.6E-05	0.0E+00	1.4E-05	0.0E+00	1.5E-05	0.0E+00	1.5E-05	0.0E+00
	Torches, welders, burners	0	5.86E-04			0.211		0.061	1.6E-05	0.0E+00	1.4E-05	0.0E+00	1.5E-05	0.0E+00	1.5E-05	0.0E+00
	Internal combustion engines	130	3.88E-04	130		0.211		0.061	1.6E-05	7.9E-07	1.4E-05	7.0E-07	1.5E-05	7.4E-07	1.5E-05	7.4E-07
	Office/kitchen equipment	0	2.36E-02			0.211		0.061	1.6E-05	0.0E+00	1.4E-05	0.0E+00	1.5E-05	0.0E+00	1.5E-05	0.0E+00
	Portable Equipment	4	6.28E-03	2		0.211	2	0.061	1.6E-05	2.1E-07	1.4E-05	1.9E-07	1.5E-05	2.0E-07	1.5E-05	2.0E-07
	No equipment involved	2143	2.53E-05	1070	120	0.211	953	0.061	1.6E-05	4.6E-07	1.4E-05	4.1E-07	1.5E-05	4.3E-07	1.5E-05	4.3E-07
Propagation from rooms in Fire Zone																
1022			7.05E-04			0.057			1.6E-05	6.3E-10	1.4E-05	5.6E-10	1.5E-05	5.9E-10	1.5E-05	6.0E-10
1023			1.62E-02			0.057			1.6E-05	1.5E-08	1.4E-05	1.3E-08	1.5E-05	1.4E-08	1.5E-05	1.4E-08
1024			1.62E-02			0.057			1.6E-05	1.5E-08	1.4E-05	1.3E-08	1.5E-05	1.4E-08	1.5E-05	1.4E-08
1025			7.05E-04			0.057			1.6E-05	6.3E-10	1.4E-05	5.6E-10	1.5E-05	5.9E-10	1.5E-05	6.0E-10
Localized Fire Threatens Waste Form on CTT in Preparation Area																
	Localized Fire Threatens TC/TAD on CTT in Preparation Area									2.4E-06						
	Localized Fire Threatens TC/HLW on CTT in Preparation Area										2.1E-06					
	Localized Fire Threatens TC/DOE-SNF on CTT in Preparation Area												2.2E-06			
	Localized Fire Threatens TC/DPC (VTC) in Preparation Area															2.2E-06
Entry represents a vulnerability due to the Canister Transfer Machine																
2004	Electrical	0	1.16E-03			0.211		0.061	1.1E-06	0.0E+00	1.3E-06	0.0E+00	1.1E-06	0.0E+00	1.2E-06	0.0E+00
	HVAC	2	4.63E-03			0.211	2	0.061	1.1E-06	6.3E-10	1.3E-06	7.3E-10	1.1E-06	6.3E-10	1.2E-06	6.9E-10
	Mechanical Equipment	14	7.55E-03	10	0	0.211	4	0.061	1.1E-06	8.5E-08	1.3E-06	1.0E-07	1.1E-06	8.5E-08	1.2E-06	9.4E-08
	Heat Generating Equipment	0	0.00E+00			0.211		0.061	1.1E-06	0.0E+00	1.3E-06	0.0E+00	1.1E-06	0.0E+00	1.2E-06	0.0E+00
	Torches, welders, burners	10	5.86E-04			0.211	10	0.061	1.1E-06	4.0E-10	1.3E-06	4.6E-10	1.1E-06	4.0E-10	1.2E-06	4.4E-10
	Internal combustion engines	0	3.88E-04			0.211		0.061	1.1E-06	0.0E+00	1.3E-06	0.0E+00	1.1E-06	0.0E+00	1.2E-06	0.0E+00
	Office/kitchen equipment	0	2.36E-02			0.211		0.061	1.1E-06	0.0E+00	1.3E-06	0.0E+00	1.1E-06	0.0E+00	1.2E-06	0.0E+00
	Portable Equipment	1	6.28E-03	1		0.211		0.061	1.1E-06	6.9E-09	1.3E-06	8.1E-09	1.1E-06	6.9E-09	1.2E-06	7.6E-09
	No equipment involved	3846	2.53E-05	60	240	0.211	3546	0.061	1.1E-06	9.1E-09	1.3E-06	1.1E-08	1.1E-06	9.1E-09	1.2E-06	1.0E-08
Localized Fire Threatens Waste Form in CTM in Transfer Room																
	Localized Fire Threatens TAD in CTM in Transfer Room									1.0E-07						
	Localized Fire Threatens HLW in CTM in Transfer Room (per individual canister)										1.2E-07					
	Localized Fire Threatens DOE-SNF in CTM in Transfer Room (per individual canister)												1.0E-07			
	Localized Fire Threatens DPC (VTC) in CTM in Transfer Room															1.1E-07

NOTE: AO = aging overpack; CTM = canister transfer machine; CTT = cask transfer trolley; DOE = U.S. Department of Energy; HLW = high-level radioactive waste; HVAC = heating, ventilation, and air conditioning; IE = initiating event; SNF = spent nuclear fuel; TAD = transportation, aging, and disposal; TC = transportation cask; TEV = transport and emplacement vehicle; VTC = a transportation cask that is upended on a railcar; WP = waste package.

Source: Original

Table F5.7-5. Localized Fire Initiating Events with Multiple Rooms of Origin

Rooms	Vulnerability	Justification
1018	WP Transfer Trolley	Room 1018 is open to 2004 (port slide gate) and 2007 (robot arms/welding)
2004		
2007		
1015	Transportation Emplacement Vehicle	Rooms open to each other due to open doors as the TEV moves from 1014 into 1015
1014		
1026	Site Prime Mover (Diesel Present)	Rooms open to each other due to open doors as the Site Prime Mover moves from 1036A to 1036 to 1026
1036		
1036A		
1026	Railcar (No Diesel Present)	Rooms open to each other due to open doors as the Railcar moves from 1036A to 1036 to 1026
1036		
1036A		
1026	Site Transporter	Rooms open to each other due to open doors as the Site Transporter moves from 1027 to 1026
1027		

NOTE: TEV = transport and emplacement vehicle; WP = waste package.

Source: Original

Table F5.7-6. Large Fire Initiating Event Frequencies

Large Fire Threatens Waste Form In Fire Zones Containing Vulnerable Waste Forms								
Large fires are those that spread beyond the boundaries of a fire area, up through those that breach the building boundary.								
			Total Ignition Frequency		Propagation Probability Beyond Fire-rated Area		Target Exposure Time (Fraction)	Contribution to IE Frequency
Large Fire Threatens TC/TAD (Diesel Present)			3.13E+00		0.169		2.1E-06	1.1E-06
Large Fire Threatens TC/TAD (No Diesel)			3.13E+00		0.169		3.3E-05	1.7E-05
Large Fire Threatens TAD in AO (Diesel Present)			3.13E+00		0.169		1.1E-05	5.9E-06
Large Fire Threatens TAD in CTM			3.13E+00		0.169		1.5E-06	7.8E-07
Large Fire Threatens TAD in WP in WPTT			3.13E+00		0.169		1.0E-04	5.4E-05
Large Fire Threatens TAD in WP in TEV			3.13E+00		0.169		1.8E-06	9.2E-07
Large Fire Threatens TC/HLW (Diesel Present)			3.13E+00		0.169		2.1E-06	1.1E-06
Large Fire Threatens TC/HLW (No Diesel)			3.13E+00		0.169		3.4E-05	1.8E-05
Large Fire Threatens HLW in CTM (per indiv canister)			3.13E+00		0.169		1.5E-06	7.8E-07
Large Fire Threatens HLW in WP			3.13E+00		0.169		1.3E-05	6.6E-06
Large Fire Threatens HLW and DOE-SNF in WP			3.13E+00		0.169		1.1E-04	5.6E-05
Large Fire Threatens TC/DOE-SNF (Diesel Present)			3.13E+00		0.169		2.1E-06	1.1E-06
Large Fire Threatens TC/DOE-SNF (No Diesel)			3.13E+00		0.169		3.2E-05	1.7E-05
Large Fire Threatens DOE-SNF in CTM (per canister)			3.13E+00		0.169		1.1E-06	5.8E-07
Large Fire Threatens DOE-SNF in Staging Area			3.13E+00		0.169		1.0E+00	5.3E-01
Large Fire Threatens TC/DPC (VTC) (Diesel)			3.13E+00		0.169		2.1E-06	1.1E-06
Large Fire Threatens TC/DPC (VTC) (No Diesel)			3.13E+00		0.169		3.0E-05	1.6E-05
Large Fire Threatens DPC (VTC) in CTM			3.13E+00		0.169		1.2E-06	6.4E-07
Large Fire Threatens DPC (VTC) in AO (Diesel)			3.13E+00		0.169		1.5E-05	7.7E-06

NOTE: AO = aging overpack; CTM = canister transfer machine; DOE = U.S. Department of Energy; HLW = high-level radioactive waste; SNF = spent nuclear fuel; TAD = transportation, aging, and disposal; TC = transportation cask; TEV = transport and emplacement vehicle; VTC = a transportation cask that is upended on a railcar; WP = waste package; WPTT = waste package transfer trolley.

Source: Original

F5.8 MONTE CARLO SIMULATION/UNCERTAINTY DISTRIBUTIONS

F5.8.1 Uncertainty Distributions

Uncertainty distributions are utilized in the contribution to initiating event frequency calculations to account for the potential of variance in the data. For example, the ignition frequency presented in Table F5.2-1, Section F5.1 is the result of a calculation based on room area. The equation utilized to perform this calculation was derived from data collected on building fires. While the data collected and the equation developed to fit the data have a good R-squared (percentage of variability accounted for in the equation) value (90), an uncertainty distribution is necessary to account for the natural variability of the frequency of ignition.

The uncertainty distributions used for this analysis are primarily normal, with the exception of the ignition frequency distribution, which is lognormal (skewed bell curve shape, with the median value at the top of the curve). Lognormal distributions can be accurately represented by a median (50%) and a 97.5% value. The 97.5% value is a figure that represents a point at which only 2.5% of all possible outcomes will vary from the mean more significantly.

Three uncertainty distributions were developed for this analysis: ignition frequency, category fraction, and conditional probability. The distribution for ignition frequency is discussed in detail in Appendix F.III. The distributions for category fraction and conditional probability are discussed in Appendix F.II.

F5.8.2 Monte Carlo Simulation

Monte Carlo simulations are performed to determine the mean, standard deviation, variance, minimum, and maximum values of each of the initiating event frequencies based on the variance of the contributing data. To accomplish this, the Microsoft Excel add-on package Crystal Ball was used. This software requires input of the necessary uncertainty distribution figures (in this case, median (50%) and 97.5% values), and the figures that the simulation will produce results for (IE frequencies). Crystal Ball software uses the mean and 97.5% value to calculate the equation which represents the distribution. The software then randomly selects a value from the possibilities defined by the distribution. This is set within the software to be done 10,000 times to ensure accurate results.

F5.9 RESULTS

The results of the analysis are the fire initiating event frequencies and their associated distributions. The initiating event frequencies represent the probability, over the length of the pre-closure period, that a fire will threaten the stated waste form during the stated vulnerability. Because data used to obtain these results are based on existing fire data, it was necessary to determine the uncertainty distribution for each initiating event. Figure F5.7-1 displays the Crystal Ball results for a localized fire threatening a TAD canister in the canister transfer machine in the Canister Transfer Room.

These results provide a statistical reference for the variance of each initiating event frequency. As seen in Section F5.7.2, Table F5.7-4, the baseline initiating event frequency for this case is 1.0E-07. The Crystal Ball results give insight into this, showing that given the variability of the

inputs, the true result could lie anywhere between $1.2\text{E-}08$ and $5.6\text{E-}07$, with a mean of $1.1\text{E-}7$, a standard deviation of $5.4\text{E-}8$, and a lognormal shape. Crystal Ball was run for all of the initiating events, and a summary of the results, giving the distribution parameters of each distribution, is shown in Table F5.7-7. The 97.5 percentile values in Table F5.7-7 are not provided in the Crystal Ball full report. Instead, these values were obtained by utilizing the Extract Data option, which allows the analyst to specify the percentile values necessary. Also not included in the Crystal Ball report is the error factors, these figures were calculated from the mean and median as discussed in Appendix F.V. It was determined via methods described in Appendix F.IV that all of the resultant distributions are lognormal. The complete output from Crystal Ball and the 97.5 percentile values are provided in Appendix F.VI. In addition to showing the initiating event frequency distribution, it also shows the input distribution for the parameters that were varied, which match the distributions developed and documented in Appendices F.II and F.III.

Table F5.7-7. Fire Initiating Events Results Summary

Initiating Event	Equipment	Mean	Median	97.5% Value	EF	Type
Localized Fire Threatens Waste Form in WP in Positioning/Closure Room	WP Transfer Trolley					
Localized Fire Threatens TAD in WP in Positioning/Closure Room		6.5E-05	5.8E-05	1.42E-4	2.2E+00	Lognormal
Localized Fire Threatens HLW in WP in Positioning/Closure Room		8.5E-06	7.6E-06	1.9E-05	2.2E+00	Lognormal
Localized Fire Threatens HLW and DOE SNF in WP in Positioning/Closure Room		6.6E-05	5.9E-05	1.4E-04	2.2E+00	Lognormal
Localized Fire Threatens Waste Form in TEV in Loadout Room	Transportation Emplacement Vehicle					
Localized Fire Threatens TAD/WP in TEV in Loadout Room		1.9E-07	1.7E-07	4.1E-07	2.1E+00	Lognormal
Localized Fire Threatens HLW and DOE SNF in WP in TEV in Loadout Room		1.9E-07	1.7E-07	4.1E-07	2.1E+00	Lognormal
Localized Fire Threatens Waste Form in WP in Loadout Room	WP Transfer Trolley					
Localized Fire Threatens TAD in WP in Loadout Room		7.3E-07	6.6E-07	1.6E-06	2.0E+00	Lognormal
Localized Fire Threatens HLW and DOE SNF in WP in Loadout Room		7.3E-07	6.6E-07	1.6E-06	2.0E+00	Lognormal
Localized Fire Threatens Waste Form on CTT in Unloading Room	Cask Transfer Trolley					
Localized Fire Threatens TC/TAD on CTT in Unloading Room		1.2E-07	1.1E-07	2.8E-07	2.3E+00	Lognormal
Localized Fire Threatens TC/HLW on CTT in Unloading Room		4.7E-07	4.2E-07	1.1E-06	2.2E+00	Lognormal
Localized Fire Threatens TC/DOE SNF on CTT in Unloading Room		7.5E-07	6.7E-07	1.7E-06	2.2E+00	Lognormal
Localized Fire Threatens TC/DPC (VTC) in Cask Unloading Room		6.4E-08	5.6E-08	1.5E-07	2.3E+00	Lognormal
Localized Fire Threatens Waste Form in AO in Unloading Room (Diesel Present)	Site Transporter					
Localized Fire Threatens TAD in AO in Unloading Room (Diesel Present)		1.3E-07	1.1E-07	2.9E-07	2.5E+00	Lognormal
Localized Fire Threatens DPC (VTC) in AO in Unloading Room (Diesel Present)		1.2E-07	1.0E-07	2.7E-07	2.4E+00	Lognormal
Localized Fire Threatens Waste Form in Vestibule/Preparation Area w/SPM (Diesel Present)	Site Prime Mover					
Localized Fire Threatens TC/TAD in Vestibule/Preparation Area w/SPM (Diesel Present)		4.7E-07	4.2E-07	1.1E-06	2.2E+00	Lognormal
Localized Fire Threatens TC/HLW in Vestibule/Preparation Area w/SPM (Diesel Present)		4.9E-07	4.3E-07	1.1E-06	2.2E+00	Lognormal
Localized Fire Threatens TC/DOE SNF in Vestibule/Preparation Area w/SPM (Diesel Present)		4.9E-07	4.3E-07	1.1E-06	2.2E+00	Lognormal
Localized Fire Threatens TC/DPC (VTC) in Vestibule/Preparation Area (Diesel Present)		4.9E-07	4.3E-07	1.1E-06	2.2E+00	Lognormal
Localized Fire Threatens Waste Form in Preparation Area w/o SPM (No Diesel Present)	Railcar					
Localized Fire Threatens TC/TAD in Preparation Area w/o SPM (No Diesel Present)		2.2E-06	2.0E-06	4.7E-06	2.2E+00	Lognormal
Localized Fire Threatens TC/HLW in Preparation Area w/o SPM (No Diesel Present)		2.6E-06	2.3E-06	5.6E-06	2.2E+00	Lognormal
Localized Fire Threatens TC/DOE SNF in Preparation Area w/o SPM (No Diesel Present)		2.2E-06	2.0E-06	4.7E-06	2.2E+00	Lognormal
Localized Fire Threatens TC/DPC (VTC) in Preparation Area (No Diesel Present)		1.9E-06	1.7E-06	4.1E-06	2.1E+00	Lognormal

Table F5.7-7. Fire Initiating Events Results Summary (Continued)

Initiating Event	Equipment	Mean	Median	97.5% Value	EF	Type
Localized Fire Threatens Waste Form in AO in Vestibule/Preparation Area (Diesel Present)	Site Transporter					
Localized Fire Threatens TAD in AO in Vestibule/Preparation Area (Diesel Present)		2.9E-06	2.6E-06	6.3E-06	2.2E+00	Lognormal
Localized Fire Threatens DPC (VTC) in AO in Vestibule/Preparation Area (Diesel Present)		4.2E-06	3.8E-06	9.2E-06	2.1E+00	Lognormal
Localized Fire Threatens Waste Form on CTT in Preparation Area	Cask Transfer Trolley					
Localized Fire Threatens TC/TAD on CTT in Preparation Area		2.6E-06	2.4E-06	6.0E-06	2.1E+00	Lognormal
Localized Fire Threatens TC/HLW on CTT in Preparation Area		2.3E-06	2.1E-06	5.3E-06	2.0E+00	Lognormal
Localized Fire Threatens TC/DOE SNF on CTT in Preparation Area		2.5E-06	2.2E-06	5.6E-06	2.3E+00	Lognormal
Localized Fire Threatens TC/DPC (VTC) in Preparation Area		2.5E-06	2.2E-06	5.6E-06	2.2E+00	Lognormal
Localized Fire Threatens Waste Form in CTM in Transfer Room	Canister Transfer Machine					
Localized Fire Threatens TAD in CTM in Transfer Room		1.1E-07	1.0E-07	2.5E-07	2.0E+00	Lognormal
Localized Fire Threatens HLW in CTM in Transfer Room (per individual canister)		1.3E-07	1.2E-07	2.9E-07	2.0E+00	Lognormal
Localized Fire Threatens DOE SNF in CTM in Transfer Room (per individual canister)		1.1E-07	1.0E-07	2.5E-07	2.0E+00	Lognormal
Localized Fire Threatens DPC in CTM in Transfer Room		1.2E-07	1.1E-07	2.7E-07	1.9E+00	Lognormal
Large Fire Threatens TC/TAD (Diesel Present)	-	1.2E-06	1.1E-06	2.8E-06	2.3E+00	Lognormal
Large Fire Threatens TC/TAD (No Diesel)	-	1.9E-05	1.7E-05	4.4E-05	2.2E+00	Lognormal
Large Fire Threatens TAD in AO (Diesel Present)	-	6.5E-06	5.8E-06	1.5E-05	2.2E+00	Lognormal
Large Fire Threatens TAD in CTM	-	8.6E-07	7.7E-07	2.0E-06	2.2E+00	Lognormal
Large Fire Threatens TAD in WP in WPTT	-	5.9E-05	5.3E-05	1.4E-04	2.1E+00	Lognormal
Large Fire Threatens TAD in WP in TEV	-	1.0E-06	9.1E-07	2.3E-06	2.0E+00	Lognormal
Large Fire Threatens TC/HLW (Diesel Present)	-	1.2E-06	1.1E-06	2.8E-06	2.3E+00	Lognormal
Large Fire Threatens TC/HLW (No Diesel)	-	2.0E-05	1.7E-05	4.6E-05	2.4E+00	Lognormal
Large Fire Threatens HLW in CTM (per indiv canister)	-	8.6E-07	7.7E-07	2.0E-06	2.2E+00	Lognormal
Large Fire Threatens HLW in WP	-	7.3E-06	6.6E-06	1.7E-05	2.1E+00	Lognormal
Large Fire Threatens HLW and DOE SNF in WP	-	6.1E-05	5.5E-05	1.4E-04	2.2E+00	Lognormal
Large Fire Threatens TC/DOE SNF (Diesel Present)	-	1.2E-06	1.1E-06	2.8E-06	2.3E+00	Lognormal
Large Fire Threatens TC/DOE SNF (No Diesel)	-	1.8E-05	1.7E-05	4.2E-05	2.0E+00	Lognormal
Large Fire Threatens DOE SNF in CTM (per canister)	-	6.4E-07	5.8E-07	1.5E-06	2.1E+00	Lognormal
Large Fire Threatens DOE SNF in Staging Area	-	5.8E-01	5.2E-01	1.4E+00	2.2E+00	Lognormal
Large Fire Threatens TC/DPC (VTC) (Diesel)	-	1.2E-06	1.1E-06	2.9E-06	2.0E+00	Lognormal
Large Fire Threatens TC/DPC (VTC) (No Diesel)	-	1.7E-05	1.5E-05	4.0E-05	2.1E+00	Lognormal
Large Fire Threatens DPC (VTC) in CTM	-	7.1E-07	6.3E-07	1.6E-06	2.2E+00	Lognormal
Large Fire Threatens DPC (VTC) in AO (Diesel)	-	8.5E-06	7.6E-06	2.0E-05	2.2E+00	Lognormal

NOTE: AO = aging overpack; CTM = canister transfer machine; CTT = cask transfer trolley; DOE = U.S. Department of Energy; HLW = high-level radioactive waste; SNF = spent nuclear fuel; TAD = transportation, aging, and disposal canister; TC = transportation cask; TEV = transport and emplacement vehicle; VTC = a transportation cask that is upended on a railcar; WP = waste package; WPTT = waste package transfer trolley.

Source: Original

Forecast: Localized Fire Threatens TAD in CTM in Transfer Room

Cell: K194

Summary:

Entire range is from 1.2E-08 to 5.6E-07

Base case is 1.0E-07

After 10,000 trials, the std. error of the mean is 5.4E-10

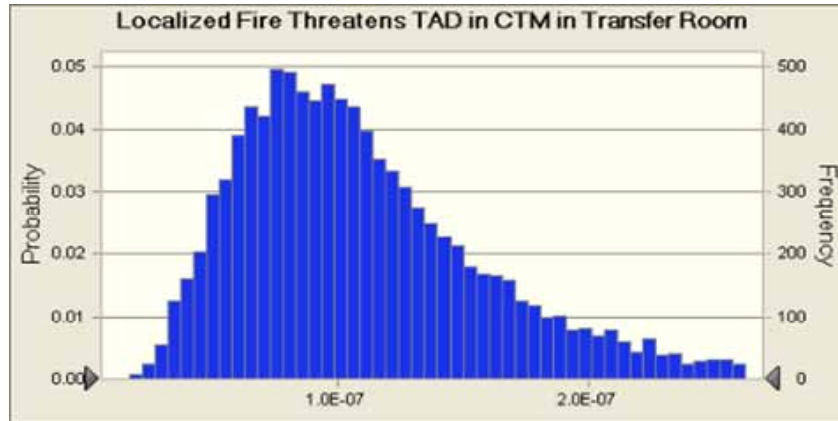

Statistics:	Forecast values
Trials	10,000
Mean	1.1E-07
Median	1.0E-07
Mode	---
Standard Deviation	5.4E-08
Variance	2.9E-15
Skewness	1.33
Kurtosis	5.85
Coeff. of Variability	0.4813
Minimum	1.2E-08
Maximum	5.6E-07
Range Width	5.5E-07
Mean Std. Error	5.4E-10

Forecast: Localized Fire Threatens TAD in CTM in Transfer Room (cont'd)

Cell: K194

Percentiles:	Forecast values
0%	1.2E-08
10%	5.5E-08
20%	6.8E-08
30%	7.9E-08
40%	9.0E-08
50%	1.0E-07
60%	1.1E-07
70%	1.3E-07
80%	1.5E-07
90%	1.8E-07
100%	5.6E-07

NOTE: CTM = canister transfer machine; TAD = transportation, aging, and disposal canister.

Source: Crystal Ball software output.

Figure F5.7-1. Example of Crystal Ball Output for a Fire Initiating Event

APPENDIX F.I DEFINITION OF IGNITION SOURCE CATEGORY

Table F.I-1. Definition of Ignition Source Category

Ignition Source Category	NFPA Equipment Categories Included
Electrical Equipment	Fixed wiring; transformer, associated over current or disconnect equipment; meter, meter box; power switchgear, over current protection devices; switch, receptacle, outlet; lighting fixture, lamp holder, ballast, sign; cord, plug; lamp, light bulb; unclassified or unknown-type electrical distribution equipment; electronic equipment; rectifier, charger
Mechanical and Electrical HVAC Equipment	Central heating unit; water heater; fixed, stationary local heating unit; central air conditioning, refrigeration equipment; water cooling device, tower; fixed, stationary local refrigeration unit; fixed, stationary local air conditioning unit; chimney, gas vent flue; chimney connector, vent connector; heat transfer system; unclassified heating systems; other HVAC equipment; unclassified air conditioning, refrigeration systems
Mechanical Equipment	Chemical process equipment; waste recovery equipment; working, shaping machine; coating machine; painting machine; unclassified process equipment; separate motor or generator; separate pump or compressor; conveyor, unknown mechanical equipment
Fixed Heat-Generating Process Equipment	Casting, molding, or forging equipment; heat-treating equipment; dryers; furnaces; incinerators
Torches/Welders	Torches, welders, burners
Internal Combustion Engines	Internal combustion engines
Office and Kitchen Equipment	Television, radio, stereo; fixed food-warming appliance; fixed or stationary oven; all other categories
Portable and Special Equipment	Portable local heating unit; hand tools; portable appliance designed to produce controlled heat; portable appliance designed not to produce heat; unclassified special equipment; unclassified service or maintenance equipment; biomedical equipment or device
No Equipment Involved	No equipment

NOTE: The entries shown in bold in the table were those that had caused fires in the data set. The other entries were included in the data set retrieval, but no fires were attributed to them. Given that there were only a total of 188 fires in the entire data set, the fact that certain items had not been associated with an observed fire cannot be taken to mean that they can be eliminated as potential ignition sources.

HVAC = heating, ventilation, and air conditioning.

Source: Ref. F2.2.76.

**APPENDIX F.II
DERIVATION OF IGNITION SOURCE DISTRIBUTION AND
FIRE PROPAGATION PROBABILITIES**

Three independent data sets concerning fires in radioactive material working facilities (Tables F.II-1 through F.II-3) have been analyzed for statistical confidence. The data sets are in the format of a tally; each sample (fire) is placed in the appropriate category (equipment type, extent of flame damage, etc.), and the reported figure for each category is the number of fires that pertained to the category. All of these data sets reflect the operating history of nuclear facilities of non-combustible construction as defined by the NFPA. The NFPA data is taken from NFPA, 2007.³

The first data set provides a distribution of fire ignition as a function of the ignition source category, as defined in Appendix F.I. Table F.II.1 provides a summary of that data.

Table F.II-1. Fires in Radioactive Material Working Facilities by Originating Equipment

Ignition Source Category	Fires	
Electrical	16	9%
Mechanical/Electrical HVAC	15	8%
Mechanical	26	14%
Heat Generating	29	16%
Torches/Welders	41	22%
Internal Combustion	4	2%
Offices/Kitchen Equipment	12	6%
Portable Equipment	19	10%
No Equipment	25	13%
Total	187	100%

NOTE: HVAC = heating, ventilation, and air conditioning.

Source: Ref. F2.2.76.

³ NFPA, "Structure Fires in Radioactive Material Working Facilities and Nuclear Energy Plants of Non-Combustible Construction," 1980-1998, National Fire Protection Association, April 2007. (Ref. F2.2.77)

Table F.II-2. Structure Fires in Radioactive Material Working Facilities and Nuclear Energy Plants of Non-Combustible Construction and in which No Automatic Suppression System Was Present or the Automatic Suppression System Failed to Operate

Extent of Flame Damage	Fires	
	Confined to object of origin	54
Confined to part of room/area of origin	13	15%
Confined to room of origin	0	0
Confined to fire-rated compartment of origin	5	6%
Confined to floor of origin	0	0
Confined to structure of origin	14	16%
Extended beyond structure of origin	0	0
Total	86	100%

Source: Ref. F2.2.76.

Table F.II-3. Structure Fires in Radioactive Material Working Facilities and Nuclear Energy Plants of Non-Combustible Construction and in which the Fire Was Too Small to Activate the Automatic Suppression System or the Automatic System Operated Properly

Extent of Flame Damage	Fires	
	Confined to object of origin	40
Confined to part of room/area of origin	23	32%
Confined to room of origin	2	3%
Confined to fire-rated compartment of origin	0	0%
Confined to floor of origin	5	7%
Confined to structure of origin	2	3%
Extended beyond structure of origin	0	0
Total	72	100%

Source: Ref. F2.2.76.

The method chosen for calculating the confidence interval of the data is the margin of error calculation as follows in Equation F.II-1:

$$ME = \sqrt{\frac{p(1-p)}{n}} \times t \quad (\text{Eq. F.II-1})$$

where

- ME = Margin of error
- p = Event probability
- n = Number of samples
- t = t -distribution value (see Table F.II-4)

The event probabilities are in the second “Fire” column of Tables F.II-1 through F.II-3, and are converted to decimal format (divided by 100) for the calculations. Values for t are obtained from a standard t -distribution table, the necessary excerpt from which is provided in Table F.II-4.

Table F.II-4. t -Distribution Value

		α	
		0.025	0.005
v	60	2.000	2.660
	120	1.980	2.617
Source: Ref. F2.2.79.			

where

- α = One minus the confidence interval divided by two (e.g., a 95% confidence interval corresponds to an α of 0.025)
- v = Degrees of freedom (number of samples minus one)

For the data sets analyzed, confidence intervals of 95% and 99% were analyzed. This is done because while 95% is an accepted and commonly used confidence interval, 99% is an extremely conservative confidence interval.

Completed calculations and the ranges based on the margins of error are provided in Tables F.II-5 through F.II-10 below. To demonstrate the calculations performed in Tables F.II-5 through F.II-10, an example is completed from Table F.II-5, row 1. The event probability (P) is determined by dividing the number of occurrences (16) for that event by the total number of fires (187). Thus, 0.0856 is the event probability for an electrically originated fire. The margin of error (ME) is then calculated utilizing Equation 1 above, obtaining t^* from Table F.II-4. For this example, t^* is 1.98 because the degrees of freedom ($v = n-1 = 186$) is greater than 120, and the confidence interval is 95 %, making $\alpha=0.025$. The ME obtained, ± 0.0405 , when subtracted from and added to the event probability provides a percentile range (Probability range column). It can be said with 95% confidence that the true event probability lies within this range. The final column is an occurrences range, which is calculated by converting the percentages of the preceding row to decimal format (dividing by 100), and multiplying them by the total number of fires (187). It can be said with 95% confidence that the true number of occurrences for any set of 187 fires is within this range. The calculations throughout Tables F.-II-5 through F.II-10 are performed in the same manner, with the value of t^* depending on the number of samples (fires) and the confidence interval.

Table F.II-5. Margin of Error Results at 95% Confidence Interval for Fires in Radioactive Material Working Facilities by Originating Equipment

Equipment Type	Occurrences	Probability		Margin of Error (95% confidence)	Probability range based on Margin of Error (%)	Occurrences range based on Margin of Error
Electrical	16	8.56E-02	±	4.05E-02	4.51 ≤ p ≤ 12.61	8.43 ≤ O ≤ 23.58
Mechanical/Electrical HVAC	15	8.02E-02	±	3.93E-02	4.09 ≤ p ≤ 11.95	7.65 ≤ O ≤ 22.35
Mechanical	26	1.39E-01	±	5.01E-02	8.89 ≤ p ≤ 18.91	16.62 ≤ O ≤ 35.36
Heat Generating	29	1.55E-01	±	5.24E-02	10.27 ≤ p ≤ 20.75	19.20 ≤ O ≤ 38.80
Torches/Welders	41	2.19E-01	±	5.99E-02	15.93 ≤ p ≤ 27.92	29.79 ≤ O ≤ 52.21
Internal Combustion	4	2.14E-02	±	2.09E-02	0.04 ≤ p ≤ 4.23	0.07 ≤ O ≤ 7.91
Offices/Kitchen Equipment	12	6.42E-02	±	3.55E-02	2.87 ≤ p ≤ 9.97	5.37 ≤ O ≤ 18.64
Portable Equipment	19	1.02E-01	±	4.37E-02	5.79 ≤ p ≤ 14.53	10.83 ≤ O ≤ 27.17
No Equipment	25	1.34E-01	±	4.93E-02	8.44 ≤ p ≤ 18.3	15.78 ≤ O ≤ 34.22
Total	187	1				

NOTE: HVAC = heating, ventilation, and air conditioning.

Source: Original

Table F.II-6. Margin of Error Results at 99% Confidence Interval for Fires in Radioactive Material Working Facilities by Originating Equipment

Equipment Type	Occurrences	Probability		Margin of Error (99% confidence)	Probability range based on Margin of Error (%)	Occurrences range based on Margin of Error
Electrical	16	8.56E-02	±	5.35E-02	3.2 ≤ p ≤ 13.91	5.98 ≤ O ≤ 26.01
Mechanical/Electrical HVAC	15	8.02E-02	±	5.20E-02	2.82 ≤ p ≤ 13.22	5.27 ≤ O ≤ 24.72
Mechanical	26	1.39E-01	±	6.62E-02	7.28 ≤ p ≤ 20.53	13.61 ≤ O ≤ 38.39
Heat Generating	29	1.55E-01	±	6.93E-02	8.58 ≤ p ≤ 22.44	16.04 ≤ O ≤ 41.96
Torches/Welders	41	2.19E-01	±	7.92E-02	14.01 ≤ p ≤ 29.84	26.20 ≤ O ≤ 55.80
Internal Combustion	4	2.14E-02	±	2.77E-02	-0.63 ≤ p ≤ 4.91	0.00 ≤ O ≤ 9.18
Offices/Kitchen Equipment	12	6.42E-02	±	4.69E-02	1.73 ≤ p ≤ 11.11	3.24 ≤ O ≤ 20.78
Portable Equipment	19	1.02E-01	±	5.78E-02	4.38 ≤ p ≤ 15.94	8.19 ≤ O ≤ 29.81
No Equipment	25	1.34E-01	±	6.51E-02	6.86 ≤ p ≤ 19.88	12.83 ≤ O ≤ 37.18
Total	187	1				

NOTE: HVAC = heating, ventilation, and air conditioning.

Source: Original

Table F.II-7. Margin of Error Results at 95% Confidence Interval for Structure Fires in Radioactive Material Working Facilities and Nuclear Energy Plants of Non-Combustible Construction and in which No Automatic Suppression System Was Present or the Automatic Suppression System Failed to Operate

Extent of Flame Damage	Occurrences	Probability	Margin of Error (95% confidence)		Probability range based on Margin of Error (%)			Occurrences range based on Margin of Error		
			±			≤ p ≤			≤ O ≤	
Confined to object of origin	54	6.21E-01	±	1.04E-01	51.67	≤ p ≤	72.48	44.78	≤ O ≤	62.81
Confined to part of room/area of origin	13	1.49E-01	±	7.65E-02	7.3	≤ p ≤	22.59	6.33	≤ O ≤	19.58
Confined to room of origin	0.33	3.79E-03	±	1.32E-02	0	≤ p ≤	1.7	0	≤ O ≤	1.47
Confined to fire-rated compartment of origin	5	5.75E-02	±	4.99E-02	0.76	≤ p ≤	10.74	0.66	≤ O ≤	9.31
Confined to floor of origin	0.33	3.79E-03	±	1.32E-02	0	≤ p ≤	1.7	0	≤ O ≤	1.47
Confined to structure of origin	14	1.61E-01	±	7.88E-02	8.21	≤ p ≤	23.97	7.11	≤ O ≤	20.77
Extended beyond structure of origin	0.33	3.79E-03	±	1.32E-02	0	≤ p ≤	1.7	0	≤ O ≤	1.47
Total	86.99	1								

Source: Original

Table F.II-8. Margin of Error Results at 99% Confidence Interval for Structure Fires in Radioactive Material Working Facilities and Nuclear Energy Plants of Non-Combustible Construction and in which No Automatic Suppression System Was Present or the Automatic Suppression System Failed to Operate

Extent of Flame Damage	Occurrences	Probability	Margin of Error (99% confidence)		Probability range based on Margin of Error (%)			Occurrences range based on Margin of Error		
			±			≤ p ≤			≤ O ≤	
Confined to object of origin	54	6.21E-01	±	1.38E-01	48.24	≤ p ≤	75.91	41.8	≤ O ≤	65.78
Confined to part of room/area of origin	13	1.49E-01	±	1.02E-01	4.78	≤ p ≤	25.11	4.14	≤ O ≤	21.76
Confined to room of origin	0.33	3.79E-03	±	1.75E-02	0	≤ p ≤	2.13	0	≤ O ≤	1.85
Confined to fire-rated compartment of origin	5	5.75E-02	±	6.64E-02	0	≤ p ≤	12.39	0	≤ O ≤	10.74
Confined to floor of origin	0.33	3.79E-03	±	1.75E-02	0	≤ p ≤	2.13	0	≤ O ≤	1.85
Confined to structure of origin	14	1.61E-01	±	1.05E-01	5.61	≤ p ≤	26.57	4.86	≤ O ≤	23.03
Extended beyond structure of origin	0.33	3.79E-03	±	1.75E-02	0	≤ p ≤	2.13	0	≤ O ≤	1.85
Total	86.99	1								

Source: Original

Table F.II-9. Margin of Error Results at 95% Confidence Interval for Structure Fires in Radioactive Material Working Facilities and Nuclear Energy Plants of Non-Combustible Construction and in which the Fire Was Too Small to Activate the Automatic Suppression System or the Automatic System Operated Properly

Extent of Flame Damage	Occurances	Probability	Margin of Error (95% confidence)		Probability range based on Margin of Error (%)			Occurances range based on Margin of Error		
			±			≤ p ≤			≤ O ≤	
Confined to object of origin	40	5.51E-01	±	1.17E-01	43.38	≤ p ≤	66.72	31.52	≤ O ≤	48.48
Confined to part of room/area of origin	23	3.17E-01	±	1.09E-01	20.74	≤ p ≤	42.57	15.07	≤ O ≤	30.93
Confined to room of origin	2	2.75E-02	±	3.84E-02	0	≤ p ≤	6.59	0	≤ O ≤	4.79
Confined to fire-rated compartment of origin	0.33	4.54E-03	±	1.58E-02	0	≤ p ≤	2.03	0	≤ O ≤	1.47
Confined to floor of origin	5	6.88E-02	±	5.94E-02	0.94	≤ p ≤	12.82	0.68	≤ O ≤	9.32
Confined to structure of origin	2	2.75E-02	±	3.84E-02	0	≤ p ≤	6.59	0	≤ O ≤	4.79
Extended beyond structure of origin	0.33	4.54E-03	±	1.58E-02	0	≤ p ≤	2.03	0	≤ O ≤	1.47
Total	72.66	1								

Source: Original

Table F.II-10. Margin of Error Results at 99% Confidence Interval for Structure Fires in Radioactive Material Working Facilities and Nuclear Energy Plants of Non-Combustible Construction and in which the Fire Was Too Small to Activate the Automatic Suppression System or the Automatic System Operated Properly

Extent of Flame Damage	Occurrences	Probability	Margin of Error (99% confidence)		Probability range based on Margin of Error (%)			Occurrences range based on Margin of Error		
			±			≤ p ≤			≤ O ≤	
Confined to object of origin	40	5.51E-01	±	1.55E-01	39.53	≤ p ≤	70.57	28.72	≤ O ≤	51.28
Confined to part of room/area of origin	23	3.17E-01	±	1.45E-01	17.14	≤ p ≤	46.17	12.45	≤ O ≤	33.55
Confined to room of origin	2	2.75E-02	±	5.11E-02	0	≤ p ≤	7.86	0	≤ O ≤	5.71
Confined to fire-rated compartment of origin	0.33	4.54E-03	±	2.10E-02	0	≤ p ≤	2.55	0	≤ O ≤	1.85
Confined to floor of origin	5	6.88E-02	±	7.90E-02	0	≤ p ≤	14.78	0	≤ O ≤	10.74
Confined to structure of origin	2	2.75E-02	±	5.11E-02	0	≤ p ≤	7.86	0	≤ O ≤	5.71
Extended beyond structure of origin	0.33	4.54E-03	±	2.10E-02	0	≤ p ≤	2.55	0	≤ O ≤	1.85
Total	72.66	1								

Source: Original

APPENDIX F.III DERIVATION OF IGNITION FREQUENCY DISTRIBUTION

For proper consideration of the fire frequency analysis of the CRCF, Wet Handling Facility, Initial Handling Facility, and Receipt Facility (RF), it was necessary to develop an uncertainty distribution for the industrial building fire frequency. The *Utilisation of Statistics to Assess Fire Risks in Buildings* study (Ref. F2.2.78) used to develop these frequencies presents an equation with floor area as an input to determine frequency. Equation F.III-1 is developed based on sample data collected:

$$f_m''(A) = c_1 A^r + c_2 A^s \tag{Eq. F.III-1}$$

where f_m'' is the annual fire frequency per square meter of floor area, A is the floor area, and the values c_1 , c_2 , r , and s are constants determined by the line of best fit derived from the data. For industrial buildings, the values for the constants are as follows: $c_1 = 3 \times 10^{-4}$, $c_2 = 5 \times 10^{-6}$, $r = -0.61$, and $s = -0.05$. The data for industrial buildings and the resulting line of best fit are presented in Figure F.III-1.

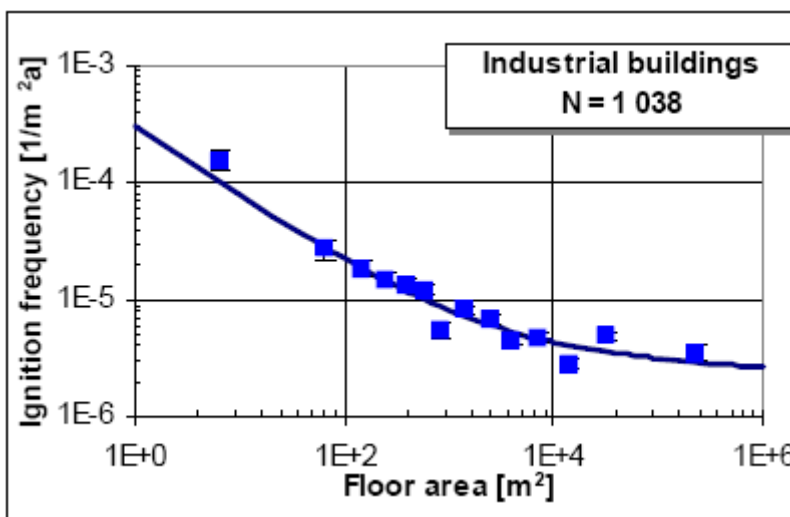

NOTE: m = meter.

Source: Ref. F2.2.78

Figure F.III.1. Ignition Frequency Observations

Each data point in the graph represents the average of many data points. The individual data points and the average values were not provided in the reference. Because the data were only presented graphically, it was necessary to estimate the data for the purposes of this analysis. To accomplish this, the center of each data point was found, and x axis values were added such that the powers increase by a unit of one. Horizontal and vertical lines were drawn from each data point to the x and y axes. The ignition frequency and floor area were then estimated based on the relative distances between these lines and the major axis values. For the example shown in Figure F.III-2 below, the distance from the 1E+2 label to the red vertical line is divided by the

distance from the 1E+2 to 1E+3 labels. In this case, the result is 0.925. Thus, the floor area for the data point is $10^{2.925}$. The ignition frequency is determined in an identical manner. The ignition frequency and floor area obtained in this manner are displayed in Table F.III-1. The ignition frequency predicted based on Equation F.III-1 is also provided in the table.

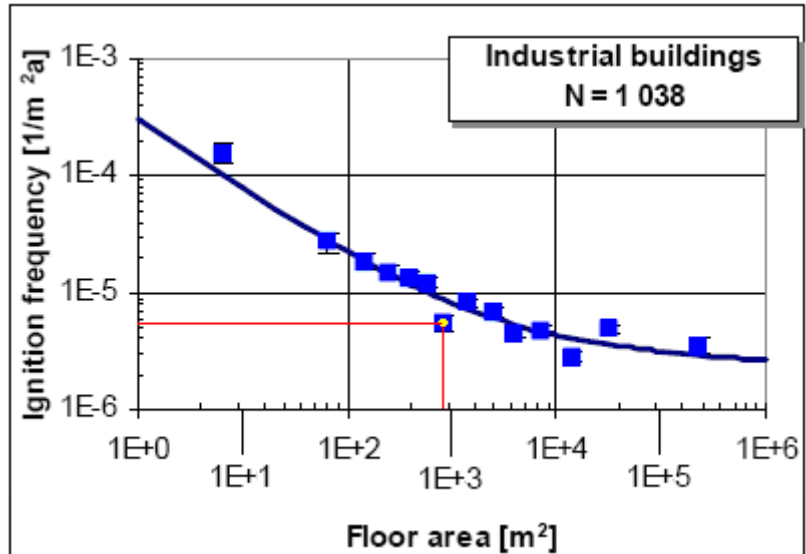

NOTE: m = meter.
Source: Ref. F2.2.78

Figure F.III-2. Data Point Determination

Table F.III-1. Ignition Frequency Data from Figure F.III-1 and Equation F.III-1

Graphically Determined Data Points		From Equation 1
Floor Area (m ²)	Ignition Frequency (1/yr m ²)	Predicted Frequency (1/yr m ²)
7	1.6×10^{-4}	9.6×10^{-5}
65	2.8×10^{-5}	2.8×10^{-5}
150	1.9×10^{-5}	1.8×10^{-5}
240	1.5×10^{-5}	1.4×10^{-5}
380	1.4×10^{-5}	1.2×10^{-5}
570	1.2×10^{-5}	9.9×10^{-6}
840	5.6×10^{-6}	8.5×10^{-6}
1,400	8.9×10^{-6}	7.1×10^{-6}
2,500	7.0×10^{-6}	5.9×10^{-6}
4,100	4.6×10^{-6}	5.2×10^{-6}
7,100	4.8×10^{-6}	4.5×10^{-6}
14,000	2.9×10^{-6}	4.0×10^{-6}
33,000	5.1×10^{-6}	3.5×10^{-6}
230,000	3.6×10^{-6}	2.9×10^{-6}

NOTE: m = meter; yr = year.

Source: Original

Because the ignition frequency is determined based on the line of best fit, the uncertainty distribution for the calculated ignition frequency can be determined by estimating the uncertainty in the ability of the best fit equation to predict the ignition frequency of any industrial building not included in the database. This is accomplished using the methodology presented below.

Statistics: Probability, Inference, and Decision (Ref. F2.2.79) outline a procedure to determine the confidence limits for a value predicted based on a linear regression equation. Though the ignition frequency and floor area are not linearly related, as illustrated by the figure and by equation F.III-1, the relationship between the log of the ignition frequency and the log of the floor area is approximately linear. This is illustrated in Figure F.III-3.

As shown in Figures F.III-1 and F.III-3, the portion of the curve for buildings less than 1,000m² has a steeper slope than the portion of the curve for buildings larger than 1,000m². For that reason, the data were divided into two ranges as shown in Figure F.III-4. Because all of the YMP facilities have floor areas larger than 1,000m², the remaining analysis focused on the upper end of the floor area range.

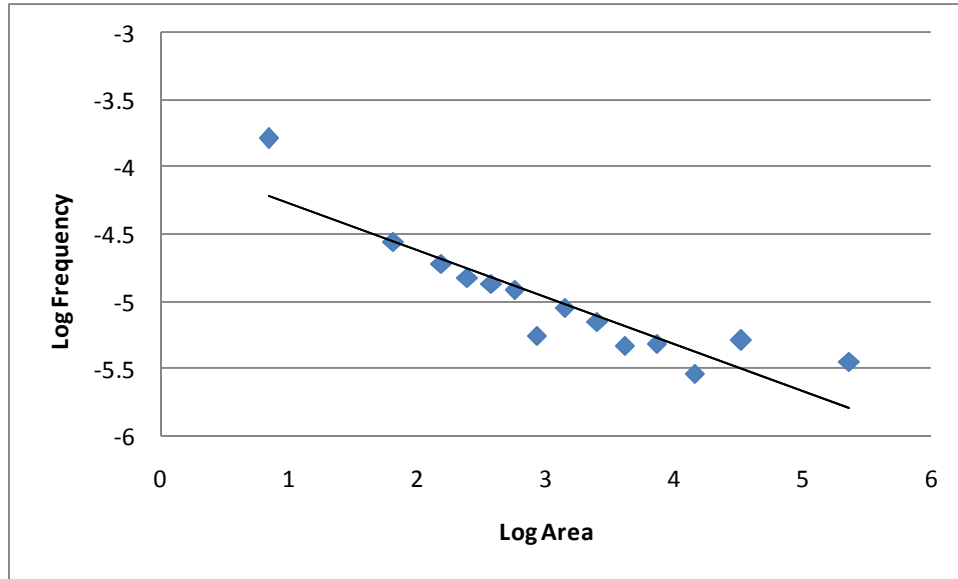

Source: Original

Figure F.III-3. Plot of Log(Ignition Frequency) as a Function of Log(Floor Area)

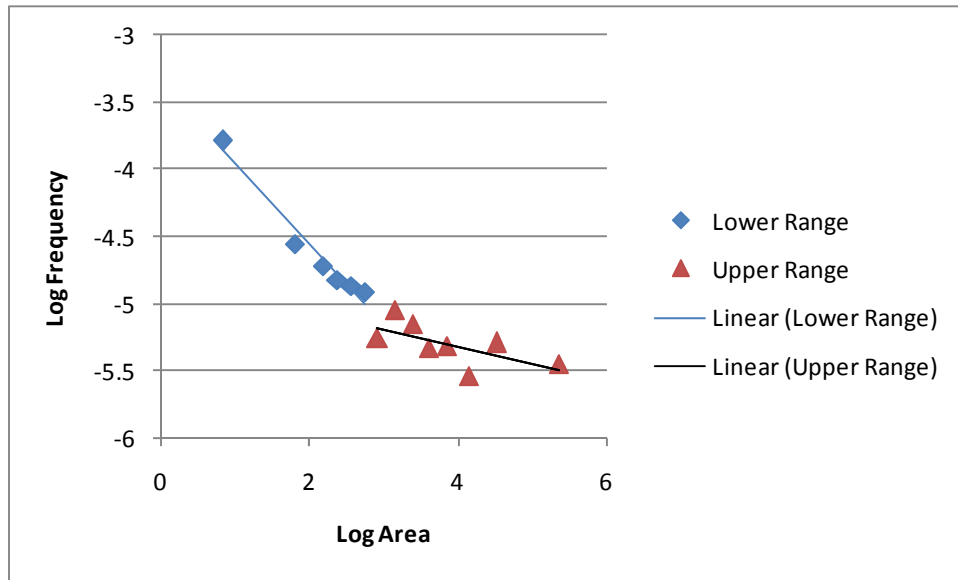

Source: Original.

Figure F.III-4. Plot of Log(Ignition Frequency) as a Function of Log(Floor Area) Divided into Two Floor Area Ranges

To arrive at the confidence interval for the log of the ignition frequency, Equations F.III-2, F.III-3, and F.III-4 are used:

$$\hat{y} \pm a \frac{s_{xy}}{\sqrt{n-2}} \sqrt{n+1 + \frac{(x - m_x)^2}{s_x^2}} \quad (\text{Eq. F.III-2})$$

$$s_{xy} = \sqrt{s_y^2(1 - r_{xy}^2)} \quad (\text{Eq. F.III-3})$$

$$r_{xy} = \frac{\sum_{i=0}^{i=n} (x_i - m_x)(y - m_y)}{n s_x s_y} \quad (\text{Eq. F.III-4})$$

where

- \hat{y} = the predicted value for the log of the ignition frequency using Equation F-III.1
- x = the log of the corresponding floor area value
- n = number of data points used in the linear regression analysis (8 for the upper floor area range)
- a = the $1-(\alpha/2)$ fractile of the t-distribution with $n-2$ degrees of freedom (for a 95% confidence interval, α is 5% and the value for a is 2.447)
- x_i = the x data values (log of floor area)
- y_i = the y data values (log of ignition frequency)
- m_x = the mean of the x data values
- m_y = the mean of the y data values
- s_x = the standard deviation of the x data values
- s_y = the standard deviation of the y data values

The upper and lower confidence limits (i.e., the 97.5% and 2.5% values) for any predicted value of the ignition frequency can be determined from Equations F.III-2 through F.III-4 using the x - y data for the upper end of the floor area range. The upper and lower confidence limits for the ignition frequency were then determined by taking the anti-log of the predicted y values. Figure F.III-5 is a plot showing the original data, the predicted values using Equation F.III-1, and the upper and lower confidence limits for the predicted values. The same approach can be used to determine the upper and lower confidence limits for the ignition frequency calculated for each of the YMP facilities. Those results are provided in Table F.III-2.

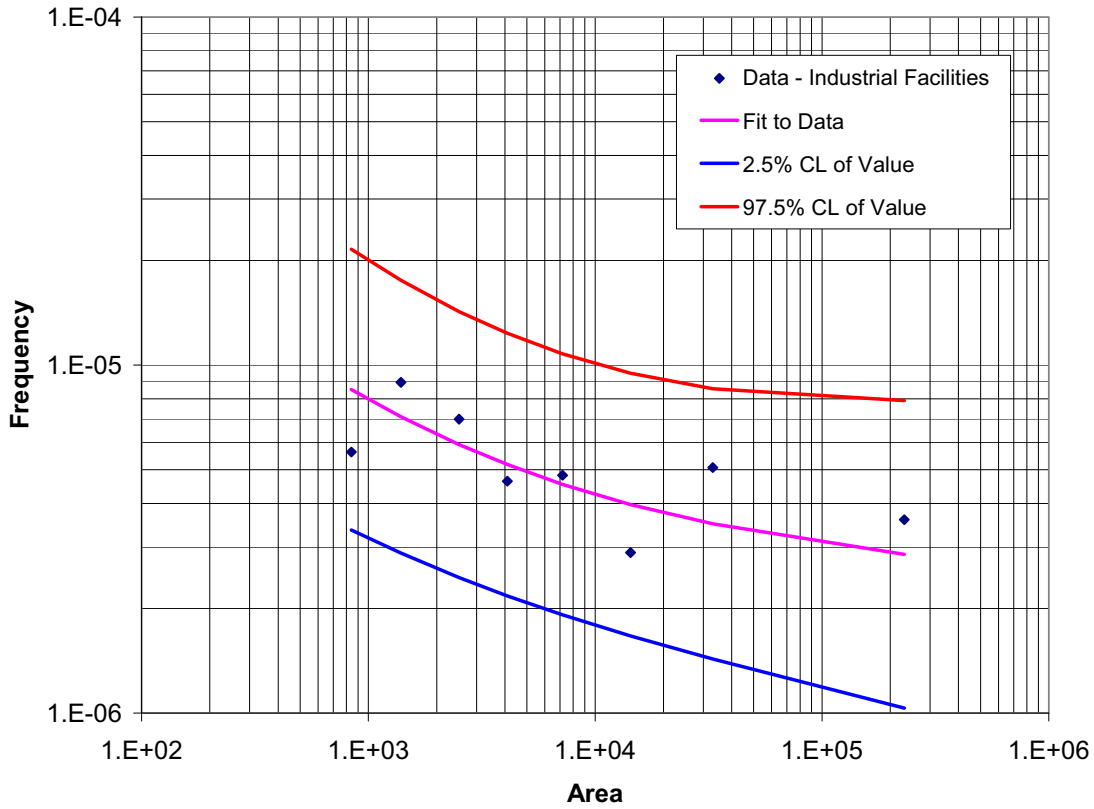

NOTE: CL = confidence limit.

Source: Original

Figure F.III-5. Plot of the Ignition Frequency Data, the Predicted Ignition Frequency, and Confidence Limits for the Predicted Value

Table F.III-2. Calculated Mean and Confidence Limits for the YMP Facility Ignition Frequency

Facility	Ignition Frequency (Ignitions per sq-m per year)		
	Median	2.5% LCL	97.5% UCL
CRCF	3.78×10^{-6}	1.58×10^{-6}	9.08×10^{-6}
IHF	4.79×10^{-6}	2.02×10^{-6}	1.14×10^{-5}
RF	4.05×10^{-6}	1.70×10^{-6}	9.64×10^{-6}
WHF	3.93×10^{-6}	1.65×10^{-6}	9.39×10^{-6}

NOTE: CRCF = Canister Receipt and Closure Facility; IHF = Initial Handling Facility; LCL = lower confidence limit; RF = Receipt Facility; ULC = upper confidence limit; WHF = Wet Handling Facility.

Source: Original

APPENDIX F.IV PROOF OF LOGNORMAL DISTRIBUTION

The fire initiating event frequencies presented throughout this document are the result of a series of calculations performed using inputs in the form of three different probability distributions. Two of the input distributions (see Appendix II) are normally distributed, and the third (see Appendix III) is lognormally distributed. After the calculations were performed, it was necessary to determine what type of distribution best represented the results. The Crystal Ball output (see Appendix VI) shows the calculated distributions at ten percentile intervals. Crystal Ball also provides the mean and the median of the distributions.

Microsoft Excel has a function, LOGNORMDIST, which can be utilized to calculate the corresponding intervals for a lognormal distribution. The Excel function requires that the log mean (μ) and log standard deviation (σ) be provided. To perform this analysis, it was necessary to calculate μ and σ using Equations F.IV-1 and F.IV-2, where the mean and median in these equations are provided in the Crystal Ball results.

$$\mu = \ln(\text{median}) \quad (\text{Eq. F.IV-1})$$

$$\sigma = \sqrt{2 \ln\left(\frac{\text{mean}}{\text{median}}\right)} \quad (\text{Eq. F.IV-2})$$

A comparison between the Crystal Ball and Excel percentile intervals reveals whether the data is a satisfactory fit to a lognormal distribution. Table F.IV-1 shows the result of this analysis. The table shows that the difference between the Excel calculated values and the Crystal Ball percentile values never exceeds 1.4 percent. Thus, it is concluded that the fire initiating events are lognormally distributed.

Table F.IV-1. Comparison Between Crystal Ball and Excel Percentile Intervals

Forecast Values	Excel Calculated Percentiles	Crystal Ball Percentiles	Difference
1.18E-08	0.003	0	0.00
5.49E-08	8.682	10	1.32
6.8E-08	18.84	20	1.16
7.9E-08	29.08	30	0.92
9.0E-08	39.81	40	0.19
1.0E-07	49.98	50	0.02
1.1E-07	59.86	60	0.14
1.3E-07	70.27	70	0.27
1.5E-07	80.58	80	0.58
1.8E-07	90.82	90	0.82
5.6E-07	99.99	100	0.01
Mu	-16.1067	Mean	1.12E-07
Sigma	0.4496	Median	1.01E-07

Source: Original

APPENDIX F.V DERIVATION OF ERROR FACTORS

It was necessary to provide an error factor for each initiating event frequency, which was calculated using data provided by Crystal Ball. The software output in Appendix F.VI provides the mean and median necessary to determine the error factor. Equation F.V-1 is utilized to calculate the log standard deviation (σ), and Equation F.V-2 provides a method for calculating the error factor from the log standard deviation.

$$\sigma = \sqrt{2 \ln \left(\frac{\text{mean}}{\text{median}} \right)} \quad (\text{Eq. F.V-1})$$

$$\text{EF} = e^{\sigma \times 1.645} \quad (\text{Eq. F.V-2})$$

The resultant error factors for each initiating event frequency are displayed in Table F5.7-5, as well as the mean and median utilized to calculate the error factor.

Several of the initiating event frequencies were not utilized as originally anticipated, many were summed for the purpose of developing split fractions. It was necessary to develop error factors for these summed figures as well. This was accomplished by directly summing the figures, then defining the summation as a Crystal Ball forecast value. The Crystal Ball results (Table F.5.7-7) provided a mean and median by which the error factors can be calculated using equations F.V-1 and F.V-2.

**APPENDIX F.VI
RESULTS FROM MONTE CARLO SIMULATION**

Initiating Event	97.5% Percentile
Large Fire Threatens TAD in WP in WPTT	1.4E-04
Large Fire Threatens TAD in WP in TEV	2.3E-06
Large Fire Threatens DOE-SNF in CTM (per canister)	1.5E-06
Large Fire Threatens DOE-SNF in Staging Area	1.4E+00
Large Fire Threatens DPC (VTC) in AO (Diesel)	2.0E-05
Large Fire Threatens DPC (VTC) in CTM	1.6E-06
Large Fire Threatens HLW and DOE-SNF in WP	1.4E-04
Large Fire Threatens HLW in CTM (per indiv canister)	2.0E-06
Large Fire Threatens HLW in WP	1.7E-05
Large Fire Threatens TAD in AO (Diesel Present)	1.5E-05
Large Fire Threatens TAD in CTM	2.0E-06
Large Fire Threatens TC/DOE-SNF (Diesel Present)	2.8E-06
Large Fire Threatens TC/DOE-SNF (No Diesel)	4.2E-05
Large Fire Threatens TC/DPC (VTC) (Diesel)	2.9E-06
Large Fire Threatens TC/DPC (VTC) (No Diesel)	4.0E-05
Large Fire Threatens TC/HLW (Diesel Present)	2.8E-06
Large Fire Threatens TC/HLW (No Diesel)	4.6E-05
Large Fire Threatens TC/TAD (Diesel Present)	2.8E-06
Large Fire Threatens TC/TAD (No Diesel)	4.4E-05
Localized Fire Threatens DOE-SNF in CTM in Transfer Room (per individual canister)	2.5E-07
Localized Fire Threatens DPC (VTC) in AO in Unloading Room (Diesel Present)	2.7E-07
Localized Fire Threatens DPC (VTC) in AO in Vestibule/Preparation Area (Diesel Present)	9.2E-06
Localized Fire Threatens DPC (VTC) in CTM in Transfer Room	2.7E-07
Localized Fire Threatens HLW and DOE-SNF in WP in Loadout Room	1.6E-06
Localized Fire Threatens HLW and DOE-SNF in WP in Positioning/Closure Room	1.4E-04
Localized Fire Threatens HLW and DOE-SNF in WP in TEV in Loadout Room	4.1E-07
Localized Fire Threatens HLW in CTM in Transfer Room (per individual canister)	2.9E-07
Localized Fire Threatens HLW in WP in Positioning/Closure Room	1.9E-05
Localized Fire Threatens TAD in AO in Unloading Room (Diesel Present)	2.9E-07
Localized Fire Threatens TAD in AO in Vestibule/Preparation Area (Diesel Present)	6.3E-06
Localized Fire Threatens TAD in CTM in Transfer Room	2.5E-07
Localized Fire Threatens TAD in WP in Loadout Room	1.6E-06
Localized Fire Threatens TAD in WP in Positioning/Closure Room	1.4E-04
Localized Fire Threatens TAD/WP in TEV in Loadout Room	4.1E-07
Localized Fire Threatens TC/DOE-SNF in Preparation Area w/o SPM (No Diesel Present)	4.7E-06

Localized Fire Threatens TC/DOE-SNF in Vestibule/Preparation Area w/SPM (Diesel Present)	1.1E-06
Localized Fire Threatens TC/DOE-SNF on CTT in Preparation Area	5.6E-06
Localized Fire Threatens TC/DOE-SNF on CTT in Unloading Room	1.7E-06
Localized Fire Threatens TC/DPC (VTC) in Cask Unloading Room	1.5E-07
Localized Fire Threatens TC/DPC (VTC) in Preparation Area	5.6E-06
Localized Fire Threatens TC/DPC (VTC) in Preparation Area (No Diesel Present)	4.1E-06
Localized Fire Threatens TC/DPC (VTC) in Vestibule/Preparation Area (Diesel Present)	1.1E-06
Localized Fire Threatens TC/HLW in Preparation Area w/o SPM (No Diesel Present)	5.6E-06
Localized Fire Threatens TC/HLW in Vestibule/Preparation Area w/SPM (Diesel Present)	1.1E-06
Localized Fire Threatens TC/HLW on CTT in Preparation Area	5.3E-06
Localized Fire Threatens TC/HLW on CTT in Unloading Room	1.1E-06
Localized Fire Threatens TC/TAD in Preparation Area w/o SPM (No Diesel Present)	4.7E-06
Localized Fire Threatens TC/TAD in Vestibule/Preparation Area w/SPM (Diesel Present)	1.1E-06
Localized Fire Threatens TC/TAD on CTT in Preparation Area	6.0E-06
Localized Fire Threatens TC/TAD on CTT in Unloading Room	2.8E-07

NOTE: AO = aging overpack; CTM = canister transfer machine; CTT = cask transfer trolley; DOE = U.S. Department of Energy; DPC = dual-purpose canister; HLW = high-level radioactive waste; SNF = spent nuclear fuel; SPM = site prime mover; TAD = transportation, aging, and disposal; TC = transportation cask; TEV = transport and emplacement vehicle; VTC = a transportation cask that is upended on a railcar; WP = waste package; WPTT = waste package transfer trolley.

Source: Crystal Ball 'extract data' output.

The Crystal Ball report, forecast worksheets, and "assumptions" follow. The term "assumptions" is used by Crystal Ball to denote the probability distributions of the inputs, and does not refer to assumptions as defined by the calculations and analysis procedure.

Crystal Ball Report - Full

Simulation started on 11/7/2007 at 17:30:59
Simulation stopped on 11/7/2007 at 17:32:39

Run preferences:

Number of trials run	10,000
Monte Carlo	
Random seed	

Run statistics:

Total running time (sec)	100.05
Trials/second (average)	100
Random numbers per sec	1,699

Crystal Ball data:

Assumptions	17
Correlations	0
Correlated groups	0
Decision variables	0
Forecasts	49

Forecasts

Worksheet: [CRCF Fire Frequency - No Suppression.xls]Initiating Event Frequency

Forecast: Large Fire Threatens TAD in WP in TEV

Cell: K210

Summary:

Entire range is from 4.5E-08 to 5.2E-06
Base case is 9.2E-07
After 10,000 trials, the std. error of the mean is 5.2E-09

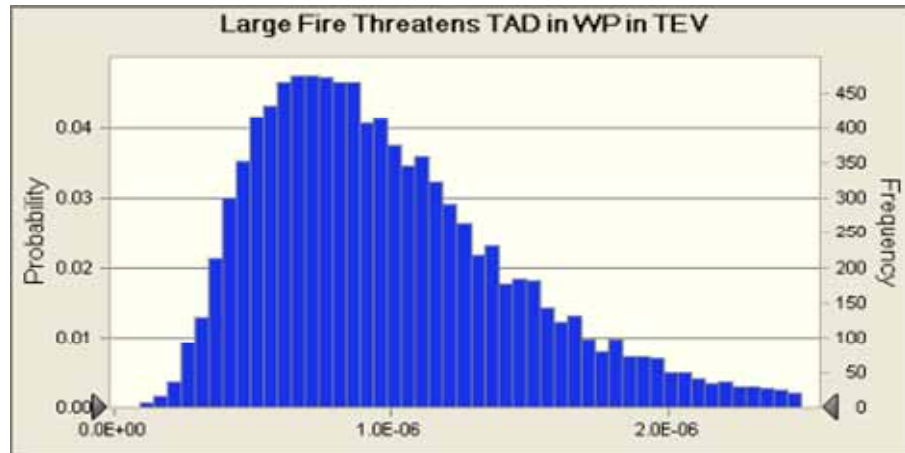

Statistics:

Forecast values

Trials	10,000
Mean	1.0E-06
Median	9.1E-07
Mode	1.4E-06
Standard Deviation	5.2E-07
Variance	2.7E-13
Skewness	1.43
Kurtosis	6.53
Coeff. of Variability	0.5124
Minimum	4.5E-08
Maximum	5.2E-06
Range Width	5.2E-06
Mean Std. Error	5.2E-09

Forecast: Large Fire Threatens TAD in WP in TEV (cont'd)

Cell: K210

Percentiles:

Forecast values

0%	4.5E-08
10%	4.7E-07
20%	5.9E-07
30%	7.0E-07
40%	8.0E-07
50%	9.1E-07
60%	1.0E-06
70%	1.2E-06
80%	1.4E-06
90%	1.7E-06
100%	5.2E-06

Forecast: Large Fire Threatens TAD in WP in WPTT

Cell: K209

Summary:

Entire range is from 2.6E-06 to 3.0E-04
Base case is 5.4E-05
After 10,000 trials, the std. error of the mean is 3.0E-07

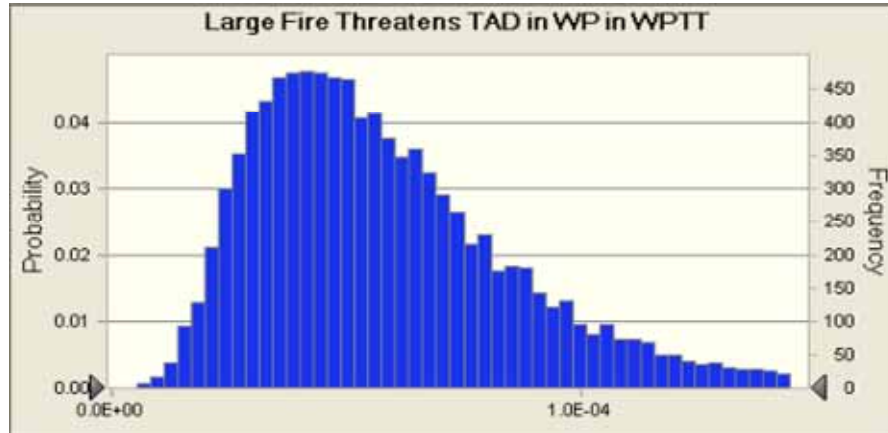

Statistics:

Forecast values

Trials	10,000
Mean	5.9E-05
Median	5.3E-05
Mode	8.1E-05
Standard Deviation	3.0E-05
Variance	9.2E-10
Skewness	1.43
Kurtosis	6.53
Coeff. of Variability	0.5124
Minimum	2.6E-06
Maximum	3.0E-04
Range Width	3.0E-04
Mean Std. Error	3.0E-07

Forecast: Large Fire Threatens TAD in WP in WPTT (cont'd)

Cell: K209

Percentiles:

Forecast values

0%	2.6E-06
10%	2.8E-05
20%	3.4E-05
30%	4.1E-05
40%	4.7E-05
50%	5.3E-05
60%	6.0E-05
70%	6.9E-05
80%	8.0E-05
90%	9.9E-05
100%	3.0E-04

Forecast: Large Fire Threatens DOE-SNF in CTM (per canister)

Cell: K217

Summary:

Entire range is from 2.8E-08 to 3.3E-06
Base case is 5.8E-07
After 10,000 trials, the std. error of the mean is 3.3E-09

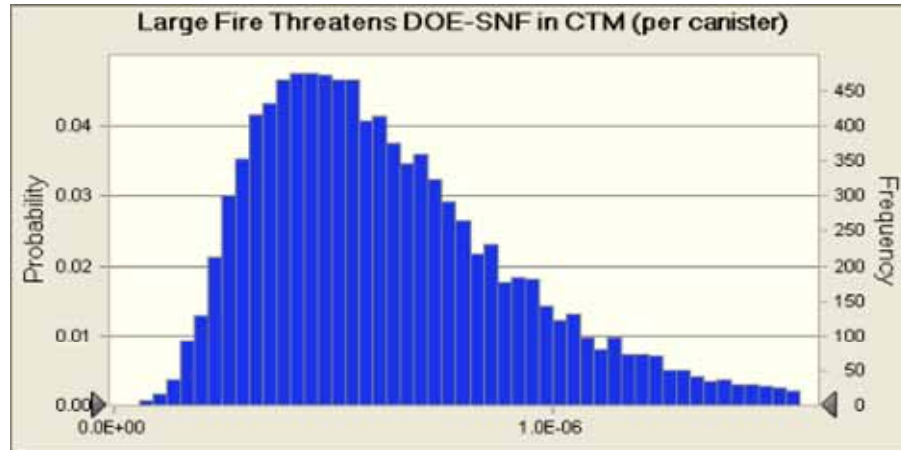

Statistics:

	Forecast values
Trials	10,000
Mean	6.4E-07
Median	5.8E-07
Mode	8.8E-07
Standard Deviation	3.3E-07
Variance	1.1E-13
Skewness	1.43
Kurtosis	6.53
Coeff. of Variability	0.5124
Minimum	2.8E-08
Maximum	3.3E-06
Range Width	3.3E-06
Mean Std. Error	3.3E-09

Forecast: Large Fire Threatens DOE-SNF in CTM (per canister) (cont'd)

Cell: K217

Percentiles:

	Forecast values
0%	2.8E-08
10%	3.0E-07
20%	3.7E-07
30%	4.4E-07
40%	5.0E-07
50%	5.8E-07
60%	6.5E-07
70%	7.5E-07
80%	8.7E-07
90%	1.1E-06
100%	3.3E-06

Forecast: Large Fire Threatens DOE-SNF in Staging Area

Cell: K218

Summary:

Entire range is from 7.5E-02 to 3.9E+00
Base case is 5.2E-01
After 10,000 trials, the std. error of the mean is 3.0E-03

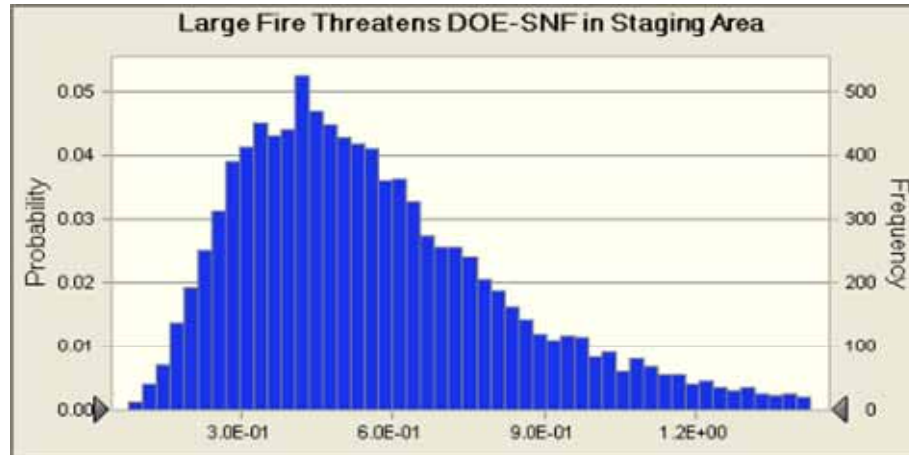

Statistics:

	Forecast values
Trials	10,000
Mean	5.8E-01
Median	5.2E-01
Mode	—
Standard Deviation	3.0E-01
Variance	9.2E-02
Skewness	1.52
Kurtosis	7.35
Coeff. of Variability	0.5220
Minimum	7.5E-02
Maximum	3.9E+00
Range Width	3.8E+00
Mean Std. Error	3.0E-03

Forecast: Large Fire Threatens DOE-SNF in Staging Area (cont'd)

Cell: K218

Percentiles:

	Forecast values
0%	7.5E-02
10%	2.7E-01
20%	3.3E-01
30%	4.0E-01
40%	4.5E-01
50%	5.2E-01
60%	5.9E-01
70%	6.7E-01
80%	7.8E-01
90%	9.8E-01
100%	3.9E+00

Forecast: Large Fire Threatens DPC (VTC) in AO (Diesel)

Cell: K222

Summary:

Entire range is from 1.1E-06 to 5.7E-05
Base case is 7.6E-06
After 10,000 trials, the std. error of the mean is 4.4E-08

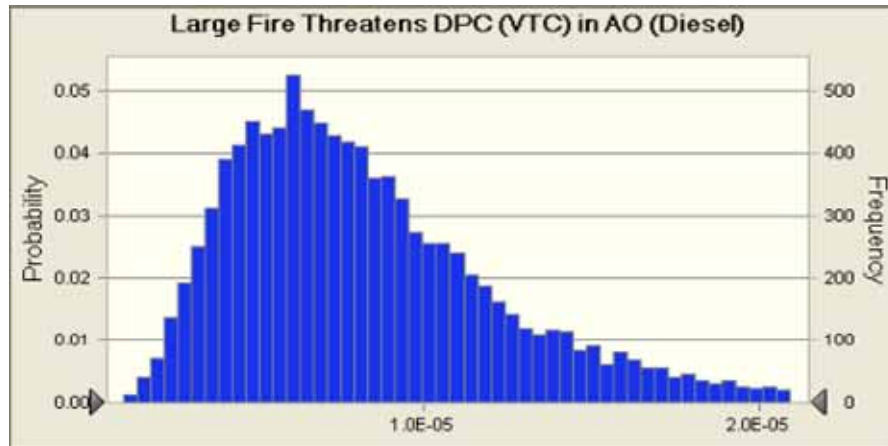

Statistics:

	Forecast values
Trials	10,000
Mean	8.5E-06
Median	7.6E-06
Mode	---
Standard Deviation	4.4E-06
Variance	2.0E-11
Skewness	1.52
Kurtosis	7.35
Coeff. of Variability	0.5220
Minimum	1.1E-06
Maximum	5.7E-05
Range Width	5.6E-05
Mean Std. Error	4.4E-08

Forecast: Large Fire Threatens DPC (VTC) in AO (Diesel) (cont'd)

Cell: K222

Percentiles:

	Forecast values
0%	1.1E-06
10%	3.9E-06
20%	4.9E-06
30%	5.8E-06
40%	6.7E-06
50%	7.6E-06
60%	8.6E-06
70%	9.8E-06
80%	1.1E-05
90%	1.4E-05
100%	5.7E-05

Forecast: Large Fire Threatens DPC (VTC) in CTM

Cell: K221

Summary:

Entire range is from 3.1E-08 to 3.6E-06
Base case is 6.4E-07
After 10,000 trials, the std. error of the mean is 3.6E-09

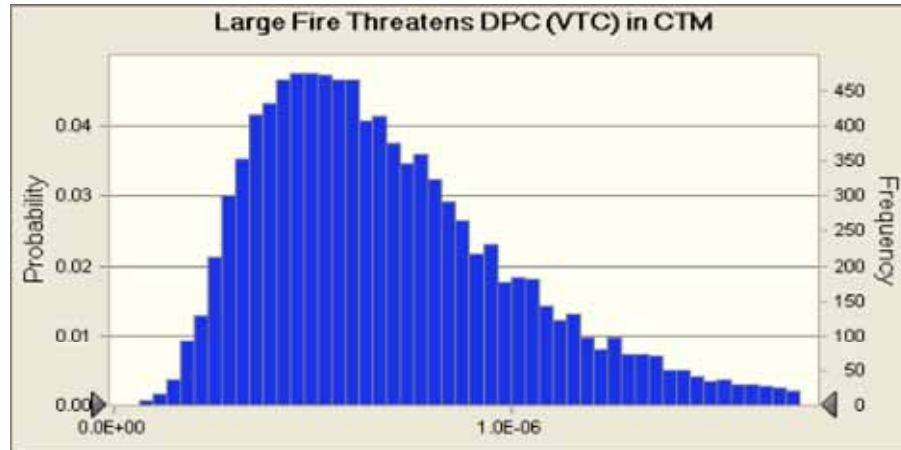

Statistics:

	Forecast values
Trials	10,000
Mean	7.1E-07
Median	6.4E-07
Mode	9.7E-07
Standard Deviation	3.6E-07
Variance	1.3E-13
Skewness	1.43
Kurtosis	6.53
Coeff. of Variability	0.5124
Minimum	3.1E-08
Maximum	3.6E-06
Range Width	3.6E-06
Mean Std. Error	3.6E-09

Forecast: Large Fire Threatens DPC (VTC) in CTM (cont'd)

Cell: K221

Percentiles:

	Forecast values
0%	3.1E-08
10%	3.3E-07
20%	4.1E-07
30%	4.9E-07
40%	5.6E-07
50%	6.3E-07
60%	7.2E-07
70%	8.2E-07
80%	9.6E-07
90%	1.2E-06
100%	3.6E-06

Forecast: Large Fire Threatens HLW and DOE-SNF in WP

Cell: K214

Summary:

Entire range is from 7.9E-06 to 4.1E-04
Base case is 5.5E-05
After 10,000 trials, the std. error of the mean is 3.2E-07

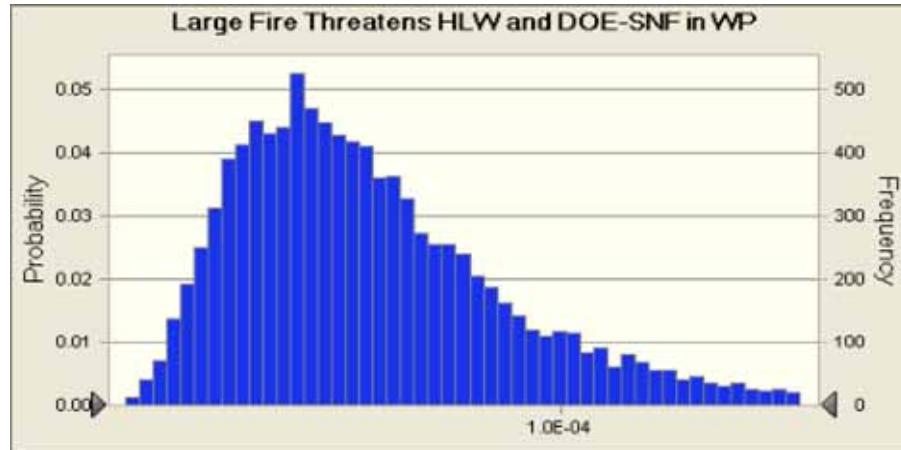

Statistics:

	Forecast values
Trials	10,000
Mean	6.1E-05
Median	5.5E-05
Mode	---
Standard Deviation	3.2E-05
Variance	1.0E-09
Skewness	1.52
Kurtosis	7.35
Coeff. of Variability	0.5220
Minimum	7.9E-06
Maximum	4.1E-04
Range Width	4.0E-04
Mean Std. Error	3.2E-07

Forecast: Large Fire Threatens HLW and DOE-SNF in WP (cont'd)

Cell: K214

Percentiles:

	Forecast values
0%	7.9E-06
10%	2.8E-05
20%	3.5E-05
30%	4.2E-05
40%	4.8E-05
50%	5.5E-05
60%	6.2E-05
70%	7.0E-05
80%	8.2E-05
90%	1.0E-04
100%	4.1E-04

Forecast: Large Fire Threatens HLW in CTM (per indiv canister)

Cell: K212

Summary:

Entire range is from 1.1E-07 to 5.8E-06
Base case is 7.7E-07
After 10,000 trials, the std. error of the mean is 4.5E-09

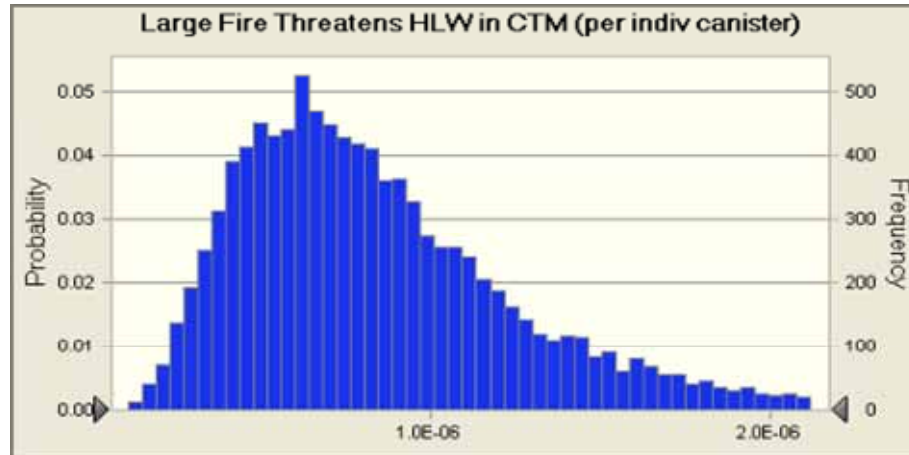

Statistics:

	Forecast values
Trials	10,000
Mean	8.6E-07
Median	7.7E-07
Mode	—
Standard Deviation	4.5E-07
Variance	2.0E-13
Skewness	1.52
Kurtosis	7.35
Coeff. of Variability	0.5220
Minimum	1.1E-07
Maximum	5.8E-06
Range Width	5.7E-06
Mean Std. Error	4.5E-09

Forecast: Large Fire Threatens HLW in CTM (per indiv canister) (cont'd)

Cell: K212

Percentiles:

	Forecast values
0%	1.1E-07
10%	4.0E-07
20%	5.0E-07
30%	5.9E-07
40%	6.7E-07
50%	7.7E-07
60%	8.7E-07
70%	9.9E-07
80%	1.2E-06
90%	1.4E-06
100%	5.8E-06

Forecast: Large Fire Threatens HLW in WP

Cell: K213

Summary:

Entire range is from 3.2E-07 to 3.7E-05
Base case is 6.6E-06
After 10,000 trials, the std. error of the mean is 3.8E-08

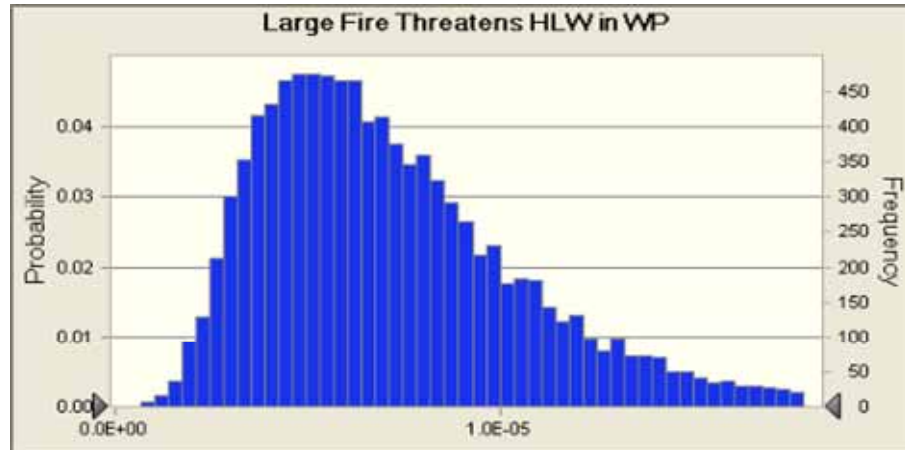

Statistics:

	Forecast values
Trials	10,000
Mean	7.3E-06
Median	6.6E-06
Mode	1.0E-05
Standard Deviation	3.8E-06
Variance	1.4E-11
Skewness	1.43
Kurtosis	6.53
Coeff. of Variability	0.5124
Minimum	3.2E-07
Maximum	3.7E-05
Range Width	3.7E-05
Mean Std. Error	3.8E-08

Forecast: Large Fire Threatens HLW in WP (cont'd)

Cell: K213

Percentiles:

	Forecast values
0%	3.2E-07
10%	3.4E-06
20%	4.3E-06
30%	5.0E-06
40%	5.8E-06
50%	6.6E-06
60%	7.5E-06
70%	8.5E-06
80%	9.9E-06
90%	1.2E-05
100%	3.7E-05

Forecast: Large Fire Threatens TAD in AO (Diesel Present)

Cell: K207

Summary:

Entire range is from 8.4E-07 to 4.3E-05
Base case is 5.8E-06
After 10,000 trials, the std. error of the mean is 3.4E-08

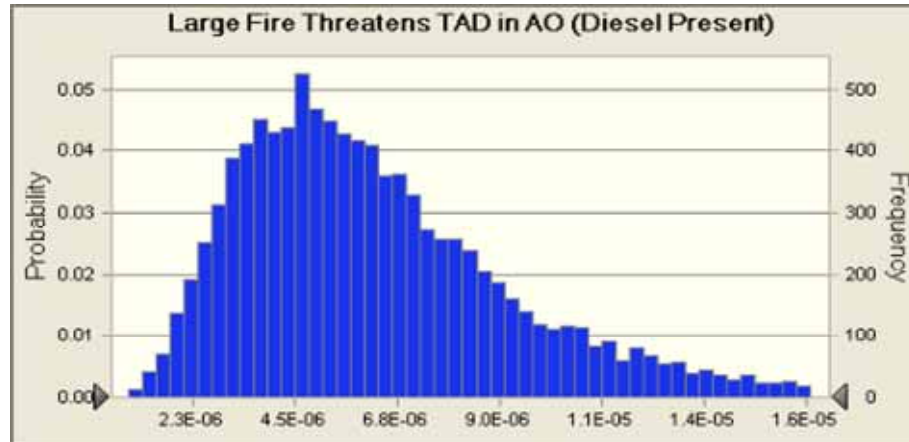

Statistics:

	Forecast values
Trials	10,000
Mean	6.5E-06
Median	5.8E-06
Mode	—
Standard Deviation	3.4E-06
Variance	1.1E-11
Skewness	1.52
Kurtosis	7.35
Coeff. of Variability	0.5220
Minimum	8.4E-07
Maximum	4.3E-05
Range Width	4.3E-05
Mean Std. Error	3.4E-08

Forecast: Large Fire Threatens TAD in AO (Diesel Present) (cont'd)

Cell: K207

Percentiles:

	Forecast values
0%	8.4E-07
10%	3.0E-06
20%	3.7E-06
30%	4.4E-06
40%	5.1E-06
50%	5.8E-06
60%	6.5E-06
70%	7.4E-06
80%	8.7E-06
90%	1.1E-05
100%	4.3E-05

Forecast: Large Fire Threatens TAD in CTM

Cell: K208

Summary:

Entire range is from 1.1E-07 to 5.8E-06
Base case is 7.7E-07
After 10,000 trials, the std. error of the mean is 4.5E-09

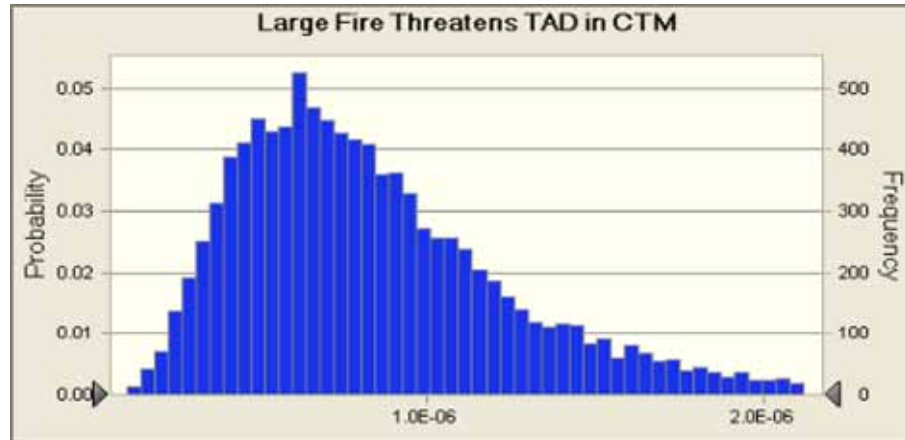

Statistics:

	Forecast values
Trials	10,000
Mean	8.6E-07
Median	7.7E-07
Mode	---
Standard Deviation	4.5E-07
Variance	2.0E-13
Skewness	1.52
Kurtosis	7.35
Coeff. of Variability	0.5220
Minimum	1.1E-07
Maximum	5.8E-06
Range Width	5.7E-06
Mean Std. Error	4.5E-09

Forecast: Large Fire Threatens TAD in CTM (cont'd)

Cell: K208

Percentiles:

	Forecast values
0%	1.1E-07
10%	4.0E-07
20%	5.0E-07
30%	5.9E-07
40%	6.7E-07
50%	7.7E-07
60%	8.7E-07
70%	9.9E-07
80%	1.2E-06
90%	1.4E-06
100%	5.8E-06

Forecast: Large Fire Threatens TC/DOE-SNF (Diesel Present)

Cell: K215

Summary:

Entire range is from 1.5E-07 to 8.0E-06
Base case is 1.1E-06
After 10,000 trials, the std. error of the mean is 6.2E-09

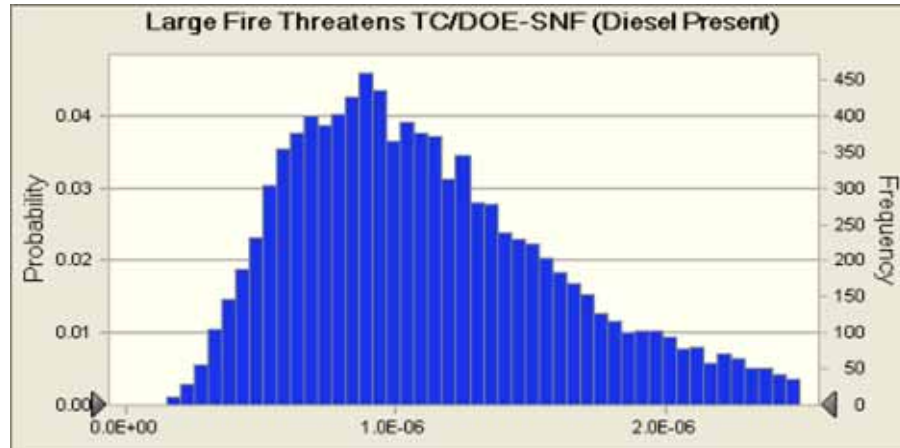

Statistics:

	Forecast values
Trials	10,000
Mean	1.2E-06
Median	1.1E-06
Mode	---
Standard Deviation	6.2E-07
Variance	3.9E-13
Skewness	1.52
Kurtosis	7.35
Coeff. of Variability	0.5220
Minimum	1.5E-07
Maximum	8.0E-06
Range Width	7.9E-06
Mean Std. Error	6.2E-09

Forecast: Large Fire Threatens TC/DOE-SNF (Diesel Present) (cont'd)

Cell: K215

Percentiles:

	Forecast values
0%	1.5E-07
10%	5.5E-07
20%	6.9E-07
30%	8.2E-07
40%	9.3E-07
50%	1.1E-06
60%	1.2E-06
70%	1.4E-06
80%	1.6E-06
90%	2.0E-06
100%	8.0E-06

Forecast: Large Fire Threatens TC/DOE-SNF (No Diesel)

Cell: K216

Summary:

Entire range is from 8.1E-07 to 9.4E-05
Base case is 1.7E-05
After 10,000 trials, the std. error of the mean is 9.5E-08

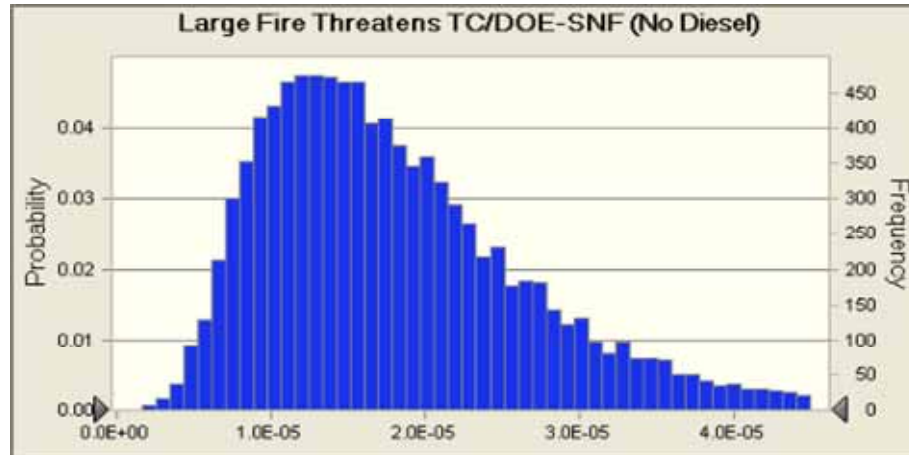

Statistics:

Forecast values

Trials	10,000
Mean	1.8E-05
Median	1.7E-05
Mode	2.5E-05
Standard Deviation	9.5E-06
Variance	8.9E-11
Skewness	1.43
Kurtosis	6.53
Coeff. of Variability	0.5124
Minimum	8.1E-07
Maximum	9.4E-05
Range Width	9.3E-05
Mean Std. Error	9.5E-08

Forecast: Large Fire Threatens TC/DOE-SNF (No Diesel) (cont'd)

Cell: K216

Percentiles:

Forecast values

0%	8.1E-07
10%	8.6E-06
20%	1.1E-05
30%	1.3E-05
40%	1.4E-05
50%	1.7E-05
60%	1.9E-05
70%	2.1E-05
80%	2.5E-05
90%	3.1E-05
100%	9.4E-05

Forecast: Large Fire Threatens TC/DPC (VTC) (Diesel)

Cell: K219

Summary:

Entire range is from 1.6E-07 to 8.3E-06
Base case is 1.1E-06
After 10,000 trials, the std. error of the mean is 6.5E-09

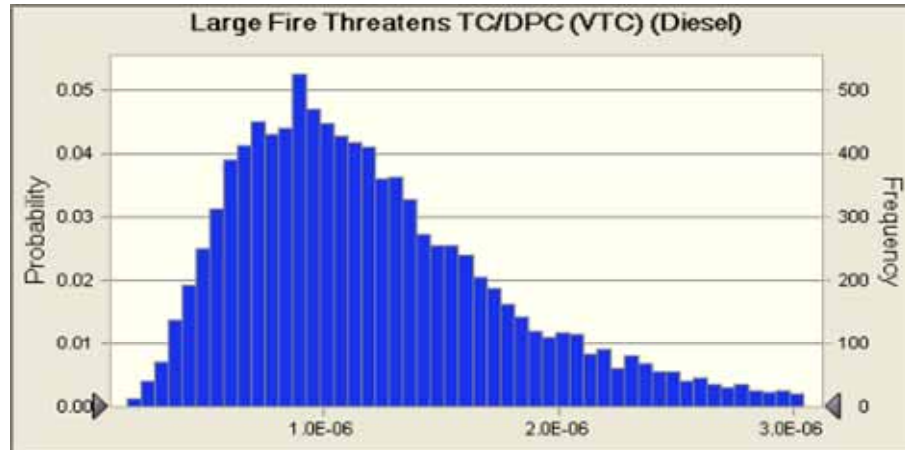

Statistics:

	Forecast values
Trials	10,000
Mean	1.2E-06
Median	1.1E-06
Mode	---
Standard Deviation	6.5E-07
Variance	4.2E-13
Skewness	1.52
Kurtosis	7.35
Coeff. of Variability	0.5220
Minimum	1.6E-07
Maximum	8.3E-06
Range Width	8.1E-06
Mean Std. Error	6.5E-09

Forecast: Large Fire Threatens TC/DPC (VTC) (Diesel) (cont'd)

Cell: K219

Percentiles:

	Forecast values
0%	1.6E-07
10%	5.7E-07
20%	7.1E-07
30%	8.5E-07
40%	9.7E-07
50%	1.1E-06
60%	1.2E-06
70%	1.4E-06
80%	1.7E-06
90%	2.1E-06
100%	8.3E-06

Forecast: Large Fire Threatens TC/DPC (VTC) (No Diesel)

Cell: K220

Summary:

Entire range is from 2.2E-06 to 1.2E-04
Base case is 1.5E-05
After 10,000 trials, the std. error of the mean is 8.9E-08

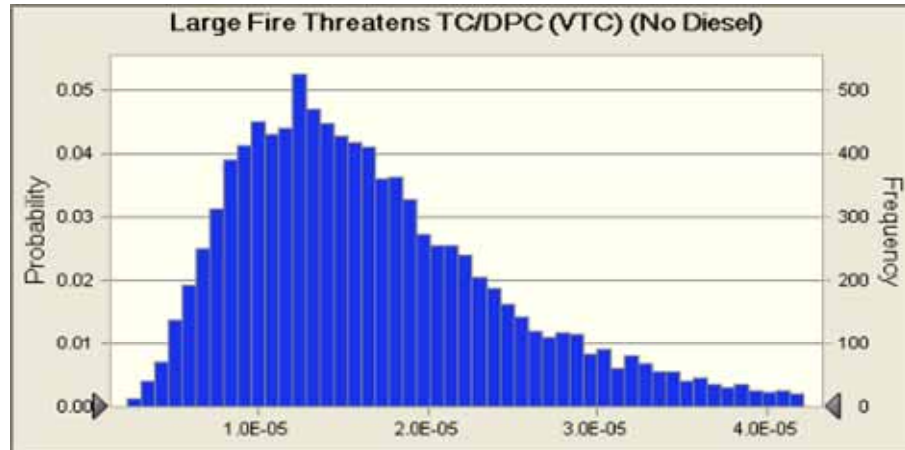

Statistics:

	Forecast values
Trials	10,000
Mean	1.7E-05
Median	1.5E-05
Mode	---
Standard Deviation	8.9E-06
Variance	8.0E-11
Skewness	1.52
Kurtosis	7.35
Coeff. of Variability	0.5220
Minimum	2.2E-06
Maximum	1.2E-04
Range Width	1.1E-04
Mean Std. Error	8.9E-08

Forecast: Large Fire Threatens TC/DPC (VTC) (No Diesel) (cont'd)

Cell: K220

Percentiles:

	Forecast values
0%	2.2E-06
10%	7.9E-06
20%	9.9E-06
30%	1.2E-05
40%	1.3E-05
50%	1.5E-05
60%	1.7E-05
70%	2.0E-05
80%	2.3E-05
90%	2.9E-05
100%	1.2E-04

Forecast: Large Fire Threatens TC/HLW (Diesel Present)

Cell: K210

Summary:

Entire range is from 1.5E-07 to 8.0E-06
Base case is 1.1E-06
After 10,000 trials, the std. error of the mean is 6.2E-09

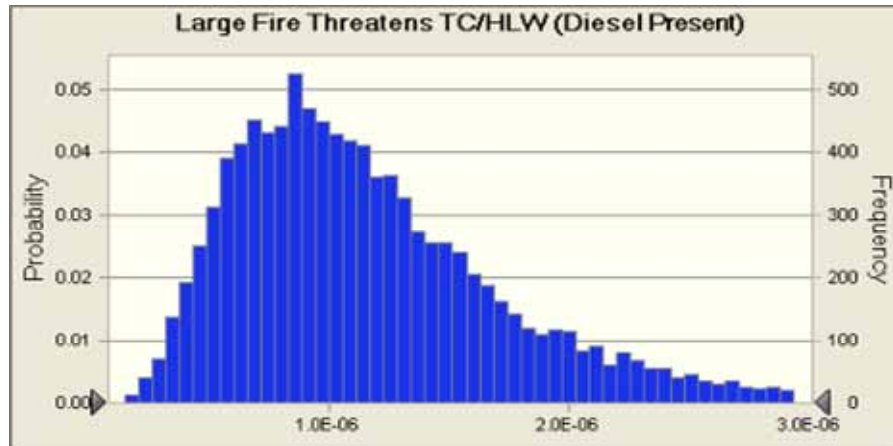

Statistics:

	Forecast values
Trials	10,000
Mean	1.2E-06
Median	1.1E-06
Mode	---
Standard Deviation	6.2E-07
Variance	3.9E-13
Skewness	1.52
Kurtosis	7.35
Coeff. of Variability	0.5220
Minimum	1.5E-07
Maximum	8.0E-06
Range Width	7.9E-06
Mean Std. Error	6.2E-09

Forecast: Large Fire Threatens TC/HLW (Diesel Present) (cont'd)

Cell: K210

Percentiles:

	Forecast values
0%	1.5E-07
10%	5.5E-07
20%	6.9E-07
30%	8.2E-07
40%	9.3E-07
50%	1.1E-06
60%	1.2E-06
70%	1.4E-06
80%	1.6E-06
90%	2.0E-06
100%	8.0E-06

Forecast: Large Fire Threatens TC/HLW (No Diesel)

Cell: K211

Summary:

Entire range is from 2.5E-06 to 1.3E-04
Base case is 1.8E-05
After 10,000 trials, the std. error of the mean is 1.0E-07

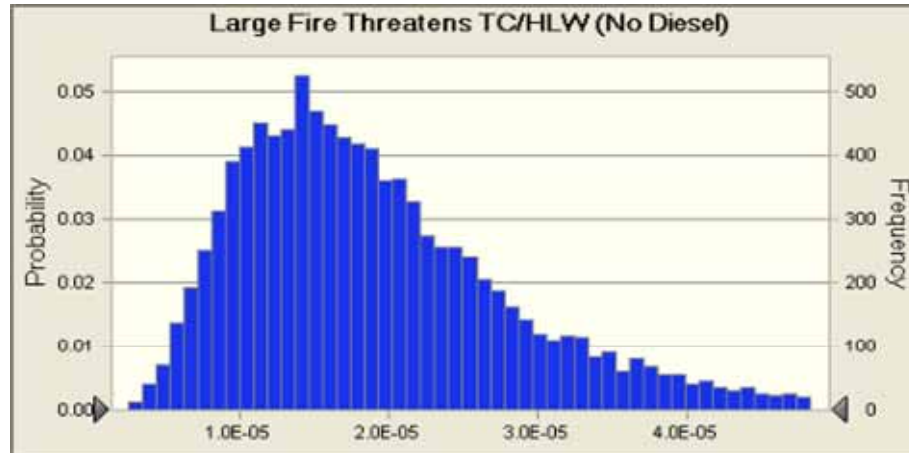

Statistics:

Forecast values

Trials	10,000
Mean	2.0E-05
Median	1.7E-05
Mode	—
Standard Deviation	1.0E-05
Variance	1.0E-10
Skewness	1.52
Kurtosis	7.35
Coeff. of Variability	0.5220
Minimum	2.5E-06
Maximum	1.3E-04
Range Width	1.3E-04
Mean Std. Error	1.0E-07

Forecast: Large Fire Threatens TC/HLW (No Diesel) (cont'd)

Cell: K211

Percentiles:

Forecast values

0%	2.5E-06
10%	9.0E-06
20%	1.1E-05
30%	1.3E-05
40%	1.5E-05
50%	1.7E-05
60%	2.0E-05
70%	2.3E-05
80%	2.6E-05
90%	3.3E-05
100%	1.3E-04

Forecast: Large Fire Threatens TC/TAD (Diesel Present)

Cell: K205

Summary:

Entire range is from 1.5E-07 to 8.0E-06
Base case is 1.1E-06
After 10,000 trials, the std. error of the mean is 6.2E-09

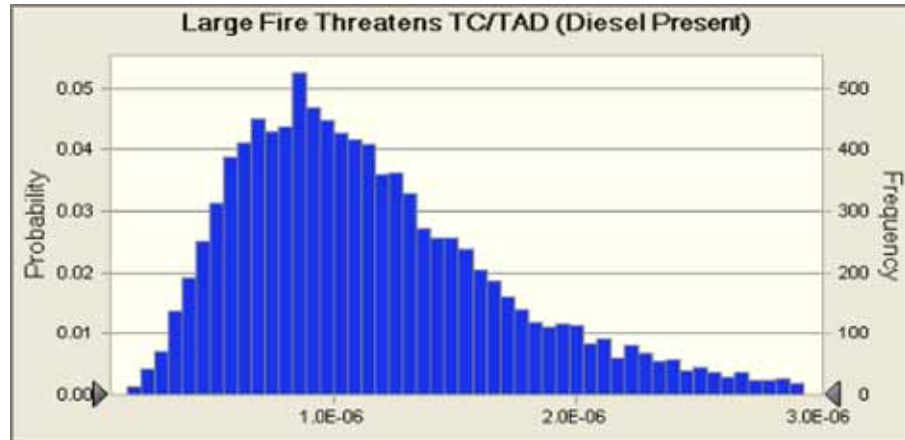

Statistics:

Forecast values

Trials	10,000
Mean	1.2E-06
Median	1.1E-06
Mode	---
Standard Deviation	6.2E-07
Variance	3.9E-13
Skewness	1.52
Kurtosis	7.35
Coeff. of Variability	0.5220
Minimum	1.5E-07
Maximum	8.0E-06
Range Width	7.9E-06
Mean Std. Error	6.2E-09

Forecast: Large Fire Threatens TC/TAD (Diesel Present) (cont'd)

Cell: K205

Percentiles:

Forecast values

0%	1.5E-07
10%	5.5E-07
20%	6.9E-07
30%	8.2E-07
40%	9.3E-07
50%	1.1E-06
60%	1.2E-06
70%	1.4E-06
80%	1.6E-06
90%	2.0E-06
100%	8.0E-06

Forecast: Large Fire Threatens TC/TAD (No Diesel)

Cell: K206

Summary:

Entire range is from 2.5E-06 to 1.3E-04
Base case is 1.7E-05
After 10,000 trials, the std. error of the mean is 9.9E-08

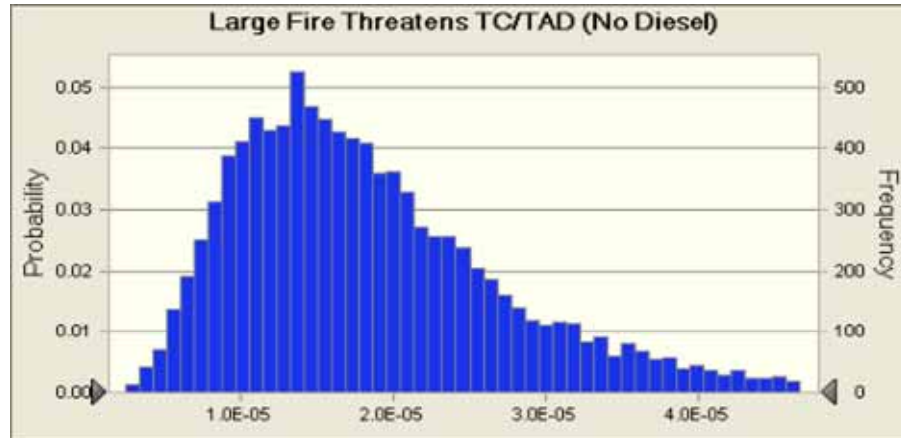

Statistics:

	Forecast values
Trials	10,000
Mean	1.9E-05
Median	1.7E-05
Mode	---
Standard Deviation	9.9E-06
Variance	9.8E-11
Skewness	1.52
Kurtosis	7.35
Coeff. of Variability	0.5220
Minimum	2.5E-06
Maximum	1.3E-04
Range Width	1.2E-04
Mean Std. Error	9.9E-08

Forecast: Large Fire Threatens TC/TAD (No Diesel) (cont'd)

Cell: K206

Percentiles:

	Forecast values
0%	2.5E-06
10%	8.7E-06
20%	1.1E-05
30%	1.3E-05
40%	1.5E-05
50%	1.7E-05
60%	1.9E-05
70%	2.2E-05
80%	2.6E-05
90%	3.2E-05
100%	1.3E-04

Forecast: Localized Fire Threatens DOE-SNF in CTM in Transfer Room (per individual canister)

Cell: O196

Summary:

Entire range is from 1.2E-08 to 5.6E-07
Base case is 1.0E-07
After 10,000 trials, the std. error of the mean is 5.4E-10

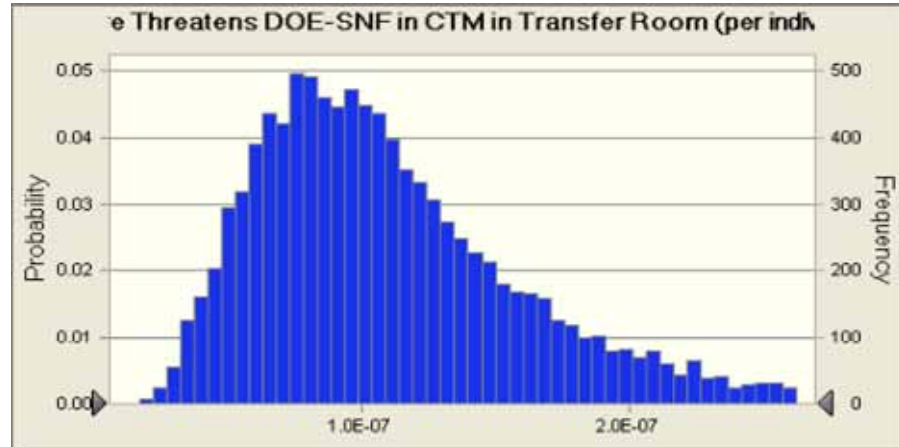

Statistics:

	Forecast values
Trials	10,000
Mean	1.1E-07
Median	1.0E-07
Mode	---
Standard Deviation	5.4E-08
Variance	2.9E-15
Skewness	1.33
Kurtosis	5.85
Coeff. of Variability	0.4813
Minimum	1.2E-08
Maximum	5.6E-07
Range Width	5.5E-07
Mean Std. Error	5.4E-10

Forecast: Localized Fire Threatens DOE-SNF in CTM in Transfer Room (per individual canister) (cont'd)

Cell: O196

Percentiles:

	Forecast values
0%	1.2E-08
10%	5.5E-08
20%	6.8E-08
30%	7.9E-08
40%	9.0E-08
50%	1.0E-07
60%	1.1E-07
70%	1.3E-07
80%	1.5E-07
90%	1.8E-07
100%	5.6E-07

Forecast: Localized Fire Threatens DPC (VTC) in AO in Unloading Room (Diesel Present) Cell: M99

Summary:

Entire range is from 1.1E-08 to 5.5E-07
Base case is 1.1E-07
After 10,000 trials, the std. error of the mean is 6.2E-10

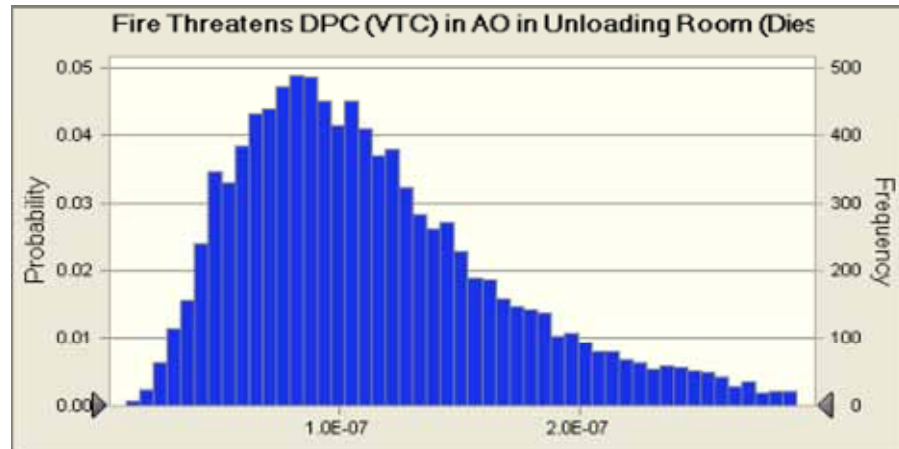

Statistics:

	Forecast values
Trials	10,000
Mean	1.2E-07
Median	1.0E-07
Mode	---
Standard Deviation	6.2E-08
Variance	3.8E-15
Skewness	1.41
Kurtosis	6.14
Coeff. of Variability	0.5290
Minimum	1.1E-08
Maximum	5.5E-07
Range Width	5.4E-07
Mean Std. Error	6.2E-10

Forecast: Localized Fire Threatens DPC (VTC) in AO in Unloading Room (Diesel Present) (cont'd) Cell: M99

Percentiles:

	Forecast values
0%	1.1E-08
10%	5.2E-08
20%	6.7E-08
30%	8.0E-08
40%	9.1E-08
50%	1.0E-07
60%	1.2E-07
70%	1.4E-07
80%	1.6E-07
90%	2.0E-07
100%	5.5E-07

Forecast: Localized Fire Threatens DPC (VTC) in AO in Vestibule/Preparation Area (Diesel Present) Cell: M160

Summary:

Entire range is from 7.0E-07 to 2.2E-05
Base case is 3.8E-06
After 10,000 trials, the std. error of the mean is 2.0E-08

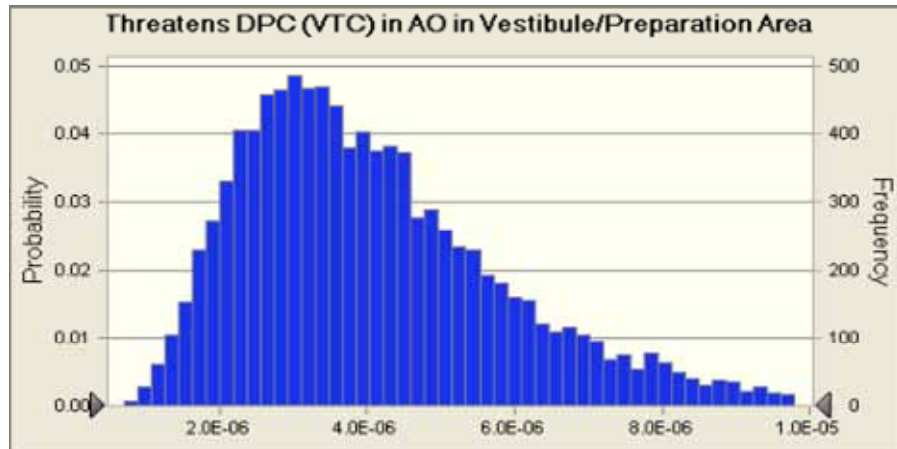

Statistics:

	Forecast values
Trials	10,000
Mean	4.2E-06
Median	3.8E-06
Mode	4.4E-06
Standard Deviation	2.0E-06
Variance	4.0E-12
Skewness	1.43
Kurtosis	6.57
Coeff. of Variability	0.4789
Minimum	7.0E-07
Maximum	2.2E-05
Range Width	2.1E-05
Mean Std. Error	2.0E-08

Forecast: Localized Fire Threatens DPC (VTC) in AO in Vestibule/Preparation Area (Diesel Present) (cont'd) Cell: M160

Percentiles:

	Forecast values
0%	7.0E-07
10%	2.1E-06
20%	2.6E-06
30%	3.0E-06
40%	3.4E-06
50%	3.8E-06
60%	4.3E-06
70%	4.8E-06
80%	5.5E-06
90%	6.8E-06
100%	2.2E-05

Forecast: Localized Fire Threatens DPC (VTC) in CTM in Transfer Room

Cell: Q197

Summary:

Entire range is from 1.3E-08 to 6.2E-07
Base case is 1.1E-07
After 10,000 trials, the std. error of the mean is 5.9E-10

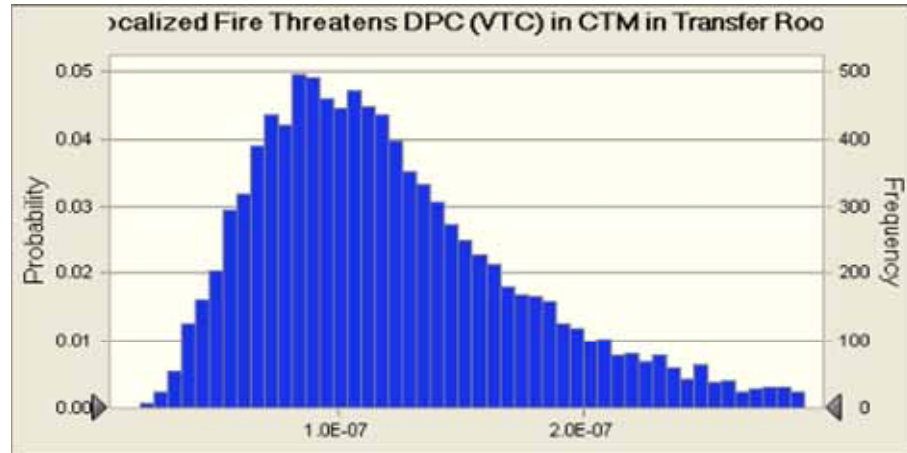

Statistics:

	Forecast values
Trials	10,000
Mean	1.2E-07
Median	1.1E-07
Mode	---
Standard Deviation	5.9E-08
Variance	3.5E-15
Skewness	1.33
Kurtosis	5.85
Coeff. of Variability	0.4813
Minimum	1.3E-08
Maximum	6.2E-07
Range Width	6.1E-07
Mean Std. Error	5.9E-10

Forecast: Localized Fire Threatens DPC (VTC) in CTM in Transfer Room (cont'd)

Cell: Q197

Percentiles:

	Forecast values
0%	1.3E-08
10%	6.1E-08
20%	7.5E-08
30%	8.7E-08
40%	9.9E-08
50%	1.1E-07
60%	1.2E-07
70%	1.4E-07
80%	1.6E-07
90%	2.0E-07
100%	6.2E-07

Forecast: Localized Fire Threatens HLW and DOE-SNF in WP in Loadout Room Cell: M59

Summary:

Entire range is from 8.5E-08 to 3.9E-06
Base case is 6.6E-07
After 10,000 trials, the std. error of the mean is 3.5E-09

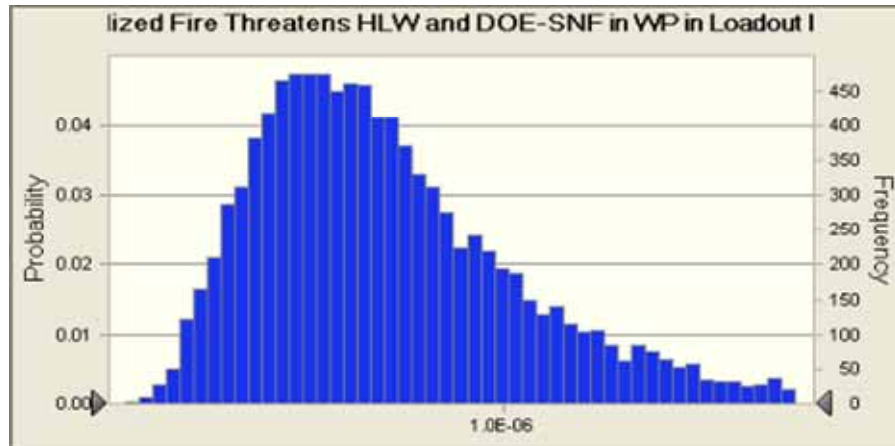

Statistics:	Forecast values
Trials	10,000
Mean	7.3E-07
Median	6.6E-07
Mode	---
Standard Deviation	3.5E-07
Variance	1.2E-13
Skewness	1.34
Kurtosis	6.03
Coeff. of Variability	0.4743
Minimum	8.5E-08
Maximum	3.9E-06
Range Width	3.8E-06
Mean Std. Error	3.5E-09

**Forecast: Localized Fire Threatens HLW and DOE-SNF in WP in Loadout Room Cell: M59
(cont'd)**

Percentiles:	Forecast values
0%	8.5E-08
10%	3.7E-07
20%	4.5E-07
30%	5.2E-07
40%	5.9E-07
50%	6.6E-07
60%	7.4E-07
70%	8.4E-07
80%	9.8E-07
90%	1.2E-06
100%	3.9E-06

Forecast: Localized Fire Threatens HLW and DOE-SNF in WP in Positioning/Closure Room

Cell: O31

Summary:

Entire range is from 8.3E-06 to 3.1E-04
Base case is 6.0E-05
After 10,000 trials, the std. error of the mean is 3.1E-07

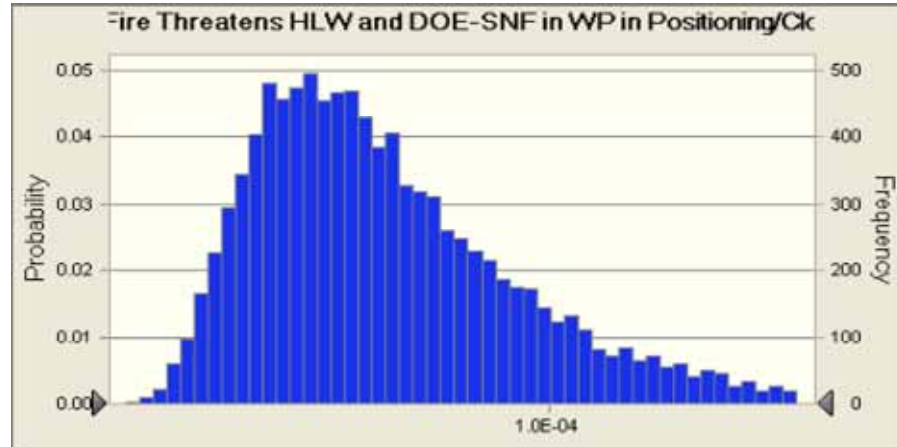

Statistics:

	Forecast values
Trials	10,000
Mean	6.6E-05
Median	5.9E-05
Mode	9.4E-05
Standard Deviation	3.1E-05
Variance	9.8E-10
Skewness	1.36
Kurtosis	5.90
Coeff. of Variability	0.4755
Minimum	8.3E-06
Maximum	3.1E-04
Range Width	3.0E-04
Mean Std. Error	3.1E-07

Forecast: Localized Fire Threatens HLW and DOE-SNF in WP in Positioning/Closure Room (cont'd)

Cell: O31

Percentiles:

	Forecast values
0%	8.3E-06
10%	3.3E-05
20%	4.0E-05
30%	4.7E-05
40%	5.3E-05
50%	5.9E-05
60%	6.7E-05
70%	7.6E-05
80%	8.8E-05
90%	1.1E-04
100%	3.1E-04

Forecast: Localized Fire Threatens HLW and DOE-SNF in WP in TEV in Loadout Room Cell: M45

Summary:

Entire range is from 2.6E-08 to 1.0E-06
Base case is 1.7E-07
After 10,000 trials, the std. error of the mean is 8.9E-10

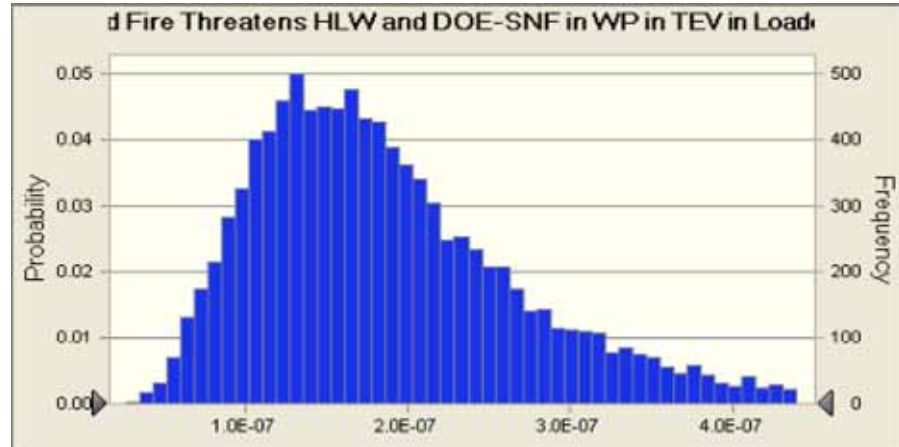

Statistics:

	Forecast values
Trials	10,000
Mean	1.9E-07
Median	1.7E-07
Mode	---
Standard Deviation	8.9E-08
Variance	7.9E-15
Skewness	1.32
Kurtosis	5.97
Coeff. of Variability	0.4679
Minimum	2.6E-08
Maximum	1.0E-06
Range Width	9.8E-07
Mean Std. Error	8.9E-10

Forecast: Localized Fire Threatens HLW and DOE-SNF in WP in TEV in Loadout Room (cont'd) Cell: M45

Percentiles:

	Forecast values
0%	2.6E-08
10%	9.6E-08
20%	1.2E-07
30%	1.4E-07
40%	1.5E-07
50%	1.7E-07
60%	1.9E-07
70%	2.2E-07
80%	2.5E-07
90%	3.1E-07
100%	1.0E-06

Forecast: Localized Fire Threatens HLW in CTM in Transfer Room (per individual canister) Cell: M195

Summary:

Entire range is from 1.4E-08 to 6.6E-07
Base case is 1.2E-07
After 10,000 trials, the std. error of the mean is 6.3E-10

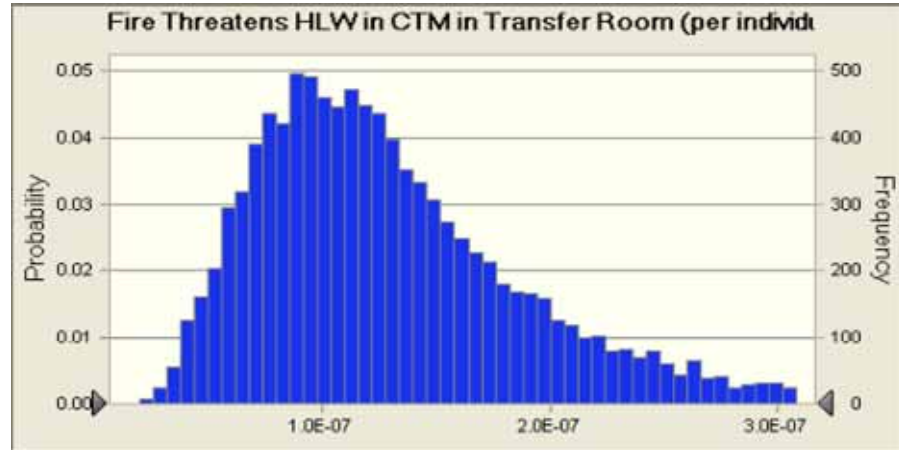

Statistics:

	Forecast values
Trials	10,000
Mean	1.3E-07
Median	1.2E-07
Mode	---
Standard Deviation	6.3E-08
Variance	4.0E-15
Skewness	1.33
Kurtosis	5.85
Coeff. of Variability	0.4813
Minimum	1.4E-08
Maximum	6.6E-07
Range Width	6.5E-07
Mean Std. Error	6.3E-10

Forecast: Localized Fire Threatens HLW in CTM in Transfer Room (per individual canister) (cont'd) Cell: M195

Percentiles:

	Forecast values
0%	1.4E-08
10%	6.4E-08
20%	8.0E-08
30%	9.3E-08
40%	1.1E-07
50%	1.2E-07
60%	1.3E-07
70%	1.5E-07
80%	1.7E-07
90%	2.2E-07
100%	6.6E-07

Forecast: Localized Fire Threatens HLW in WP in Positioning/Closure Room

Cell: M30

Summary:

Entire range is from 1.1E-06 to 4.0E-05
Base case is 7.7E-06
After 10,000 trials, the std. error of the mean is 4.0E-08

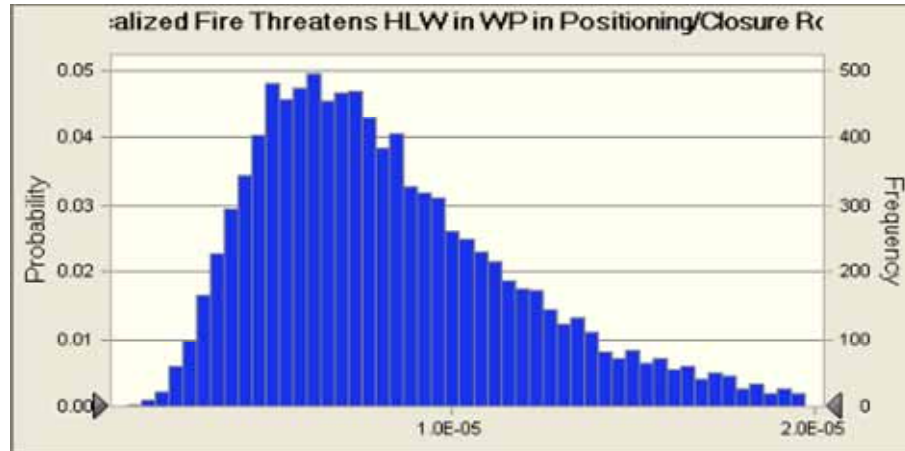

Statistics:

	Forecast values
Trials	10,000
Mean	8.5E-06
Median	7.6E-06
Mode	1.2E-05
Standard Deviation	4.0E-06
Variance	1.6E-11
Skewness	1.36
Kurtosis	5.90
Coeff. of Variability	0.4755
Minimum	1.1E-06
Maximum	4.0E-05
Range Width	3.9E-05
Mean Std. Error	4.0E-08

Forecast: Localized Fire Threatens HLW in WP in Positioning/Closure Room (cont'd)

Cell: M30

Percentiles:

	Forecast values
0%	1.1E-06
10%	4.3E-06
20%	5.2E-06
30%	6.0E-06
40%	6.8E-06
50%	7.6E-06
60%	8.5E-06
70%	9.7E-06
80%	1.1E-05
90%	1.4E-05
100%	4.0E-05

Forecast: Localized Fire Threatens TAD in AO in Unloading Room (Diesel Present) Cell: K98

Summary:

Entire range is from 1.2E-08 to 5.9E-07
 Base case is 1.1E-07
 After 10,000 trials, the std. error of the mean is 6.6E-10

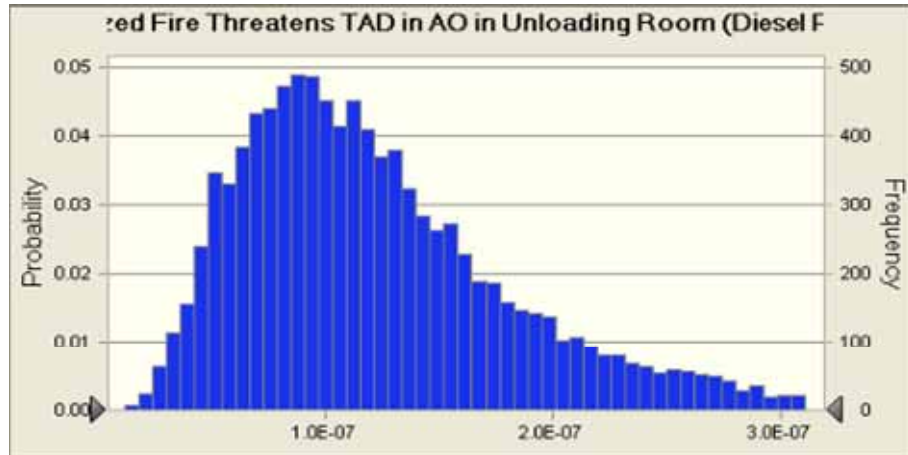

Statistics:

	Forecast values
Trials	10,000
Mean	1.3E-07
Median	1.1E-07
Mode	—
Standard Deviation	6.6E-08
Variance	4.4E-15
Skewness	1.41
Kurtosis	6.14
Coeff. of Variability	0.5290
Minimum	1.2E-08
Maximum	5.9E-07
Range Width	5.8E-07
Mean Std. Error	6.6E-10

Forecast: Localized Fire Threatens TAD in AO in Unloading Room (Diesel Present) (Cell: K98)

Percentiles:

	Forecast values
0%	1.2E-08
10%	5.5E-08
20%	7.2E-08
30%	8.5E-08
40%	9.8E-08
50%	1.1E-07
60%	1.3E-07
70%	1.4E-07
80%	1.7E-07
90%	2.1E-07
100%	5.9E-07

**Forecast: Localized Fire Threatens TAD in AO in Vestibule/Preparation Area
(Diesel Present)**

Cell: K159

Summary:

Entire range is from 3.0E-07 to 1.8E-05
Base case is 2.6E-06
After 10,000 trials, the std. error of the mean is 1.4E-08

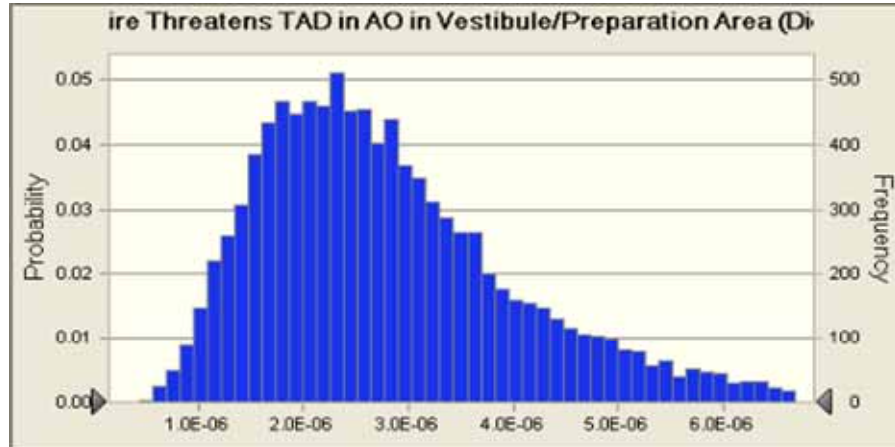

Statistics:

Forecast values

Trials	10,000
Mean	2.9E-06
Median	2.6E-06
Mode	---
Standard Deviation	1.4E-06
Variance	1.9E-12
Skewness	1.40
Kurtosis	6.76
Coeff. of Variability	0.4758
Minimum	3.0E-07
Maximum	1.8E-05
Range Width	1.7E-05
Mean Std. Error	1.4E-08

**Forecast: Localized Fire Threatens TAD in AO in Vestibule/Preparation Area
(Diesel Present) (cont'd)**

Cell: K159

Percentiles:

Forecast values

0%	3.0E-07
10%	1.4E-06
20%	1.8E-06
30%	2.0E-06
40%	2.3E-06
50%	2.6E-06
60%	2.9E-06
70%	3.3E-06
80%	3.8E-06
90%	4.7E-06
100%	1.8E-05

Forecast: Localized Fire Threatens TAD in CTM in Transfer Room

Cell: K194

Summary:

Entire range is from 1.2E-08 to 5.6E-07
Base case is 1.0E-07
After 10,000 trials, the std. error of the mean is 5.4E-10

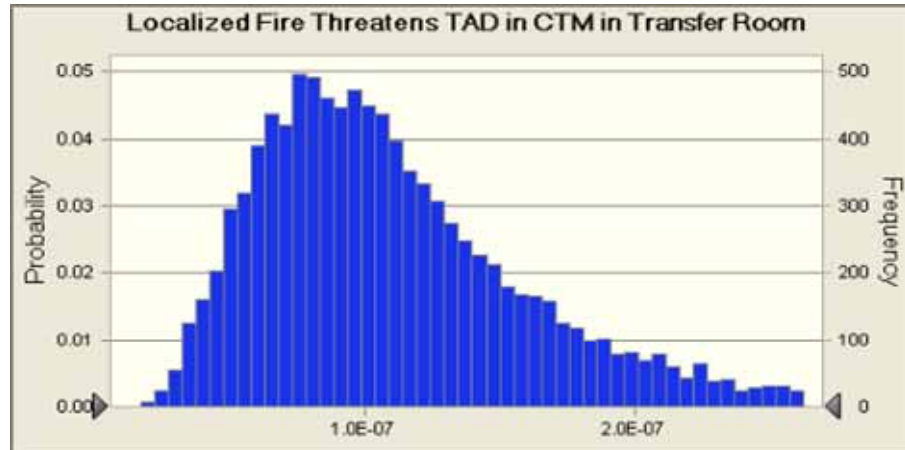

Statistics:

	Forecast values
Trials	10,000
Mean	1.1E-07
Median	1.0E-07
Mode	---
Standard Deviation	5.4E-08
Variance	2.9E-15
Skewness	1.33
Kurtosis	5.85
Coeff. of Variability	0.4813
Minimum	1.2E-08
Maximum	5.6E-07
Range Width	5.5E-07
Mean Std. Error	5.4E-10

Forecast: Localized Fire Threatens TAD in CTM in Transfer Room (cont'd)

Cell: K194

Percentiles:

	Forecast values
0%	1.2E-08
10%	5.5E-08
20%	6.8E-08
30%	7.9E-08
40%	9.0E-08
50%	1.0E-07
60%	1.1E-07
70%	1.3E-07
80%	1.5E-07
90%	1.8E-07
100%	5.6E-07

Forecast: Localized Fire Threatens TAD in WP in Loadout Room

Cell: K58

Summary:

Entire range is from 8.5E-08 to 3.9E-06
Base case is 6.6E-07
After 10,000 trials, the std. error of the mean is 3.5E-09

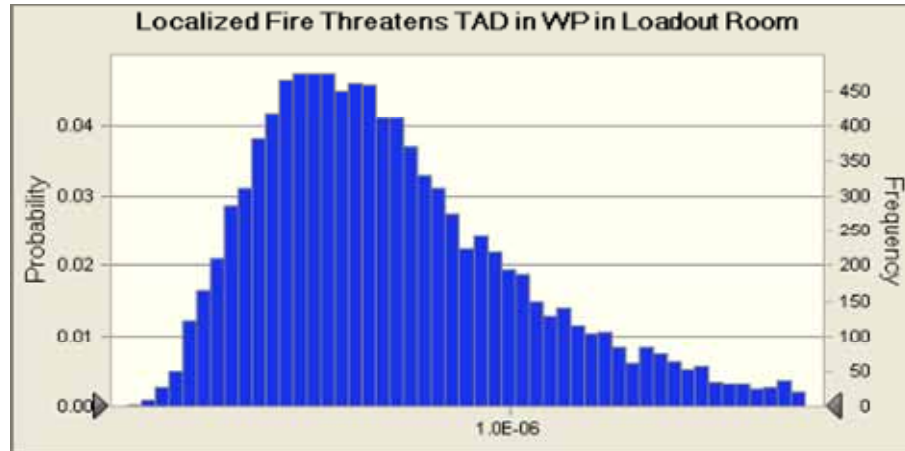

Statistics:

Forecast values

Trials	10,000
Mean	7.3E-07
Median	6.6E-07
Mode	---
Standard Deviation	3.5E-07
Variance	1.2E-13
Skewness	1.34
Kurtosis	6.03
Coeff. of Variability	0.4743
Minimum	8.5E-08
Maximum	3.9E-06
Range Width	3.8E-06
Mean Std. Error	3.5E-09

Forecast: Localized Fire Threatens TAD in WP in Loadout Room (cont'd)

Cell: K58

Percentiles:

Forecast values

0%	8.5E-08
10%	3.7E-07
20%	4.5E-07
30%	5.2E-07
40%	5.9E-07
50%	6.6E-07
60%	7.4E-07
70%	8.4E-07
80%	9.8E-07
90%	1.2E-06
100%	3.9E-06

Forecast: Localized Fire Threatens TAD in WP in Positioning/Closure Room

Cell: K29

Summary:

Entire range is from 8.12E-6 to 3.06E-4
Base case is 5.85E-5
After 10,000 trials, the std. error of the mean is 3.07E-7

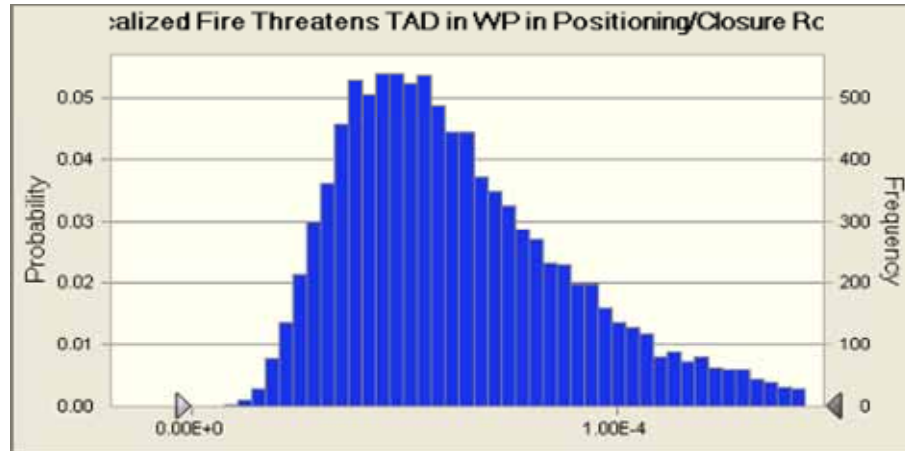

Statistics:

	Forecast values
Trials	10,000
Mean	6.5E-05
Median	5.8E-05
Mode	9.3E-05
Standard Deviation	3.1E-05
Variance	9.4E-10
Skewness	1.36
Kurtosis	5.90
Coeff. of Variability	0.4755
Minimum	8.1E-06
Maximum	3.1E-04
Range Width	3.0E-04
Mean Std. Error	3.1E-07

Forecast: Localized Fire Threatens TAD in WP in Positioning/Closure Room (cont'd) Cell: K29

Percentiles:

	Forecast values
0%	8.1E-06
10%	3.3E-05
20%	4.0E-05
30%	4.6E-05
40%	5.2E-05
50%	5.8E-05
60%	6.5E-05
70%	7.4E-05
80%	8.6E-05
90%	1.0E-04
100%	3.1E-04

Forecast: Localized Fire Threatens TAD/WP in TEV in Loadout Room

Cell: K44

Summary:

Entire range is from 2.6E-08 to 1.0E-06
Base case is 1.7E-07
After 10,000 trials, the std. error of the mean is 8.9E-10

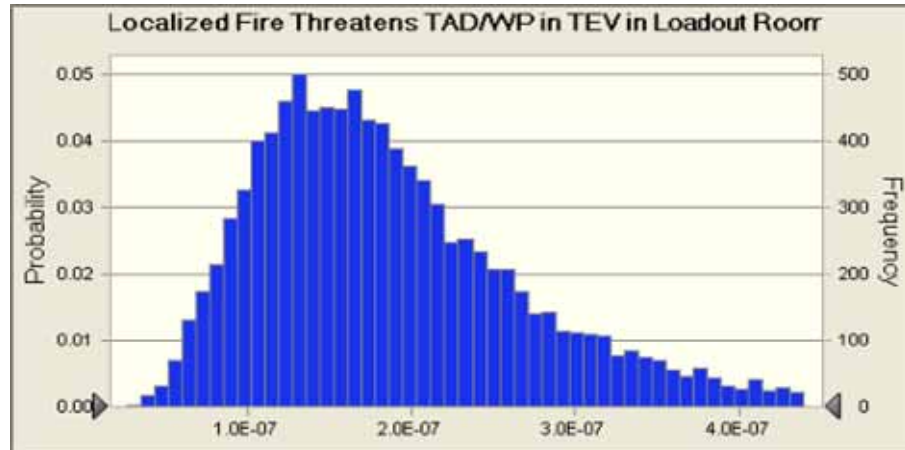

Statistics:

	Forecast values
Trials	10,000
Mean	1.9E-07
Median	1.7E-07
Mode	---
Standard Deviation	8.9E-08
Variance	7.9E-15
Skewness	1.32
Kurtosis	5.97
Coeff. of Variability	0.4679
Minimum	2.6E-08
Maximum	1.0E-06
Range Width	9.8E-07
Mean Std. Error	8.9E-10

Forecast: Localized Fire Threatens TAD/WP in TEV in Loadout Room (cont'd)

Cell: K44

Percentiles:

	Forecast values
0%	2.6E-08
10%	9.6E-08
20%	1.2E-07
30%	1.4E-07
40%	1.5E-07
50%	1.7E-07
60%	1.9E-07
70%	2.2E-07
80%	2.5E-07
90%	3.1E-07
100%	1.0E-06

Forecast: Localized Fire Threatens TC/DOE-SNF in Preparation Area w/o SPM (No Diesel Present) Cell: O140

Summary:

Entire range is from 3.1E-07 to 1.1E-05
Base case is 2.0E-06
After 10,000 trials, the std. error of the mean is 1.0E-08

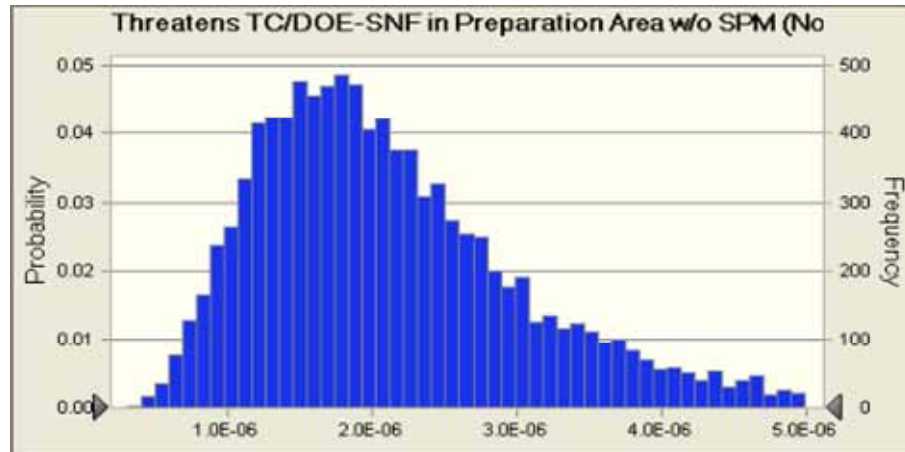

Statistics:	Forecast values
Trials	10,000
Mean	2.2E-06
Median	2.0E-06
Mode	---
Standard Deviation	1.0E-06
Variance	1.0E-12
Skewness	1.32
Kurtosis	5.90
Coeff. of Variability	0.4671
Minimum	3.1E-07
Maximum	1.1E-05
Range Width	1.1E-05
Mean Std. Error	1.0E-08

Forecast: Localized Fire Threatens TC/DOE-SNF in Preparation Area w/o SPM (No Diesel Present) (cont'd) Cell: O140

Percentiles:	Forecast values
0%	3.1E-07
10%	1.1E-06
20%	1.3E-06
30%	1.5E-06
40%	1.8E-06
50%	2.0E-06
60%	2.2E-06
70%	2.5E-06
80%	2.9E-06
90%	3.5E-06
100%	1.1E-05

Forecast: Localized Fire Threatens TC/DOE-SNF in Vestibule/Preparation Area w/SPM (Diesel Present) Cell: O119

Summary:

Entire range is from 7.6E-08 to 2.6E-06
Base case is 4.4E-07
After 10,000 trials, the std. error of the mean is 2.5E-09

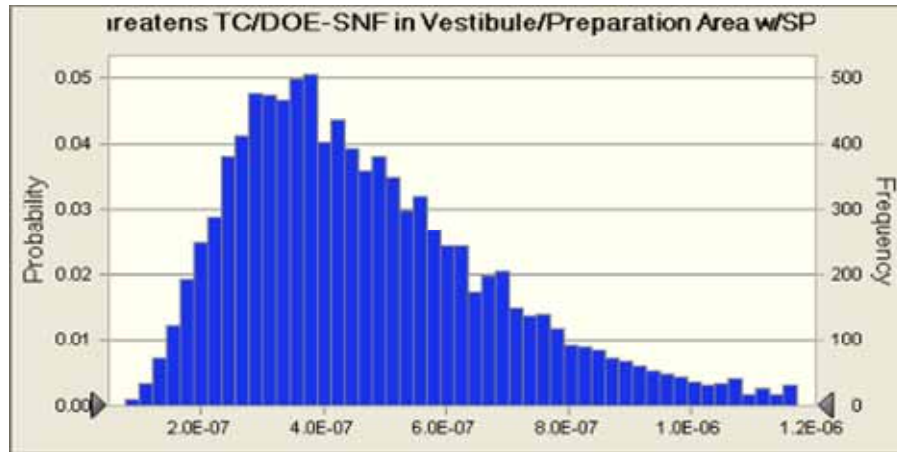

Statistics:

	Forecast values
Trials	10,000
Mean	4.9E-07
Median	4.3E-07
Mode	4.4E-07
Standard Deviation	2.5E-07
Variance	6.0E-14
Skewness	1.53
Kurtosis	7.15
Coeff. of Variability	0.5040
Minimum	7.6E-08
Maximum	2.6E-06
Range Width	2.5E-06
Mean Std. Error	2.5E-09

Forecast: Localized Fire Threatens TC/DOE-SNF in Vestibule/Preparation Area w/SPM (Diesel Present) (cont'd) Cell: O119

Percentiles:

	Forecast values
0%	7.6E-08
10%	2.4E-07
20%	2.9E-07
30%	3.4E-07
40%	3.8E-07
50%	4.3E-07
60%	4.9E-07
70%	5.6E-07
80%	6.5E-07
90%	8.0E-07
100%	2.6E-06

Forecast: Localized Fire Threatens TC/DOE-SNF on CTT in Preparation Area

Cell: O180

Summary:

Entire range is from 2.2E-07 to 1.7E-05
Base case is 2.2E-06
After 10,000 trials, the std. error of the mean is 1.2E-08

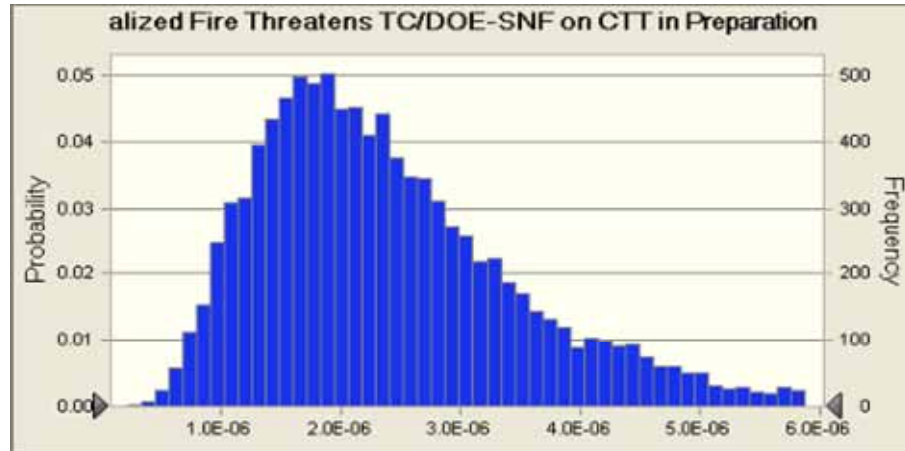

Statistics:

Forecast values

Trials	10,000
Mean	2.5E-06
Median	2.2E-06
Mode	---
Standard Deviation	1.2E-06
Variance	1.5E-12
Skewness	1.52
Kurtosis	7.80
Coeff. of Variability	0.4975
Minimum	2.2E-07
Maximum	1.7E-05
Range Width	1.7E-05
Mean Std. Error	1.2E-08

Forecast: Localized Fire Threatens TC/DOE-SNF on CTT in Preparation Area (cont'd)

Cell: O180

Percentiles:

Forecast values

0%	2.2E-07
10%	1.2E-06
20%	1.5E-06
30%	1.7E-06
40%	2.0E-06
50%	2.2E-06
60%	2.5E-06
70%	2.8E-06
80%	3.3E-06
90%	4.1E-06
100%	1.7E-05

Forecast: Localized Fire Threatens TC/DOE-SNF on CTT in Unloading Room

Cell: O79

Summary:

Entire range is from 7.2E-08 to 3.5E-06
Base case is 6.7E-07
After 10,000 trials, the std. error of the mean is 3.9E-09

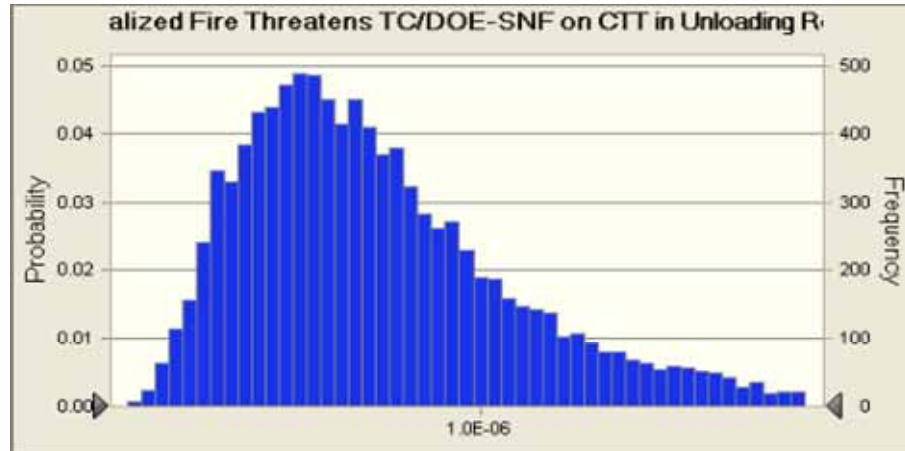

Statistics:

	Forecast values
Trials	10,000
Mean	7.5E-07
Median	6.7E-07
Mode	---
Standard Deviation	3.9E-07
Variance	1.6E-13
Skewness	1.41
Kurtosis	6.14
Coeff. of Variability	0.5290
Minimum	7.2E-08
Maximum	3.5E-06
Range Width	3.4E-06
Mean Std. Error	3.9E-09

Forecast: Localized Fire Threatens TC/DOE-SNF on CTT in Unloading Room (cont'd)

Cell: O79

Percentiles:

	Forecast values
0%	7.2E-08
10%	3.3E-07
20%	4.3E-07
30%	5.1E-07
40%	5.8E-07
50%	6.7E-07
60%	7.5E-07
70%	8.6E-07
80%	1.0E-06
90%	1.3E-06
100%	3.5E-06

Forecast: Localized Fire Threatens TC/DPC (VTC) in Cask Unloading Room

Cell: Q80

Summary:

Entire range is from 7.3E-09 to 3.8E-07
Base case is 5.8E-08
After 10,000 trials, the std. error of the mean is 3.4E-10

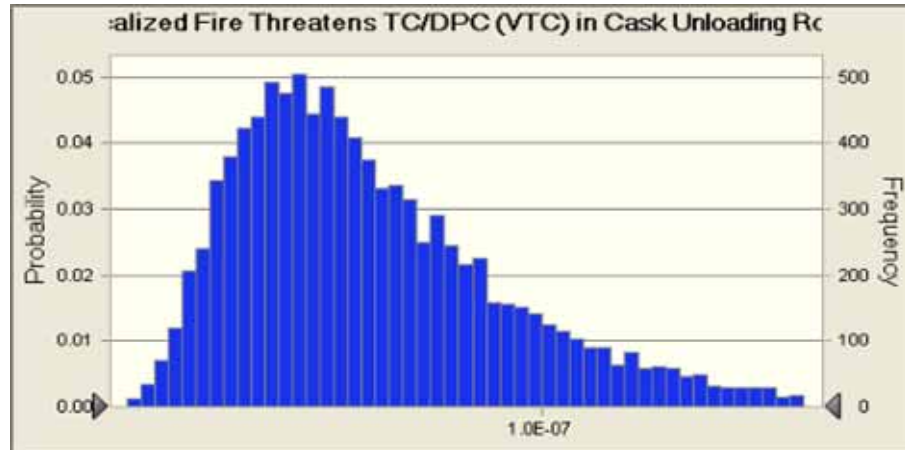

Statistics:

	Forecast values
Trials	10,000
Mean	6.4E-08
Median	5.6E-08
Mode	6.2E-08
Standard Deviation	3.4E-08
Variance	1.2E-15
Skewness	1.55
Kurtosis	7.28
Coeff. of Variability	0.5345
Minimum	7.3E-09
Maximum	3.8E-07
Range Width	3.7E-07
Mean Std. Error	3.4E-10

Forecast: Localized Fire Threatens TC/DPC (VTC) in Cask Unloading Room (cont'd)Cell: Q80

Percentiles:

	Forecast values
0%	7.3E-09
10%	2.9E-08
20%	3.6E-08
30%	4.3E-08
40%	4.9E-08
50%	5.6E-08
60%	6.4E-08
70%	7.4E-08
80%	8.6E-08
90%	1.1E-07
100%	3.8E-07

Forecast: Localized Fire Threatens TC/DPC (VTC) in Preparation Area

Cell: Q181

Summary:

Entire range is from 2.2E-07 to 1.7E-05
Base case is 2.2E-06
After 10,000 trials, the std. error of the mean is 1.2E-08

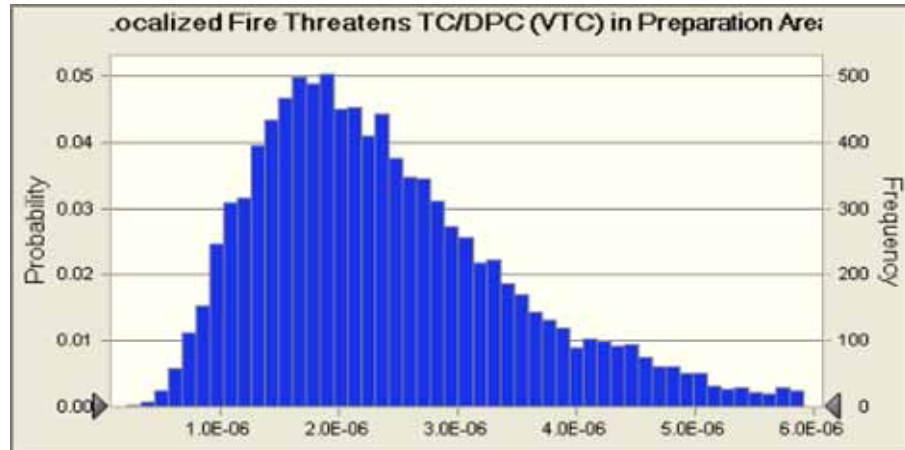

Statistics:

	Forecast values
Trials	10,000
Mean	2.5E-06
Median	2.2E-06
Mode	---
Standard Deviation	1.2E-06
Variance	1.5E-12
Skewness	1.52
Kurtosis	7.80
Coeff. of Variability	0.4975
Minimum	2.2E-07
Maximum	1.7E-05
Range Width	1.7E-05
Mean Std. Error	1.2E-08

Forecast: Localized Fire Threatens TC/DPC (VTC) in Preparation Area (cont'd)

Cell: Q181

Percentiles:

	Forecast values
0%	2.2E-07
10%	1.2E-06
20%	1.5E-06
30%	1.7E-06
40%	2.0E-06
50%	2.2E-06
60%	2.5E-06
70%	2.8E-06
80%	3.3E-06
90%	4.1E-06
100%	1.7E-05

Forecast: Localized Fire Threatens TC/DPC (VTC) in Preparation Area (No Diesel Cell: Q141 Present)

Summary:

Entire range is from 2.7E-07 to 9.8E-06
 Base case is 1.7E-06
 After 10,000 trials, the std. error of the mean is 8.8E-09

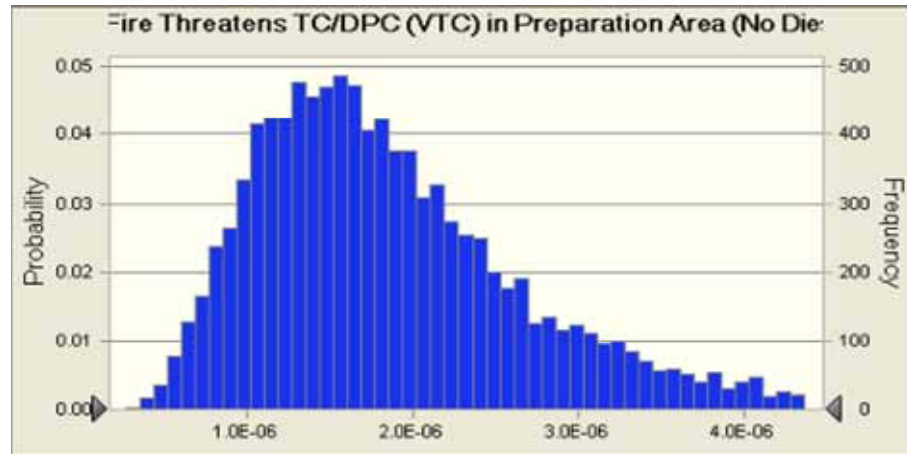

Statistics:

Forecast values

Trials	10,000
Mean	1.9E-06
Median	1.7E-06
Mode	---
Standard Deviation	8.8E-07
Variance	7.8E-13
Skewness	1.32
Kurtosis	5.90
Coeff. of Variability	0.4671
Minimum	2.7E-07
Maximum	9.8E-06
Range Width	9.6E-06
Mean Std. Error	8.8E-09

Forecast: Localized Fire Threatens TC/DPC (VTC) in Preparation Area (No Diesel Cell: Q141 Present) (cont'd)

Percentiles:

Forecast values

0%	2.7E-07
10%	9.6E-07
20%	1.2E-06
30%	1.4E-06
40%	1.5E-06
50%	1.7E-06
60%	1.9E-06
70%	2.2E-06
80%	2.5E-06
90%	3.1E-06
100%	9.8E-06

Forecast: Localized Fire Threatens TC/DPC (VTC) in Vestibule/Preparation Area Cell: Q120 (Diesel Present)

Summary:

Entire range is from 7.6E-08 to 2.6E-06
Base case is 4.4E-07
After 10,000 trials, the std. error of the mean is 2.5E-09

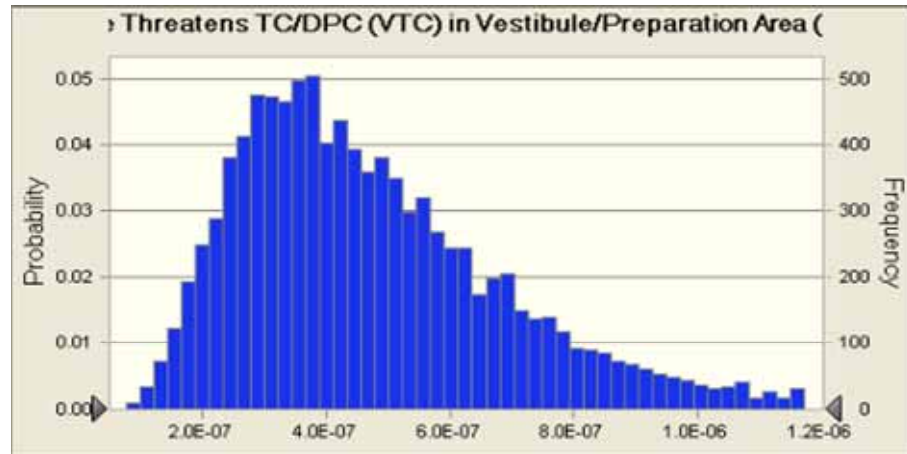

Statistics:	Forecast values
Trials	10,000
Mean	4.9E-07
Median	4.3E-07
Mode	4.4E-07
Standard Deviation	2.5E-07
Variance	6.0E-14
Skewness	1.53
Kurtosis	7.15
Coeff. of Variability	0.5040
Minimum	7.6E-08
Maximum	2.6E-06
Range Width	2.5E-06
Mean Std. Error	2.5E-09

Forecast: Localized Fire Threatens TC/DPC (VTC) in Vestibule/Preparation Area Cell: Q120 (Diesel Present) (cont'd)

Percentiles:	Forecast values
0%	7.6E-08
10%	2.4E-07
20%	2.9E-07
30%	3.4E-07
40%	3.8E-07
50%	4.3E-07
60%	4.9E-07
70%	5.6E-07
80%	6.5E-07
90%	8.0E-07
100%	2.6E-06

Forecast: Localized Fire Threatens TC/HLW in Preparation Area w/o SPM (No Diesel Present) Cell: M139

Summary:

Entire range is from 3.6E-07 to 1.3E-05
 Base case is 2.3E-06
 After 10,000 trials, the std. error of the mean is 1.2E-08

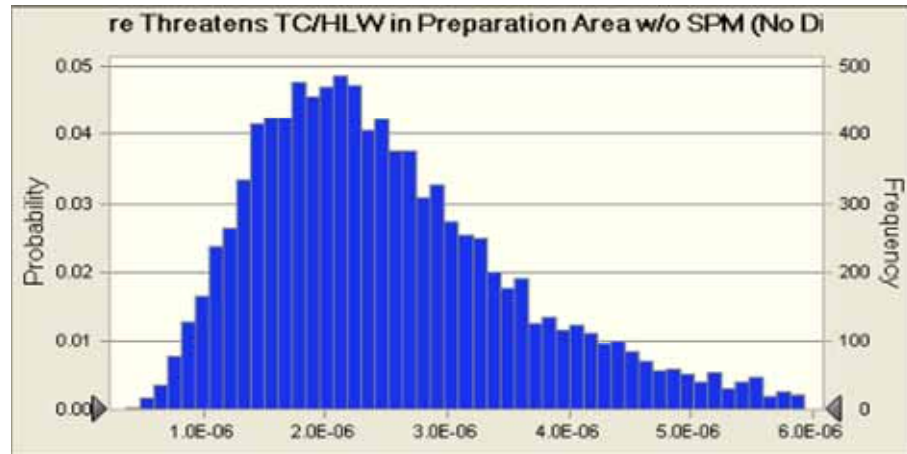

Statistics:	Forecast values
Trials	10,000
Mean	2.6E-06
Median	2.3E-06
Mode	---
Standard Deviation	1.2E-06
Variance	1.4E-12
Skewness	1.32
Kurtosis	5.90
Coeff. of Variability	0.4671
Minimum	3.6E-07
Maximum	1.3E-05
Range Width	1.3E-05
Mean Std. Error	1.2E-08

Forecast: Localized Fire Threatens TC/HLW in Preparation Area w/o SPM (No Diesel Present) (cont'd) Cell: M139

Percentiles:	Forecast values
0%	3.6E-07
10%	1.3E-06
20%	1.6E-06
30%	1.8E-06
40%	2.1E-06
50%	2.3E-06
60%	2.6E-06
70%	2.9E-06
80%	3.4E-06
90%	4.2E-06
100%	1.3E-05

Forecast: Localized Fire Threatens TC/HLW in Vestibule/Preparation Area w/SPM Cell: M118 (Diesel Present)

Summary:

Entire range is from 7.6E-08 to 2.6E-06
Base case is 4.4E-07
After 10,000 trials, the std. error of the mean is 2.5E-09

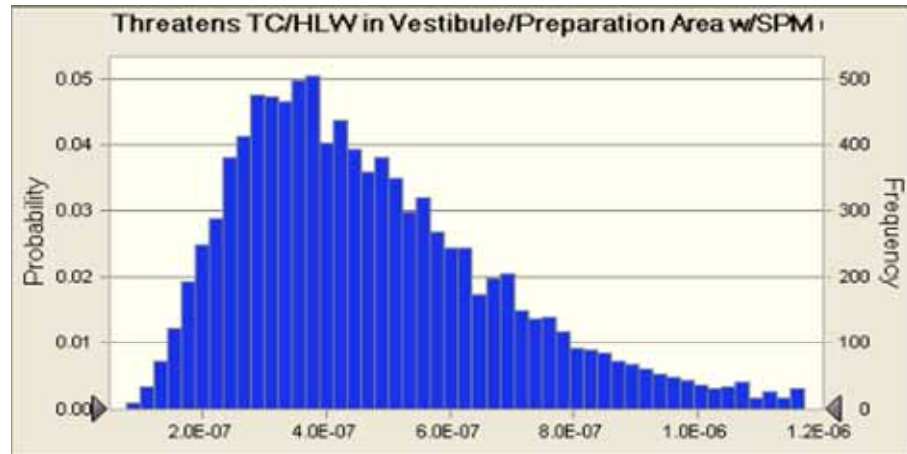

Statistics:	Forecast values
Trials	10,000
Mean	4.9E-07
Median	4.3E-07
Mode	4.4E-07
Standard Deviation	2.5E-07
Variance	6.0E-14
Skewness	1.53
Kurtosis	7.15
Coeff. of Variability	0.5040
Minimum	7.6E-08
Maximum	2.6E-06
Range Width	2.5E-06
Mean Std. Error	2.5E-09

Forecast: Localized Fire Threatens TC/HLW in Vestibule/Preparation Area w/SPM Cell: M118 (Diesel Present) (cont'd)

Percentiles:	Forecast values
0%	7.6E-08
10%	2.4E-07
20%	2.9E-07
30%	3.4E-07
40%	3.8E-07
50%	4.3E-07
60%	4.9E-07
70%	5.6E-07
80%	6.5E-07
90%	8.0E-07
100%	2.6E-06

Forecast: Localized Fire Threatens TC/HLW on CTT in Preparation Area

Cell: M179

Summary:

Entire range is from 2.1E-07 to 1.6E-05
Base case is 2.1E-06
After 10,000 trials, the std. error of the mean is 1.2E-08

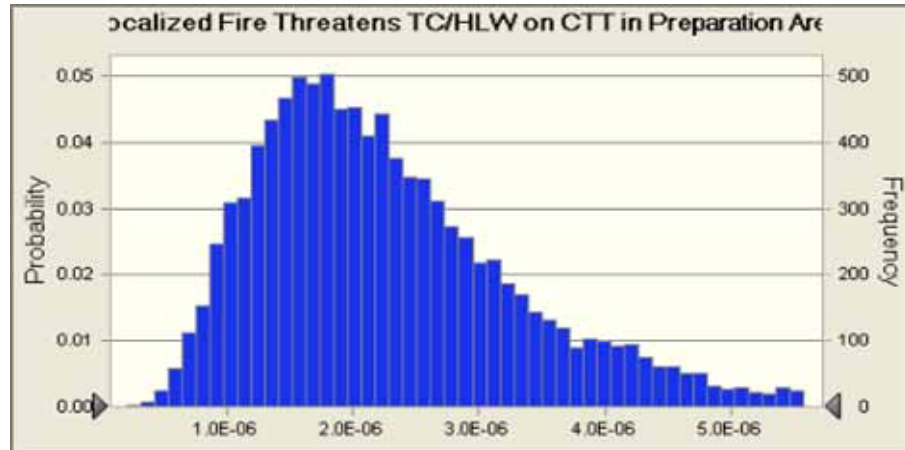

Statistics:

	Forecast values
Trials	10,000
Mean	2.3E-06
Median	2.1E-06
Mode	---
Standard Deviation	1.2E-06
Variance	1.3E-12
Skewness	1.52
Kurtosis	7.80
Coeff. of Variability	0.4975
Minimum	2.1E-07
Maximum	1.6E-05
Range Width	1.6E-05
Mean Std. Error	1.2E-08

Forecast: Localized Fire Threatens TC/HLW on CTT in Preparation Area (cont'd)

Cell: M179

Percentiles:

	Forecast values
0%	2.1E-07
10%	1.1E-06
20%	1.4E-06
30%	1.6E-06
40%	1.8E-06
50%	2.1E-06
60%	2.4E-06
70%	2.7E-06
80%	3.1E-06
90%	3.9E-06
100%	1.6E-05

Forecast: Localized Fire Threatens TC/HLW on CTT in Unloading Room

Cell: M78

Summary:

Entire range is from 4.5E-08 to 2.2E-06
Base case is 4.3E-07
After 10,000 trials, the std. error of the mean is 2.5E-09

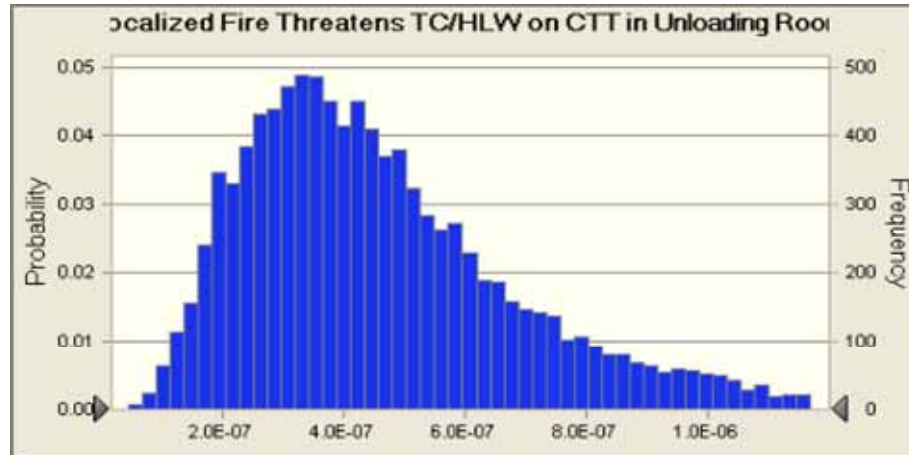

Statistics:

Forecast values

Trials	10,000
Mean	4.7E-07
Median	4.2E-07
Mode	—
Standard Deviation	2.5E-07
Variance	6.2E-14
Skewness	1.41
Kurtosis	6.14
Coeff. of Variability	0.5290
Minimum	4.5E-08
Maximum	2.2E-06
Range Width	2.2E-06
Mean Std. Error	2.5E-09

Forecast: Localized Fire Threatens TC/HLW on CTT in Unloading Room (cont'd)

Cell: M78

Percentiles:

Forecast values

0%	4.5E-08
10%	2.1E-07
20%	2.7E-07
30%	3.2E-07
40%	3.7E-07
50%	4.2E-07
60%	4.8E-07
70%	5.4E-07
80%	6.4E-07
90%	8.0E-07
100%	2.2E-06

Forecast: Localized Fire Threatens TC/TAD in Preparation Area w/o SPM (No Diesel Present)

Cell: K138

Summary:

Entire range is from 3.1E-07 to 1.1E-05
Base case is 2.0E-06
After 10,000 trials, the std. error of the mean is 1.0E-08

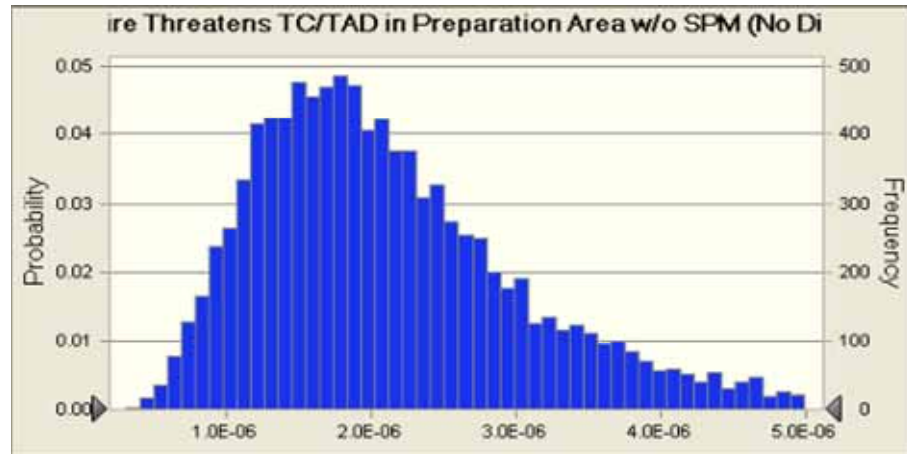

Statistics:

Forecast values

Trials	10,000
Mean	2.2E-06
Median	2.0E-06
Mode	---
Standard Deviation	1.0E-06
Variance	1.0E-12
Skewness	1.32
Kurtosis	5.90
Coeff. of Variability	0.4671
Minimum	3.1E-07
Maximum	1.1E-05
Range Width	1.1E-05
Mean Std. Error	1.0E-08

Forecast: Localized Fire Threatens TC/TAD in Preparation Area w/o SPM (No Diesel Present) (cont'd)

Cell: K138

Percentiles:

Forecast values

0%	3.1E-07
10%	1.1E-06
20%	1.3E-06
30%	1.5E-06
40%	1.8E-06
50%	2.0E-06
60%	2.2E-06
70%	2.5E-06
80%	2.9E-06
90%	3.5E-06
100%	1.1E-05

Forecast: Localized Fire Threatens TC/TAD in Vestibule/Preparation Area w/SPM Cell: K117 (Diesel Present)

Summary:

Entire range is from 4.7E-08 to 3.2E-06
Base case is 4.2E-07
After 10,000 trials, the std. error of the mean is 2.3E-09

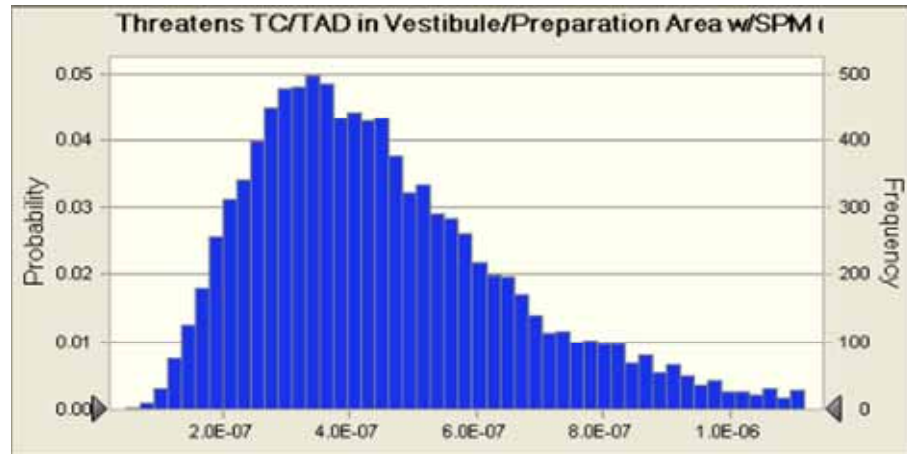

Statistics:	Forecast values
Trials	10,000
Mean	4.7E-07
Median	4.2E-07
Mode	---
Standard Deviation	2.3E-07
Variance	5.4E-14
Skewness	1.53
Kurtosis	7.78
Coeff. of Variability	0.5005
Minimum	4.7E-08
Maximum	3.2E-06
Range Width	3.1E-06
Mean Std. Error	2.3E-09

Forecast: Localized Fire Threatens TC/TAD in Vestibule/Preparation Area w/SPM Cell: K117 (Diesel Present) (cont'd)

Percentiles:	Forecast values
0%	4.7E-08
10%	2.2E-07
20%	2.8E-07
30%	3.2E-07
40%	3.7E-07
50%	4.2E-07
60%	4.7E-07
70%	5.3E-07
80%	6.2E-07
90%	7.7E-07
100%	3.2E-06

Forecast: Localized Fire Threatens TC/TAD on CTT in Preparation Area

Cell: K178

Summary:

Entire range is from 2.4E-07 to 1.8E-05
Base case is 2.3E-06
After 10,000 trials, the std. error of the mean is 1.3E-08

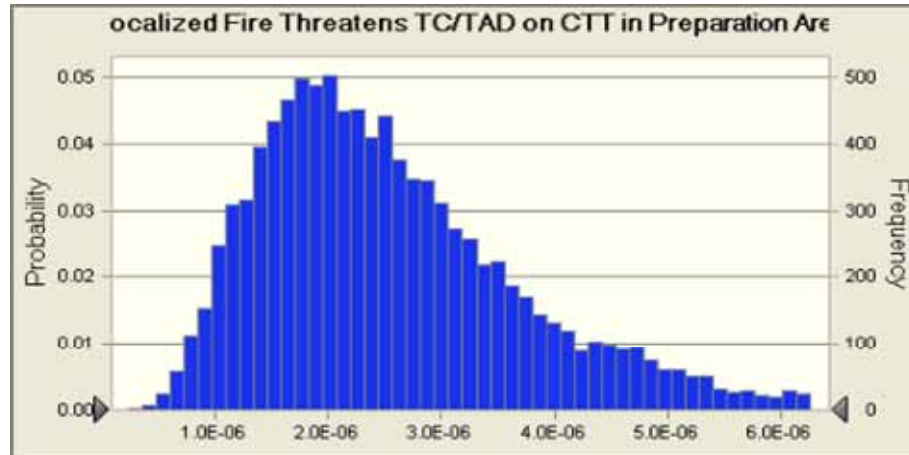

Statistics:

	Forecast values
Trials	10,000
Mean	2.6E-06
Median	2.4E-06
Mode	—
Standard Deviation	1.3E-06
Variance	1.7E-12
Skewness	1.52
Kurtosis	7.80
Coeff. of Variability	0.4975
Minimum	2.4E-07
Maximum	1.8E-05
Range Width	1.8E-05
Mean Std. Error	1.3E-08

Forecast: Localized Fire Threatens TC/TAD on CTT in Preparation Area (cont'd)

Cell: K178

Percentiles:

	Forecast values
0%	2.4E-07
10%	1.3E-06
20%	1.6E-06
30%	1.8E-06
40%	2.1E-06
50%	2.4E-06
60%	2.7E-06
70%	3.0E-06
80%	3.5E-06
90%	4.3E-06
100%	1.8E-05

Forecast: Localized Fire Threatens TC/TAD on CTT in Unloading Room

Cell: K77

Summary:

Entire range is from 1.1E-08 to 5.6E-07
Base case is 1.1E-07
After 10,000 trials, the std. error of the mean is 6.3E-10

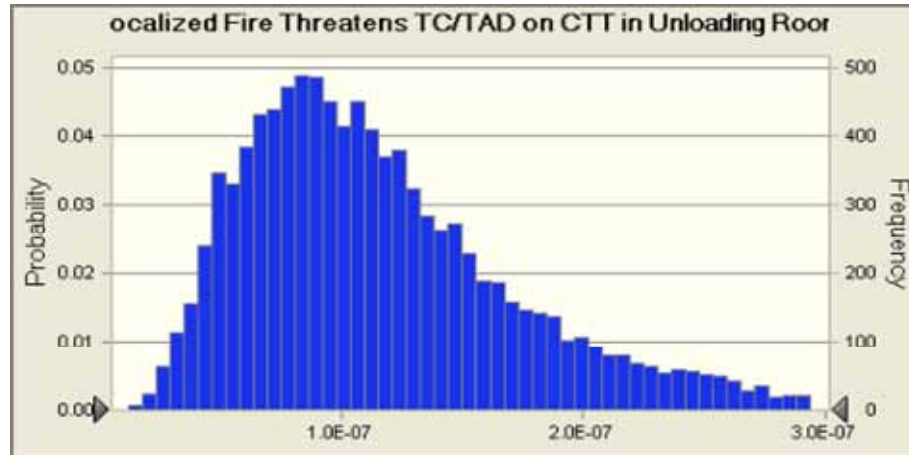

Statistics:

	Forecast values
Trials	10,000
Mean	1.2E-07
Median	1.1E-07
Mode	—
Standard Deviation	6.3E-08
Variance	3.9E-15
Skewness	1.41
Kurtosis	6.14
Coeff. of Variability	0.5290
Minimum	1.1E-08
Maximum	5.6E-07
Range Width	5.5E-07
Mean Std. Error	6.3E-10

Forecast: Localized Fire Threatens TC/TAD on CTT in Unloading Room (cont'd)

Cell: K77

Percentiles:

	Forecast values
0%	1.1E-08
10%	5.2E-08
20%	6.8E-08
30%	8.0E-08
40%	9.2E-08
50%	1.1E-07
60%	1.2E-07
70%	1.4E-07
80%	1.6E-07
90%	2.0E-07
100%	5.6E-07

End of Forecasts

Assumptions

Worksheet: [CRCF Fire Frequency - No Suppression.xls]Ignition Source Frequency

Assumption: Sampled Value

Cell: H2

Normal distribution with parameters:

Mean	0.086	(=I2)
97.5%	0.126	(=J2)

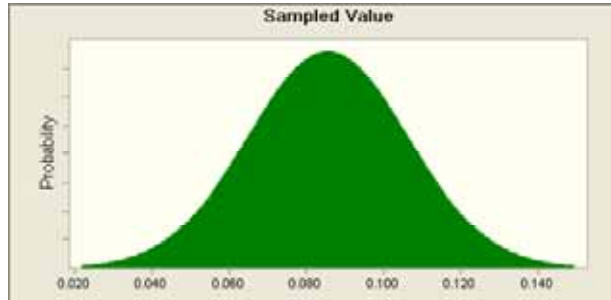

Assumption: Sampled Value (H10)

Cell: H10

Normal distribution with parameters:

Mean	0.134	(=I10)
97.5%	0.183	(=J10)

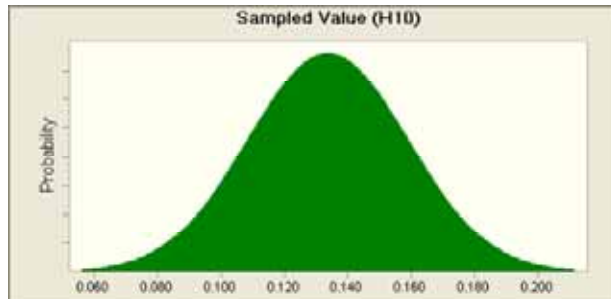

Assumption: Sampled Value (H3)

Cell: H3

Normal distribution with parameters:

Mean	0.080	(=I3)
97.5%	0.120	(=J3)

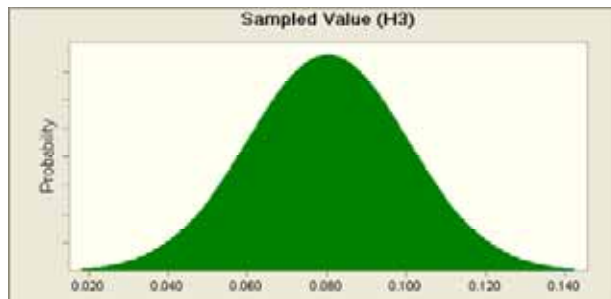

Assumption: Sampled Value (H4)

Cell: H4

Normal distribution with parameters:

Mean	0.139	(=I4)
97.5%	0.189	(=J4)

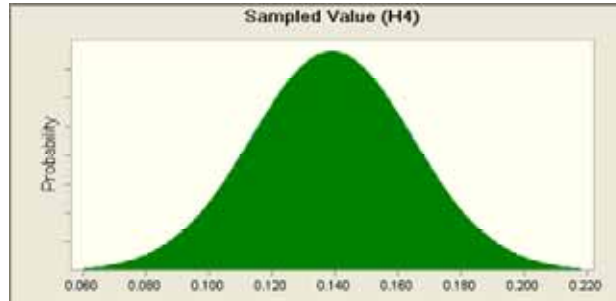

Assumption: Sampled Value (H5)

Cell: H5

Normal distribution with parameters:

Mean	0.155	(=I5)
97.5%	0.207	(=J5)

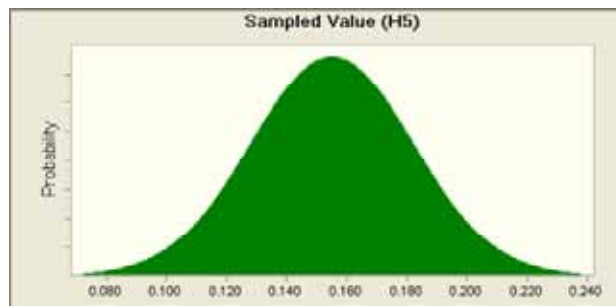

Assumption: Sampled Value (H6)

Cell: H6

Normal distribution with parameters:

Mean	0.219	(=I6)
97.5%	0.279	(=J6)

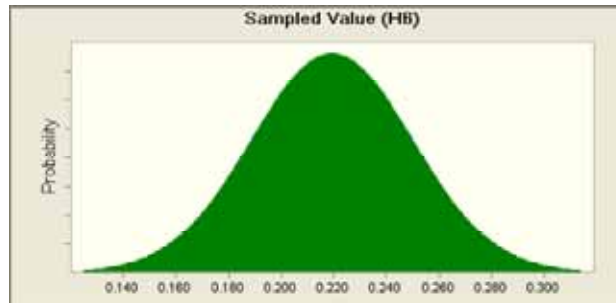

Assumption: Sampled Value (H7)

Cell: H7

Normal distribution with parameters:

Mean	0.021	(=I7)
97.5%	0.042	(=J7)

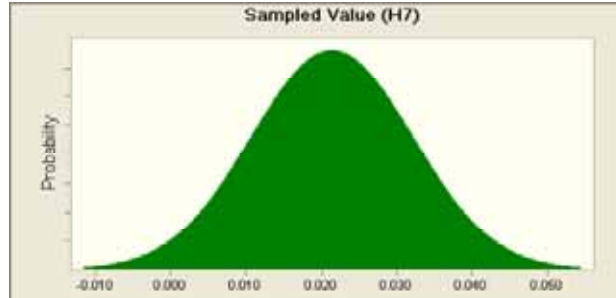

Assumption: Sampled Value (H8)

Cell: H8

Normal distribution with parameters:

Mean	0.064	(=I8)
97.5%	0.100	(=J8)

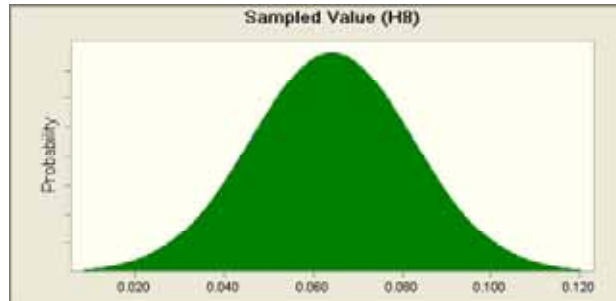

Assumption: Sampled Value (H9)

Cell: H9

Normal distribution with parameters:

Mean	0.102	(=I9)
97.5%	0.145	(=J9)

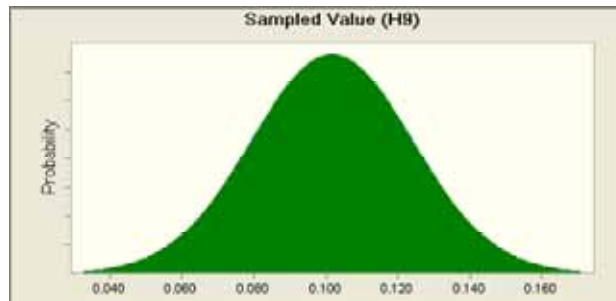

Worksheet: [CRCF Fire Frequency - No Suppression.xls]Propagation Probabilities

Assumption: F14

Cell: F14

Normal distribution with parameters:

Mean	0.621	(=G14)
97.5%	0.725	(=H14)

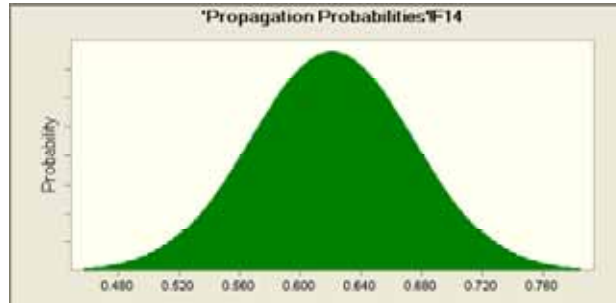

Assumption: F15

Cell: F15

Normal distribution with parameters:

Mean	0.149	(=G15)
97.5%	0.226	(=H15)

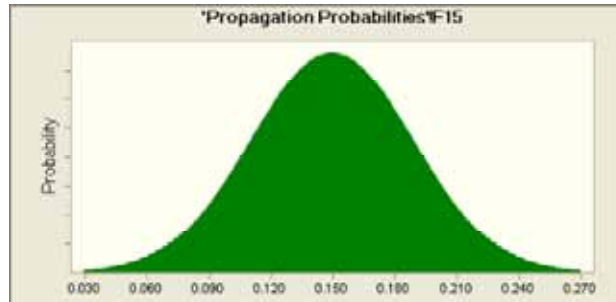

Assumption: F16

Cell: F16

Normal distribution with parameters:

Mean	0.004	(=G16)
97.5%	0.017	(=H16)

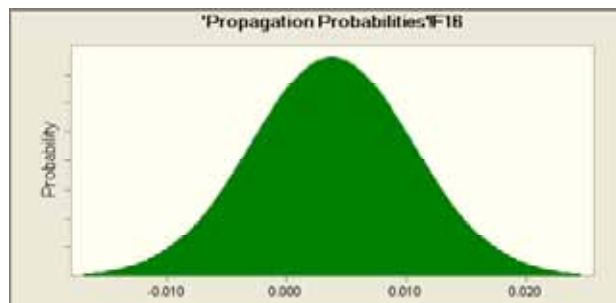

Assumption: F17

Cell: F17

Normal distribution with parameters:

Mean	0.057	(=G17)
97.5%	0.107	(=H17)

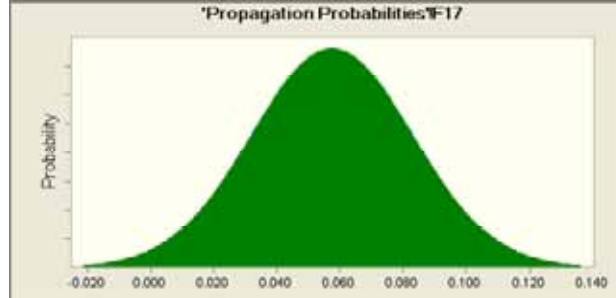

Assumption: F18

Cell: F18

Normal distribution with parameters:

Mean	0.004	(=G18)
97.5%	0.017	(=H18)

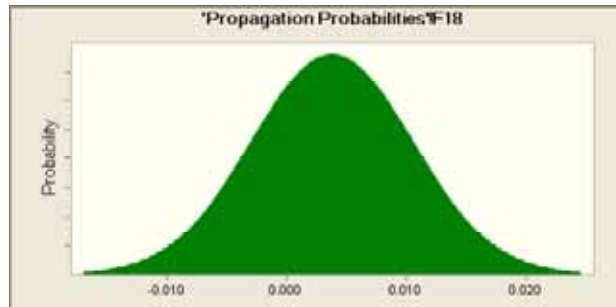

Assumption: F19

Cell: F19

Normal distribution with parameters:

Mean	0.161	(=G19)
97.5%	0.240	(=H19)

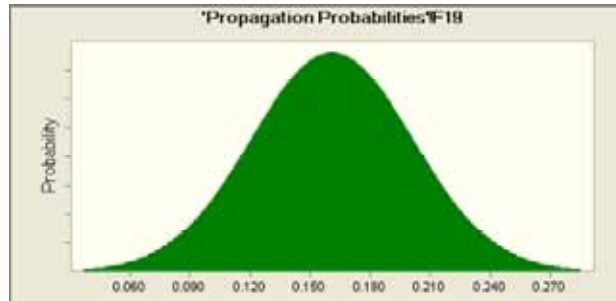

Assumption: F20

Cell: F20

Normal distribution with parameters:

Mean	0.004	(=G20)
97.5%	0.017	(=H20)

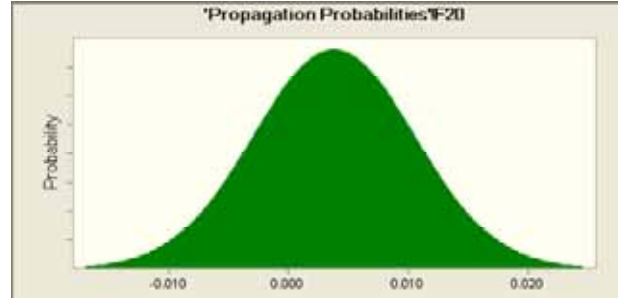

Cell: F20

Worksheet: [CRCF Fire Frequency - No Suppression.xls]Total Frequency

Assumption: F123

Cell: F123

Lognormal distribution with parameters:

50%	3.77E-6	(=G123)
97.5%	9.06E-6	(=I123)

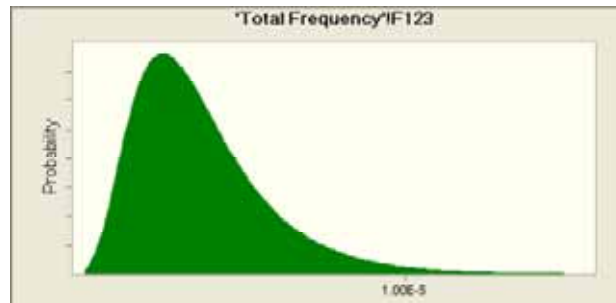

End of Assumptions

NOTE: AO = aging overpack; CTM = canister transfer machine; CTT = cask transfer trolley; DOE = U.S. Department of Energy; DPC = dual-purpose canister; HLW = high-level radioactive waste; SNF = spent nuclear fuel; TAD = transportation, aging, and disposal; TC = transportation cask; TEV = transport and emplacement vehicle; VTC = a transportation cask that is upended on a railcar; WP = waste package; WPTT = waste package transfer trolley.

Source: Crystal Ball software output.

ATTACHMENT G
EVENT SEQUENCE QUANTIFICATION SUMMARY TABLES

ATTACHMENT G

EVENT SEQUENCE QUANTIFICATION SUMMARY TABLES

Attachment G contains the event sequence quantification summary table (Table G-1) referenced by Section 6.7. It also contains Table G-2, *Final Event Sequences Summary*; Table G-3, *Beyond Category 2 Final Event Sequences Summary*; and Table G-4, *Important to Criticality Final Event Sequences Summary* that are referenced in Section 6.8. Blank cells in these tables indicate that the value is <E-12.

This attachment can be found on the CD in Attachment H, in a file named Attachment G.doc.

ATTACHMENT H
SAPPHIRE MODEL AND SUPPORTING FILES

ATTACHMENT H SAPHIRE MODEL AND SUPPORTING FILES

This attachment is the CD containing the SAPHIRE model and supporting files. The electronic files contained on the CD are identified below.

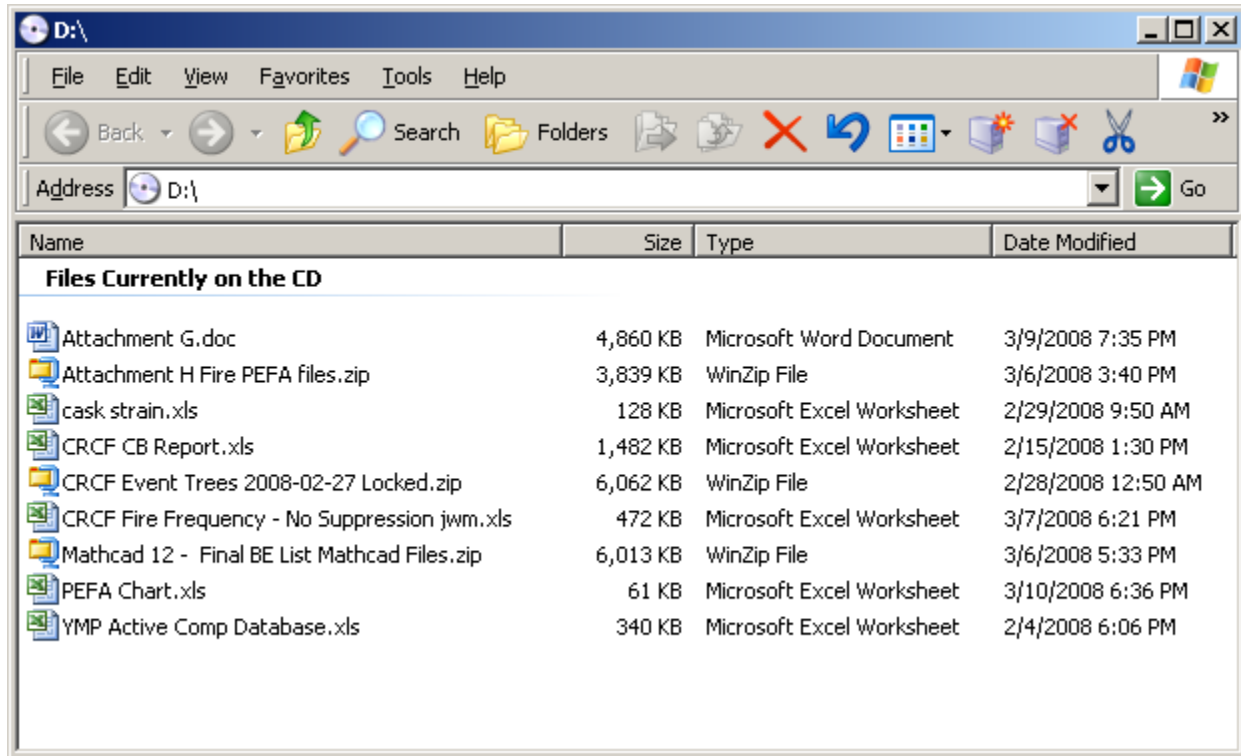

Name	Size	Type	Date Modified
Files Currently on the CD			
Attachment G.doc	4,860 KB	Microsoft Word Document	3/9/2008 7:35 PM
Attachment H Fire PEFA files.zip	3,839 KB	WinZip File	3/6/2008 3:40 PM
cask strain.xls	128 KB	Microsoft Excel Worksheet	2/29/2008 9:50 AM
CRCF CB Report.xls	1,482 KB	Microsoft Excel Worksheet	2/15/2008 1:30 PM
CRCF Event Trees 2008-02-27 Locked.zip	6,062 KB	WinZip File	2/28/2008 12:50 AM
CRCF Fire Frequency - No Suppression jwm.xls	472 KB	Microsoft Excel Worksheet	3/7/2008 6:21 PM
Mathcad 12 - Final BE List Mathcad Files.zip	6,013 KB	WinZip File	3/6/2008 5:33 PM
PEFA Chart.xls	61 KB	Microsoft Excel Worksheet	3/10/2008 6:36 PM
YMP Active Comp Database.xls	340 KB	Microsoft Excel Worksheet	2/4/2008 6:06 PM