

*Office of Civilian Radioactive Waste Management*

---

---



# ***Civilian Radioactive Waste Management System***

## ***Transportation, Aging and Disposal Canister System Performance Specification***

***Revision 1 / ICN 1***

DOC ID: WMO-TADCS-000001

---

---

***March 2008***

U.S. Department of Energy  
Office of Civilian Radioactive Waste Management

**PAGE INTENTIONALLY  
LEFT BLANK**

Preparer: M. P. 28 MAR 2008  
M. Popa Date

Approval: D. K. Z. 28 Mar 2008  
D. K. Zabransky Date  
Acting Director  
Waste Management Office

**REVISION HISTORY**

<b><u>Revision</u></b>	<b><u>Change</u></b>
A	Initial Issue
B	For requirement number (5) and (6) in Section 3.1.1 changed "... or less than 5 years out-of-reactor..." to "... <b>and no</b> less than 5 years out-of-reactor..."
0	Initial issue of Final TAD Performance Specification. Incorporated comments on the Preliminary TAD Performance Specification, Rev. B
1	Reword Sections 3.1.2(1) and 3.3.2(1). Revise Table 3.1-4 to set the pool water boron concentration to greater than or equal to 2500 ppm. Reword Sections 3.3.2(7), 3.3.6(1) and 3.3.6(2). Account for new seismic data in Attachment A. Updated Attachment E with the revised supplemental soils report and added the calculation/analysis change notice (Attachment F). Addressed CR 10743 in Section 2.5.  Modify Section 3.1.5(2) to change the minimum neutron absorber thickness from 0.433 in. to 0.4375 in.
REV 1 ICN 1	Changed the footnote on the cover page of Attachment E to reflect the change from CACN 001 to CACN 002



## **TABLE of CONTENTS**

<b>1.0</b>	<b>INTRODUCTION</b>	<b>1</b>
<b>1.1</b>	<b>Purpose</b>	<b>1</b>
<b>1.2</b>	<b>Transportation, Aging and Disposal (TAD) System Description</b>	<b>1</b>
1.2.1	TAD canister	1
1.2.2	Transportation Overpack	2
1.2.3	Transportation Skid	2
1.2.4	Ancillary Equipment	2
1.2.5	Shielded Transfer Cask	2
1.2.6	Aging Overpack	2
1.2.7	Site Transporter	2
1.2.8	Waste Package Overpack	3
1.2.9	Storage Overpack	3
<b>1.3</b>	<b>Definitions</b>	<b>3</b>
<b>1.4</b>	<b>Safety Classification of the Components</b>	<b>4</b>
<b>1.5</b>	<b>Limitations</b>	<b>4</b>
<b>2.0</b>	<b>APPLICABLE DOCUMENTS/REFERENCES</b>	<b>4</b>
<b>2.1</b>	<b>Regulations</b>	<b>4</b>
<b>2.2</b>	<b>DOE Documents</b>	<b>5</b>
<b>2.3</b>	<b>NRC Documents</b>	<b>5</b>
<b>2.4</b>	<b>Codes and Standards</b>	<b>6</b>
<b>2.5</b>	<b>Other References</b>	<b>7</b>
<b>3.0</b>	<b>PERFORMANCE REQUIREMENTS</b>	<b>8</b>
<b>3.1</b>	<b>TAD Canister</b>	<b>8</b>
3.1.1	General	8
3.1.2	Structural	10
3.1.3	Thermal	14
3.1.4	Dose and Shielding	15
3.1.5	Criticality	15
3.1.6	Containment	16
3.1.7	Operations	18
3.1.8	Materials	18
<b>3.2</b>	<b>Transportation Overpack</b>	<b>20</b>
3.2.1	General	20
3.2.2	Structural	20
3.2.3	Thermal	21
3.2.4	Dose and Shielding	21
3.2.5	Criticality	21
3.2.6	Containment	21
3.2.7	Operations	21
3.2.8	Materials	23
<b>3.3</b>	<b>Aging Overpack</b>	<b>23</b>
3.3.1	General	23
3.3.2	Structural	24
3.3.3	Thermal	26

3.3.4	Dose and Shielding	27
3.3.5	Criticality	27
3.3.6	Containment	27
3.3.7	Operations	28
3.3.8	Materials	28
<b>4.0</b>	<b>GLOSSARY</b>	<b>28</b>

Attachment A Seismic Data for Yucca Mountain Geologic Repository Operations Area

Attachment B Postclosure Criticality Loading Curves

Attachment C TAD Canister Lifting Feature

Attachment D Aging Overpack Details

Attachment E Supplemental Soils Report

Attachment F Supplemental Soils Report Calculation/Analysis Change Notice

## ACRONYMS

ALARA	as low as is reasonably achievable
BWR	boiling water reactor
CFR	Code of Federal Regulation
CSNF	commercial spent nuclear fuel
DCRA	disposal control rod assembly
DOE	U.S. Department of Energy
GROA	geologic repository operations area
HLW	high-level radioactive waste
HVAC	heating, ventilation and air-conditioning
ICRP	International Commission on Radiological Protection
ISFSI	independent spent fuel storage installation
ITS	important to safety
MTU	metric tons of uranium
NRC	U.S. Nuclear Regulatory Commission
NWPA	Nuclear Waste Policy Act
OCRWM	Office of Civilian Radioactive Waste Management
PWR	pressurized water reactor
SNF	spent nuclear fuel
SSC	structures, systems and components
STC	shielded transfer cask
TAD	transportation, aging and disposal
TEDE	total effective dose equivalent
TWPS	TAD waste package spacer
USL	upper subcritical limit
YMP	Yucca Mountain Project

**PAGE INTENTIONALLY  
LEFT BLANK**

## ABBREVIATIONS

° C	degrees Centigrade
° F	degrees Fahrenheit
BTU	International Table British thermal unit
BTU/hr-ft <sup>2</sup>	British thermal unit per hour-square foot
Bq	becquerel
cm	centimeter
cm <sup>2</sup>	square centimeter
dpm	disintegrations per minute
ft	feet
ft/s	feet per second
g	acceleration due to gravity
g/cm <sup>2</sup>	grams per square centimeter
GWd	gigawatt-day
h or hr	hour
in.	inches
$k_{eff}$	effective neutron multiplication factor
kg	kilogram
km	kilometer
km/hr	kilometer/hour
kPa	kilopascal
kW	kilowatt
kW/m <sup>2</sup>	kilowatt per square meter
lb	pound(s) (weight; unless otherwise specified)
lb/ft <sup>2</sup>	pounds per square foot
lb/in <sup>2</sup>	pounds per square inch
lb/in <sup>2</sup> /sec	pounds per square inch per second
m	meter
m/s	meter per second
m <sup>2</sup>	square meter(s)
mho	Conductance in mho being the reciprocal of resistance in ohms
mm	millimeter
MPa	megapascal
mph	miles per hour

mrem	milli roentgen equivalent man
MT	metric tons
pH	potential of hydrogen
ppm	parts per million
psi, lb/in <sup>2</sup>	pounds per square inch
s or sec	second
ton	short ton (2,000 lb weight)
torr	pressure that causes the Hg column to rise 1 millimeter
yr	year

## **1.0 INTRODUCTION**

### **1.1 Purpose**

This document provides specifications for selected system components of the Transportation, Aging and Disposal (TAD) canister-based system. A list of system specified components and ancillary components are included in Section 1.2.

The TAD canister, in conjunction with specialized overpacks will accomplish a number of functions in the management and disposal of spent nuclear fuel. Some of these functions will be accomplished at purchaser sites where commercial spent nuclear fuel (CSNF) is stored, and some will be performed within the Office of Civilian Radioactive Waste Management (OCRWM) transportation and disposal system. This document contains only those requirements unique to applications within Department of Energy's (DOE's) system. DOE recognizes that TAD canisters may have to perform similar functions at purchaser sites. Requirements to meet reactor functions, such as on-site dry storage, handling, and loading for transportation, are expected to be similar to commercially available canister-based systems.

This document is intended to be referenced in the license application for the Monitored Geologic Repository (MGR). As such, the requirements cited herein are needed for TAD system use in OCRWM's disposal system. This document contains specifications for the TAD canister, transportation overpack and aging overpack. The remaining components and equipment that are unique to the OCRWM system or for similar purchaser applications will be supplied by others.

### **1.2 Transportation, Aging and Disposal (TAD) System Description**

A TAD system consists of a canister, together with other equipment, that allows for management of commercial spent nuclear fuel.

#### **1.2.1 TAD canister**

The TAD canister is loaded with commercial spent nuclear fuel (CSNF) and sealed at purchaser sites (e.g., reactors) or the repository. The loaded TAD canister may be used for storage for a period of time at purchaser sites; for this purpose it must be approved contents for a storage system certified under title 10 CFR part 72. The loaded TAD canister may be delivered to DOE for transportation to the geologic repository operations area (GROA), for which it would be listed as approved contents for packaging, including the transportation overpack, certified under title 10 CFR part 71. At the GROA, a loaded TAD canister may also be handled using a shielded transfer cask or aged in an aging overpack; and shall be disposed of in a waste package. All three of these functions will be covered by the repository license granted under title 10 CFR part 63.

1.2.2 Transportation Overpack

The transportation overpack is an overpack certified under title 10 CFR part 71 as a packaging component used to enclose TAD canisters for transportation. The transportation overpack: protects the TAD canister during normal conditions of transport and design basis accidents; dissipates decay heat from the contained CSNF; and, protects workers and the public from radiation.

1.2.3 Transportation Skid

The transportation skid is the means of handling assembled transportation packages at various sites and during inter-modal transfers.

1.2.4 Ancillary Equipment

Ancillary equipment is any general or site specific equipment, not specifically described within this document, required to operate and handle TAD system components in accordance with their certificates of compliance and other regulatory or operational requirements. Ancillary equipment to be used at the repository will be provided by others. Any ancillary equipment needed for use at purchaser sites is expected to be similar to commercially available equipment in common usage.

1.2.5 Shielded Transfer Cask

The shielded transfer cask (STC) is used to transport a loaded TAD canister among the various surface facilities at the GROA prior to loading into an aging overpack or waste package. The STC protects the TAD canister from damage, protects workers from radiation and allows for proper heat dissipation. The STC for use at the repository will be provided by others. STC to be used at purchaser sites are expected to be similar to commercially available equipment commonly used.

1.2.6 Aging Overpack

Aging overpacks are used to safely contain a loaded TAD canister on the aging pad until repository emplacement thermal limits are met. The aging overpack protects the TAD canisters from damage, dissipates decay heat and protects workers from radiation.

1.2.7 Site Transporter

The site transporter is a vehicle to be used for transporting loaded and unloaded STCs and aging overpacks at the GROA. The transporter will also provide support for STCs and aging overpacks during loading and unloading operations. The site transporter will be provided by others. A site transporter is expected to be required to perform analogous functions at purchaser sites. Any site transporter that is part of a site specific independent spent fuel storage installation (ISFSI) system is expected to be similar to commercially available equipment in common usage.



1.2.8 Waste Package

The waste package is the disposal container that the TAD canister will be sealed inside prior to final emplacement in the drift.

1.2.9 Storage Overpack

The storage overpack provides functions analogous to the aging overpack at purchaser sites. Storage overpacks which are part of a purchaser site specific ISFSI will be designed to meet the requirements of title 10 CFR part 72. Storage overpacks used at purchaser sites as part of a site specific ISFSI are expected to be similar to commercially available equipment in common usage.

### 1.3 Definitions

**Accident-** An undesirable event; especially one that could potentially do damage or harm to a cask or its contents.

**Approved Contents-** Used in the context of this performance specification, the term “approved contents” means one of the following:

Transportation Overpack: The contents of Type B packaging as defined NRC Regulatory Guide 7.9 *Standard Format and Content of Part 71 Applications for Approval of Packages for Radioactive Material* and listed in section 5b “Contents of Packaging” of Certificates of Compliance issued under 10 CFR part 71.

Storage Overpack: The materials to be stored as defined in NRC Regulatory Guide 3.61 *Standard Format and Content for a Topical Safety Analysis Report for a Spent Fuel Dry Storage Cask* and listed in Section 6 “Approved Contents” of Certificates of Compliance issued under 10 CFR part 72.

**Normal-** A term used to define expected radioactive wastes, operations and/or processes.

**Off-normal-** A term used to define any combination of radioactive waste, operations or processes that are not expected during normal activities; usually associated with damaged or failed materials, equipment or processes.

**Purchaser-** Any person, other than a Federal agency, who is licensed by the Nuclear Regulatory Commission to use a utilization or production facility under the authority of sections 103 or 104 of the Atomic Energy Act of 1954 (42 U.S.C. 2133, 2134) or who has title to spent nuclear fuel or high-level radioactive waste and who has executed a contract for disposal of spent nuclear fuel and/or high-level radioactive waste with DOE.

## 1.4 Safety Classification of the Components

Safety classification of the components in this specification has not been assigned. However; the TAD canister, the transportation overpack, and the aging overpack covered by this specification are expected to be Important to Safety (ITS).

## 1.5 Limitations

No portion of this specification shall be interpreted such that it suggests, implies or intimates that the vendor is responsible for showing compliance with 10 CFR part 63, *Disposal of High-Level Radioactive Wastes in a Geologic Repository at Yucca Mountain, Nevada*. That responsibility remains the sole purview of the Department of Energy.

Those conditions unique to the operations at the GROA are included in this performance specification.

## 2.0 APPLICABLE DOCUMENTS/REFERENCES

### 2.1 Regulations

10 CFR part 19- 2006 Energy: *Notices, Instructions and Reports to Workers: Inspection and Investigations*.

10 CFR part 20- 2006 Energy: *Standards for Protection Against Radiation*.

10 CFR part 21- 2006 Energy: *Reporting of Defects and Noncompliance*.

10 CFR part 26- 2006 Energy: *Fitness for Duty Programs*.

10 CFR part 50- 2006 Energy: *Domestic Licensing of Production and Utilization Facilities*.

10 CFR part 63- 2006 Energy: *Disposal of High-Level Radioactive Wastes in a Geologic Repository at Yucca Mountain, Nevada*.

10 CFR part 71- 2006 Energy: *Packaging and Transportation of Radioactive Material*.

10 CFR part 72- 2006 Energy: *Licensing Requirements for the Independent Storage of Spent Nuclear Fuel, High-Level Radioactive Waste and Reactor-Related Greater than Class C Waste*.

10 CFR part 73- 2006 Energy: *Physical Protection of Plants and Materials*.

10 CFR part 74- 2006 Energy: *Material Control and Accounting of Special Nuclear Material*.

10 CFR part 140- 2006 Energy: *Financial Protection Requirements and Indemnity Agreements.*

10 CFR part 835- 2006 Energy: *Occupational Radiation Protection.*

10 CFR part 961- 2006 Energy: *Standard Contract for Disposal of Spent Nuclear Fuel and/or High-Level Radioactive Waste.*

40 CFR part 261- 2006 *Protection of Environment: Identification and Listing of Hazardous Waste.*

49 CFR part 173- 2006 *Transportation: Shippers--General Requirements for Shipments and Packagings.*

66FR 55732- *Disposal of High-Level Radioactive Wastes in a Proposed Geologic Repository at Yucca Mountain, NV, Final Rule.* 10 CFR parts 2, 19, 20, 21, 30, 40, 51, 60, 61, 63, 70, 72, 73 and 75.

*Nuclear Waste Policy Act of 1982.* 42 U.S.C. 10101 et seq.

*Resource Conservation and Recovery Act of 1976.* 42 U.S.C. 6901 et seq.

## **2.2 DOE Documents**

DOE O 450.1-Change 2; 2005; *Environmental Protection Program*; Washington, D.C.: U.S. Department of Energy.

DOE-STD-1090-2004. 2004. *Hoisting and Rigging (Formerly Hoisting and Rigging Manual)*. Washington, D.C.: U.S. Department of Energy.

DOE O 435.1. 1999. *Radioactive Waste Management*. Washington, D.C.: U.S. Department of Energy.

## **2.3 NRC Documents**

NUREG-1567, *Standard Review Plan for Spent Fuel Dry Storage Facilities*

NUREG-1536, *Standard Review Plan for Dry Cask Storage Systems*

NUREG-1617, *Standard Review Plan for Transportation Packages for Spent Nuclear Fuel*

NUREG-0612, *Control of Heavy Loads at Nuclear Power Plants*

NUREG-0800, *Standard Review Plan for the Review of Safety Analysis Reports for Nuclear Power Plants*

NUREG/CR-4461, *Tornado Climatology of the Contiguous United States*

NUREG-1804, *Yucca Mountain Review Plan*

Regulatory Guide 1.23, Rev. 0, 1972; *Onsite Meteorological Programs*;  
Washington, D.C.: U.S. Atomic Energy Commission.

Regulatory Guide 1.76, Rev. 0, 1974; *Design Basis Tornado for Nuclear Power  
Plants*; Washington, D.C.: U.S. Atomic Energy Commission.

NRC Regulatory Guide 7.9 *Standard Format and Content of Part 71 Applications  
for Approval of Packages for Radioactive Material*

NRC Regulatory Guide 3.61 *Standard Format and Content for a Topical Safety  
Analysis Report for a Spent Fuel Dry Storage Cask*

SFPO-ISG-11, Revision 3, *Cladding Considerations for the Transportation and  
Storage of Spent Fuel*

SFPO-ISG-18, *The Design/Qualification of Final Closure Welds on Austenitic  
Stainless Steel Canisters as Confinement Boundary for Spent Fuel Storage and  
Containment Boundary for Spent Fuel Transportation*; NRC Interim Staff  
Guidance

## 2.4 Codes and Standards

AAR (Association of American Railroads) 1993. *Manual of Standards and  
Recommended Practices, Section C – Part II, Specifications for Design,  
Fabrication and Construction of Freight Cars M-1001, Volumes I and II  
Standards*. Washington, D.C.: Association of American Railroads. TIC: 10188.

AAR 2004. *Manual of Standards and Recommended Practices*. Washington,  
D.C.: Association of American Railroads. TIC: 256289.

AASHTO (American Association of State Highway and Transportation Officials)  
2004. *A Policy on Geometric Design of Highways and Streets*. 5th Edition.  
Washington, D.C.: American Association of State Highway and Transportation  
Officials. TIC: 257443.

ANSI/ANS-57.7-1988. *American National Standard Design Criteria for an  
Independent Spent Fuel Storage Installation (Water Pool Type)*. Revision of  
ANSI/ANS 57.7-1981. La Grange Park, Illinois: American Nuclear Society.  
TIC: 238870.

ANSI N14.5-97. 1998. *American National Standard for Radioactive Materials -  
Leakage Tests on Packages for Shipment*. New York, New York: American  
National Standards Institute. TIC: 247029.

ANSI/ANS-57.9. 1992. *Design Criteria for an Independent Spent Fuel Storage Installation (Dry Type)*. La Grange Park, Illinois: American Nuclear Society. TIC: 3043.

ASCE 7-98. 2000. *Minimum Design Loads for Buildings and Other Structures*. Revision of ANSI/ASCE 7-95. Reston, Virginia: American Society of Civil Engineers. TIC: 247427.

ASME (American Society of Mechanical Engineers) 2004. *2004 ASME Boiler and Pressure Vessel Code*. 2004 Edition. New York, New York: American Society of Mechanical Engineers. TIC: 256479.

ASTM A-276-06. 2006. *Standard Specification for Stainless Steel Bars and Shapes*. West Conshohocken, PA: ASTM International. TIC: 258258

ASTM A887-89. 2004 *Standard Specification for Borated Stainless Steel Plate, Sheet, and Strip for Nuclear Application*; Conshohocken, PA 19428: ASTM International. TIC: 258746

ASTM B 932-04. 2004. *Standard Specification for Low-Carbon Nickel-Chromium-Molybdenum-Gadolinium Alloy Plate, Sheet and Strip*. West Conshohocken, Pennsylvania: American Society for Testing and Materials. TIC: 255846.

ISO 11611984/Cor.1:1990(E). 1990. *Series 1 Freight Containers - Corner Fittings - Specification (including Technical Corrigendum 1), 4<sup>th</sup> Edition*. Geneva, Switzerland: International Organization for Standardization. TIC: 258256; 258247.

SEI/ASCE 7-02. 2003. *Minimum Design Loads for Buildings and Other Structures*. Reston, Virginia: American Society of Civil Engineers. TIC: 255517.

IEEE/ASTM SI 10-1997. 1997. *Standard for Use of the International System of Units (SI): The Modern Metric System*. New York, New York: Institute of Electrical and Electronics Engineers.

## 2.5 Other References

*Transportation, Aging and Disposal Canister System Performance Specification Requirements Rationale*; DOC ID: WMO-TADCS-RR-000001 Washington, D.C.: U.S. Department of Energy.

BSC 2004. *Criticality Model*. CAL-DS0-NU-000003 REV 00A. Las Vegas, Nevada: Bechtel SAIC Company. ACC: DOC.20040913.0008; DOC.20050728.0007.

BSC 2008. Supplemental Earthquake Ground Motion Input for a Geologic Repository at Yucca Mountain, NV. MDL-MGR-GS-000007 REV 00. Las Vegas, Nevada: Bechtel SAIC Company. ACC: DOC.20080221.0001

Sandia National Laboratories (SNL) 2007. *Criticality Input to Canister-Based System Performance Specification for Disposal*. TDR-DS0-NU-000002 REV 01. Las Vegas, Nevada: Sandia National Laboratories. ACC: DOC.20070103.0002.

YMP 2003 Disposal Criticality Analysis Methodology Topical Report, YMP/TR-004Q, Rev. 02, Yucca Mountain Site Characterization Office, Las Vegas, Nevada, 5 November 2003 DOC.20031110.0005

### **3.0 PERFORMANCE REQUIREMENTS**

For the purposes of this specification, the following English unit designations and conventions are intended:

lb. = pound force not pound mass

ton = short ton (2,000 lb.)

#### **3.1 TAD Canister**

When necessary, the following TAD canister-based system components shall work in conjunction with the TAD canister to meet objectives of this performance specification:

- Transportation Overpack (Section 3.2)
- Aging Overpack (Section 3.3)
- Ancillary Equipment (Not Included in this Specification)
- Shielded Transfer Cask (Not Included in this Specification)
- Site Transporter (Not Included in this Specification)

##### **3.1.1 General**

This section applies to the TAD canister, which will be part of a Nuclear Regulatory Commission (NRC) certified system, approved for confining CSNF during storage, transportation, aging and disposal. The TAD canister includes a canister shell, lid(s) and components (e.g., basket for holding fuel assemblies, thermal shunts and neutron absorbers, etc.) needed to perform its functions.

- (1) The TAD canister shall be a right circular cylinder with a diameter of  $66.5 \text{ in.} \left( \begin{array}{c} +0.0 \text{ in.} \\ -0.5 \text{ in.} \end{array} \right)$ . The TAD canister height shall not be less than 186.0 in. and not greater than 212.0 in. including the lifting feature shown in Attachment C considering all relevant factors (e.g., tolerance stack-up, thermal expansion, internal pressure).

- a. For a TAD canister with a height less than the maximum, a TAD waste package spacer (TWPS) meeting requirements in Section 3.1.1(17-20) shall be included. If required, the TWPS shall have a diameter of  $66.5 \text{ in.} \left( \begin{array}{c} + 0.0 \text{ in.} \\ - 0.5 \text{ in.} \end{array} \right)$  and length such that the combined height of the TWPS and TAD canister shall be  $212.0 \text{ in.} \left( \begin{array}{c} + 0.0 \text{ in.} \\ - 0.5 \text{ in.} \end{array} \right)$  considering all relevant factors (e.g., tolerance stack-up, thermal expansion, internal pressure).
  - b. If required, the TWPS shall be placed in a waste package prior to loading of the TAD canister for disposal. The TWPS function is to restrict axial motion of the TAD canister within the waste package after emplacement.
- (2) The TAD canister loaded weight shall be consistent with the height determined in accordance with 3.1.1(1). The combined weight of the loaded TAD canister and TWPS shall not exceed 54.25 tons.
  - (3) The capacity of the TAD canister shall be either 21 pressurized water reactor (PWR) spent fuel assemblies or 44 boiling water reactor (BWR) spent fuel assemblies.
  - (4) The loaded and closed TAD canister shall be capable of being reopened while submerged in a borated or unborated pool.
  - (5) A TAD canister for PWR assemblies shall be limited to accepting CSNF with characteristics less than 5% initial enrichment, less than 80 GWd/MTU burn up and no less than 5 years out-of-reactor cooling time.<sup>1,3</sup>
  - (6) A TAD canister for BWR assemblies shall be limited to accepting CSNF with characteristics less than 5% initial enrichment, less than 75 GWd/MTU burnup and no less than 5 years out-of-reactor cooling time.<sup>2,3</sup>
  - (7) A TAD canister shall be capable of being loaded with CSNF from one or more facilities that are licensed by the NRC and hold one or more contracts with the DOE for disposal of CSNF.<sup>3</sup>
  - (8) All external edges of the TAD canister shall have a minimum radius of curvature of 0.25 in.

---

<sup>1</sup> These characteristics represent bounding PWR characteristics used in the repository design basis and provide enveloping conditions for repository shielding, thermal and dose consequence analysis.

<sup>2</sup> These characteristics represent bounding BWR characteristics used in the repository design basis and provide enveloping conditions for the repository shielding, thermal and dose consequence analysis.

<sup>3</sup> TAD canister design basis SNF (i.e., approved contents) chosen by the vendor shall be any assembly subset with characteristics bounded by the limits defined by 3.1.1(5) or 3.1.1(6).

- (9) To the extent practicable, projections or protuberances from reasonably smooth adjacent surfaces shall be avoided or smoothly blended into the adjacent smooth surfaces.
- (10) The TAD canister shall be designed to store vendor defined design basis CSNF at a purchaser site in accordance with 10 CFR part 72 in either a horizontal or vertical orientation.
- (11) A TAD canister shall be designed to transport vendor defined design basis CSNF to the GROA in a horizontal configuration.
- (12) A TAD canister shall be designed to dispose of vendor defined design basis CSNF in a waste package in a horizontal configuration.
- (13) A TAD canister shall be designed to be handled at the GROA loaded with vendor defined design basis CSNF in a vertical configuration.
- (14) A TAD canister shall be designed to age vendor defined design basis CSNF in a vertical configuration.
- (15) At the time of delivery to the repository, a loaded TAD canister shall have a remaining service lifetime for aging of 50 years without maintenance.<sup>4</sup>
- (16) The service lifetime environmental conditions shall be site appropriate for the period of deployment at reactors. Yucca Mountain environmental conditions apply for repository aging service.
- (17) TWPS shall be constructed of materials specified in 3.1.8 (1).
- (18) TWPS shall be a right circular cylinder, either solid or hollow with sides and ends formed from plates at least 2 inches thick.
- (19) The TWPS shall have an average mass density equal to or greater than that of the loaded TAD canister.<sup>5</sup>
- (20) The TWPS shall include four (4) threaded holes in its top for the purpose of attaching temporary rigging meeting requirements of NUREG-0612, *Control of Heavy Loads at Nuclear Power Plants* to be used when inserting the TWPS into an otherwise empty waste package.

### 3.1.2 Structural

- (1) For each of the following design basis seismic events and configurations, the TAD canister shall meet the performance specifications. Seismic vertical and horizontal spectral accelerations are detailed in Attachment A.

---

<sup>4</sup> Prior to delivery to the repository, a loaded TAD canister may have been stored at a reactor site for up to 60 years.

<sup>5</sup> The average mass density is determined by dividing the total mass of the TAD canister/TWPS by the volume of a right circular cylinder with same diameter and height.



- a. Following a 2,000-year seismic return period event, a TAD canister shall maintain a maximum leakage rate of  $1.5 \times 10^{-12}$  fraction of canister free volume per second<sup>6</sup> (normal), maximum cladding temperature of 752° F (normal) and remain within design codes while in the configurations described below.
  - While suspended by a crane inside an ASTM A-36 cylindrical steel cavity with an inner diameter of 72.5 inches with 12 inch thick wall.
  - While contained in a vendor defined transportation overpack (with impact limiters) described in Section 3.2 of this performance specification.
  - While contained in a vendor defined transportation overpack (without impact limiters) described in Section 3.2 of this performance specification that is constrained in an upright position. A constrained transportation overpack is one properly secured into GROA transfer trolley and restrained from tip-over in a seismic event.
  - While contained in a vendor defined aging overpack as described in Section 3.3 of this performance specification.
- b. Following a 10,000-year seismic return period event, a TAD canister shall maintain a maximum leakage rate of  $1.5 \times 10^{-12}$  fraction of canister free volume per second<sup>6</sup> (normal), cladding temperature limit of 1,058° F (off-normal) and remain within design codes while in the configurations described below.
  - While suspended by a crane inside an ASTM A-36 cylindrical steel cavity with an inner diameter of 72.5 inches with 12 inch thick wall.
  - While contained in a vendor defined transportation overpack (with impact limiters) described in Section 3.2 of this performance specification.
  - While contained in a vendor defined transportation overpack (without impact limiters) described in Section 3.2 of this performance specification that is constrained in an upright position. A constrained transportation overpack is one properly secured into GROA transfer trolley and restrained from tip-over in a seismic event.
  - While contained in a vendor defined aging overpack as described in Section 3.3 of this performance specification.
- c. Following a seismic event characterized by horizontal and vertical peak ground accelerations of 96.52 ft/s<sup>2</sup> (3g) a TAD canister shall maintain a maximum leakage rate of  $1.5 \times 10^{-12}$  fraction of canister free volume per second<sup>6</sup> (normal) while in the configurations described below. For this initiating event, canister design codes may be exceeded (i.e., vendor may rely on capacity in excess of code allowances).

---

<sup>6</sup> This leakage rate meets the leak-tight criterion of ANS/ANSI-N14.5, *American National Standard for Radioactive Materials - Leakage Tests on Packages for Shipment*.

- A TAD canister in a vendor defined transportation cask described in Section 3.2 that drops 10 feet onto an unyielding surface in the most damaging orientation. The transportation cask configuration shall be with or without impact limiters.
  - While contained in a vendor defined transportation overpack (without impact limiters) described in Section 3.2 of this performance specification that is constrained in an upright position. A constrained transportation overpack is one properly secured into GROA transfer trolley and restrained from tip-over in a seismic event.
  - While contained in a vendor defined aging overpack as described in Section 3.3 of this performance specification.
- (2) A TAD canister in a vendor defined aging overpack shall maintain a maximum leakage rate of  $1.5 \times 10^{-12}$  fraction of canister free volume per second<sup>6</sup> (normal) and cladding temperature limits (see inset) during and following exposure to the environmental conditions listed below.

For a - e, the cladding temperature limits are 752° F and 1,058° F for “normal” and “off-normal” limits, respectively.

- a. These environmental conditions are not cumulative but occur independently:
- Outdoor average daily temperature range of 2° F to 116° F with insolation as specified in 10 CFR part 71 (normal)
  - An extreme wind gust of 120 mph for 3-sec (normal)
  - Maximum tornado wind speed of 189 mph with a corresponding pressure drop of 0.81 lb/in<sup>2</sup> and a rate of pressure drop of 0.30 lb/in<sup>2</sup>/sec (off-normal). The spectrum of missiles from the maximum tornado is provided in Table 3.1-1 (off-normal):

**Table 3.1-1 Spectrum of Missiles**

Missile	Mass (lb)	Dimensions (ft)	Hor. Vel. (ft/s)
Wood Plank	114.6	0.301 × 0.948 × 12	190.2
6” Schedule 40 pipe	286.6	0.551D × 15.02	32.8
1 in. steel rod	8.8	0.0833D × 3	26.3
Utility Pole	1,124	1.125D × 35.04	85.3
12” Schedule 40 pipe	749.6	1.05D × 15.02	23.0

- b. Annual precipitation of 20 inches/year (normal). The spectrum of rainfall is provided in Table 3.1-2 (normal):

**Table 3.1-2 Spectrum of Rainfall**

<b>Parameter and Frequency</b>	<b>Nominal Estimate</b>	<b>Upper Bound 90% Confidence Interval*</b>
Maximum 24-hr precipitation (50-year return period)	2.79 in./day	3.30 in./day
Maximum 24-hr precipitation (100-year return period)	3.23 in./day	3.84 in./day
Maximum 24-hr precipitation (500-year return period)	4.37 in./day	5.25 in./day
Precipitation 1-hr intensity (50-year return period)	1.35 in./hr	1.72 in./hr
Precipitation 1-hr intensity (100-year return period)	1.68 in./hr	2.15 in./hr

\*Use the values for upper bound 90% confidence interval.

- c. Maximum daily snowfall of 6.0 in. (normal)
  - d. Maximum monthly snowfall of 6.6 in. (normal)
  - e. A lightning strike with a peak current of 250 kiloamps over a period of 260 microseconds and continuous current of 2 kiloamps for 2 seconds (off-normal).
- (3) A TAD canister in a transportation overpack (with impact limiters) shall maintain a maximum leakage rate of  $1.5 \times 10^{-12}$  fraction of canister free volume per second<sup>6</sup> (off-normal) and cladding temperature limits (see inset) during and following exposure to the environmental conditions listed below.

For a - e, the cladding temperature limits are 752° F and 1,058° F for “normal” and “off-normal” limits, respectively.

- a. These environmental conditions are not cumulative but occur independently:
  - Outdoor average daily temperature range of 2° F to 116° F with insolation as specified in 10 CFR part 71 (normal)
  - An extreme wind gust of 120 mph for 3-sec (normal)
  - Maximum tornado wind speed of 189 mph with a corresponding pressure drop of 0.81 lb/in<sup>2</sup> and a rate of pressure drop of 0.30 lb/in<sup>2</sup>/sec (off-normal). The spectrum of missiles from the maximum tornado is provided in Table 3.1-3 (off-normal):

**Table 3.1-3 Spectrum of Missiles**

Missile	Mass (lb)	Dimensions (ft)	Hor. Vel. (ft/s)
Wood Plank	114.6	0.301 × 0.948 × 12	190.2
6" Schedule 40 pipe	286.6	0.551D × 15.02	32.8
1 in. steel rod	8.8	0.0833D × 3	26.3
Utility Pole	1,124	1.125D × 35.04	85.3
12" Schedule 40 pipe	749.6	1.05D × 15.02	23.0

- b. Annual precipitation of 20 inches/year (normal). The spectrum of rainfall is provided in Table 3.1-2 (normal):

**Table 3.1-4 Spectrum of Rainfall**

Parameter and Frequency	Nominal Estimate	Upper Bound 90% Confidence Interval*
Maximum 24-hr precipitation (50-year return period)	2.79 in./day	3.30 in./day
Maximum 24-hr precipitation (100-year return period)	3.23 in./day	3.84 in./day
Maximum 24-hr precipitation (500-year return period)	4.37 in./day	5.25 in./day
Precipitation 1-hr intensity (50-year return period)	1.35 in./hr	1.72 in./hr
Precipitation 1-hr intensity (100-year return period)	1.68 in./hr	2.15 in./hr

\*Use the values for upper bound 90% confidence interval.

- c. Maximum daily snowfall of 6.0 in. (normal)
  - d. Maximum monthly snowfall of 6.6 in. (normal)
  - e. A lightning strike with a peak current of 250 kiloamps over a period of 260 microseconds and continuous current of 2 kiloamps for 2 seconds (off-normal).
- (4) The TAD canister shall have a flat bottom.

3.1.3 Thermal

- (1) Except as noted in 3.1.3 (2), CSNF cladding temperature in TAD canisters shall not exceed 752° F during normal operations. Normal operations include storage at purchaser sites, transportation from purchasers to the GROA and handling at the GROA (e.g., aging, storage, onsite transfer, etc).
- (2) CSNF cladding temperature shall not exceed 1,058° F during draining, drying and backfill operations following TAD canister loading.
- (3) The maximum leakage rate of a TAD canister shall be  $9.3 \times 10^{-10}$  fraction of canister free volume per second (off-normal) after a fully-engulfing fire characterized by an average flame temperature of 1,720 °F and lasting 30

minutes. During this event the TAD canister is in either a closed vendor defined transportation overpack (with or without impact limiters) or an open vendor defined transportation overpack without impact limiters. For this event, canister design codes may be exceeded (i.e., vendor may rely on capacity in excess of code allowances).

- (4) TAD canister cooling features and mechanisms shall be passive.
- (5) To ensure adequate thermal performance of the TAD canister when emplaced in the waste package, the peak cladding temperature shall be less than 662° F for each set of conditions in Table 3.1-3.

**Table 3.1-3 Thermal Conditions for Cladding Temperature Determination**

<b>Thermal Output (kW)</b>	<b>Canister Surface Temperature Boundary Conditions (°F)</b>
11.8	525
18	450
25	358

3.1.4 Dose and Shielding

- (1) For GROA operations, the combined neutron and gamma integrated average dose rate over the top surface of a loaded TAD canister shall not exceed 800 mrem/hr on contact.
- (2) For GROA operations, the combined contact neutron and gamma maximum dose rate at any point on the top surface of the TAD canister shall not exceed 1,000 mrem/hr.
- (3) The TAD canister shall be designed such that contamination on an accessible external surface shall be removable to:
  - a. 1,000 dpm/100 cm<sup>2</sup> - beta-gamma with a wipe efficiency of 0.1.
  - b. 20 dpm/100 cm<sup>2</sup> - alpha with a wipe efficiency of 0.1

3.1.5 Criticality

- (1) No specific requirements beyond those of 10 CFR Part 71, Subpart E, Paragraph 55(b).
- (2) Postclosure Criticality control shall be maintained by employing either the items in (a) or the analysis in (b), as follows:
  - a. Include the following features in the TAD canister internals:
    - 1. Neutron absorber plates or tubes made from borated stainless steel produced by powder metallurgy and meeting ASTM A887-89, *Standard Specification for Borated Stainless Steel Plate, Sheet, and Strip for Nuclear Application*, Grade “A” alloys.

2. Minimum thickness of neutron absorber plates shall be 0.4375 inches. Maximum and nominal thickness may be based on structural requirements. Multiple plates may be used if corrosion assumptions (250 nm/year) are taken into for all surfaces such that 6 mm remains after 10,000 years.
3. The neutron absorber plate shall have a boron content of 1.1 wt % to 1.2 wt %, a range that falls within the specification for 304B4 UNS S30464 as described in ASTM A887-89, *Standard Specification for Borated Stainless Steel Plate, Sheet, and Strip for Nuclear Application*.
4. Neutron absorber plates or tubes shall extend along the full length of the active fuel region inclusive of any axial shifting of the assemblies within the TAD canister.
5. Neutron absorber plates or tubes must cover all four longitudinal sides of each fuel assembly.
6. TAD canister designs for PWR fuel assemblies shall accommodate assemblies loaded with a disposal control rod assembly (DCRA<sup>7</sup>). A DCRA is intended for acceptance of PWR CSNF with characteristics outside limits set in the postclosure criticality loading curves. Current postclosure criticality loading curves are shown in Attachment B of this performance specification. Updated postclosure criticality loading curves that represent a PWR TAD canister with features described in items 1 through 5 of this subsection may be provided at a later date.
  - b. Perform analyses of TAD canister-based systems to ensure the maximum calculated effective neutron multiplication factor ( $k_{eff}$ )<sup>8</sup> for a TAD canister containing the most reactive CSNF for which the design is approved shall not exceed the critical limit<sup>9</sup> for four postclosure archetypical proxy configurations.<sup>10,11</sup>

### 3.1.6 Containment

- (1) The TAD canister design shall meet either of the requirements below.

---

<sup>7</sup> DCRA is similar to control rod assemblies, reactivity control assemblies, reactivity control cluster assemblies or burnable poison rod assemblies placed in fuel assemblies during irradiation in reactors. A primary difference is extra thick zircaloy cladding, absorber materials that extend beyond the active fuel length and spiders that hold rods have thick zircaloy or titanium locking mechanism(s).

<sup>8</sup> The maximum  $k_{eff}$  for a configuration is the value at the upper limit of a two-sided 95% confidence interval.

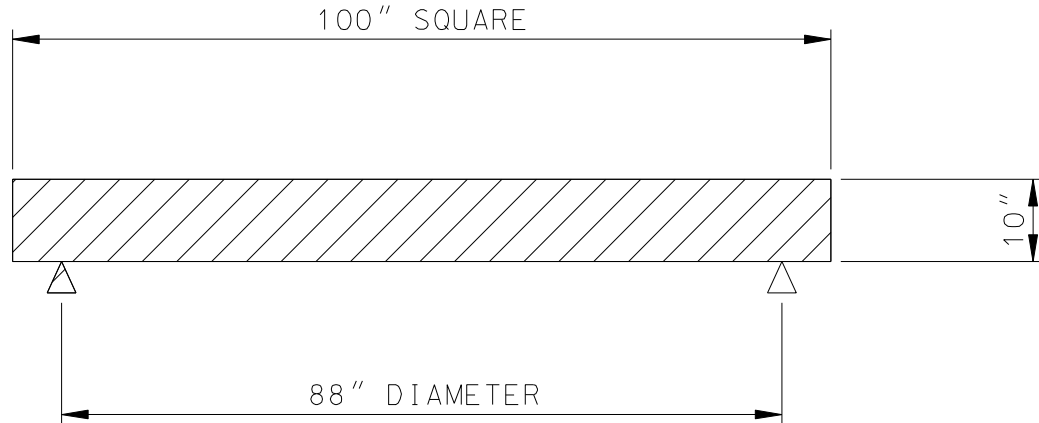
<sup>9</sup> The critical limit is the value of  $k_{eff}$  at which a configuration is considered potentially critical including biases and uncertainties (BSC 2004, Section 6.3.1).

<sup>10</sup> The *Criticality Input to Canister Based System Performance Specification for Disposal* (SNL 2007, Section 3.1) provides a set of considerations for determining the proxy configurations based upon analyses of different, but similar, waste package designs. A list of the four proxy configuration cases are:

- a. Nominal case, basket assembly degraded, CSNF intact.
- b. Seismic case-I, basket assembly intact, CSNF degraded.
- c. Seismic case-II, basket assembly degraded, CSNF degraded.
- d. Igneous intrusion case, basket assembly degraded, CSNF degraded, waste package and TAD structural deformation.

<sup>11</sup> A system performance assessment is a comprehensive analysis estimating dose incurred by reasonably maximally exposed individual, including associated uncertainties, as a result of repository releases caused by all significant features, events, processes, and sequences of events and processes, weighted by their probability of occurrence (YMP 2003, Appendix B).

- a. The qualification of the TAD canister final closure welds shall meet SFPO-ISG-18, *Design/Qualification of Final Closure Welds on Austenitic Stainless Steel Canisters as Confinement Boundary for Spent Fuel Storage and Containment Boundary for Spent Fuel Transportation*, for assuring no credible leakage for containment and confinement.
  - b. The TAD canister shall be designed to facilitate helium leak testing of closure features using methods that can demonstrate the defined leak-tight requirements have been met. Leak testing shall be performed in accordance with ANSI N14.5-97, *American National Standard for Radioactive Materials - Leakage Tests on Packages for Shipment*.
- (2) Helium shall be the only gas used for final backfill operations.
  - (3) TAD canister shell and lid shall be designed and fabricated in accordance with *ASME Boiler and Pressure Vessel Code*, Section III, Division 1, Sub-section NB (for Class 1 Components). Vendor shall identify applicable exceptions, clarifications, interpretations, and code cases.
  - (4) In accordance with industry standards and regulatory guidance, the TAD canister shall be designed to facilitate the following:
    - a. Draining and drying to remove water vapor and oxidizing material shall be carried out in accordance with NUREG-1536, *Standard Review Plan for Dry Cask Storage Systems Final Report*, USNRC, January 1997.
    - b. Filling with helium to atmospheric pressure or greater as required to meet leak test procedural requirements.
    - c. Sampling of the gas space to verify helium purity.
    - d. Limiting maximum allowable oxidizing gas concentration within the loaded and sealed TAD canister to 0.20% of the free volume in the TAD canister at atmospheric pressure.
  - (5) A loaded TAD canister shall maintain a leakage rate of  $1.5 \times 10^{-12}$  fraction of canister free volume per second<sup>6</sup> (normal) and cladding temperature below 752° F (normal) following a 12 inch vertical flat-bottom drop. The impacted surface is a solid carbon steel plate, simply supported as shown in Figure 3.1-1. The material conforms to ASTM A36/A36M, *Standard Specification for Carbon Structural Steel*. Centerline of the TAD canister may be offset from centerline of the plate by as much as three (3) inches.



**Figure 3.1-1**

**3.1.7 Operations**

- (1) The TAD canister lid shall be designed for handling under water with the TAD canister in a vertical orientation.
- (2) The TAD canister body and lid shall have features to center and seat the lid during submerged installation. The maximum off-center value is  $\frac{1}{2}$  in.
- (3) A feature for lifting a vertically oriented, loaded TAD canister from the lid shall be provided. The lifting feature may be integral with the lid or mechanically attached. The lifting feature shall be in place and ready for service prior to transport to the repository. A sketch of the lifting feature that shall be used is shown in Attachment C.
- (4) An open, empty and vertically oriented TAD canister shall have integral lifting feature(s) provided to allow lifting by an overhead handling system.
- (5) The TAD canister shall be designed with features such that draining, drying and backfill operations take advantage of "as low as reasonably achievable" (ALARA) principles.

**3.1.8 Materials**

- (1) Required Materials- Except for thermal shunts and criticality control materials, the TAD canister and structural internals (i.e., basket) shall be constructed of a Type 300-series stainless steel (UNS S3XXXX, such as UNS S31603, which may also be designated as type 316L) as listed in ASTM A-276-06, *Standard Specification for Stainless Steel Bars and Shapes*.
- (2) The TAD canister and its basket materials shall be designed to be compatible with either borated or unborated repository pool water as defined in Table 3.1-4.



<b>Table 3.1-4. Repository Pool Water Specifications</b>		
Average annual pool water temperature	<90° F (Pool water temperature may exceed 110° F for no more than 5% of the time during June, July, August, and September.)	
	<b>Unborated Pool</b>	<b>Borated Pool</b>
Average annual pool water conductivity	<3 $\mu$ -mho/cm	<3 $\mu$ -mho/cm
Pool water chloride concentration	<0.5 ppm	<0.5 ppm
Pool water pH	5.3 to 7.5	4.5 to 9.0
Pool water boron concentration	-	$\geq$ 2500 ppm

- (3) Prohibited or Restricted Materials
- a. The TAD canister shall not have organic, hydrocarbon-based materials of construction.
  - b. All metal surfaces shall meet surface cleanliness classification C requirement defined in ASME NQA-1-2000 Edition, Subpart 2.1 *Quality Assurance Requirements for Cleaning of Fluid Systems and Associated Components for Nuclear Power Plants*.
  - c. The TAD canister shall not be constructed of pyrophoric materials.
  - d. The TAD canister, including the steel matrix, gaskets, seals, adhesives and solder, shall not be constructed with materials that would be regulated as hazardous wastes under the Resource Conservation and Recovery Act (RCRA) and prohibited from land disposal under RCRA if declared to be waste.
- (4) Markings
- a. The TAD canister shall be capable of being marked on the lid and body with an identical unique identifier prior to delivery for loading.
  - b. The unique identifier space shall be of suitable length and height to contain nine (9) alphanumeric and two (2) special characters (e.g., -, /, "space", etc.) to be specified by the DOE.
  - c. Alphanumeric characters shall have a minimum height of 6 in.
  - d. The markings shall remain legible without intervention or maintenance during/after any of the following events:
    - The entire service life defined in Section 3.1.1.
    - Normal operations to include loading, closure, storage, transportation, aging and disposal.
    - Dose, heat and irradiation associated with the vendor defined design basis PWR or BWR, as applicable.

### 3.2 Transportation Overpack

#### 3.2.1 General

- (1) The transportation overpack cavity shall accommodate a TAD canister formed as a right-circular cylinder with a length including the lifting feature as specified by the vendor in accordance with 3.1.1(1) and a diameter of 66.5 in.; and Attachment C.
- (2) The transportation overpack shall function with a vendor defined TAD canister that meets the requirements of Section 3.1.
- (3) The loaded transportation overpack (without impact limiters) shall be designed to be lifted in a vertical orientation by an overhead crane.
- (4) The loaded transportation overpack (without impact limiters) shall be able to stand upright when set down upon a flat horizontal surface without requiring the use of auxiliary supports.
- (5) The size and weight of the loaded transportation overpack shall be limited to the characteristics provided in Table 3.2-1.

**Table 3.2-1 Transportation Overpack Characteristics**

Characteristic	Value
Maximum cask length without impact limiters (in.)	230
Maximum cask length with impact limiters (in.)	333
Maximum cask diameter without impact limiters (in.)	98
Maximum cask lid diameter (in.)	84
Maximum distance across upper trunnions (in.)	108
Maximum diameter of impact limiters (in.)	126
Maximum weight of fully loaded overpack without impact limiters (lb.)	250,000
Maximum weight of fully loaded overpack, impact limiters and transportation skid (lb.)	360,000

- (6) Lifting attachments and appurtenances on transportation overpacks, overpack lids and impact limiters shall be designed, documented and fabricated in accordance with NUREG-0612 *Control of Heavy Loads at Nuclear Power Plants*.

#### 3.2.2 Structural

A loaded TAD canister contained within a transportation overpack assembled with any other components included in the packaging, as defined in 10 CFR part 71, shall meet the requirements for a Type B cask as specified in 10 CFR part 71, as evidenced by a valid Certificate of Compliance.

### 3.2.3 Thermal

- (1) During normal operations, the CSNF cladding temperature in the TAD canister shall not exceed 752° F. Normal operations include transportation from purchaser sites to the GROA.
- (2) Transportation overpacks cooling features and mechanisms shall be passive.

### 3.2.4 Dose and Shielding

- (1) The transportation overpack impact limiters shall include design and handling features that use standardized tools and features that simplify removal operations. Standard tools are those that can be found in industrial tool catalogs.
- (2) Supplemental shielding shall not be required in vacant trunnion locations to meet dose requirements for transporting the TAD canister with vendor defined contents.
- (3) Transportation overpack shall be designed such that contamination on accessible external surfaces shall be removable to:
  - a. 1,000 dpm/100 cm<sup>2</sup> - beta-gamma with a wipe efficiency of 0.1.
  - b. 20 dpm/100 cm<sup>2</sup> - alpha with a wipe efficiency of 0.1.

### 3.2.5 Criticality

No specific requirements beyond those of 10 CFR part 71.

### 3.2.6 Containment

The loaded transportation overpack shall have a tamper indicating device (TID) that meets requirements of 10 CFR part 73 *Physical Protection of Plants and Materials*.

### 3.2.7 Operations

- (1) Normal operational procedures shall **not** require submergence of transportation overpack into CSNF pool at repository or loading site. Transportation overpacks may be submerged in pool in unusual or off-normal circumstances.
- (2) Transportation overpack shall have closures that can be bolted and unbolted using standard tools. Standard tools are those that can be found in industrial tool catalogs.
- (3) The transportation overpack shall have trunnions that meet the following requirements.
  - a. There shall be two (2) upper (lifting) trunnions with the centerline located between 8 and 24 inches from the top of the vendor defined transportation overpack.

- b. There shall be two (2) lower (rotation) trunnions with the centerline located less than 36 inches from the bottom of the vendor defined transportation overpack.
  - c. The centerline of each trunnion set shall be outside the area of the spent fuel region to provide maximum ALARA benefits.
- (4) The transportation overpack shall have upper lifting trunnions with dual seats.
- a. The smaller seat (lifting yoke interface) shall have a diameter of 6.75  $\pm$ 0.25 inches and an axial width of no less than 2.5 inches.
  - b. The diameter of the end caps shall not exceed 8.75 inches.
- (5) Transportation skid shall be designed to permit the loaded transportation overpack, without impact limiters, to be upended by rotation about its lower trunnions and removed from the transportation skid in a vertical orientation via overhead crane.
- (6) The lower turning trunnions shall be pocket trunnions and recessed into the cask body.
- (7) The upper trunnions shall:
- a. Be mechanically fastened to the cask body.
  - b. Incorporate features for installation and removal that maximize ALARA principles. Repository goal is to limit total dose for installing or removing the trunnions to less than 40 millirem per pair.
- (8) The upper trunnions shall be removed and stowed during transport.
- (9) The transportation overpack lid shall have a lifting ring that is:
- a. Identical to that of the TAD canister as shown in Attachment C.
  - b. Is removable from the transportation overpack lid.
  - c. Capable of handling the unencumbered transportation overpack lid.
- (10) The transportation skid to be used with the TAD canister-based system shall have the following characteristics:
- a. Secures the transportation overpack during normal conditions of transport in accordance with requirements of 10 CFR part 71.45.
  - b. Secures to the railcar in accordance with requirements of AAR Interchange Rule 88, A.15.c.3. (AAR Field Manual 2006)
  - c. Design shall facilitate lifting of the loaded package in its transportation configuration, including the skid and impact limiters, and transfer of the package from one conveyance to another.

- d. The footprint of the transportation skid shall not exceed 124 inches wide by 360 inches long.
- e. Vendor skid design shall be compatible with all variations of their TAD canister-based system in a transportation configuration (e.g., PWR and BWR variants).
- f. Shall be designed to permit the loaded vendor defined transportation overpack, without impact limiters, to be upended by rotation about its lower trunnions and removed in a vertical orientation via overhead crane.
- g. Skid shall be designed such that the bottom of loaded vendor defined transportation overpack (in a vertical orientation) shall not be required to be lifted more than 12'-3" above grade elevation (top of rail). The conveyance deck height will not be greater than 54" above grade elevation.

3.2.8 Materials

Materials selections shall be as necessary to meet requirements of 10 CFR part 71 and other requirements of this specification.

**3.3 Aging Overpack**

3.3.1 General

- (1) The aging overpack cavity shall accommodate a TAD canister formed as a right-circular cylinder with a length including the lifting feature as specified by the vendor in accordance with 3.1.1(1) and a diameter of 66.5 in.; and Attachment C.
- (2) The aging overpack shall function with a TAD canister that has a loaded weight consistent with vendor specified dimensions in accordance with 3.1.1(1, 2).
- (3) The combined size and weight of the loaded TAD canister-based system in an aging overpack shall be limited to ensure handling at the GROA. The limits are provided in Table 3.3-1.

<b>Table 3.3-1 Combined Size and Weight Limits</b>	
Maximum overpack diameter	144 in.
Maximum overpack lid diameter	84 in.
Maximum overpack lid thickness	18 in.
Maximum overpack length	264 in.
Maximum overpack weight (loaded)	250 tons

- (4) The aging overpack shall meet the operational requirements detailed in sketch presented in Attachment D.

- (5) The aging overpack shall be designed to be moved in a vertical orientation.
- (6) The aging overpack lid shall have a lifting ring that is:
  - a. Identical to that of the TAD canister as shown in Attachment C.
  - b. Capable of handling the unencumbered aging overpack lid.
- (7) The designed maintainable service lifetime of the aging overpack shall be a minimum of 100 years.

### 3.3.2 Structural

- (1) For each design basis seismic event defined below, the TAD canister in an aging configuration shall meet the following performance specifications. Seismic vertical and horizontal spectral accelerations are detailed in Attachment A.
  - a. Following a 2,000-year seismic return period event:
    - TAD canister in an aging overpack, shall maintain a maximum leakage rate of  $1.5 \times 10^{-12}$  fraction of canister free volume per second<sup>6</sup> (normal)
    - Maintain a maximum cladding temperature of 752° F (normal)
    - Canister design codes shall not be exceeded.
    - The aging overpack shall remain upright and free standing.
  - b. Following a 10,000-year seismic return period event:
    - TAD canister in an aging overpack, shall maintain a maximum leakage rate of  $1.5 \times 10^{-12}$  fraction of canister free volume per second<sup>6</sup> (normal)
    - Maintain a maximum cladding temperature of 1,058° F (off-normal)
    - Canister design codes shall not be exceeded.
    - The aging overpack shall remain upright and free standing.
  - c. Following a seismic event characterized by horizontal and vertical peak ground accelerations of  $96.52 \text{ ft/s}^2$  (3g):
    - TAD canister in an aging overpack, shall maintain a maximum leakage rate of  $1.5 \times 10^{-12}$  fraction of canister free volume per second<sup>6</sup> (normal)
    - Canister design codes may be exceeded (i.e., vendor may rely on capacity in excess of code allowances).
    - The aging overpack shall remain upright and free standing during and following the event.
- (2) During GROA operations, aging overpack shall be designed to maintain a maximum TAD canister leakage rate of  $1.5 \times 10^{-12}$  fraction of free volume per second<sup>6</sup> (normal) and cladding temperature limits (see inset) during and following exposure to the environmental conditions listed below.

For 2a - 2e, the cladding temperature limits are 752° F and 1,058° F for “normal” and “off-normal” limits, respectively.

- a. These environmental conditions are not cumulative but occur independently:
- Outdoor average daily temperature range of 2° F to 116° F with insolation as specified in 10 CFR part 71 (normal)
  - An extreme wind gust of 120 mph for 3-sec (normal)
  - Maximum tornado wind speed of 189 mph with a corresponding pressure drop of 0.81 lb/in<sup>2</sup> and a rate of pressure drop of 0.30 lb/in<sup>2</sup>/sec (off-normal). The spectrum of missiles from the maximum tornado is provided in Table 3.3-2 (off-normal).

**Table 3.3-2 Spectrum of Missiles**

Missile	Mass (lb)	Dimensions (ft)	Hor. Vel. (ft/s)
Wood Plank	114.6	0.301 × 0.948 × 12	190.2
6” Schedule 40 pipe	286.6	0.551D × 15.02	32.8
1 in. steel rod	8.8	0.0833D × 3	26.3
Utility Pole	1,124	1.125D × 35.04	85.3
12” Schedule 40 pipe	749.6	1.05D × 15.02	23.0

- b. Annual precipitation of 20 inches/year (normal). The spectrum of rainfall is provided in Table 3.3-3 (normal):

**Table 3.3-3 Spectrum of Rainfall**

Parameter and Frequency	Nominal Estimate	Upper Bound 90% Confidence Interval*
Maximum 24-hr precipitation (50-year return period)	2.79 in./day	3.30 in./day
Maximum 24-hr precipitation (100-year return period)	3.23 in./day	3.84 in./day
Maximum 24-hr precipitation (500-year return period)	4.37 in./day	5.25 in./day
Precipitation 1-hr intensity (50-year return period)	1.35 in./hr	1.72 in./hr
Precipitation 1-hr intensity (100-year return period)	1.68 in./hr	2.15 in./hr

\*Use the values for upper bound 90% confidence interval.

- c. Maximum daily snowfall of 6.0 in. (normal)
- d. Maximum monthly snowfall of 6.6 in. (normal)
- e. A lightning strike with a peak current of 250 kiloamps over a period of 260 microseconds and a continuing current of 2 kiloamps for 2 seconds (off-normal).

- (3) Following an impact (with resultant fire) from an F-15 military aircraft into an aging overpack, the TAD canister shall maintain a maximum leak rate of  $9.3 \times 10^{-10}$  fraction of canister free volume per second (off-normal) and maximum cladding temperature 1,058° F (off-normal). The analysis shall assume the following:
  - a. The crash speed is 500 ft/sec.
  - b. Impact orientation analyzed shall be that which results in maximum damage.
  - c. 12,000 lbs of JP-8 fuel.
  - d. F-15 airframe.
  - e. Two engine components of 3,740 lbs. and dimensions of 46.5 inches D × 191 inches each spaced 96 inches apart.
  - f. One (1) M61A1 20-mm cannon mounted internally just off center of axis.
  - g. 1,000 lbs of inert armaments (i.e., dummy bombs) located between the engines.
- (4) The TAD canister in an aging overpack shall be designed to a maximum leakage rate of  $1.5 \times 10^{-12}$  fraction of canister free volume per second<sup>6</sup> (normal) and maximum cladding temperature of 1,058° F (off-normal) following 4 in. of volcanic ash accumulation. The aging overpack may be on a site transporter. The ash fall loads are estimated at 21 lb/ft<sup>2</sup> with a thermal conductivity of 0.11 BTU/hr-ft-° F.
- (5) The aging overpack shall retain the TAD canister following a drop and/or tip-over event.
- (6) The aging overpack top shall have one (1) lift feature in each quadrant to allow for lifting using temporary rigging and portable crane. The lifting features shall be of sufficient size to allow any two (2) to upright and lift a loaded aging overpack.
- (7) For analysis purposes, the aging pad shall be assumed to have the following characteristics:
  - a. 5,000 PSI concrete with a thickness of three feet.
  - b. Concrete surface is a light broom finish.
  - c. Reinforcing steel shall be #11's on 8 in. centers, each direction, top and bottom, standard cover top and bottom, with #5 ties spaced at 2'-0". On the perimeter there are #5 ties spaced at 8" with 2 #11's spaced at 10" on the vertical face of the foundation.
  - d. Soil data is in Attachment E and Attachment F.

### 3.3.3 Thermal

- (1) Aging overpack cooling features and mechanisms shall be passive.



- (2) A loaded aging overpack shall be capable of withstanding a fully engulfing fire without the TAD canister exceeding a leakage rate of  $9.3 \times 10^{-10}$  fraction of canister free volume per second (off-normal) and maximum fuel cladding temperature of 1,058° F (off-normal) under the conditions below.
- a. The resulting fire described in section 3.3.2 (3) (aircraft impact) of this performance specification.
  - b. The fire described in 10 CFR 71.73.c (4) *Hypothetical Accident Condition* requirements as modified below.
    1. The 30-minute period shall be replaced by a period to be determined by calculation of a pool spill fire formed by 100 gallons of diesel fuel.
    2. Additionally, a surrogate fully engulfing fire of duration twice the duration of the pool fire which starts simultaneously with the pool fire and with a steady-state heat release rate of 10 MW shall be used to model the burning rate of all other solid and liquid combustible materials. For this purpose, assume the heat transfer conditions specified in 10 CFR 71.73.c (4). Temperature conditions from this fire shall be consistent with a totally engulfing black body emitting from the 10 MW requirement.
  - c. A loaded aging overpack shall withstand a deflagration blast wave, fuel tank projectiles and incident thermal radiation resulting from the worst case engulfing fire<sup>12</sup> determined in the previous fire protection requirement without the TAD canister exceeding a leakage rate of  $9.3 \times 10^{-10}$  fraction of canister free volume per second (off-normal) and maximum fuel cladding temperature of 1,058° F (off-normal).

#### 3.3.4 Dose and Shielding

When the loaded aging overpack is on the aging pad with its vertical axis in its normal orientation, the combined neutron and gamma contact dose rate on any accessible exterior surface (excluding the underside of the aging overpack) shall not exceed 40 mrem per hour at any location. This is inclusive of air circulation ducts, penetrations and other potential streaming paths on the overpack surface.

#### 3.3.5 Criticality

No criticality requirements beyond those detailed in Section 3.1.5 of this performance specification.

#### 3.3.6 Containment

The aging overpack shall be designed such that following a 3-ft vertical drop or tip over from a 3-ft high site transporter, the TAD canister maximum leak rate is

---

<sup>12</sup> For this analysis, assume the total quantity of fuel shall vaporize into an efficient fuel-air mixture producing an explosive event. Effects of heat generation, fuel tank projectiles and blast wave propagation shall be considered.

$9.3 \times 10^{-10}$  fraction of canister free volume per second (off-normal) under applicable repository environmental conditions. The impacted surface characteristics are as follows:

- (1) 5,000 PSI concrete with a thickness of three feet with a broom finish.
- (2) Reinforcing steel shall be #11's on 8 in. centers, each direction, top and bottom, standard cover top and bottom, with #5 ties spaced at 2'-0". On the perimeter there are #5 ties spaced at 8" with 2 #11's spaced at 10" on the vertical face of the foundation.
- (3) Soil data is in Attachment E and Attachment F.

#### 3.3.7 Operations

- (1) The aging overpack shall be designed to receive, age, and discharge a loaded TAD canister in a vertical orientation.
- (2) The loaded aging overpack shall be transportable on site in a vertical orientation.
- (3) The loaded aging overpack shall be designed to remain in its transport orientation when set down on a flat horizontal surface without use of auxiliary supports.
- (4) The aging overpack shall have a vendor designed fixture(s) such that the loaded aging overpack can be handled via an overhead crane.
- (5) The loaded aging overpack shall be designed to be moved to the aging pad via site transporter using a pair of lift beams (e.g., forklift). A sketch showing the interface is shown in Attachment D.
- (6) The aging overpack shall be capable of being transported by air pallet.

#### 3.3.8 Materials

No material requirements, prohibitions, or restrictions have been identified for the aging overpack.

## 4.0 GLOSSARY

The following section incorporates the definitions and descriptions of major "terms of art" used throughout this document.

**Aging-** Safely placing commercial CSNF in a site-specific overpack on an aging pad for a long period of time (years) for radioactive decay. Radioactive decay results in a cooler waste form to ensure thermal limits can be met. Safely aging

CSNF is an integral part of GROA operations to ensure material has significantly decayed to meet licensed thermal limitations.

**Burnup-** A measure of nuclear reactor fuel consumption expressed either as the percentage of fuel atoms that have undergone fission or as the amount of energy produced per initial unit weight of fuel.

**Canister-** The structure surrounding the waste form that facilitates handling, storage, aging and/or transportation.

1. The canister may provide structural support for intact CSNF, loose rods, non-fuel components and confinement of radionuclides.
2. Canistered waste shall be placed in waste packages prior to emplacement.

**Cladding-** The metallic outer sheath of a fuel rod generally made of a zirconium alloy. It is intended to isolate the fuel from the external environment.

**Design Bases-** That information that identifies the specific functions to be performed by a structure, system, or component of a facility and the specific values or ranges of values chosen for controlling parameters as reference bounds for design. These values may be constraints derived from generally accepted “state-of-the-art” practices for achieving functional goals or requirements derived from analysis (based on calculation or experiments) of the effects of a postulated event under which a structure, system, or component must meet its functional goals. The values for controlling parameters for external events include:

1. Estimates of severe natural events to be used for deriving design bases that will be based on consideration of historical data on the associated parameters, physical data, or analysis of upper limits of the physical processes involved; and,
2. Estimates of severe external human-induced events to be used for deriving design bases, which will be based on analysis of human activity in the region, taking into account the site characteristics and the risks associated with the event.

**Event Sequence-** A series of actions and/or occurrences within the natural and engineered components of a GROA that could potentially lead to exposure of individuals to radiation. An event sequence includes one or more initiating events and associated combinations of repository system component failures, including those produced by the action or inaction of operating personnel. Those event sequences that are expected to occur one or more times before permanent closure of the geologic repository operations area are referred to as Category 1 event sequences. Other event sequences that have at least one chance in 10,000 of occurring before permanent closure are referred to as Category 2 event sequences.

**Fuel assembly-** A number of fuel rods held together by plates and separated by spacers used in a reactor. This assembly is sometimes called a fuel bundle or fuel element.

**Geologic Repository Operations Area (GROA)**- A high-level radioactive waste facility that is part of a geologic repository, including both surface and subsurface areas, where wet handling activities are conducted.

**Hypothetical Accident Conditions**- The sequential conditions and tests defined in 10 CFR part 71 subpart E (Package Approval Standards) and subpart F (Package, Special Form and LSA-III Tests) that a package (or array of packages) must be evaluated against.

**High-Level Radioactive Waste (HLW)**- (1) The highly radioactive material resulting from the reprocessing of spent nuclear fuel, including liquid waste produced directly in reprocessing and any solid material derived from such liquid waste that contains fission products in sufficient concentrations; (2) Irradiated reactor fuel; and (3) Other highly radioactive material that the Commission, consistent with existing law, determines by rule requires permanent isolation.

**Important to Safety**- In reference to structures, systems and components, means those engineered features of the GROA whose function is:

- (1) To provide reasonable assurance that high-level waste can be received, handled, packaged, stored, emplaced, and retrieved without exceeding the requirements of §63.111(b)(1) for Category 1 event sequences; or
- (2) To prevent or mitigate Category 2 event sequences that could result in radiological exposures exceeding the values specified at §63.111(b)(2) to any individual located on or beyond any point on the boundary of the site.

**Important to Waste Isolation**- With reference to design of the engineered barrier system and characterization of natural barriers, means those engineered and natural barriers whose function is to provide a reasonable expectation that high-level waste can be disposed of without exceeding the requirements of 10 CFR 63.113(b) and (c).

**Neutron Absorber**- A material (e.g., boron) that absorbs neutrons used in nuclear reactors, transportation overpacks and waste packages to control neutron multiplication.

**Normal Conditions of Transport**- The conditions and tests defined in 10 CFR part 71 subpart E (Package Approval Standards) and subpart F (Package, Special Form and LSA-III Tests) that all packages must be evaluated against.

**Postclosure**- The period of time after closure of the geologic repository.

**Preclosure**- The period of time before and during closure of the GROA disposal system.

**Site**<sup>1</sup>- An area surrounding the GROA for which the DOE exercises authority over its use in accordance with the provisions of 10 CFR part 63.

**Site<sup>2</sup>**- The owner controlled area defined for a utility under 10 CFR part 50.

**Site Transporter**- A self-powered vehicle designed to haul the TAD canister and contents while within either a shielded transfer cask or aging overpack between GROA surface facilities.

**Shielded Transfer Cask (STC)**- A cask that meets applicable requirements for safe transfer of a TAD canister and its contents between various surface facilities.

**Spent Nuclear Fuel (SNF)**- Fuel withdrawn from a nuclear reactor following irradiation, the constituent elements of which have not been separated by reprocessing.

**Storage**– For the purposes of this specification, the placement, by a licensee of spent nuclear fuel in independent spent fuel storage installations (ISFSI) certified under title 10 CFR part 72.

**TAD System**- The set of components consisting of one or more TAD canisters, transportation overpacks, transportation skids, ancillary equipments, shielded transfer casks, aging overpacks and site transporters used to facilitate handling of CSNF.

**Total Effective Dose Equivalent**- For purposes of assessing doses to workers, the sum of the deep-dose equivalent (for external exposures) and committed effective dose equivalent (for internal exposures).

**Transportation Overpack**- The assembly of components of the packaging intended to retain the radioactive material during transport.

**Trunnion**- Cylindrical protuberance for supporting and/or lifting located on the outside of a container or cask (e.g., waste package, aging overpack, etc.)

**Waste package**- The waste form and any containers, shielding, packing and other absorbent materials immediately surrounding an individual waste container.

**PAGE INTENTIONALLY  
LEFT BLANK**

# **Attachment A**

## **Seismic Data for Yucca Mountain Geologic Repository Operations Area**

**PAGE INTENTIONALLY  
LEFT BLANK**



**Summary of Seismic Data for Yucca Mountain Surface Facilities**

Table 1. Peak Ground Motions Associated with Ground Motion Categories

Part A: Horizontal Ground Accelerations

Ground Motion Category	Return Period <sup>b</sup> (years)	Horizontal Peak Ground Acceleration <sup>a</sup> (PGA) (g)		DTN
		Surface <sup>c</sup>	Subsurface <sup>d</sup>	
DBGM-1	1,000	0.33	0.12	MO0706DSDR1E3A.000, MO0707DSRB1E3A.000
DBGM-2	2,000	0.45	0.17	MO0706DSDR5E4A.001, MO0707DSRB5E4A.000
BDBGM	10,000	0.91	0.37	MO0706DSDR1E4A.001, MO0707DSRB1E4A.000

Part B: Vertical Ground Accelerations

Ground Motion Category	Return Period <sup>b</sup> (years)	Vertical Peak Ground Acceleration <sup>a</sup> (PGA) (g)		DTN
		Surface <sup>c</sup>	Subsurface <sup>d</sup>	
DBGM-1	1,000	0.22	0.07	MO0706DSDR1E3A.000, MO0707DSRB1E3A.000
DBGM-2	2,000	0.32	0.12	MO0706DSDR5E4A.001, MO0707DSRB5E4A.000
BDBGM	10,000	0.72	0.32	MO0706DSDR1E4A.001, MO0707DSRB1E4A.000

NOTES:

- a) The PGA value is the acceleration at a frequency of 100 Hz (period = 0.01 second).
- b) A return period of 1,000 years equals a mean annual probability of exceedance (MAPE) of  $1.0 \times 10^{-3}$ ; similarly, a return period of 2,000 years equals a MAPE of  $5.0 \times 10^{-4}$  and a return period of 10,000 years equals a MAPE of  $1.0 \times 10^{-4}$ .
- c) Surface values are applicable for the entire Surface Geologic Repository Operations Area. They are determined by enveloping results for 30 ft (9 m), 70 ft (20 m), 100 ft (30 m), and 200 ft (60 m) of alluvium (soil) and for profiles characterizing the seismic velocity to the northeast and south of the Exile Hill fault splay. (*Supplemental Earthquake Ground Motion Input for a Geologic Repository at Yucca Mountain* (BSC 2008, Section 6.5.2))
- d) Subsurface values are applicable for the entire waste emplacement area. They are determined by enveloping results for profiles characterizing the seismic velocity of the waste emplacement area footprint. (*Supplemental Earthquake Ground Motion Input for a Geologic Repository at Yucca Mountain* (BSC 2008, Section 6.5.3))

BDBGM = beyond design basis ground motion; DBGM = design basis ground motion; DTN = document tracking number; g = acceleration due to gravity.

Table 2. Spectral Ground Motions Associated with Ground Motion Categories

Part A: Horizontal Spectral Accelerations

Ground Motion Category	Return Period (years)	Average Horizontal Spectral Accelerations <sup>a</sup> (g)			DTN
		Range	Surface <sup>b</sup>	Subsurface <sup>c</sup>	
DBGM-1	1,000	S <sub>A(1-2)</sub>	0.42	0.18	MO0706DSDR1E3A.000, MO0707DSRB1E3A.000
		S <sub>A(5-10)</sub>	0.81	0.26	
DBGM-2	2,000	S <sub>A(1-2)</sub>	0.61	0.25	MO0706DSDR5E4A.001, MO0707DSRB5E4A.000
		S <sub>A(5-10)</sub>	1.16	0.38	
BDBGM	10,000	S <sub>A(1-2)</sub>	1.29	0.51	MO0706DSDR1E4A.001, MO0707DSRB1E4A.000
		S <sub>A(5-10)</sub>	2.36	0.79	

Part B: Vertical Accelerations

Ground Motion Category	Return Period (years)	Average Vertical Spectral Accelerations <sup>a</sup> (g)			DTN
		Range	Surface <sup>b</sup>	Subsurface <sup>c</sup>	
DBGM-1	1,000	S <sub>A(1-2)</sub>	0.22	0.12	MO0706DSDR1E3A.000, MO0707DSRB1E3A.000
		S <sub>A(5-10)</sub>	0.49	0.14	
DBGM-2	2,000	S <sub>A(1-2)</sub>	0.33	0.17	MO0706DSDR5E4A.001, MO0707DSRB5E4A.000
		S <sub>A(5-10)</sub>	0.74	0.22	
BDBGM	10,000	S <sub>A(1-2)</sub>	0.72	0.36	MO0706DSDR1E4A.001, MO0707DSRB1E4A.000
		S <sub>A(5-10)</sub>	1.84	0.52	

NOTES:

- Spectral accelerations are defined as:  $S_{A(1-2)} = [(SA_1 + SA_2) / 2]$  and  $S_{A(5-10)} = [(SA_5 + SA_{10}) / 2]$ , where SA<sub>1</sub>, SA<sub>2</sub>, SA<sub>5</sub>, and SA<sub>10</sub> are the maximum horizontal spectral accelerations at 1 Hz, 2 Hz, 5 Hz, and 10 Hz, respectively, for 5% damping.
  - Surface values are applicable for the entire Surface Geologic Repository Operations Area. They are determined by enveloping results for 30 ft (9 m), 70 ft (20 m), 100 ft (30 m), and 200 ft (60 m) of alluvium (soil) and for profiles characterizing the seismic velocity to the northeast and south of the Exile Hill fault splay. (*Supplemental Earthquake Ground Motion Input for a Geologic Repository at Yucca Mountain* (BSC 2008, Section 6.5.2))
  - Subsurface values are applicable for the entire waste emplacement area. They are determined by enveloping results for profiles characterizing the seismic velocity of the waste emplacement area footprint. (*Supplemental Earthquake Ground Motion Input for a Geologic Repository at Yucca Mountain* (BSC 2008, Section 6.5.3))
- BDBGM = beyond design basis ground motion; DBGM = design basis ground motion; DTN = document tracking number; g = acceleration due to gravity; SA = spectral acceleration; S<sub>A(X-Y)</sub> = average spectral acceleration for a range, computed as the average of spectral accelerations at frequencies of X and Y.

Table 3. Maximum Horizontal Spectral Accelerations at Surface for 2,000-Year Return Period Seismic Event

Period (sec)	Spectral Acceleration At Different Damping Levels (g)								
	0.5%	1.0%	2.0%	3.0%	5.0%	7.0%	10%	15%	20%
0.010	0.4537	0.4537	0.4537	0.4537	0.4537	0.4537	0.4537	0.4537	0.4537
0.011	0.4700	0.4700	0.4700	0.4700	0.4700	0.4700	0.4700	0.4700	0.4700
0.012	0.4911	0.4911	0.4911	0.4911	0.4911	0.4911	0.4911	0.4911	0.4911
0.014	0.6243	0.5880	0.5517	0.5304	0.5177	0.5161	0.5061	0.4947	0.4866
0.017	0.7699	0.6957	0.6216	0.5782	0.5506	0.5373	0.5207	0.5019	0.4885
0.020	0.9385	0.8214	0.7042	0.6357	0.5905	0.5638	0.5394	0.5118	0.4921
0.025	1.1920	1.0272	0.8110	0.7112	0.6380	0.5960	0.5627	0.5248	0.4979
0.034	1.4115	1.1792	0.9469	0.8110	0.7141	0.6500	0.6031	0.5497	0.5118
0.050	1.8513	1.5327	1.2141	1.0277	0.8330	0.7390	0.6723	0.5966	0.5428
0.100	2.7270	2.2294	1.7318	1.4407	1.1894	1.0267	0.9100	0.7773	0.6832
0.110	2.7243	2.2281	1.7319	1.4417	1.1863	1.0218	0.9032	0.7683	0.6726
0.123	2.7071	2.2160	1.7248	1.4375	1.1784	1.0125	0.8920	0.7550	0.6578
0.142	2.6805	2.1974	1.7142	1.4316	1.1690	1.0019	0.8794	0.7402	0.6414
0.167	2.6424	2.1710	1.6995	1.4238	1.1581	0.9904	0.8659	0.7244	0.6240
0.201	2.5328	2.0876	1.6425	1.3820	1.1201	0.9562	0.8326	0.6921	0.5924
0.248	2.3322	1.9307	1.5291	1.2943	1.0458	0.8916	0.7733	0.6387	0.5432
0.335	2.0462	1.7066	1.3671	1.1685	0.9418	0.8025	0.6926	0.5677	0.4791
0.498	1.6534	1.3951	1.1369	0.9859	0.7945	0.6778	0.5823	0.4738	0.3968
1.000	0.8239	0.7125	0.6011	0.5360	0.4357	0.3746	0.3212	0.2605	0.2175
1.123	0.7157	0.6218	0.5278	0.4729	0.3854	0.3320	0.2849	0.2314	0.1934
1.262	0.6210	0.5420	0.4629	0.4167	0.3407	0.2942	0.2527	0.2055	0.1720
1.417	0.5385	0.4722	0.4059	0.3671	0.3012	0.2607	0.2243	0.1828	0.1534
1.668	0.4306	0.3801	0.3297	0.3002	0.2477	0.2153	0.1856	0.1519	0.1280
2.009	0.3272	0.2912	0.2552	0.2341	0.1947	0.1701	0.1473	0.1213	0.1028

Source: MO0706DSDR5E4A.001. Seismic Design Spectra for the Surface Facilities Area at 5E-4 APE for Multiple Dampings.

NOTES: g = acceleration due to gravity; sec = second.

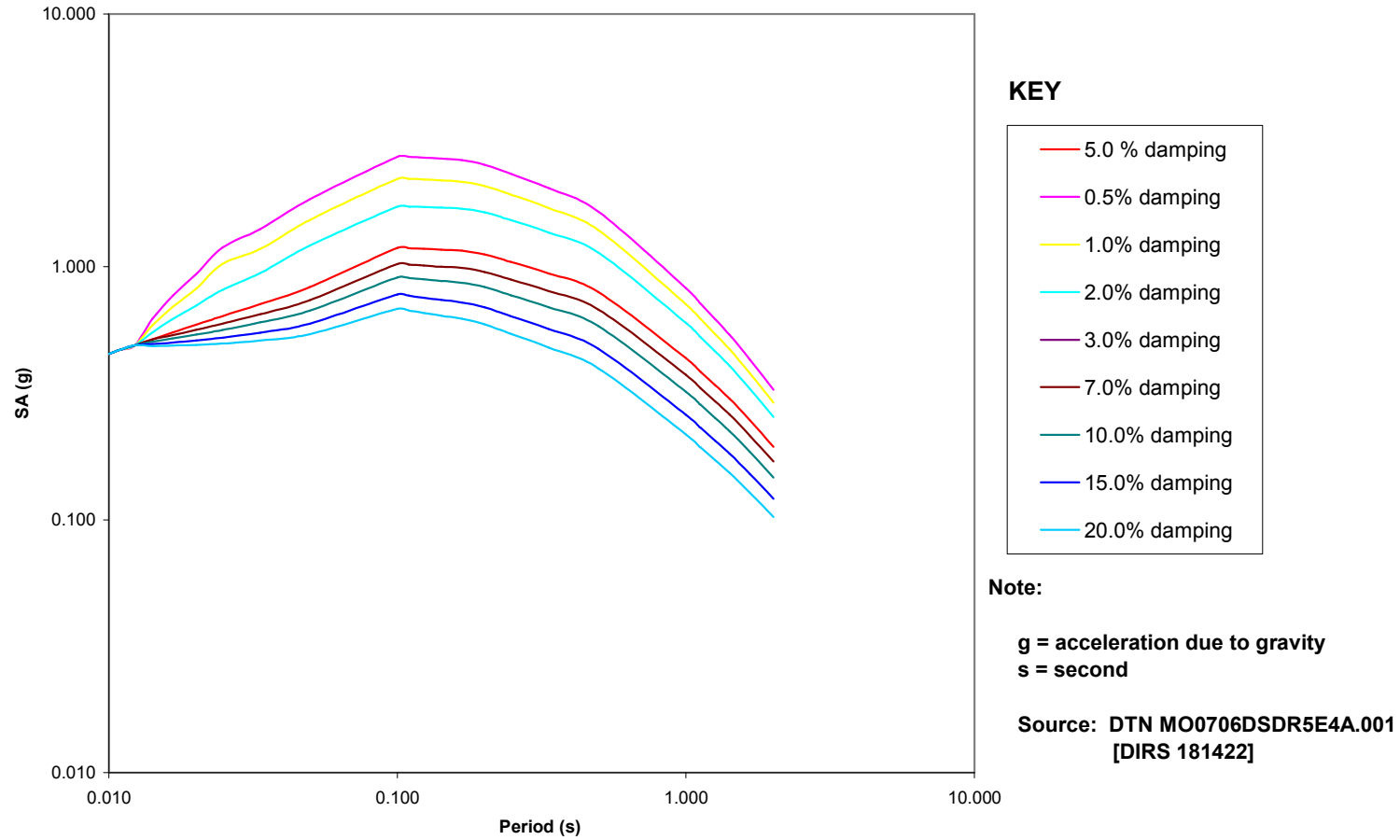


Figure 1 Maximum Horizontal Spectra at Surface for Multiple Damping Levels for 2,000-Year Return Period Seismic Event

Table 4. Vertical Spectral Accelerations at Surface for 2,000-Year Return Period Seismic Event

Period (sec)	Spectral Acceleration At Different Damping Levels (g)								
	0.5%	1.0%	2.0%	3.0%	5.0%	7.0%	10%	15%	20%
0.010	0.3194	0.3194	0.3194	0.3194	0.3194	0.3194	0.3194	0.3194	0.3194
0.011	0.3369	0.3369	0.3369	0.3369	0.3369	0.3369	0.3369	0.3369	0.3369
0.012	0.3600	0.3600	0.3600	0.3600	0.3600	0.3600	0.3600	0.3600	0.3600
0.014	0.4927	0.4563	0.4198	0.3985	0.3892	0.3742	0.3694	0.3639	0.3600
0.017	0.6211	0.5532	0.4853	0.4455	0.4241	0.4004	0.3885	0.3749	0.3653
0.020	0.7777	0.6720	0.5664	0.5046	0.4679	0.4334	0.4129	0.3896	0.3731
0.025	0.9682	0.8178	0.6674	0.5794	0.5235	0.4758	0.4450	0.4100	0.3852
0.034	1.2700	1.0509	0.8317	0.7035	0.6161	0.5473	0.5004	0.4470	0.4091
0.050	1.7219	1.4052	1.0884	0.9032	0.7660	0.6652	0.5941	0.5133	0.4560
0.100	2.0115	1.6335	1.2555	1.0343	0.8454	0.7169	0.6243	0.5189	0.4442
0.110	1.9518	1.5859	1.2200	1.0059	0.8195	0.6937	0.6027	0.4993	0.4259
0.123	1.8683	1.5196	1.1709	0.9669	0.7848	0.6629	0.5746	0.4742	0.4030
0.142	1.7625	1.4359	1.1094	0.9183	0.7425	0.6261	0.5414	0.4451	0.3768
0.167	1.6338	1.3344	1.0350	0.8599	0.6927	0.5833	0.5032	0.4123	0.3477
0.201	1.4899	1.2211	0.9522	0.7950	0.6385	0.5371	0.4625	0.3777	0.3175
0.248	1.3386	1.1022	0.8658	0.7275	0.5830	0.4904	0.4217	0.3435	0.2881
0.335	1.1441	0.9496	0.7550	0.6412	0.5134	0.4323	0.3713	0.3019	0.2527
0.498	0.9133	0.7674	0.6216	0.5362	0.4304	0.3641	0.3128	0.2545	0.2131
1.000	0.4306	0.3714	0.3122	0.2775	0.2261	0.1939	0.1674	0.1373	0.1159
1.123	0.3743	0.3244	0.2745	0.2453	0.2006	0.1726	0.1492	0.1227	0.1039
1.262	0.3265	0.2844	0.2423	0.2177	0.1787	0.1543	0.1336	0.1102	0.0935
1.417	0.2831	0.2478	0.2125	0.1919	0.1583	0.1371	0.1190	0.0985	0.0839
1.668	0.2319	0.2045	0.1771	0.1611	0.1338	0.1166	0.1015	0.0844	0.0723
2.009	0.1828	0.1626	0.1425	0.1307	0.1095	0.0961	0.0841	0.0704	0.0607

Source: MO0706DSDR5E4A.001. Seismic Design Spectra for the Surface Facilities Area at 5E-4 APE for Multiple Dampings.

NOTES: g = acceleration due to gravity; sec = second.

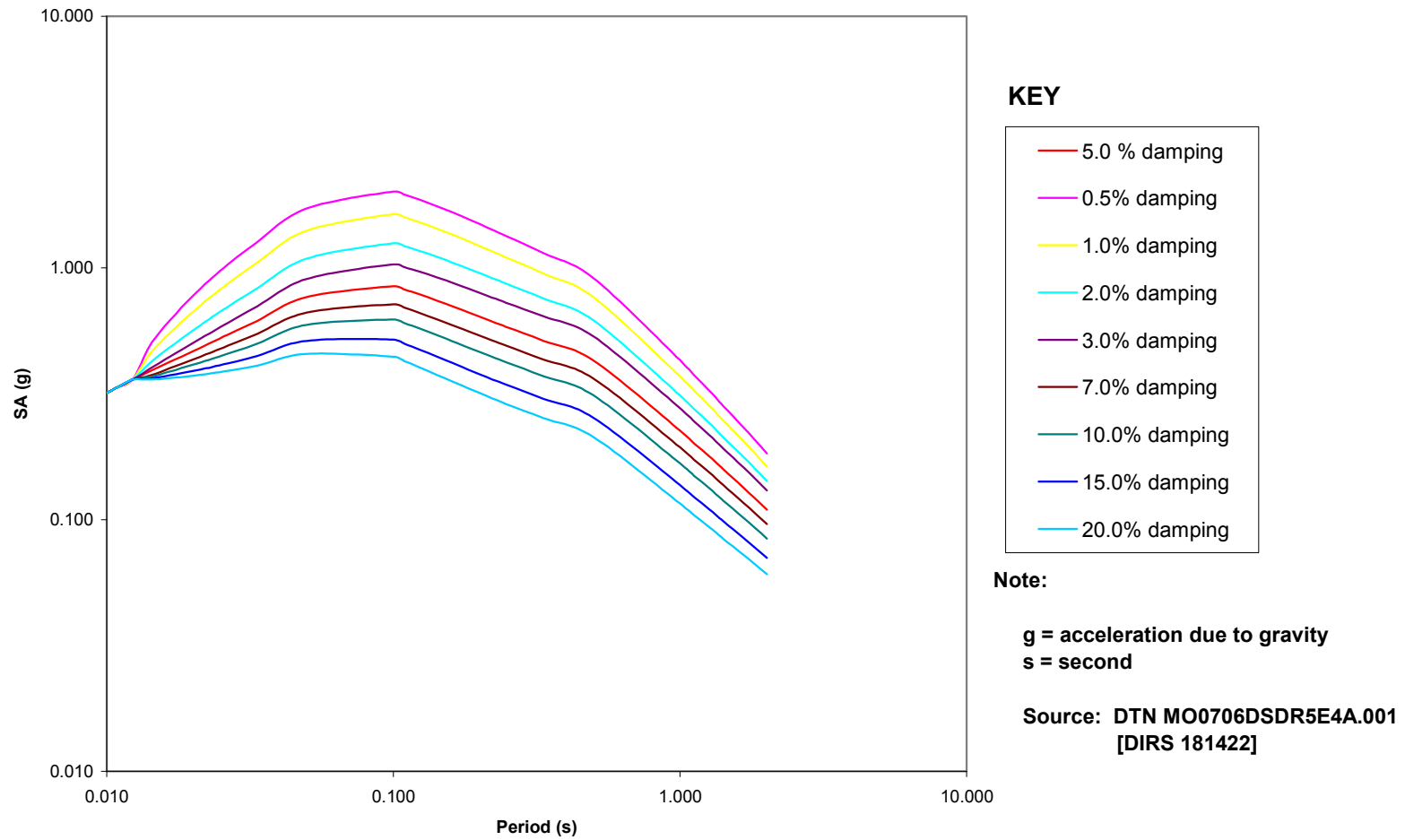


Figure 2. Vertical Spectra at Surface for Multiple Damping Levels for 2,000-Year Return Period Seismic Event

Table 5. Maximum Horizontal Spectral Accelerations at Surface for 10,000-Year Return Period Seismic Event

Period (sec)	Spectral Acceleration At Different Damping Levels (g)								
	0.5%	1.0%	2.0%	3.0%	5.0%	7.0%	10%	15%	20%
0.010	0.9138	0.9138	0.9138	0.9138	0.9138	0.9138	0.9138	0.9138	0.9138
0.011	0.9441	0.9441	0.9441	0.9441	0.9441	0.9441	0.9441	0.9441	0.9441
0.012	0.9853	0.9853	0.9853	0.9853	0.9853	0.9853	0.9853	0.9853	0.9853
0.014	1.2515	1.1787	1.1059	1.0634	1.0378	1.0345	1.0144	0.9916	0.9755
0.017	1.5422	1.3936	1.2451	1.1582	1.1029	1.0763	1.0430	1.0053	0.9784
0.020	1.8782	1.6437	1.4093	1.2722	1.1817	1.1282	1.0795	1.0241	0.9848
0.025	2.3806	2.0515	1.6255	1.4454	1.2742	1.1904	1.1238	1.0481	0.9944
0.034	2.8060	2.3442	1.8824	1.6123	1.4196	1.2922	1.1989	1.0927	1.0174
0.050	3.6495	3.0215	2.3934	2.0260	1.6421	1.4568	1.3254	1.1760	1.0701
0.100	5.5112	4.5055	3.4998	2.9115	2.4037	2.0748	1.8390	1.5709	1.3806
0.110	5.5009	4.4990	3.4972	2.9111	2.3954	2.0633	1.8238	1.5514	1.3582
0.123	5.4692	4.4769	3.4847	2.9042	2.3807	2.0455	1.8021	1.5253	1.3290
0.142	5.4189	4.4421	3.4653	2.8940	2.3632	2.0255	1.7778	1.4963	1.2966
0.167	5.3460	4.3922	3.4384	2.8804	2.3430	2.0037	1.7519	1.4655	1.2624
0.201	5.2461	4.3240	3.4019	2.8625	2.3200	1.9804	1.7245	1.4335	1.2271
0.248	4.8115	3.9831	3.1548	2.6702	2.1576	1.8395	1.5953	1.3177	1.1208
0.335	4.2016	3.5044	2.8072	2.3994	1.9339	1.6479	1.4222	1.1657	0.9838
0.498	3.3925	2.8626	2.3328	2.0229	1.6302	1.3908	1.1949	0.9722	0.8142
1.000	1.8092	1.5647	1.3201	1.1770	0.9568	0.8225	0.7053	0.5721	0.4776
1.123	1.5865	1.3782	1.1700	1.0482	0.8543	0.7360	0.6316	0.5129	0.4287
1.262	1.3892	1.2124	1.0357	0.9323	0.7622	0.6581	0.5652	0.4597	0.3848
1.417	1.2107	1.0616	0.9126	0.8254	0.6772	0.5862	0.5042	0.4110	0.3449
1.668	0.9870	0.8713	0.7557	0.6881	0.5678	0.4935	0.4255	0.3483	0.2935
2.009	0.7801	0.6943	0.6084	0.5582	0.4642	0.4056	0.3511	0.2892	0.2452

Source: MO0706DSDR1E4A.001. Seismic Design Spectra for the Surface Facilities Area at 1E-4 APE for Multiple Dampings.

NOTES: g = acceleration due to gravity; sec = second.

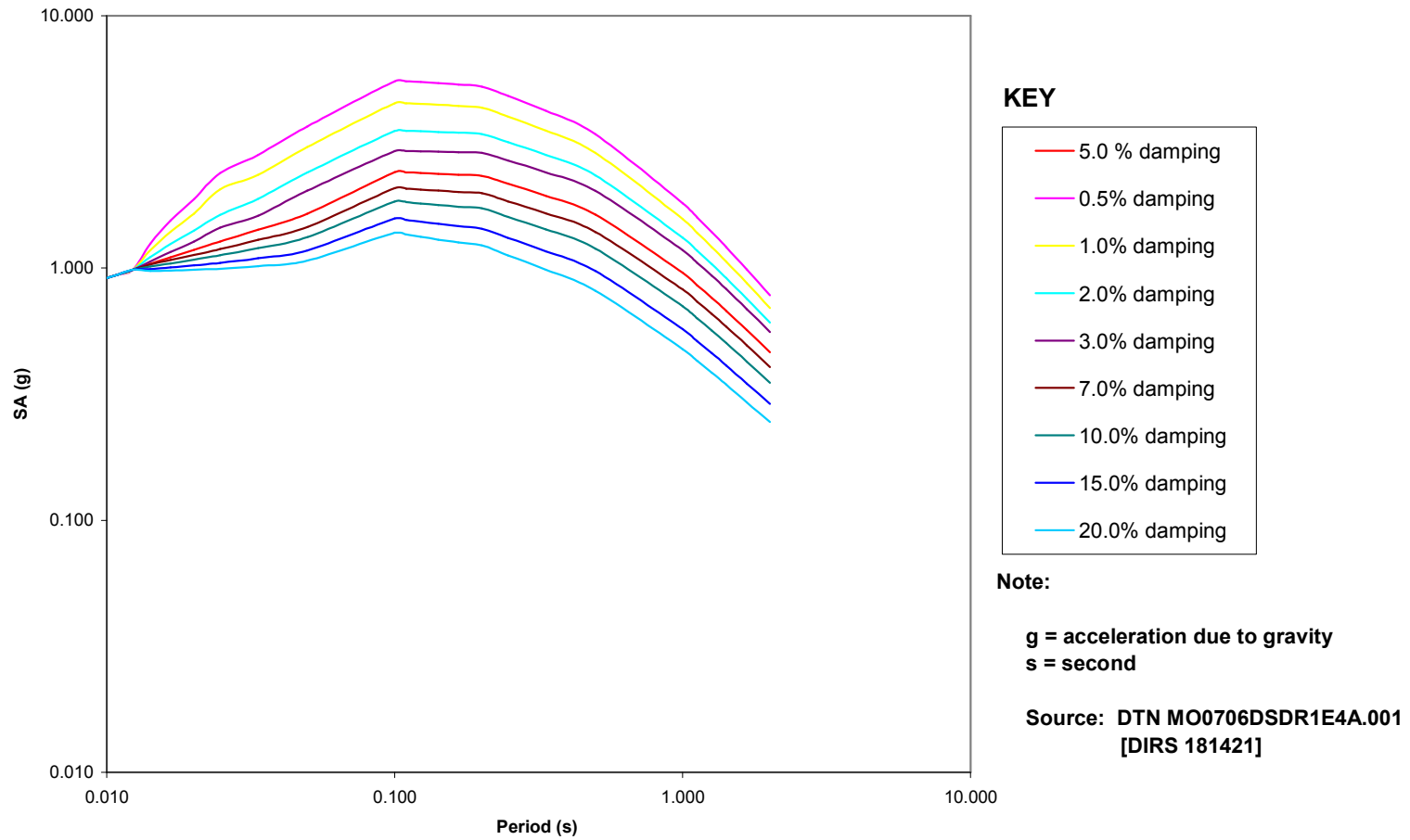


Figure 3. Maximum Horizontal Spectra at Surface for Multiple Damping Levels for 10,000-Year Return Period Seismic Event



Table 6. Vertical Spectral Accelerations at Surface for 10,000-Year Return Period Seismic Event

Period (sec)	Spectral Acceleration At Different Damping Levels (g)								
	0.5%	1.0%	2.0%	3.0%	5.0%	7.0%	10%	15%	20%
0.010	0.7230	0.7230	0.7230	0.7230	0.7230	0.7230	0.7230	0.7230	0.7230
0.011	0.7603	0.7603	0.7603	0.7603	0.7603	0.7603	0.7603	0.7603	0.7603
0.012	0.8130	0.8130	0.8130	0.8130	0.8130	0.8130	0.8130	0.8130	0.8130
0.014	1.1176	1.0349	0.9522	0.9038	0.8828	0.8489	0.8379	0.8255	0.8166
0.017	1.4198	1.2645	1.1092	1.0184	0.9694	0.9153	0.8880	0.8571	0.8351
0.020	1.7872	1.5445	1.3017	1.1597	1.0753	0.9960	0.9489	0.8954	0.8574
0.025	2.2352	1.8880	1.5407	1.3376	1.2086	1.0985	1.0274	0.9466	0.8893
0.034	2.9660	2.4542	1.9423	1.6430	1.4388	1.2782	1.1685	1.0438	0.9554
0.050	4.0145	3.2761	2.5377	2.1057	1.7859	1.5508	1.3851	1.1968	1.0632
0.100	5.2488	4.2624	3.2760	2.6990	2.2060	1.8707	1.6289	1.3541	1.1591
0.110	5.1390	4.1756	3.2121	2.6485	2.1577	1.8263	1.5868	1.3146	1.1214
0.123	4.8179	3.9187	3.0195	2.4935	2.0238	1.7094	1.4817	1.2228	1.0391
0.142	4.3750	3.5644	2.7538	2.2796	1.8431	1.5541	1.3439	1.1049	0.9353
0.167	3.8826	3.1710	2.4595	2.0433	1.6461	1.3860	1.1959	0.9797	0.8263
0.201	3.4108	2.7954	2.1800	1.8200	1.4617	1.2296	1.0588	0.8647	0.7269
0.248	2.9723	2.4474	1.9225	1.6154	1.2945	1.0889	0.9363	0.7627	0.6396
0.335	2.5078	2.0814	1.6549	1.4055	1.1253	0.9476	0.8139	0.6618	0.5539
0.498	1.9565	1.6440	1.3315	1.1487	0.9220	0.7800	0.6701	0.5452	0.4566
1.000	0.9760	0.8418	0.7076	0.6291	0.5125	0.4395	0.3795	0.3112	0.2628
1.123	0.8514	0.7379	0.6244	0.5581	0.4563	0.3926	0.3395	0.2791	0.2363
1.262	0.7404	0.6449	0.5494	0.4935	0.4052	0.3498	0.3030	0.2498	0.2121
1.417	0.6432	0.5631	0.4830	0.4361	0.3597	0.3116	0.2705	0.2238	0.1906
1.668	0.5270	0.4648	0.4025	0.3661	0.3041	0.2649	0.2308	0.1919	0.1643
2.009	0.4134	0.3677	0.3221	0.2954	0.2476	0.2173	0.1901	0.1592	0.1373

Source: MO0706DSDR1E4A.001. Seismic Design Spectra for the Surface Facilities Area at 1E-4 APE for Multiple Dampings.

NOTES: g = acceleration due to gravity; sec = second.

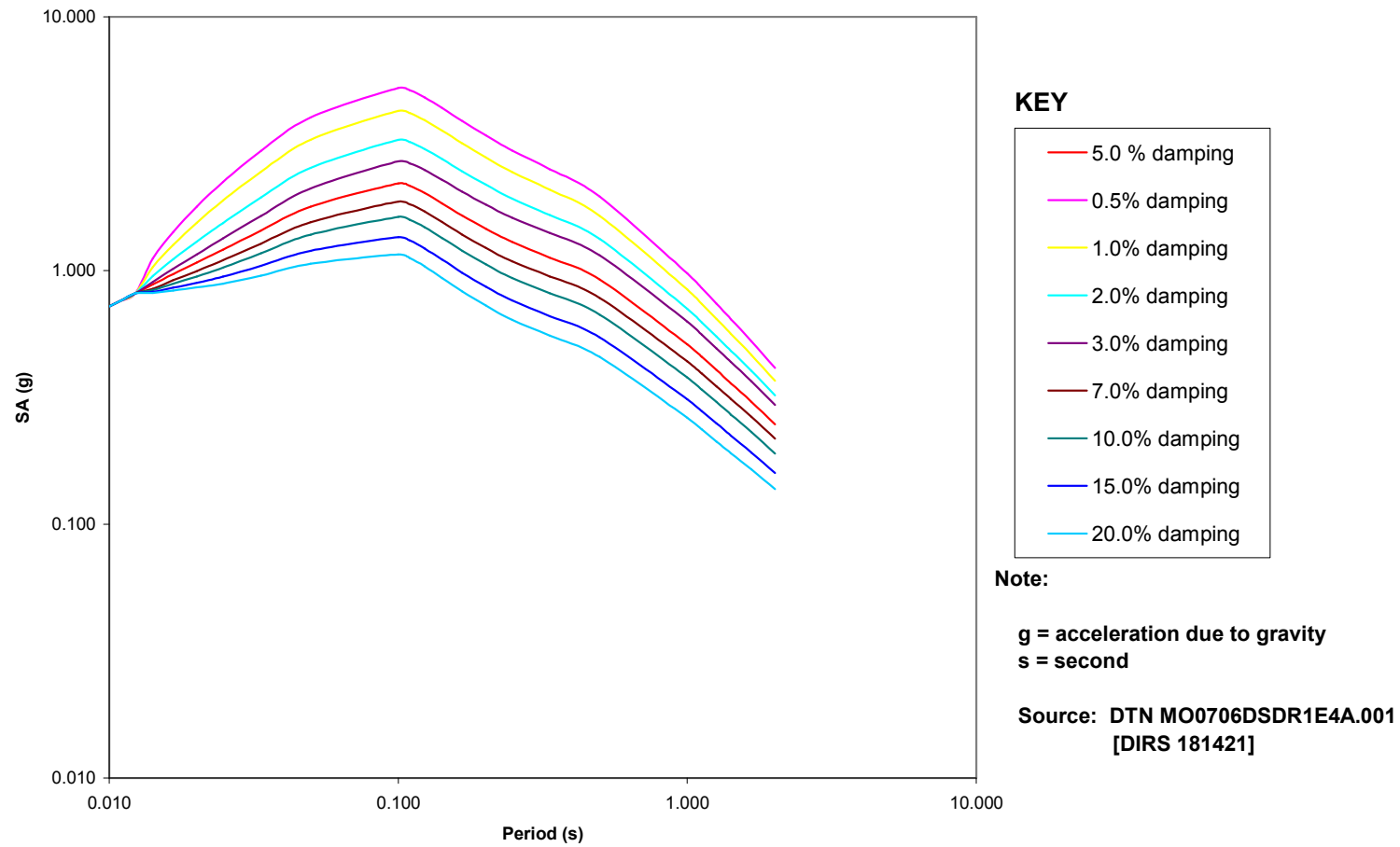
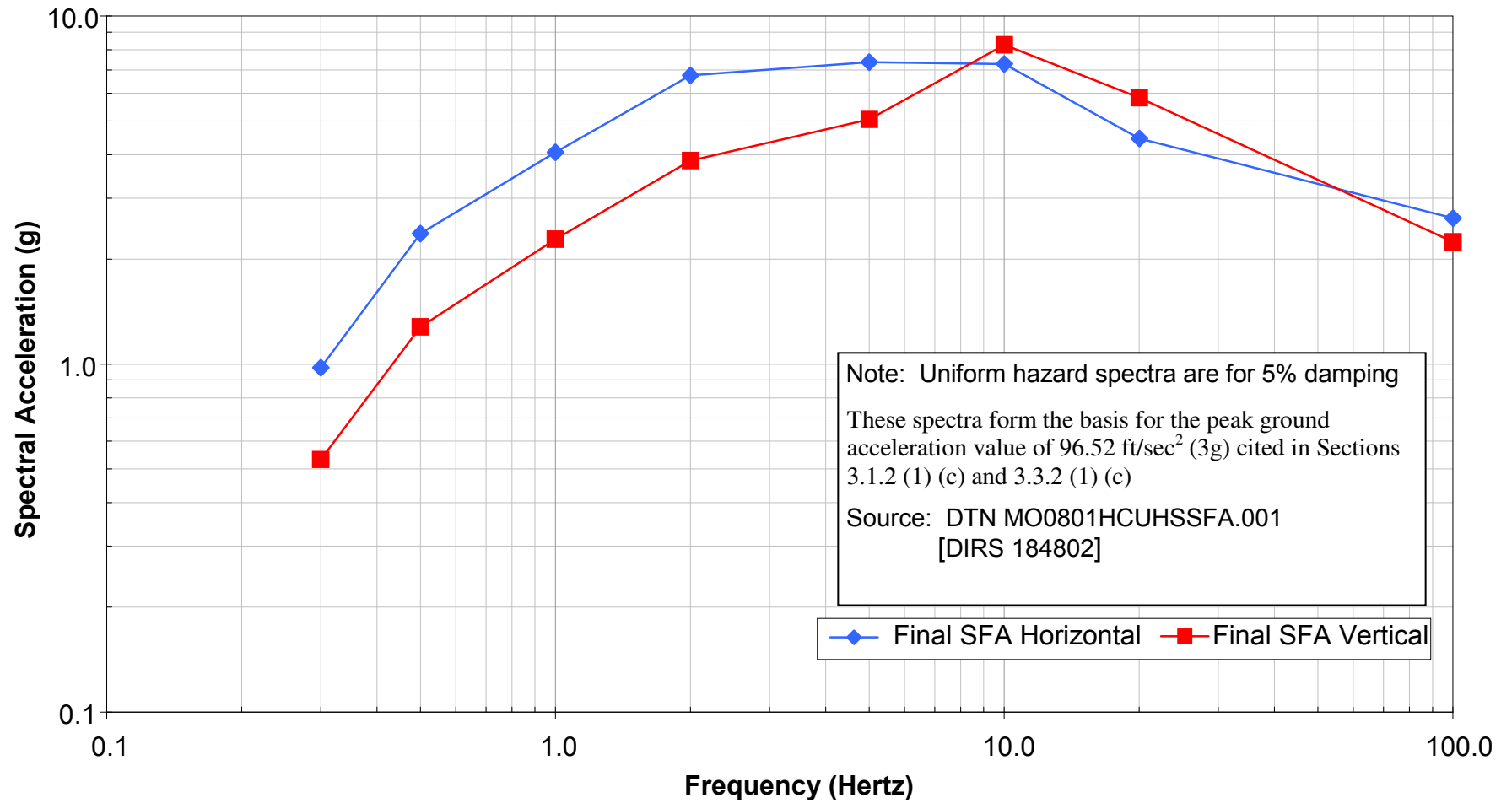


Figure 4. Vertical Spectra at Surface for Multiple Damping Levels for 10,000-Year Return Period Seismic Event

**Uniform Hazard Spectra - Surface Facilities Area (SFA)  
2 X 10<sup>-6</sup> Mean Annual Probability of Exceedance**



**PAGE INTENTIONALLY  
LEFT BLANK**

# **Attachment B**

## **Current Postclosure Criticality Loading Curves**

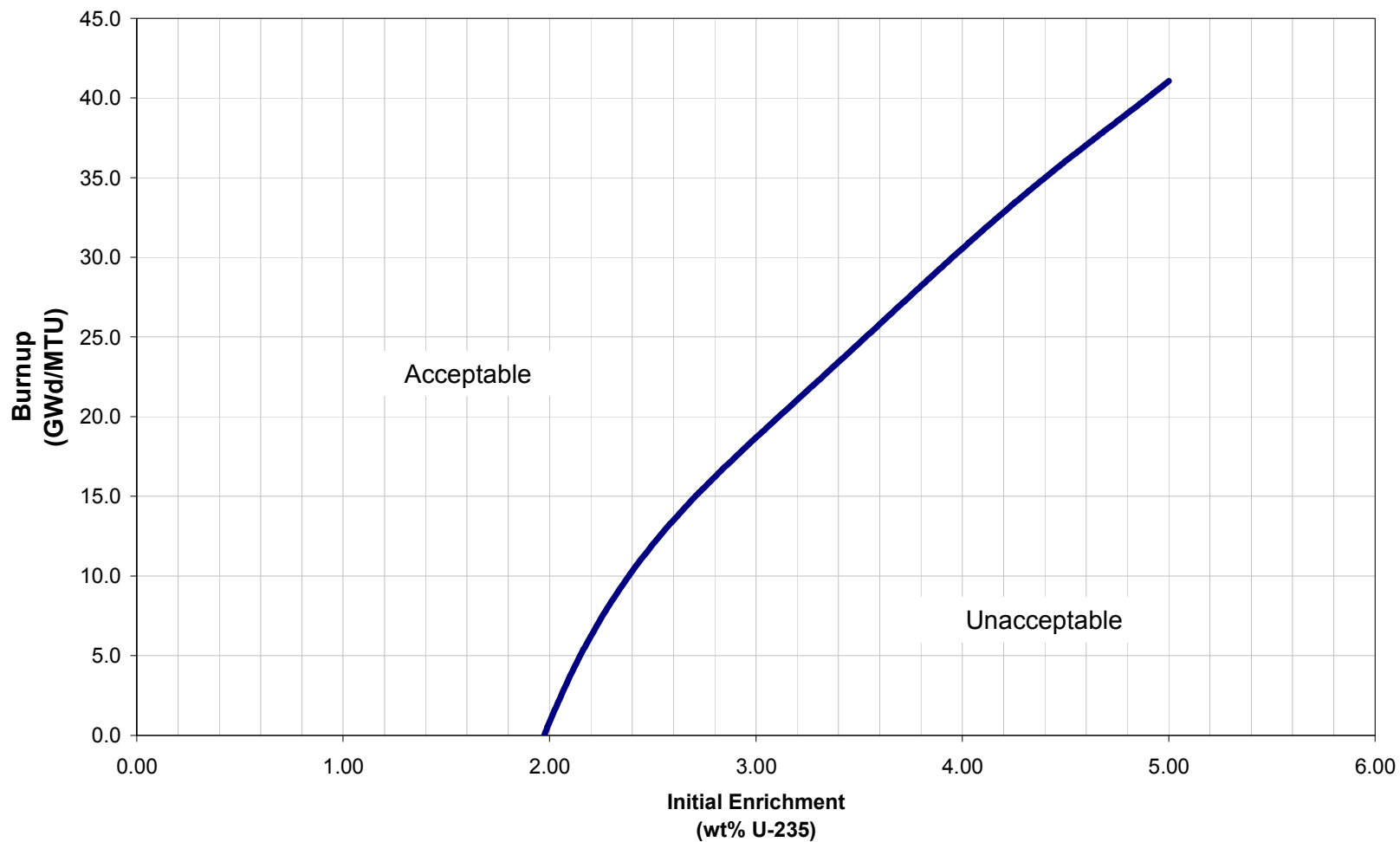
**PAGE INTENTIONALLY  
LEFT BLANK**

The Department of Energy is currently developing finalized PWR and BWR postclosure criticality loading curves. The following PWR and BWR loading curves represent the currently defined TAD configuration and materials baseline as detailed in Section 3.1.5 of this Performance Specification.

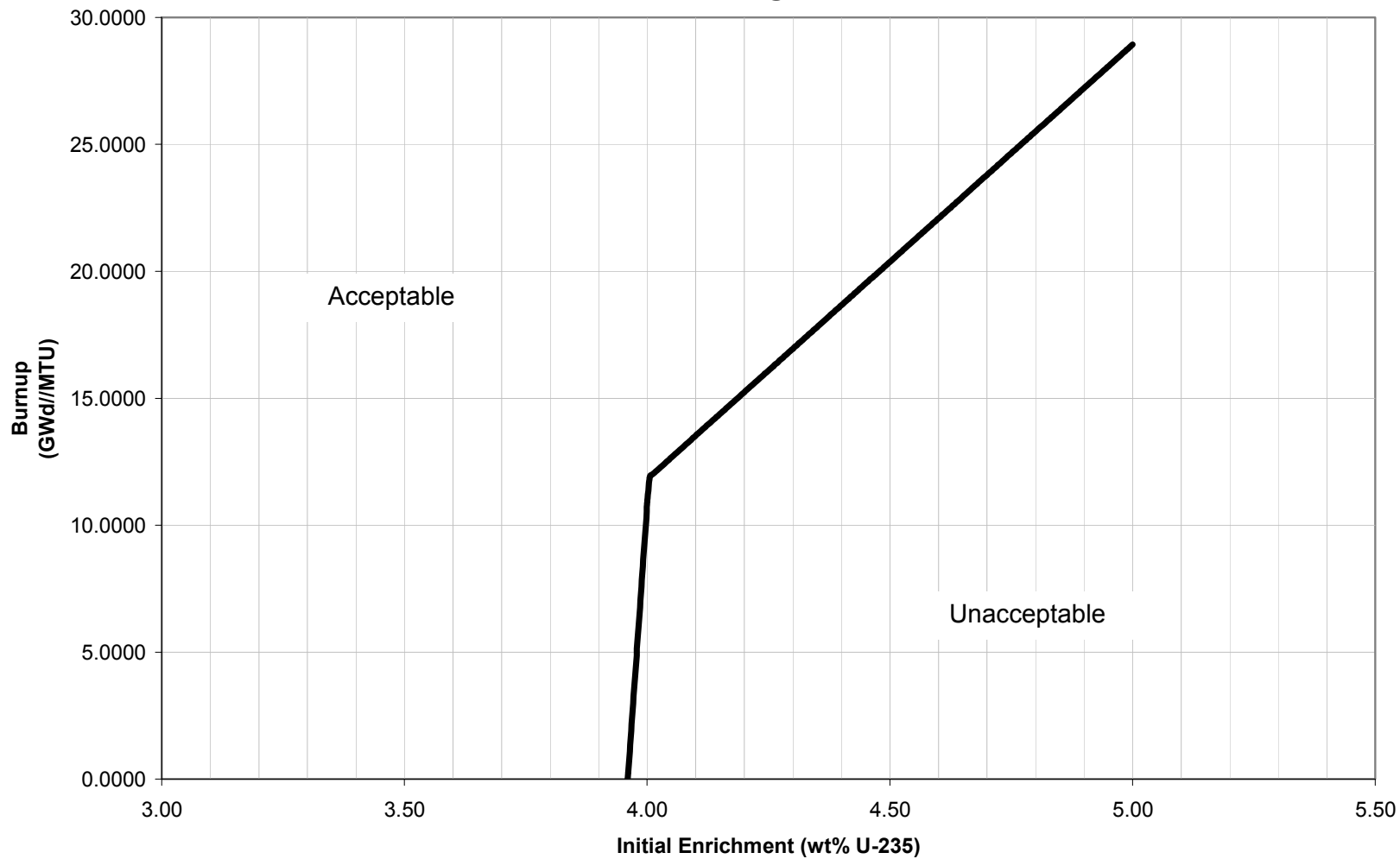
**PAGE INTENTIONALLY  
LEFT BLANK**



### PWR Loading Curve



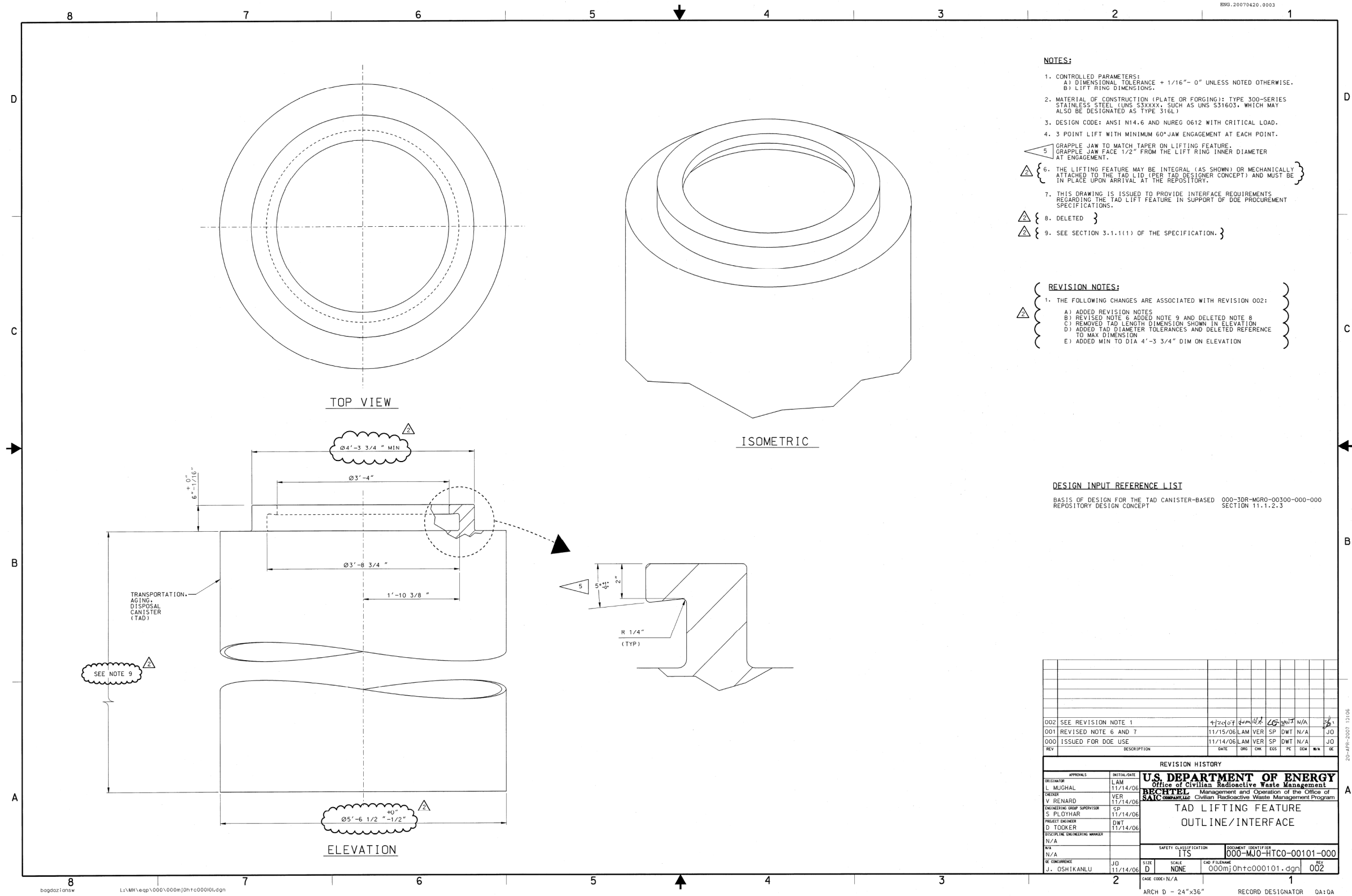
### BWR Loading Curve



# **Attachment C**

## **TAD Canister Lifting Feature**

**PAGE INTENTIONALLY  
LEFT BLANK**



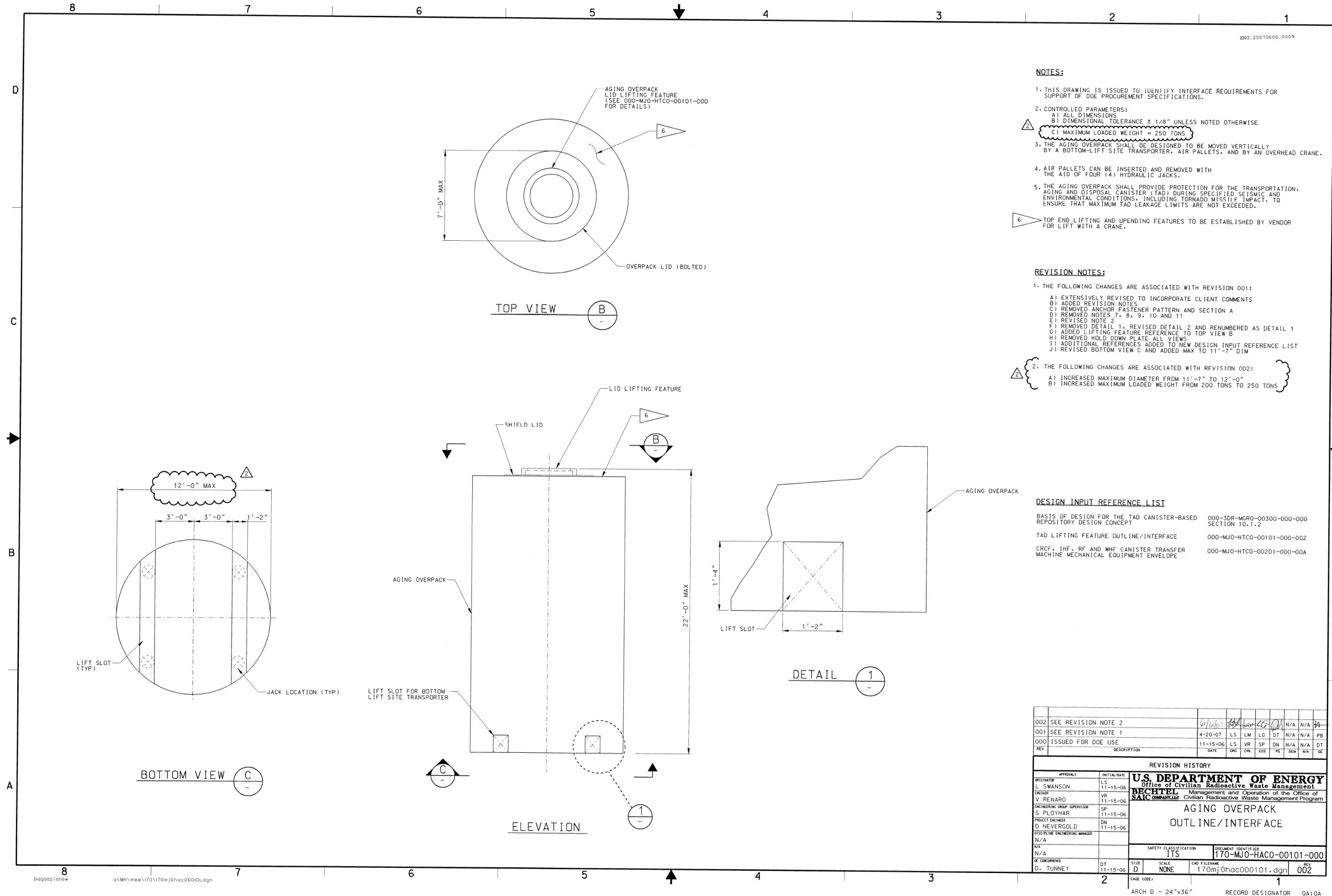
**PAGE INTENTIONALLY  
LEFT BLANK**

# **Attachment D**

## **Aging Overpack Details**

**PAGE INTENTIONALLY  
LEFT BLANK**





**PAGE INTENTIONALLY  
LEFT BLANK**

# **Attachment E**

## **Supplemental Soils Report**

**BSC**

**Design Calculation or Analysis Cover Sheet**

1. QA: QA

Complete only applicable items.

2. Page 1

3. System Subsurface Investigations		4. Document Identifier 100-SOC-CY00-00100-000-00D					
5. Title Supplemental Soils Report							
6. Group Geotechnical (C/S/A)							
7. Document Status Designation <input type="checkbox"/> Preliminary <input checked="" type="checkbox"/> Committed <input type="checkbox"/> Confirmed <input type="checkbox"/> Cancelled/Superseded							
8. Notes/Comments <b>DISCLAIMER</b> - The calculations contained in this document were developed by Bechtel SAIC Company LLC (BSC) and are intended solely for the use of BSC in its work for the Yucca Mountain Project.							
Attachments							Total Number of Pages
Appendix A-Seismic Wave Velocity							57
Appendix B-Bearing Capacity and Settlement							55
Appendix C-Lateral Earth Pressures and Resistance to Lateral Loads							26
RECORD OF REVISIONS							
9. No.	10. Reason For Revision	11. Total # of Pgs.	12. Last Pg. #	13. Originator (Print/Sign/Date)	14. Checker (Print/Sign/Date)	15. EGS (Print/Sign/Date)	16. Approved/Accepted (Print/Sign/Date)
00A	Initial Issue	243	C-26	Peter Chiu 10/27/04	James T. Cameron 10/27/04	---	Farhang Ostadan 11/1/04 R. E. Pernisi 11/4/04
00B	Complete Revision; revised format to conform to EG-DSK-3003; revised contents of 6.4.2.3 (formerly 10.2.3) and 7.1.11 (formerly 11.11) and replaced figure 7-1 (formerly 11-1) to resolve CR5565 concerns. Also addresses issues raised in CR8288 regarding consistency with Ground Motion Report (Section 6.4.2). Note: the layout of the facilities is currently under revision. Even though the exact number and configuration of facilities will change, the design philosophy will continue to use multiple facilities of different sizes located within the North Portal area similar to that shown on Figure 1-1. The calculation will be updated when the layout for the facilities is revised.	255	C-26	James T. Cameron 8/15/06	Nan Deng 8/15/06	---	Farhang Ostadan 8/16/06 Raj S. Rajagopal 8/21/06
00C	Complete Revision; replaced Figs. 1-1 and 6-7; modified Section 7.1.7 and title to Fig 7-1; revised organization of Section 2.	265	C-26	James T. Cameron 2/21/07	Nan Deng 2/21/07	Richard Kotas	Farhang Ostadan 2/22/07 Raj S. Rajagopal 2/22/07
00D	Complete Revision: Replaced Figure 1-1. Added discussion in Section 1.3 regarding revised building layout. Added references, tables and figures in Section 6 regarding additional field and laboratory studies done in 2005 and 2006. Modified App. C to reflect revised building dimensions. Added to Section 7.1.9, Percolation Rates. Modified Tables 2-1 and 2-2 to reflect revised design parameters. Modified Section 3.2 to alert to additional assumptions not requiring verification in Appendices B and C.	272 276 1/3/2008	C-26	James T. Cameron <i>JTC</i> 12/17/07	Nan Deng <i>Nan Deng</i> 12/18/07	JAMES DOCKERY <i>J. Dockery</i> 12/20/07	Farhang Ostadan <i>F. Ostadan</i> 12/18/07 Raj Rajagopal <i>Raj Rajagopal</i> 12/20/07

**CONTENTS**

1	PURPOSE .....	16
1.1	PURPOSE .....	16
1.2	SCOPE .....	16
1.3	PROJECT DESCRIPTION .....	16
1.4	LIMITATIONS .....	19
2	REFERENCES .....	19
2.1	PROCEDURES/DIRECTIVES .....	19
2.2	DESIGN INPUTS .....	20
2.2.1	Input Documents .....	20
2.2.2	Standards .....	25
2.2.3	Data Tracking Numbers .....	26
2.2.4	Drawings .....	29
2.3	DESIGN CONSTRAINTS .....	29
2.4	DESIGN OUTPUTS .....	29
3	ASSUMPTIONS .....	35
3.1	ASSUMPTIONS REQUIRING VERIFICATION .....	35
3.2	ASSUMPTIONS NOT REQUIRING VERIFICATION .....	35
4	METHODOLOGY .....	35
4.1	QUALITY ASSURANCE .....	35
4.2	USE OF SOFTWARE .....	35
4.3	CALCULATION APPROACH .....	36
4.4	DESIGN CRITERIA .....	36
5	LIST OF ATTACHMENTS .....	36
5.1	APPENDICES .....	36
6	BODY OF CALCULATION .....	37
6.1	SITE DESCRIPTION .....	37
6.1.1	Location .....	37
6.1.2	Summary of Site Geology .....	39
6.1.3	Existing Conditions and Surface Features .....	40
6.1.4	Subsurface Conditions .....	40
6.2	FIELD EXPLORATION AND TESTING .....	47
6.2.1	Field Exploration .....	47
6.2.2	Field Tests .....	59
6.3	LABORATORY TESTING .....	64
6.3.1	Static Testing .....	65
6.3.2	Dynamic Testing .....	68
6.4	MATERIAL PROPERTIES .....	69
6.4.1	Static Soil Properties .....	69
6.4.2	Dynamic Soil Properties .....	77

6.4.3	Roller Compacted Soil Cement.....	107
7	RESULTS AND CONCLUSIONS.....	109
7.1	ENGINEERING DESIGN PARAMETERS.....	109
7.1.1	Material Properties .....	110
7.1.2	Foundation Pressures.....	110
7.1.3	Settlement.....	110
7.1.4	Coefficient of Subgrade Reaction and Equivalent Soil Springs .....	111
7.1.5	Lateral Earth Pressures.....	112
7.1.6	Resistance to Lateral Loads.....	113
7.1.7	Slope Considerations.....	113
7.1.8	Pavements.....	115
7.1.9	Percolation Rates.....	115
7.1.10	2000 International Building Code (IBC) Soil Type.....	116
7.1.11	Frost Penetration .....	116
7.1.12	Liquefaction Potential .....	116
7.2	CONSTRUCTION CONSIDERATIONS .....	133
7.2.1	Stripping and Site Preparation.....	133
7.2.2	Foundations .....	133
7.2.3	Excavation, Backfill and Temporary Shoring.....	133
7.2.4	Excavations for Underground Utilities .....	134
7.2.5	Temporary and Permanent Slopes.....	134
7.2.6	Compaction .....	134
7.2.7	Suitability of On-site Materials.....	135
7.2.8	Concrete Aggregates .....	135
7.2.9	Volume Coefficients .....	135
7.2.10	Surface and Storm Water Drainage.....	135
7.2.11	Septic System Drain Field.....	136
7.2.12	Wet Weather Construction .....	136
7.2.13	Dewatering .....	136
7.3	ADDITIONAL INVESTIGATIONS/TESTING.....	136
7.3.1	Test Pits and Geologic Reconnaissance .....	136
7.3.2	Borings .....	136
7.3.3	Laboratory Testing .....	137
7.3.4	CBR Testing.....	137
7.3.5	Field Plate Load Tests.....	137
7.3.6	Resistivity Testing.....	137
7.3.7	Aggregate Testing .....	137
7.3.8	Ballast Testing.....	137
7.3.9	Chemical Testing.....	137
7.3.10	Test Fill Program.....	137
7.3.11	Pavement Design.....	138

## LIST OF FIGURES

Figure 1-1.	Location Map Showing Geotechnical Boreholes from pre-2005, 2005, and 2006 to 2007 Drilling Programs (TDR-MGR-GE-000010 Rev. 00C).....	18
Figure 6-1.	Site Vicinity Map (Figure 1-1 from CRWMS M&O 1999). .....	38
Figure 6-2.	Generalized Map of the Midway Valley area. (Fig. 1-1 from Gibson et al. 1992). 39	39
Figure 6-3.	Elevation Contours for Top-of-Bedrock Encountered in Boreholes (Figure 232 of BSC 2002a).....	42
Figure 6-4.	Surface Facilities Area Geologic Cross Section A-A'. (Figure 225 of BSC 2002a and Assumption 6 of BSC 2002a, DTN:MO0008GSC00286.000—see Figure 6-7 for the location of the cross-section) .....	44
Figure 6-5.	Surface Facilities Area Geologic Cross Section B-B'. (Figure 226 of BSC 2002a, DTN:MO0008GSC00286.000—see Figure 6-7 for the location of the cross-section) 45	45
Figure 6-6.	Sketch of Stratigraphy Underlying Typical Surface Facility (not to scale). .....	46
Figure 6-7.	Locations of Soil Exploration in the surface facilities area (only pre-2005 borings shown). Cross-Sections shown in Figure 6-4, Figure 6-5, and Figure 7-1. ....	53
Figure 6-8.	Locations of Borings in Surface Facilities Area with respect to Building Footprints (DTNs: GS030783114233.001, GS070583114233.002, GS070683114233.005, MO0707RFGNDMV1.000, MO0708SMFGLGIB.000). ....	54
Figure 6-9.	Depth to Rock in Building Area (DTNs: GS030783114233.001, GS070583114233.002, GS070683114233.005, MO0707RFGNDMV1.000, MO0708SMFGLGIB.000).....	55
Figure 6-10.	Depth of Fill Encountered in Building Area (DTNs: GS030783114233.001, GS070583114233.002, GS070683114233.005, MO0707RFGNDMV1.000, MO0708SMFGLGIB.000).....	56
Figure 6-11.	Locations of Test Pits in Surface Facilities Area with respect to Building Footprints (DTNs: GS020383114233.001, GS070583114233.003).....	57
Figure 6-12.	Location of Fran Ridge Borrow Samples (DTN: MO0112GSC01170.000) .....	58
Figure 6-13.	Locations of SASW lines at the surface facilities site [only pre-2004 lines shown]. (Figure 43 of BSC 2002a) .....	64
Figure 6-14.	Particle-Size Distribution Curves for Alluvium for TP-WHB-1 to TP-WHB-4 (DTN: GS020483114233.004 and GS020783114233.005).....	71
Figure 6-15.	Particle-Size Distribution Curves for Alluvium for TP-WHB-5 to TP-WHB-7 (DTN: GS070683114233.004).....	71

Figure 6-16. Particle-Size Distribution Curves for Sonic Borings RF-47 and RF-52 (DTN: GS070483114233.001) .....	72
Figure 6-17. Strength envelopes fitted to triaxial tests on engineered fill. (DTN: MO0203EBSCTCTS.016) .....	76
Figure 6-18. Statistical analyses of shear-wave velocities from downhole measurements in the surface facilities area. (Figure 22 of BSC 2002a) .....	79
Figure 6-19. Shear wave velocity by depth interval from receiver to receiver interval suspension surveys in surface facilities area. (Figure 30 of BSC 2002a, DTN: MO02045FTDSUSP.001).....	80
Figure 6-20. Shear wave velocity by depth interval from source to receiver interval suspension surveys in surface facilities area. (Figure 31 of BSC 2002a, DTN: MO02045FTDSUSP.001).....	81
Figure 6-21. Shear wave velocity from SASW measurements in the surface facilities area. (Figure 91 of BSC 2002a).....	82
Figure 6-22. Compression wave velocity by depth interval from source to receiver interval suspension surveys in surface facilities area. (Figure 34 of BSC 2002a, DTN: MO02045FTDSUSP.001).....	83
Figure 6-23. Compression-wave velocities from downhole measurements in the surface facilities area. (Figure 23 of BSC 2002a).....	84
Figure 6-24. WHB showing location and upthrown and downthrown sides of Exile Hill Fault Splay. (Figure 6.2-89 from BSC 2004a).....	85
Figure 6-25. Shear-wave velocities for alluvium layer from downhole, SASW, and suspension surveys. ....	87
Figure 6-26. Compression-wave velocities for alluvium layer from downhole and suspension surveys. 88	
Figure 6-27. Base Case shear wave velocity profile for alluvium in the surface facilities area–upthrown side. (Figure 6.2-121 from BSC 2004a).....	89
Figure 6-28. Base Case compression wave velocity profile for alluvium in the surface facilities area–upthrown side. (Figure 6.2-122 from BSC 2004a).....	90
Figure 6-29. Base Case shear wave velocity profile for alluvium in the surface facilities area–downthrown side. (Figure 6.3-176 from BSC 2004a).....	91
Figure 6-30. Base Case compression wave velocity profile for alluvium in the surface facilities area–downthrown side. (Figure 6.3-179 from BSC 2004a).....	92
Figure 6-31. Comparison of simple averaging (Appendix A) and Base Case (2004a downthrown side) shear wave velocity profiles for alluvium in the surface facilities area	93
Figure 6-32. Base Case shear wave velocity profile for tuff in the surface facilities area–upthrown block. (Figure 6.2-119 from BSC 2004a).....	95



Figure 6-33.	Base Case compression wave velocity profile for tuff in the surface facilities area–upthrown block. (Figure 6.2-120 from BSC 2004a) .....	96
Figure 6-34.	Base Case shear wave velocity profile for alluvium and tuff in the surface facilities area–downthrown block. (Figure 6.3-177 from BSC 2004a).....	97
Figure 6-35.	Base Case compression wave velocity profiles for alluvium and tuff in the surface facilities area–downthrown block. (Figure 6.3-180 from BSC 2004a) .....	98
Figure 6-36.	Normalized shear modulus and damping ratio for alluvium. (Figure 6.2-147 of BSC 2004a) .....	102
Figure 6-37.	Normalized shear modulus and damping ratio for bedrock. (Figure 6.2-139 of BSC 2004a) .....	104
Figure 6-38.	Normalized shear modulus for engineered fill from Fran Ridge Borrow Area. (Figure 221 of BSC 2002a, DTN: MO0203DHRSSWHB.001) .....	106
Figure 6-39.	Material damping ratio for engineered fill from Fran Ridge Borrow Area. (Figure 222 of BSC 2002a, DTN: MO0203DHRSSWHB.001) .....	106
Figure 6-40.	Normalized shear modulus reduction curves for cement treated soils.....	108
Figure 6-41.	Damping ratio degradation curves for cement treated soils.....	109
Figure 7-1.	WHB Area Geologic Cross Section E-E’, looking South.....	114
Figure 7-2.	Allowable foundation pressure for square and strip footings on alluvium vs. foundation width and foundation embedment (1-inch design settlement).....	117
Figure 7-3.	Allowable foundation pressure for square and strip footings on alluvium vs. foundation width and foundation embedment (½-inch design settlement).....	118
Figure 7-4.	Immediate settlements for different widths of square and strip footings on alluvium vs. foundation pressure ( $d_f = 2$ ft).....	119
Figure 7-5.	Immediate settlements for different widths of square and strip footings on alluvium vs. foundation pressure ( $d_f = 6$ ft).....	120
Figure 7-6.	Long-term settlements for square and strip footings and different depths of foundation embedment.....	121
Figure 7-7.	Lateral earth pressures for yielding walls .....	122
Figure 7-8.	Surcharge loading for yielding walls (not drawn to scale, USN 1986) .....	123
Figure 7-9.	Surcharge loading for yielding walls, continued (not drawn to scale, USN 1986)	125
Figure 7-10.	Lateral earth pressures for non-yielding walls.....	126
Figure 7-11.	Compactor-induced pressures from roller compactor (Compactor model: Dynapac CA15D).....	127

Figure 7-12.	Compactor-induced pressures from roller compactor (Compactor model: Dynapac CA25).....	128
Figure 7-13.	Compactor-induced pressures from roller compactor (Ingersoll-Rand DX-70).	129
Figure 7-14.	Compactor-induced pressures from plate compactor (Bomag BP30).....	130
Figure 7-15.	Compactor-induced pressures from plate compactor (Wacker BS 62Y).....	131
Figure 7-16.	Extreme frost penetration (inches) at the North Portal Area (Figure III-1 BSC 2002b).	132

**LIST OF TABLES**

Table 1-1	Summary of Planned Buildings .....	17
Table 2-1.	Recommended Material Parameters .....	30
Table 2-2.	Summary of Recommended Surface Facilities Foundation Design Parameters	32
Table 6-1.	Boring Information in Surface Facilities Area.....	49
Table 6-2.	Test Pit and Trench Information in surface facilities area. ....	51
Table 6-3.	Test Standards Used for In-Situ Density Testing.....	59
Table 6-4.	References of Seismic Survey Procedures.....	60
Table 6-5.	Comparison of Downhole Seismic, Suspension Seismic and SASW Methods (Table 31 of BSC 2002a) .....	62
Table 6-6.	Seismic Velocity Survey Summary .....	63
Table 6-7.	Laboratory Tests and Standards Conducted on Alluvium. ....	66
Table 6-8.	Laboratory Tests and Standards Conducted on Engineered Fill Material. ....	67
Table 6-9.	Standard and Reference Used for Dynamic Testing.....	68
Table 6-10.	Results from Tests Performed on Alluvial Samples at Surface Facilities Area (DTNs: GS020483114233.004, GS070483114233.001). ....	70
Table 6-11.	Results from Tests Performed in Denver, CO, on a Composite Sample of Fran Ridge Borrow Materials (Table 27 of BSC 2002a, DTN: MO0206EBSFRBLT.018). ...	75
Table 6-12.	Mean Values of Soil Density from Borehole Geophysical Surveys (adopted from Table 12 of BSC 2002a). ....	100

## ACRONYMS AND ABBREVIATIONS

ACC	Accession Number
ACI	American Concrete Institute
ASCE	American Society of Civil Engineers
ASTM	American Society for Testing and Materials
BSC	Bechtel SAIC Company
c	cohesion
$C_c$	coefficient of curvature
CCCF	Central Control Center Facility
CF	finer content
CPT	Cone penetrometer test
CRCF	Canister Receipt and Closure Facility
CRWMS	Civilian Radioactive Waste Management System
$C_u$	coefficient of uniformity
$D_{10}$	grain diameter (in mm) corresponding to 10% passing, by weight (or mass)
$D_{30}$	grain diameter (in mm) corresponding to 30% passing, by weight (or mass)
$D_{60}$	grain diameter (in mm) corresponding to 60% passing, by weight (or mass)
DIRS	Document Input Reference System
DOE	U.S. Department of Energy
DTN	Data Tracking Number
E	Young's modulus or secant Young's modulus
elev.	elevation
EMWB	Equipment Maintenance/Warehouse Building
EPRI	Electrical Power Research Institute
Eq.	equation
ESF	Exploratory Studies Facility
Fpm	feet per minute
fps	feet per second
ft	foot, feet (unit of measurement)
ft/s	feet per second
ft <sup>2</sup>	feet squared
ft <sup>3</sup>	feet cubed
G	shear modulus
$G_{max}$	small-strain (maximum) shear modulus
GP	poorly-graded gravels or gravel-sand mixtures, little or no fines
GSF	Ground Surface Facility
GW	well-graded gravels or gravel-sand mixtures, little or no fines
HEMF	Heavy Equipment Maintenance Facility

### ACRONYMS AND ABBREVIATIONS (CONTINUED)

ICC	International Code Council
ID	identification
IHF	Initial Handling Facility
in.	inch, inches
$K_A$	coefficient of active earth pressure
$K_P$	coefficient of passive earth pressure
kip	1,000 pounds (kilopound)
kip/ft <sup>2</sup>	kips per square foot
kip/ft <sup>3</sup>	kips per cubic foot
$K_o$	coefficient of at-rest soil pressure
Kcf	kips per cubic foot
ksf	kips per square foot
lb/ft <sup>2</sup>	pounds per square foot
lb/ft <sup>3</sup>	pounds per cubic foot
lb	pounds (usually pounds-force)
LL	liquid limit
mm	millimeter
M&O	Management and Operating Contractor
MWV	Midway Valley
N	SPT penetration resistance (blow count)
$N_{60}$	SPT penetration resistance corrected to 60% efficiency
NNWSI	Nevada Nuclear Waste Site Investigation
NRC	National Regulatory Commission
NRG	North Ramp Geotechnical
NRSF	North Ramp Surface Facilities
p	page
pcf	pounds per cubic foot
PI	plasticity index
pp	pages
psf	pounds per square foot
psi	pounds per square inch
“Q”	“quality”
QA	quality assurance
Qal	Quaternary alluvium

### ACRONYMS AND ABBREVIATIONS (CONTINUED)

RCSC	roller compacted soil cement
RCTS	Resonant Column & Torsional Shear
Rev.	revision
REV.	revision
RF	Repository Facility
RF	Receipt Facility
SASW	spectral analysis of surface waves
SFS	Surface Facility System
SM	silty sands, sand-silt mixtures
SN	Scientific Notebook
SP	poorly-graded sand or gravelly sands, little or no fines
SPT	Standard Penetration Test
SW	well-graded sand or gravelly sands, little or no fines
tcf	tons (American) per cubic foot
TIC	Technical Information Center
Tmbtl	pre-Rainier Mesa Tuff bedded tuff
Tmr	Rainier Mesa Tuff of the Timber Mountain Group
tons/ft <sup>3</sup>	tons (American) per cubic foot
Tpbt5	pre-Tuff unit "x" bedded tuffs (also known as post-Tiva Canyon Tuff bedded tuffs)
Tpcpll	Tiva Canyon Tuff: crystal-poor member, lower lithophysal zone
Tpcpln	Tiva Canyon Tuff: crystal-poor member, lower nonlithophysal zone
Tpcpmn	Tiva Canyon Tuff: crystal-poor member, middle nonlithophysal zone
Tpcpul	Tiva Canyon Tuff: crystal-poor member, upper lithophysal zone
Tpcpun	Tiva Canyon Tuff: crystal-poor member, upper nonlithophysal zone
Tpcrn	Tiva Canyon Tuff: crystal-rich member, nonlithophysal zone, but used in BSC (2002) to mean the Tpcr member
Tpki	Tuff unit "x"
tsf	tons (American) per square foot
UF	Utility Facility
USBR	U.S. Bureau of Reclamation
USN	U.S. Department of the Navy
USS	United States Steel
UTA	University of Texas, Austin
V <sub>p</sub>	compression-wave seismic velocity
V <sub>s</sub>	shear-wave seismic velocity

**ACRONYMS AND ABBREVIATIONS (CONTINUED)**

WHB	waste handling surface facilities formally designated as WHB or Waste Handling Building
WHF	Wet Handling Facility
WNNRF	Warehouse and Non-Nuclear Receipt Facility
YMP	Yucca Mountain Project

## GLOSSARY

This glossary presents definitions for geologic and geotechnical terms as used in this report. Other definitions may be used in other disciplines or in other contexts.

**bedded tuff**—a rock unit composed of volcanic ejecta that was deposited in layers and that exhibits distinct planes of weakness (bedding planes) parallel to layering; deposited either by water or by compositional sorting by air fall.

**coefficient of uniformity**—the ratio of  $D_{60}$  to  $D_{10}$ , where  $D_n$  is the sieve opening that would allow  $n$  percent of the soil particles (on a dry mass basis) to pass. In practice,  $D_n$  is determined by interpolation of the results of a particle-size distribution test.

**coefficient of vertical subgrade reaction,  $k$**  (mass per length squared per time squared, e.g., pound-force/ft<sup>3</sup> or kN/m<sup>3</sup>)—the ratio of the vertical pressure acting at the foundation/subgrade interface at a point to the settlement at the same point.

**compression-wave velocity**—velocity of the compression (P) wave from a seismic energy source.

**density,  $\rho$**  (mass per length cubed, e.g., pound-mass/ft<sup>3</sup> or kg/m<sup>3</sup>)—the total mass (solids plus liquid plus gas) per total volume. Synonyms: bulk density, total bulk density, moist density, total density, wet density.

**density of solid particles,  $\rho_s$**  (mass per length cubed, e.g., pound-mass/ft<sup>3</sup> or kg/m<sup>3</sup>)—the mass of solid particles divided by the volume of solid particles.

**dry density,  $\rho_d$**  (mass per length cubed, e.g., pound-mass/ft<sup>3</sup> or kg/m<sup>3</sup>)—the mass of solid particles per the total volume of soil or rock.

**embedment**—the depth at which the base of a foundation is situated below the ground surface.

**engineered fill**—a fill placed by man that meets several criteria, including: (1) the fill is designed to meet established criteria (e.g., bearing capacity, settlement) for a particular purpose (building, embankment, etc.); (2) criteria are established on drawings and in a written specification for the material placed in the fill; (3) the fill is placed in accordance with drawings and written specifications; (4) the fill placement operations are observed by a geotechnical engineer (usually a geotechnical technician working under the geotechnical engineer's supervision); (5) the material being placed in the fill is sufficiently tested to establish its geotechnical characteristics; (6) the degree of compaction of the fill is verified by either (a) in-situ density tests and compaction tests if relative compaction or relative density is specified, or (b) documenting adherence to a method specification, depending on which acceptance criteria is stipulated in the construction contract documents; (7) all fill material and all compacted fill that do not meet the contract requirements is either removed and replaced or reworked in an appropriate manner; (8) the geotechnical engineer prepares detailed written daily reports stating the geotechnical engineer's observations for the day, which are distributed on a daily basis; and (9) the geotechnical engineer writes and files a report at the conclusion of earthwork construction summarizing the geotechnical engineer's observations and testing made during construction and



providing his opinion that the fill was or was not constructed in accordance with the specifications and is suited or not for its intended use.

**finer content**—the percent of a material's particles, on a dry weight basis, that pass through a U.S. Standard No. 200 sieve.

**kip**—a unit of force (weight) equal to one thousand pounds-force (1000 lbf).

**lithophysae**—hollow, bubble-like structures composed of concentric shells formed by the concentration of gases during cooling of portions of a volcanic flow deposit.

**lithophysal**—containing lithophysae.

**low-amplitude shear modulus**—see shear modulus, low-amplitude.

**moist density**—synonym of density.

**non-engineered fill**—an artificial (man-made) fill that does not meet the definition of engineered fill.

**nonwelded tuff**—a volcanic rock consisting of fragments that were deposited with insufficient heat to have become fused.

**overburden pressure**—at point A at depth,  $d$ ,  $\sigma_v = \int_0^d \gamma dz$  where  $\gamma$  is unit weight and  $z$  is depth

below the point on the ground surface directly above Point A. Note: For this report, groundwater is not a consideration, so effective overburden pressure is taken to be the same as total overburden pressure.

**percent core recovery**—in a given cored interval, the ratio of the length of core recovered to the length of the interval, expressed as a percentage.

**Poisson's ratio,  $\nu$** —in Hooke's Law for isotropic materials, for a material subjected to a stress in some direction, the ratio of the strain in the transverse direction to the strain in the direction of stress application.

**relative compaction**—the ratio, expressed as a percentage, of the dry unit weight of a soil mass to the reference maximum dry unit weight of the material as determined by a test, such as ASTM D 1557, *Standard Test Methods for Laboratory Compaction Characteristics of Soil Using Modified Effort (56,000ft-lbf/ft<sup>3</sup> (2,700kN-m/m<sup>3</sup>))*.

**relative density**—the ratio of (1) the difference between the void ratio of a cohesionless soil in the loosest state and its actual void ratio, to (2) the difference between the void ratios in the loosest and in the densest states.

**shear modulus**—the stiffness factor for a material under shear stress, expressed by the relationship of the applied shear force to the change in position produced by this force, calculated as the product of the total mass density (total unit weight divided by gravity) and the square of the shear wave velocity. Symbol:  $G$ .

**shear modulus, low-amplitude**—shear modulus determined as the ratio of the shearing stress divided by the shearing strain at low strain values ( $< 0.001\%$ ). Symbol:  $G$ . Synonym: small-strain shear modulus.

**shear-wave velocity**—velocity of the shear (S) wave from a seismic energy source.

**shear-wave velocity, low-amplitude** -the velocity of a seismic body wave propagating with a shearing motion that oscillates particles at right angles to the direction of propagation measured at low strain values ( $< 0.001\%$ ). Synonym: small-strain shear-wave velocity.

**small-strain shear modulus**—synonym of low-amplitude shear modulus

**small-strain shear-wave velocity**—synonym of low-amplitude shear-wave velocity.

**total density**—synonym of density.

**total unit weight**—synonym of unit weight.

**unit weight,  $\gamma$**  (mass per length squared per time squared, e.g., pound-force/ft<sup>3</sup> or kN/m<sup>3</sup>)—the total weight (solids plus liquid plus gas) per total volume. This parameter is also referred to as “moist unit weight,” “wet unit weight,” or “total unit weight.”

**unit weight, dry,  $\gamma_d$**  (mass per length squared per time squared, e.g., pound-force/ft<sup>3</sup> or kN/m<sup>3</sup>)—the total weight of solid particles per total volume.

**unit weight, total**—synonym of unit weight.

**vitric tuff**—an indurated deposit of volcanic ash composed mainly glassy fragments blown out of a volcano during a volcanic eruption.

**water content**—the ratio of the mass of water contained in the pore spaces of soil or rock material, to the solid mass of particles in that material, expressed as a percentage. Also referred to as gravimetric water content. Note that adsorbed water is not considered part of the water in the pore spaces but as water bound to the solid particles—synonym of moisture content.

**welded tuff**—a rock consisting of volcanic fragments that has been indurated by the heat retained by particles and the enveloping gases.

**wet density**—synonym of density.

## **1 PURPOSE**

### **1.1 PURPOSE**

This report is written as a companion report to *Soils Report for North Portal Area, Yucca Mountain Project*, Document Identifier 100-00C-WRP0-00100-000-000, dated October 2002 (BSC 2002b). The primary purpose of the current report is to adopt, clarify, and summarize the findings and recommendations of BSC (2002a) and BSC (2002b) into design charts and tables to be used for the preliminary design of waste handling surface facilities (formally designated as WHB, or waste handling building) to be constructed near the North Portal of the Exploratory Studies Facility (ESF) at the Yucca Mountain Project Site (YMP). The surface facilities include all associated surface structures for the nuclear waste handling and storage facility. This report also recommends additional investigation and testing for the final design of the proposed facilities. These recommendations have been developed for use in design of the potential waste handling facilities to a level suitable to support License Application.

Subsequent to the issuance of Revision 00A of this calculation a ground motion report for the site was written (BSC 2004a) more thoroughly addressing dynamic properties and other seismic considerations. This current calculation revision includes consideration of the BSC 2004a report regarding the dynamic soil properties, including shear and compression wave velocities and material degradation relationships.

### **1.2 SCOPE**

The scope of this report is to provide simplified charts and recommendations of geotechnical parameters to be used for preliminary design and analysis of the surface facilities. Where pertinent, the recommendations provided in BSC (2002b) are used. The current report summarizes the pertinent field and laboratory investigations, the results of material property tests, and provides engineering design parameters including allowable bearing capacity, settlement, lateral earth pressures on retaining walls, and slope evaluation based on site-specific subsurface soil information. Additional recommendations provided include pavement design parameters, percolation rates, and frost penetration. Construction considerations and additional investigations and testing are also discussed.

### **1.3 PROJECT DESCRIPTION**

The configuration of the nuclear waste handling surface facilities area has changed over much iteration from a single building encompassing all aspects of the waste handling process to the configuration used herein, which consists of several major storage and process facilities. The facility layout is shown in Figure 1-1 (Drawing TDR-MGR-GE-000010 Rev. 00C). The largest structures are the two aging pads to the north of the building cluster. The largest buildings are the Canister Receipt and Closure Facilities (Building Nos. 080, 070, and 060). Other major structures include the Wet Handling Facility (050); Initial Handling Facility (51A); Receipt Facility (200); and the Emergency Diesel Generator Facility (26D). The southeast portion of the site area contains an evaporation pond and a stormwater/retention pond. Several smaller facilities (administration, fire rescue, medical, storage, etc.) are located in the southern portion of

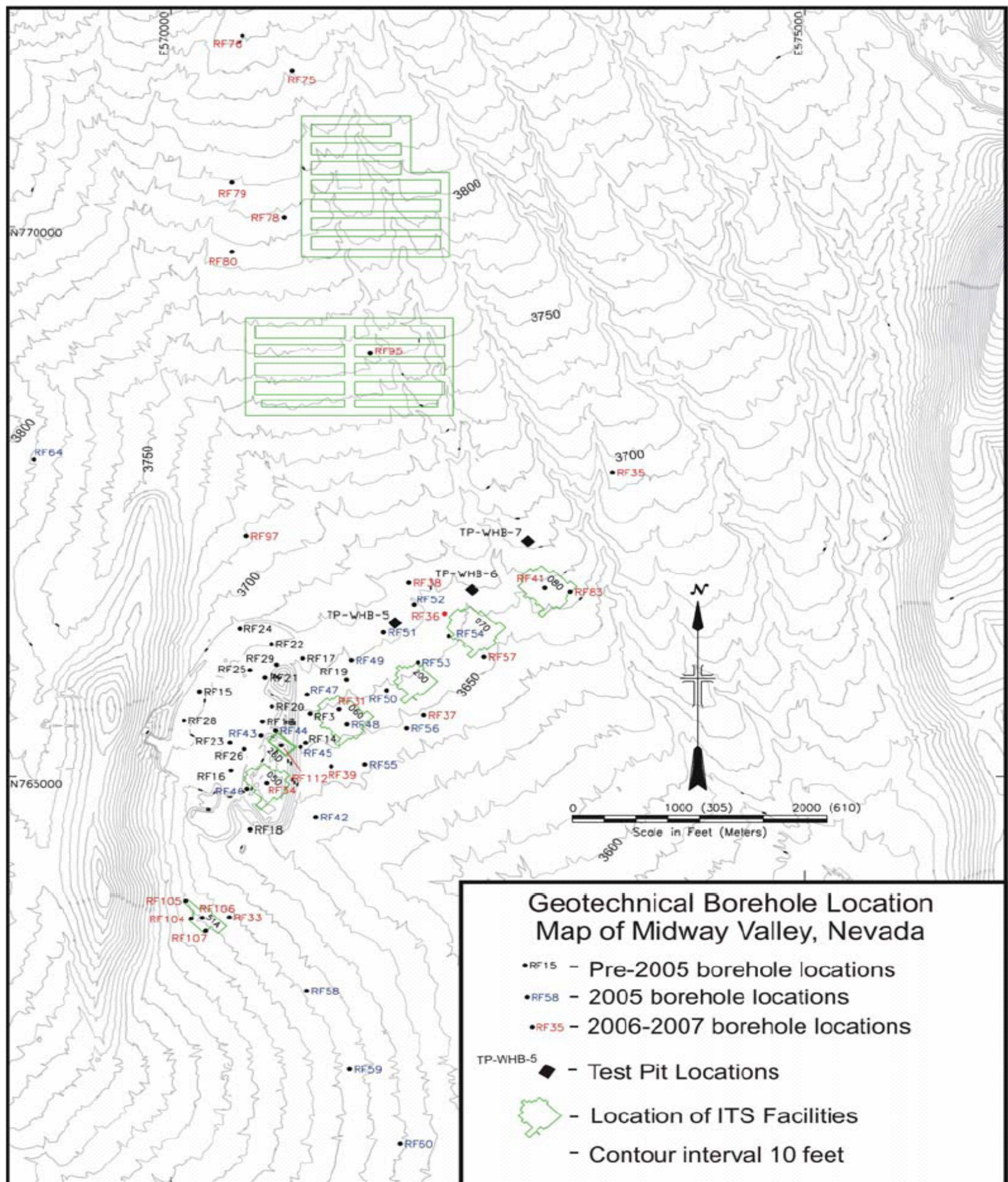
the site. The nuclear handling surface facilities are typically constructed with heavy reinforced concrete walls, floor and roof slabs, and heavy structural steel framing systems. Foundation pressures are expected to be on the order of 3 to 5 ksf (static) and 10 ksf (dynamic) under the planned structures. A summary of the building dimensions, weights, elevations and reference sources for the larger buildings is provided in Table 1-1 below.

**Table 1-1 Summary of Planned Buildings**

Building	Dimensions (ft)	Elev (ft)	Load (kips)	Drawing Reference	Calculation
Receipt Facility, RF	284 x 242 x 7	3658	189677	200-DB0-RF00-00101-000, Rev. 00A, 5/29/07	200-DBC-RF00-00300-000, Rev 00A, 3/07
Emergency Diesel Generator Facility	98 x 174 x 4		95		26D-SOC-EG00-00500-000, Rev. 00A, 7/16/07
Cannister Receipt and Closure Facility, CRCF #1	262 x 421 x 6	3662	314229	060-DB0-CR00-00101-000, Rev. 00A, 7/30/07	060-DBC-CR00-00200-000-00A
Initial Handling Facility, IHF	385 x 235 x 6		31310	51A-P10-IH00-00102-000, Rev. 00B	51A-SSC-IH00-00400-000, Rev 00A, 3/31/07
Wet Handling Facility, WHF (pool)	114 x 116 x 52	(-52 below grade)		050-DB0-WH00-00101-000, Rev 00A, 7/30/07	Wet Handling Facility Subgrade Structure and Foundation Design, 050-SYC-WH00-00500-000, Rev 00A, 5/07
Wet Handling Facility, WHF (building)	270 x 214	3667	269692	050-DB0-WH00-00102-000, Rev 00A, 7/30/07	

**Figure 1-1. Location Map Showing Geotechnical Boreholes from pre-2005, 2005, and 2006 to 2007 Drilling Programs (TDR-MGR-GE-000010 Rev. 00C)**

Geotechnical Data for a Potential Waste Handling Building and for Ground Motion Analyses for the Yucca Mountain Project



Source: DTNs: GS020383114233.003 [DIRS 157980], GS070683114233.005 [DIRS 182109], MO0707RFGNPMV1.000 [DIRS 183189], MO0706ABRTP567.000 [DIRS 183301], MO0612SMFGLGIB.000 [DIRS 183648], for boreholes, test pits; BSC Drawing #100-C00-MGR0-00501-000 [DIRS 184014], 170-C00-AP00-00101-000 (DIRS 184057) for ITS facilities.

## 1.4 LIMITATIONS

Limitations stated in Section 1.3 of BSC (2002b) apply to this report and are briefly summarized below (refer to BSC 2002b for full descriptions):

1. These recommendations are intended to provide geotechnical input for the surface facilities to support License Application.
2. When the final building configuration and borrow source are defined the recommendations should be reviewed to evaluate whether any changes or additional confirmatory borings or field tests are needed (These items are addressed in Section 7.3 of this report.).
3. The bases for the recommendations are limited to the borings, field tests, and laboratory tests performed in the vicinity of the site to date. Although not likely, unanticipated subsurface conditions may be present. The recommendations provided in this report are based on no major deviations occurring from what was observed in the studies to date.
4. The recommended bearing capacities and lateral earth pressures are for near horizontal ground conditions (i.e., less than or equal to a 3% slope). However, modifications to the recommendations can be made on a case-by-case basis for any specific conditions that vary appreciably from the near horizontal ground condition.
5. Any person using this report for bidding purposes should perform independent investigations, as they deem necessary to satisfy themselves that the surface and subsurface conditions are suitably accurate to determine construction procedures and methods.

## 2 REFERENCES

### 2.1 PROCEDURES/DIRECTIVES

EG-PRO-3DP-G04B-00037, Rev. 10. *Calculations and Analyses*. Las Vegas, Nevada: Bechtel SAIC Company. ACC: ENG.20071018.0001

IT-PRO-0011, Rev. 7. *Software Management*. Las Vegas, Nevada: Bechtel SAIC Company. ACC: DOC.20070905.0007.

ORD (Office of Repository Development) 2006. *Repository Project Management Automation Plan*. 000-PLN-MGR0-00200-000, Rev. 00E. Las Vegas, Nevada: U.S. Department of Energy, Office of Repository Development. ACC: ENG.20070326.0019.

## 2.2 DESIGN INPUTS

The input data used or considered in the calculation herein are primarily adopted from the following references (for the surface facilities area):

- Geotechnical Data for Potential Waste Handling Building and for Ground Motion Analyses for the Yucca Mountain Site Characterization Project, BSC (2002a)
- Soils Report for North Portal Area, Yucca Mountain Project, BSC (2002b)
- Ground Motion Input Report, BSC (2004a)

Input data taken from other sources are indicated where they are used.

### 2.2.1 Input Documents

ACI 230.1R-90. 1991. State-of-the-Art Report on Soil Cement. Detroit, Michigan: American Concrete Institute. TIC: 231738.

ASCE 4-98. 2000. *Seismic Analysis of Safety-Related Nuclear Structures and Commentary*. Reston, Virginia: American Society of Civil Engineers. TIC: 253158. (DIRS 159618)

Bowles, J.E. 1996. *Foundation Analysis and Design*. 5th Edition. New York, New York: McGraw-Hill. TIC: 247039. (DIRS 157929)

BSC 2002a. *Geotechnical Data for a Potential Waste Handling Building and for Ground Motion Analyses for the Yucca Mountain Site Characterization Project*. ANL-MGR-GE-000003 REV 00. Las Vegas, Nevada: Bechtel SAIC Company. ACC: MOL.20021004.0078. (DIRS 157829)

BSC 2002b. *Soils Report for North Portal Area, Yucca Mountain Project*. 100-00C-WRP0-00100-000-000. Las Vegas, Nevada: Bechtel SAIC Company. ACC: MOL.20021015.0323. (DIRS 159262)

BSC 2002c. Preliminary Hydrologic Engineering Studies for the North Portal Pad and Vicinity. ANL-EBS-MD-000060 REV 00. Las Vegas, Nevada: Bechtel SAIC Company. ACC: MOL.20021028.0123.

BSC 2004a. Development of Earthquake Ground Motion Input for Preclosure Seismic Design and Postclosure Performance Assessment of a Geologic Repository at Yucca Mountain, NV. MDL-MGR-GS-000003 REV 01. Las Vegas, Nevada: Bechtel SAIC Company. ACC: DOC.20041111.0006; DOC.20051130.0003. (DIRS 170027)

BSC 2004b. *Preliminary Dynamic Design Parameters for Roller-Compacted Soil-Cement*. 100-SOC-CY00-00200-000-00A. Las Vegas, Nevada: Bechtel SAIC Company. ACC: ENG.20040205.0008.



BSC 2006a. *Basis of Design for the TAD Canister-Based Repository Design Concept*. 000-3DR-MGR0-00300-000-001. Las Vegas, Nevada: Bechtel SAIC Company. ACC: ENG.20071026.0033.

BSC (Bechtel SAIC Company) 2007. Project Design Criteria Document. 000-3DR-MGR0-00100-000-007. Las Vegas, Nevada: Bechtel SAIC Company. ACC: ENG.20071016.0005; ENG.20071108.0001. (DIRS 179641).

BSC (Bechtel SAIC Company) 2007. CRCF Foundation Design. 060-DBC-CR00-00200-000-00A. Las Vegas, Nevada: Bechtel SAIC Company. ACC: ENG.20070322.0005. (DIRS 184027).

BSC (Bechtel SAIC Company) 2007. Emergency Diesel Generator Facility – Diesel Generator Foundation Calculation. 26D-S0C-EG00-00500-000-00A. Las Vegas, Nevada: Bechtel SAIC Company. ACC: ENG.20070718.0006.

BSC (Bechtel SAIC Company) 2007. Initial Handling Facility – Initial Handling Facility Foundation Design. 51A-SSC-IH00-00400-000-00A. Las Vegas, Nevada: Bechtel SAIC Company.

BSC (Bechtel SAIC Company) 2007. Receipt Facility (RF) Foundation Design. 200-DBC-RF00-00300-000-00A. Las Vegas, Nevada: Bechtel SAIC Company. ACC: ENG.20070328.0004. (DIRS 184037)

BSC (Bechtel SAIC Company) 2007. Wet Handling Facility Subgrade Structure and Foundation Design. 050-SYC-WH00-00500-000-00A. Las Vegas, Nevada: Bechtel SAIC Company. ACC: ENG.20070601.0017. (DIRS 184031)

Bureau of Reclamation 1992. Logs of Test Pit or Auger Hole: Access Road, Ground Surface Facility, Hole Nos. GSF-TP-1 through GSF-TP-39. [Denver, Colorado]: U.S. Department of the Interior, Bureau of Reclamation. ACC: NNA.19930614.0010. (DIRS 103599)

Bureau of Reclamation 1993. Electrical Resistivity Data for YMP North Portal Grounding Mat. [Denver, Colorado: U.S. Department of the Interior, Bureau of Reclamation]. ACC: MOL.19980115.0161. (DIRS 103589)

CRWMS M&O 1999. *Preliminary Geotechnical Investigation for Waste Handling Building, Yucca Mountain Site Characterization Project*. BCB000000-01717-5705-00016 REV 00. Las Vegas, Nevada: CRWMS M&O. ACC: MOL.19990625.0182. (DIRE 109209)

DOE 1995. *Yucca Mountain Site Characterization Project Site Atlas 1995*. Two volumes. Washington, D.C.: U.S. Department of Energy. ACC: MOL.19960311.0262. (DIRS 102884)

Duncan, J.M. and Seed, R.B. 1986. "Compaction-Induced Earth Pressures under K(sub0)-Conditions." *Journal of Geotechnical Engineering*, 112, (1), 1-22. [New York, New York]: American Society of Civil Engineers. TIC: 243244. (DIRS 102359)



- Duncan, J.M.; Williams, G.W.; Sehn, A.L.; and Seed, R.B. 1991. "Estimation Earth Pressures Due to Compaction." *Journal of Geotechnical Engineering*, 117, (12), 1833-1847. [New York, New York]: American Society of Civil Engineers. TIC: 252185. (DIRS 157870)
- Dupas, J-M. and Pecker, A. 1979. "Static and Dynamic Properties of Sand-Cement." *Journal of the Geotechnical Engineering Division*, 105, (GT3), 419-436. [Reston, Virginia]: American Society of Civil Engineers. TIC: 254534. (DIRS 165770)
- EPRI 1993. *Method and Guidelines for Estimating Earthquake Ground Motion in Eastern North America*. Volume 1 of *Guidelines for Determining Design Basis Ground Motions*. EPRI TR-102293. Palo Alto, California: Electric Power Research Institute. TIC: 226495. (DIRS 103319)
- Fang, H-Y., ed. 1991. *Foundation Engineering Handbook*. 2nd Edition. Boston, Massachusetts: Kluwer Academic Publishers. TIC: 245696. (DIRS 135068)
- Gibson, J.D.; Swan, F.H.; Wesling, J.R.; Bullard, T.F.; Perman, R.C.; Angell, M.M.; and DiSilvestro, L.A. 1992. *Summary and Evaluation of Existing Geological and Geophysical Data Near Prospective Surface Facilities in Midway Valley, Yucca Mountain Project, Nye County, Nevada*. SAND90-2491. Albuquerque, New Mexico: Sandia National Laboratories. ACC: NNA.19910709.0001. (DIRS 102323)
- Ho, D.M.; Sayre, R.L.; and Wu, C.L. 1986. *Suitability of Natural Soils for Foundations for Surface Facilities at the Prospective Yucca Mountain Nuclear Waste Repository*. SAND85-7107. Albuquerque, New Mexico: Sandia National Laboratories. ACC: NNA.19890327.0053. (DIRS 102324)
- Holmes & Narver 1983. *Soils Investigation for Sandia Laboratories NNWSI Area 25 Nevada Test Site*. Report #ES 133. Las Vegas, Nevada: Holmes & Narver. ACC: MOL.19961113.0080. (DIRS 102299)
- ICC 2000. *International Building Code 2000*. Falls Church, Virginia: International Code Council. TIC: 251054. (DIRS 159179)
- Kohata, Y.; Muramoto, K.; Maekawa, H.; Yajima, J.; and Babasaki, R. 1997. "JGS TC Report: Deformation and Strength Properties of DM Cement-Treated Soils." *Grouting and Deep Mixing, Proceedings of IS-Tokyo '96, the Second International Conference on Ground Improvement Geosystems, Tokyo, 14-17 May 1996*. Yonekura, R.; Terashi, M.; and Shibazaki, M., eds. 2, 905-911. Brookfield, Vermont: A.A. Balkema. TIC: 254764.(DIRS 165771)
- Ladd, R.S. 1978. "Preparing Test Specimens Using Undercompaction." *Geotechnical Testing Journal*, 1, (1), 16-23. New York, New York: American Society for Testing and Materials. TIC: 243278. (DIRS 102326)
- Luebbers, M.J. 2002a. Borehole Suspension Seismic Component of Geotechnical Investigation for a Potential Waste Handling Building. Scientific Notebook SN-M&O-SCI-024-V1. ACC: MOL.20020509.0127; MOL.20020509.0129; MOL.20020509.0130; MOL.20020509.0132.(DIRS 157252)

Luebbers, M.J. 2002b. Borehole Suspension Seismic Component of Geotechnical Investigation for a Potential Waste Handling Building. Scientific Notebook SN-M&O-SCI-024-V2. ACC: MOL.20020509.0128; MOL.20020509.0130; MOL.20020509.0131; MOL.20020509.0132; MOL.20020509.0133. (DIRS 157253)

Luebbers, M.J. 2002c. Downhole Seismic Component of Geotechnical Investigation for a Potential Waste Handling Building. Scientific Notebook SN-M&O-SCI-025-V1. ACC: MOL.20020228.0297. (DIRS 157288)

McGinn, A.J. and O'Rourke, T.D. 2003. *Performance of Deep Mixing Methods at Fort Point Channel*. Ithaca, New York: Cornell University, School of Civil and Environmental Engineering. TIC: 254802. (DIRS 165772)

McKeown, M. 1992. *Soil and Rock Geotechnical Investigations Field and Laboratory Studies, North Ramp Surface Facility Exploratory Studies Facility, Yucca Mountain Project, Nevada*. Technical Memorandum 3610-92-35. Denver, Colorado: U.S. Department of Interior, Bureau of Reclamation. ACC: NNA.19930607.0020. (DIRS 102330)

Neal, J.T. 1985. *Location Recommendation for Surface Facilities for the Prospective Yucca Mountain Nuclear Waste Repository*. SAND84-2015. Albuquerque, New Mexico: Sandia National Laboratories. ACC: NNA.19870406.0061. (DIRS 101618)

Neal, J.T. 1986. *Preliminary Validation of Geology at Site for Repository Surface Facilities, Yucca Mountain, Nevada*. SAND85-0815. Albuquerque, New Mexico: Sandia National Laboratories. ACC: NNA.19870824.0060. (DIRS 102331)

NRC 1989. "Seismic System Analysis." Revision 2 of Section 3.7.2 of *Standard Review Plan [for the Review of Safety Analysis Reports for Nuclear Power Plants]*. NUREG-0800. Washington, D.C.: U.S. Nuclear Regulatory Commission. ACC: MOL.20030910.0151. (DIRS 165111)

Peck, R.B.; Hansen, W.E.; and Thornburn, T.H. 1974. *Foundation Engineering*. New York, New York: John Wiley & Sons. (DIRS 166319)

Poulos, H.G. and Davis, E.H. 1991. *Elastic Solutions for Soil and Rock Mechanics*. Series in Soil Engineering. Lambe, T.W., and Whitman, R.V., eds. New York, New York: Center for Geotechnical Research. TIC: 252578. (DIRS 157885)

Sato, H.; Tanaka, Y.; Kanatani, M.; Tamari, Y.; and Sugisawa, M. 1995. "An Experimental and Numerical Study on the Behaviour of Improved Ground by D.M.M. Against Liquefaction." *Proceedings of IS-Tokyo '95, The First International Conference on Earthquake Geotechnical Engineering, Tokyo, 14-16 November 1995*. Ishihara, K., ed. 2, 767-772. Brookfield, Vermont: A.A. Balkema. TIC: 254515. (DIRS 165774)

Seed, H.B. and Idriss, I.M. 1970. *Soil Moduli and Damping Factors for Dynamic Response Analyses*. EERC 70-10. Berkeley, California: University of California, Earthquake Engineering Research Center. TIC: 241070. (DIRS 103324)

Seed, H.B. and Whitman, R.V. 1970. "Design of Earth Retaining Structures for Dynamic Loads." *Lateral Stresses in the Ground and Design of Earth-Retaining Structures, State-of-the-Art Papers Presented at 1970 Specialty Conference, June 22-24, 1970, Ithaca, N.Y.* Pages 103-147. New York, New York: American Society of Civil Engineers. TIC: 243358. (DIRS 102360)

Seed, H.B.; Wong, R.T.; Idriss, I.M.; and Tokimatsu, K. 1986. "Moduli and Damping Factors for Dynamic Analyses of Cohesionless Soils." *Journal of Geotechnical Engineering*, 112, (11), 1016-1033. New York, New York: American Society of Civil Engineers. TIC: 243355. (DIRS 157263)

Sherard, J.L.; Dunnigan, L.P.; and Talbot, J.R. 1984. "Basic Properties of Sand and Gravel Filters." *Journal of Geotechnical Engineering*, 110, (6), 684-700. [Reston, Virginia]: American Society of Civil Engineers. TIC: 255343.

Terzaghi, K. 1955. "Evaluation of Coefficients of Subgrade Reaction." *Geotechnique*, V, 297-326. London, [England]: [Thomas Telford]. TIC: 243253. (DIRS 102363)

Terzaghi, K.; Peck, R.B.; and Mesri, G. 1996. *Soil Mechanics in Engineering Practice*. 3rd Edition. New York, New York: John Wiley & Sons. TIC: 255131. (DIRS 165965)

USN 1986. *Foundations and Earth Structures*. Design Manual 7.02. NAVFAC 0525-LP-300-7070. Alexandria, Virginia: U.S. Department of the Navy, Naval Facilities Engineering Command. TIC: 207993. (DIRS 102312)

Vucetic, M. and Dobry, R. 1988. "Degradation of Marine Clays Under Cyclic Loading." *Journal of Geotechnical Engineering*, 114, (2), 133-149. New York, New York: ASCE. TIC:255461. (DIRS 166683)

Wang, Y.D. 1986. *Investigation of Constitutive Relations for Weakly Cemented Sands*. Ph.D. dissertation. Berkeley, California: University of California, Berkeley. TIC: 254462. (DIRS 165775)

Wong, I.G. 2002a. SASW Measurements Near the Top of Yucca Mountain and in the Potential Repository Block. Scientific Notebook SN-M&O-SCI-040-V1. ACC: MOL.20020619.0461; MOL.20020619.0462. (DIRS 157292)

Wong, I.G. 2002b. Downhole Seismic Measurements at the Potential Waste Handling Building Site. Scientific Notebook SN-M&O-SCI-030-V1. ACC: MOL.20020227.0168. (DIRS 157332)

Wong, I.G. 2002c. SASW Measurements at Waste Handling Building Site. Scientific Notebook SN-M&O-SCI-022-V1. ACC: MOL.20020520.0222; MOL.20020520.0223; MOL.20020520.0225; MOL.20020520.0226. (DIRS 157269)

Wong, I.G. 2002d. Laboratory Dynamic Testing of Rock and Soil Specimens for the Potential Waste Handling Building Site. Scientific Notebook SN-M&O-SCI-033-V1. ACC: MOL.20020508.0336; MOL.20020528.0392; MOL.20020508.0337; MOL.20020528.0394 (DIRS 159423)

## 2.2.2 Standards

ASTM C 136-01. 2001. *Standard Test Method for Sieve Analysis of Fine and Coarse Aggregates*. West Conshohocken, Pennsylvania: American Society for Testing and Materials. TIC: 253074. (DIRS 159570)

ASTM D 1557-02. 2003. *Standard Test Methods for Laboratory Compaction Characteristics of Soil Using Modified Effort (56,000 ft-lbf/ft<sup>3</sup> (2,700 kN-m/m<sup>3</sup>))*. West Conshohocken, Pennsylvania: American Society for Testing and Materials. TIC: 254263. (DIRS 164216)

ASTM D 1557-91. 1998. *Standard Test Method for Laboratory Compaction Characteristics of Soil Using Modified Effort (56,000 ft-lbf/ft<sup>3</sup> (2,700 kN-m/m<sup>3</sup>))*. West Conshohocken, Pennsylvania: American Society for Testing and Materials. TIC: 242992. (DIRS 102391)

ASTM D 2434-68 (Reapproved 2000). 2000. *Standard Test Method for Permeability of Granular Soils (Constant Head)*. West Conshohocken, Pennsylvania: American Society for Testing and Materials. TIC: 255907. (DIRS 166311)

ASTM D 4718-87 (Reapproved 2001). 2001. *Standard Practice for Correction of Unit Weight and Water Content for Soils Containing Oversize Particles*. West Conshohocken, Pennsylvania: American Society for Testing and Materials. TIC: 253066. (DIRS 159581)

ASTM D 5126-90 (Reapproved 1998). 1998. *Standard Guide for Comparison of Field Methods for Determining Hydraulic Conductivity in the Vadose Zone*. West Conshohocken, Pennsylvania: American Society for Testing and Materials. TIC: 255906. (DIRS 166313)

ASTM D 558-82. 1982. *Standard Test Methods for Moisture-Density Relations of Soil-Cement Mixtures*. Philadelphia, Pennsylvania: American Society of Testing and Materials. TIC: 254760. (DIRS 165764)

USBR 5000-86. *Procedure for Determining Unified Soil Classification (Laboratory Method)*. Denver, Colorado: U.S. Department of the Interior, Bureau of Reclamation. TIC: 232041. (DIRS 158737)

USBR 5300-89. *Procedure for Determining Moisture Content of Soil and Rock by the Oven Method*. Denver, Colorado: U.S. Department of the Interior, Bureau of Reclamation. TIC: 232041. (DIRS 158740)

USBR 5320-89. *Procedure for Determining Specific Gravity of Soils*. Denver, Colorado: U.S. Department of the Interior, Bureau of Reclamation. TIC: 232041. (DIRS 158741)

USBR 5325-89. *Procedure for Performing Gradation Analysis of Gravel Size Fraction of Soils*. Denver, Colorado: U.S. Department of the Interior, Bureau of Reclamation. TIC: 232041. (DIRS 158742)

USBR 5330-89. *Procedure for Performing Gradation Analysis of Fines and Sand Size Fraction of Soils, Including Hydrometer Analysis.* Denver, Colorado: U.S. Department of the Interior, Bureau of Reclamation. TIC: 232041. (DIRS 158743)

USBR 5335-89. *Procedure for Performing Gradation Analysis of Soils Without Hydrometer-Wet Sieve.* Denver, Colorado: U.S. Department of the Interior, Bureau of Reclamation. TIC: 232041. (DIRS 158744)

USBR 5350-89. *Procedure for Determining the Liquid Limit of Soils by the One-Point Method.* Denver, Colorado: U.S. Department of the Interior, Bureau of Reclamation. TIC: 232041. (DIRS 158745)

USBR 5360-89. *Procedure for Determining the Plastic Limit and Plasticity Index of Soils.* Denver, Colorado: U.S. Department of the Interior, Bureau of Reclamation. TIC: 232041. (DIRS 158746)

USBR 5525-89. *Procedure for Determining the Minimum Index Unit Weight of Cohesionless Soils.* Denver, Colorado: U.S. Department of the Interior, Bureau of Reclamation. TIC: 232041. (DIRS 158748)

USBR 5530-89. *Procedure for Determining the Maximum Index Unit Weight of Cohesionless Soils.* Denver, Colorado: U.S. Department of the Interior, Bureau of Reclamation. TIC: 232041. (DIRS 158749)

USBR 7205-89. *Procedure for Determining Unit Weight of Soils In-Place by the Sand-Cone Method.* Denver, Colorado: U.S. Department of the Interior, Bureau of Reclamation. TIC: 232041. (DIRS 158752)

USBR 7221-89. *Procedure for Determining Unit Weight of Soils In-Place by the Water Replacement Method in a Test Pit.* Denver, Colorado: U.S. Department of the Interior, Bureau of Reclamation. TIC: 232041. (DIRS 102405)

### **2.2.3 Data Tracking Numbers**

GS020383114233.001. Waste Handling Building Test Pit Logs with Photomosaic Test Pit Maps. Submittal date: 03/28/2002. (DIRS 157982).

GS020383114233.003. Geotechnical Borehole Logs for the Waste Handling Building, Yucca Mountain Project, Nevada Test Site, Nevada. Submittal date: 03/28/2002. (DIRS 157980)

GS020483114233.004. Geotechnical Field and Laboratory Test Results from Waste Handling Building Foundation Investigation. Submittal date: 04/15/2002. (DIRS 158242)

GS020783114233.005. Gradations, Yucca Mountain Project, Nevada Test Site, Nevada, Version 7/16/03. Submittal date: 07/23/2003. (DIRS 164561)

- GS030783114233.001. Geotechnical Borehole Logs for the Waste Handling Building, Yucca Mountain Project, Nevada Test Site, Nevada, Version 7/16/03. Submittal date: 07/23/2003. (DIRS 164561)
- GS070483114233.001. Index Properties of Alluvium Soils from Two Sonic Drill Core Holes Obtained at Yucca Mountain Project, 07/20/2006 to 09/28/2006.
- GS070583114233.002. Geologic Descriptive Logs of Fill and Quaternary Alluvium Material in 19 Repository Facilities Geotechnical Investigations Boreholes for the Yucca Mountain Waste Handling Building, 04/12/2005 - 09/12/2005.
- GS070583114233.003. Geologic Descriptive Logs and Photomosaic Maps of Three Test Pits (TP-WHB-5, TP-WHB-6, and TP-WHB-7) for the Yucca Mountain Waste Handling Building, 10/10/2006 - 11/07/2006. Submittal date: 05/31/2007. (DIRS 183296)
- GS070683114233.004. Index Properties and In Place Unit Weight Test Results from Soils from Nine Ring Density Excavations Performed at Yucca Mountain Project, 8/3/2006 to 9/27/2006.
- GS070683114233.005. Geotechnical Borehole Logs of 18 Repository Facilities Geotechnical Investigations Boreholes for the Yucca Mountain Waste Handling Building, 05/18/2007 - 06/20/2007. Submittal date: 06/20/2007. (DIRS 182109)
- GS950308312213.004. Cumulative Infiltration and Surface Flux Rates Conducted in Fortymile Wash and Near UE-25 UZN#7. Submittal date: 03/27/1995.
- GS960908312212.009. Cumulative Infiltration and Surface Flux Rates Calculated on Raw Millivolt Readings for FY95. Submittal date: 09/12/1996.
- MO0008GSC00286.000. Exploratory Studies Facility (ESF) North Portal Pad, Waste Handling Building (WHB) Profile Sections #3, #4, #5, #6, #7, and #8. Submittal date: 08/17/2000. (DIRS 157306)
- MO0110DVDBOREH.000. Downhole Velocity Data from Boreholes RF-13 and RF-17. Submittal date: 10/17/2001. (DIRS 157295)
- MO0110SASWWHBS.000. SASW Velocity Data from the Waste Handling Building Site Characterization Area. Submittal date: 10/02/2001. (DIRS 157969)
- MO0111DVDWHBSC.001. Downhole Velocity Data at the Waste Handling Building Site Characterization Area. Submittal date: 11/08/2001. (DIRS 157296)
- MO0112GSC01170.000. Borrow Pit #1 (Fran Ridge), USBR Sample Locations, for WHB Investigations. Submittal date: 12/04/2001. (DIRS 157302)
- MO0202DWAVEATD.000. Downhole S-Wave and P-Wave Interpreted Arrival Time Data from Boreholes RF#13 and RF#17. Submittal date: 02/13/2002. (DIRS 158079)

MO0202WHBTMPKS.000. Time Picks for Downhole Seismic Surveys. Submittal date: 02/13/2002. (DIRS 158081)

MO0203DHRSSWHB.001. Dynamic Laboratory Test Data for Rock and Soil Samples from the Waste Handling Building Site Characterization Area. Submittal date: 03/19/2002. (DIRS 158082)

MO0203EBSCTCTS.016. Compaction and Triaxial Compression Tests of Soil Sample. Submittal date: 04/01/2002. (DIRS 157970)

MO02045FTDSUSP.001. Statistics for Shear-Wave Velocity, Compression-Wave Velocity, and Poisson's Ratio by 1.5 Meter Depth Intervals from Suspension Seismic Measurements. Submittal date: 04/23/2002. (DIRS 158162)

MO0204SUSPSEIS.001. Statistics for Shear-Wave Velocity, Compression-Wave Velocity, and Poisson's Ratio by Lithostratigraphic Unit from Suspension Seismic Measurements. Submittal date: 04/23/2002. (DIRS 158160)

MO0206EBSFRBLT.018. Fran Ridge Borrow Lab Testing. Submittal date: 06/10/2002. (DIRS 158767)

MO0609SASWSEDC.001, Surface Spectral Analysis of Surface Waves (SASW) Experimental Dispersion Curves for FY04 and FY05 for YMP.

MO0609SASWSTDC.003, Surface Spectral Analysis of Surface Waves (SASW) Theoretical Dispersion Curves and VS Profiles for FY04 and FY05 for YMP.

MO0612SMFGLGIB.000. Sample Management Facility Geologic Logs for the Repository Facilities Geotechnical Investigations Boreholes. Submittal date: 12/18/2006. (DIRS 183648)

MO0706ABRTP567.000. AS-BUILT PROPOSED REPOSITORY FACILITY TEST PITS 5, 6 & 7. Submittal date: 07/10/2007. (DIRS 183301)

MO0707RFGNPMV1.000. REPOSITORY FACILITY (RF) GEOTECHNICAL INVESTIGATIONS NORTH PORTAL & MIDWAY VALLEY - PART 1. Submittal date: 07/24/2007. (DIRS 183189)

MO0708SMFGLGIB.000. SAMPLE MANAGEMENT FACILITY GEOLOGIC LOGS FOR THE REPOSITORY FACILITIES GEOTECHNICAL INVESTIGATIONS BOREHOLES. Submittal date: 08/10/2007. (DIRS 183304)

SNF29041993001.002. Percolation Test Data, EFS Muck Storage Area. Submittal date: 12/21/1994.

## 2.2.4 Drawings

BSC (Bechtel SAIC Company) 2007. Geologic Repository Operations Area North Portal Site Plan. 100-C00-MGR0-00501-000 REV 00E. Las Vegas, Nevada: Bechtel SAIC Company. ACC: ENG.20071116.0004. (DIRS 184014)

BSC (Bechtel SAIC Company) 2007. Geologic Repository Operations Area Aging Pad Site Plan. 170-C00-AP00-00101-000 REV 00B. Las Vegas, Nevada: Bechtel SAIC Company. ACC: ENG.20071116.0005. (DIRS 184057)

BSC (Bechtel SAIC Company) 2007. Initial Handling Facility General Arrangement Ground Floor Plan. 51A-P10-IH00-00102-000 REV 00B. Las Vegas, Nevada: Bechtel SAIC Company. ACC: ENG.20071101.0003. (DIRS 183793)

Nuclear Facilities Buildings, Cannister Receipt and Closure Facility #1, Forming Plan at TOC El. 0'-0", 060-DB0-CR00-00101-000, Rev. 00A, 7/30/07, Las Vegas, Nevada: Bechtel SAIC Company.

Nuclear Facilities Buildings, Receipt Facility, Forming Plan at TOC El. 0'-0", 200-DB0-RF00-00101-000, Rev. 00A, 5/29/07, Las Vegas, Nevada: Bechtel SAIC Company.

Nuclear Facilities Buildings, Wet Handling Facility, Forming Plan at TOC El. 0'-0", 050-DB0-WH00-00102-000, Rev 00A, 7/30/07, Las Vegas, Nevada: Bechtel SAIC Company.

Nuclear Facilities Buildings, Wet Handling Facility, Forming Plan at TOC El. (-)34'-0" and (-)52'-0", 050-DB0-WH00-00101-000, Rev 00A, 7/30/07, Las Vegas, Nevada: Bechtel SAIC Company.

## 2.3 DESIGN CONSTRAINTS

None.

## 2.4 DESIGN OUTPUTS

This calculation will be used as input for other calculations. Summaries of material properties and design parameters derived from this calculation are provided in Tables 2-1 and 2-2.



**Table 2-1. Recommended Material Parameters**  
**Design Parameter<sup>a</sup>**

	<b>Layer</b>
<b>Engineered Fill</b>	
<b>Roller Compacted Cement<sup>b</sup></b>	
<b>Bedrock</b>	<b>Alluvium</b>
Moist Density, $\gamma$ (pcf)	
127 pcf	
130–140 pcf	
114–117 pcf	
100 pcf	
Specific Gravity, $G_s$	
2.5	
2.5	
Not Applicable	
Shear Strength Parameters	
$\phi = 42^\circ$	
$c = 0$	
$\phi = 0$	
$c = 400$ psi (unconf. comp.)	
$\phi = 39^\circ$	
$c = 0$	
Not Applicable	
At-Rest Earth Pressure Coefficient, $K_0$	
0.33	
Not Applicable	
0.37	
Not Applicable	
Active Earth Pressure Coefficient, $K_A$	
0.20	
Not Applicable	
0.23	
Not Applicable	
Passive Earth Pressure Coefficient, $K_P$	
5.0	
Not Applicable	
4.4	

Not Applicable

Static Elastic Modulus, E (ksi)

14–28

Not Available

30–75

Not Applicable

Poisson's Ratio,  $\nu$

0.3–0.4

0.3

0.23–0.44

0.3

Shear Wave Velocity,  $V_s$  (fps)

630–1,500

2,000–3,000

Figure 6-27, Figure 6-29, and Base Case - Figure 6-31

Figure 6-32 and Figure 6-34

Compression Wave Velocity,  $V_p$  (fps)

1,500–3,700

3,700–5,600

Figure 6-28 and

Figure 6-30

Figure 6-33 and Figure 6-35

Low-Strain Shear Modulus, G (ksi)

10–60

100–270

40–200

150–1,000

Low-Strain Elastic Modulus, E (ksi)

30–170

260–700

100–500

400–2,500

Shear Modulus Reduction,  $G/G_{\max}$

Figure 6-38

Figure 6-40

Figure 6-36–upper figure

Figure 6-37–upper figure

Material Damping Ratio, D%

Figure 6-39

Figure 6-41  
 Figure 6-36–lower figure  
 Figure 6-37–lower figure

Resistivity (ohm-m)  
 To Be Determined  
 To Be Determined  
 To Be Determined  
 Not Applicable

CBR  
 20-60  
 Not Applicable  
 20-60  
 Not Applicable

Soil Profile Type  
 (ICC 2000)  
 $S_D$   
 (stiff soil)  
 $S_C$  (very dense soil and soft rock) to  $S_B$  (rock)  
 $S_C$   
 (very dense soil and soft rock)  
 $S_B$  (rock) to  
 $S_A$  (hard rock)

<sup>a</sup> see applicable sections in calculation or appendices for basis of parameters

<sup>b</sup> additional testing required for verification

**Table 2-2. Summary of Recommended Surface Facilities Foundation Design Parameters**

**Design Parameter**

**Results / Recommendations**

Soil Material Properties  
 Table 2-1

## Foundation Pressure

Settlement controls design

Square and Continuous footings: Figure 7-2 and Figure 7-3

## Estimated Settlements

Square and strip footings

Figure 7-4 through Figure 7-6

Mat foundation (300' × 400')

Load (ksf)	Center (in)	Corner (in)	Differential (in)
3	0.2–0.4	negligible	0.4
5	0.5–1.6	< 0.1	1.5
7	1.3–2.9	< 0.1	2.9

## Lateral Pressures

Yielding walls

Static and seismic pressures: Figure 7-7

Surcharge loads: Figure 7-8 and Figure 7-9

Non-yielding walls

Static and seismic pressures: Figure 7-10

Compactor-induced pressures: Figure 7-11 thru Figure 7-15

## Lateral Load Resistance

Friction Coefficient,  $\tan \phi$ 

for alluvium: 0.81

for engineered fill: 0.90

Passive resistance: 515 pcf equivalent fluid

## Temporary Shoring

For braced excavation

Lateral pressure: 17H psf

## Temporary Slopes

1.5H:1V

## Permanent Slopes

2H:1V

**Modulus of Subgrade Reaction**

(static loading; ranges may be doubled for short-term loading)

	<u>Alluvium</u>	<u>Engineered Fill</u>
Horizontal:	104-120 kcf (60-70 pci)	60-96 kcf (35-55 pci)

**Vertical:**

1ft ×1ft footing	1000 kcf (580 pci)	600 kcf (350 pci)
Large mats	155-520 kcf (90-300 pci)	75-250 kcf (45-145 pci)

**Saturated Permeability** $5 \times 10^{-5}$  to  $5 \times 10^{-4}$  fpm**Percolation Rate**

1.8 in/hr

**Depth of Frost Penetration**

10 inches: see Figure 7-16

**Minimum Footing Depth**

2 feet

### 3 ASSUMPTIONS

This calculation is a compilation of available geotechnical information for use in preliminary design of waste handling surface facilities. It is written to adopt, clarify, and summarize findings and recommendations of BSC (2002a) and BSC (2002b) into design charts and tables. The same assumptions as listed in Section 5 of BSC (2002b) have been used in this calculation. There were no assumptions requiring verification in BSC, 2002b.

#### 3.1 ASSUMPTIONS REQUIRING VERIFICATION

There are no assumptions used in this calculation requiring verification.

#### 3.2 ASSUMPTIONS NOT REQUIRING VERIFICATION

Appendices B (Section B4) and C (Section C5) include additional assumptions not requiring verification specific to their subject matter. There are no additional assumptions (other than those listed in BSC, 2002b) used in this calculation.

### 4 METHODOLOGY

#### 4.1 QUALITY ASSURANCE

This calculation was prepared in accordance with procedure EG-PRO-3DP-G04B-00037, *Calculation and Analyses* (ACC: ENG 20070122.0010). *The Basis of Design for the TAD Canister-Based Repository Design Concept* (ACC: ENG 20061023.0002) classifies the nuclear waste handling surface facilities as Important to Safety. Hence, the approved version of this document is designed as QA:QA.

#### 4.2 USE OF SOFTWARE

Excel 2003 and Word 2003, which are part of this Microsoft Office 2003 suite of programs, were used in this report. Microsoft Office 2003 as used in this calculation is classified as Level 2 software usage as defined in IT-PRO-0011 *Software Management* (ACC: DOC 20061221.0003) and is listed on the *Repository Project Management Automation Plan* (ACC: ENG.20060703.0001).

Mathcad version 13 was utilized in this calculation. Mathcad was operated on a PC system running the Window 2003 operating system. Mathcad as used in this calculation is considered as Level 2 software usage as defined in IT-PRO-0011, *Software Management* (ACC: DOC.20061221.0003). Mathcad version 13 is listed on the *Repository Project Management Automation Plan*. (ACC: ENG 20060703.0001).

### 4.3 CALCULATION APPROACH

This calculation reviews existing analyses, reports, drawings, and other documents to determine relevant aspects that have the potential to contribute to and enhance the evaluation of soil materials present at the site. Analytical methods of relevant engineering concepts with arithmetic computation and logic are used.

### 4.4 DESIGN CRITERIA

The criteria itemized in Section 4.2 of BSC (2002b) are, in general, applicable for this calculation. The current project design criteria are contained in BSC (2006b). Applicable criteria are briefly summarized below.

1. The final building grades will be above the probable maximum flood level (BSC 2006b, Section 6.1.9).
2. The nominal grades within pad areas shall be as required to provide proper drainage (BSC, 2006b, Section 4.2.1.7).
3. The pad configuration will prevent ponding of water (BSC 2006b, Section 4.2.1.6).
4. Site drainage will direct natural surface runoff around surface facilities (BSC 2006b, Section 4.2.1.6).
5. Fill side slopes will be no greater than 2 horizontal to 1 vertical (BSC 2006b, Section 4.2.1.7).
6. A minimum surcharge pressure of 300 psf shall be applied for the design of all subsurface walls (BSC, 2006b, Section 4.2.11.3.5).
7. The layout will locate the surface facilities near the North Portal of the repository.

Refer to Sections 4.2 of BSC (2002b) and BSC (2006b) for more thorough descriptions.

## 5 LIST OF ATTACHMENTS

### 5.1 APPENDICES

Analyses performed for use in the study herein are documented in the following attached appendices:

**Appendix A:** Seismic Wave Velocity

**Appendix B:** Bearing Capacity and Settlement

**Appendix C:** Lateral Earth Pressures and Resistance to Lateral Loads

## 6 BODY OF CALCULATION

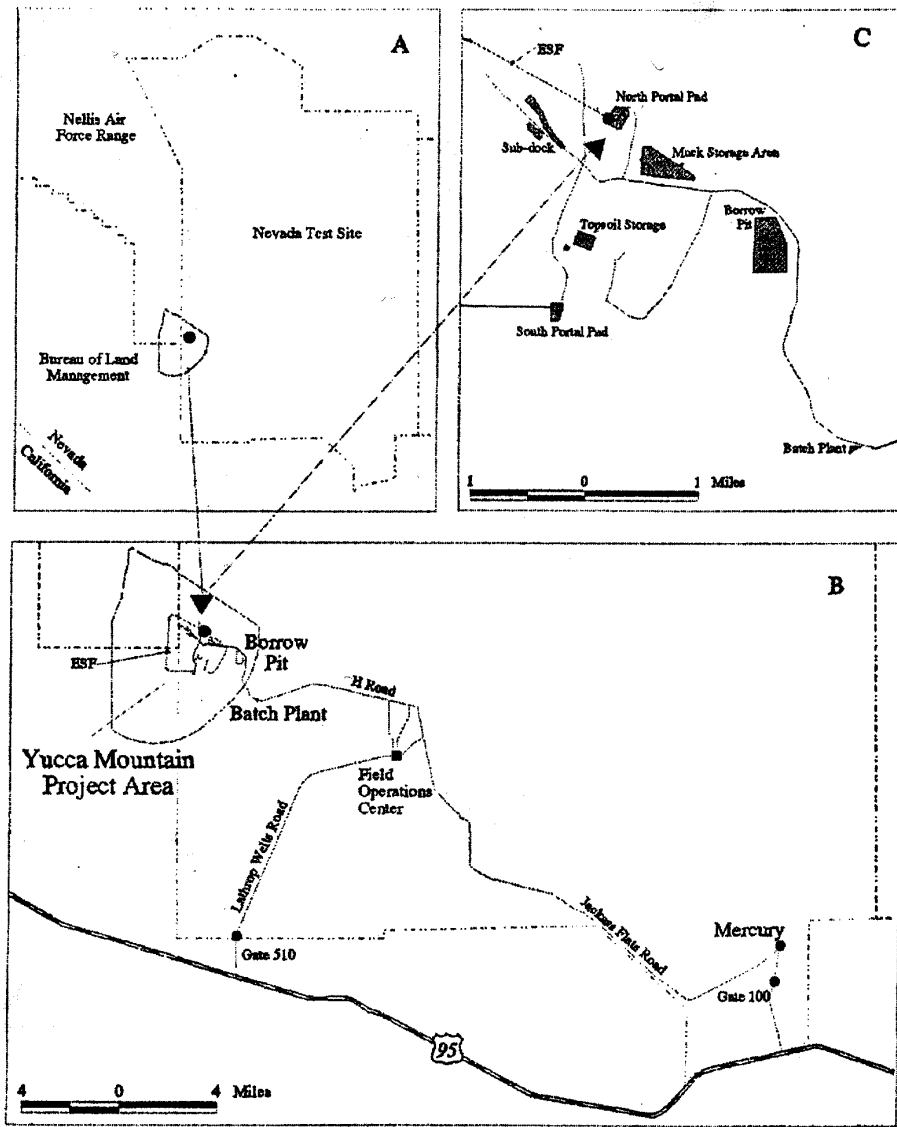
### 6.1 SITE DESCRIPTION

#### 6.1.1 Location

The YMP site is situated in the southwestern part of U.S. Department of Energy (DOE) Nevada Test Site (NTS), and on parts of adjacent Nellis Air Force Range and U.S. Bureau of Land Management (BLM) lands (See Section 1.2.1 of CRWMS M&O 1999). The site of the potential surface facilities is totally within Area 25 of the NTS. The surface facilities site extends east from the North Portal Pad, which is the fill pad that was constructed for the Exploratory Studies Facility (ESF). A small portion of the site in the northwest corner lies within engineered fill. The site is approximately 27 miles west-northwest of Mercury, Nevada (Figure 6-1) and is located in Nye County, Nevada approximately 100 miles northwest of the city of Las Vegas.

The approximate northing and easting coordinate ranges of the proposed site are N764,000 to N767,000 and E570,000 to E573,000, respectively (Nevada State Plane). The latitudinal and longitudinal coordinates are  $36^{\circ} 50'$  and  $116^{\circ} 26.5'$ , respectively.





- A - Nevada Test Site in Southern Nevada
- B - Yucca Mountain Project Area in the Nevada Test Site
- C - ESF Surface Facilities



Yucca Mountain Site  
Characterization Project

Figure 1-1  
INDEX MAP

Figure 6-1. Site Vicinity Map (Figure 1-1 from CRWMS M&O 1999).

### 6.1.2 Summary of Site Geology

The surface facilities site lies on the western edge of the central portion of the Midway Valley at the eastern toe of Exile Hill. Yucca Mountain lies about 2 miles west of the surface facilities site. Figure 6-2 shows the general geologic features in the vicinity of the site, with the surface facilities area indicated near the center of this figure.

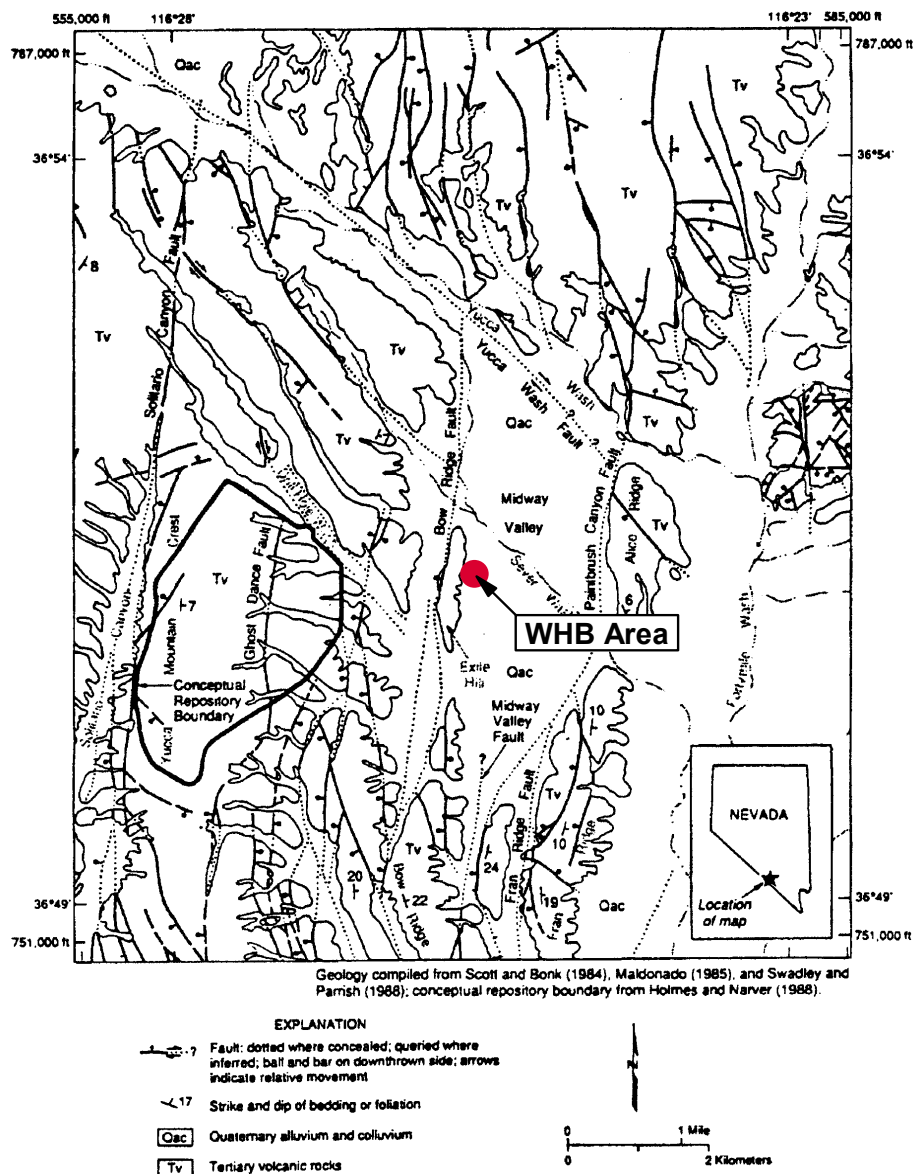


Figure 6-2. Generalized Map of the Midway Valley area. (Fig. 1-1 from Gibson et al. 1992).

The generalized geology of the site consists of alluvial and colluvial deposits overlying tuffitic bedrock. Volcanic rocks of Miocene age dominate the area. Small, intermittent flood-type drainage deposits cross the site area from west to east. The alluvial and colluvial deposits, which originated from Yucca Mountain on the west, vary from about 60 to 120 feet thick under the current building layout and deepen to several hundred feet in the center of the Midway Valley. Thorough descriptions of the geologic settings in the area can be found in Section 2 of CRWMS M&O (1999) and Section 6.6 of BSC (2002a) and their corresponding references.

### **6.1.3 Existing Conditions and Surface Features**

The existing surface conditions and features are succinctly summarized in the following paragraphs, which were excerpted from Section 1.2.1 of CRWMS M&O (1999):

“The ground surface elevation in the vicinity of the WHB [surface facilities] site ranges from about 3,000 feet in the lower reaches of Forty Mile Wash, southeast of the site, to over 6,000 feet in the closer areas of Timber Mountain Caldera, about 4 miles to the north.

The crest of Yucca Mountain averages roughly 4,900 feet in elevation. Relief near the site of the WHB [surface facilities] site is approximately 250 feet, from roughly 3,850 feet elevation at the crest of Exile Hill, immediately west of the site, to roughly 3,600 feet elevation at the center of Midway Valley, east of the site.

The North Portal Pad is located along the western margin of Midway Valley, at the eastern base of Exile Hill. It is an area of approximately 800 to 1,200 feet by 600 to 700 feet of man-made fill sloping roughly 2 degrees to the east, and is situated at approximately 3,670 to 3,683 feet elevation. Muck piles along the eastern side of the North Portal Pad rise to approximately 3,700 feet elevation. The eastern part of the surface facilities footprint is in the area of the present muck piles.

Beneath fill placed for the North Portal Pad is a variable thickness of colluvial and alluvial material overlying Tertiary volcanic bedrock units. The North Portal Pad is the surface at which the ESF tunnel portal was constructed. The pad supports the muck-handling facilities for the tunnel excavation, as well as offices, shops and rail equipment supporting the boring of the ESF tunnel, and facilities for engineering and scientific testing in the ESF.”

### **6.1.4 Subsurface Conditions**

This section provides a general description of some of the subsurface conditions at the surface facilities area. The descriptions of the subsurface conditions are based on information obtained from existing boreholes in the area. Refer to BSC (2002a) Section 6.6.2 and BSC (2002b) Section 6 for more detail. Figure 6-4 and Figure 6-5 show existing geologic cross-sections near the site. The cross-sections are taken from Figures 225, cross-section A-A' and 226, cross-section B-B' of BSC (2002a) and span in the NW-SE and NE-SW directions, respectively. The locations of these cross-sections and the layout of the proposed facilities are shown in Figure 6-7. Although these cross-sections do not span through the area of the current layout of the proposed

facilities, they present a general summary of the expected subsurface conditions. It should be noted that these cross-sections were based on data tracking numbers GS020383114233.003 and MO0008GSC00286.000. GS020383114233.003 has been superseded by GS030783114233.001 to account for bedrock depth corrections. The revisions in GS030783114233.001 are not reflected in Figure 6-4 and Figure 6-5. However, the differences are relatively minor and will not affect the recommendations of this calculation. A sketch of the stratigraphy beneath a typical surface facility is shown in Figure 6-6.

#### **6.1.4.1 Existing Fill**

Non-engineered fill, varying in thickness from 5 to 34.8 feet (refer to DTNs - GS020383114233.003, GS070683114233.005, MO0707RFGNDMV1.000, and MO0708SMFGLGIB.000, and Figure 6-10 for fill contact depths), covers the surface of the western edge of the proposed structures at the site. The existing fill it is planned to be removed prior to the construction of the surface facilities (see BSC 2002b, Section 6.1) and be replaced by an engineered fill. Section 3.7 of CRWMS M&O (1999) provides more information about the existing fill. It is understood that the fill consists of tunnel muck material from the exile hill, and from borrow areas of Fran Ridge and Forty-mile Wash. Note that Section 5, Assumption 10 of BSC (2002b) states that 28 feet of existing fill was initially logged in one of the borings at the surface facilities area (UE-25 RF#20) and may have been misidentified during field exploration. For that location, the existing fill may, instead, have been only 9 feet thick.

#### **6.1.4.2 Alluvium**

Beneath the existing fill there is a layer of alluvial material, consisting of interbedded calcite-cemented (caliche) and non-cemented poorly sorted, coarse-grained gravel with sand and some fines, cobbles, and boulders (refer to Tables 4 and 5 of BSC 2002a and Table 6-1, for alluvium contact depths). Available information indicates that the thickness of the alluvium is likely to vary considerably at some locations due to irregular erosion. Furthermore, cemented and uncemented soil layers appear randomly within this soil unit. The alluvium generally ranges in thickness from about 75 ft feet to 192 ft, under the major building footprints with the thickness increasing eastward from Exile Hill (see Figure 6-9). Note that Section 5, Assumption 9 of BSC 2002b states that alluvium logged in borehole UE-25 RF#21 between 70 and 115 feet may have been misidentified and may, in fact, be bedrock.

#### **6.1.4.3 Bedrock**

As Section 6.3 of BSC (2002b) asserts, there are non-welded and welded tuffs from the units of Timber Mountain and Paintbrush groups underlying the surface deposits of fill and alluvium.

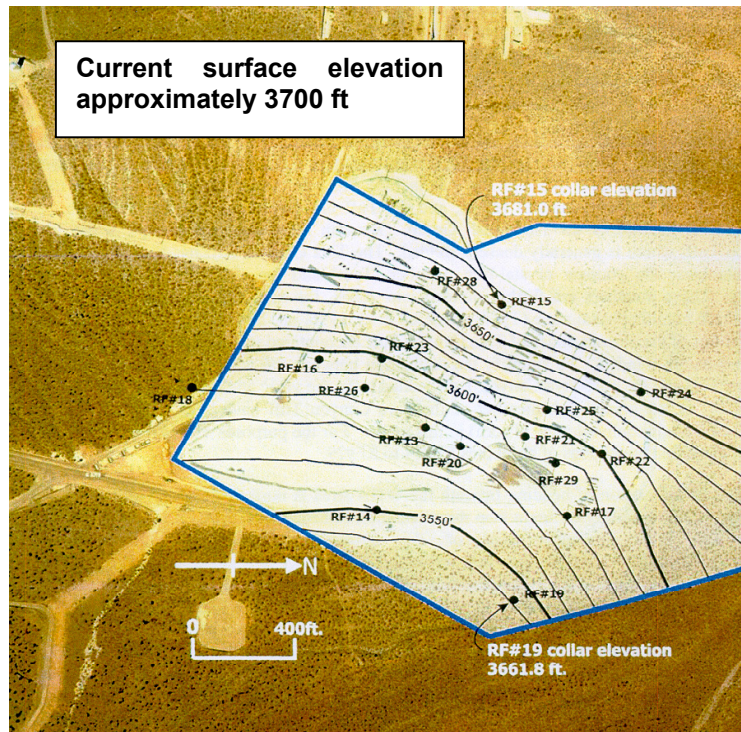
The non-welded units include the following:

- Pre-Rainier Mesa Tuff bedded tuffs (Tmbt1) of the Timber Mountain Group
- Tuff unit “x” (Tpki) of the Paintbrush Group
- Pre-Tuff unit “x” bedded tuffs (Tpbt5) of the Paintbrush Group

Beneath the non-welded units is the densely welded Tiva Canyon Tuff consisting of the following:

- Younger crystal-rich member (Tpcr)
- Older crystal-poor member (Tpcp)

Both of the Tiva Canyon Tuff members are further divided into zones. Refer to Section 6.6.2 and Attachments I and II of BSC (2002a) for a detailed geologic description of the bedrock. Figure 6-3 shows elevation contours for the top-of-bedrock (Figure 232 of BSC 2002a).



**Figure 6-3. Elevation Contours for Top-of-Bedrock Encountered in Boreholes (Figure 232 of BSC 2002a)**

#### 6.1.4.4 Groundwater

Groundwater data relevant to the area is summarized in Section 6.6.3 of BSC (2002a). The groundwater table is located at a typical depth of 1,270 feet below the present ground surface, and is over 1,000 feet below the top of bedrock in the North Portal Area. Hence, groundwater does not affect the geotechnical calculations presented in this study.

#### 6.1.4.5 Proposed Engineered Fill

It is assumed that the existing fill will be removed and that the surface facilities will be founded on the native alluvium soil. Any required engineered fill will likely be obtained from the alluvial sand and gravel deposits at the Fran Ridge Borrow Area, which is located approximately

1.5 miles southeast of the surface facilities. However, due the large design lateral and vertical accelerations, alternative measures are being considered to lock the structures to the ground by a more positive means, such as roller-compacted soil cement (RCSC). Section 6.1.4.6 below discusses estimated properties of RCSC for design evaluation purposes.

#### **6.1.4.6 Roller-Compacted Soil Cement**

A literature review was performed to define typical soil properties for use in evaluating potential benefits of using roller-compacted soil cement to replace the tunnel muck that currently underlies the surface facilities site (see BSC 2004b). Papers regarding properties of roller-compacted concrete as well as deep soil mix technologies were reviewed. It is anticipated that a soil-concrete mixture could provide the desired soil response properties for seismic design of the structures and simultaneously provide a high quality control in the field. The report resulting from the literature review is provided in BSC (2004b).



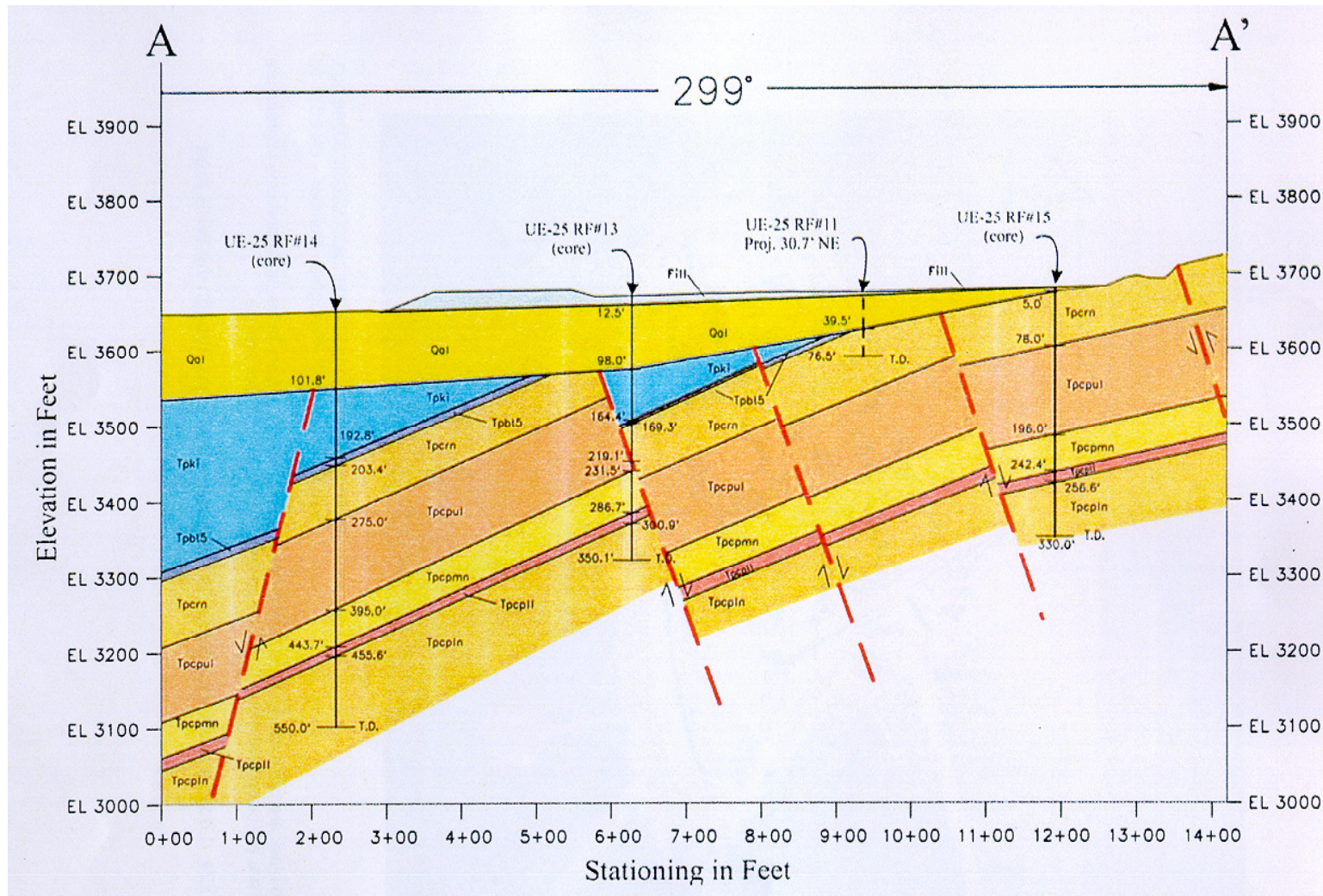
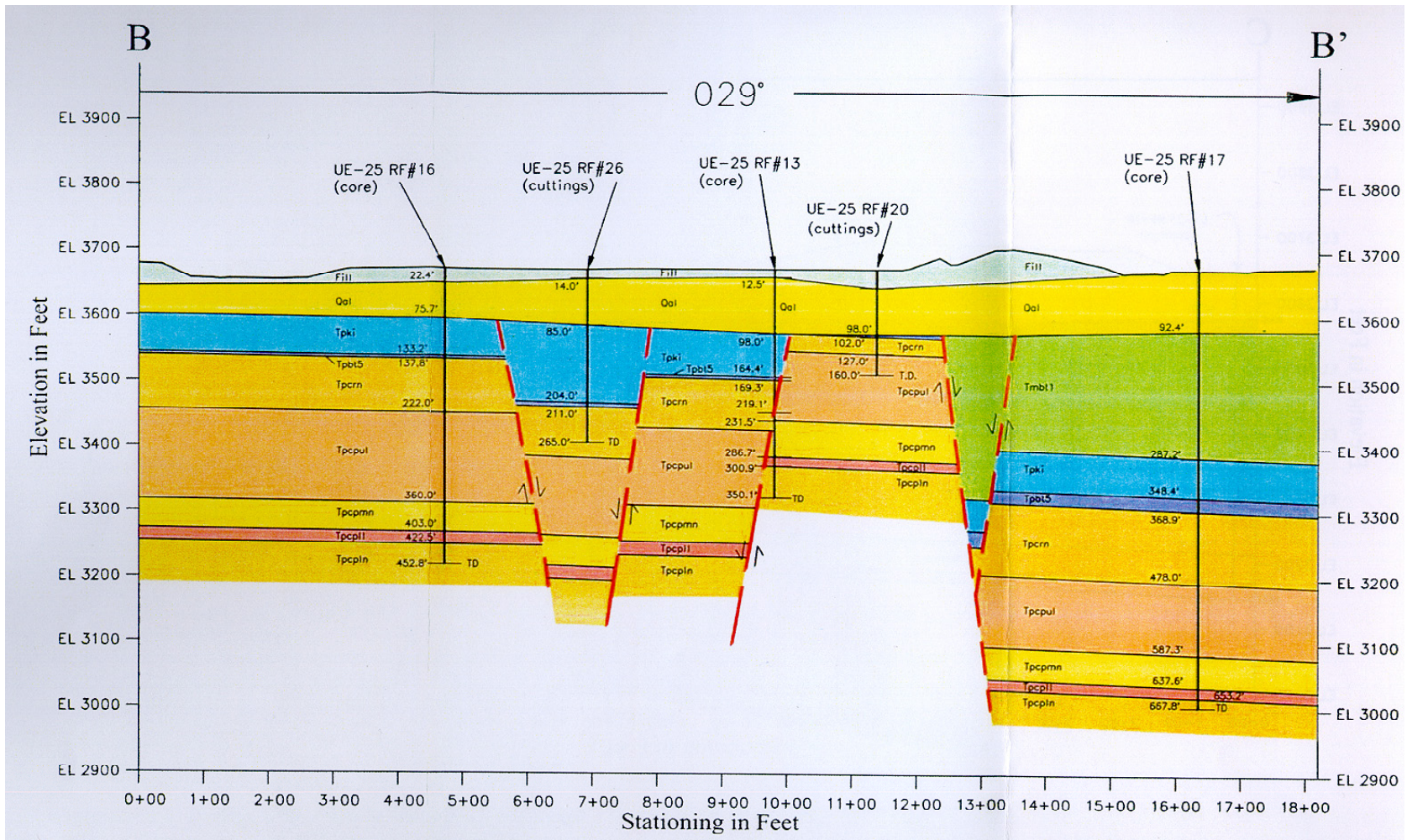


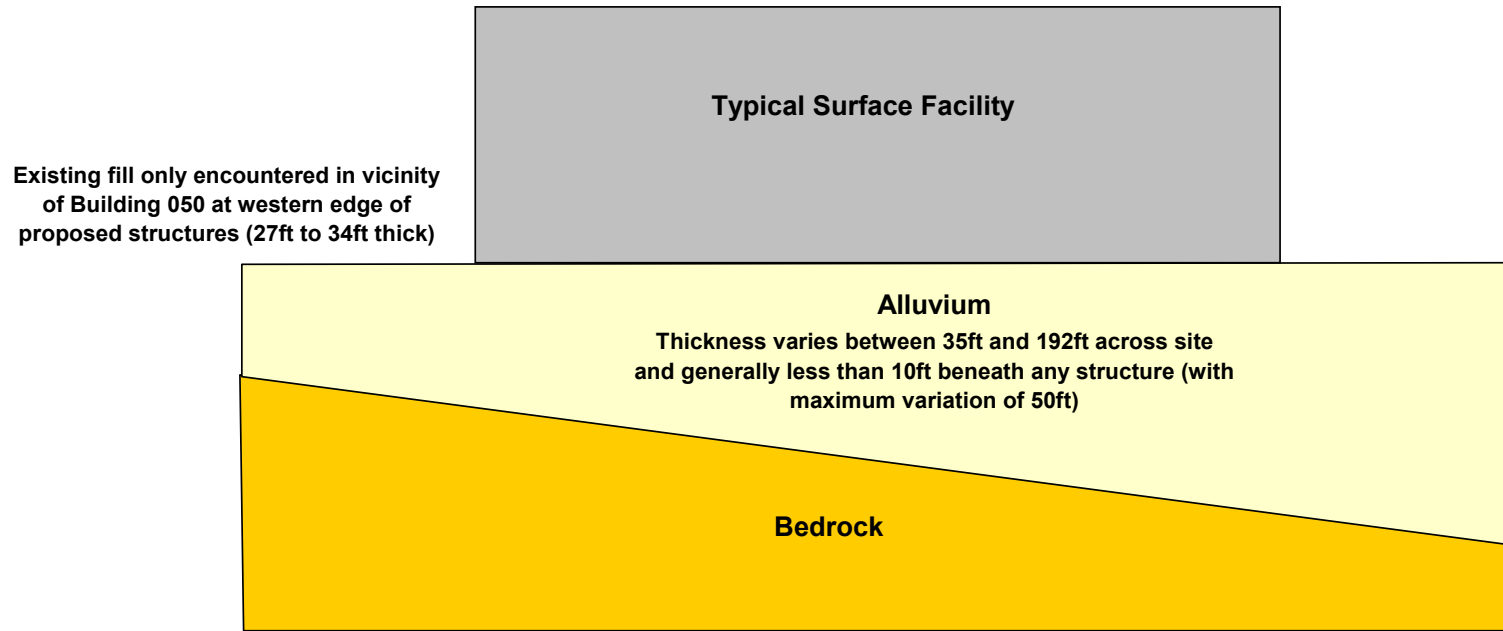
Figure 6-4. Surface Facilities Area Geologic Cross Section A-A'. (Figure 225 of BSC 2002a and Assumption 6 of BSC 2002a, DTN:MO0008GSC00286.000—see Figure 6-7 for the location of the cross-section)





**Figure 6-5. Surface Facilities Area Geologic Cross Section B-B'. (Figure 226 of BSC 2002a, DTN:MO0008GSC00286.000—see Figure 6-7 for the location of the cross-section)**





**Figure 6-6. Sketch of Stratigraphy Underlying Typical Surface Facility (not to scale).**

## 6.2 FIELD EXPLORATION AND TESTING

The following sections summarize the soil investigations and field tests performed in the surface facilities area. Soil investigations in the surface facilities area have been conducted since the mid-1980s. Data obtained at the site (as presented in the BSC 2002a and BSC 2002b references) is primarily relied upon as the direct input for the analyses contained in this report. The subsurface investigations for BSC 2002a and BSC2002b were performed within 2000 and 2001. Additional investigations were performed in 2005 that included borings and test pits with associated field and laboratory testing, and SASW measurements. These latter investigations were performed to augment and confirm the previously existing information and to investigate subsurface conditions in new areas resulting from building layout reconfigurations. Other data acquired from explorations prior to those covered in the BSC 2002a and BSC 2002b investigations are used as corroborative information.

### 6.2.1 Field Exploration

#### 6.2.1.1 Borings

Within the surface facilities area, 15 total boreholes (UE-25 RF#14 to RF#26, RF#28, and RF#29) were drilled in 2000 using core hole and mud rotary drilling techniques. Depths of the borings ranged from approximately 100 to 670 feet below top of bedrock (Table 4, Bechtel 2002a). A previous boring (UE-25 RF#13) was cored in 1998 to a depth of approximately 350 feet (Table 5, Bechtel 2002a).

Eighteen addition shallow borings were drilled in 2005 using the sonic coring technique to depths varying between 104 feet and 417 feet, primarily to determine the depth of alluvium in the surface facilities area and to augment the geologic understanding of the area. In addition, a series of laboratory gradation tests were performed on selected samples of the alluvial material obtained from two of the sonic cores.

A boring designated as NRG#1 was drilled at the top of the nearby Exile Hill in 1992 (McKeown 1992). Studies performed between 1984 and 1985 (Neal 1985, and Neal 1986) produced 4 borings located within the surface facilities area (UE-25 RF#3, RF#3b, RF#9, and RF#11).

The coordinates of all borings drilled in the surface facilities area are provided in Table 6-1. The locations of the pre-2005 borings are shown in Figure 6-7 overlain on an aerial photograph. Figure 6-8 shows all the boring locations, including those drilled in 2005 and in 2006-2007, with respect to the planned building footprints. Note that the full depth of some of the borings drilled in the 2006-2007 timeframe are not shown, as only the upper portion of the logging were properly reviewed and qualified in time for use in this report. As seen in the figure, numerous borings were drilled northwest of the most recent proposed building layout due to changes in the building arrangement during the course of the investigative studies. The depth of rock encountered in each of the borings is indicated in Figure 6-9. In general, the rock depth increases from about 75 ft at the southwest end of the building area to as much as 192 ft at the northeast end. The depth of fill encountered at each of the boring locations is depicted in Figure 6-10.

### 6.2.1.2 Test Pits and Trenches

Previous investigations in the surface facilities area during the 1980s and 1990s included numerous excavations of shallow test pits (designated as NNWSI, SFS, NRSF, GSF and MWV-P) and trenches (MWV-T). Documentation of these test pits is provided in Holmes & Narver 1983, Ho et al. 1986, McKeown 1992, and Map ID SA95-9-15 of DOE 1995. The pre-2005 test pit locations are shown in Figure 6-7.

Investigations performed from 2000 to 2001 included four test pits (TP-WHB-1 to -4) excavated in the surface facilities area. The test pits were each excavated to a depth of approximately 20 feet into the alluvial material. No fill was encountered in these test pits. A total of 22 samples of the alluvium were obtained from the four test pits for laboratory testing.

In 2006 three additional test pits (TP-WHB-5, TP-WHB-6, and TP-WHB-7) were excavated in the surface facilities area to observe subsurface conditions, to perform insitu density tests, and to obtain both disturbed and undisturbed samples for laboratory testing. Each excavation extended to about a 20-foot depth into native alluvium material.

All test pit locations excavated within the site vicinity are shown in Figure 6-11 in relation to the planned building footprints. Table 6-2 provides a summary of all known test pits and trenches excavated in the surface facilities area. None of the test pits extended below alluvial material.

Four disturbed samples of material to be potentially used as engineered fill were obtained from the existing borrow area (Fran Ridge Borrow Area) at widely spaced locations. The location of Fran Ridge is shown in Figure 1-1. Figure 6-12 (taken from Figure 213 of BSC 2002a) shows the sampling locations taken from the Fran Ridge Borrow Area. These samples were combined into a composite sample and taken to offsite laboratory facilities for testing.

**Table 6-1. Boring Information in Surface Facilities Area.**

Date	Identification	Coordinates (Nevada State Plane), ft		Surface Elevation (ft)	Total Depth (ft)	Fill Thickness (feet)	Depth to Rock (ft)	Source
		Northing	Easting					
March 1984 & July 1985	UE-25 RF#1	765,575	571,100	3,657.7	301		91	Neal (1985) & Neal (1986)
	UE-25 RF#3B	765,695	571,066		111			
	UE-25 RF#9	765,945	570,643		105		105	
	UE-25 RF#11	765,622	570,435		77		39.5	
November 1992	UE-25 NRG#1	765,359	569,803		150.1			McKeown (1992)
October 1998	UE-25 RF#13	765,500	570,720	3,671.1	350.1	12.5	98	BSC (2002a) DTN:GS030783114233.001
June - November 2000	UE-25 RF#14	765,309	571,066	3,651.4	550		101.8	
	UE-25 RF#15	765,774	570,225	3,680.8	330	5.0	6.5	
	UE-25 RF#16	765,056	570,473	3,672.0	452.8	22.4	75.7	
	UE-25 RF#17	766,076	571,042	3,673.4	667.8		96.1	
	UE-25 RF#18	764,522	570,627	3,640.3	493.6		65	
	UE-25 RF#19	765,880	571,384	3,661.6	645.2		120	
	UE-25 RF#20	765,637	570,797	3,671.1	160	28	98	
	UE-25 RF#21	765,899	570,739	3,672.9	192.2		115	
	UE-25 RF#22	766,206	570,793	3,680.3	540.6		80	
	UE-25 RF#23	765,311	570,465	3,673.9	159.1	12	76	
	UE-25 RF#24	766,345	570,543	3,685.8	268	10	30	
	UE-25 RF#25	765,968	570,627	3,676.4	159	10	70	
	UE-25 RF#26	765,248	570,580	3,670.8	264.9	14	85	
	UE-25 RF#28	765,510	570,105	3,680.2	99.8	5	15	
UE-25 RF#29	766,018	570,836	3,672.6	430		85		
April - June 2005	UE25 RF-42	764,633	571,142	3,634.9	118.9		84	DTN: GS070683114233.005
	UE25 RF-43	765,376	570,709	3,669.9	110.1	19.4	90.5	
	UE25 RF-44	765,419	570,829	3,676.3	143.5	26.8	108	
	UE25 RF-45	765,268	571,022	3,650.0	125.5		93	
	UE25 RF-46	764,890	570,603	3,669.2	103.5	27.2	84.2	
	UE25 RF-47	765,747	571,077	3,663.9	122.3		97	
	UE25 RF-48	765,474	571,387	3,653.6	159.3		113.3	
	UE25 RF-49	766,059	571,421	3,668.8	142.9		112.9	
	UE25 RF-50	765,785	571,698	3,656.3	155.5		123.2	
	UE25 RF-51	766,314	571,672	3,672.0	156.7		128.4	
	UE25 RF-52	766,557	571,915	3,672.4	184.7		164.7	
	UE25 RF-53	766,040	571,948	3,661.3	160.6		138.2	
	UE25 RF-54	766,279	572,190	3,661.6	196.7		183.0	
	UE25 RF-55	765,112	571,531	3,642.2	154.2		110.2	
	UE25 RF-56	765,439	571,857	3,646.8	416.9		129.9	
	UE25 RF-58	763,061	571,073	3,667.7	150.7		134.2	
UE25 RF-59	762,347	571,407	3,664.6	179		155.3		
UE25 RF-60	761,667	571,809	3,650.1	195.6		144.5		

**Table 6 1 (cont'd). Boring Information in Surface Facilities Area**

Date	Identification	Coordinates (Nevada State Plane), ft		Surface Elevation (ft)	Total Depth (ft)	Fill Thickness (feet)	Depth to Rock (ft)	Source
		Northing	Easting					
2006-2007	UE-25 RF#31	765,614	571,327	3,657.1			105.5	DTNs: MO0707RFGNPMV1.000, MO0708SMFGLGIB.000
	UE-25 RF#33	763,730	570,460	3,671.3			87.6	
	UE-25 RF#34	764,942	570,753	3,684.1		33.6	115.4	
	UE-25 RF#35	767,763	573,480	3,693.8			110.7	
	UE-25 RF#36	766,480	572,155	3,664.6			171.8	
	UE-25 RF#37	765,562	571,996	3,647.6			130.1	
	UE-25 RF#38	766,760	571,874	3,673.5			148.7	
	UE-25 RF#39	765,095	571,264	3,644.6			100.4	
	UE-25 RF#41	766,715	572,950	3,666.1			192.4	
2006-2007	UE-RF#64	767,880	568,919	3,787.6			69.5	DTNs: MO0707RFGNPMV1.000, MO0708SMFGLGIB.000
	UE-RF#75	771,417	570,954	3,851.4			60.4	
	UE-RF#76	771,732	570,564	3,870.9			132	
	UE-RF#78	770,082	570,895	3,806.0			135.5	
	UE-RF#79	770,399	570,480	3,818.2			132.3	
	UE-RF#80	769,769	570,480	3,796.1			127.9	
	UE-RF#83	766,679	573,151	3,662.8			142.2	
	UE-RF#95	768,844	571,573	3,753.0			182.1	
	UE-RF#97	767,184	570,596	3,711.0			79.1	
	UE-RF#104	763,719	570,163	3,682.6			50.3	
	UE-RF#105	763,877	570,121	3,679.5			35.4	
	UE-RF#106	763,725	570,246	3,677.6			62.6	
	UE-RF#107	763,608	570,272	3,681.0			72.2	
UE-RF#112	765,284	570,872	3,688.8		34.8	121		

Notes:  
RF—Repository Facility

**Table 6-2. Test Pit and Trench Information in surface facilities area.**

Seq. No.	Date	Identification	Coordinates (Nevada State Plane), ft		Source
			Northing	Easting	
1	May 1983	NNWSI 2	764,850	570,941	Holmes & Narver (1983)
2	May 1984	SFS-3	764,850	570,941	Ho et al (1986)
3	Spring 1992	NRSF-TP-1	765,193	569,828	McKeown (1992) & DOE (1995)
4		NRSF-TP-2	765,313	569,892	
5		NRSF-TP-3	765,359	569,946	
6		NRSF-TP-4	765,383	569,998	
7		NRSF-TP-5	765,430	569,977	
8		NRSF-TP-6	765,510	570,002	
9		NRSF-TP-7	765,463	570,093	
10		NRSF-TP-8	765,506	570,101	
11		NRSF-TP-9	765,571	570,029	
12		NRSF-TP-10	765,669	570,015	
13		NRSF-TP-11	765,638	570,206	
14		NRSF-TP-12	765,641	570,035	
15		NRSF-TP-13	765,798	570,140	
16		NRSF-TP-14	765,700	570,244	
17		NRSF-TP-15	765,837	570,228	
18		NRSF-TP-16	765,790	570,344	
19		NRSF-TP-17	765,916	570,277	
20		NRSF-TP-18	765,860	570,382	
21		NRSF-TP-19	765,621	570,511	
22		NRSF-TP-20	765,541	570,436	
23		NRSF-TP-21	765,599	570,346	
24		NRSF-TP-22	765,521	570,313	
25		NRSF-TP-23	765,462	570,390	
26		NRSF-TP-24	765,218	570,255	
27		NRSF-TP-25	765,113	570,360	
28		NRSF-TP-26	765,016	570,036	
29		NRSF-TP-27	765,256	570,246	
30		NRSF-TP-27a	765,259	570,330	
31		NRSF-TP-28	765,093	570,256	
32		NRSF-TP-29	765,107	570,201	
33		NRSF-TP-30	765,127	570,156	
34		NRSF-TP-31	764,987	570,135	
35	NRSF-TP-32	765,084	569,969		

## Notes:

1. NNWSI–Nevada Nuclear Waste Site Investigation
2. SFS–Surface Facility System
2. NRSF–North Ramp Surface Facilities
3. SFS-3 was deepened from pre-existing NNWSI 2

**Table 6-2. Test Pit and Trench Information in surface facilities area (continued)**

Seq. No.	Date	Identification	Coordinates (Nevada State Plane), ft		Source
			Northing	Easting	
36	September 1992	GSF-TP-1	765,966	570,884	USBR (1992)
37		GSF-TP-2	765,539	571,110	
38		GSF-TP-3	765,040	571,110	
39		GSF-TP-4	764,519	571,040	
40		GSF-TP-5	764,000	570,935	
41	1992	MWV-P1	765,405	570,849	DOE (1995)
42		MWV-P2	765,259	571,652	
43		MWV-P3	764,148	570,845	
44		MWV-P9	762,931	572,751	
45		MWV-P28	765,178	571,005	
46		MWV-P29	765,147	570,387	
47		MWV-P30	765,149	570,599	
48		MWV-P31	765,150	570,717	
49		MWV-P32	765,189	571,029	
50	MWV-P32a	765,144	571,028		
51	1992	MWV-T5A	765,212	570,501	DOE (1995)
52		MWV-T6	765,173	569,987	
53		MWV-T7	765,482	570,059	
54	July 2000	TP-WHB-1	766,304	570,772	BSC (2002a)
55		TP-WHB-2	765,595	571,106	
56		TP-WHB-3	765,306	571,161	
57		TP-WHB-4	765,950	571,453	
58	August- September 2006	TP-WHB-5	766,398	571,766	DTN: GS070583114233.003
59		TP-WHB-6	766,696	572,372	
60		TP-WHB-7	767,137	572,812	

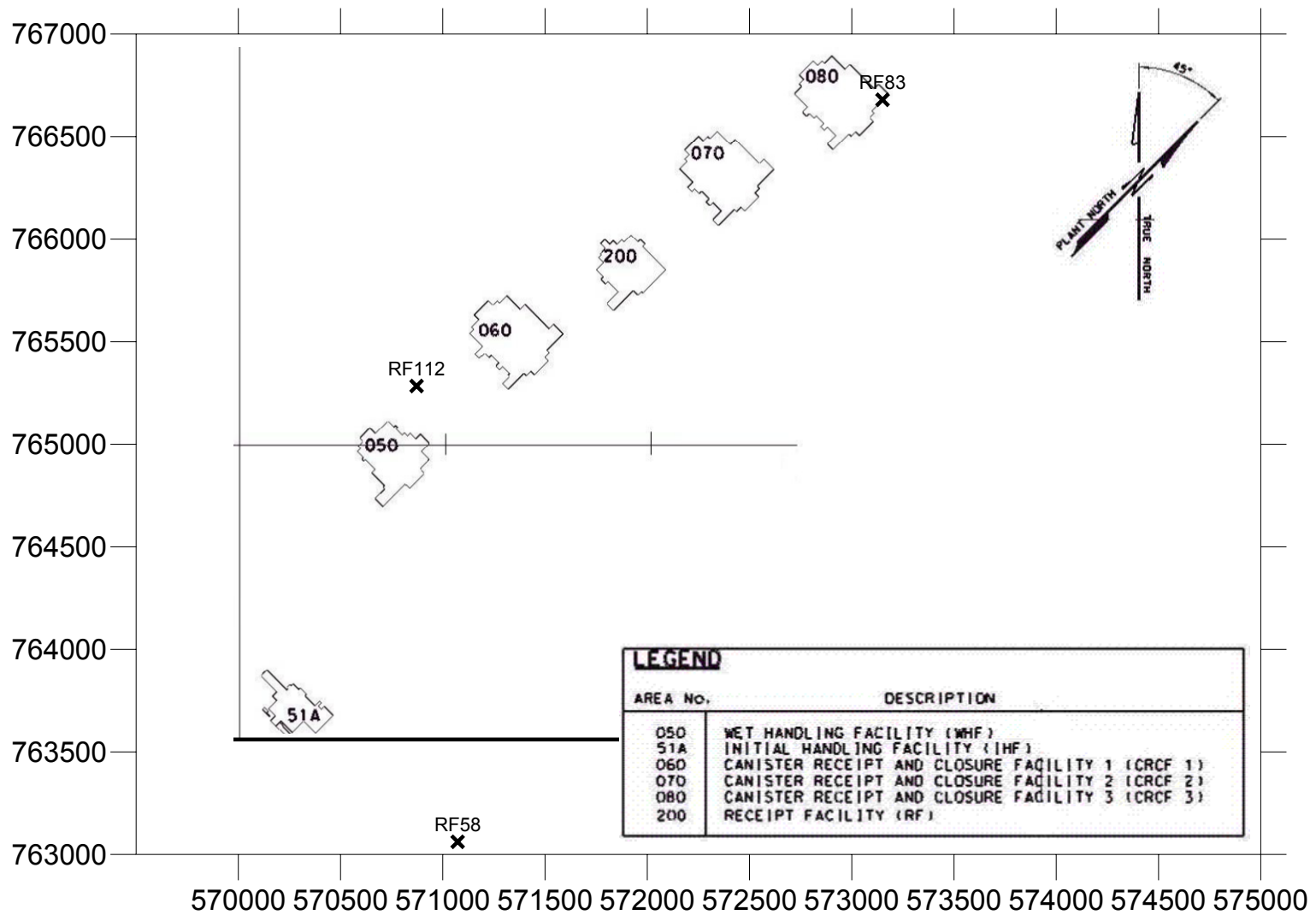
## Notes:

1. GSF–Ground Surface Facility
2. MWV–Midway Valley
3. WHB–Waste Handling Building



**Figure 6-7.** Locations of Soil Exploration in the surface facilities area (only pre-2005 borings shown). Cross-Sections shown in Figure 6-4, Figure 6-5, and Figure 7-1.





**Figure 6-8. Locations of Borings in Surface Facilities Area with respect to Building Footprints (DTNs: GS030783114233.001, GS070583114233.002, GS070683114233.005, MO0707RFGNDMV1.000, MO0708SMFGLGIB.000).**

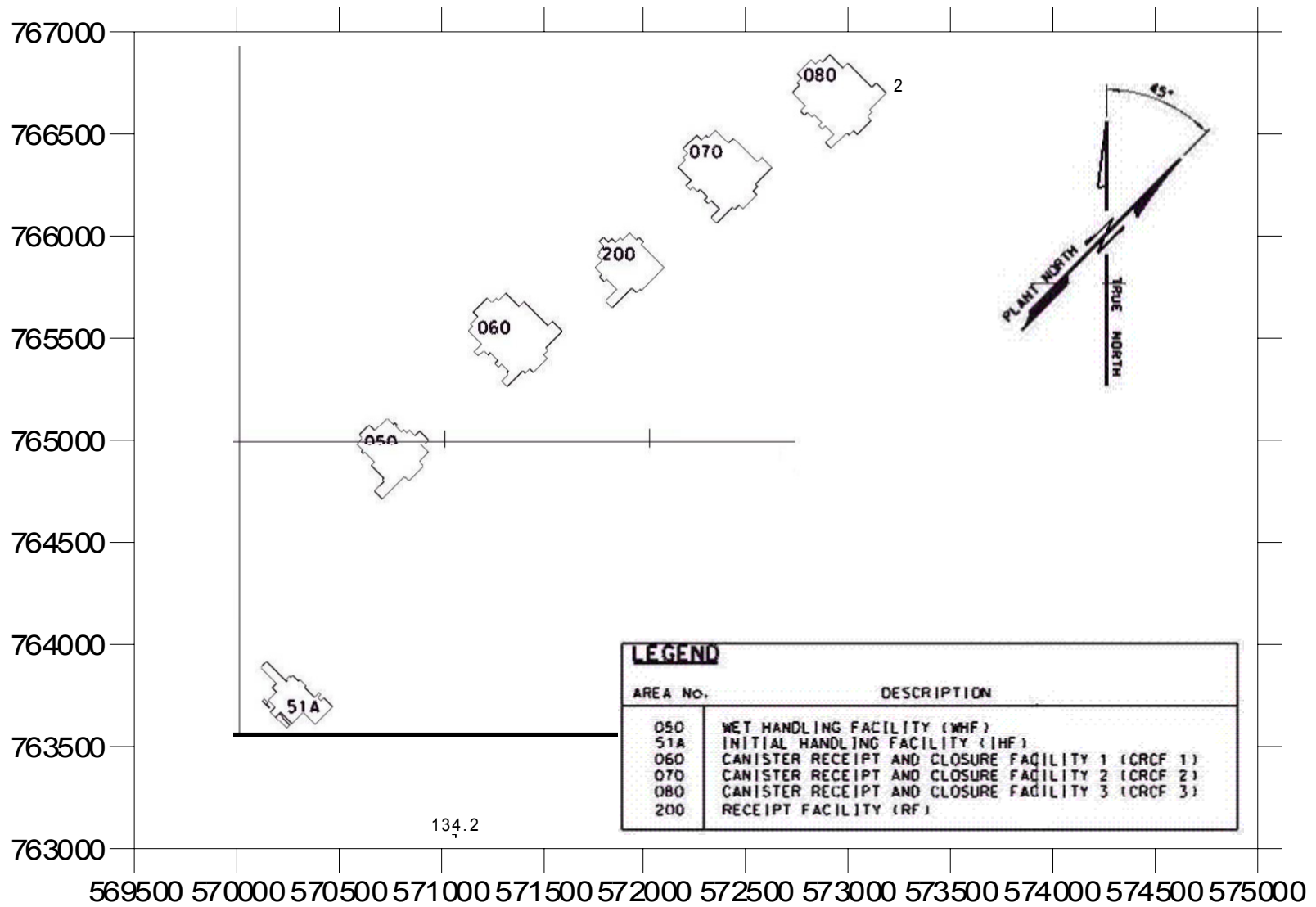


Figure 6-9. Depth to Rock in Building Area (DTNs: GS030783114233.001, GS070583114233.002, GS070683114233.005, MO0707RFGNDMV1.000, MO0708SMFGLGIB.000)

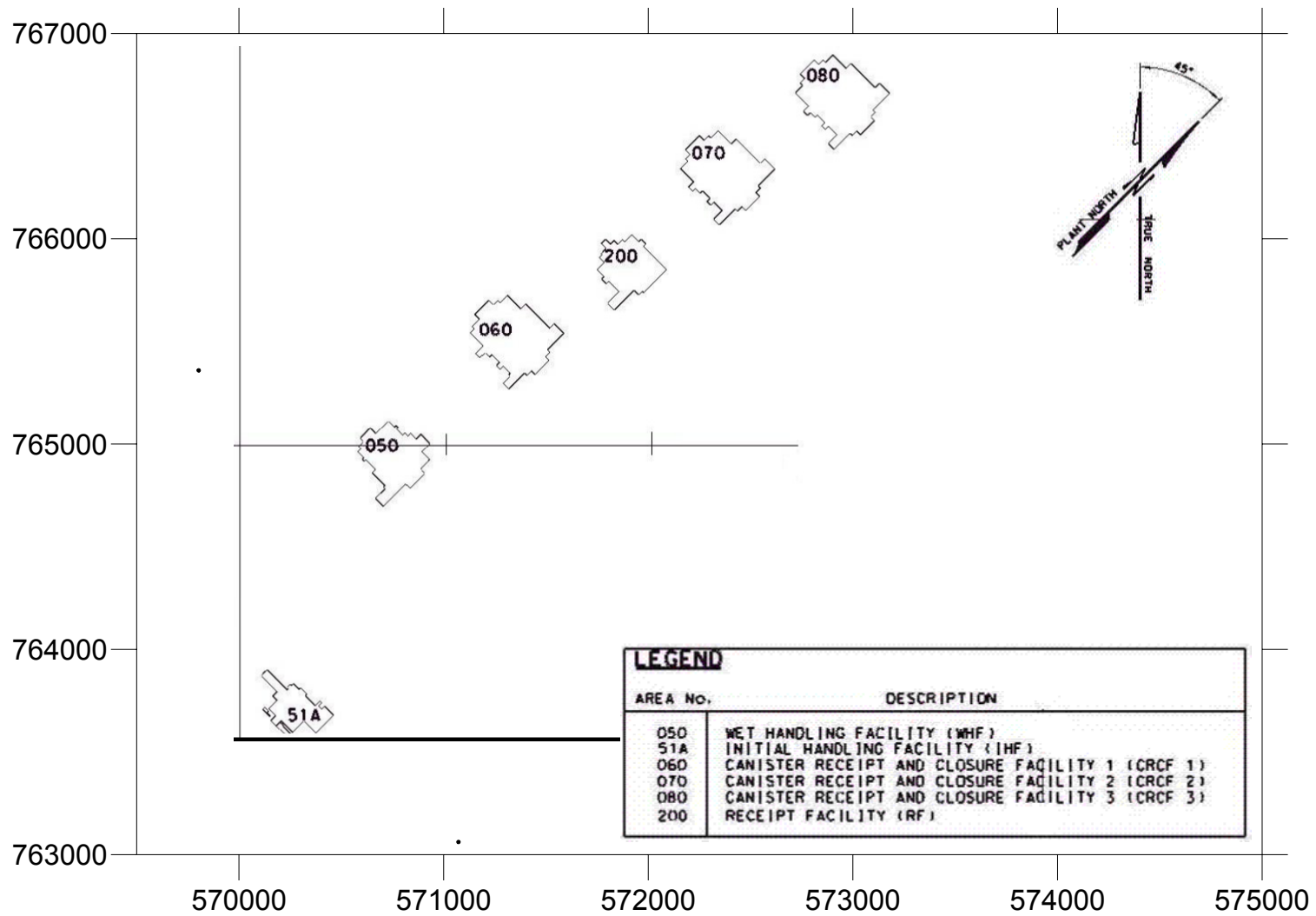
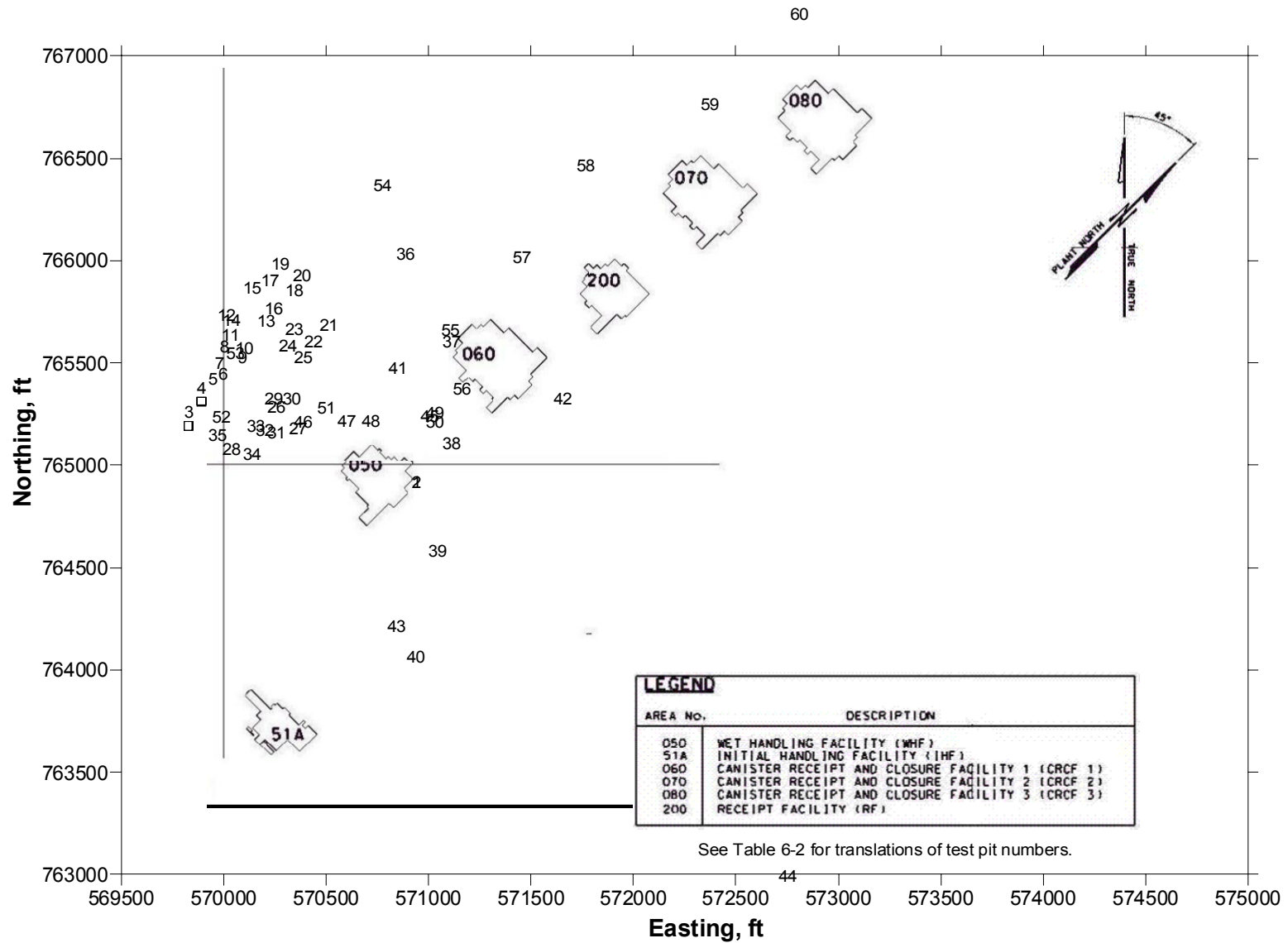
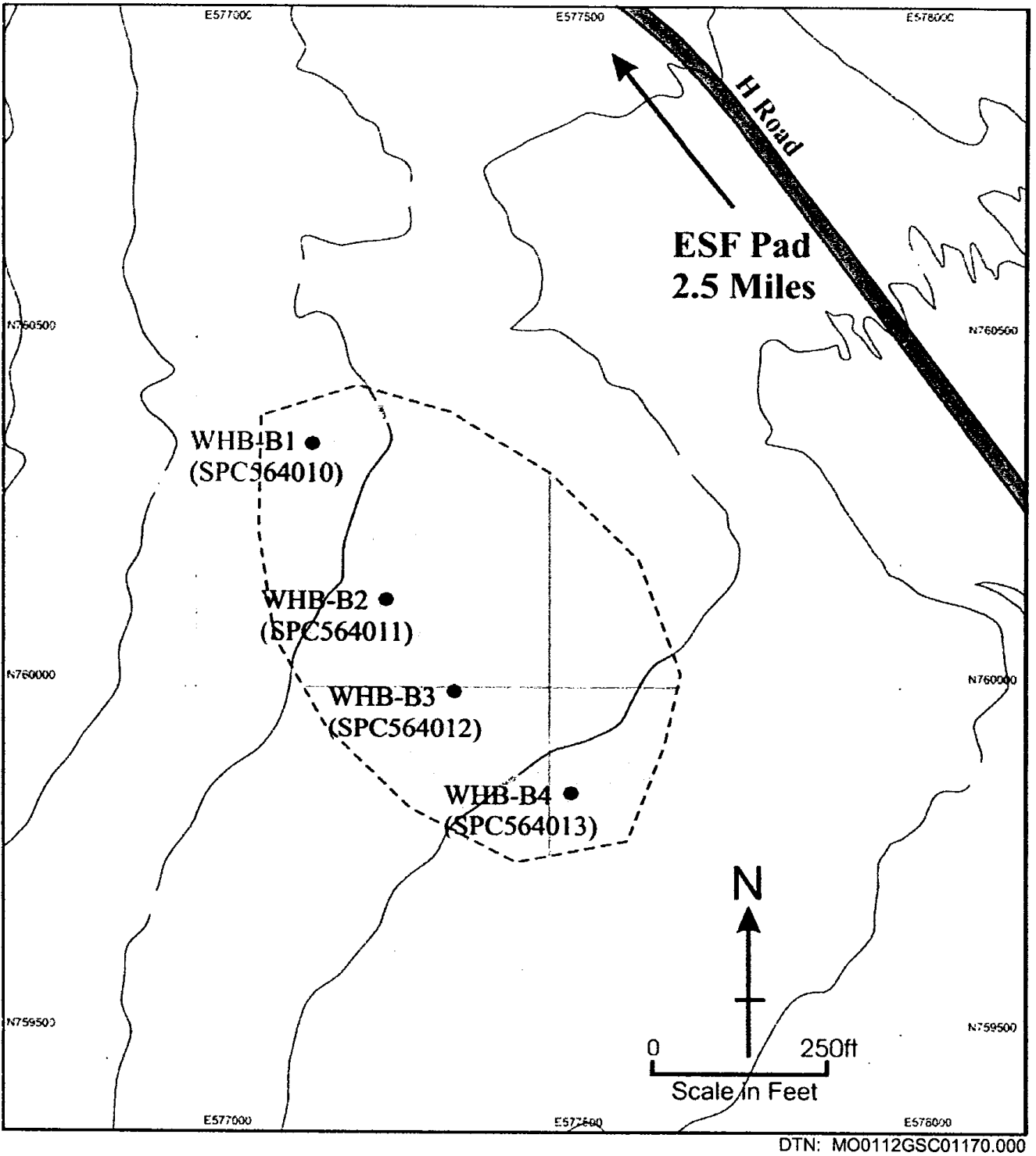


Figure 6-10. Depth of Fill Encountered in Building Area (DTNs: GS030783114233.001, GS070583114233.002, GS070683114233.005, MO0707RFGNDMV1.000, MO0708SMFGLGIB.000)



**Figure 6-11. Locations of Test Pits in Surface Facilities Area with respect to Building Footprints (DTNs: GS020383114233.001, GS070583114233.003).**

December 2007



**Figure 6-12. Location of Fran Ridge Borrow Pit #1 Samples (DTN: MO0112GSC01170.000)**

## 6.2.2 Field Tests

### 6.2.2.1 In-Situ Density Testing

Six 6-foot diameter ring density tests, and sixteen 20-inch diameter sand cone density tests were performed on the alluvial material within test pit excavations in the Fran Ridge borrow area (TP-WHB-1 through TP-WHB-4) from depths of 4 to 20 feet. Caliper and gamma-gamma wireline surveys were also performed in some of the borings primarily to determine the density of the subsurface materials. This is discussed in Section 6.2.2.4. Table 6-3 lists the standards used for the testing.

**Table 6-3. Test Standards Used for In-Situ Density Testing.**

Test	Standard
Ring density test	<ul style="list-style-type: none"> <li>• USBR 7221-89, <i>Procedure for Determining Unit Weight of Soils In-Place by the Water Replacement Method in a Test Pit</i></li> </ul>
Sand cone density test	<ul style="list-style-type: none"> <li>• USBR 7205-89, <i>Procedure for Determining Unit Weight of Soils In-Place by the Sand-Cone Method</i></li> </ul>
Gamma-gamma wireline survey	<ul style="list-style-type: none"> <li>• PA-PRO-0312</li> <li>• , Rev. 0, ICN 0, <i>The Preparation, Planning, and Field Verification of Surface-Based Geophysical Logging Operations</i> (this information is considered historical, therefore, only shown as reference)</li> </ul>

Nine 6-foot diameter ring density tests were also conducted in the 3 test pits performed in 2006. Results of the in-situ density tests are shown in Table 6 of BSC (2002a) and in DTN:GS070683114233.004 and discussed in the material properties (Section 6.4) of this report. The materials from these tests were sealed and taken to an offsite geotechnical laboratory for further soil property and classification testing (See Section 6.4, Material Properties section of this report).

In-place density tests were also conducted for materials from several test pits and borings performed in the mid-1980s to early 1990s (see Table 6-1 and Table 6-2). Methods used to measure the densities included water replacement tests (McKeown 1992), and sand cone and nuclear densometer tests (Ho, et al. 1986). Data from these tests are compiled and used as corroborative information in the analyses contained herein.

### 6.2.2.2 Standard Penetration Tests

Standard Penetration Test (SPT) blowcounts were obtained at 5-foot intervals up to 100 feet in depth in RF#13 using a Modified California (MC) sampler (140-pound hammer with a drop of

30 inches). A review of the literature also revealed that SPT blowcounts were performed in TP-NNWSI2 (up to 5 feet depth) in May 1983 (Holmes & Narver 1983).

### 6.2.2.3 Seismic Velocity Surveys at Surface Facilities Area

Several seismic velocity surveys were conducted in the surface facilities area in order to determine the dynamic characteristics of the subsurface materials. The following 3 methods were used:

1. Downhole (DH)
  - 22 total surveys extending down to approximately 640 feet in depth
2. Suspension logging (DH)
  - 16 receiver-to-receiver surveys extending down to approximately 650 feet in depth
  - 16 source-to-receiver surveys extending down to approximately 650 feet in depth
3. Spectral-analysis-of-surface waves (SASW)
  - 35 survey lines extending down to approximately 500 feet in depth (2000-2001)
  - 18 survey lines generally extending from 400 feet to approximately 1400 feet in depth (2004-2005)

The results and comparisons of the pre-2005 surveys are documented in BSC (2002a) and summarized in Section 6.4.2.1 of this report. The five additional SASW surveys performed in 2005 are documented in MO0609SASWSEDC.001 and MO0609SASWSTDC.003. Table 6-4 shows a list of the references containing the procedures used to conduct the seismic surveys.

**Table 6-4. References of Seismic Survey Procedures.**

Method	Procedure
Downhole	<ul style="list-style-type: none"> <li>• Redpath Geophysics: SN-M&amp;O-SCI-030-V1 (Wong 2002b)</li> <li>• GEOVision: SN-M&amp;O-SCI-025-V1 (Luebbers 2002c)</li> </ul>
Suspension	<ul style="list-style-type: none"> <li>• SN-M&amp;O-SCI-024-V1 (Luebbers 2002a)</li> <li>• SN-M&amp;O-SCI-024-V2 (Luebbers 2002b)</li> </ul>
SASW	<ul style="list-style-type: none"> <li>• SN-M&amp;O-SCI-022-V1 (Wong 2002c)</li> <li>• SN-M&amp;O-SCI-040-V1 (Wong 2002a)</li> </ul>

Table 6-5 (Table 31 from BSC 2002a) describes and compares the different seismic velocity surveying methods. Table 6-6 lists the borings in which the seismic velocity surveys were performed in the surface facilities area. The locations of the borings in which downhole and

suspension seismic surveys were performed are shown in Figure 6-7. Figure 6-13 (Figure 43 of BSC 2002a) shows the locations of the pre-2005 SASW lines at the surface facilities site.



**Table 6-5. Comparison of Downhole Seismic, Suspension Seismic and SASW Methods  
(Table 31 of BSC 2002a)**

**Table 31. Comparison of Downhole Seismic, Suspension Seismic and SASW Methods**

Characteristic	Suspension Seismic	Downhole Seismic	SASW
Energy source	Built-in solenoid hammer	Hammer on plank	Hammer at close source-receiver spacings; sledgehammer, dropped weight, bulldozer or vibroseis at longer spacings
Type of wave generated	P and S	P and S	Rayleigh or other surface wave
Ability to reverse polarity	Yes	Yes	No
Primary direction of wave motion	Upward, vertical	Downward, near vertical but becoming more inclined at shallow depth	Horizontal
Wave frequency, Hz	S wave 500 - 1,000 P wave 1,000 - 3,000	S wave 20 - 40 P wave 50 - 200	5 - 500 or more
Boreholes required	One	One	None
Borehole requirements	Liquid-filled; uncased generally preferred; plastic casing is acceptable	Dry preferred; casing optional	Not applicable
Maximum effective depth, ft	1,600	300 to 700	Up to 500
Resolution	Resolution constant with depth	Resolution decreasing with depth	Resolution decreasing with depth
Borehole drift survey	Not required	Not required	Not applicable
Space limitations	Can be performed wherever a borehole can be drilled	Can be performed wherever a borehole can be drilled	Line length is about 2 times the depth surveyed, so on-site and off-site constraints may limit survey depth
Type of wave interpreted	P and S <sub>H</sub>	P and S <sub>H</sub>	R, converted to S using theory and assumed Poisson's ratio
Interval velocity	Yes	Only with geophones at multiple depths	No
Average velocity	Yes, by accumulation of individual travel times	Yes	Yes

**Table 6-6. Seismic Velocity Survey Summary**

Borehole ID	Downhole seismic				Suspension seismic (source-to-receiver and receiver-to-receiver)		SASW <sup>[6]</sup>
	Reynolds and Associates <sup>[1]</sup>	URS <sup>[2]</sup>	Redpath Geophysics <sup>[3]</sup>	GEOvision Inc. <sup>[3]</sup>	URS <sup>[2]</sup>	Luebbers M. J. <sup>[4]</sup>	University of Texas at Austin <sup>[5]</sup>
UE-25 RF#3	x						
UE-25 RF#3B	x						
UE-25 RF#9	x						
UE-25 RF#10	x						
UE-25 RF#13		x	x	x	x		SASW-1
UE-25 RF#14			x			x	
UE-25 RF#15			x			x	SASW-10+37
UE-25 RF#16 <sup>[7]</sup>			x			x	SASW-29
UE-25 RF#17				x		x	SASW-34+36 <sup>[8]</sup>
UE-25 RF#18 <sup>[7]</sup>			x			x	
UE-25 RF#19			x			x	
UE-25 RF#20 <sup>[7]</sup>			x			x	
UE-25 RF#21 <sup>[7]</sup>			x			x	SASW-2
UE-25 RF#22 <sup>[7]</sup>			x			x	SASW-23
UE-25 RF#23			x			x	SASW-32+35, SASW-33
UE-25 RF#24 <sup>[7]</sup>			x			x	SASW-4
UE-25 RF#25			x			x	
UE-25 RF#26			x			x	
UE-25 RF#28 <sup>[7]</sup>			x			x	SASW-8
UE-25 RF#29			x			x	
UE-25 RF#42							SASW-RF42 <sup>[9]</sup>
UE-25 RF#48							SASW-RF48 <sup>[9]</sup>
UE-25 RF#49							SASW-RF49 <sup>[9]</sup>
UE-25 RF#55							SASW-RF55 <sup>[9]</sup>
UE-25 RF#56							SASW-RF56 <sup>[9]</sup>

[1] 1985 surveys

[2] December 1998 survey

[3] October through December 2000 surveys

[4] September through December 2000 surveys

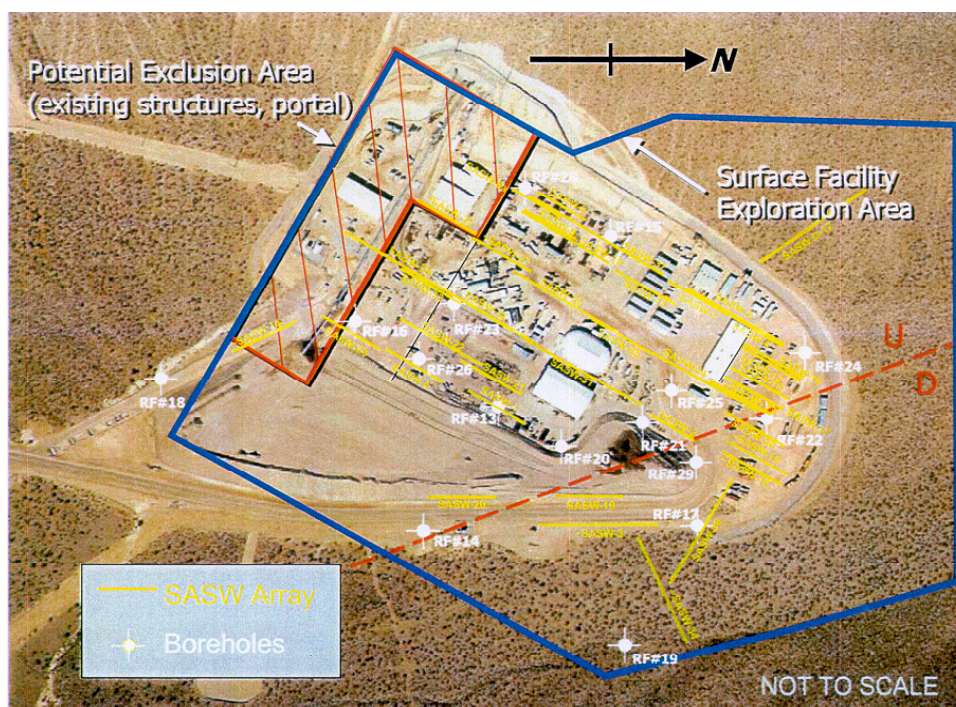
[5] July through August 2000 surveys unless otherwise noted (BSC 2002a)

[6] A total of 53 SASW surveys were performed in the proposed surface facilities area. A total of 40 shear-wave velocity profiles were developed. Eleven of these profiles were performed between existing boreholes from BSC 2002a and 5 were performed between new borings drilled in 2005. Refer to Figure 6-13 for SASW line locations measured before 2005.

[7] Caliper and gamma-gamma wireline surveys were performed in these boreholes

[8] 2 velocity profiles measured at SASW line survey

[9] 2005 surveys (MO0609SASWSEDC.001 and MO0609SASWSTDC.003)



**Figure 6-13. Locations of SASW lines at the surface facilities site [only pre-2004 lines shown]. (Figure 43 of BSC 2002a)**

#### 6.2.2.4 Borehole Wireline

Caliper and gamma-gamma wireline surveys were performed in 7 boreholes (RF#16, #18, #20, #21, #22, #24, and #28.). Caliper measurements were performed in order to assess the extent of erosion of the borehole walls by the drilling fluid and its potential effects on the suspension seismic results. The main purpose of performing the gamma-gamma measurements was to evaluate the density of the subsurface materials.

The process established in PA-PRO-0312 (this information is considered historical, therefore, only shown as reference), Yucca Mountain Site Characterization Project Field Verification of Geophysical Operation, and AP-SIII.6Q, Geophysical Logging Programs for Surface-Based Testing Program Boreholes, were followed for both the caliper and gamma-gamma wireline surveys.

### 6.3 LABORATORY TESTING

This section discusses laboratory testing conducted on samples taken during 2000 to 2001 from the borings and test pits performed at the surface facilities area.

### **6.3.1 Static Testing**

Documentation of all static laboratory testing is found in Sections 6.2.9 and 6.5.2 of BSC (2002a) for the alluvial and borrow pit materials, respectively. A summary of the static laboratory test results is presented in Section 6.4 of this report.

#### **6.3.1.1 Alluvium**

Static tests were performed on 22 samples of alluvial material obtained from test pits TP-WHB-1 through -4, and on 9 samples from TP-WHB-5 through -7. All tests were conducted at a geotechnical laboratory located in Denver, Colorado. The tests conducted are listed in Table 6-7 along with the testing standards used.

**Table 6-7. Laboratory Tests and Standards Conducted on Alluvium.**

Test	Standard
Atterberg Limits	<ul style="list-style-type: none"> <li>• USBR 5350-89, <i>Procedure for Determining the Liquid Limit of Soils by the One-Point Method</i></li> <li>• USBR 5360-89, <i>Procedure for Determining the Plastic Limit and Plasticity Index of Soils.</i></li> </ul>
Maximum and Minimum Index Unit Weights	<p>For particles passing the 3-inch sieve:</p> <ul style="list-style-type: none"> <li>• USBR 5525-89, <i>Procedure for Determining the Minimum Index Unit Weight of Cohesionless Soil</i></li> <li>• USBR 5530-89, <i>Procedure for Determining the Maximum Index Unit Weight of Cohesionless Soils.</i></li> </ul>
Particle-Size Distribution	<ul style="list-style-type: none"> <li>• USBR 5325-89, <i>Procedure for Performing Gradation Analysis of Gravel Size Fraction of Soils</i></li> <li>• USBR 5330-89, <i>Procedure for Performing Gradation Analysis of Fines and Sand Size Fraction of Soils, Including Hydrometer Analysis</i></li> <li>• USBR 5335-89, <i>Procedure for Performing Gradation Analysis of Soils Without Hydrometer–Wet Sieve.</i></li> </ul>
Specific Gravity	<p>For particles passing the 4.75 mm (No. 4) sieve:</p> <ul style="list-style-type: none"> <li>• USBR 5320-89, <i>Procedure for Determining Specific Gravity of Soils (volume method)</i></li> </ul> <p>For particles retained on the 4.75 mm (No. 4) sieve:</p> <ul style="list-style-type: none"> <li>• USBR 5320-89, <i>Procedure for Determining Specific Gravity of Soils (suspension method).</i></li> </ul>
Unified Soil Classification System	<ul style="list-style-type: none"> <li>• USBR 5000-86, <i>Procedure for Determining Unified Soil Classification (Laboratory Method).</i></li> </ul>
Water Content	<ul style="list-style-type: none"> <li>• USBR 5300-89, <i>Procedure for Determining Moisture Content of Soil and Rock by the Oven Method.</i></li> </ul>

### 6.3.1.2 Engineered Fill

Disturbed samples of the borrow material were taken from 4 locations (WHB-B1 to WHB-B4) in the Fran Bridge Borrow Area and then combined into one bulk sample. Testing was conducted at laboratory facilities in Denver, Colorado and Santa Ana, California (URS Greiner Woodward Clyde). The tests conducted are listed in Table 6-8 below along with the testing standards used (where provided).

**Table 6-8. Laboratory Tests and Standards Conducted on Engineered Fill Material.**

Test	Standard
Atterberg Limits	<ul style="list-style-type: none"> <li>• USBR 5350-89, <i>Procedure for Determining the Liquid Limit of Soils by the One-Point Method.</i></li> </ul>
Compaction Test	<ul style="list-style-type: none"> <li>• ASTM D 1557, <i>Standard Test Method for Laboratory Compaction Characteristics of Soil Using Modified Effort (56,000 ft-lbf/ft<sup>3</sup> (2,700 kN-m/m<sup>3</sup>)).</i></li> </ul>
Maximum and Minimum Index Unit Weights	<p>For particles passing the 3-inch sieve:</p> <ul style="list-style-type: none"> <li>• USBR 5525-89, <i>Procedure for Determining the Minimum Index Unit Weight of Cohesionless Soils</i></li> <li>• USBR 5530-89, <i>Procedure for Determining the Maximum Index Unit Weight of Cohesionless Soils.</i></li> </ul>
Particle-Size Distribution	<ul style="list-style-type: none"> <li>• USBR 5325-89, <i>Procedure for Performing Gradation Analysis of Gravel Size Fraction of Soils</i></li> <li>• USBR 5335-89, <i>Procedure for Performing Gradation Analysis of Soils Without Hydrometer–Wet Sieve.</i></li> <li>• ASTM C 136, <i>Standard Test Method for Sieve Analysis of Fine and Coarse Aggregates</i>, for 3 conditions: (1) as received; (2) after scalping on the ½-inch sieve and prior to compaction; and (3) after the compaction test on the ½-inch minus material.</li> </ul>
Specific Gravity	<p>For particles passing the 4.75 mm (No. 4) sieve:</p> <ul style="list-style-type: none"> <li>• USBR 5320-89, <i>Procedure for Determining Specific Gravity of Soils (volume method).</i></li> </ul> <p>Denver, Colorado laboratory for particles retained on the 4.75 mm (No. 4) sieve:</p> <ul style="list-style-type: none"> <li>• USBR 5320-89, <i>Procedure for Determining Specific Gravity of Soils (suspension method).</i></li> </ul>
Triaxial Test	<ul style="list-style-type: none"> <li>• Four triaxial tests performed on reconstituted specimens under isotropically consolidated, drained conditions.</li> </ul>
Unified Soil Classification System	<ul style="list-style-type: none"> <li>• USBR 5000-86, <i>Procedure for Determining Unified Soil Classification (Laboratory Method).</i></li> </ul>

### 6.3.2 Dynamic Testing

Dynamic properties of the alluvium, bedrock (tuff), and engineered fill were evaluated using combined resonant column and torsional shear (RCTS) tests. The laboratory dynamic testing was performed in the Geotechnical Engineering Center at the University of Texas at Austin. Testing procedures are presented in Section 6.2.10.1 of BSC (2002a) and SN-M&O SCI-033-V1 (Wong 2002d).

Dynamic properties, including the shear modulus and material damping relative to shearing strain, were determined from the laboratory tests on samples of alluvium, bedrock, and engineered fill. A summary of the results of the dynamic testing is presented in Section 6.4.2 of this report. Table 6-9 lists the testing standard and reference used for the dynamic tests.

**Table 6-9. Standard and Reference Used for Dynamic Testing.**

Test	Standard and Reference
Resonant column and torsional shear (RCTS)	<ul style="list-style-type: none"> <li>• PA-PRO-0310, <i>Laboratory Dynamic Rock/Soil Testing</i> (this information is considered historical, therefore, only shown as reference).</li> <li>• SN-M&amp;O-SCI-033-V1 (Wong 2002d)</li> </ul>

#### 6.3.2.1 Alluvium

One combined alluvial sample was collected from boreholes RF#14 to #17. The specimen was reconstituted in the laboratory due to sampling disturbance, using the standard under-compaction method of Ladd (1978).

Additionally, dynamic testing was also performed on a soil sample taken from borehole RF#13 in 1999. A summary of the test results from this sample is provided in CRWMS M&O (1999, Appendix Q).

#### 6.3.2.2 Engineered Fill

Ten reconstituted specimens taken from the Fran Ridge borrow area were tested. Four of the samples were tested in 2 stages to investigate the dynamic property effects of increasing the water content of the granular fill after placement.

### 6.3.2.3 Bedrock (Tuff)

Eighteen undisturbed specimens taken from boreholes RF#14 to #17 were tested. During testing, the specimens were divided into three groups based on their dry unit weight,  $\gamma_d$ :

- Group 1:  $\gamma_d$  from 133 pcf to 147 pcf
- Group 2:  $\gamma_d$  from 117 pcf to 132 pcf
- Group 3:  $\gamma_d$  from 78 pcf to 94 pcf

## 6.4 MATERIAL PROPERTIES

This section presents a summary and discussion of the results of both static and dynamic laboratory tests on the soil units at the site. All information presented in the following sections is based on data presented in BSC (2002a) and BSC (2002b). A summary of recommended material properties for design is presented in Table 2-1.

### 6.4.1 Static Soil Properties

#### 6.4.1.1 Alluvium

Results of the in-situ density tests and laboratory tests conducted on the alluvial material from TP-WHB-1 to TP-WHB-4 are shown in Tables 6 and 13 of BSC (2002a), respectively. Results of the in-situ density tests and laboratory tests conducted on the alluvial material from TP-WHB-5 to TP-WHB-7 are provided in DTN:GS070683114233.004.

The following sections describe the results of testing on 31 samples obtained at depths ranging from 4 to 20 feet. There were no alluvium samples obtained for depths greater than 20 feet.

##### 6.4.1.1.1 General Characteristics

The alluvium material is generally medium dense to dense, and varies between a well-graded gravel (GW), well-graded gravel with silt (GW-GM), poorly graded sand with silt (SP-SM), and well-graded sand with silt (SW-SM). Intermittent layers of calcite-cemented material (caliche) are present in the alluvium (BSC 2002b, Section 6.2 and DTNs:GS070583114233.002 and GS070583114233.003). However, these areas were conservatively not considered in this report. Table 6-10 provides a summary of average soil properties determined from the laboratory testing.



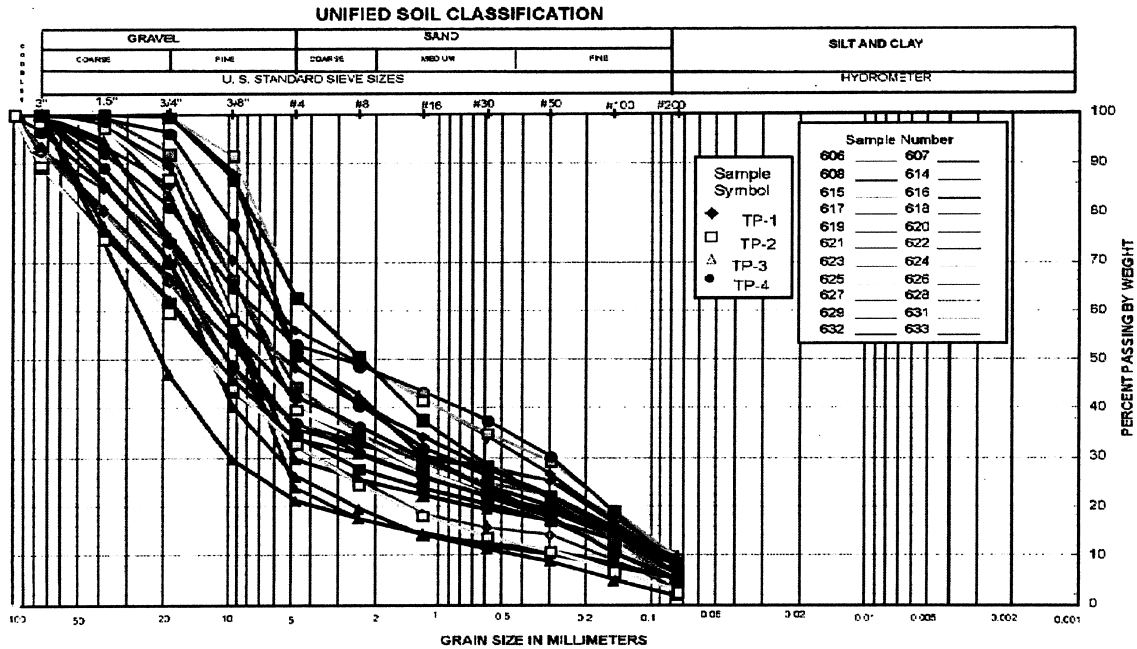
**Table 6-10. Results from Tests Performed on Alluvial Samples at Surface Facilities Area (DTNs: GS020483114233.004, GS070483114233.001).**

Test	Results
Particle size distribution	57 ± 13% (gravel & cobbles)
	37 ± 12% (sand)
	6 ± 2.5% (fines)
Plasticity	Non-plastic
Average Density	116 pcf maximum index (passing 3-inch sieve)
	92 pcf minimum index (passing 3-inch sieve)
	108 pcf dry in-place
	71 ± 20% relative
Average minimum index density	91 pcf (passing 3-inch sieve)
Average specific gravity and absorption (passing 3-inch sieve)	2.37 apparent
	2.25 bulk (saturated surface dry)
	2.16 bulk (oven dry)
	4.0% absorption
Average specific gravity and absorption (retained on No. 4 and passing 3-inch sieve)	2.46 apparent
	2.26 bulk (saturated surface dry)
	2.12 bulk (oven dry)
	8.5% absorption
Average specific gravity (passing No. 4)	2.52
Average water content	7.1 % (passing No. 4 sieve)
	4.9 % (retained on No. 4 sieve)

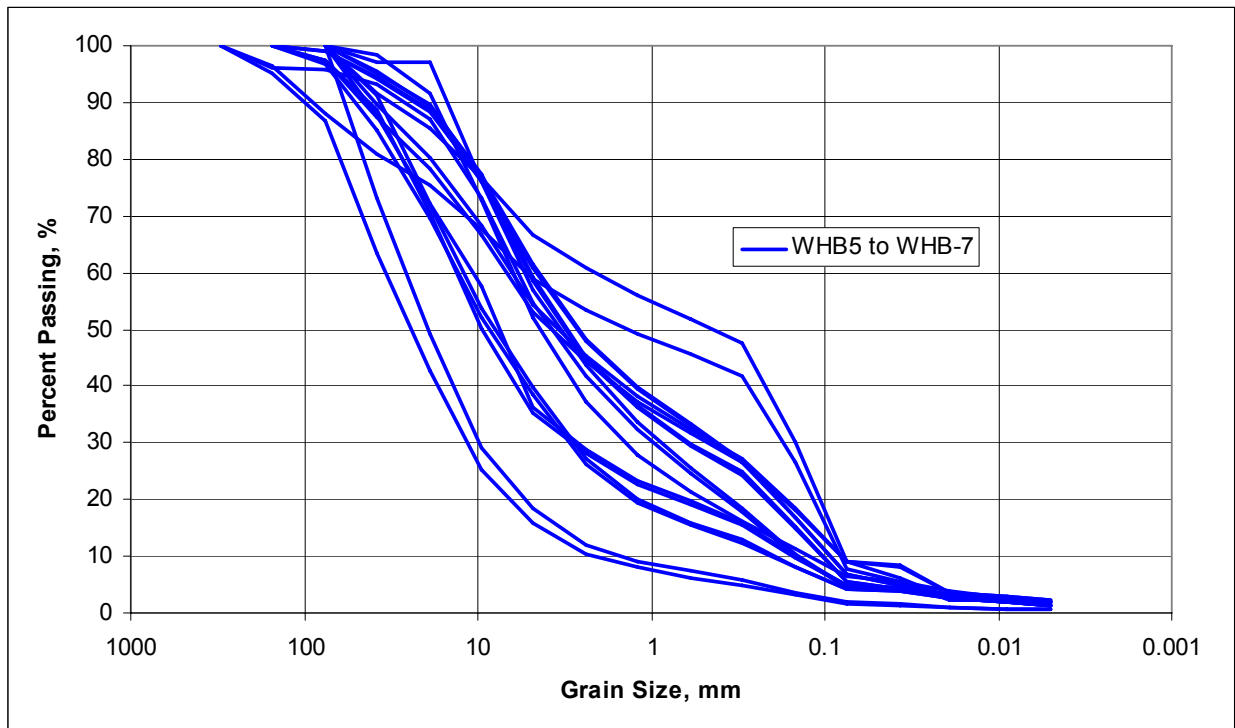
A comparison of the data from Table 6-10 with soil data from earlier geotechnical investigations (1980's and early 1990's) shows good corroboration of the soils properties. The specific gravity of the alluvium at the site is less than typically encountered for sand and gravel soils, likely due to the volcanic origin of the Yucca Mountain soils. See, for instance, USN 1986 (pp. 7.1-23), which uses a specific gravity of 2.65 for granular soils in their tables of typical values.

#### 6.4.1.1.2 Gradation

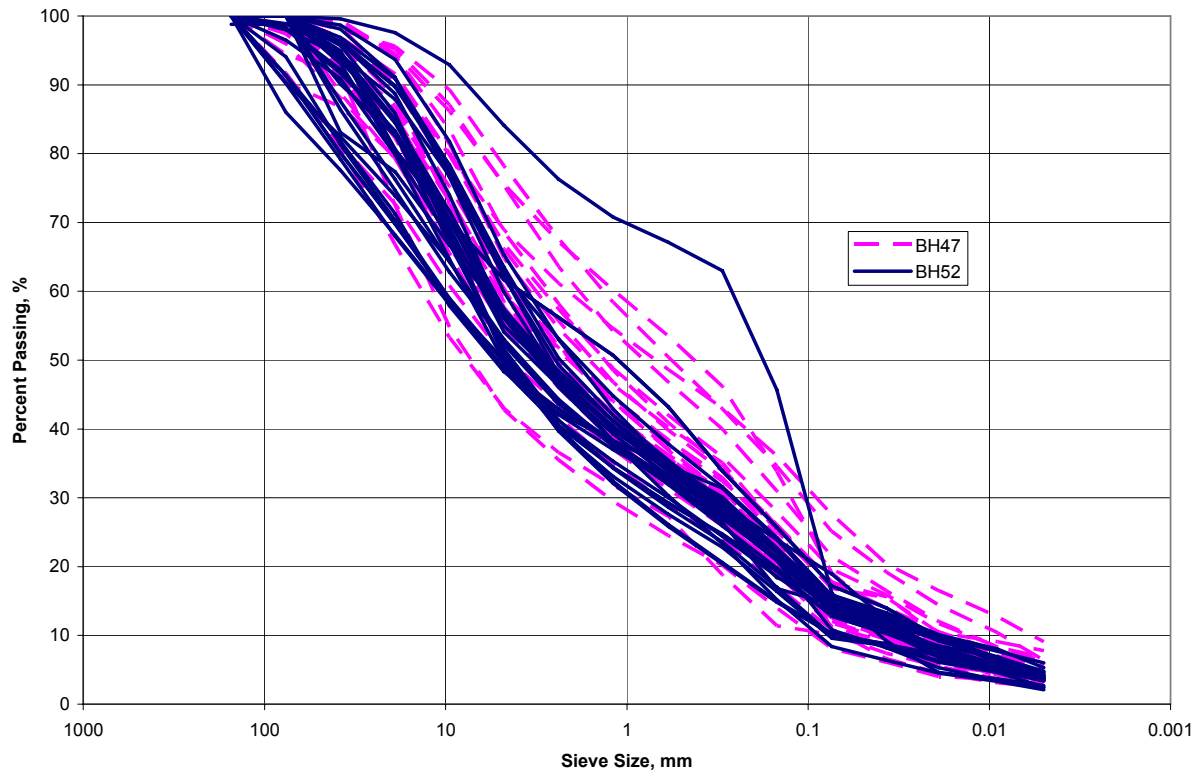
Plots of gradation test results from test pits WHB-1 through WHB-4 (DTN: GS020783114233.005) are provided in Figure 6-14, while those for WHB-5 through WHB-7 (DTN: GS070683114233.004) are provide in Figure 6-15. Gradations for sonic Borings RF-47 and RF-52 are provided in Figure 6-16. Note that sonic coring breaks up some of the larger gravels resulting in a shift to finer particles as compared to Figure 6-14 and Figure 6-15.



**Figure 6-14. Particle-Size Distribution Curves for Alluvium for TP-WHB-1 to TP-WHB-4 (DTN: GS020483114233.004 and GS020783114233.005)**



**Figure 6-15. Particle-Size Distribution Curves for Alluvium for TP-WHB-5 to TP-WHB-7 (DTN: GS070683114233.004)**



**Figure 6-16. Particle-Size Distribution Curves for Sonic Borings RF-47 and RF-52 (DTN: GS070483114233.001)**

#### 6.4.1.1.3 Density

From the 31 samples taken within the alluvium from the 2002 and 2006 field tests, in-place dry density, and minimum and maximum index density tests were performed (see Table 6-10). An average relative density of 71% was determined from these tests.

Density testing included 15 ring density and 16 sand cone tests taken up to 20 feet in depth into the alluvium, and gamma-gamma surveys extending up to a 480 depth through the alluvium and into bedrock. Based on the field tests, Sections 8.2.1 and I.2.1 of BSC (2002b) recommends the average moist unit weight of the alluvium to be approximately 114 pcf in the upper 8 feet and 117 pcf below 8 feet. Moisture contents vary between about 5 and 7 percent. The data from the gamma-gamma surveys are the only known density measurements at lower depths of the alluvium and are generally lower in value by approximately 25 to 30%. However, Section 8.2.1 of BSC (2002b) indicates that these results may correspond to the bedrock material rather than the alluvium.

Densities from earlier soil investigations were measured by water replacement tests (McKeown 1992), laboratory tests on drive tube samples (Neal 1986), and sand cone and nuclear tests (Ho, et al. 1986). A comparison of the data obtained from these measurements to recent field tests

show good agreement. Hence, a conservative moist unit weight of 114 to 117 pcf for the alluvium is recommended.

#### 6.4.1.1.4 Shear Strength

Because undisturbed alluvial samples were not obtained in prior geotechnical investigations, correlations from several sources between the relative density and friction angle are used to estimate the strength of the alluvium. Table I-17 of BSC (2002b) presents a summary of the friction angles obtained from the various correlations used. The mean, and mean plus/minus one standard deviation values of relative density are used for the calculation. Based on the correlations between relative density and friction angle, an effective friction angle of 39 degrees, corresponding to halfway between the mean minus one standard deviation and the mean values of the relative density, is recommended for the alluvium for a pressure of 1 atmosphere.

Sections 8.2.2, I.2.2.1, I.2.2.2, I.2.2.3, I.2.2.4, and I.2.2.5 of BSC (2002b) recommend different strength envelopes to be used for different types of analyses (i.e., passive pressures, bearing capacity, and slope stability). A linear failure envelope with no cohesion ( $c = 0$ ) and producing an equivalent effective friction angle,  $\phi_{\text{eff}}$ , of 39 degrees is considered to adequately characterize the alluvial material and is recommended for preliminary design.

SPT data (discussed in Section 6.2.2.2) from borehole RF#13 and TP-NNWSI2 corroborate the conservative shear strength friction angle selected for the alluvium, revealing blow counts on the order of 100 to 300 blows/foot. This also holds true for correlations between shear wave velocity and shear strength, as the measured shear wave velocities at the site correlate to unrealistically high shear strength values.

#### 6.4.1.1.5 Earth Pressure Coefficients

Earth pressure coefficients are calculated for at-rest, active and passive conditions to be used for analyses of lateral earth pressures (Section 7.1.5). Appendix C documents the derivation of these coefficients. The results are shown in Table 2-1.

#### 6.4.1.1.6 Young's Modulus

Static Young's Modulus,  $E$ , for the alluvium can be calculated using the results of the elastic settlement analyses contained in Appendix C. For expected vertical loads of 3 and 5 ksf, the elastic settlements computed are 0.4 and 1.6 inches, respectively. Using a maximum alluvium thickness of 120 ft, the average strains induced in the alluvium from the 3 and 5 ksf vertical loading are determined to be 0.03% and 0.11%, respectively. Static Young's modulus can then be determined using:

$$E = \frac{\sigma}{\epsilon}, \quad (\text{Eq. 1})$$

where  $E$  is the Young's modulus,  $\epsilon$  is the axial strain, and  $\sigma$  is the vertical stress.  $E$  is determined to be 30 to 75 ksi.

Sections 8.2.3 and I.2.3 of BSC (2002b) recommend the following equation to be used for a strain range of 0.1 to 0.5% and for a stress range for 0 to 6 ksf:

$$E = 777.37(\varepsilon)^{-0.6505} \sigma^{0.5}, \text{ where} \quad (\text{Eq. 12 and I-66 of BSC 2002b}) \quad (\text{Eq. 2})$$

$\varepsilon$  is the axial strain in percent and  $\sigma$  is the vertical overburden stress. Using an average overburden stress in the alluvium of 11 ksf ( $\sigma = 0.117 \text{ kcf} \times 60$  from the alluvium weight plus 4 ksf from vertical loading) and an axial strain of 0.1% yields E to be 80 ksi. For design, use a static Young's Modulus of 30 to 75 ksi for static loading conditions (Table 2-1).

#### **6.4.1.1.7 Resistivity**

Electrical resistivity of the soil will be required for design of grounding and evaluation of corrosion potential. Field measurements will be required for the alluvium and any engineered fill that is placed. It is expected that the main source of engineered fill will be alluvium and, therefore, the resistivity of these two materials will be similar. Measurements made at eight locations on the alluvial surface prior to building the construction-support pad at the North Portal (U.S. Bureau of Reclamation, 1992, and Bureau of Reclamation, 1993) provide a typical range of values for these materials. The results indicated resistivities measuring between 60 and 540 ohm-meters.

#### **6.4.1.2 Engineered Fill**

It is anticipated that engineered fill will be obtained from alluvial soils, possibly processed to some extent. The Fran Ridge Borrow Area is an example of such material. The information presented in this section are provided for corroborative purposes only. Actual design values will be obtained after a source pit is identified.

Results of the static tests conducted in a laboratory located in Denver, CO, on the fill obtained from the Fran Ridge Borrow Area are presented in Table 6-11 (Table 27 and Figure 214 of BSC 2002a). Results of static strength tests conducted in Santa Ana, CA are presented in Table 28 and Figures 215 through 217 of BSC (2002a). The following sections summarize the results of the laboratory testing on disturbed samples obtained at widely spaced locations of the Fran Ridge Borrow Area.

##### **6.4.1.2.1 General Characteristics**

The borrow material is classified as a poorly graded sand to gravel (SP/GP), and, after compaction, a poorly graded sand with silt and gravel (SP-SM). Table 6-11 below presents soil properties determined for engineered fill from laboratory testing.

**Table 6-11. Results from Tests Performed in Denver, CO, on a Composite Sample of Fran Ridge Borrow Materials (Table 27 of BSC 2002a, DTN: MO0206EBSFRBLT.018).**

Test	Results
Particle size distribution	48% (gravel)
	49% (sand)
	3% (fines)
Plasticity	Non-plastic
Average maximum index density	112.4 pcf (passing 3-inch sieve)
Average minimum index density	94 pcf (passing 3-inch sieve)
Average specific gravity and absorption (passing 3-inch sieve)	2.39 apparent
	2.24 bulk (saturated surface dry)
	2.13 bulk (oven dry)
	5.3% absorption
Average specific gravity and absorption (retained on No. 4 and passing 3-inch sieve)	2.45 apparent
	2.24 bulk (saturated surface dry)
	2.10 bulk (oven dry)
	6.9% absorption
Average specific gravity (passing No. 4)	2.52

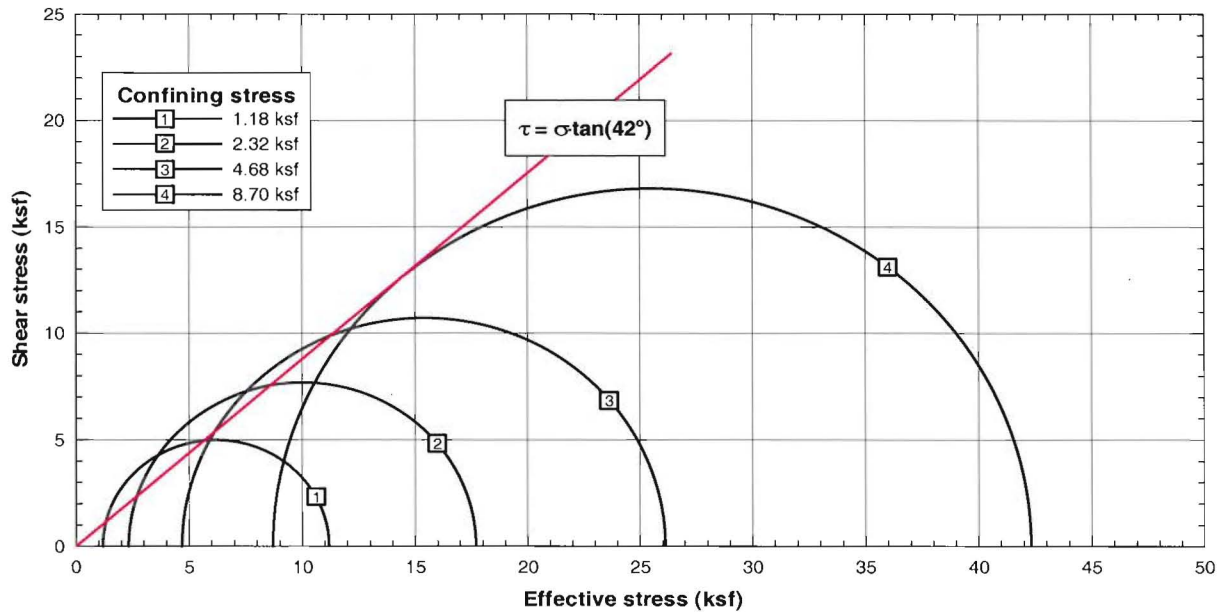
#### 6.4.1.2.2 Total Unit Weight

The results of the compaction test on a composite sample of the Fran Ridge Borrow material indicate a maximum dry unit weight of 114.5 pcf for an optimum water content of 11 percent. Based on the results from the compaction test and on the standard practice presented in ASTM D 4718 for the correction of unit weight and water content for soils containing oversized particles, the moist unit weight for the engineered fill is computed to be 127 pcf [ $114.5 \text{ pcf} \times (1+0.11)$ ].

#### 6.4.1.2.3 Shear Strength

A set of four drained triaxial compression tests performed on the composite sample of the Fran Ridge material are used to obtain the shear strength of the engineered fill material. The material was compacted to an average dry density of 110 pcf and water content of 12.5%. The results of these tests are shown in Table 28 and Figures 216 and 217 of BSC (2002a). Figure 6-17 below (Figure 217 of BSC 2002a) shows the results of the triaxial tests.

Sections 8.1.2, I.1.2.3, I.1.2.4, I.1.2.5, and I.1.2.6 of BSC (2002b) recommend various strength envelopes to be used for different types of analyses (general purpose, passive pressures, bearing capacity, slope stability). However, a linear failure envelope with no cohesion ( $c=0$ ) and producing an equivalent effective friction angle,  $\phi_{\text{eff}}$ , of 42 degrees is considered to adequately characterize the alluvial material.



**Figure 6-17. Strength envelopes fitted to triaxial tests on engineered fill.  
(DTN: MO0203EBSCTCTS.016)**

#### 6.4.1.2.4 Earth Pressures Coefficients

Earth pressure coefficients are calculated in Appendix C. Table 2-1 presents the results.

#### 6.4.1.2.5 Young's Modulus

Typical Young's Modulus values for a dense sand and gravel material are recommended to be 14–28 ksi (Bowles 1996).

A secant Young's modulus was calculated in Sections 8.1.3 and I.1.3 of BSC (2002b) from the drained triaxial test results. Equations 6 and I-19 of BSC (2002b) are recommended for use in computing the Young's modulus:

$$E = 911.19(\sigma')^{0.4541}, \text{ where } \quad (\text{Eq. 6 and I-19 of BSC 2002b}) \quad (4)$$

$\sigma'$  is the initial isotropic consolidation stress prior to loading. The above equation corresponds to a strain of 0.25%. For an overburden stress of 5.5 ksf, Young's Modulus is estimated to be approximately 14 ksi.

For design, use a static Young's Modulus of 14 to 28 ksi (Table 2-1).

### **6.4.1.3 Bedrock**

#### **6.4.1.3.1 Moist Unit Weight**

Density measurements were obtained from the gamma-gamma wireline surveys and dynamic laboratory testing for the bedrock material. The results are discussed in Section 6.4.2.3.

#### **6.4.1.3.2 Shear Strength**

Since, the structures will be underlain by a significant amount of alluvium over bedrock, estimation of shear strength of the bedrock is not required for purposes of these analyses and is conservatively ignored. This information can be derived from other project sources if needed.

### **6.4.2 Dynamic Soil Properties**

Dynamic soil properties, including seismic wave velocity, Poisson's ratio, and strain dependent parameters of shear modulus degradation and material damping ratio were developed for use in the future dynamic analyses of the structures and foundations at the surface facilities site. The following sections are a summary of the data compiled and reported in BSC (2002a).

#### **6.4.2.1 Shear and Compression Wave Velocity**

Statistical values of shear ( $V_s$ ) and compression ( $V_p$ ) wave velocities for each soil layer present at the site (existing fill, alluvium and bedrock) are provided in tabular form in Sections 6.2.5.3, 6.2.6.4, and 6.2.7.3 in BSC (2002a), for the downhole, suspension, and SASW seismic surveys. For this report, the available data was compiled and divided by soil unit (where known), using geologic information provided in the boring logs of the surface facilities area. Representative velocity values of the soil materials are summarized in Table 2-1. Section 6.2.2.3 discusses the data used in the analysis. A detailed discussion of this analysis is provided in Appendix A of this report. This analysis determined a linear fit of shear wave velocity versus depth in the fill and average shear wave velocity for rock types grouped into two main divisions:

1. Those occurring lithostratigraphically between Tmbt1 through Tpcpul,
2. and those occurring lithostratigraphically between Tpcpmn through Tpcpln.

Shear and compression wave velocities determined from dynamic laboratory tests on the alluvium and bedrock materials discussed in Sections 6.2.10.2, and 6.2.10.3 of BSC (2002a) were not considered to be as accurate as measurements in the field of the seismic wave velocities and thus were not used in the analysis herein. Results of dynamic laboratory tests (RCTS) performed on the engineered fill were considered since no geophysical surveys could be performed on this material. A discussion of the seismic wave velocity values for the roller compacted cement is provided in Section 6.4.3.

Sections 6.2.5, 6.2.6, and 6.2.7, BSC (2002a) provide numerous figures comparing the results of the seismic wave velocity surveys in the surface facilities area. These figures should be referred to for details on individual surveys and specific comparisons between survey methods. Figure 6-18 through Figure 6-23 are taken from Figures 22, 30, 31, 91, 34, and 23 of BSC (2002a),



respectively, and show statistical analyses of the shear- and compression-wave velocities measured in the surface facilities area by the three surveying methods. A discussion and comparison of the surveying methods and results of individual velocity profiles are provided in Sections 6.2.5 to 6.2.7, Section 6.7, and Attachments V through IX of BSC (2002a).

Additional analyses of the available shear wave velocity and compression wave velocity data were performed in BSC (2004a) after the initial issue of the current calculation. The 2004 analysis subdivided the analyses based on data measurements taken west (on the upthrown side) and east (on the downthrown side) of the Exile Hill Fault Splay (see Figure 6-24). Additional culling of data was also made based on evaluation of the quality of each data source. This created modified distributions of the available field measurement data for the various subsurface materials. As demonstrated in Figure 6-24, the majority of the available measurements were performed on the upthrown side (west) of the Exile Hill Fault Splay.

Due to its more detailed data analysis, the results from BSC (2004a) are recommended for design. However, the results of the previous analyses are presented for informational purposes.

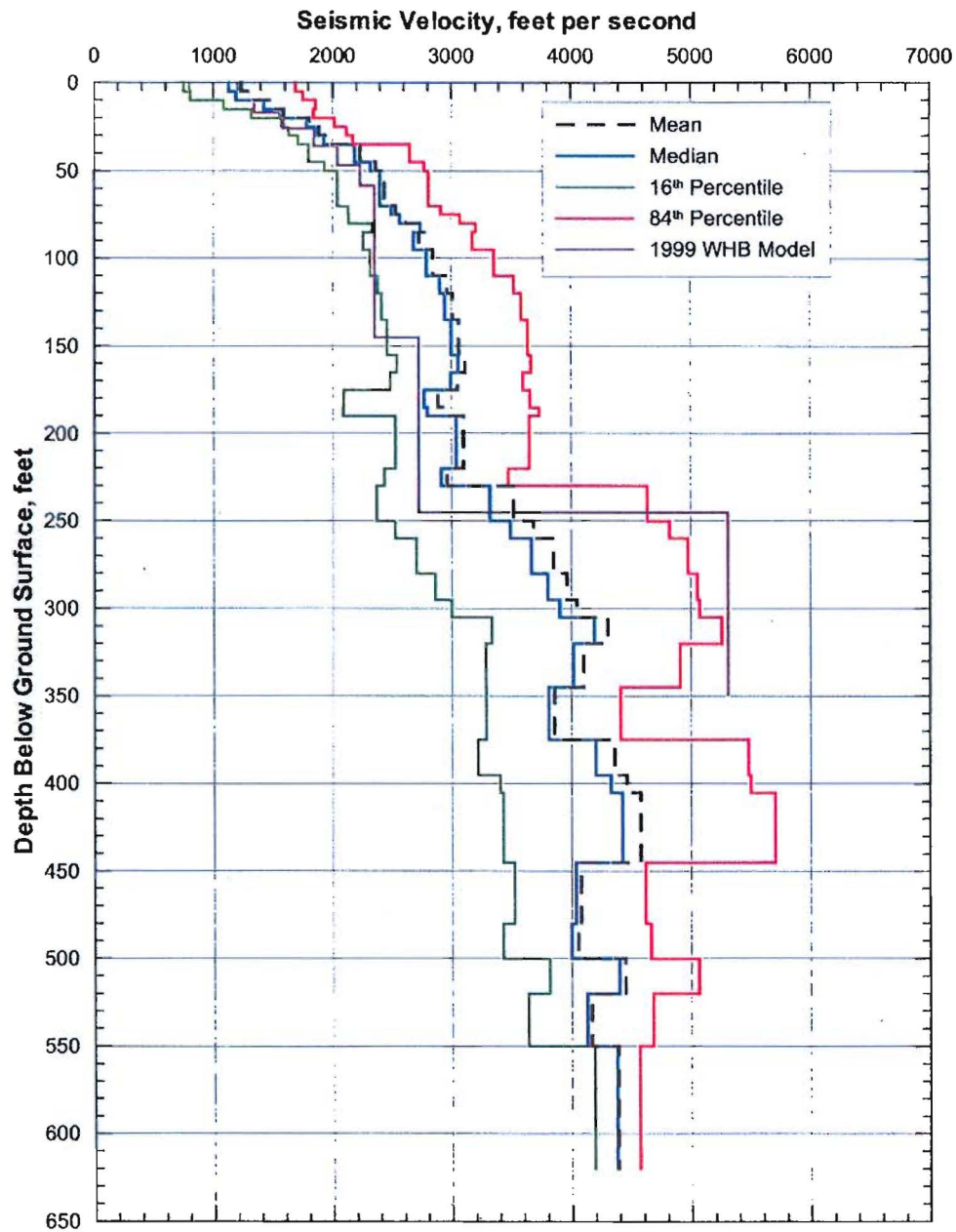
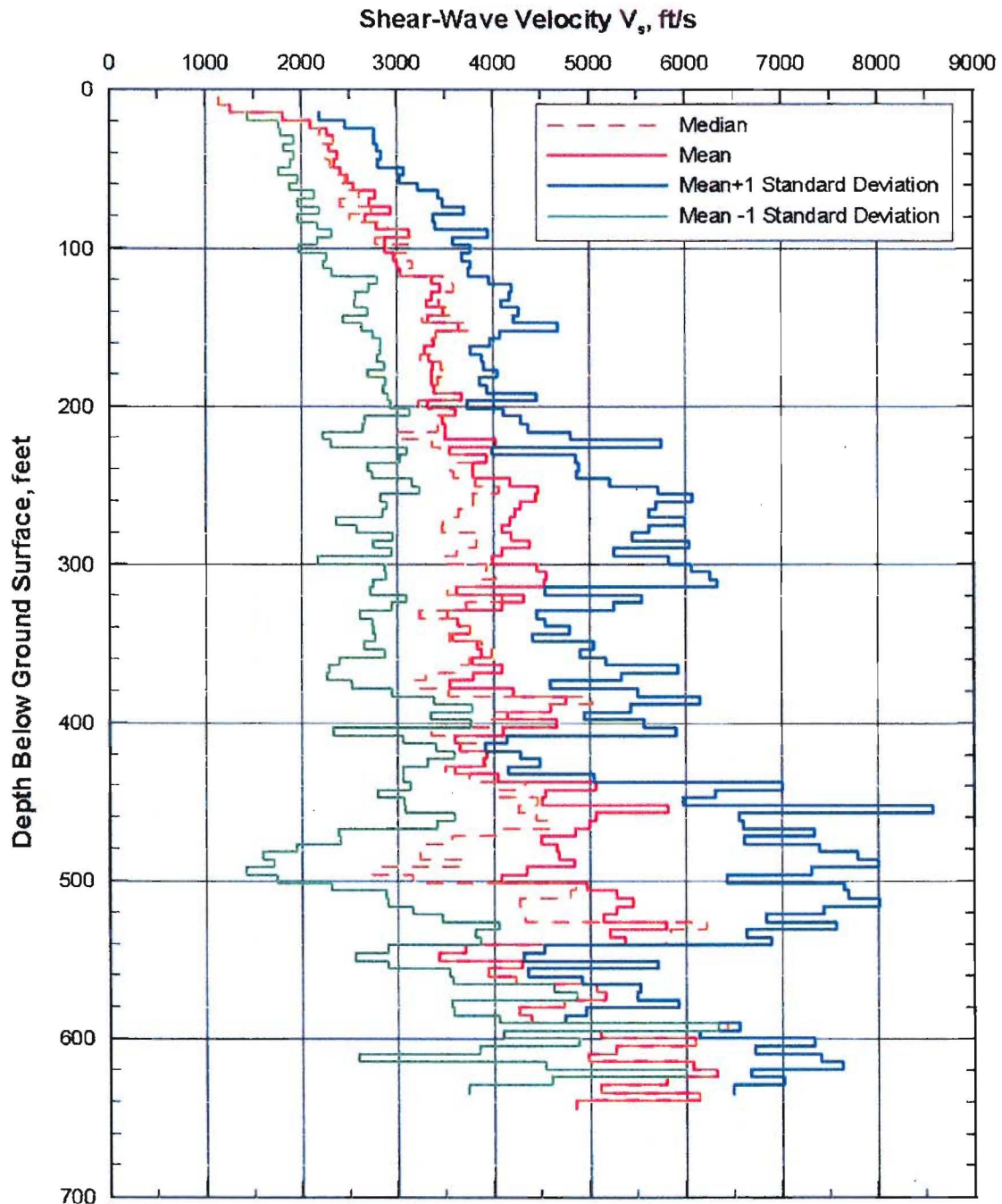
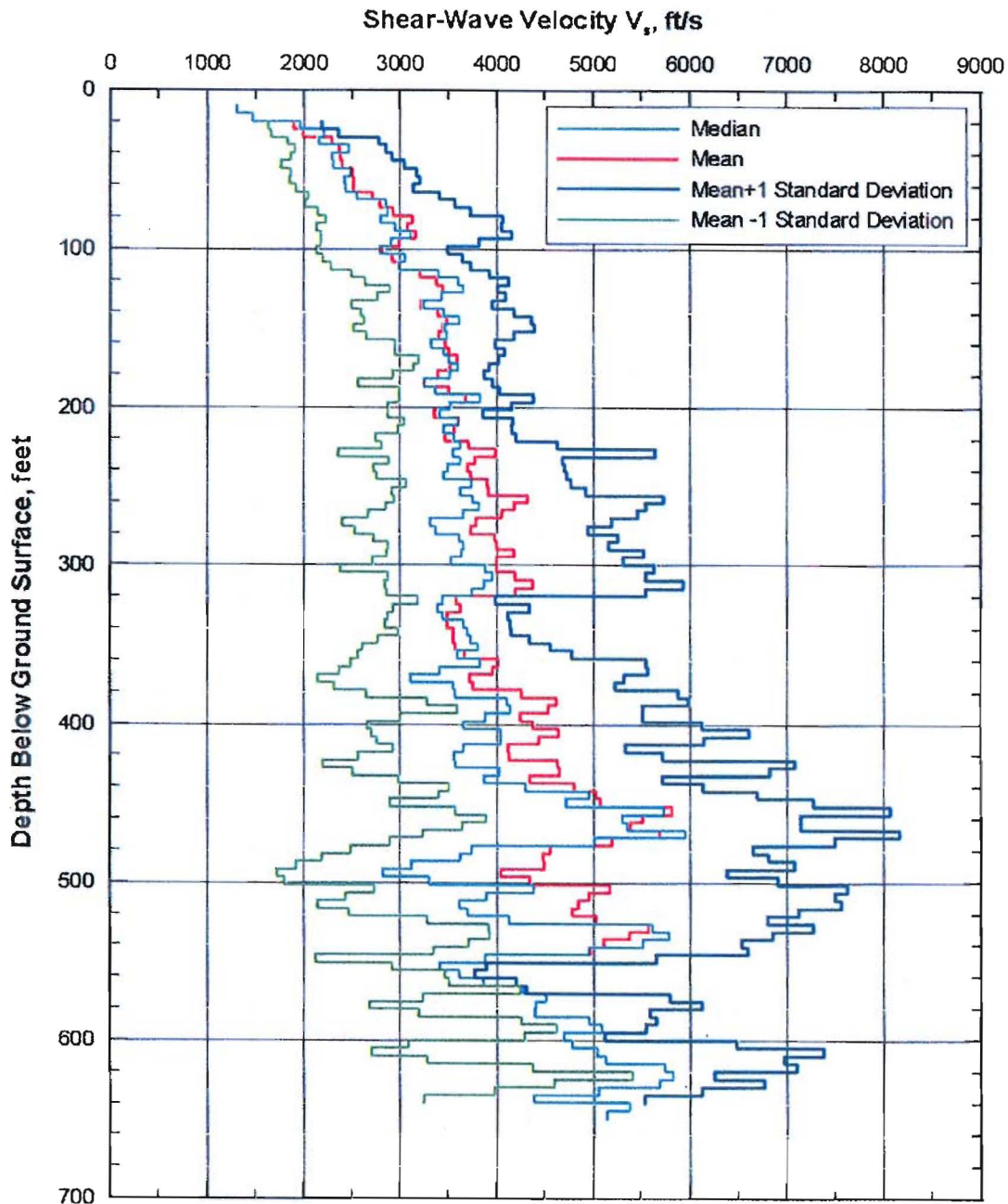


Figure 6-18. Statistical analyses of shear-wave velocities from downhole measurements in the surface facilities area. (Figure 22 of BSC 2002a)



**Figure 6-19. Shear wave velocity by depth interval from receiver to receiver interval suspension surveys in surface facilities area. (Figure 30 of BSC 2002a, DTN: MO02045FTDSUSP.001)**



**Figure 6-20.** Shear wave velocity by depth interval from source to receiver interval suspension surveys in surface facilities area. (Figure 31 of BSC 2002a, DTN: MO02045FTDSUSP.001)

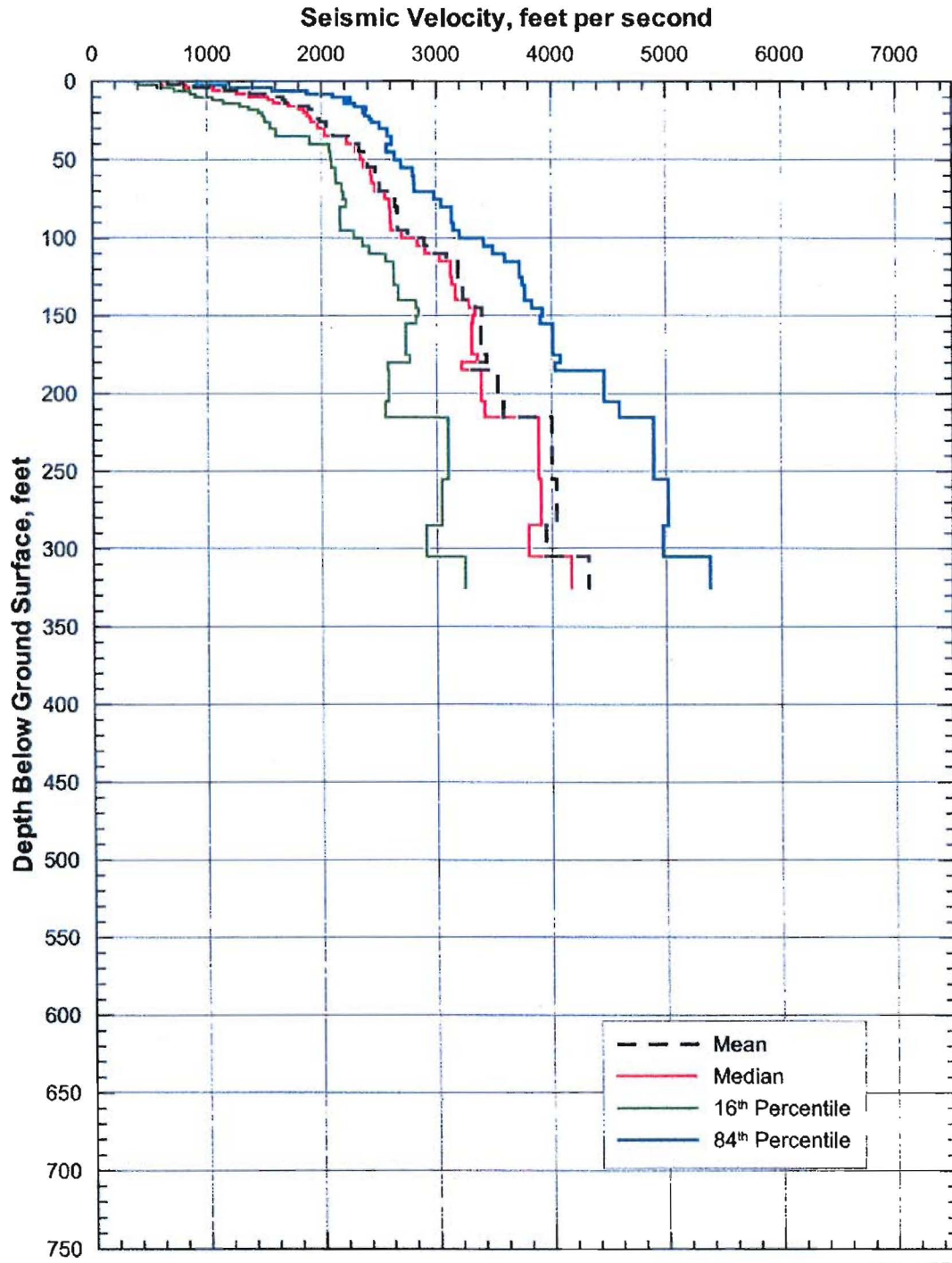


Figure 6-21. Shear wave velocity from SASW measurements in the surface facilities area. (Figure 91 of BSC 2002a)



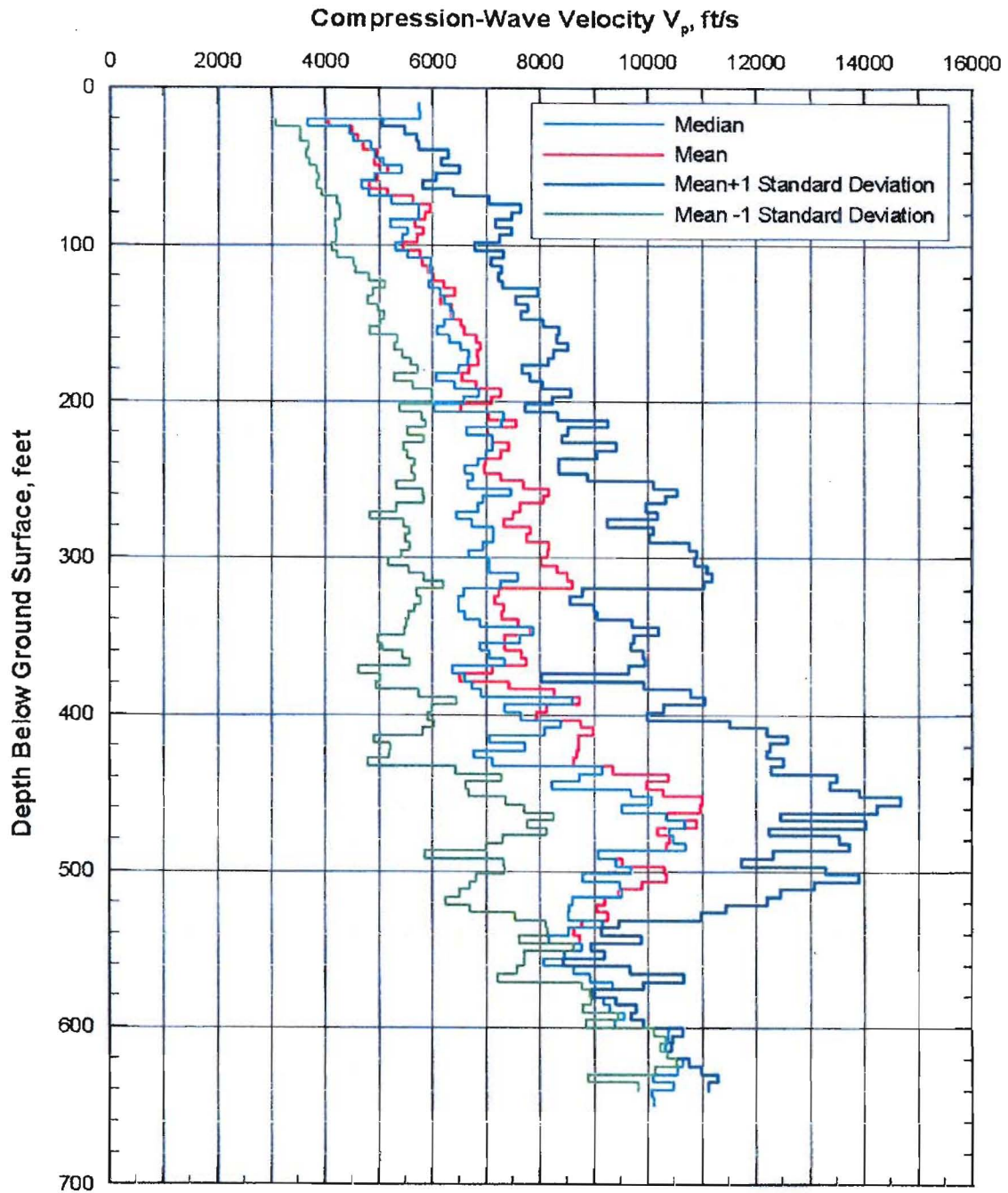


Figure 6-22. Compression wave velocity by depth interval from source to receiver interval suspension surveys in surface facilities area. (Figure 34 of BSC 2002a, DTN: MO02045FTDSUSP.001)

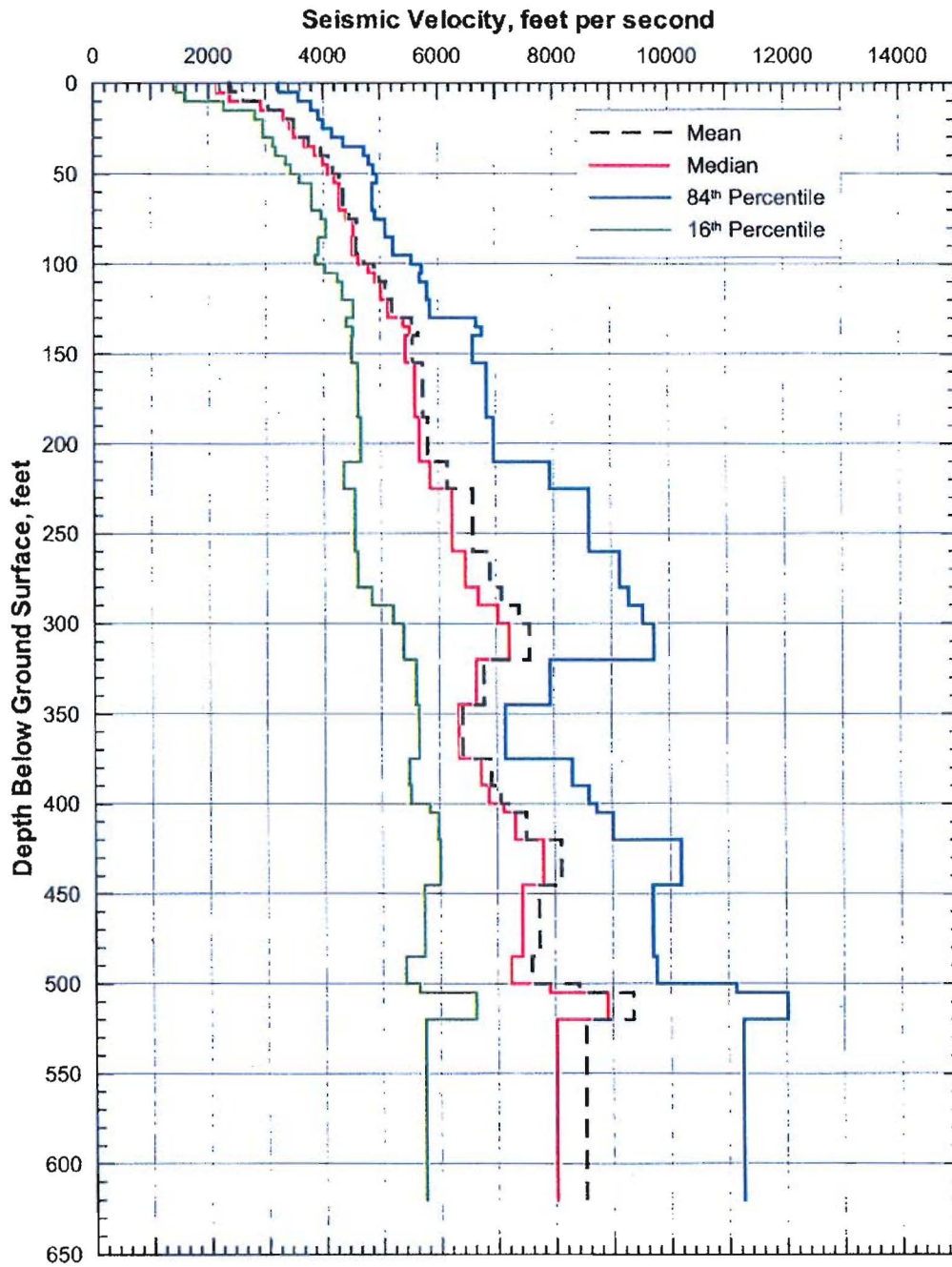
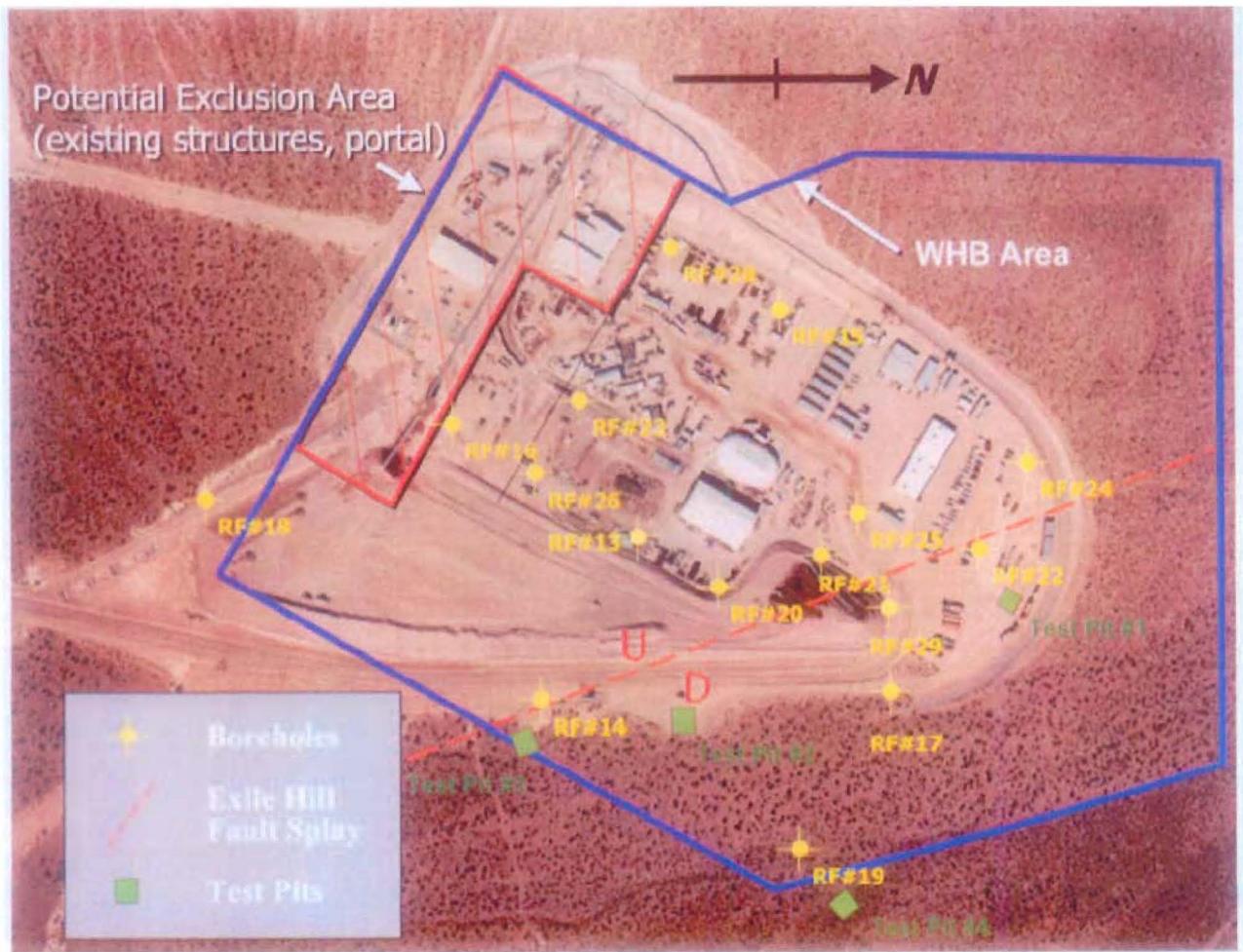


Figure 6-23. Compression-wave velocities from downhole measurements in the surface facilities area. (Figure 23 of BSC 2002a)





NOT TO SCALE

Source: BSC 2002a [DIRS 157829], Figures 2 and 3, YMP Photograph #BN8811\_50

NOTE: "U" and "D" signify the upthrown and downthrown sides, respectively, of the Exile Hill fault splay.

**Figure 6-24. WHB showing location and upthrown and downthrown sides of Exile Hill Fault Splay. (Figure 6.2-89 from BSC 2004a)**

#### 6.4.2.1.1 Alluvium

Figure 6-25 and Figure 6-26 show compilation plots of the shear and compression wave velocities measured by the various seismic survey methods for the alluvium layer. The data discussed in Section 6.4.2.1 is used in the figures. The seismic velocity data from the downhole and SASW (DTN: MO0110SASWWHBS.000) surveys are plotted at the mid-depth of the velocity intervals. As Figure 6-13 indicates, the SASW survey lines were conducted at various locations in the surface facilities area. Not all of the surveys corresponded directly with a known boring. Hence, for shear-wave velocity profiles provided in BSC 2002a (Figures 54, 55, 57, 61, 63, 76, 82, 85, and 87), only a select number of SASW surveys corresponding to the lithology of known borings were used.



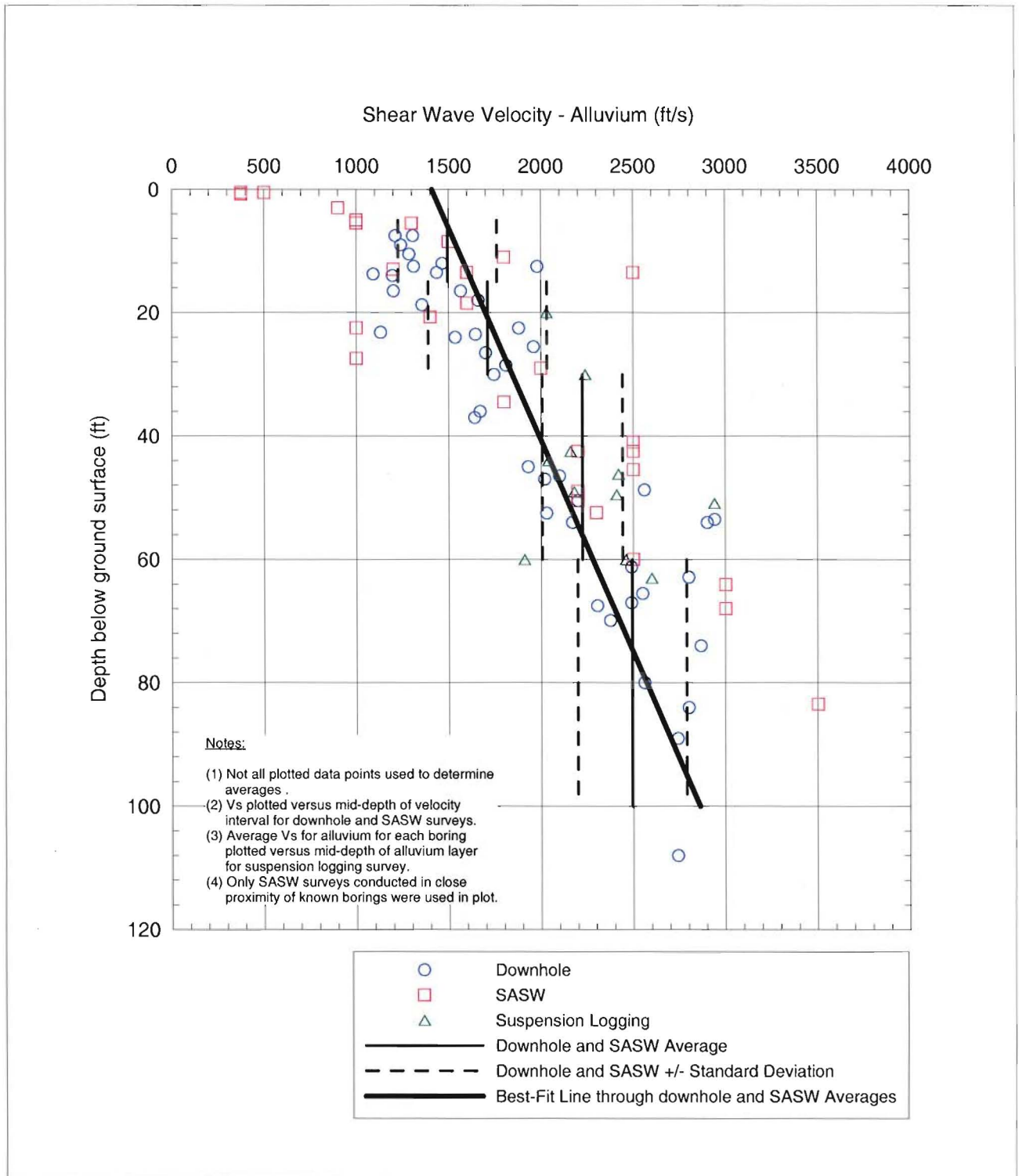
Data obtained from suspension logging surveys (source-to-receiver method) shown in Tables VII-2 and VII-3 from BSC (2002a) are also plotted in Figure 6-25. The data contains average seismic wave velocities calculated for each boring drilled in the alluvium.

Average seismic velocities at various depth intervals (5-15 feet, 15-30 feet, 30-60 feet, and 60-100 feet) were calculated from the downhole and SASW survey data and fitted to a linear best-fit relationship for the shear wave velocity shown in Figure 6-25. A detailed discussion is provided in Appendix A of this report.

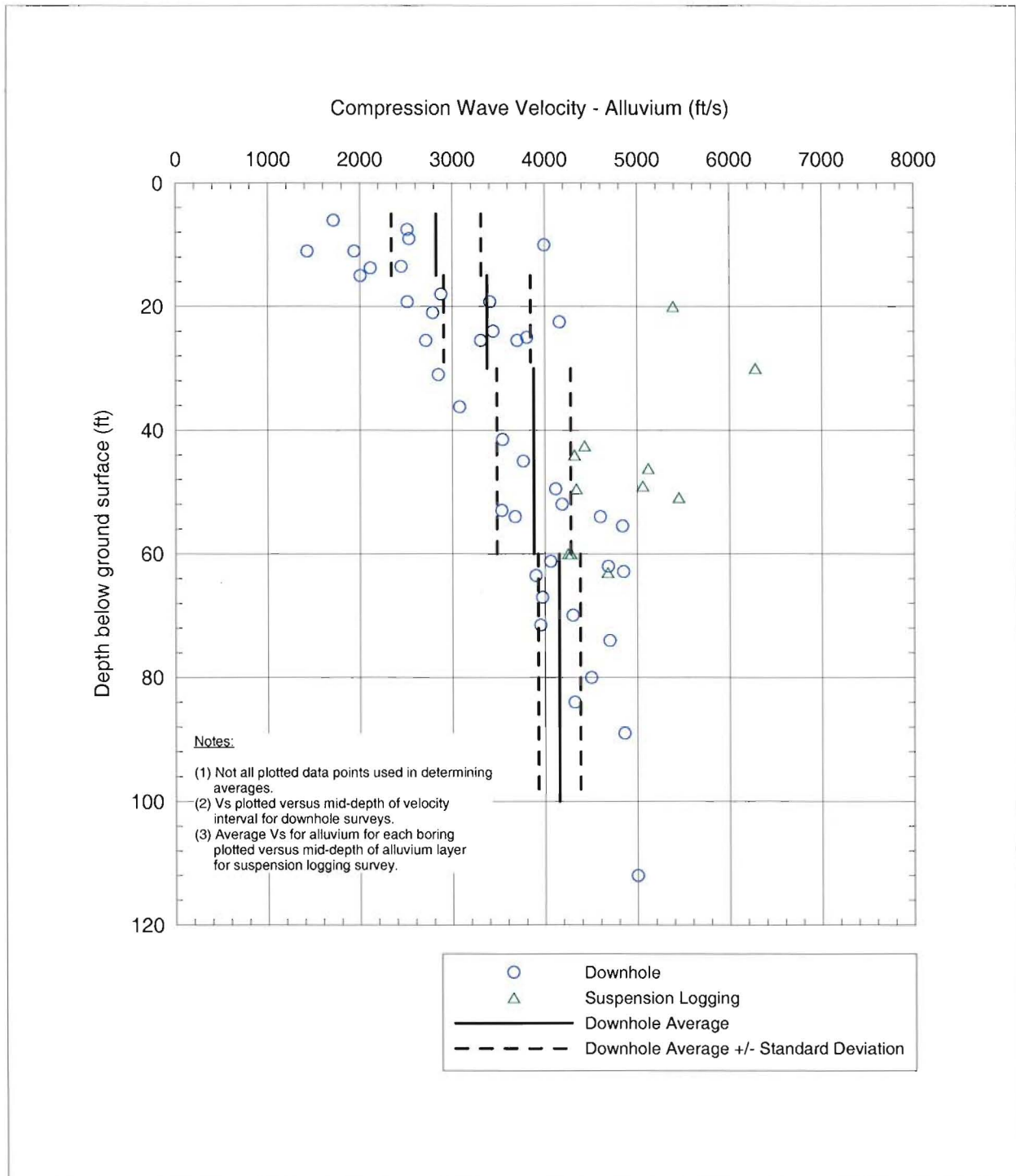
The shear wave and compression wave velocities were also determined in BSC (2004a) for the alluvium separately for each side of the Exile Hill Fault Splay. The shear wave and compression wave velocities on the upthrown side of the Exile Hill Fault Splay are presented in Figure 6-27 and Figure 6-28, respectively. The shear wave and compression wave velocities determined for alluvium on the downthrown side of the Exile Hill Fault Splay are presented in Figure 6-29 and Figure 6-30, respectively.

Figure 6-31 presents a comparison of the shear wave velocity relationships estimated in Appendix A (simple averaging technique) to the more rigorous analysis performed in BSC 2004a. The two methods provide similar results.

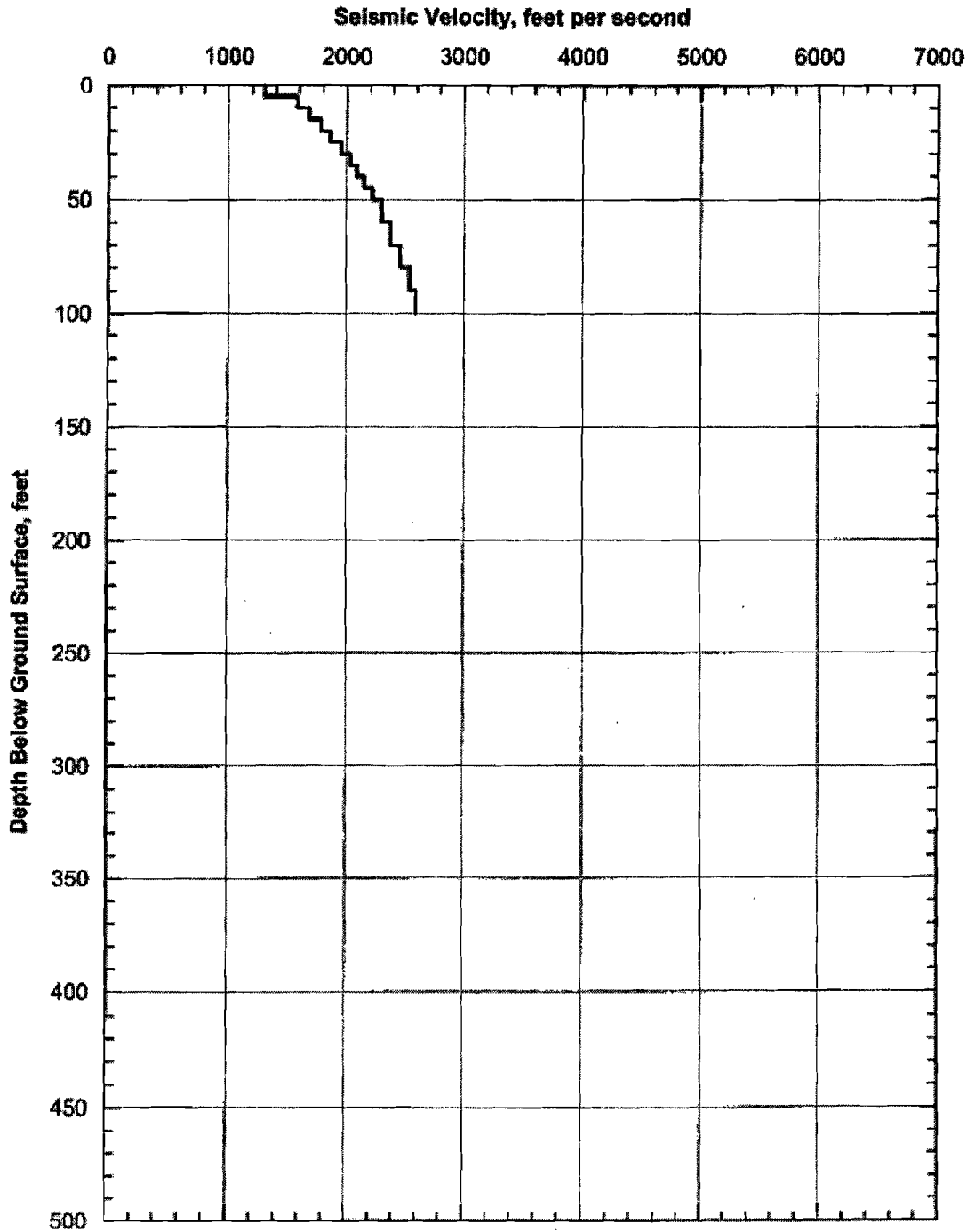
Recommended seismic wave velocity values for alluvium are provided in Table 2-1.



**Figure 6-25. Shear-wave velocities for alluvium layer from downhole, SASW, and suspension surveys.**

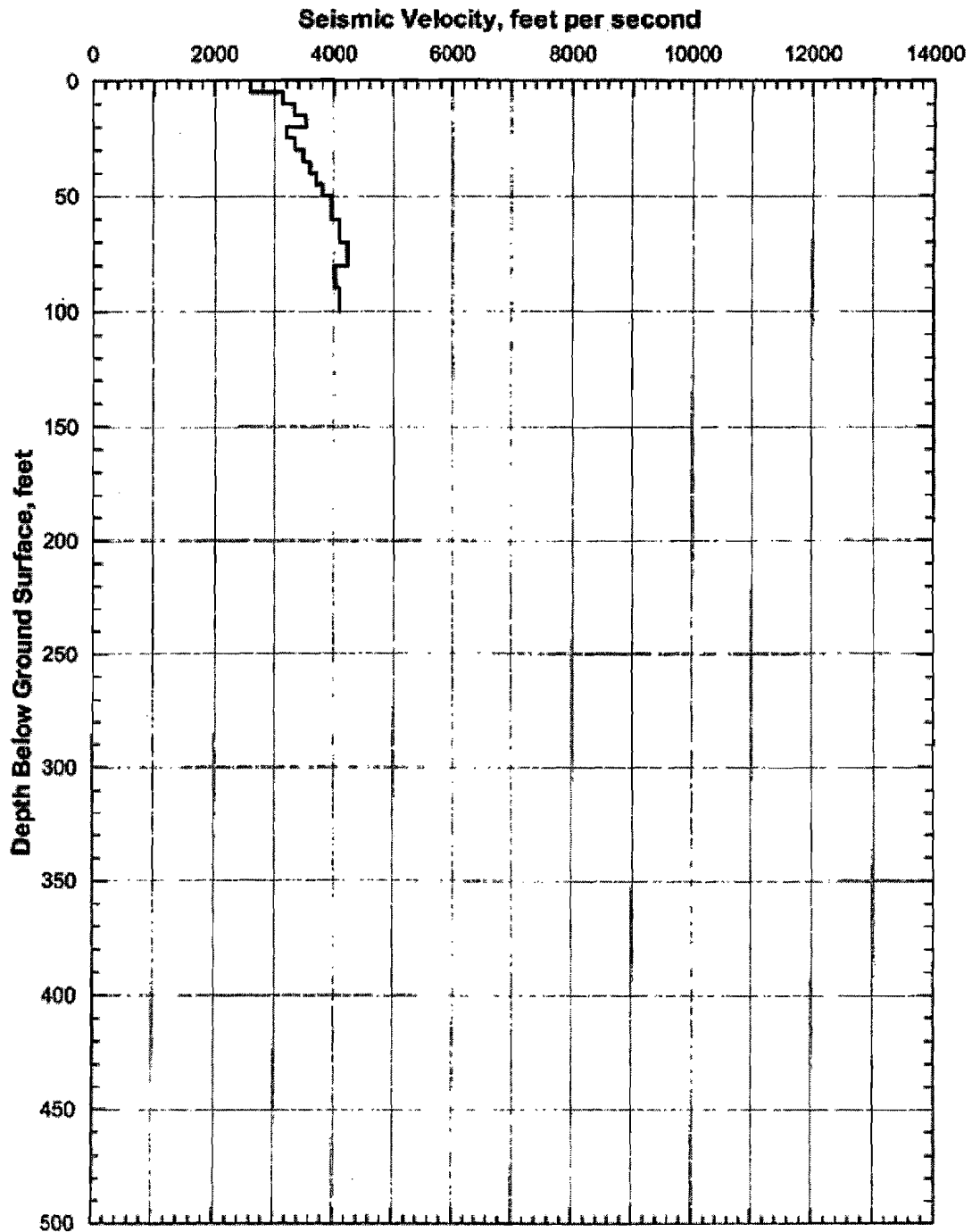


**Figure 6-26. Compression-wave velocities for alluvium layer from downhole and suspension surveys.**



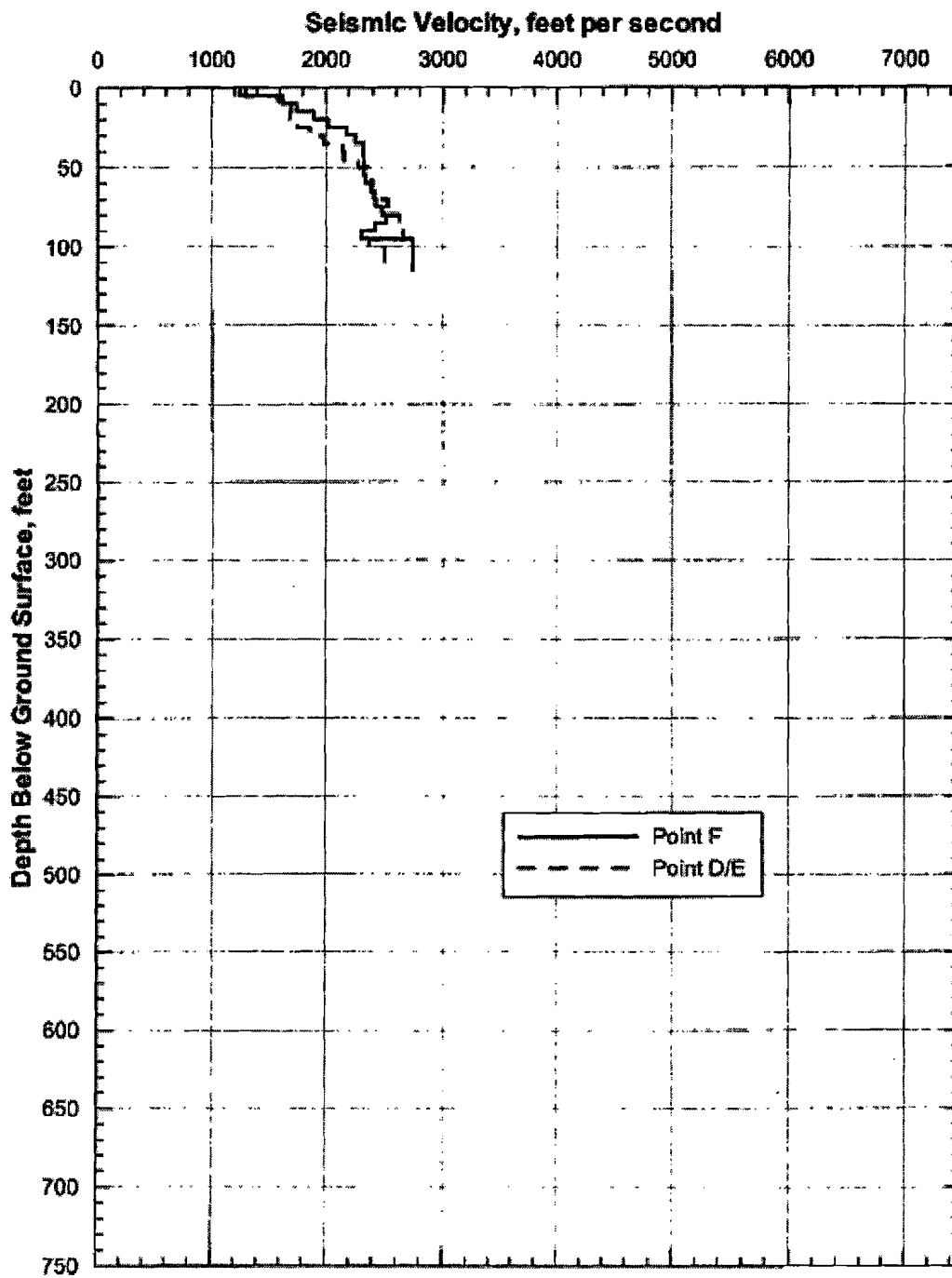
Source: Wong and Silva 2003 [DIRS 163201], p. 88, Figure 27

Figure 6-27. Base Case shear wave velocity profile for alluvium in the surface facilities area—upthrown side. (Figure 6.2-121 from BSC 2004a)



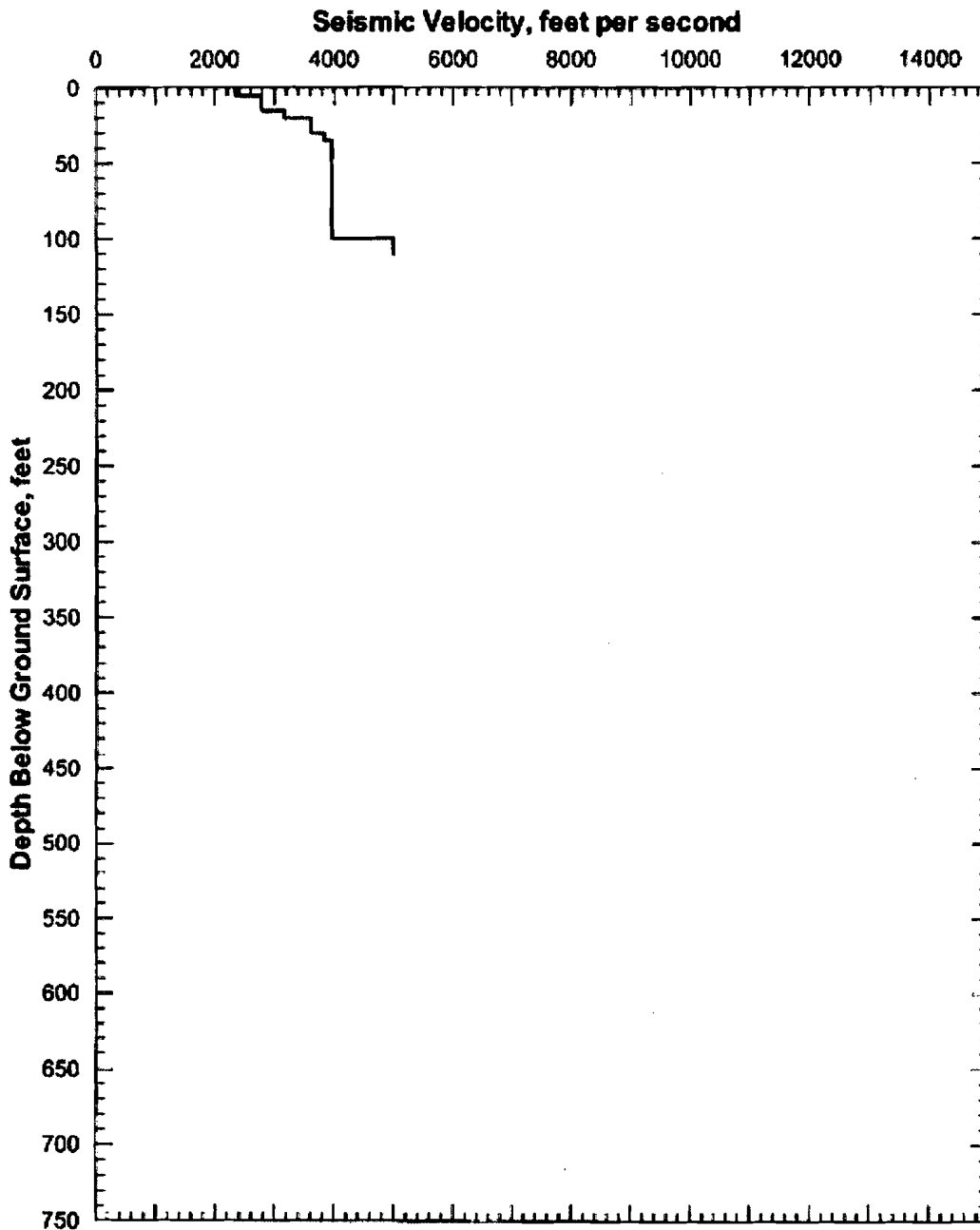
Source: Wong and Silva 2003 [DIRS 163201], p. 90, Figure 29

**Figure 6-28. Base Case compression wave velocity profile for alluvium in the surface facilities area—upthrown side. (Figure 6.2-122 from BSC 2004a)**



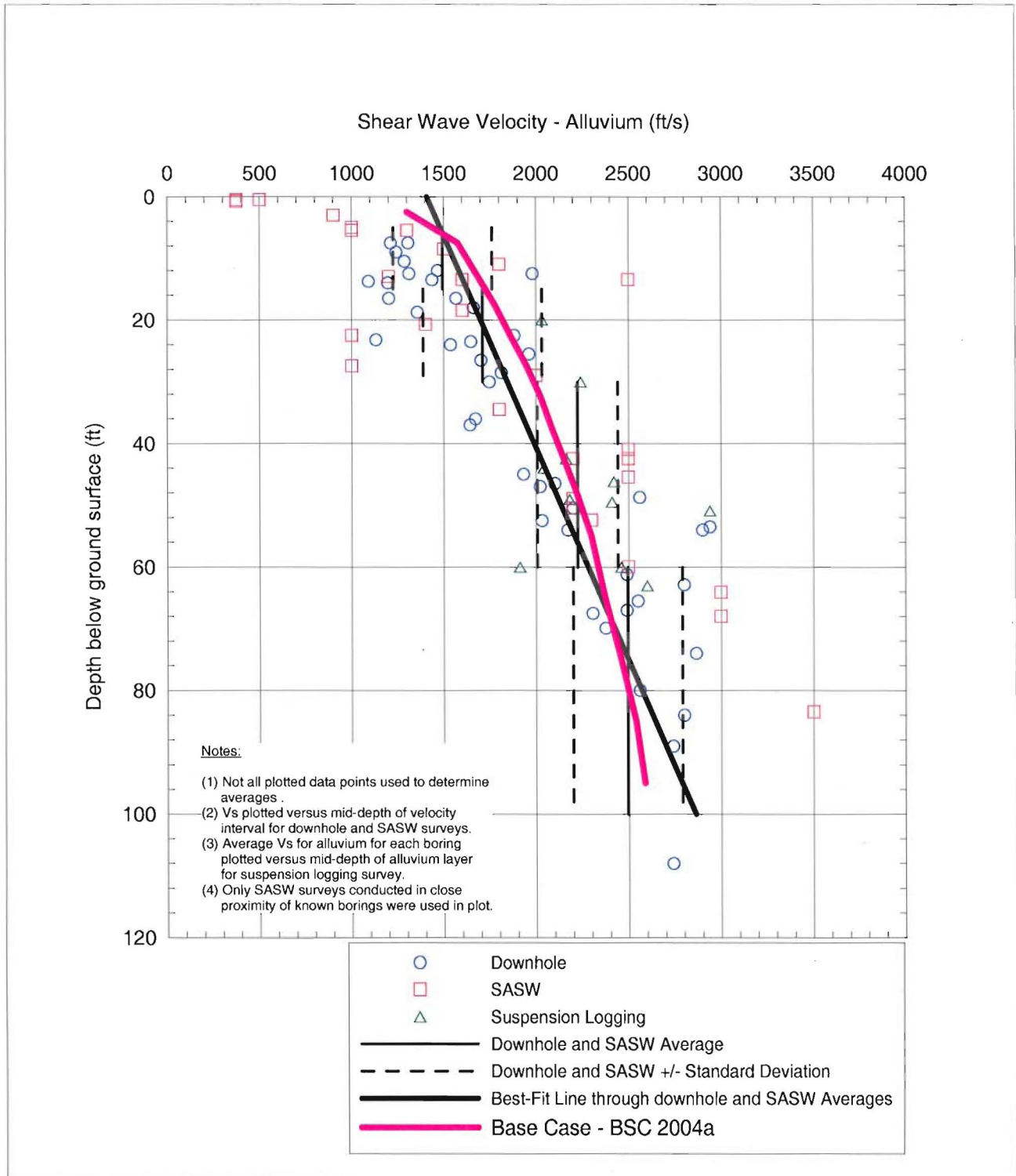
Source: Wong and Silva 2004b [DIRS 170444], page 102

Figure 6-29. Base Case shear wave velocity profile for alluvium in the surface facilities area—downthrown side. (Figure 6.3-176 from BSC 2004a)



Source: Wong and Silva 2004b [DIRS 170444], page 108

**Figure 6-30. Base Case compression wave velocity profile for alluvium in the surface facilities area—downthrown side. (Figure 6.3-179 from BSC 2004a)**



**Figure 6-31. Comparison of simple averaging (Appendix A) and Base Case (2004a drowthrown side) shear wave velocity profiles for alluvium in the surface facilities area**

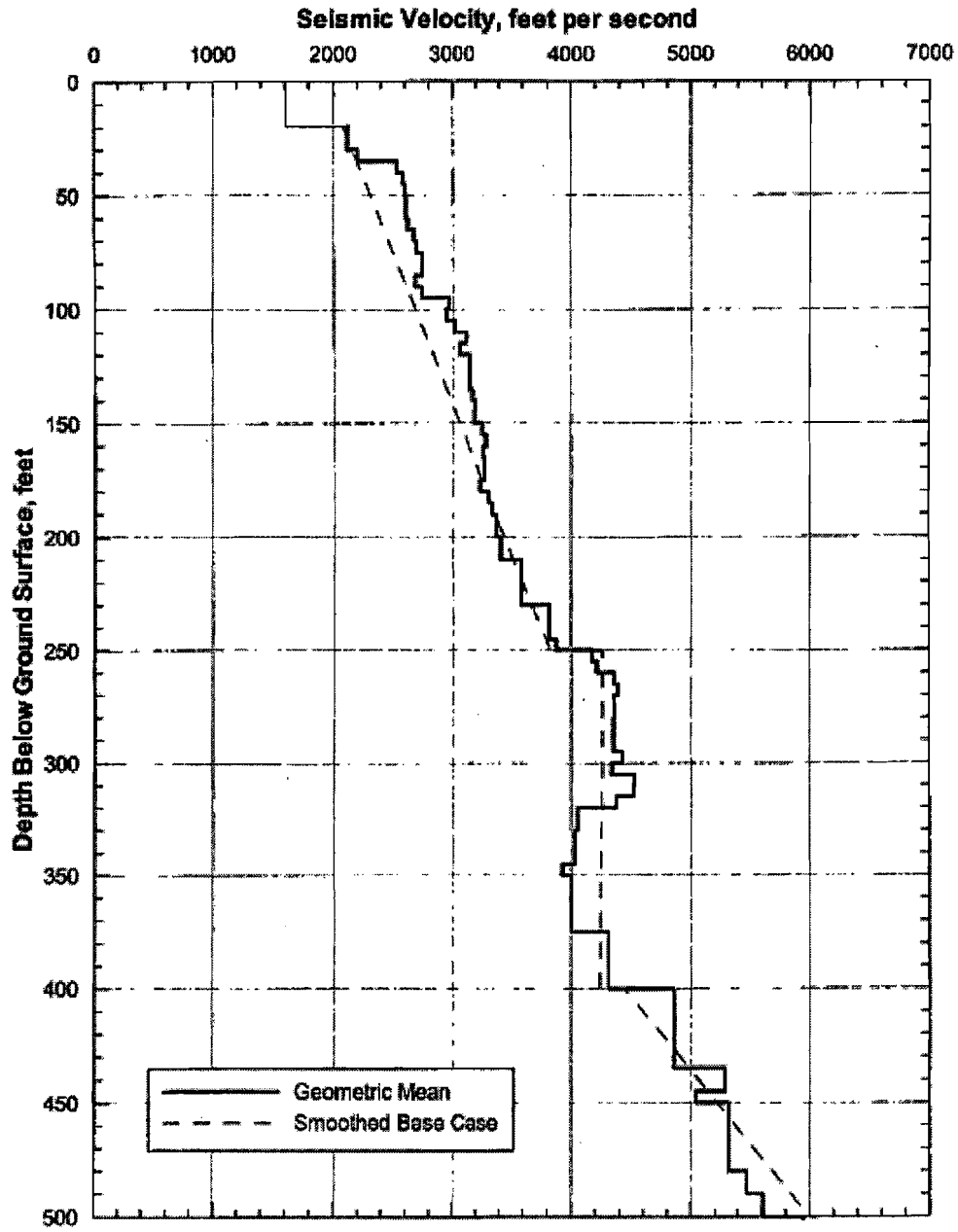


#### **6.4.2.1.2 Bedrock**

Shear and compression wave velocity averages were also computed for the bedrock (tuff) units identified in Section 6.1.4.3 using a methodology similar to that performed for the alluvium. This was performed for the downhole, suspension logging, and SASW line surveys. A detailed discussion is provided in Appendix A of this report.

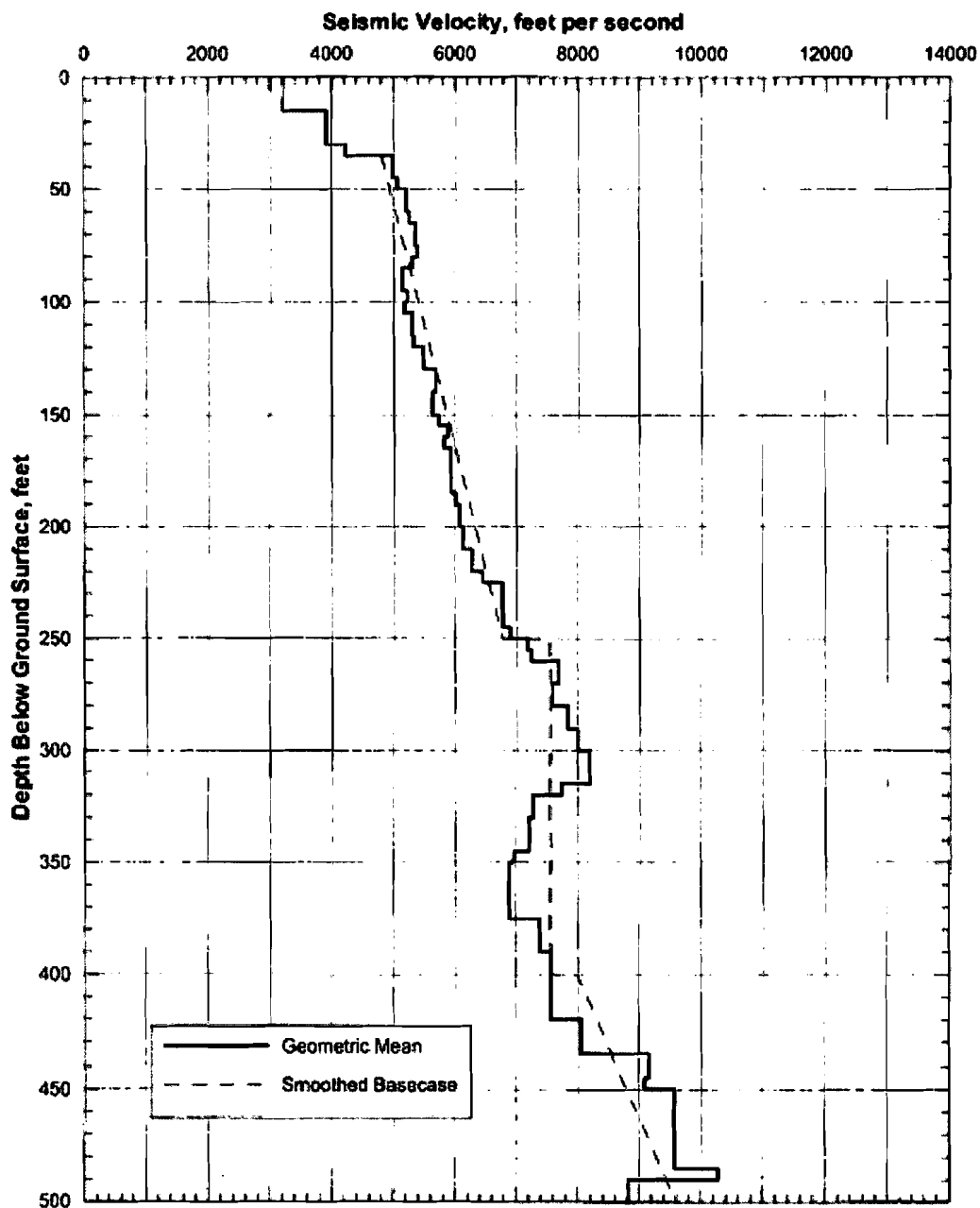
The shear wave velocities determined in BSC (2004a) for tuff on the upthrown and downthrown sides of the Exile Hill Fault Splay are presented in Figure 6-32 and Figure 6-34, respectively. The compression wave velocities determined in BSC (2004a) for tuff on the upthrown and downthrown sides of the Exile Hill Fault Splay are presented in Figure 6-33 and Figure 6-35, respectively.

Recommended seismic wave velocity values for the bedrock are provided in Table 2-1.



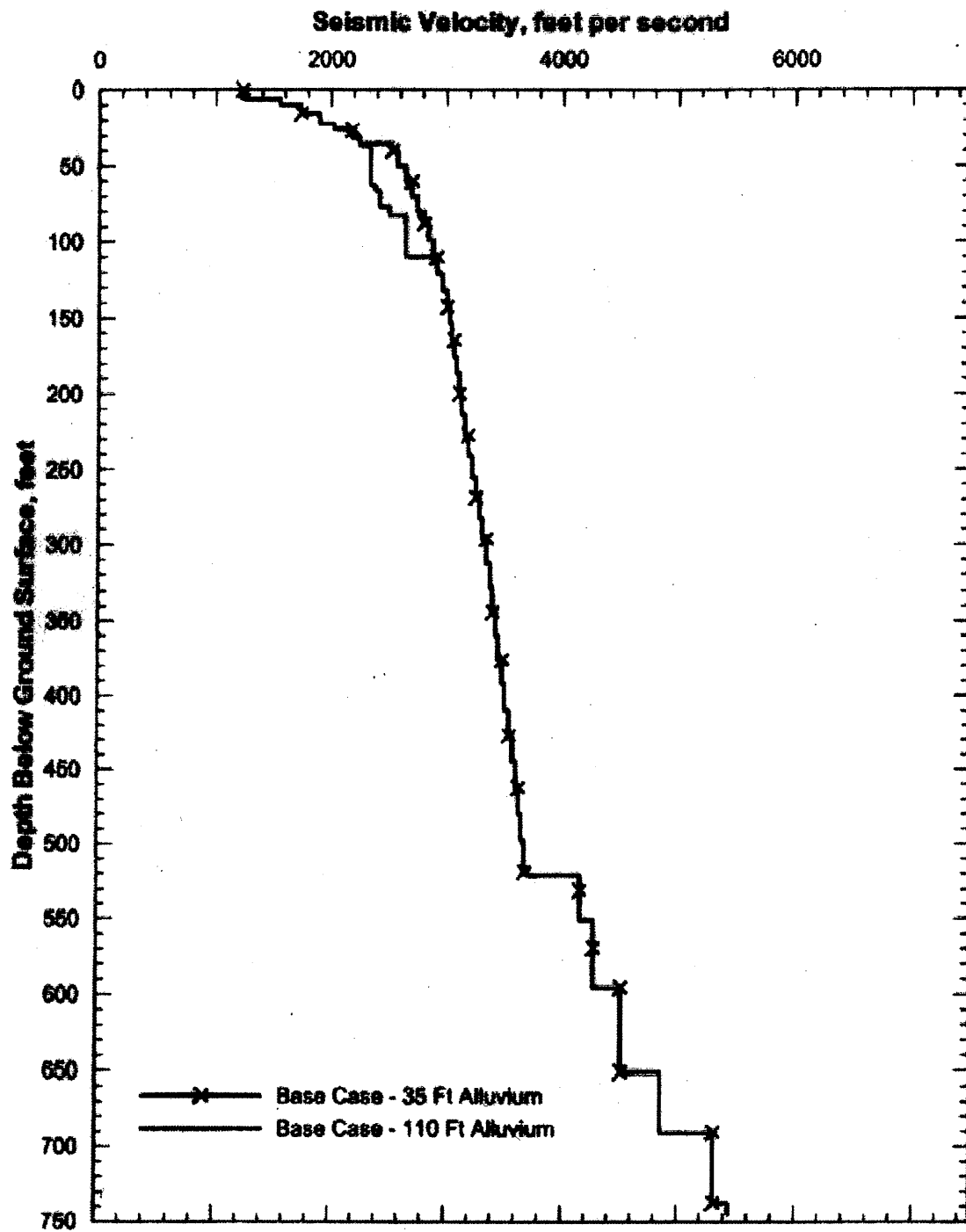
Source: Wong and Silva 2003 [DIRS 163201], p. 91, Figure 30

Figure 6-32. Base Case shear wave velocity profile for tuff in the surface facilities area–upthrown block. (Figure 6.2-119 from BSC 2004a)



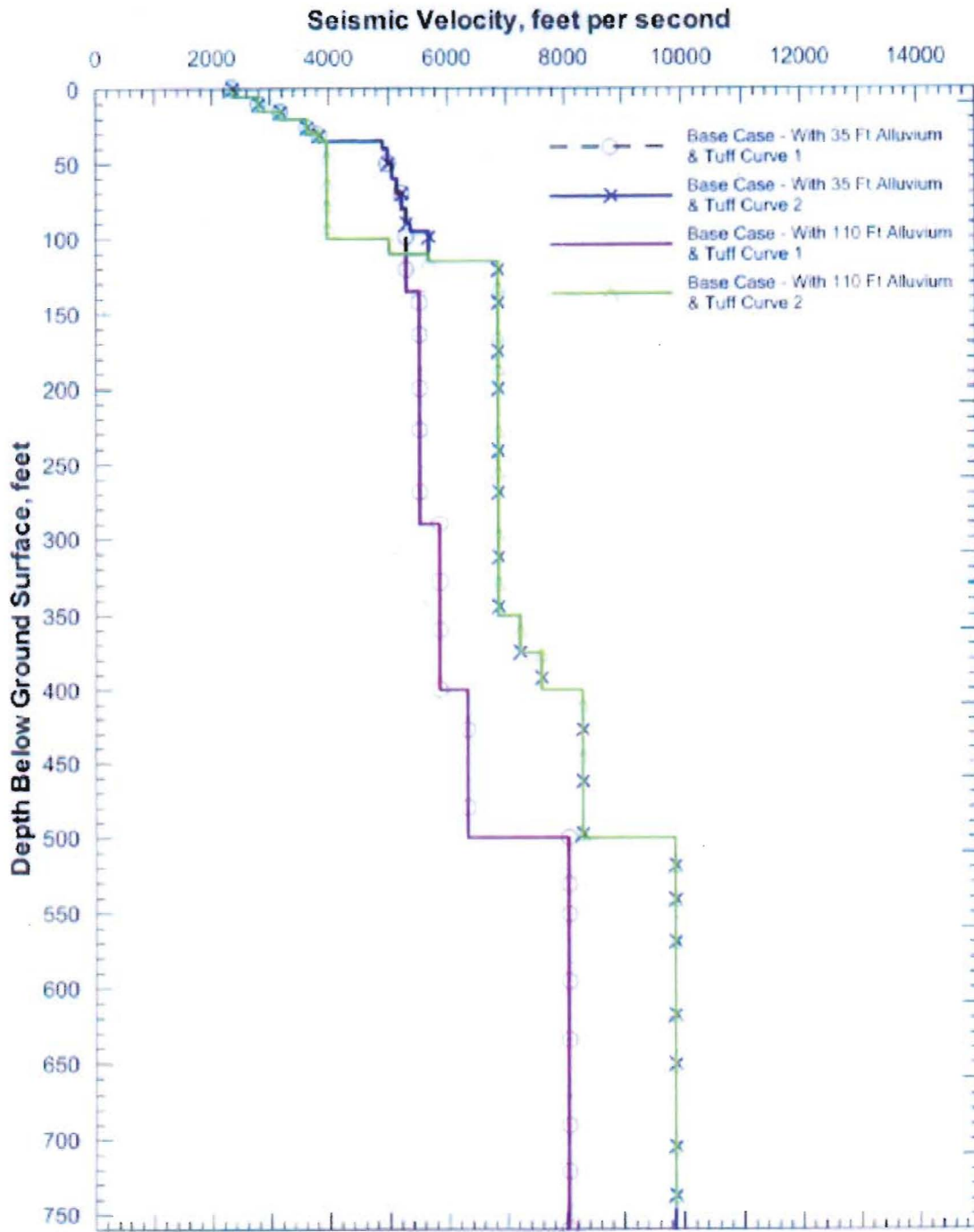
Source: Wong and Silva 2003 [DIRS 163201], p. 93, Figure 32

**Figure 6-33. Base Case compression wave velocity profile for tuff in the surface facilities area–upthrown block. (Figure 6.2-120 from BSC 2004a)**



Source: Wong and Silva 2004b [DIRS 170444], page 115

Figure 6-34. Base Case shear wave velocity profile for alluvium and tuff in the surface facilities area-downthrown block. (Figure 6.3-177 from BSC 2004a)



Source: Wong and Silva 2004a [DIRS 170443], SR 128, pages 3 and 4

**Figure 6-35. Base Case compression wave velocity profiles for alluvium and tuff in the surface facilities area–downthrown block. (Figure 6.3-180 from BSC 2004a)**

### 6.4.2.1.3 Engineered Fill

No geophysical surveys could be performed on the proposed engineered fill. Hence, shear wave velocities measured from the dynamic laboratory testing (RCTS) were considered (Attachment XVII of BSC 2002a). Ten reconstituted specimens were tested for dynamic response characteristics by low-amplitude RC tests with confinement pressures ranging from 2 to 64 psi. The average total unit weight and percent of Modified Proctor of the specimens were 116 pcf and 93%, respectively. Four of these samples were tested in 2 stages to investigate the impact on the dynamic properties of increasing the water content of the granular fill after placement. For an estimated mean total stress of 8 psi, the average shear wave velocity measured from the dynamic testing was  $700 \pm 70$  ft/s. This appears low for dense sand. As an upper bound limit, 1500 ft/s is recommended for the shear wave velocity. The shear wave velocity range for engineered fill is essentially equivalent to that of alluvium.

From Section 6.4.2.2, using the range of Poisson's ratio for the engineered fill and equation (5), the range of compression wave velocity was estimated to be 1500 to 3700 ft/s.

### 6.4.2.1.4 Roller Compacted Soil Cement

Typical seismic velocities for roller-compacted soil cements are discussed in Section 6.4.3.

### 6.4.2.2 Poisson's Ratio

From the estimated average shear and compression wave velocities, representative Poisson's ratios for the alluvium and bedrock were determined using the following relationship:

$$\nu = \frac{2V_s^2 - V_p^2}{2V_s^2 - 2V_p^2}, \quad (\text{Eq. 5})$$

where  $V_p$  = compression wave velocity

$V_s$  = shear wave velocity

$\nu$  = Poisson's ratio

For the engineered fill, Bowles (1996) recommends a range of 0.3 to 0.4 for a dense cohesionless sand. The recommended values are summarized in Table 2-1.

### 6.4.2.3 Total Density

Table 12 of BSC (2002a), provides a statistical summary of density measurements by lithostratigraphic unit from the borehole wireline geophysical surveys (made in boreholes RF#16, #18, #20, #21, #22, #24, and #28). Figure 101 of BSC (2002a), shows the total densities measured versus depth. This information is summarized in Table 6-12 below.

**Table 6-12. Mean Values of Soil Density from Borehole Geophysical Surveys (adopted from Table 12 of BSC 2002a).**

Unit	Mean Density (pcf)
Existing Fill	115
Alluvium, Qal	116 <sup>(1)</sup>
Bedrock, Tmbt1	110
Bedrock, Tpki	98
Bedrock, Tpbt5	112
Bedrock, Tpcrn	117
Bedrock, Tpcpun	132
Bedrock, Tpcpul	130
Bedrock, Tpcpmn	145
Bedrock, Tpcpll	136
Bedrock, Tpcpln	132

<sup>(1)</sup> Assumption 4 of Section 5 in BSC (2002a) was not considered in the values.

Densities of the bedrock were also measured in the dynamic laboratory tests. BSC (2002a) compares the mean values from the in-situ tests and dynamic laboratory tests, as well as values obtained from previous borehole samples in the area (Table 34 of BSC 2002a). Some variability exists between the different methods of measurement. Since the number of measurements obtained from dynamic tests was too small to provide reliable numbers compared to the in-situ tests, it was not considered. In accordance with Section I.3.1 of BSC (2002b), it is recommended that the lowest density value obtained for bedrock (approximately 100 pcf from the Tpki rock unit) be used for design as this provides the most conservative value for bearing capacity calculations.

#### 6.4.2.4 Shear Moduli

Although dynamic shear moduli,  $G$ , values for the alluvium and bedrock were determined from the dynamic soil laboratory testing, the laboratory tests are primarily performed to measure the modulus reduction and damping ratio curves. Factors that may not be representative in the laboratory samples such as aging and cementation may affect  $G$  measurements. Hence, the dynamic soil shear modulus for the alluvium and bedrock is calculated using the theory of elasticity. The following equation is used:

$$G_{MAX} = \rho V_s^2, \quad (\text{Eq. 6})$$

where  $\rho$  = mass density, which is the unit weight of the soil divided by the acceleration of gravity

$V_s$  = average shear wave velocity estimated in Section 6.4.2.1

The upper and lower bound shear-wave velocity values are used to determine the maximum shear modulus as shown in Table 2-1

### 6.4.2.5 Modulus Degradation and Material Damping

#### 6.4.2.5.1 Alluvium

Figure 6-36 (Figure 6.2-147 of BSC 2004a) presents the effects of the shear strain on the normalized shear modulus ( $G/G_{max}$ ) and material damping ratio ( $D_{min}$ ). These figures were derived from dynamic laboratory testing performed on reconstituted samples. The following testing-related factors, in order of largest influence, were considered in developing the design curves (BSC 2004a, Section 6.2.4.3):

1. Destruction of cementation
2. Decrease in coefficient of uniformity
3. Variation in confining pressure in the field
4. Variation in density in the field
5. Increase in mean particle size
6. The test boundary size

Research available in the geotechnical literature provide guidance on the difference in dynamic behavior between reconstituted, scalped samples and field conditions relative to these factors. Two sets of mean curves are recommended to adequately incorporate uncertainty in the dynamic response of the alluvium as a result of the limited test data available.

The lower mean average (LMA, dashed) lines represent the case where natural cementation in the field breaks down under ground motion producing strains and follows the relationship presented in Figure 7.A-3 of EPRI (1993) for the middle of the range indicated for gravels.

The upper mean average (UMA, solid) lines were developed as an envelope of the data above 0.01% strain and a general fit to the data at small strains (<0.01%) and generally fit the relationships for cohesionless soils between depths of 250 ft and 500 ft as presented in Figure 7.A-18 of EPRI (1993).

Both the UMA and LMA curves were developed in a subjective manner. The UMA curves acknowledge the lack of experience in the geotechnical community with this type of soil and the limited test data. The six factors listed were considered in developing both sets of curves, but more directly with the LMA curves.



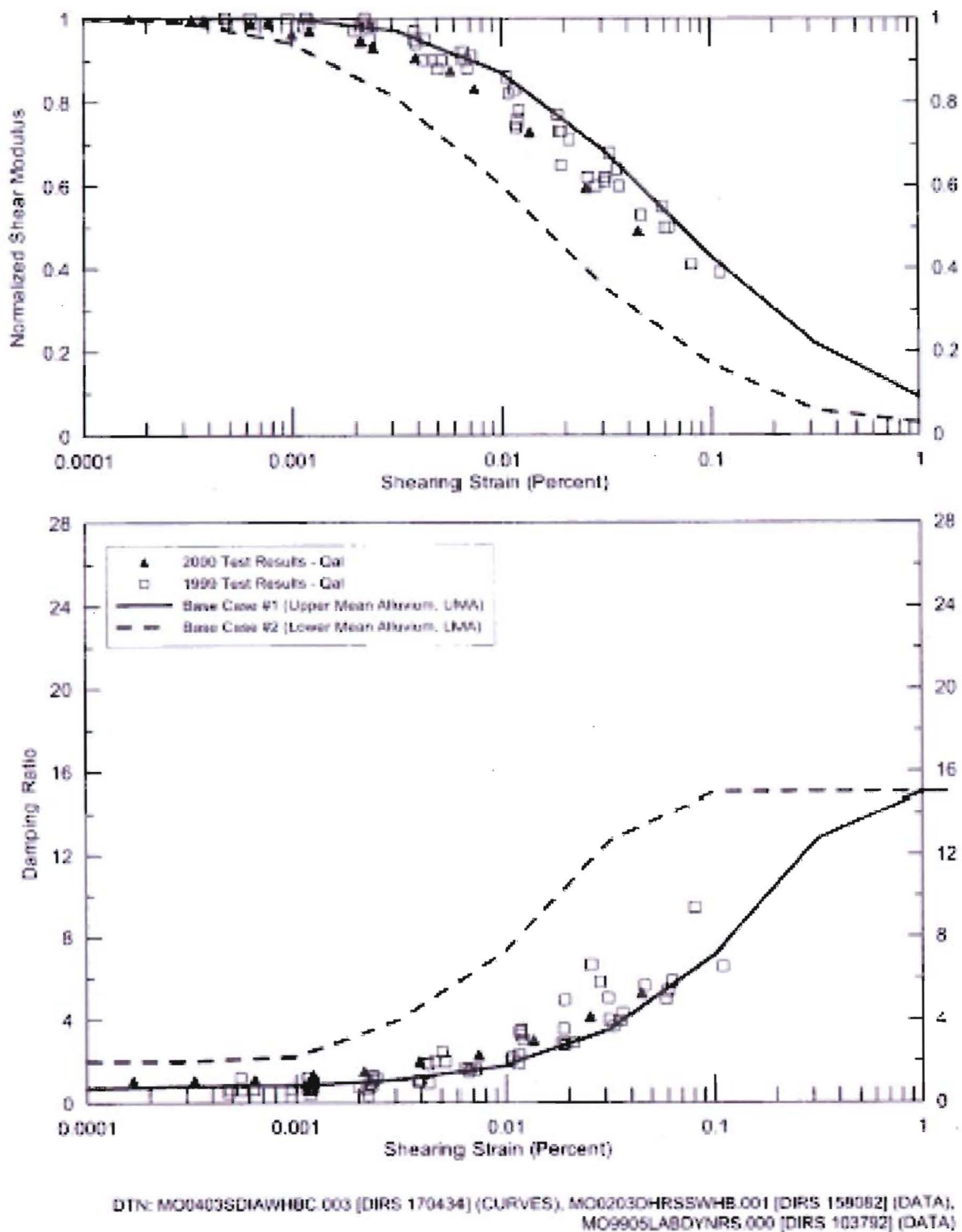


Figure 6-36. Normalized shear modulus and damping ratio for alluvium. (Figure 6.2-147 of BSC 2004a)

#### 6.4.2.5.2 Bedrock

As stated in Section 6.3.2.3 of this report, dynamic tests were performed on a total of 18 tuff specimens divided into three groups based on their dry unit weight:

- Group 1:  $\gamma_d$  from 133 pcf to 147 pcf
- Group 2:  $\gamma_d$  from 117 pcf to 132 pcf
- Group 3:  $\gamma_d$  from 78 pcf to 94 pcf

Based on these tests it was determined that there were no correlations between the shear modulus and damping ratio degradation relationships and lithostratigraphic unit, degree of welding, or dry unit weight, and therefore, all dynamic test results on tuff could be grouped together (BSC 2004a).

However, test specimen size, amount of fractures, voids, and planes of weakness, do play a role in the strain behavior of the tuff. In consideration of this, similar to the alluvium, two sets of degradation relationship curves were also developed for the tuff—for upper mean tuff (UMT) and lower mean tuff (LMT). Figure 6-37 shows the shear modulus reduction and damping ratio curves for the tuff bedrock (taken from Figure 6.2-139 of BSC 2004a).

The UMT shear modulus reduction curve was developed considering the generalized shape of cohesionless soil curves from EPRI (1993, Figure 7.A-18) fitted through the most linear laboratory test data. For the damping ratio curve the corresponding EPRI (1993, Figure 7.A-19) curves were used, constrained to have 1) a small-strain damping ratio of 0.5% for consistency with the site attenuation ( $\kappa$  of 0.0186 sec) used in the PSHA, and 2) a maximum of 15% in accordance with guidance from NUREG-0800, Section 3.7.2 (NRC 1989).

The LMT modulus reduction curve was developed considering the generalized shape of cohesionless soil curves from EPRI (1993, Figure 7.A-18) fitted through the middle of the laboratory test data, then adjusted downward by a factor of 4 based on the ratio of  $G_{max}$  in the field (based on Vs) to that in the laboratory to account for heterogeneity and fracturing in the field. The resulting curve corresponds to the 21 ft to 50 ft curve in EPRI (1993, Figure 7.A-18). For material damping the corresponding curve from Figure 7.A-19 of EPRI (1993) was used. As for the UMT curves, a small-strain material damping of 0.5% was used to constrain the curves at small strains.

Note that for both the UMT and LMT relationships developed; all values for strains exceeding 0.1% are extrapolated based solely on the shape of the EPRI (1993) curves.

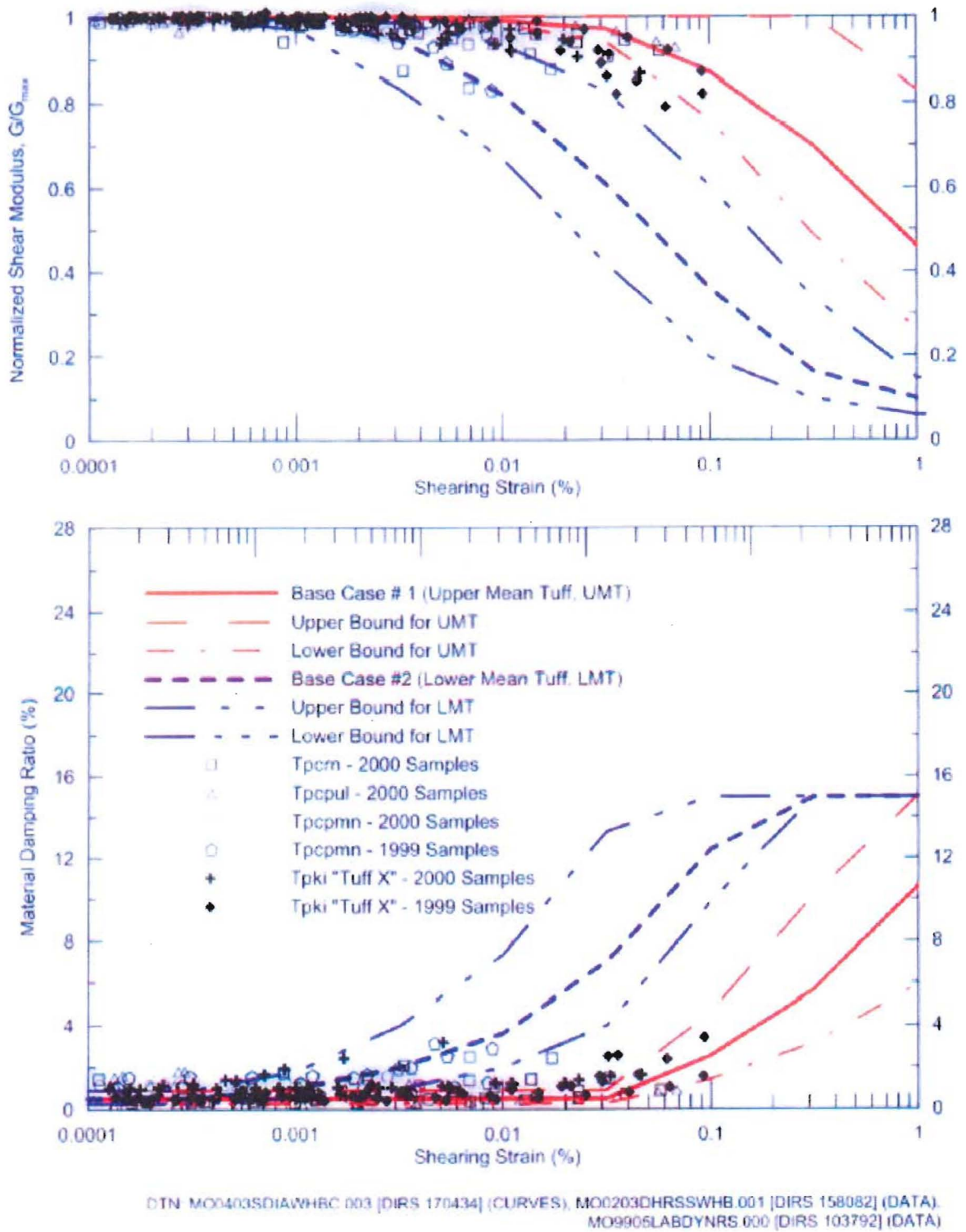


Figure 6-37. Normalized shear modulus and damping ratio for bedrock. (Figure 6.2-139 of BSC 2004a)

### 6.4.2.5.3 Engineered Fill

Figure 6-38 and Figure 6-39 show the composite shear modulus reduction and damping ratio curves for this material (taken from Figures 221 and 222 from BSC 2002a, respectively).

$G_{\max}$  increases with increasing dry unit weight of the compacted material, and decreases with increasing water content for denser specimens. The soil behavior curve is similar to that for sandy material proposed by Seed et al. (1986). However, it exhibits a higher minimum damping ratio. In general, the values of  $G_{\max}$  evaluated using the resonant column and torsional shear devices agreed within 10 percent. The values of  $D_{\min}$  evaluated using the resonant column and torsional shear devices also agreed within 10 percent.

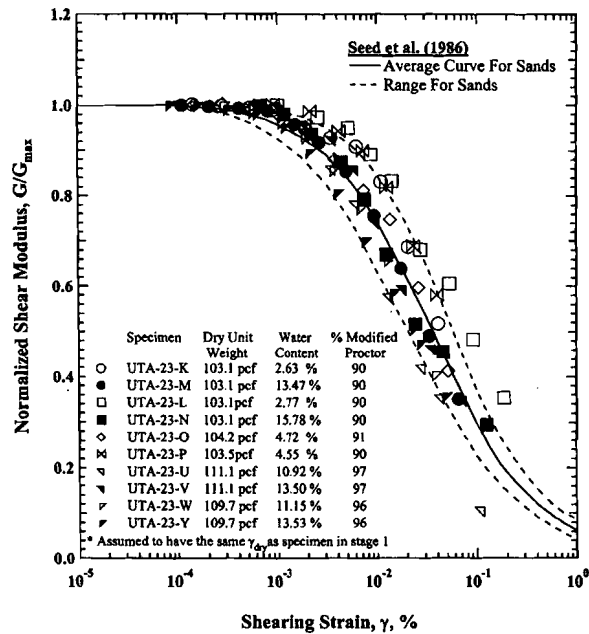


Figure 6-38. Normalized shear modulus for engineered fill from Fran Ridge Borrow Area. (Figure 221 of BSC 2002a, DTN: MO0203DHRSSWHB.001)

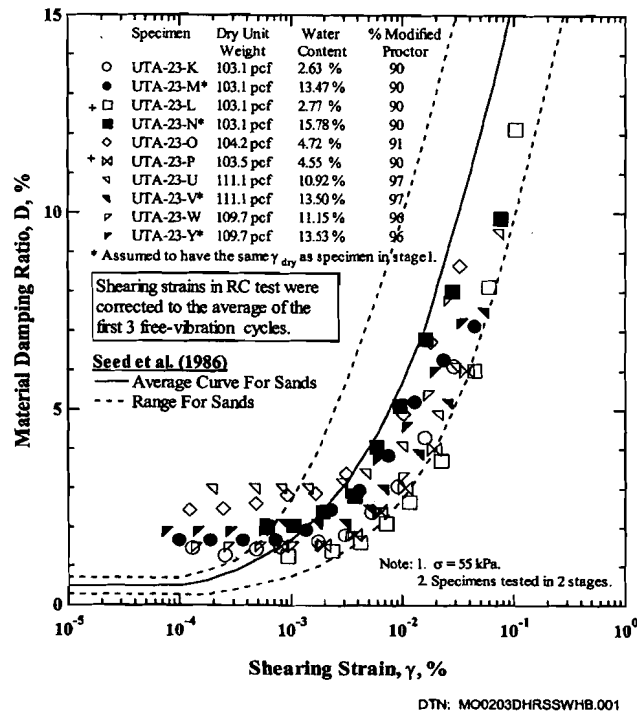


Figure 6-39. Material damping ratio for engineered fill from Fran Ridge Borrow Area. (Figure 222 of BSC 2002a, DTN: MO0203DHRSSWHB.001)

### 6.4.3 Roller Compacted Soil Cement

#### 6.4.3.1 Recommended Properties

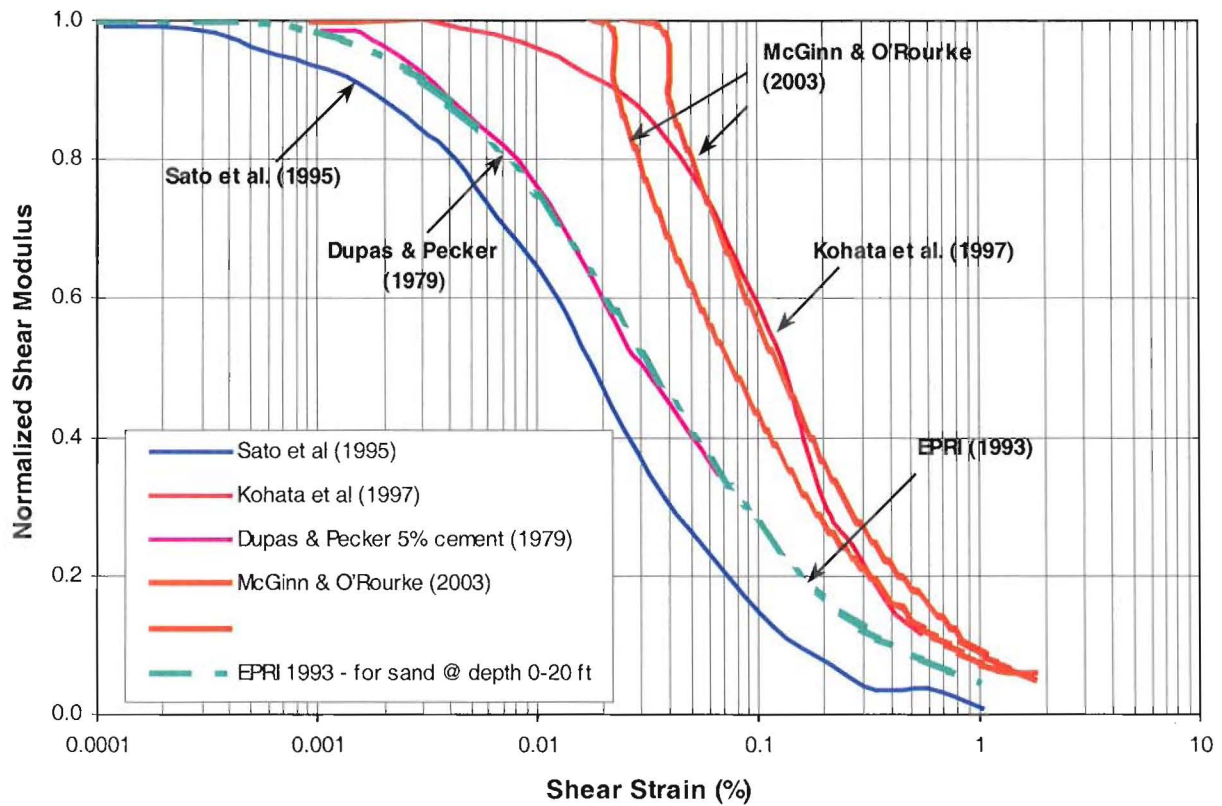
The following recommendations are based on the review of properties of roller compacted soil cement (RCSC) and deep soil mixes that are summarized in Section 9 of BSC (2004b). These parameters are provided as a first estimate for dynamic evaluation of roller-compacted soil-cement should RCSC be considered for use at the site:

- Percent cement: 4% to 12% by weight
- Unit weight: 130 pcf to 140 pcf
- Poisson's ratio: 0.30
- Shear-wave velocity,  $V_s$ :
  - Lower bound: 2000 ft/s
  - Average: 2500 ft/s
  - Upper bound: 3000 ft/s
- Shear modulus at low strain:
  - Lower bound: 100 ksi
  - Average: 180 ksi
  - Upper bound: 270 ksi

No information was found in the literature regarding shear modulus reduction curves specific to RCSC. However, the following presents a limited collection of shear modulus reduction curves for cement treated soils identified in the literature:

1. Dupas and Pecker (1979)–From cyclic triaxial tests performed on soil-cement samples. Soil was fine to medium grain sand with 5% cement by weight and compacted to 100% of the maximum density as determined by ASTM D 558. Curing time 180 days.
2. Wang (1986)–From triaxial and simple shear tests on artificially cemented sand. The material was a mixture of Monterey #0 and #20 sand with 2% cement and 74% relative density.
3. Kohata et al. (1997)–From cyclic triaxial tests performed on soil-cement samples cured for 28 days. Soil was fine-grained. Cement percentage unknown.
4. Sato et al. (1995)–From dynamic triaxial tests performed on sand-cement samples. Sand was fine to medium grained with 100% less than 0.84 mm,  $D_{60} = 0.35$  mm,  $D_{30} = 0.31$  mm, and uniformity coefficient = 1.59. Cement percentage unknown.
5. McGinn and O'Rourke (2003)–From pressuremeter tests performed on stiff clays treated with 12% to 15% cement by weight using the deep soil mixing method.

Figure 6-40 presents the normalized shear modulus data from these sources. The EPRI (1993) curve for sand for depths of 0-20 ft is included for comparison.

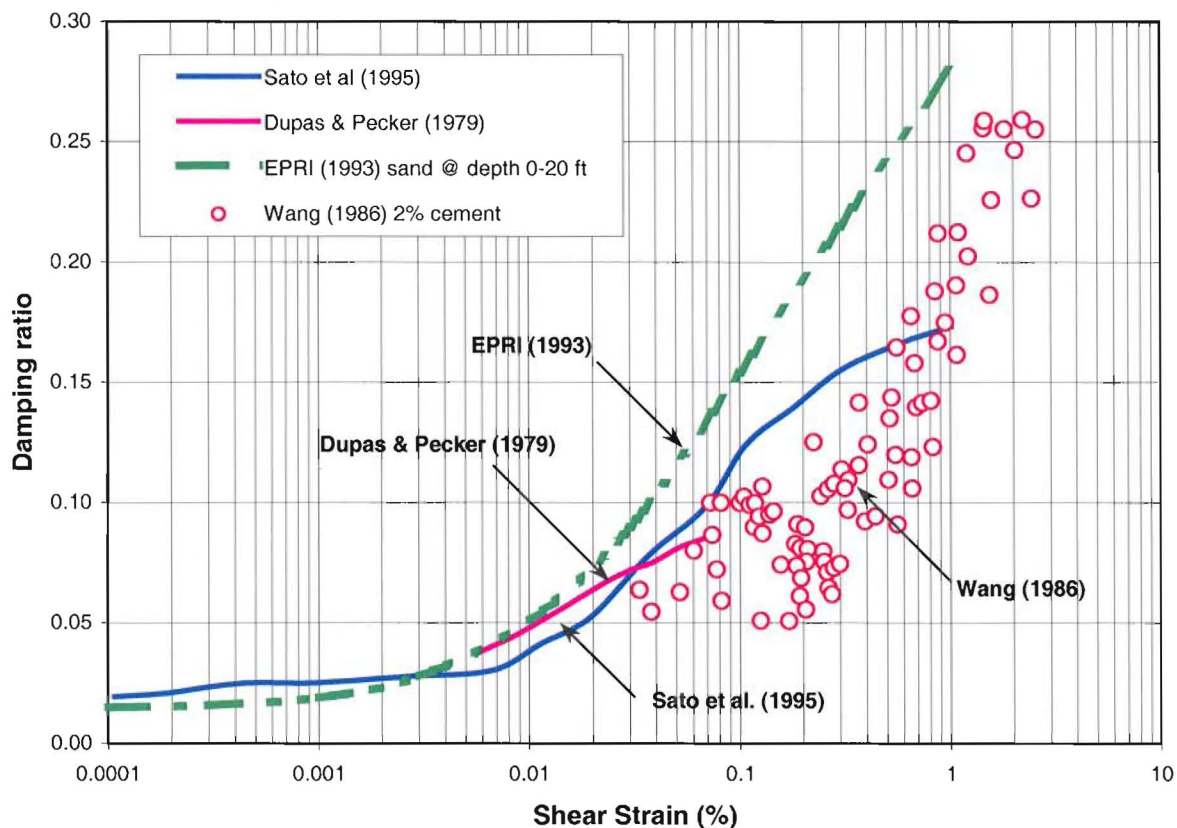


**Figure 6-40. Normalized shear modulus reduction curves for cement treated soils.**

Note that the curves by Kohata et al. (1997), and McGinn and O'Rourke (2003) were computed from fine-grained soils treated with cement, while all other curves were obtained from sand-cement mixtures.

No information was found in the literature regarding damping ratio reduction curves specific to RCSC. Only Dupas and Pecker (1979), Wang (1986) and Kohata et al. (1997) present damping ratio degradation data for soil cement mixes. Figure 6-41 presents the damping ratio degradation data from these sources. The EPRI (1993) curve for sand for depths of 0-20 ft is included for comparison.





**Figure 6-41. Damping ratio degradation curves for cement treated soils.**

Note: the curves presented in Figure 6-41 were obtained from sand-cement mixtures.

#### 6.4.3.2 Limitations of Use

Since very little data are available on non-linear properties they should be reviewed by the peer review to develop recommendations for application for design evaluation. Prior to final design a comprehensive laboratory and field testing program should be created to determine all of the above listed properties. In addition, non-linear soil-structure interaction analyses should be performed to optimize the depth and extent of soil treatment. Depending on the extent of the treatment areas the above inputs may be used either in the free-field or in SSI models.

## 7 RESULTS AND CONCLUSIONS

### 7.1 Engineering Design Parameters

Analyses outputs obtained from the calculations prepared for this report are reasonable compared to the input parameters used. The results are considered suitable for use in preliminary design.



Figures and tables containing supporting design parameters are located at the end of this section. Table 2-2 shows key results of the analyses contained herein.

### 7.1.1 Material Properties

Table 2-1 summarizes the recommended static and dynamic soil properties discussed in Sections 6.4 and 7 for design.

### 7.1.2 Foundation Pressures

The recommended foundation pressures of the soil at the surface facilities area were determined for various conditions using conventional geotechnical bearing capacity theory. Design charts are provided for allowable foundation pressures for different footing geometries resting on alluvium. Design settlements of 1-inch, or less, and ½-inch, or less, were used in the analyses. The strength parameters used for the alluvium are discussed in Section 6.4. A minimum factor of safety of 3.0 against bearing capacity failure was used (i.e.,  $q_{\text{allowable}} = q_{\text{ultimate}} / 3.0$ ).

Figure 7-2 and Figure 7-3 show the recommended bearing pressures on square and strip footings for 2-foot and 6-foot embedment depths with widths ranging from 2 to 30 feet, for 1-inch and ½-inch design settlement, respectively. Figure 7-4 and Figure 7-5 show the variation of immediate settlement with bearing pressure for square and strip footings of 5-foot, 10-foot, and 20-foot widths, for embedment depths of 2 feet and 6 feet, respectively. Figure 7-6 shows the variation of long-term settlement with foundation width. Note that in Figure 7-6, strip and square footings provide nearly identical solutions. Details of the foundation analyses are documented in Appendix B.

### 7.1.3 Settlement

#### 7.1.3.1 Short-Term Settlement

Settlement of foundations is a function of the footing size, average footing load, the depth of footing embedment, and characteristics of the soil material type. Two methods were considered to estimate the settlements for the surface facilities area: (1) Burland and Burbidge (Terzaghi et al., 1996), which uses an average  $N_{60}$  blow count value (correlated from a relationship to the relative density), and (2) Schmertmann (Terzaghi et al., 1996), which uses Young's modulus (correlated from measured shear-wave velocities). Immediate settlements induced under different foundation pressures are presented in Figure 7-4 and Figure 7-5 for a variety of conditions. A detailed description of the analyses is provided in Appendix B.

#### 7.1.3.2 Long-Term Settlement

Over time, some additional settlement will occur due to long-term, secondary settlement effects. This settlement is in addition to that estimated in Section 7.1.3.1. The long-term or secondary settlements for the surface facilities area were computed based on the method developed by Burland and Burbidge (Terzaghi et al., 1996). The settlement was determined to be less than ½

inch. Long-term settlements are presented for different footing widths (square and strip footings) and different depths of foundation embedment in Figure 7-6. A detailed description of the analysis is provided in Appendix B.

### 7.1.3.3 Elastic Settlement

Elastic settlements were computed for a large mat foundation based on a uniform vertical stress distribution, representative average shear wave velocities (see Section 6.4.2.1.1), and Young's modulus (derived from modulus degradation curves). The dimensions of (300' × 400') were used in the analysis, which encompass the largest building dimensions. Settlements under the corner and center of the mat were determined for loads of 3, 5, and 7 ksf. A detailed description of the analysis is provided in Appendix B. Results of the analysis are shown in Table 2-2.

### 7.1.3.4 Differential Settlement

In accordance with Peck, et al. (1974) Chapter 14, differential settlement between adjacent footings can be  $\frac{3}{4}$  of the maximum estimated value.

The following are allowable angular distortions,  $\delta/L$  (allowable differential settlement over a given distance), for buildings (Fig. 5.59 of Fang 1991):

<u><math>\delta/L</math></u>	<u>Building type</u>
1/500	Buildings where cracking is not permissible; Rigid circular mat or ring footing for tall and slender rigid structures

where  $\delta$  = allowable differential settlement and L = spacing distance

### 7.1.3.5 Seismically-Induced Settlement

Seismically-induced settlement is not considered to be a significant issue due to the dry and dense nature of the soils encountered at the YMP site. In addition, cementation of the native alluvium will also reduce the potential for dynamic settlement.

## 7.1.4 Coefficient of Subgrade Reaction and Equivalent Soil Springs

All shallow footings and mat foundations will be supported by the alluvium. For the design of large footings and mats it is typical to represent the soil with equivalent springs. The vertical coefficient of subgrade reaction for the alluvium is estimated based on Terzaghi (1955). For dry dense sand, the recommended value for a one-foot by one-foot plate,  $k_{s1}$ , is 600 -2000 kcf (tons/cubic foot). For the dense gravelly alluvium present at the site, it is recommended that a best estimate value of 1000 kcf (580 pci) be used. For the anticipated dense engineered fill, it is recommended that a best estimate value of 600 kcf (350 pci) be used.

These values must be reduced for large loaded sizes in accordance with the following relationship:

$$k_s = k_{s1} \left( \frac{B+1}{2B} \right)^2 \quad (\text{Eq. 8})$$

where B is the least footing dimension and  $k_s$  is the coefficient of subgrade reaction for the footing or mat. For large footings or mats  $k_s$  will approach  $\frac{k_{s1}}{4}$ . Therefore, for preliminary design, it is recommended to use 155 to 520 kcf (90–300 pci) for alluvium and 75 to 250 kcf (45–145 pci) for engineered fill. It is common practice to double the static load for dynamic load cases.

Figure 9 of USN (1986) was used to estimate the horizontal coefficient of subgrade reaction by correlations with relative density. For the very dense alluvium material, the values were estimated to be 104–120 kcf (60–70 pci). For the dense engineered fill, the values were estimated to be 60–96 kcf (35–55 pci). Results are summarized in Table 2-1.

### 7.1.5 Lateral Earth Pressures

Currently a 55-foot below-grade wall is planned for construction of a pool for the wet-process building. Lateral earth pressures were determined to estimate the loads that will act on subgrade walls. Both static and seismic conditions for yielding and non-yielding walls were considered in the analyses, including effects from compaction-induced earth pressures and static surcharge loads. Live loads and dynamic surcharge loads were not considered in the analyses. No factor of safety was applied to the calculated earth pressures. The calculations were performed using the measured properties of the alluvium (see Section 6.4.1). A coefficient of horizontal acceleration of 1g was used in the seismic analysis. The results from the seismic analysis may be scaled by any selected peak ground acceleration value.

A schematic summary of the results for yielding and non-yielding walls is shown in Figure 7-7 through Figure 7-15. A detailed description of the analyses is provided in Appendix C.

#### 7.1.5.1 Lateral Earth Pressures for Temporary Shoring

For a braced and shored excavation the lateral pressures can be estimated using a uniform pressure of 17H psf, where H is the height of the wall. Details of the supporting analysis are provided in Appendix C.

#### 7.1.5.2 Surcharge and Compaction Loads

Surcharge loading due to nearby point, line, uniform surcharge, strip, and footing loads are presented in Figure 7-8 and Figure 7-9. These relationships are based on those presented in USN (1986).

Compaction stresses imposed on the wall as a result of compaction are addressed in Appendix C. The calculated compaction stresses due to various compaction devices are presented Figure 7-11 through Figure 7-15. In accordance to Section 4.2.11.3.5 of BSC (2006b), a minimum surcharge load of 300 psf shall be used (see Section 2.2.1).

#### **7.1.6 Resistance to Lateral Loads**

Resistance to lateral loads acting on footings, mats, and subgrade walls can be developed from passive resistance of the soil and from friction acting between the structural base and the subgrade soils.

Passive resistance can be determined assuming an equivalent fluid unit weight of 515 pcf acting on the sides of the foundations. When applying passive resistance for external footings or building walls, the effective depth of embedment should be reduced by one foot. Supporting calculations are provided in Appendix C.

The ultimate coefficients of sliding friction for mat and footing foundations underlain by alluvium and engineered fill are estimated to be 0.81 and 0.90, respectively (see Appendix C).

#### **7.1.7 Slope Considerations**

Figure 7-1 is a cross-section through the site and the lower end of Exile Hill (located on the far right hand side of the figure), which is located west of the planned surface facilities. Note that the column of geologic labels on left-hand-side of Figure 7-1 has been shifted upward and do not label the corresponding geologic strata. However, that information is not critical to the intent of this figure, as only the right-hand-side of figure is needed to illustrate the relatively gentle slope of Exile Hill directly adjacent to the surface facilities to be located east of RF#28 at the toe of the slope. As the cross-section illustrates, the surface facilities site is on relatively level ground. Exile Hill immediately west of the surface facilities site slopes at about 2.5H:1V (horizontal: vertical) in its upper portion and flattens to about 6H:1V near its base adjacent to the surface facilities site. The steeper, upper portions of Exile Hill, west of the surface facilities, are composed of rock at the surface. The alluvium and colluvium constitute the flatter lower portion. Due the flatness of the adjacent alluvial/colluvial portions and the presence of rock in the upper portions, slope stability of Exile Hill is not anticipated to be a significant concern for the surface facilities site. Additional reconnaissance of the slope as recommended in Section 7.3.1 will determine if a detailed stability analysis of Exile Hill is necessary.

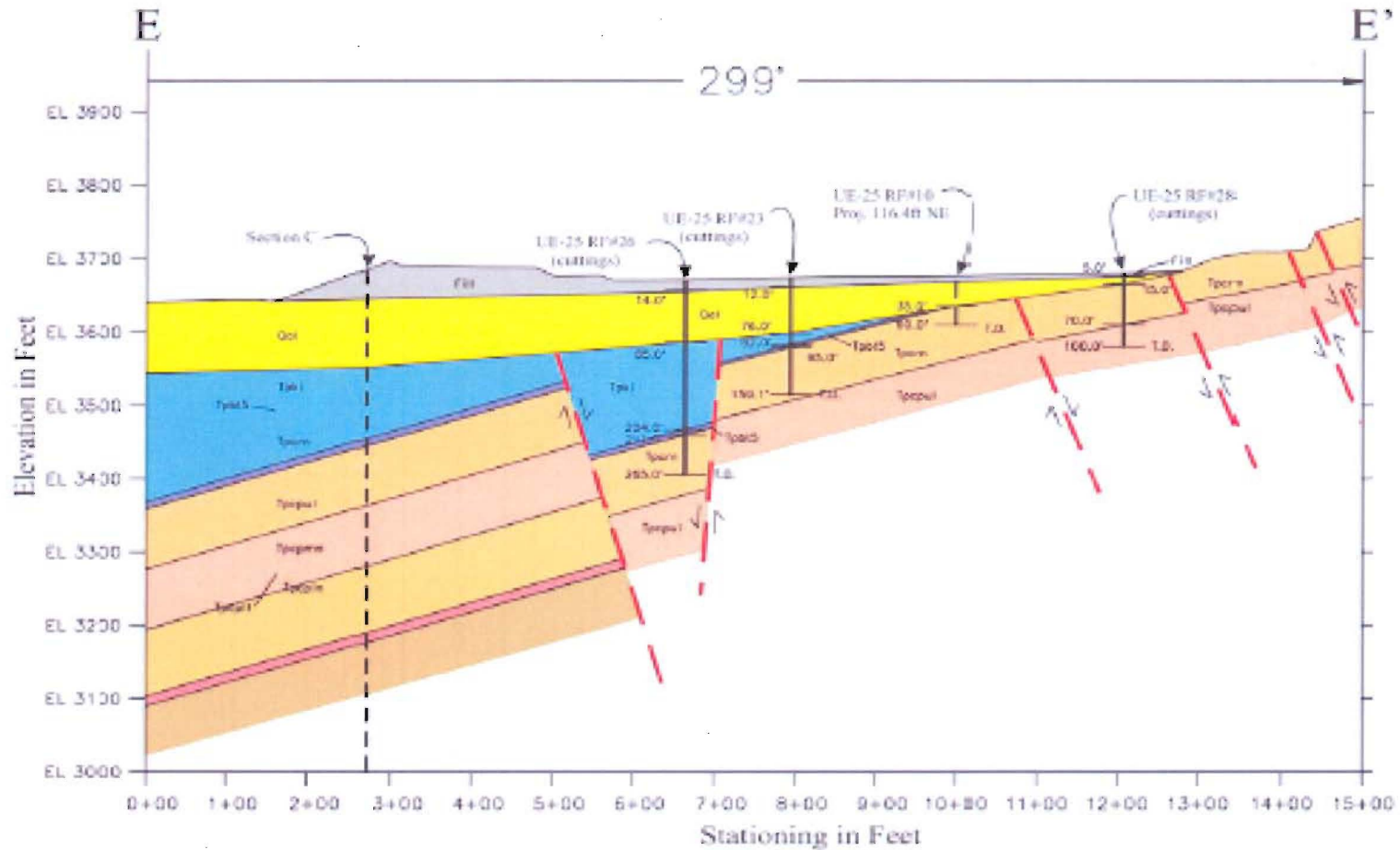


Figure 7-1. WHB Area Geologic Cross Section E-E', looking South  
(see Figure 6-7 for location of cross section)

(Excerpted from BSC 2002a. Geotechnical Data for a Potential Waste Handling and for Ground Motion Analyses for the Yucca Mountain Site Characterization Project)

This page is illegible and does not affect the technical content of the document.

*[Handwritten signature]*  
1/2/2008

Temporary cuts in the alluvium should be no steeper than 1.5H:1V. Permanent fill slopes should be no steeper than 2H:1V. Permanent cut and fill slopes should be provided with erosion protection by placement of at least 3 inches of coarse aggregate shouldering material.

### 7.1.8 Pavements

The designs of all pavement sections including the gravel construction phase pavements and any heavy transport routes should be developed using an approved pavement analysis method.

CBR was not directly measured on the site materials. Preliminary designs may be based on a CBR of 20 percent for the alluvium and engineered fill. This is the most conservative value recommended for the gravelly soils in Table 1, page 7.2-39, of USN (1986).

### 7.1.9 Percolation Rates

The percolation rate of soils have been measured at a number of different locations in the site vicinity, including the ESF Muck Storage Area (DTN: SNF29041993001.002, average 1.8 in/hr), at 14 locations within Midway Valley (DTN: GS960908312212.009, average 2.3 in/hr), and at 2 locations within Fortymile Wash (DTN: GS950308312213.004). Based on ANL-EBS-MD-000060, these sources are generally consistent with the percolation rate of about 1.8 inches per hour.

An estimate of the permeability of the alluvial soils can also be made based on the fines percentage (see Section 6.4.1.1.1) and the relationship presented in Figure 8-5 of USN (1986) for the effect of fines on permeability. Based on this figure, the permeability of the alluvium can be estimated to be between  $5 \times 10^{-5}$  fpm (0.036 in/hr) and  $5 \times 10^{-4}$  fpm (0.36 in/hr).

Alternatively, Sherard, et al (1984) determined that permeability,  $k$ , for sand and gravel filters could be calculated from  $k = 0.35 \times D_{15}^2$ , where  $D_{15}$  (the grain size for which 15% of material is smaller by weight) = 0.08mm (see Figure 6-14 and Figure 6-15) and  $k$  is in cm/sec. This results in a permeability of about  $2.24 \times 10^{-3}$  cm/sec = 3.2 in/hr. This estimate, and consideration that many of the tests performed in the three above-referenced DTN's of field percolation and double ring infiltrometer tests obtained higher values than the recommended 1.8 in/hr, would indicate that a reasonable range of permeability to be between about  $5 \times 10^{-5}$  fpm (0.036 in/hr) and  $2 \times 10^{-3}$  fpm (2.8 in/hr). Also, note that permeability can be highly variable in the alluvial materials which also include localized layers or zones of relatively impermeable caliche.

Care should be taken to use the proper test for the intended design function and add appropriate factors of safety. These numbers can also be refined by performing additional field percolation tests (ASTM D 5126) or laboratory constant-head permeability tests on reconstituted samples (ASTM D 2434).

### **7.1.10 2000 International Building Code (IBC) Soil Type**

Using the averaged shear wave velocities developed in Appendix A and reported in Table 2-1, a Soil Profile Type from the 2000 International Building Code (IBC) was selected to characterize the dynamic soil properties of the surface facilities area (ICC 2000, Table 1615.1.1).

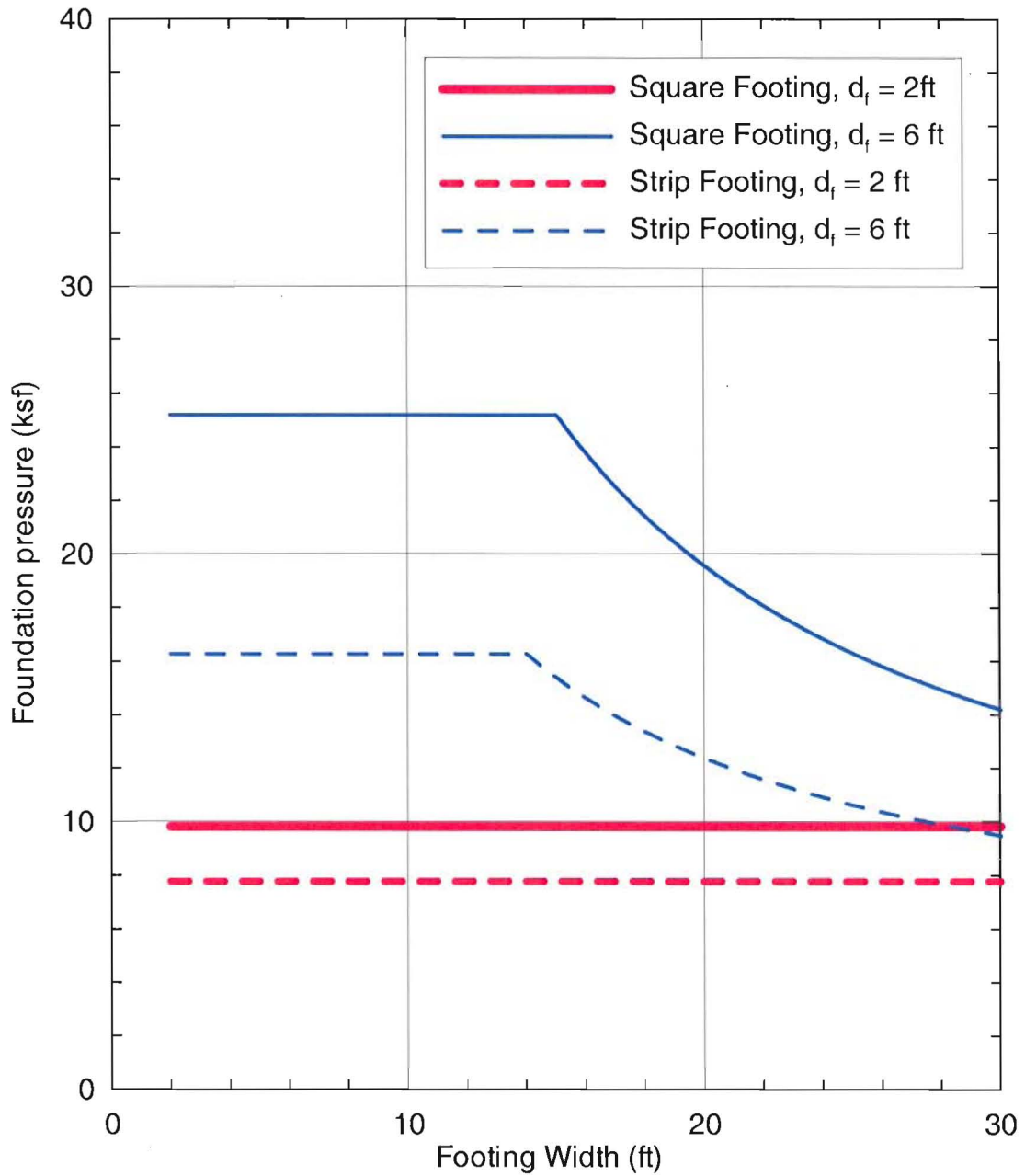
Table 2-1 summarizes the soil profile type determined for the soil units at the site.

### **7.1.11 Frost Penetration**

Figure 7-16 (Figure III-1 of BSC 2002b) below shows the potential frost penetration for the western United States. Based on this map, the potential for frost penetration at the YMP site is approximately 10 inches. Use 10 inches for design purposes.

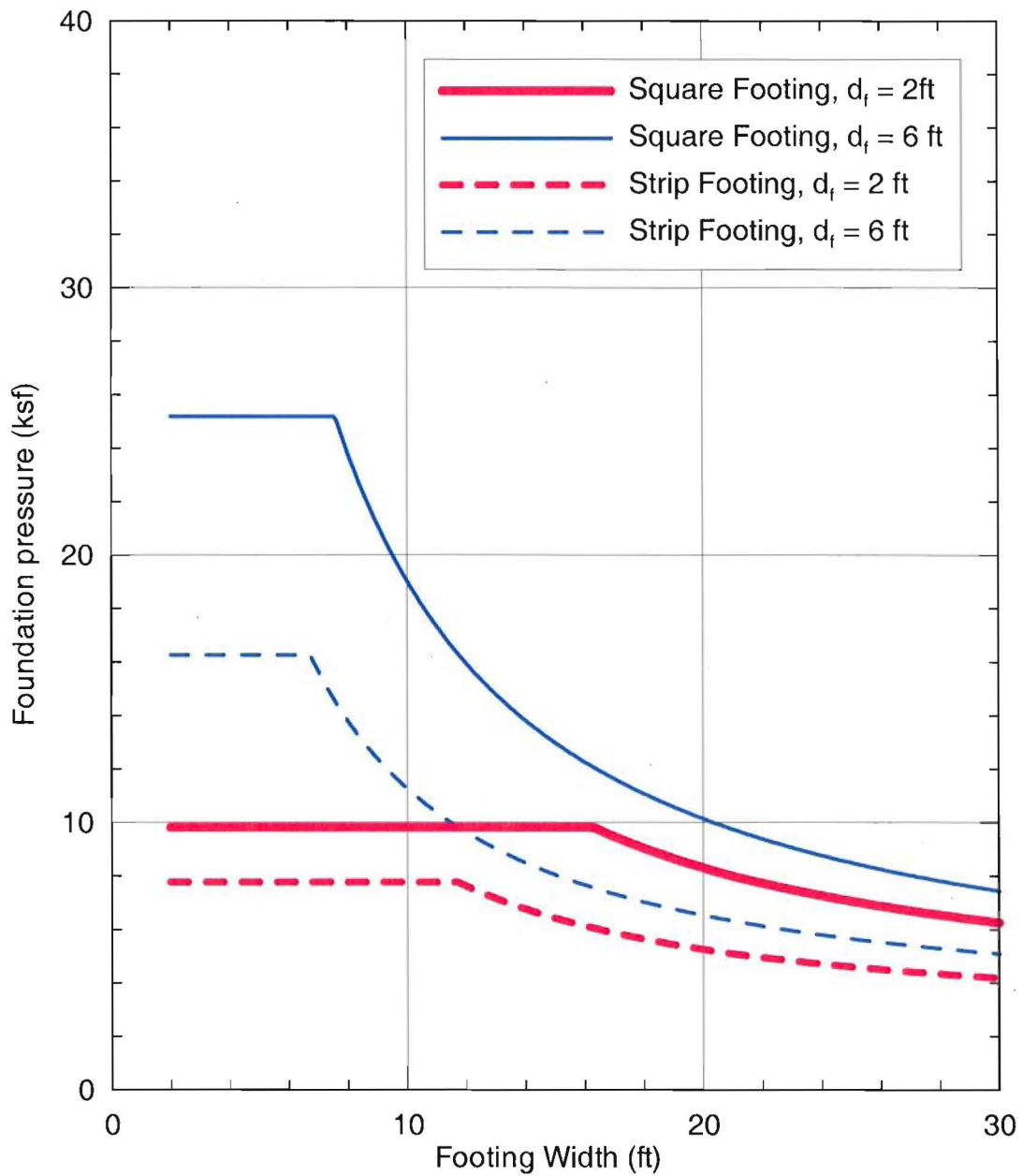
### **7.1.12 Liquefaction Potential**

As discussed in Section 6.1.4.4, groundwater is located 1270 feet below the ground surface. Therefore, there is no potential for liquefaction to occur beneath the planned structures at the site.

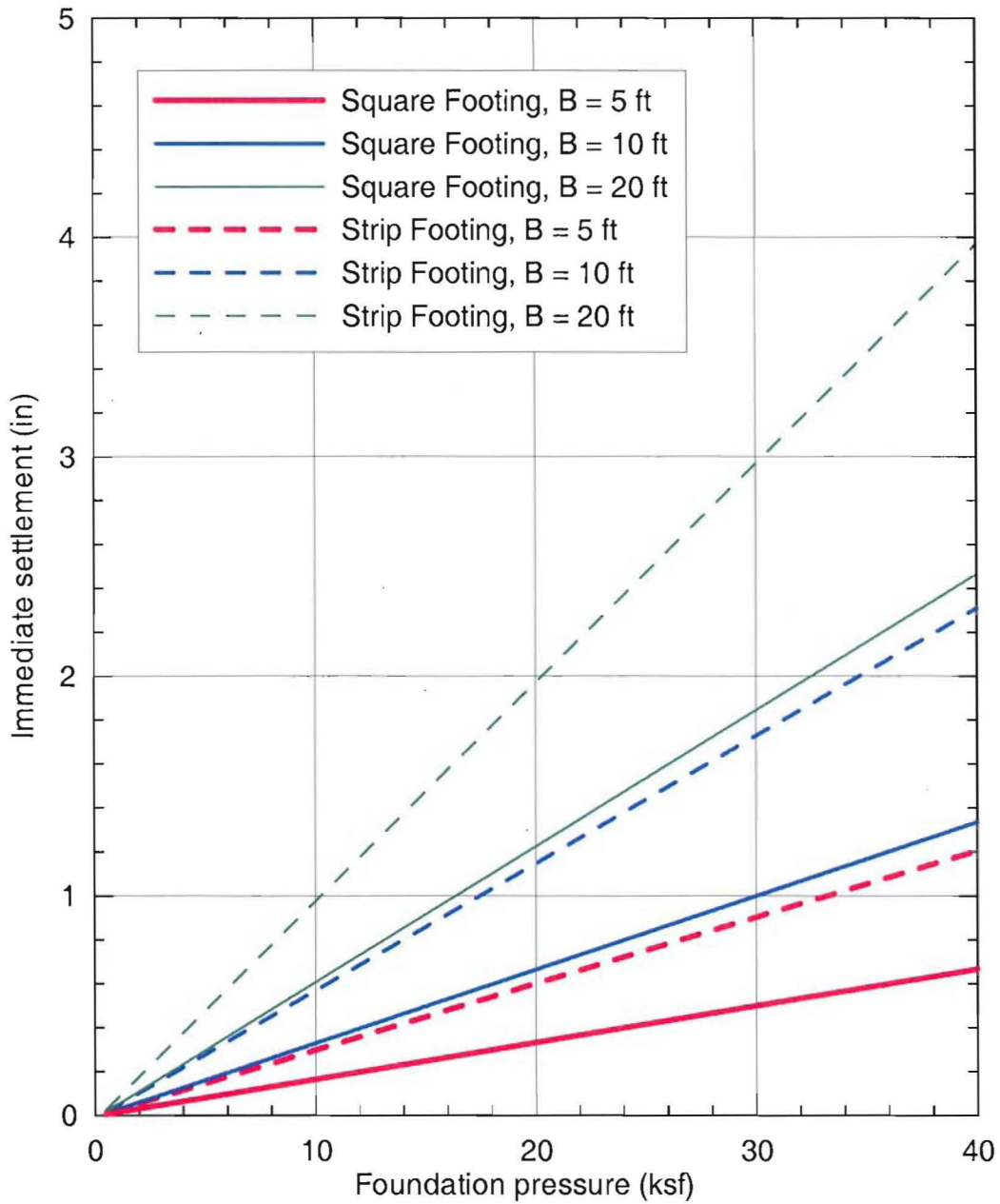


**Figure 7-2. Allowable foundation pressure for square and strip footings on alluvium vs. foundation width and foundation embedment (1-inch design settlement).**

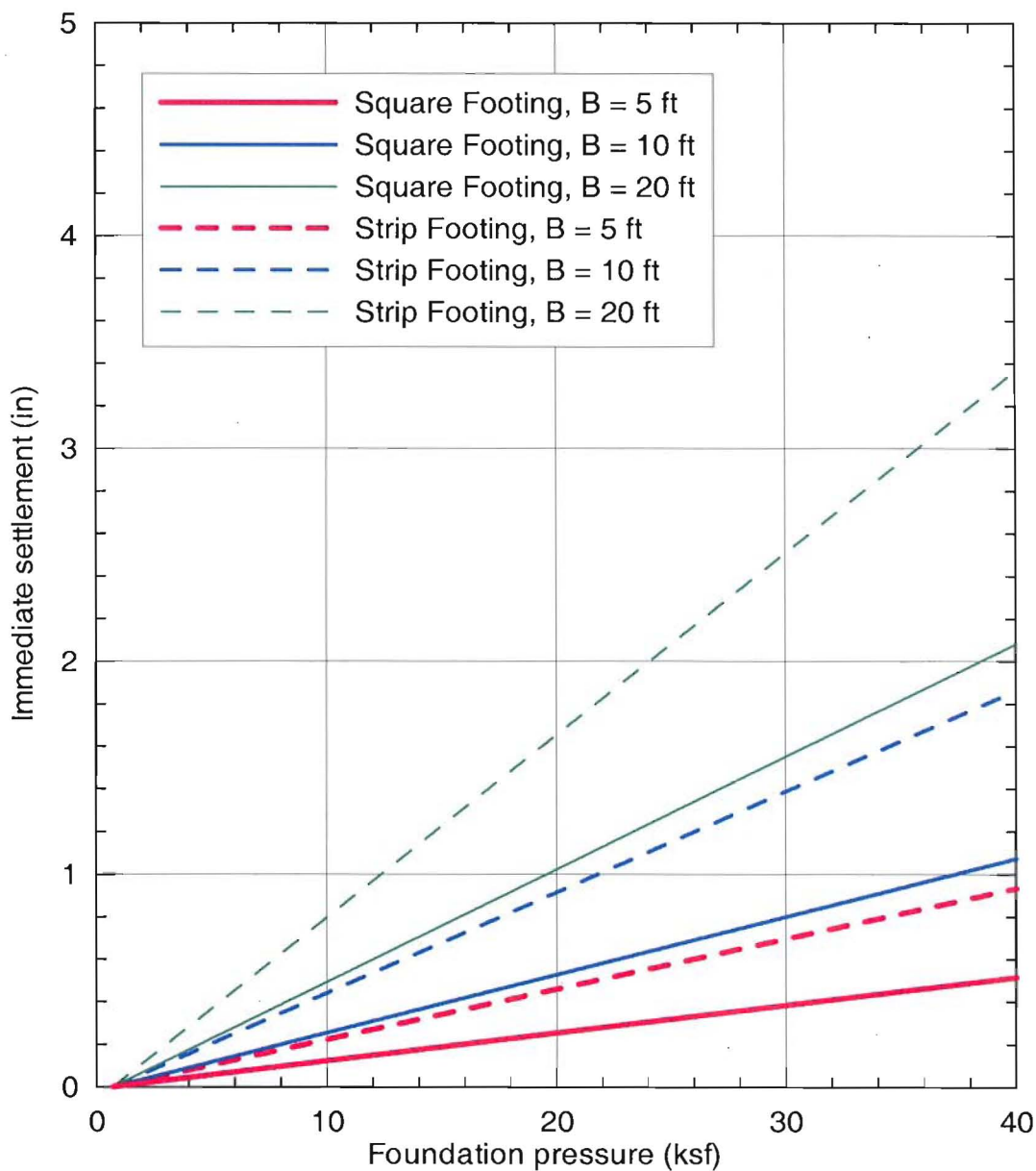




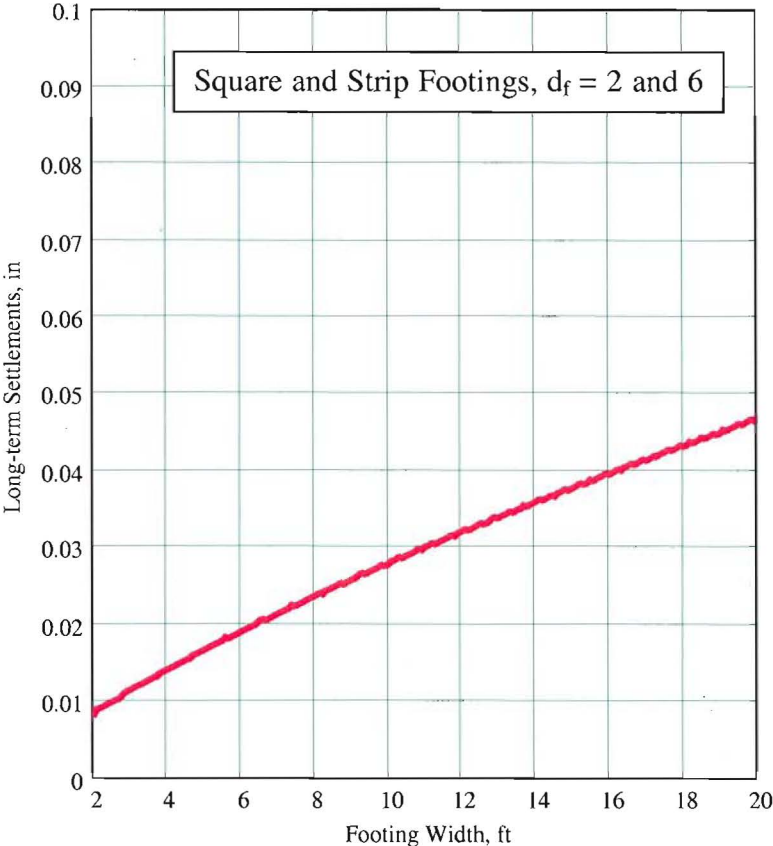
**Figure 7-3. Allowable foundation pressure for square and strip footings on alluvium vs. foundation width and foundation embedment (1/2-inch design settlement).**



**Figure 7-4. Immediate settlements for different widths of square and strip footings on alluvium vs. foundation pressure ( $d_f = 2$  ft)**

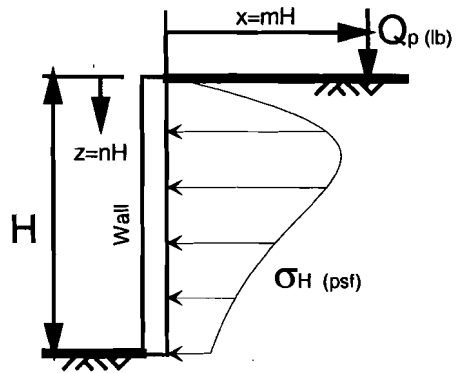


**Figure 7-5. Immediate settlements for different widths of square and strip footings on alluvium vs. foundation pressure ( $d_f = 6$  ft).**



**Figure 7-6. Long-term settlements for square and strip footings and different depths of foundation embedment.**

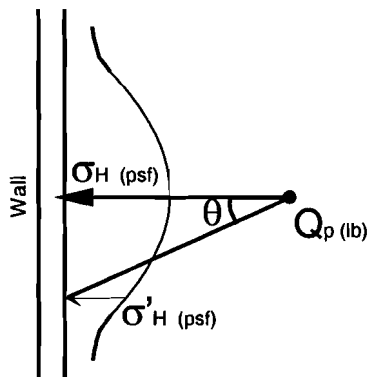




$$\sigma_H = 0.28 \frac{Q_p}{H^2} \frac{n^2}{(0.16+n^2)^3} \quad (\text{for } m \leq 0.4)$$

$$\sigma_H = 1.77 \frac{Q_p}{H^2} \frac{m^2 n^2}{(m^2+n^2)^3} \quad (\text{for } m > 0.4)$$

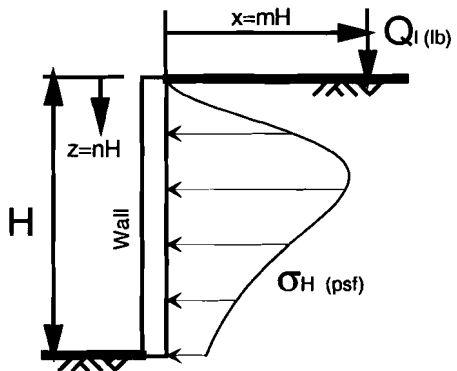
Elevation View



$$\sigma'_H = \sigma_H \cos^2(\theta)$$

Plan View

**Lateral Pressure due to Point Load**



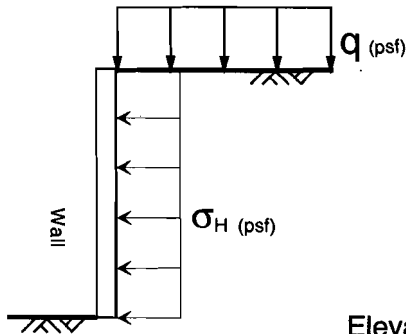
$$\sigma_H = 0.20 \frac{Q_i}{H} \frac{n}{(0.16+n^2)^2} \quad (\text{for } m \leq 0.4)$$

$$\sigma_H = 1.28 \frac{Q_i}{H} \frac{m^2 n}{(m^2+n^2)^2} \quad (\text{for } m > 0.4)$$

Elevation View

**Lateral Pressure due to Line Load**

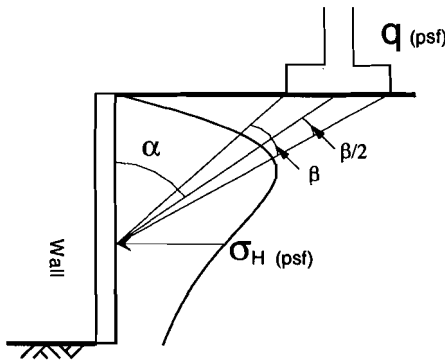
**Figure 7-8. Surcharge loading for yielding walls (not drawn to scale, USN 1986)**



$$\sigma_H = q K \text{ (psf)}$$

Elevation View

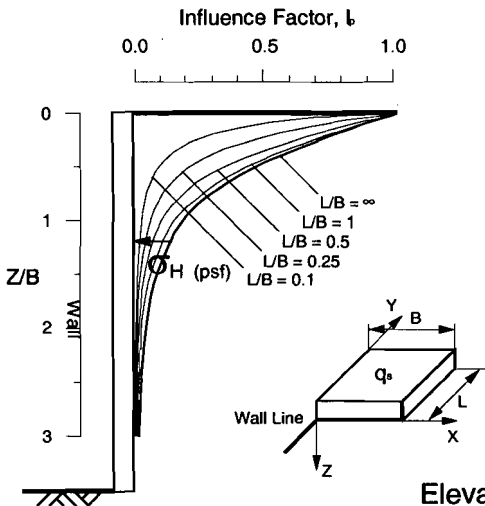
**Lateral Pressure due to Uniform Surcharge**



$$\sigma_H = \frac{2q}{\pi} [\beta - \sin\beta\cos2\alpha]$$

Elevation View

**Lateral Pressure due to Strip Load**



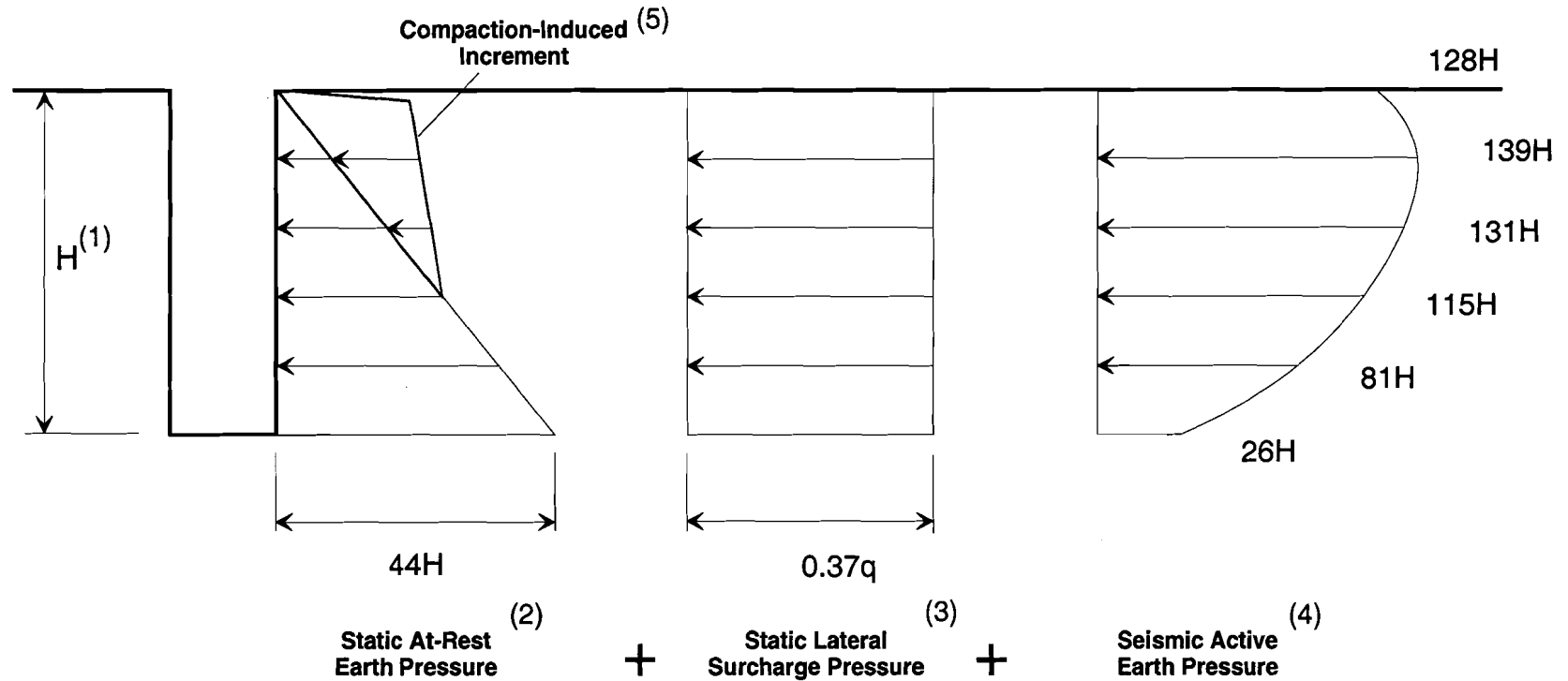
$$\sigma_H = I_p \times q_s$$

Elevation View

**Lateral Pressure due to Footing**

**Figure 7-9. Surcharge loading for yielding walls, continued (not drawn to scale, USN 1986)**





**Notes:**

- (1) Height of wall, H, is presented in feet.
- (2) Static at-rest earth pressures for alluvium:  $K_o = 0.37$ ,  $\gamma = 117$  pcf.
- (3) Static lateral surcharge pressure based on  $K_o q$ , where q is surcharge to be determined.
- (4) Seismic active earth pressure based on methods from ASCE 4-98 (2000), where  $k_h = 1g$  (to be scaled by actual peak ground acceleration, PGA);  
Does not include dynamic contribution due to surcharge load
- (5) Compaction-induced pressure increments for specific compaction equipment provided in the next following figures.
- (6) Pressures are presented in psf.

**Figure 7-10. Lateral earth pressures for non-yielding walls.**

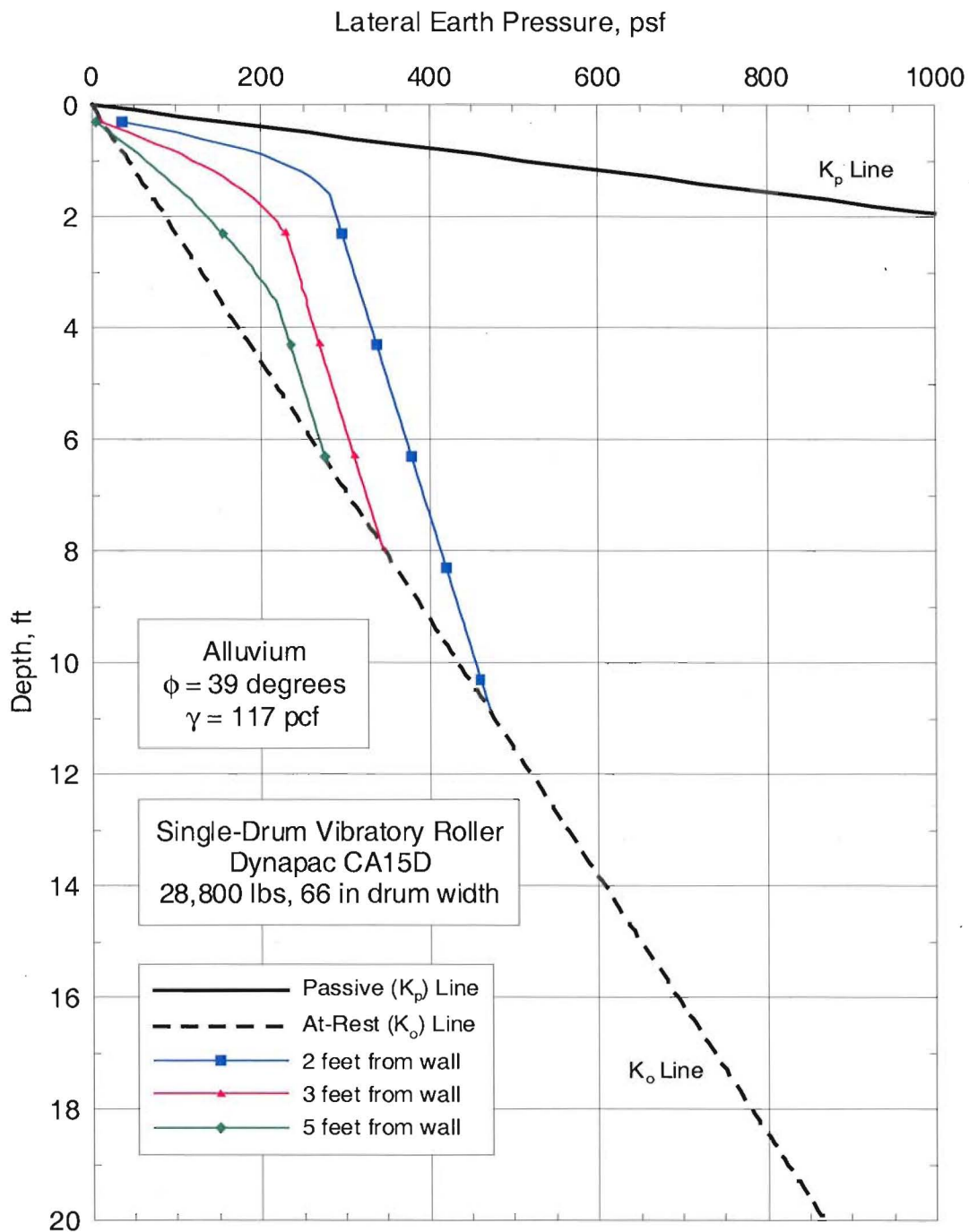
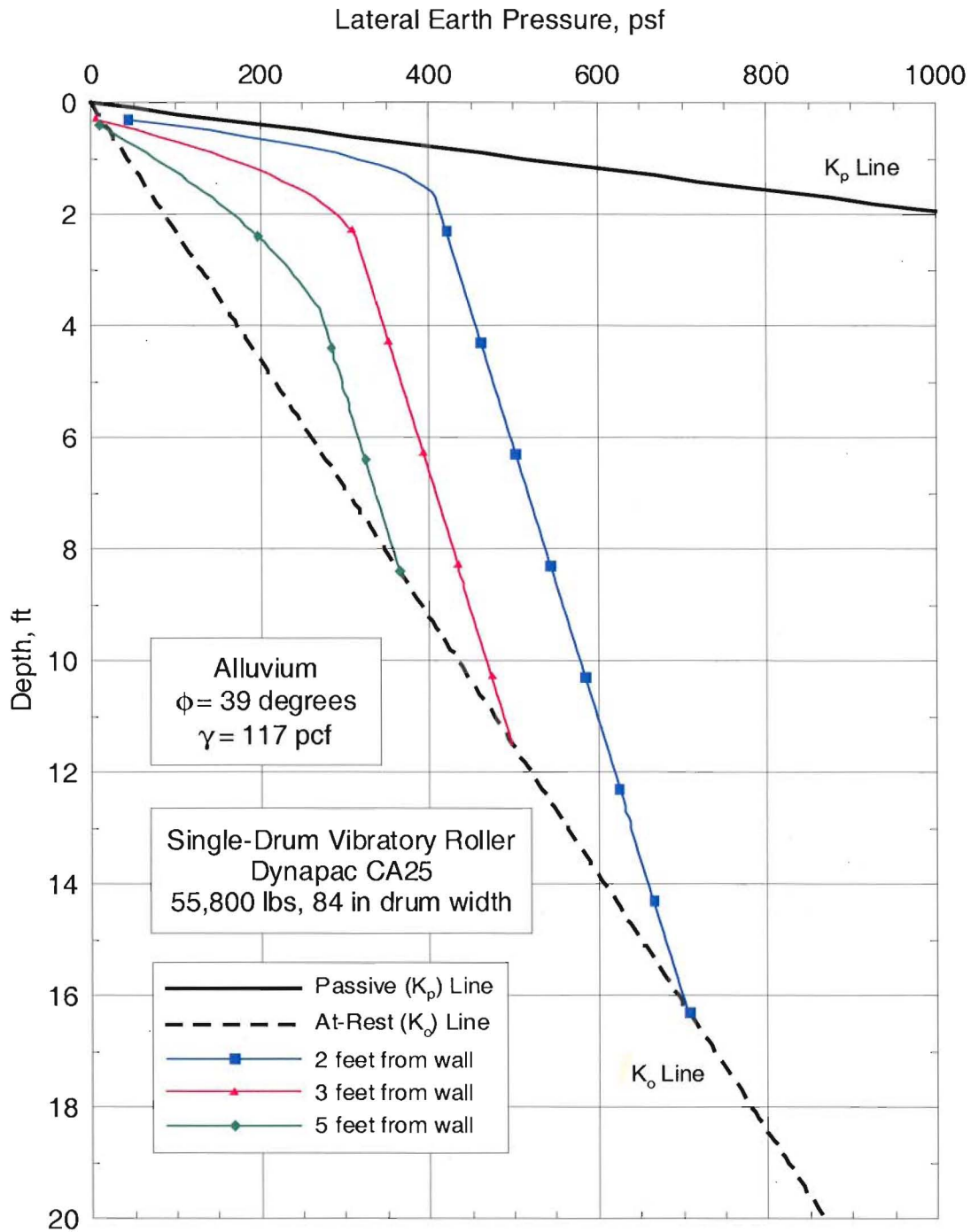
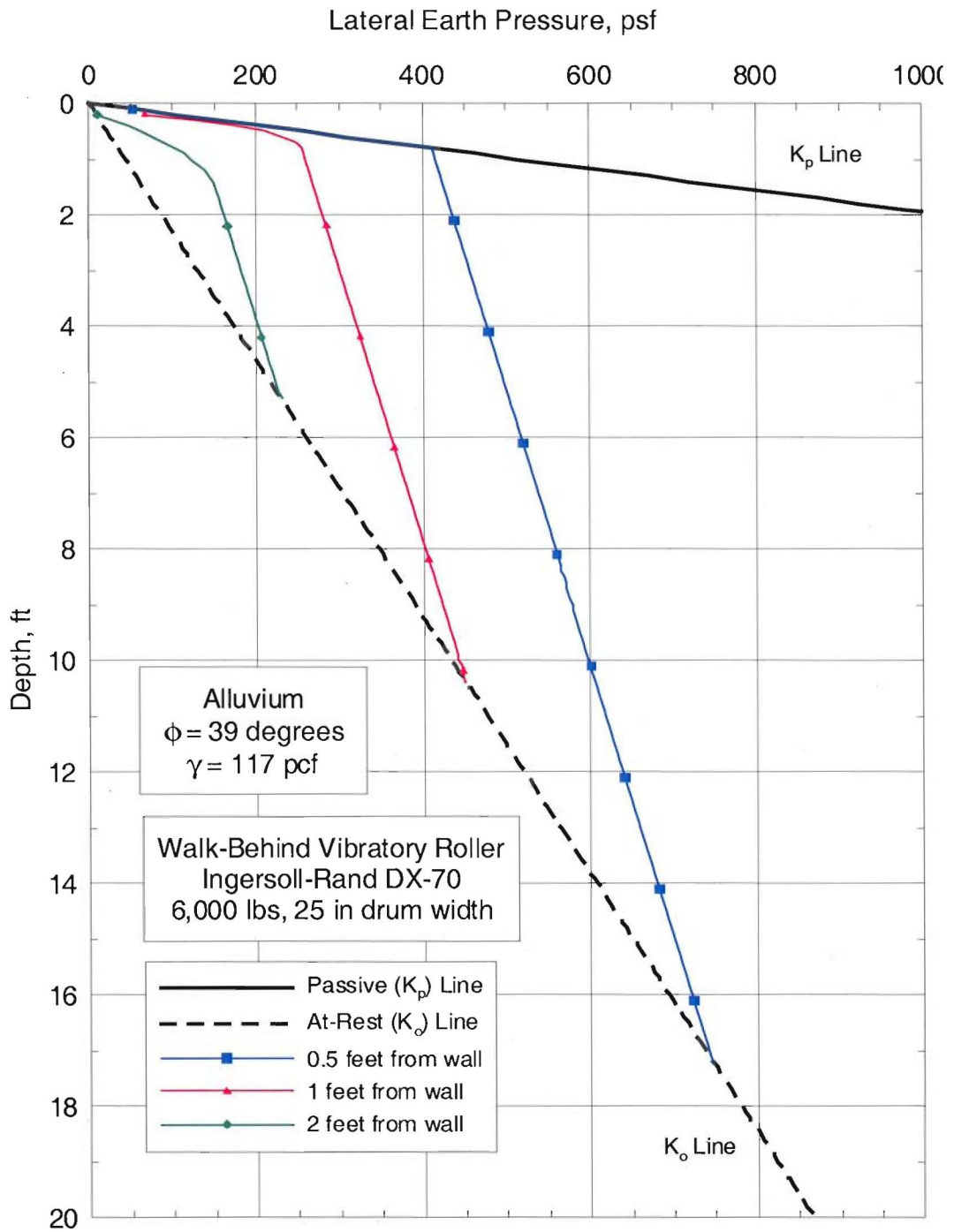


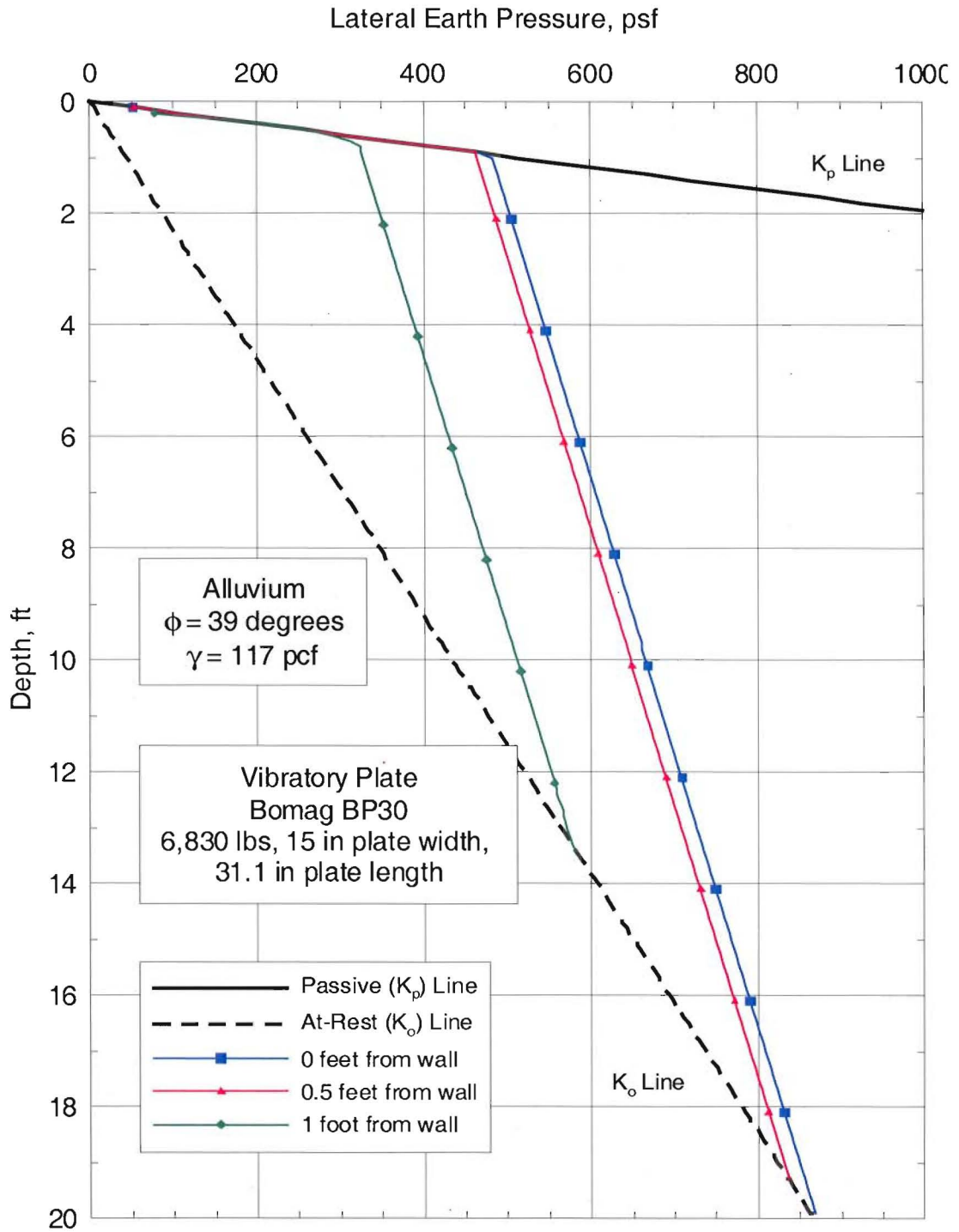
Figure 7-11. Compactor-induced pressures from roller compactor (Compactor model: Dynapac CA15D)



**Figure 7-11. Compactor-induced pressures from roller compactor (Compactor model: Dynapac CA25)**



**Figure 7-12. Compactor-induced pressures from roller compactor (Ingersoll-Rand DX-70).**



**Figure 7-13. Compactor-induced pressures from plate compactor (Bomag BP30).**

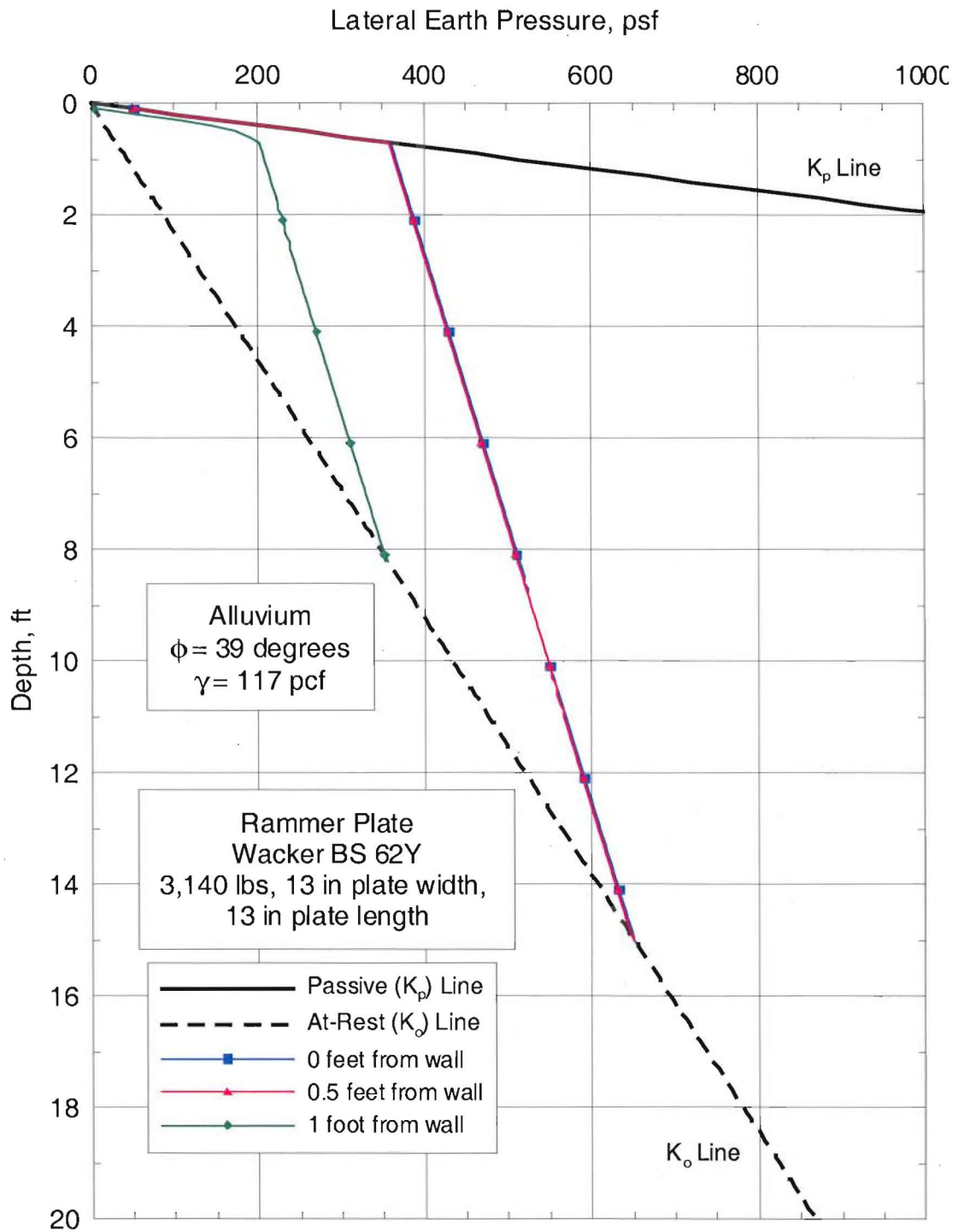
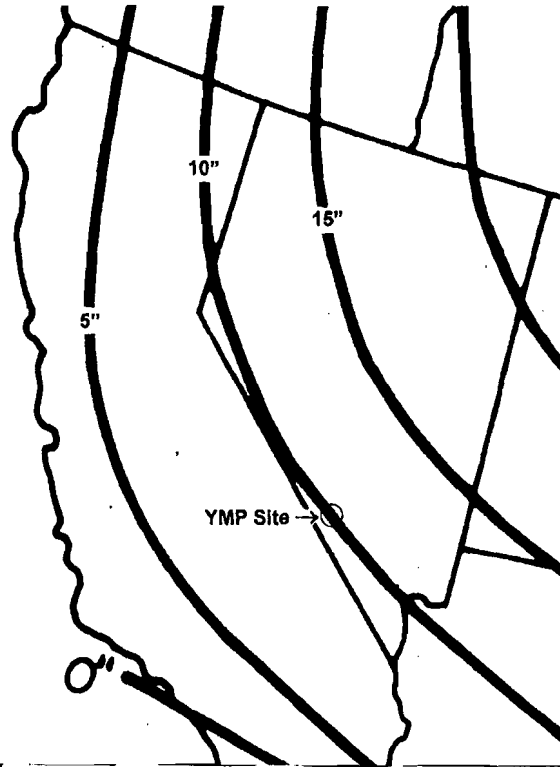


Figure 7-15. Compactor-induced pressures from plate compactor (Wacker BS 62Y).



**Figure 7-16. Extreme frost penetration (inches) at the North Portal Area (Figure III-1 BSC 2002b).**

## **7.2 CONSTRUCTION CONSIDERATIONS**

### **7.2.1 Stripping and Site Preparation**

Portions of the site are currently covered with 5 to 22.4 feet of uncontrolled sand and gravel fill. All fill in the building areas should be removed down to the top of native alluvium. Any preexisting organic materials and roots, if any, encountered at the top of the native alluvium should be stripped at each of the structure sites. It is expected that no more than 6 inches of stripping of the original native surface would be needed to remove the organic materials and roots. In areas with preexisting heavy sagebrush growth, additional stripping may be required to remove the deep roots.

The excavated areas should extend outside the footing line for a distance equal to at least 1/2 the depth of the excavation up to a maximum of 5 feet outside the footing line.

The top 12 inches of the exposed subgrade surface should then be compacted to an in-place density of at least 95 percent of the maximum laboratory dry density as determined by ASTM D 1557.

The structural fill may consist of the excavated soil, or imported fill. Imported structural fill should consist of 5/8-inch minus crushed base course or 2-inch minus pit run gravel with less than 5 percent fines (minus U.S. No. 200 sieve size). All structural fill beneath or around structures should be compacted to an in-place density of at least 95 percent of the maximum laboratory dry density as determined by ASTM D 1557.

### **7.2.2 Foundations**

All foundation should be buried a minimum of 2 feet below the ground surface. This depth exceeds the design depth of freeze of 10 inches (see Section 7.1.11), with some allowance for loss of ground around footings.

### **7.2.3 Excavation, Backfill and Temporary Shoring**

We recommend that all excavations be made as open excavations, with side slopes no steeper than 1.5 Horizontal to 1 Vertical (1.5H: 1V). However, recognizing that some elements of certain structures may be as deep as 50 feet or more below the existing surface elevation, a combination of open cut and shoring may be necessary for those particular features. Temporary shoring to support these excavations may be designed based on the soil properties indicated in Table 2-1.

Consistent with conventional practice, actual temporary excavation slopes should be made the responsibility of the construction contractor. The construction contractor is able to observe the nature and conditions of the subsurface encountered and has the responsibility for methods, sequence, and schedule of construction. If instability is detected, slopes should be flattened or shored. All temporary excavation slopes should be accomplished in accordance with all local, state, and federal safety regulations. Excavation slopes and shoring may be designed using the



soil properties shown in Table 2-1. Shoring systems, if used, should be monitored for vertical and lateral movement during construction to confirm that movements are contained within allowable limits.

The granular soils observed in the explorations can be excavated using conventional equipment such as scrapers or rubber-tired or tracked hydraulic backhoes. Excavation in most of the site soils is not expected to require any unusual equipment or procedures. Any cobbles observed in the excavations should be removed from any excavated soils that will be used as backfill. No cemented layers were identified that would require special construction equipment or techniques.

#### **7.2.4 Excavations for Underground Utilities**

Backfill above and around underground utilities should be compacted to an in-place density of at least 95 percent of the maximum laboratory dry density as determined by ASTM D 1557. Moisture content of backfill materials should be within  $\pm 3$  percent of optimum.

As an alternative to conventional trench backfilling, encasement of the conduit in controlled density fill (CDF) may be used. CDF used for pipe bedding or backfill should have a 28-day compressive strength between 50 and 200 psi (ACI 230.1R-90).

Consistent with conventional practice, actual temporary excavation slopes for utility trenches should be made the responsibility of the construction contractor. The construction contractor is able to observe the nature and conditions of the subsurface materials encountered and has the responsibility for methods, sequence, and schedule of construction. If instability is detected, slopes should be flattened or shored. All temporary excavation slopes should be accomplished in accordance with local, state, and federal safety regulations.

#### **7.2.5 Temporary and Permanent Slopes**

Temporary cut slopes should be constructed with slopes no steeper than 1.5H: 1V. Fill slopes should be no steeper than 2H: 1V. This recommendation is in conformance with the Project Design Documents (see BSC 2005, Section 4.2.1.2.7).

Permanent cut and fill slopes should be provided with erosion protection by placement of at least 3 inches of coarse concrete aggregate.

#### **7.2.6 Compaction**

All foundation stabilization, structural fill, utility bedding, and foundation and trench backfill materials should be compacted to an in-place density of at least 95 percent of the maximum laboratory dry density as determined by ASTM D 1557. Moisture content should be controlled to be within  $\pm 3$  percent of optimum.

In general, the thickness of backfill layers before compaction should not exceed 12 inches for heavy compactors and 8 inches for hand-operated mechanical compactors.

## **7.2.7 Suitability of On-site Materials**

### **7.2.7.1 Structural Backfill**

Based on field descriptions and laboratory testing of the alluvial materials encountered in the test pits performed at the surface facilities and the Fran Ridge borrow area (Sections 6.2.4 and 6.2.9 of BSC 2002a), these materials are suitable for use as structural backfill provided that material larger than 3 inches are removed and that a suitably cost-effective means is used to test the materials for quality control purposes. Backfill placed around structures should be placed in lifts not to exceed 12 inches loose depth for heavy compactors and 8 inches for hand-operated mechanical compactors, and compacted to an in-place density of at least 95 percent of the maximum laboratory dry density as determined by ASTM D 1557.

### **7.2.8 Concrete Aggregates**

Based on gradation tests performed on the alluvial materials encountered in the test pits performed at the surface facilities and the Fran Ridge borrow area (Section 6.5.2 of BSC 2002a), materials encountered at the site are not suitable for use as concrete aggregates without processing. The unprocessed materials contain too many large size particles. Processing these deposits to produce acceptable concrete aggregate is expected to be cost-prohibitive. However, if ballast is also processed on site, the additional processing required for concrete aggregate may become more viable.

### **7.2.9 Volume Coefficients**

Based on density test results compiled in BSC (2002b), Section I.2.1, the mean moist unit weight of the in-situ alluvium is between 114 and 117 pcf. The maximum dry unit weight for tests on Fran Ridge borrow material (also composed of alluvial soils) as reported in BSC (2002a), Section 8.1.1, was 114.5 pcf with a moisture content of 11%. Adjustments for the large particle sizes and for a moisture content one percentage point higher than the optimum resulted in a maximum estimated moist unit weight of 128 pcf (Section I.1.1 of BSC 2002b).

Therefore, assuming that the Fran Ridge material physical characteristics are similar to the in-situ alluvium, the in-place relative compaction of the alluvium is estimated to be about  $114/128 = 89\%$  of its maximum value. Compaction of the excavated alluvium to 95% of its maximum dry density will result in a denser material that is smaller in volume. The difference involved with this process is therefore  $(114-128)/114 = -11\%$ , or 11% percent shrinkage. Due to local variability in gravel content additional testing during construction will be necessary to determine the actual shrink or swell factors for the particular blend of materials.

### **7.2.10 Surface and Storm Water Drainage**

Surface drainage should provide positive drainage of surface storm water away from the structures and pavement areas. We expect that storm water disposal may utilize conventional drywells installed within the alluvium. However, cementation in the alluvium may decrease the

effectiveness of this method and additional studies and analysis will be required to verify this if surface runoff is insufficient.

Infiltration testing is recommended for the alluvium. A factor of safety of at least 3.0 should be applied to the measured rate to accommodate plugging over time.

#### **7.2.11 Septic System Drain Field**

The septic system drain field should be designed in accordance the state and local requirements. The septic system should be designed using the average measured infiltration rate at 4 feet below the existing surface elevation in the alluvial materials. Current design standards allow septic systems to be designed based on actual infiltration rates without application of a factor of safety. Because of the expected heavy usage, provisions for reserve capacity should be included in the septic system drain field design.

#### **7.2.12 Wet Weather Construction**

Because of the granular nature of the soils at this site and the general environment of the site, wet weather construction should not be a major concern. Mitigation measures to reduce the potential impact of occasional storms would include providing positive drainage to direct storm water away from excavations and work zones. Effective maintenance of access roads and staging areas will also reduce the impact of an occasional storm.

#### **7.2.13 Dewatering**

Because of the depth of the groundwater, over 1000 feet below the ground surface elevation, dewatering is not a significant concern at this site.

### **7.3 ADDITIONAL INVESTIGATIONS/TESTING**

The following is a list of items that will be required to finalize design for the YMP waste handing facilities at the North Portal area.

#### **7.3.1 Test Pits and Geologic Reconnaissance**

It is recommended that an additional 5 to 6 shallow test pits be performed on Exile Hill to better characterize the slope for stability issues. This will include geologic reconnaissance and mapping of the slope area.

#### **7.3.2 Borings**

Although there are numerous borings and test pits in the site vicinity, there are very few within the borders of the planned buildings. It is estimated that another 29 borings [each ~100 feet deep] will be required to provide sufficient coverage of the planned facilities. The borings should be performed using mud rotary, hollow-stem auger, or air-drill techniques. Sampling

would generally involve 3-inch diameter heavy-duty samplers along with 2-inch diameter SPT. Any encountered soft zones would be sampled with 3-inch diameter thin-walled Shelby tubes. Borings should extend about 15 feet into rock. Therefore, coring capability will also be needed. CPT is not an option due the amount of gravel present. The borings would be used to better define local stratigraphy for both static and dynamic analyses, and the depth of fill to be removed.

### **7.3.3 Laboratory Testing**

Laboratory testing associated with the borings would consist of gradation, Atterberg limits, direct shear, moisture and density, relative density tests, and possibly large diameter triaxial testing.

### **7.3.4 CBR Testing**

California bearing ratio tests are needed on the alluvium and anticipated fill sources for pavement design.

### **7.3.5 Field Plate Load Tests**

Plate load tests should be conducted on undisturbed soils in the test pits to define the elastic parameters of the alluvium and the fill source.

### **7.3.6 Resistivity Testing**

Field electrical resistivity tests should be performed on the alluvium and fill source materials.

### **7.3.7 Aggregate Testing**

Qualification of on-site or local aggregate will require testing for use as backfill and under pavements. Required tests include specific gravity, absorption, degradation, and soundness.

### **7.3.8 Ballast Testing**

Additional aggregate testing suites, as described in Section 7.3.7, would be needed to evaluate tunnel muck cuttings for use as ballast when suitable samples become available.

### **7.3.9 Chemical Testing**

Laboratory pH, chloride, sulphate, and resistivity tests will be needed to evaluate corrosion potential for metal pipes from alluvium and fill.

### **7.3.10 Test Fill Program**

A test fill program should be performed to evaluate the in-situ engineering properties of engineered fill, including its shear-wave and damping properties, and to determine the effect of

construction equipment on the material. The test pad would also be used to establish relationships between the various density testing methods (i.e., nuclear, sand cone, and relative density).

### **7.3.11 Pavement Design**

Design of temporary construction roads and operational pavements (and any special purpose roads, such as for heavy transport vehicles) will need to be provided when the pertinent additional field and laboratory tests are completed.

APPENDIX A – SEISMIC WAVE VELOCITY

---

<b>Appendix A Contents</b>	<b>Page Number</b>
<b>A1 Objective .....</b>	<b>A-2</b>
<b>A2 Inputs .....</b>	<b>A-2</b>
<b>A3 Background .....</b>	<b>A-3</b>
<b>A4 Methodology .....</b>	<b>A-8</b>
<b>A5 Assumptions .....</b>	<b>A-8</b>
<b>A6 Calculations .....</b>	<b>A-9</b>
<b>A6.1 Alluvium (Qal) .....</b>	<b>A-9</b>
<b>A6.2 Existing Fill and Bedrock.....</b>	<b>A-15</b>
<b>A7 Results/Conclusions .....</b>	<b>A-20</b>
<b>A8 Attachments.....</b>	<b>A-21</b>
<b>A8.1 Seismic Wave Data (from BSC 2002a).....</b>	<b>A-21</b>
<b>A8.2 Soil Contact Depths (from BSC 2002a, based on DTN: GS030783114233.001) .....</b>	<b>A-39</b>
<b>A8.3 EXCEL Spreadsheets .....</b>	<b>A-39</b>

APPENDIX A – SEISMIC WAVE VELOCITY

## A1 Objective

The purpose of this analysis is to estimate representative shear-wave ( $V_s$ ) and compression-wave ( $V_p$ ) velocities for the soil and rock units present at the Yucca Mountain Project (YMP) site. The analysis is based on available seismic wave velocity data measured at the site and contained in BSC (2002a). Seismic wave velocities were obtained by the following seismic surveying methods: (1) downhole, (2) suspension P-S (OYO), and (3) spectral analysis of surface waves (SASW).

## A2 Inputs

Direct input data used in the analysis herein are selected per Table 2 (summary of input data) of BSC (2002a). The seismic velocity data contained in BSC (2002a) are provided in tabular form consisting of  $V_s$  and  $V_p$  profiles at various depth intervals for different survey methods. The raw data from the surveying methods were not available for this calculation. Table A2-1 below lists data sources that were considered in this analysis:

**Table A2-1. Tables and figures from previous reports providing seismic velocity data considered in the analysis (Data attached in Section A8.1).**

Surveying Method	Source	Date of Surveys	Borings / Line surveys	Table/Figure	Data Tracking Number	Data
Downhole	BSC (2002a)	Oct. to Dec. 2000	RF#13 (two surveys), RF#14 through #26, #28, and #29	Tables 8 and 9	MO0111DVDWHBSC.001 MO0202WHBTMPKS.000 MO0110DVIDBOREH.000 MO0202WAVEATD.000	$V_s$ & $V_p$ <sup>(1)</sup>
Suspension P-S (OYO)	BSC (2002a)	Sept. and Dec. 2000	RF#14 through #26, #28, and #29	Tables VII-2 and VII-3	MO0204SUSPSEIS.001	$V_s$ & $V_p$ <sup>(2)</sup>
SASW	BSC (2002a)	Summer 2000 and 2001	<sup>(3)</sup> Lines 1, 2, 4, 8, 10+37, 23, 29, 33, 32+35, and 34+36	Figures IX-1, IX-2, IX-4, IX-8, IX-10, IX-23, IX-29, IX-32, IX-33 and IX-34 (2 profiles)	MO0110SASWHBS.000	$V_s$ <sup>(1)</sup>

<sup>(1)</sup> Average velocities at various depth intervals

<sup>(2)</sup> Average velocities by soil unit

<sup>(3)</sup> Line surveys that were conducted at locations corresponding to nearby borings

All data presented in Table A2-1 is provided in Section A8.1 of this calculation. Boring logs and soil contact depths provided in BSC (2002a) for all the locations listed Table A2-1 were used to match the soil layers with corresponding  $V_s$  and  $V_p$  values at depth. The tables providing the soil contact depths are contained in Section A8.2 of this calculation. The predominant soil layers identified in each boring are:

## APPENDIX A – SEISMIC WAVE VELOCITY

---

- Existing Fill: Fill
- Alluvium: Qal
- Bedrock:
  - Tmbt1 – Pre-Rainier Mesa Tuff bedded tuff
  - Tpki – Tuff unit “x”
  - Tpbt5 – Pre-tuff unit “x” bedded tuffs (also known as post-Tiva Canyon Tuff bedded tuff)
  - Tpcrn – Tiva Canyon Tuff: crystal-rich member, nonlithophysal zone
  - Tpcpul – Tiva Canyon Tuff: crystal-poor member, upper lithophysal zone
  - Tpcpmn – Tiva Canyon Tuff: crystal-poor member, middle nonlithophysal zone
  - Tpcpll – Tiva Canyon Tuff: crystal-poor member, lower lithophysal zone
  - Tpcpln – Tiva Canyon Tuff: crystal-poor member, lower nonlithophysal zone

### A3 Background

Recent surveying investigations at the YMP site included measurements of  $V_s$  and  $V_p$  using three survey methods:

#### Downhole

Downhole surveys were performed at 16 boreholes (RF#13 through #26, #28, and #29). RF#13 was surveyed twice by downhole methods in 2000. Tables 8 and 9 of BSC (2002a) provide  $V_s$  and  $V_p$  data in terms of average seismic velocities at various depth intervals for each boring.

The locations of the borings where the downhole surveys were performed are shown in Figure A3-1.

#### Suspension log

Suspension log surveys were also performed at 16 boreholes (RF#13 through #26, #28, and #29). The receiver-to-receiver (RR) and source-to-receiver (SR) methods were both used in the suspension logging (except that only receiver-to-receiver was used for RF#13) to measure the shear-wave velocities. Tables VII-1, VII-2 and VII-3 from BSC (2002a) provide data in terms of seismic velocities averaged at each soil unit (determined from the geologic boring logs) for each boring. Per recommendations from BSC2002a, since more of the receiver-to-receiver seismic velocity data was missing, data from the SR method was used for evaluation of the suspension logging results.

The locations of the borings where the downhole surveys were performed are shown in Figure A3-1.

#### SASW

40 SASW surveys were performed at the site, of which 35 shear-wave velocity profiles were developed. The seismic velocities measured from the SASW surveys were determined from dispersion curves (surface wave velocity versus wavelength). Section 10.2.1.1 of BSC (2002a) presents 11 of these profiles corresponding to nearby boring locations (see Table A2-1). To simplify the analysis herein, only these profiles were used. Table A3-1 shows the profiles and their corresponding boring numbers.

The locations of the borings where the downhole surveys were performed are shown in Figure A3-2.



APPENDIX A – SEISMIC WAVE VELOCITY



Figure A3-1. Locations of borings where downhole and suspension seismic surveys were conducted (Figure 2 of BSC 2002a, DTN:GS020383114233.001).

APPENDIX A – SEISMIC WAVE VELOCITY

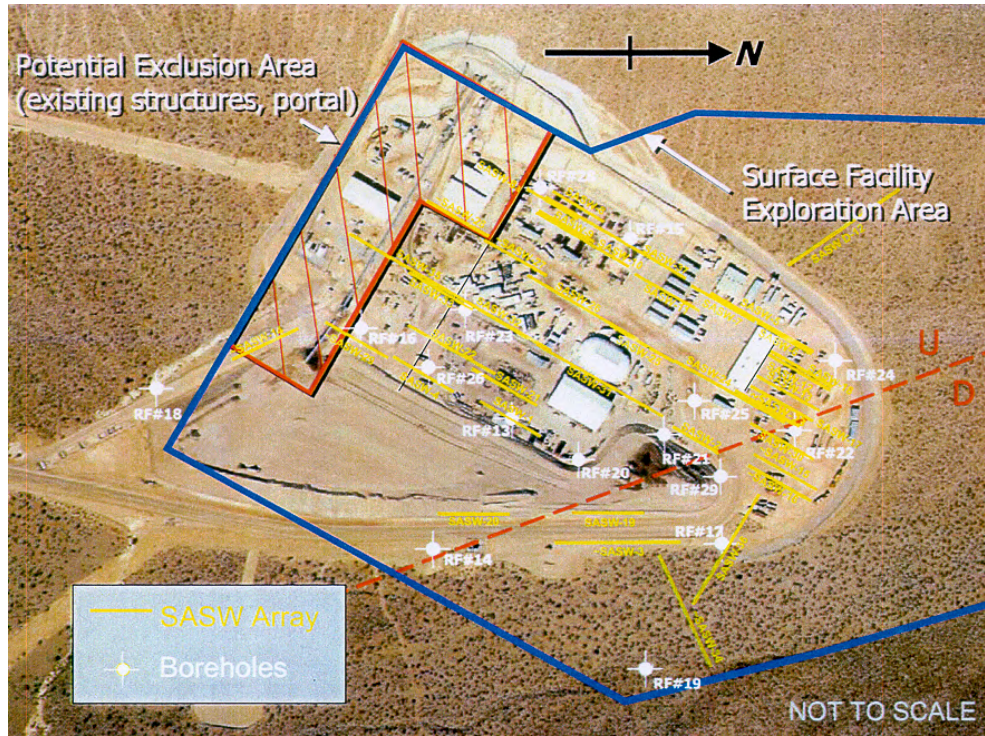


Figure A3-2. Locations of SASW seismic survey lines (Figure 43 of BSC 2002a).

Table A3-1. SASW Line Locations and Corresponding Borings.

SASW Line	Corresponding Boring (RF#)
1	13
2	21
4	26
8	28
10+37	15
23	22
29	16
33	23
32+35	23
34+36 (2 profiles)	17

Surveying information for each of the three methods are provided in BSC (2002a). Attachment VII of BSC2002a presents comparison figures showing seismic velocity versus depth profiles from the different survey methods.

Figure A3-3 and Figure A3-4 below show statistical values of  $V_s$  and  $V_p$  by lithostratigraphic unit measured from suspension surveys, respectively (the figures were taken from Figures 33 and 35 of BSC 2002a). Note that although Figure 33 states that the values are from source-to-receiver suspension surveys, it appears that the data is

APPENDIX A – SEISMIC WAVE VELOCITY

from receiver-to-receiver surveys (According to Table VII-2 of BSC 2002a, which shows statistics for suspension seismic source-to-receiver shear-wave velocities by lithostratigraphic unit, no measurements for Qal were made for RF#13, yet the figure below shows an average for that borehole for Qal. Table VII-1, on the other hand, which shows statistics for suspension seismic receiver-to-receiver shear-wave velocities by lithostratigraphic unit, does have a measurement for Qal for RF#13).

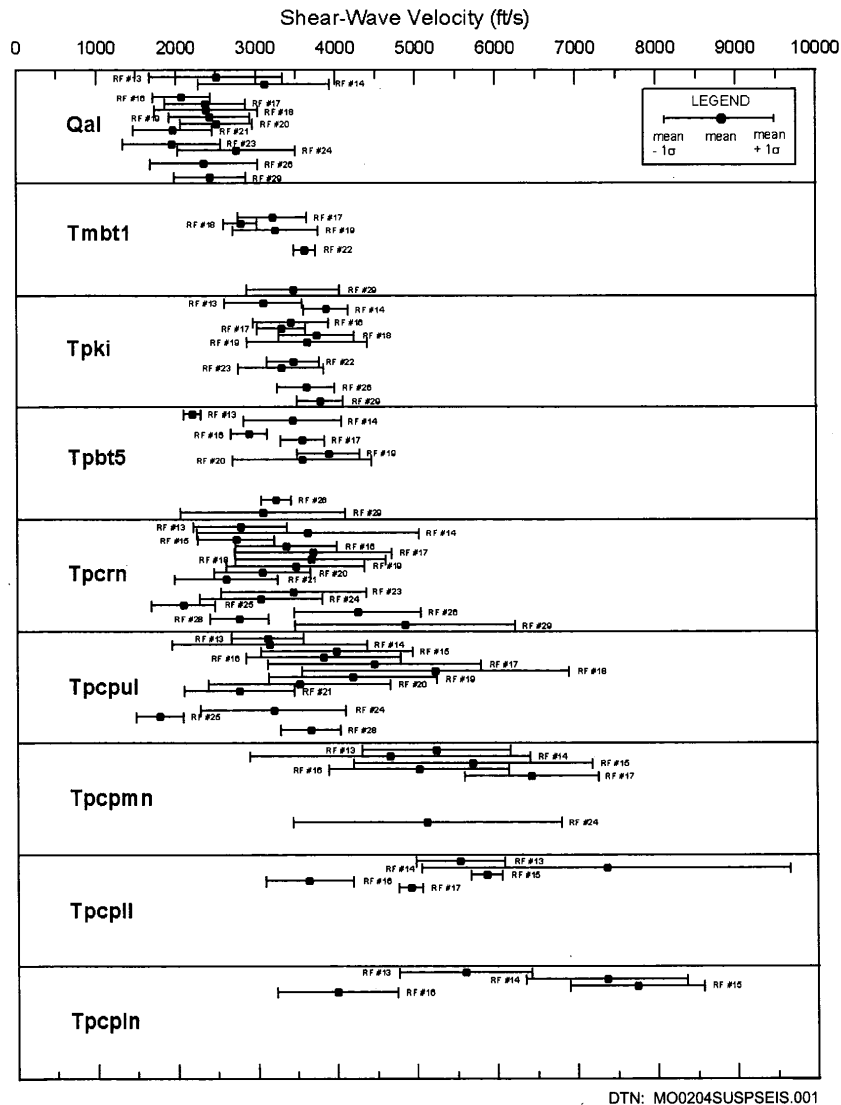


Figure A3-3. Statistical Values of Shear-Wave Velocity by Lithostratigraphic Unit from Source-to-Receiver Interval Suspension Surveys in Surface Facilities Area (Figure 33 of BSC 2002a, appears to represent values from receiver-to-receiver surveys).

APPENDIX A – SEISMIC WAVE VELOCITY

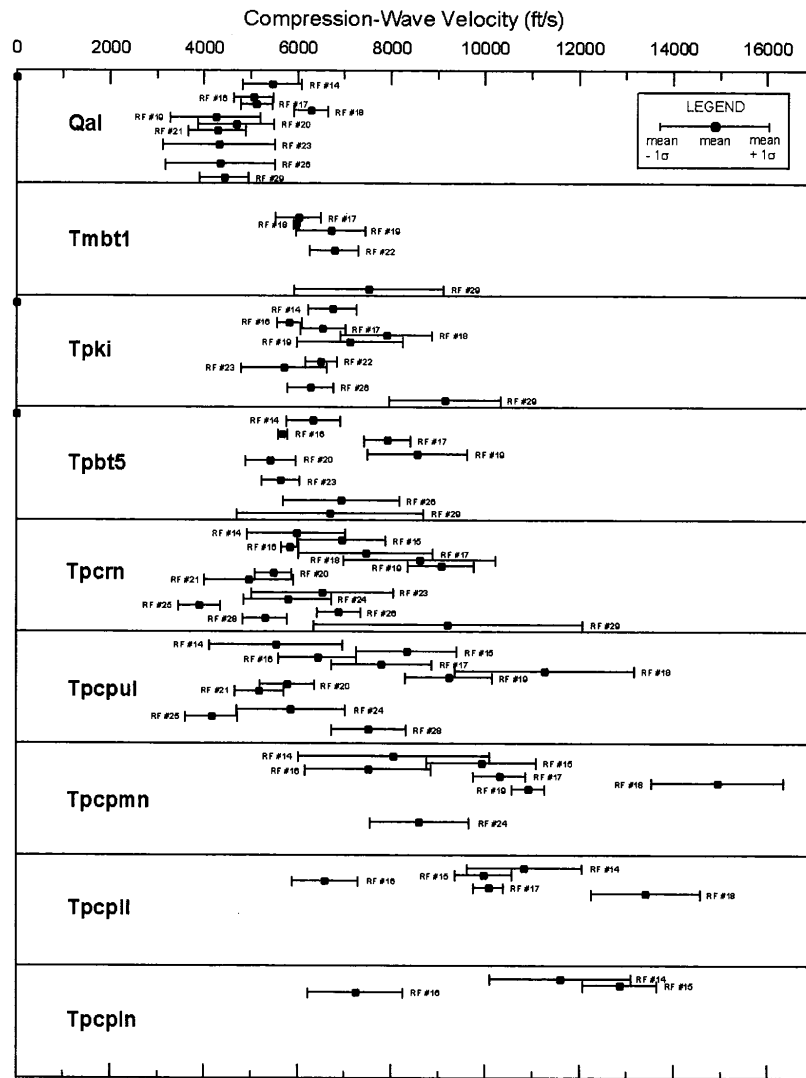


Figure A3-4. Statistical Values of Compression-Wave Velocity by Lithostratigraphic Unit from Source-to-Receiver Interval Suspension Surveys in Surface Facilities Area (Figure 35 of BSC 2002a).

## APPENDIX A – SEISMIC WAVE VELOCITY

---

A downhole survey was performed at RF#13 in 1998. Previous surveys were also performed at the site in the mid 1980's. Downhole surveys were performed at borings designated as RF#3, 3B, #9 and #10. Laboratory sonic velocities were also measured at RF#9, #10, and #11. Because of the abundance of more current measurements, the data from these previous surveys are not considered in the analysis contained herein.

### A4 Methodology

The data provided was analyzed separately for the alluvium, existing fill, and rock layers. In general, the seismic velocity values were averaged for each soil unit in each surveyed boring and for each surveying method. Statistical analysis (standard deviation and coefficient of variation) was also performed. The following steps were performed:

1. Where applicable, the seismic wave velocity profiles for each boring were superimposed over the geologic soil units.
2. Velocity values for each soil/rock layer were averaged where applicable using the following equation:

$$V_{average} = \frac{\sum_{i=1}^n V_i d_i}{\sum_{i=1}^n d_i}, \text{ where} \quad (A1)$$

$d_i$  = thickness of layer  $i$  in ft

$V_i$  = seismic velocity in layer  $i$

\* To estimate the average seismic wave velocity of alluvium, the layer was subdivided into four intervals: (1) 5-15 ft, (2) 15-30 ft, (3) 30-60 ft, and (4) 60-100 ft. Averages were determined for the existing fill and each bedrock unit. For the alluvium, an average was taken only if the sublayer thickness was at least half the amount of the depth interval.

In order to average the data, equal weight was given to each survey conducted.

### A5 Assumptions

It is assumed that all data provided in the tables and figures referenced in Table A2-1 have been qualified for use in design analysis. It is assumed that all surveys performed in the surface facilities area are contained in BSC (2002a).

All of these assumptions are either sufficiently conservative or represent typical standards used in the industry and do not require further verification.



**APPENDIX A – SEISMIC WAVE VELOCITY**

---

## **A6 Calculations**

The following sections describes the calculation approach to average the seismic wave velocities for the alluvium, existing fill, and bedrock, as outlined in Section A4. The methodology used to average the soil/rock units are essentially identical, with the exception that the alluvium is subdivided into 4 layers.

### **A6.1 Alluvium (Qal)**

The seismic wave velocity data for the alluvium listed in Table A2-1 was used to develop a plot of seismic velocities versus depth for the 3 survey methods. The mid-depth of the measured values was used for the downhole and SASW surveys. Note that for this calculation, only SASW surveys that were conducted near borings were used (as shown in BSC 2002a). The data provided from the suspension logging surveys was an average of the entire alluvium (Qal) layer encountered for each boring (Tables VII-2 and VII-3 of BSC 2002a). The values were thus plotted against the mid-depth of the Qal layer for each boring. Figure A6-1 and Figure A6-2 show the profiles for both  $V_s$  and  $V_p$  values, respectively. Note that compression wave velocities are not measured by SASW surveys.

Following the methodology outlined in Section A4, EXCEL spreadsheets were used to conduct the analysis for each boring and are provided in Section A8.3 of this calculation. Table A6-1 shows the results from the analysis for shear wave velocity from downhole and SASW surveys. Table A6-2 presents both sets of averages from the downhole and SASW surveys. Figure A6-1 shows the results graphically.

APPENDIX A – SEISMIC WAVE VELOCITY

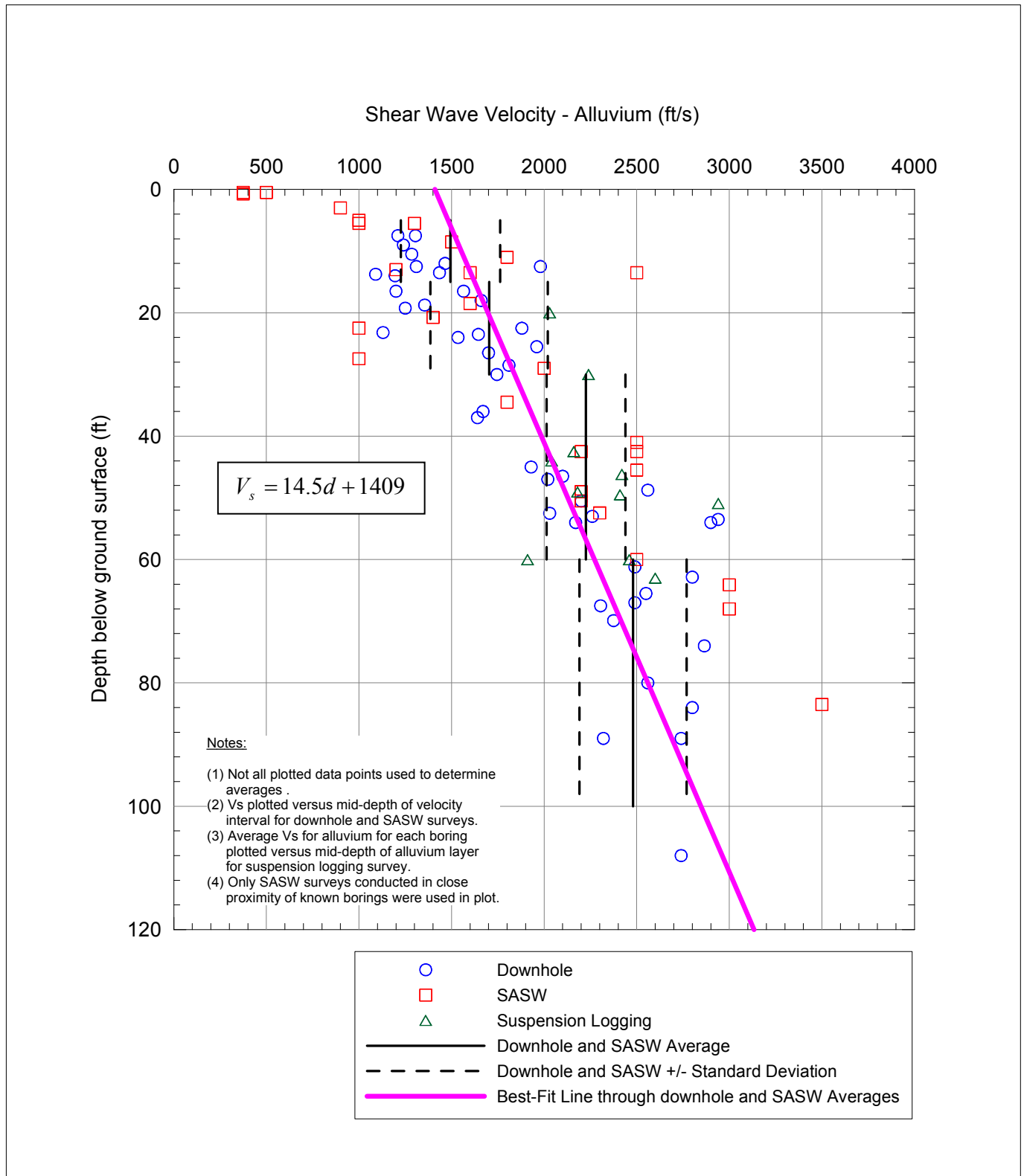


Figure A6-1. Shear Wave Velocity Data for Alluvium at YMP Site.

APPENDIX A – SEISMIC WAVE VELOCITY

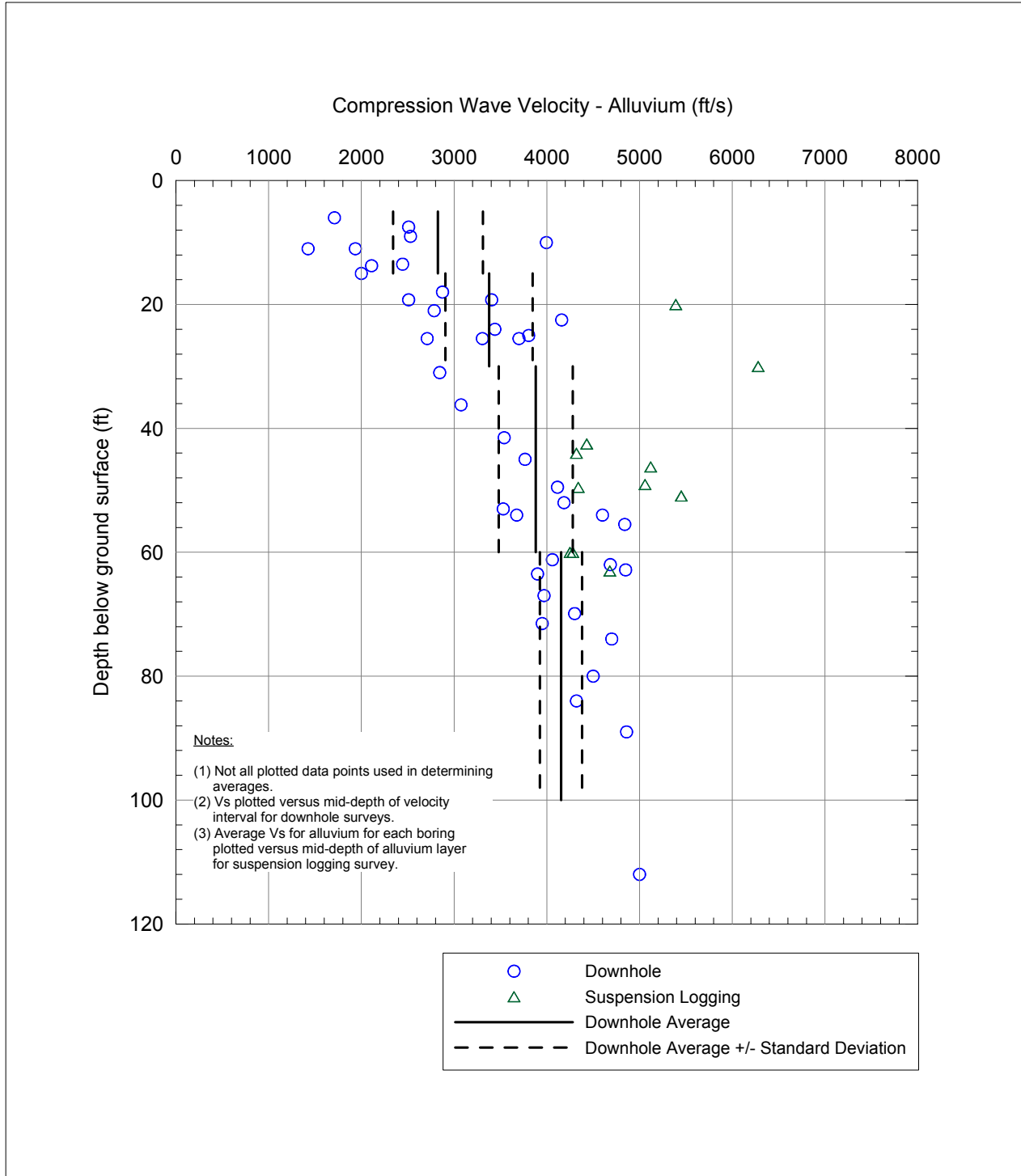


Figure A6-2. Compression Wave Velocity Data for Alluvium at YMP Site.



APPENDIX A – SEISMIC WAVE VELOCITY

Table A6-1. Computed alluvium shear wave velocity averages.

SHEAR WAVE VELOCITY, Vs (FT/S)								
Boring	Downhole				SASW			
	Interval / Depth (ft)							
	1	2	3	4	1	2	3	4
	5' - 15'	15' - 30'	30' - 60'	60' - 100'	5' - 15'	15' - 30'	30' - 60'	60' - 100'
13 (survey 1)		1580	2030	2366		1453	2200	3192
13 (survey 2)		1960	2384	2490				
14	1240	1700	2195	2375				
16		1533	2027			1000	2500	
17 (Profile 1)	1210	1880	2490	2490	1565	2300	2300	2300
17 (Profile 2)					1480	1800	1800	
18	1435	1529	2162					
19	1285	1705	2157	2349				
20	1200	1528	2020	2595				
21	1310	1723	1930		1570	2140	2500	
22	1465	1906	2200	2200	2200	2200	2200	2200
23		1886	2100			2000	2267	
24	1195	1467						
25	1645	1645	2638					
26		1745	2121	2550		1000	2600	3000
28	1643				1800			
29	1660	1660	2119	2326				
# borings	11	15	14	9	5	8	8	4
Avg. Vs (ft/s)	1390	1696	2184	2416	1723	1737	2296	2673
St.Dev.,σ (ft/s)	189	156	195	125	292	526	251	496
Coeff of var., σ/Avg. Vs	0.14	0.09	0.09	0.05	0.17	0.30	0.11	0.19

Table A6-2. Computed alluvium shear wave velocity averages of downhole and SASW surveys combined.

Interval	1	2	3	4
Depth (ft)	5 - 15	15 - 30	30 - 60	60 - 100
# of measurements	16	23	22	13
Average Vs, (ft/s)	1494	1710	2224	2495
St.Dev.,σ (ft/s)	268	322	218	295
Coeff of variation, σ/avg	0.18	0.19	0.10	0.12

A linear fit is plotted on Figure A6-1 through the 4 average velocity values reported in Table A6-2. The fitted equation was determined to be:

$$V_s = 14.5d + 1409 \tag{A2}$$

$V_s$  = shear wave velocity

**APPENDIX A – SEISMIC WAVE VELOCITY**

d = depth

Table A6-3 below presents the average results from the analysis for compression wave velocity from the downhole surveys for alluvium. Figure A6-2 shows the results graphically.

**Table A6-3. Computed alluvium compression wave velocity averages.**

<b>COMPRESSION WAVE VELOCITY, V<sub>p</sub> (FT/S)</b>				
Boring	Downhole			
	Interval / Depth (ft)			
	1	2	3	4
	5' - 15'	15' - 30'	30' - 60'	60' - 100'
13 (survey 1)		3746	4685	4685
13 (survey 2)		3700	3916	3970
14	2955	3805	4168	4300
16		3075	3667	
17 (Profile 1)	2510	4160	4060	4060
18	3305	3305	3823	
19	2748	3440	3797	3950
20	2470	3540	3540	4115
21	2845	2845	2951	
22	2445	3141	4185	4185
23		3412	3765	
24	2241	2785		
25	2710	2710	4059	
26		4115	4115	4115
28	3995			
29	2875	2875	3595	4005
# borings	11	15	14	9
Avg. V <sub>p</sub> (ft/s)	<b>2827</b>	<b>3377</b>	<b>3880</b>	<b>4154</b>
St.Dev., σ (ft/s)	485	470	399	227
Coeff of var., σ/Avg. V <sub>p</sub>	0.17	0.14	0.10	0.05

Table A6-4 below shows average values obtained by source-to-receiver suspension surveys provided in BSC (2002a). BSC (2002a) reports final averages of V<sub>s</sub> and V<sub>p</sub> for all the borings (weighted by the number of measurements). An attempt to verify the suspension data failed to produce the same result as presented in Tables VII-2 and VII-3 of BSC (2002a). It is not specifically documented in BSC (2002a) how the statistical data was determined. Since the averages provided by BSC (2002a) are for the entire alluvium layer in each boring, the data could not be subdivided into the four depth intervals as was performed for the downhole and SASW surveys. The raw data for the suspension logging for borings RF#14 through #26, #28, and #29 were not available for this calculation for processing.

APPENDIX A – SEISMIC WAVE VELOCITY

**Table A6-4. Seismic Wave Velocity Averages of Qal for Suspension Logging Surveys  
 (as reported in BSC 2002a).**

Boring	Source-to-receiver	
	V <sub>s</sub> (ft/s)	V <sub>p</sub> (ft/s)
13	-	-
14	2940 ± 240	5450 ± 630
16	2180 ± 150	5060 ± 430
17	2420 ± 380	5120 ± 340
18	2240 ± 320	6280 ± 370
19	2460 ± 340	4250 ± 960
20	2600 ± 390	4680 ± 810
21	1910 ± 300	4280 ± 610
23	2040 ± 650	4320 ± 1200
24	2030	5390
26	2410 ± 620	4340 ± 1170
29	2160 ± 350	4430 ± 520
<b>All</b>	<b>2040 ± 880</b>	<b>4660 ± 950</b>

It can be seen from the above tables and figures that the shear and compression wave velocity of the alluvium generally increases with depth. The shear wave velocity results from the downhole, SASW, and suspension logging surveys show relatively good agreement with each other. However, compression wave velocity results are higher from the suspension logging than the downhole surveys. Since the averages provided for the suspension logging are for the entire alluvium layer in each boring, it cannot be determined how the seismic velocity varies with depth by this method.

Since the provided averages from the suspension logging could not be checked, only the averages of V<sub>p</sub> from the downhole surveys are used. The average seismic velocity range for the alluvium obtained from available data is estimated below (from downhole and SASW surveys):

Depth (ft)	Shear Wave Velocity <sup>1</sup> (ft/s)	Compression Wave <sup>2</sup> Velocity (ft/s)
5 – 15	1,500 ± 270	2,800 ± 490
15 – 30	1,700 ± 320	3,400 ± 470
30 – 60	2,200 ± 220	3,900 ± 400
60 – 100	2,500 ± 300	4,200 ± 230

<sup>1</sup> from downhole and SASW surveys

<sup>2</sup> from downhole surveys only

APPENDIX A – SEISMIC WAVE VELOCITY

---

Using the following equation, Poisson’s ratio for the alluvium can be estimated:

$$\nu = \frac{2V_s^2 - V_p^2}{2V_s^2 - 2V_p^2} \tag{A3}$$

Using average values of the seismic velocities, a Poisson’s ratio of 0.23 to 0.30 is estimated for the alluvium. If the  $V_p$  average of 4660 ft/s (Table A6-4) from the suspension logging surveys is used, the Poisson’s ratio range is 0.30 to 0.44. These ranges are in good agreement with the BSC (2002a) reported value of  $0.27 \pm 0.15$  (Table VII-4).

**A6.2 Existing Fill and Bedrock**

Though the existing fill will be removed and thus is not necessary to consider, it is included in the analysis for completeness. It is difficult to estimate representative values of the bedrock units at the YMP site due to their varying thickness and depth locations. The cross-section in Figure 225 of BSC (2002a) shows the amount of dipping of the bedrock layers that exists at the YMP site. BSC (2002a) provides figures visually comparing the seismic wave velocities of these bedrock units.

The methodology used to average the alluvium was generally adopted to average the shear and compression wave velocities of the existing fill and rock layers, though unlike the alluvium, these materials were not subdivided into smaller intervals. The following rock layers for the downhole, SASW, and suspension logging surveys were used to compute the seismic wave averages:

Tmbt1 –	Pre-Rainier Mesa Tuff bedded tuff
Tpki –	Tuff unit “x”
Tpbt5 –	Pre-tuff unit “x” bedded tuffs (also known as post-Tiva Canyon Tuff bedded tuff)
Tpcrn –	Tiva Canyon Tuff: crystal-rich member, nonlithophysal zone
Tpcpul –	Tiva Canyon Tuff: crystal-poor member, upper lithophysal zone
Tpcpmn –	Tiva Canyon Tuff: crystal-poor member, middle nonlithophysal zone
Tpcpll –	Tiva Canyon Tuff: crystal-poor member, lower lithophysal zone
Tpcpln –	Tiva Canyon Tuff: crystal-poor member, lower nonlithophysal zone

Computed averages were based solely on the extent of the measured seismic velocity profiles and the logged geologic borings provided in BSC (2002a), regardless of whether the surveyed profile extended through the entire rock layer or ended within the layer. Averages from the suspension logging surveys are provided in BSC (2002a) (shown in Section A8.1) for each rock unit and each boring were also used in this analysis. The averages obtained from the source-to-receiver method were used per BSC (2002a) recommendations.

The results of the shear wave velocity averages for each boring and the total averages for the data obtained from the downhole, SASW, and suspension logging surveys are shown in Table A6-5, Table A6-6 and Table A6-7, respectively. Table A6-8 shows the data from all the surveys (downhole, SASW, and suspension logging) averaged together. Table A6-9 and Table A6-10 show the results of the compression wave velocity averages from the downhole and suspension logging surveys for each boring, respectively. EXCEL spreadsheets were used to conduct the analysis for each boring and are provided in Section A8.3. Table A6-11 shows the data from the downhole and suspension logging surveys averaged together.

It is evident from the presented tables and above figures, that although it is unclear how the seismic velocity varies with depth within each bedrock unit, a notable increase in seismic velocity exists between the Tpcpul and Tpcpmn layers. Hence, using equation (A1), averages were determined for the rock layer from Tmbt1 to Tpcpul (upper rock) and from Tpcpmn to Tpcpln (lower rock). Thus for the following tables, averages were also computed for the “upper rock”, “lower rock”, and the entire rock layer (upper and lower rock combined).

APPENDIX A – SEISMIC WAVE VELOCITY

Table A6-5. Computed existing fill and bedrock shear wave velocity averages (downhole surveys).

Boring	SHEAR WAVE VELOCITY, Vs (FT/S)											
	Downhole											
	Material											
	Fill	Tmbt1	Tpki	Tpbt5	Tpcrn	Tpcpul	Tpcpmn	Tpcpll	Tpcpln	All Rock	Upper Rock <sup>a</sup>	Lower Rock <sup>b</sup>
13	909		2740	2740	2740	3110	5800	5800	5800	4080	2774	5800
13	1090		2805	2810	3113	6490	6490	6490	6490	4746	3262	6490
14			3091	2640	2640	4410	5000	5000	5000	3937	3484	5000
15	1935				2363	3126	4053	5900	5900	3776	2838	5209
16	836		2800	2800	2800	3143	5713	7000	7000	3745	2967	6349
17		3134	3160	3160	3890	4393	4520			3598	3537	4520
18		2900	3770		3525	4200	4200	4200		3901	3856	4200
19		2740	3780	3780	3780	4100	4250			3537	3530	4250
20	1200			2800	2800	2800				2800	2800	
21	1310				2500	2500				2431	2431	
22		3349	3393	3500	3500					3414	3414	
23	982		2865	2865	3416					3284	3284	
24	1195				2050	2070	2070			2063	2062	2070
25	1645				2344	2100				2258	2258	
26	698		3677	3780	3780					3710	3710	
28	1305				2724	3300				2904	2904	
29		3237	3800	3800	3800					3457	3457	
# borings	11	5	11	11	17	13	9	6	5	17	17	9
Avg. Vs (ft/s)	1191	3072	3262	3152	3045	3519	4677	5732	6038	3391	3092	4876
St.Dev.,σ (ft/s)	359	249	436	470	595	1203	1292	1010	755	702	519	1351
Coeff of var., σ/Avg. Vs	0.30	0.08	0.13	0.15	0.20	0.34	0.28	0.18	0.13	0.21	0.17	0.28

<sup>a</sup>Tmbt1 to Tpcpul

<sup>b</sup>Tpcpmn to Tpcpln

Table A6-6. Computed existing fill and bedrock shear wave velocity averages (SASW surveys).

Boring	SHEAR WAVE VELOCITY, Vs (FT/S)											
	SASW											
	Material											
	Fill	Tmbt1	Tpki	Tpbt5	Tpcrn	Tpcpul	Tpcpmn	Tpcpll	Tpcpln	All Rock	Upper Rock <sup>a</sup>	Lower Rock <sup>b</sup>
13	848		3500	3500	3500					3500	3500	
15	1300				2803	3473	5000	5000		3615	3220	5000
16	737			3000	3000					3000	3000	
17		2453	2700							2469	2469	
21	1160				2500					2500	2500	
22		2980								2980	2980	
23	1008		2500	2500	3360					3163	3163	
26	557		3000							3000	3000	
28	1040				2856	3200				2977	2977	
# borings	7	2	4	3	6	2	1	1	0	9	9	1
Avg. Vs (ft/s)	950	2717	2925	3000	3003	3336	5000	5000		3023	2979	5000
St.Dev.,σ (ft/s)	254	372	435	500	371	193	-	-		385	327	-
Coeff of var., σ/Avg. Vs	0.27	0.14	0.15	0.17	0.12	0.06	-	-		0.13	0.11	-

<sup>a</sup>Tmbt1 to Tpcpul

<sup>b</sup>Tpcpmn to Tpcpln

APPENDIX A – SEISMIC WAVE VELOCITY

Table A6-7. Bedrock shear wave velocity averages as reported in BSC2002a (suspension logging surveys).

Boring	SHEAR WAVE VELOCITY, Vs (FT/S)											
	Suspension Logging, source-to-receiver											
	Material											
	Fill	Tmbt1	Tpki	Tpbt5	Tpcrn	Tpcpul	Tpcpmn	Tpcpll	Tpcpln	All Rock	Upper Rock <sup>a</sup>	Lower Rock <sup>b</sup>
14			3790	3420	3350	3130	4380	6280	7240	4391	3399	6268
15					3360	4380	5410	6170	7160	5012	3995	6449
16			3340	2190	3350	3620	4760	3770	4240	3687	3460	4382
17		3240	3330	3660	3540	4200	6030	5140		3814	3547	5819
18		2840	3360		3440	5640	7380	5430		3901	3374	6709
19		3330	3390	3730	3360	3890	3590			3496	3494	3590
20				2880	3170	3240				3189	3189	
21					2680	2760				2708	2708	
22		3710	3560							3667	3667	
23			3150	3110	3600					3496	3496	
24					3060	3270	4850			3452	3186	4850
25					2010	2210				2086	2086	
26			3680	4040	3840					3742	3742	
28					2970	4450				3492	3492	
29		2160	3470	3800	3650	4650				2765	2765	
# borings	0	5	9	8	14	12	7	5	3	15	15	7
Avg. Vs (ft/s)	-	<b>3056</b>	<b>3452</b>	<b>3354</b>	<b>3241</b>	<b>3787</b>	<b>5200</b>	<b>5358</b>	<b>6213</b>	<b>3526</b>	<b>3307</b>	<b>5438</b>
St.Dev.,σ (ft/s)	-	589	197	603	462	940	1229	1010	1709	692	475	1180
Coeff of var., σ/Avg. Vs	-	0.19	0.06	0.18	0.14	0.25	0.24	0.19	0.28	0.20	0.14	0.22

<sup>a</sup>Tmbt1 to Tpcpul  
<sup>b</sup>Tpcpmn to Tpcpln

Table A6-8. Computed existing fill and bedrock shear wave velocity averages of downhole, SASW, and suspension logging surveys.

Material	Fill	Tmbt1	Tpki	Tpbt5	Tpcrn	Tpcpul	Tpcpmn	Tpcpll	Tpcpln	All Rock	Upper Rock <sup>a</sup>	Lower Rock <sup>b</sup>
# measurements	18	12	24	22	37	27	17	12	8	41	41	17
Avg. Vs (ft/s)	1097	3006	3277	3205	3113	3624	4912	5515	6104	<b>3360</b>	<b>3146</b>	<b>5115</b>
St.Dev.,σ (ft/s)	337	424	393	516	514	1033	1212	946	1081	656	475	1230
Coeff of var, σ/avg	0.31	0.14	0.12	0.16	0.17	0.29	0.25	0.17	0.18	0.20	0.15	0.24

<sup>a</sup>Tmbt1 to Tpcpul  
<sup>b</sup>Tpcpmn to Tpcpln

APPENDIX A – SEISMIC WAVE VELOCITY

Table A6-9. Computed existing fill and bedrock compression wave velocity averages (downhole surveys).

Boring	COMPRESSION WAVE VELOCITY, Vp (FT/S)											
	Downhole											
	Fill	Tmbt1	Tpki	Tpbt5	Tpcrn	Tpcpul	Tpcpmn	Tpcpll	Tpcpln	All Rock	Upper Rock <sup>a</sup>	Lower Rock <sup>b</sup>
13		3746	4685	4685	4685	6748	9335	9335	9335	6785	4877	9335
13		3700	3916	3970	5417	11180	11180	11180	11180	8201	5669	11180
14	2955	3805	4168	4300	5900	7113	9203	11000	11000	7532	6352	10300
15					4147	7403	12748	14000	14000	9084	6174	13531
16		3075	3667		4850	5864	8735	10000	10000	6267	5342	9360
17	2510	4160	4060	4060	6731	9602	10210			6916	6699	10210
18	3305	3305	3823		5881	7489	8300	8300		6643	6393	8300
19	2748	3440	3797	3950	6350	6350	6350			5898	5894	6350
20	2470	3540	3540	4115	4320	4320				4320	4320	
21	2845	2845	2951		4350	4850				4437	4437	
22	2445	3141	4185	4185	5560					5537	5537	
23		3412	3765		5167					5054	5054	
24	2241	2785			4878	4960	4960			4932	4927	4960
25	2710	2710	4059		4328	4800				4495	4495	
26		4115	4115	4115	5750					5986	5986	
28	3995				4922	5640				5147	5147	
29	2875	2875	3595	4005	6040					5799	5799	
# borings	11	15	14	9	17	13	9	6	5	17	17	9
Avg. Vp (ft/s)	2827	3377	3880	4154	5252	6640	9002	10636	11103	6061	5477	9281
St.Dev.,σ (ft/s)	485	470	399	227	778	1988	2354	1965	1785	1350	729	2545
Coeff of var., σ/Avg. Vp	0.17	0.14	0.10	0.05	0.15	0.30	0.26	0.18	0.16	0.22	0.13	0.27

<sup>a</sup>Tmbt1 to Tpcpul  
<sup>b</sup>Tpcpmn to Tpcpln

Table A6-10. Bedrock compression wave velocity averages as reported in BSC2002a (suspension logging).

Boring	COMPRESSION WAVE VELOCITY, Vp (FT/S)											
	Suspension Logging, source-to-receiver											
	Fill	Tmbt1	Tpki	Tpbt5	Tpcrn	Tpcpul	Tpcpmn	Tpcpll	Tpcpln	All Rock	Upper Rock <sup>a</sup>	Lower Rock <sup>b</sup>
14			6750	6340	5980	5560	8060	10840	11610	7573	6060	10435
15					6950	8340	9930	9970	12860	9358	7816	11539
16			5830	5690	5840	6440	7520	6600	7240	6400	6127	7235
17		6020	6550	7930	7460	7800	10320	10080		7273	6875	10263
18		5960	7900		8620	11280	14960	13420		8344	7200	14430
19		6710	7120	8570	9070	9240	10920			7935	7876	10920
20				5420	5490	5790				5645	5645	
21					4960	5190				5041	5041	
22		6780								4817	4817	
23			5710	5640	6540					6348	6348	
24					5800	5860	8610			6279	5836	8610
25					3910	4170				4009	4009	
26			6290	6940	6890					6495	6495	
28					5320	7530				6100	6100	
29		7530	9150	6690	9210					8172	8172	
# borings	0	5	8	8	14	11	7	5	3	15	15	7
Avg. Vp (ft/s)	-	6600	6913	6653	6574	7018	10046	10182	10570	6653	6294	10490
St.Dev.,σ (ft/s)	-	643	1146	1131	1577	2061	2496	2439	2951	1463	1173	2273
Coeff of var., σ/Avg. Vp	-	0.10	0.17	0.17	0.24	0.29	0.25	0.24	0.28	0.22	0.19	0.22

<sup>a</sup>Tmbt1 to Tpcpul  
<sup>b</sup>Tpcpmn to Tpcpln

APPENDIX A – SEISMIC WAVE VELOCITY

**Table A6-11. Computed existing fill and bedrock compression wave velocity averages of downhole and suspension logging surveys.**

Material	Fill	Tmbt1	Tpki	Tpbt5	Tpcrn	Tpcpul	Tpcpmn	Tpcpll	Tpcpln	All Rock	Upper Rock <sup>a</sup>	Lower Rock <sup>b</sup>
# measurements	11	20	22	17	31	24	16	11	8	32	32	19
Avg. V <sub>p</sub> (ft/s)	2827	4183	4983	5330	5849	6813	9459	10430	10903	<b>6338</b>	<b>5860</b>	<b>9810</b>
St.Dev.,σ (ft/s)	485	1517	1663	1496	1360	1986	2394	2090	2094	1413	1034	2430
Coeff of var, σ/avg	0.17	0.36	0.33	0.28	0.23	0.29	0.25	0.20	0.19	0.22	0.18	0.25

<sup>a</sup>Tmbt1 to Tpcpul  
<sup>b</sup>Tpcpmn to Tpcpln

Based on all the surveys, the following average ranges were estimated:

<b>V<sub>s</sub> for upper rock:</b>	<b>3,100 ± 480 ft/s</b>
<b>V<sub>p</sub> for upper rock:</b>	<b>5,900 ± 1,030 ft/s</b>
<b>V<sub>s</sub> for lower rock:</b>	<b>5,100 ± 1,230 ft/s</b>
<b>V<sub>p</sub> for lower rock:</b>	<b>9,800 ± 2,430 ft/s</b>
<b>V<sub>s</sub> for entire rock:</b>	<b>3,400 ± 660 ft/s</b>
<b>V<sub>p</sub> for entire rock:</b>	<b>6,300 ± 1,410 ft/s</b>

Using equation (A3), Poisson’s ratio for the upper and lower rock layers are found to be similar. The range for the entire rock is 0.27 – 0.31. This is in relative good agreement with Figures 28 (downhole measurements) and 36 (suspension logging surveys) of BSC (2002a).



APPENDIX A – SEISMIC WAVE VELOCITY

---

## A7 Results/Conclusions

A simple analysis was performed to compute statistical values of the shear- and compression-wave velocities of the soil layers present at the Yucca Mountain Project site for three methods of seismic wave surveying. Data was provided from BSC (2002a).

Based on the comparisons made, the following average ranges of seismic velocities were estimated for the alluvium and bedrock materials:

- **Alluvium**

Depth (ft)	Shear Wave Velocity (ft/s)	Compression Wave Velocity (ft/s)
5 – 15	1,500 ± 270	2,800 ± 490
15 – 30	1,700 ± 320	3,400 ± 470
30 – 60	2,200 ± 220	3,900 ± 400
60 – 100	2,500 ± 300	4,200 ± 230

- **Bedrock**

<b>V<sub>s</sub> for upper rock:</b>	<b>3,100 ± 480 ft/s</b>
<b>V<sub>p</sub> for upper rock:</b>	<b>5,900 ± 1,030 ft/s</b>
<b>V<sub>s</sub> for lower rock:</b>	<b>5100 ± 1,230 ft/s</b>
<b>V<sub>p</sub> for lower rock:</b>	<b>9,800 ± 2,430 ft/s</b>
<b>V<sub>s</sub> for entire rock:</b>	<b>3,400 ± 660 ft/s</b>
<b>V<sub>p</sub> for entire rock:</b>	<b>6,300 ± 1,410 ft/s</b>

The upper rock refers to the Tmbt1 to Tpcpl layers. The lower rock refers to the Tpcpmn to Tpcpln layers. It should be noted that the analyses were based on averaging seismic wave velocities within each soil/rock unit.

A Poisson's ratio of 0.23 to 0.44 is estimated for the alluvium. A Poisson's ratio of 0.27 to 0.31 is estimated for the bedrock.

The averages do not take into account the influence of depth with seismic velocity. A review of the geologic conditions of the site shows that the bedrock unit layers may vary considerably in elevation at some locations. It should also be noted for simplification, that equal weight was given to each boring where a survey was conducted, regardless of the survey method or how many measurements were made within the soil/rock unit (in the case of the suspension logging surveys).

APPENDIX A – SEISMIC WAVE VELOCITY

## A8 Attachments

The following sections contain data and spreadsheets used for the analyses:

- A8.1 Seismic wave data – contains all the seismic wave data and corresponding depths at which they were measured presented in BSC (2002a) that was used for the analyses.
- A8.2 Soil contact depths – contains all the soil contact depths from the boring logs presented in BSC (2002a). These contact depths were superimposed onto the data from Section A8.1 in order to assign the appropriate seismic wave velocity values to their corresponding soil unit.
- A8.3 EXCEL spreadsheets – contains the averaging performed on the seismic wave velocity data for each boring where data is available. Seismic wave velocity average = sum of (velocity × thickness) / sum of thickness for each soil/rock unit.

### A8.1 Seismic Wave Data (from BSC 2002a)

- Shear wave velocity as reported in BSC (2002a) (downhole surveys)

Table 8. WHB Area Downhole Shear-Wave Velocities

RF#13 (all boreholes surveyed by Redpath Geophysics unless otherwise indicated)	Depth Range (ft)	Velocity (ft/s)
	3 - 10	750
10 - 25	1355	
25 - 80	2030	
80 - 230	2740	
230 - 345	5,800 ±	
RF#13 (GEOVision)	Depth Range (ft)	Velocity (ft/s)
	0 - 15	1,090
	15 - 36	1,960
	36 - 99	2,490
	99 - 215	2810
215 - 345	6490	
RF#14	Depth Range (ft)	Velocity (ft/s)
	3 - 15	1240
	15 - 38	1700
	38 - 114	2375
	114 - 165	3390
	165 - 305	2640
305 - 520	5000 ±	
RF#15	Depth Range (ft)	Velocity (ft/s)
	3 - 38	1935
	38 - 122	2700 ±
	122 - 230	3380
230 - 320	5900	

APPENDIX A – SEISMIC WAVE VELOCITY

Table 8. WHB Downhole Shear-Wave Velocities (continued)

RF#16	Depth Range (ft)	Velocity (ft/s)
	3 - 15	655
	15 - 24	1130
	24 - 50	1640
	50 - 296	2800
	296 - 376	3540
RF#17 (GEOVision)	Depth Range (ft)	Velocity (ft/s)
	0 - 15	1210
	15 - 30	1880
	30 - 100	2490
	100 - 400	3160
	400 - 500	3890
RF#18	Depth Range (ft)	Velocity (ft/s)
	3 - 24	1435
	24 - 48	1670
	48 - 78	2900
	78 - 220	3860
	220 - 250	2400
RF#19	Depth Range (ft)	Velocity (ft/s)
	3 - 18	1285
	18 - 39	1810
	39 - 96	2305
	96 - 282	2740
	282 - 550	3780
RF#20	Depth Range (ft)	Velocity (ft/s)
	3 - 24	1200
	24 - 70	2020
	70 - 155	2800 ±
RF#21	Depth Range (ft)	Velocity (ft/s)
	3 - 20	1310
	20 - 84	1930
	84 - 185	2500 ±
RF#22	Depth Range (ft)	Velocity (ft/s)
	3 - 21	1465
	21 - 83	2200
	83 - 175	3540
	175 - 192	1400
	192 - 500	3500
RF#23	Depth Range (ft)	Velocity (ft/s)
	3 - 9	690
	9 - 21	1565
	21 - 72	2100
	72 - 110	2865
	110 - 155	3600
RF#24	Depth Range (ft)	Velocity (ft/s)
	3 - 18	1195
	18 - 33	1535
	33 - 260	2070

Table 8. WHB Downhole Shear-Wave Velocities (continued)

RF#25	Depth Range (ft)	Velocity (ft/s)
	3 - 37	1645
	37 - 86	2940
	86 - 155	2100
RF# 26	Depth Range (ft)	Velocity (ft/s)
	3 - 12	425
	12 - 46	1745
	46 - 95	2550
	95 - 260	3780
RF#28	Depth Range (ft)	Velocity (ft/s)
	3 - 10	1305
	10 - 39	1980
	39 - 95	3300
RF#29	Depth Range (ft)	Velocity (ft/s)
	3 - 33	1660
	33-75	2170
	75-138	2560
	138-230	3320
	230 -405	3800

APPENDIX A – SEISMIC WAVE VELOCITY

- Compression wave velocity as reported in BSC (2002a) (downhole surveys)

Table 9. WHB Area Downhole Compression-Wave Velocities

	Depth Range (ft)	Velocity (ft/s)
RF#13 (all boreholes surveyed by Redpath Geophysics unless otherwise indicated)	3 - 9	1455
	9 - 26	3405
	26 - 226	4685
	226 - 345	9335
RF#13 (GEOVision)	0 - 15	2110
	15 - 36	3700
	36 - 99	3970
	99 - 215	4900
	215 - 345	11,180
RF#14	6 - 12	2530
	12 - 38	3805
	38 - 110	4300
	110 - 304	5900
	304 - 420	7500
RF#15	420 - 520	11,000
	3 - 18	3215
	18 - 39	3815
	38 - 133	4600 ±
	133 - 210	9850
RF#16	210 - 320	14,000 ±
	3 - 15	1590
	15 - 50	3075
	50 - 280	4850
	280 - 376	6600 ±
RF#17 (GEOVision)	376 - 445	10,000 ±
	0 - 15	2510
	15 - 30	4160
	30 - 100	4060
	100 - 400	5580
RF#18	400 - 500	7190
	500 - 620	10,210
	3 - 48	3305
	48 - 78	4600
	78 - 290	5850
RF#19	290 - 390	7200
	390 - 485	8300 ±
	3 - 9	1710
	9 - 39	3440
	39 - 104	3950
RF#19	104 - 294	5000
	294 - 640	6350

APPENDIX A – SEISMIC WAVE VELOCITY

Table 9. Downhole Compression Wave Velocities (concluded)

	Depth Range (ft)	Velocity (ft/s)
RF#20	3 - 13	1935
	13 - 70	3540
	70 - 155	4320
RF#21	3-57	2845
	57 -120	3900
	120-185	4850
RF#22	3 - 24	2445
	24 - 87	4185
	87 - 505	5580
RF#23	3 - 18	2000
	18 - 72	3765
	72 - 120	4700
	120 - 155	5500
RF#24	3 - 12	1425
	12 - 33	2785
	33 - 260	4960
RF#25	3 - 41	2710
	41 - 86	4840
	86 - 105	3400
	105 - 155	4800 ±
RF#26	3 - 10	840
	10 - 95	4115
	95 - 140	7030
	140 - 260	5750
RF#28	3 - 39	3995
	39 - 96	5640
RF#29	3 - 33	2875
	33 - 75	3675
	75 - 135	4500
	135 - 405	6040

*Jal*  
 1/2/2007

APPENDIX A – SEISMIC WAVE VELOCITY

Shear wave velocity as reported in BSC (2002a) (suspension surveys, source-to-receiver)

Table VII-2. Statistics for Suspension Seismic <sup>SOURCE</sup>Receiver-to-Receiver Shear-Wave Velocities by Lithostratigraphic Unit

Borehole	Parameter	Fill	Qal	Tmbt1	Tpki	Tpbt5	Tpcrn	Tpcpul	Tpcpmn	Tpcpll	Tpcpln
RF#13 (core)	Depth (ft)	0-12.5	12.5-98.0		98.0-164.4	164.4-169.3	169.3-219.1	219.1-231.5	231.5-286.7	286.7-300.9	300.9-350.1
	Mean Vs (ft/s)	NA	NA		NA	NA	NA	NA	NA	NA	NA
	Median Vs (ft/s)	NA	NA		NA	NA	NA	NA	NA	NA	NA
	Standard Deviation	NA	NA		NA	NA	NA	NA	NA	NA	NA
	Coeff. of var. (%)	NA	NA		NA	NA	NA	NA	NA	NA	NA
	No. of meas.	0	0		0	0	0	0	0	0	0
RF#14 (core)	Depth (ft)		0-101.8		101.8-192.5	192.5-203.4	203.4-275.0	275.0-395.0	395.0-443.7	443.7-455.6	455.6-550.0
	Mean Vs (ft/s)		2940		3790	3420	3350	3130	4380	6280	7240
	Median Vs (ft/s)		2930		3830	3280	3220	3010	4310	6180	7330
	Standard Deviation		242.3		247.7	392.3	539.7	1008.6	1370.3	978.5	716.1
	Coeff. of var. (%)		8.2		6.5	11.5	16.1	32.2	31.3	15.6	9.9
	No. of meas.		31		56	6	44	73	30	7	55
RF#15 (core)	Depth (ft)	0-6.5					6.5-78.0	78.0-196.0	196.0-242.4	242.4-256.6	256.6-330.0
	Mean Vs (ft/s)	NA					3360	4380	5410	6170	7160
	Median Vs (ft/s)	NA					3230	4500	5120	6130	7180
	Standard Deviation	NA					544.6	639.0	1357.9	433.5	468.9
	Coeff. of var. (%)	NA					16.2	14.6	25.1	7.0	6.5
	No. of meas.	0					31	72	28	9	37
RF#16 (core)	Depth (ft)	0-22.4	22.4-75.7		75.7-133.2	133.2-137.8	137.8-222.0	222.0-360.0	360.0-403.0	403.0-422.5	422.5-452.8
	Mean Vs (ft/s)	NA	2180		3340	2190	3350	3620	4760	3770	4240
	Median Vs (ft/s)	NA	2200		3400	2190	3300	3570	4810	3560	4180
	Standard Deviation	NA	147.7		407.9	113.1	324.3	721.5	1075.6	570.9	541.6
	Coeff. of var. (%)	NA	6.8		12.2	5.2	9.7	20.0	22.6	15.2	12.8
	No. of meas.	0	30		35	2	52	84	26	12	15
RF#17 (core)	Depth (ft)		0-92.4	92.4-287.2	287.2-348.4	348.4-368.9	368.9-478.0	478.0-587.3	587.3-637.6	637.6-653.2	653.2-667.8
	Mean Vs (ft/s)		2420	3240	3330	3660	3540	4250	5980	5240	NA
	Median Vs (ft/s)		2460	3160	3350	3620	3450	4200	6030	5140	NA
	Standard Deviation		383.1	355.1	169.7	159.5	562.1	1053.9	616.4	156.9	NA
	Coeff. of var. (%)		15.9	11.0	5.1	4.4	15.9	24.8	10.3	3.0	NA
	No. of meas.		24	118	38	12	67	66	31	7	0
RF#18 (cuttings)	Depth (ft)		0-60.0	60.0-65.0	65.0-204.0		204.0-292.0	292.0-425.0	425.0-470.0	470.0-493.6	
	Mean Vs (ft/s)		2240	2840	3360		3440	5640	7380	5430	
	Median Vs (ft/s)		2300	2830	3540		3300	5740	7360	5160	
	Standard Deviation		316.2	140.5	441.8		716.1	1337.7	1246.7	1619.0	
	Coeff. of var. (%)		14.1	4.9	13.2		20.8	23.7	16.9	29.8	
	No. of meas.		16	3	85		53	81	28	9	

DTN: MO0204SUSPSEIS.001

\*Note: The above table appears to be source-to-receiver, not receiver-to-receiver as indicated

Table VII-2. Statistics for Suspension Seismic Source-to-Receiver Shear-Wave Velocities by Lithostratigraphic Unit (Continued)

Borehole	Parameter	Fill	Qal	Tmbt1	Tpki	Tpbt5	Tpcrn	Tpcpul	Tpcpmn	Tpcpll	Tpcpln
RF#19 (cuttings)	Depth (ft)		0-120.0	120.0-280.0	280.0-410.0	410.0-420.0	420.0-510.0	510.0-635.0	635.0-645.2		
	Mean Vs (ft/s)		2460	3330	3390	3730	3360	3890	3590		
	Median Vs (ft/s)		2440	3340	3410	3640	3270	3770	3600		
	Standard Deviation		339.4	318.7	412.5	238.3	483.2	688.2	55.7		
	Coeff. of var. (%)		13.8	9.6	12.2	6.4	14.4	17.7	1.6		
	No. of meas.		52	98	79	6	55	76	3		
RF#20 (cuttings)	Depth (ft)	0-28.0	28.0-98.0			98.0-102.0	102.0-127.0	127.0-160.0			
	Mean Vs (ft/s)	2080	2600			2880	3170	3240			
	Median Vs (ft/s)	2080	2560			2790	3200	3310			
	Standard Deviation	90.7	386.5			314.8	418.5	377.2			
	Coeff. of var. (%)	4.4	14.9			10.9	13.2	11.6			
	No. of meas.	4	43			3	15	15			
RF#21** (cuttings)	Depth (ft)	0-5.0	5.0-115.0				115.0-165.0	165.0-192.2			
	Mean Vs (ft/s)	NA	1910				2680	2760			
	Median Vs (ft/s)	NA	1920				2670	2750			
	Standard Deviation	NA	298.3				401.6	426.1			
	Coeff. of var. (%)	NA	15.6				15.0	15.4			
	No. of meas.	0	58				31	12			
RF#22 (cuttings /core)	Depth (ft)		0-80.0	80.0-318.0	318.0-415.0	415.0-438.0	438.0-530.0	530.0-540.0			
	Mean Vs (ft/s)		NA	3710	3560	NA	NA	NA			
	Median Vs (ft/s)		NA	3720	3610	NA	NA	NA			
	Standard Deviation		NA	118.4	214.1	NA	NA	NA			
	Coeff. of var. (%)		NA	3.2	6.0	NA	NA	NA			
	No. of meas.		0	51	47	0	0	0			
RF#23 (cuttings)	Depth (ft)	0-12.0	12.0-76.0		76.0-92.0	92.0-95.0	95.0-159.1				
	Mean Vs (ft/s)	1300	2040		3150	3110	3600				
	Median Vs (ft/s)	1300	1730		2990	3110	3550				
	Standard Deviation	NA	653.8		338.4	339.4	907.1				
	Coeff. of var. (%)	NA	32.1		10.8	10.9	25.2				
	No. of meas.	1	39		9	2	36				
RF#24 (cuttings)	Depth (ft)	0-10.0	10.0-30.0				30.0-110.0	110.0-230.0	230.0-268.0		
	Mean Vs (ft/s)	NA	2030				3060	3270	4850		
	Median Vs (ft/s)	NA	2030				2960	3370	4650		
	Standard Deviation	NA	NA				735.4	778.0	905.6		
	Coeff. of var. (%)	NA	NA				24.0	23.8	18.7		
	No. of meas.	0	1				48	74	20		

DTN: MO0204SUSPSEIS.001

APPENDIX A – SEISMIC WAVE VELOCITY

Table VII-2. Statistics for Suspension Seismic Source-to-Receiver Shear-Wave Velocities by Lithostratigraphic Unit (Continued)

Borehole	Parameter	Fill	Qal	Tmbt1	Tpki	Tpbt5	Tpcrn	Tpcpul	Tpcpmn	Tpcpll	Tpcpln
RF#25 (cuttings)	Depth (ft)	0-10.0	10.0-70.0				70.0-125.0	125.0-159.0			
	Mean Vs (ft/s)	NA	NA				2010	2210			
	Median Vs (ft/s)	NA	NA				1990	2120			
	Standard Deviation	NA	NA				239.7	289.5			
	Coeff. of var. (%)	NA	NA				12.0	13.1			
	No. of meas.	0	0				26	16			
RF#26 (cuttings)	Depth (ft)	0-14.0	14.0-85.0		85.0-204.0	204.0-211.0	211.0-264.9				
	Mean Vs (ft/s)	NA	2410		3680	4040	3840				
	Median Vs (ft/s)	NA	2180		3700	4030	3800				
	Standard Deviation	NA	623.0		243.7	591.7	336.4				
	Coeff. of var. (%)	NA	25.8		6.6	14.7	8.8				
	No. of meas.	0	40		73	4	28				
RF#28 (cuttings)	Depth (ft)	0-5.0	5.0-15.0				15.0-70.0	70.0-100.0			
	Mean Vs (ft/s)	NA	NA				2970	4450			
	Median Vs (ft/s)	NA	NA				3010	4710			
	Standard Deviation	NA	NA				202.5	814.5			
	Coeff. of var. (%)	NA	NA				6.8	18.3			
	No. of meas.	0	0				25	15			
RF#29 (cuttings)	Depth (ft)		0-85.0	85.0-280.0	280.0-370.0	370.0-380.0	380.0-430.0				
	Mean Vs (ft/s)		2160	3470	3800	3650	4650				
	Median Vs (ft/s)		2070	3640	3900	3320	3920				
	Standard Deviation		351.3	576.5	295.7	1203.1	1568.0				
	Coeff. of var. (%)		16.2	16.6	7.8	33.0	33.7				
	No. of meas.		36	119	55	6	14				
All tests	Mean Vs (ft/s)	1920	2040	3390	3440	3510	3300	3970	5460	5230	6790
	Median Vs (ft/s)	2010	2190	3450	3570	3530	3230	3810	5410	5210	7040
	Standard Deviation	356.5	879.7	437.9	663.9	647.0	739.8	1227.4	1516.4	1308.5	1204.4
	Coeff. of var. (%)	18.5	43.1	12.9	19.3	18.4	22.4	31.0	27.8	25.0	17.7
	No. of meas.	5	419	389	489	41	534	575	166	44	107

DTN: MO0204SUSPSEIS.001

Notes: \* Coefficient of Variation (%) = 100\*standard deviation / mean  
 \*\* In Assumption 4, Section 5, the contact between the Qal and Tpcrn is assumed to be at a depth of 70 feet. This table follows the geologic logs in Attachment I.

APPENDIX A – SEISMIC WAVE VELOCITY

- Compression wave velocity as reported in BSC (2002a) (suspension surveys, source-to-receiver)

Table VII-3. Statistics for Suspension Seismic Source-to-Receiver Compression-Wave Velocities by Lithostratigraphic Unit

Borehole	Parameter	Fill	Qal	Tmbt1	Tpkl	Tpbt5	Tpcrn	Tpcpul	Tpcpmn	Tpcpll	Tpcpin
RF#13 (core)	Depth (ft)	0-12.5	12.5-98.0		98.0-164.4	164.4-169.3	169.3-219.1	219.1-231.5	231.5-286.7	286.7-300.9	300.9-350.1
	Mean Vp (ft/s)	NA	NA		NA	NA	NA	NA	NA	NA	NA
	Median Vp (ft/s)	NA	NA		NA	NA	NA	NA	NA	NA	NA
	Standard Deviation	NA	NA		NA	NA	NA	NA	NA	NA	NA
	Coeff. of var. (%)	NA	NA		NA	NA	NA	NA	NA	NA	NA
	No. of meas.	0	0		0	0	0	0	0	0	0
RF#14 (core)	Depth (ft)		0-101.8		101.8-192.5	192.5-203.4	203.4-275.0	275.0-395.0	395.0-443.7	443.7-455.6	455.6-550.0
	Mean Vp (ft/s)		5450		6750	6340	5980	5660	8060	10840	11610
	Median Vp (ft/s)		5600		6810	6460	5760	5350	7260	10610	11560
	Standard Deviation		632.7		521.8	573.7	1057.8	1428.3	2042.1	1216.0	1493.3
	Coeff. of var. (%)		11.6		7.7	9.0	17.7	25.7	25.3	11.2	12.9
	No. of meas.		31		56	6	39	71	30	7	55
RF#15 (core)	Depth (ft)	0-6.5					6.5-78.0	78.0-196.0	196.0-242.4	242.4-256.6	256.6-330.0
	Mean Vp (ft/s)	NA					6950	8340	9930	9970	12860
	Median Vp (ft/s)	NA					6710	8080	9610	9880	12930
	Standard Deviation	NA					936.7	1066.7	1155.6	605.7	792.2
	Coeff. of var. (%)	NA					13.5	12.8	11.6	6.1	6.2
	No. of meas.	0					31	72	28	9	37
RF#16 (core)	Depth (ft)	0-22.4	22.4-75.7		75.7-133.2	133.2-137.8	137.8-222.0	222.0-360.0	360.0-403.0	403.0-422.5	422.5-452.8
	Mean Vp (ft/s)	NA	5060		5830	5690	5840	6440	7520	6600	7240
	Median Vp (ft/s)	NA	5050		5800	5690	5800	6340	7410	6740	7630
	Standard Deviation	NA	427.3		270.3	91.9	184.7	833.4	1343.8	700.1	1014.9
	Coeff. of var. (%)	NA	8.5		4.6	1.6	3.2	12.9	17.9	10.6	14.0
	No. of meas.	0	30		35	2	52	84	26	12	15
RF#17 (core)	Depth (ft)		0-92.4	92.4-287.2	287.2-348.4	348.4-368.9	368.9-478.0	478.0-587.3	587.3-637.6	637.6-653.2	653.2-667.8
	Mean Vp (ft/s)		5120	6020	6550	7930	7460	7800	10320	10080	NA
	Median Vp (ft/s)		5110	6070	6450	8010	7320	7840	10470	9960	NA
	Standard Deviation		342.8	483.7	480.8	492.6	1442.1	1071.3	556.9	317.4	NA
	Coeff. of var. (%)		6.7	8.0	7.3	6.2	19.3	13.7	5.4	3.1	NA
	No. of meas.		24	118	38	12	67	66	31	7	0
RF#18 (cuttings)	Depth (ft)		0-60.0	60.0-65.0	65.0-204.0		204.0-292.0	292.0-425.0	425.0-470.0	470.0-493.6	
	Mean Vp (ft/s)		6280	5960	7900		8620	11280	14960	13420	
	Median Vp (ft/s)		6210	5930	8010		8060	11200	15260	12920	
	Standard Deviation		368.8	57.7	974.5		1618.3	1897.3	1409.9	1157.8	
	Coeff. of var. (%)		5.9	1.0	12.3		18.8	16.8	9.4	8.6	
	No. of meas.		16	3	85		53	81	28	9	

DTN: MO0204SUSPSEIS.001

Table VII-3. Statistics for Suspension Seismic Source-to-Receiver Compression-Wave Velocities by Lithostratigraphic Unit (Continued)

Borehole	Parameter	Fill	Qal	Tmbt1	Tpkl	Tpbt5	Tpcrn	Tpcpul	Tpcpmn	Tpcpll	Tpcpin
RF#19 (cuttings)	Depth (ft)		0-120.0	120.0-280.0	280.0-410.0	410.0-420.0	420.0-510.0	510.0-635.0	635.0-645.2		
	Mean Vp (ft/s)		4250	6710	7120	8570	9070	9240	10920		
	Median Vp (ft/s)		3800	6690	6860	8320	9080	9130	11030		
	Standard Deviation		962.5	736.1	1132.6	1084.5	701.9	928.9	342.7		
	Coeff. of var. (%)		22.7	11.0	15.9	12.4	7.7	10.1	3.1		
	No. of meas.		52	98	79	6	55	76	3		
RF#20 (cuttings)	Depth (ft)	0-28.0	28.0-98.0				98.0-102.0	102.0-127.0	127.0-160.0		
	Mean Vp (ft/s)	3710	4680				5420	5490	5790		
	Median Vp (ft/s)	3710	4740				5230	5550	5690		
	Standard Deviation	239.8	813.8				536.8	389.7	581.4		
	Coeff. of var. (%)	6.5	17.4				9.9	7.1	10.0		
	No. of meas.	4	43				3	15	15		
RF#21** (cuttings)	Depth (ft)	0-5.0	5.0-115.0				115.0-165.0	165.0-192.2			
	Mean Vp (ft/s)	NA	4280				4960	5190			
	Median Vp (ft/s)	NA	4280				4870	5100			
	Standard Deviation	NA	609.4				958.9	529.0			
	Coeff. of var. (%)	NA	14.2				19.3	10.2			
	No. of meas.	0	58				31	12			
RF#22 (cuttings / core)	Depth (ft)		0-80.0	80.0-318.0	318.0-415.0	415.0-438.0	438.0-530.0	530.0-540.0			
	Mean Vp (ft/s)		NA	6780	6510	NA	NA	NA			
	Median Vp (ft/s)		NA	6710	6520	NA	NA	NA			
	Standard Deviation		NA	522.8	331.1	NA	NA	NA			
	Coeff. of var. (%)		NA	7.7	5.1	NA	NA	NA			
	No. of meas.		0	51	47	0	0	0			
RF#23 (cuttings)	Depth (ft)	0-12.0	12.0-76.0		76.0-92.0	92.0-95.0	95.0-159.1				
	Mean Vp (ft/s)	5470	4320		5710	5640	6540				
	Median Vp (ft/s)	5470	4230		5270	5640	6560				
	Standard Deviation	NA	1200.4		922.1	410.1	1515.8				
	Coeff. of var. (%)	NA	27.8		16.1	7.3	23.2				
	No. of meas.	1	39		9	2	36				
RF#24 (cuttings)	Depth (ft)	0-10.0	10.0-30.0				30.0-110.0	110.0-230.0	230.0-268.0		
	Mean Vp (ft/s)	NA	5390				5800	5860	8610		
	Median Vp (ft/s)	NA	5390				5620	5760	8520		
	Standard Deviation	NA	NA				935.2	1161.9	1057.4		
	Coeff. of var. (%)	NA	NA				16.1	19.8	12.3		
	No. of meas.	0	1				48	74	20		

DTN: MO0204SUSPSEIS.001



APPENDIX A – SEISMIC WAVE VELOCITY

Table VII-3. Statistics for Suspension Seismic Source-to-Receiver Compression-Wave Velocities by Lithostratigraphic Unit (Continued)

Borehole	Parameter	Fill	Qal	Tmbt1	Tpkl	Tpbt5	Tpcrn	Tpcpul	Tpcpmn	Tpcpll	Tpcpln
RF#25 (cuttings)	Depth (ft)	0-10.0	10.0-70.0				70.0-125.0	125.0-159.0			
	Mean Vp (ft/s)	NA	NA				3910	4170			
	Median Vp (ft/s)	NA	NA				3930	4030			
	Standard Deviation	NA	NA				453.1	553.7			
	Coeff. of var. (%)	NA	NA				11.6	13.3			
	No. of meas.	0	0				26	16			
RF#26 (cuttings)	Depth (ft)	0-14.0	14.0-85.0		85.0-204.0	204.0-211.0	211.0-264.9				
	Mean Vp (ft/s)	NA	4340		6290	6940	6890				
	Median Vp (ft/s)	NA	3840		6240	6660	6840				
	Standard Deviation	NA	1171.2		495.5	1241.1	472.3				
	Coeff. of var. (%)	NA	27.0		7.9	17.9	6.9				
	No. of meas.	0	33		73	4	28				
RF#28 (cuttings)	Depth (ft)	0-5.0	5.0-15.0				15.0-70.0	70.0-100.0			
	Mean Vp (ft/s)	NA	NA				5320	7530			
	Median Vp (ft/s)	NA	NA				5190	7650			
	Standard Deviation	NA	NA				477.3	799.1			
	Coeff. of var. (%)	NA	NA				9.0	10.6			
	No. of meas.	0	0				25	15			
RF#29 (cuttings)	Depth (ft)		0-85.0	85.0-280.0	280.0-370.0	370.0-380.0	380.0-430.0				
	Mean Vp (ft/s)		4430	7530	9150	6690	9210				
	Median Vp (ft/s)		4500	7790	9310	5830	8070				
	Standard Deviation		524.7	1593.9	1185.3	1994.0	2866.4				
	Coeff. of var. (%)		11.9	21.2	13.0	29.8	31.1				
	No. of meas.		36	119	55	6	14				
All tests	Mean Vp (ft/s)	4060	4660	6760	7100	7110	6730	7650	9990	9910	11430
	Median Vp (ft/s)	3820	4670	6550	6730	7060	6410	7470	9690	9990	12050
	Standard Deviation	812.9	948.5	1168.9	1258.6	1394.2	1828.7	2310.9	2798.1	2540.1	2167.4
	Coeff. of var. (%)	20.0	20.4	17.3	17.7	19.6	27.2	30.2	28.0	25.6	19.0
	No. of meas.	5	363	389	477	41	529	573	166	44	107

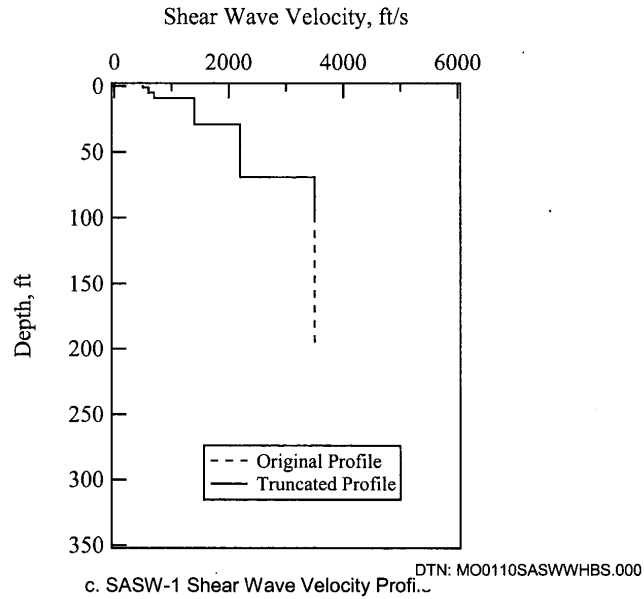
DTN: MO0204SUSPSEIS.001

Notes: \* Coefficient of Variation (%) = 100\*standard deviation / mean

\*\* In Assumption 4, Section 5, the contact between the Qal and Tpcrn is assumed to be at a depth of 70 feet. This table follows the geologic logs in Attachment I.

APPENDIX A – SEISMIC WAVE VELOCITY

- Shear wave velocity (SASW surveys)



c. SASW-1 Shear Wave Velocity Profil...

Location: SASW-1

Layer No.	Thickness, ft	P-Wave Velocity, ft/s	S-Wave Velocity, ft/s	Poisson's Ratio***	Mass Density*** pcf
1	1	866	500	0.25	120
2	4	1039	600	0.25	120
3	4	1212	700	0.25	120
4	20	2425	1400	0.25	120
5	40	3810	2200	0.25	120
6	29*	6062	3500	0.25	80
7	102**	6062	3500	0.25	80

DTN: MO0110SASWWHBS.000

\* Vs profile truncated at 98 ft based on geological profile showing an offset fault beginning at a depth of approximately 98 ft.

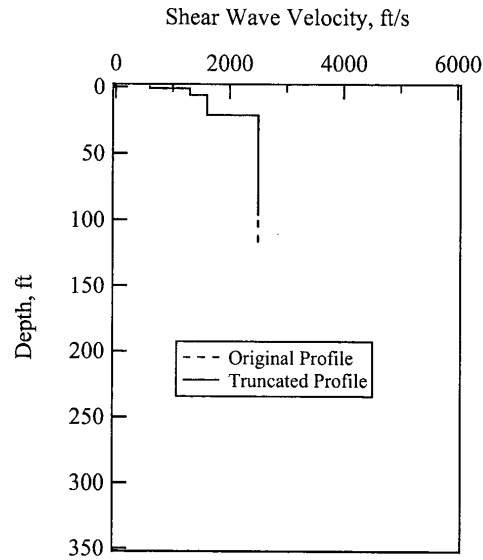
\*\* Additional layering used in matching the theoretical dispersion curve to the complete experimental dispersion curve

\*\*\* Poisson's ratio and mass density from Wong (2002c, Appendix 1)

Figure IX-1. SASW-1 Results (continued)

Corresponds to Boring RF#13

APPENDIX A – SEISMIC WAVE VELOCITY



DTN: MO0110SASWWHBS.000

c. SASW-2 Shear Wave Velocity Profile

Location: SASW-2

Layer No.	Thickness, ft	P-Wave Velocity, ft/s	S-Wave Velocity, ft/s	Poisson's Ratio***	Mass Density*** pcf
1	1	1039	600	0.25	120
2	5	2252	1300	0.25	120
3	15	2771	1600	0.25	120
4	75*	4850	2500	0.25	120
5	24**	4850	2500	0.25	120

DTN: MO0110SASWWHBS.000

\* Vs profile truncated at 96 ft based on geological profile showing an offset fault beginning at a depth of approximately 96 ft.

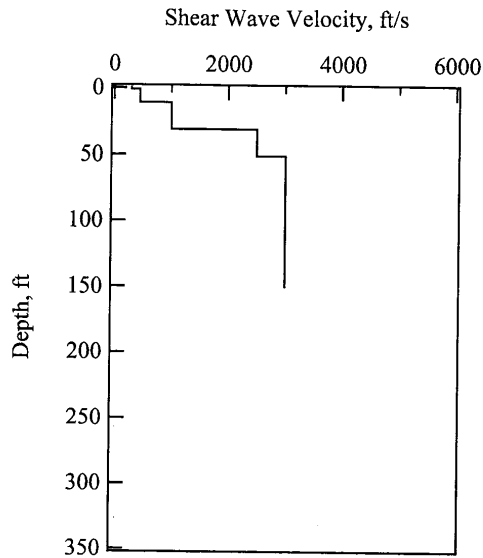
\*\* Additional layering used in matching the theoretical dispersion curve to the complete experimental dispersion curve

\*\*\* Poisson's ratio and mass density from Wong (2002c, Appendix 2)

Figure IX-2. SASW-2 Results (continued)

Corresponds to Boring RF#21

APPENDIX A – SEISMIC WAVE VELOCITY



DTN: MO0110SASWWHBS.000

c. SASW-4 Shear Wave Velocity Profile

Location: SASW-4

Layer No.	Thickness, ft	P-Wave Velocity, ft/s	S-Wave Velocity, ft/s	Poisson's Ratio*	Mass Density* pcf
1	1	520	300	0.25	120
2	10	779	450	0.25	120
3	20	1732	1000	0.25	120
4	20	4330	2500	0.25	120
5	100	5196	3000	0.25	80

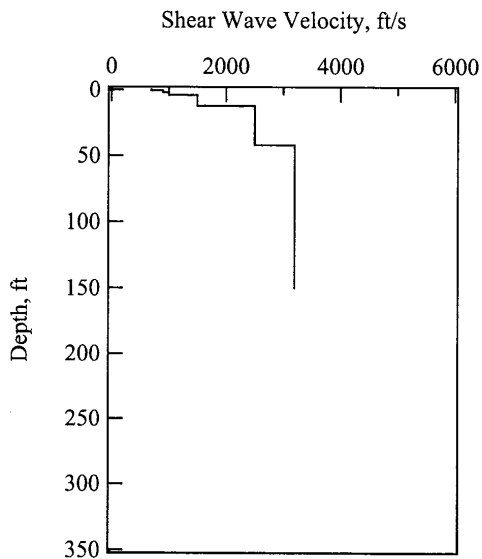
DTN: MO0110SASWWHBS.000

\* Poisson's ratio and mass density from Wong (2002c, Appendix 4)

Figure IX-4. SASW-4 Results (continued)

Corresponds to Boring RF#26

APPENDIX A – SEISMIC WAVE VELOCITY



DTN: MO0110SASWWHBS.000

c. SASW-8 Shear Wave Velocity Profile

Location: SASW-8

Layer No.	Thickness, ft	P-Wave Velocity, ft/s	S-Wave Velocity, ft/s	Poisson's Ratio*	Mass Density* pcf
1	0.5	1212	700	0.25	120
2	1.5	1559	900	0.25	120
3	2.0	1732	1000	0.25	120
4	8	2598	1500	0.25	120
5	30	4330	2500	0.25	120
6	108	5543	3200	0.25	80

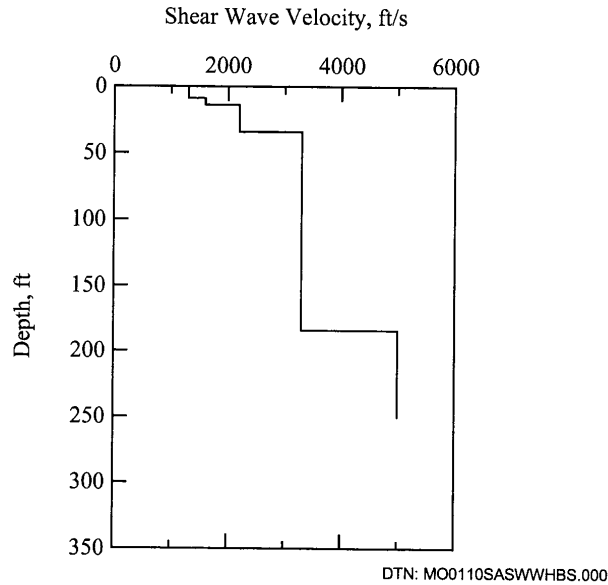
DTN: MO0110SASWWHBS.000

\* Poisson's ratio and mass density from Wong (2002c, Appendix 8)

Figure IX-8. SASW-8 Results (continued)

Corresponds to Boring RF#28

APPENDIX A – SEISMIC WAVE VELOCITY



c. SASW-10+37 Shear Wave Velocity Profile

Location: SASW-10+37

Layer No.	Thickness, ft	P-Wave Velocity, ft/s	S-Wave Velocity, ft/s	Poisson's Ratio*	Mass Density* pcf
1	1	2251	1300	0.25	120
2	8	2251	1300	0.25	120
3	5	2771	1600	0.25	120
4	20	3810	2200	0.25	120
5	150	5716	3300	0.25	80
6	66	8660	5000	0.25	145

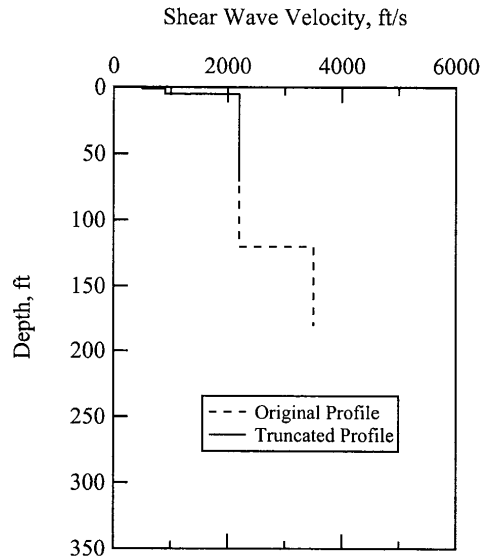
DTN: MO0110SASWWHBS.000

\* Poisson's ratio and mass density from Wong (2002c, Appendix 10)

Figure IX-10. SASW-10+37 Results (continued)

Corresponds to Boring RF#15

APPENDIX A – SEISMIC WAVE VELOCITY



DTN: MO0110SASWWHBS.000

c. SASW-23 Shear Wave Velocity Profile

Location: SASW-23

Layer No.	Thickness, ft	P-Wave Velocity, ft/s	S-Wave Velocity, ft/s	Poisson's Ratio***	Mass Density*** pcf
1	1	866	500	0.25	120
2	4	1559	900	0.25	120
3	65*	3810	2200	0.25	120
4	50**	3810	2200	0.25	120
5	60**	6062	3500	0.25	80

DTN: MO0110SASWWHBS.000

\* Vs profile truncated at 70 ft based on geological profile showing an offset fault beginning at a depth of approximately 70 ft.

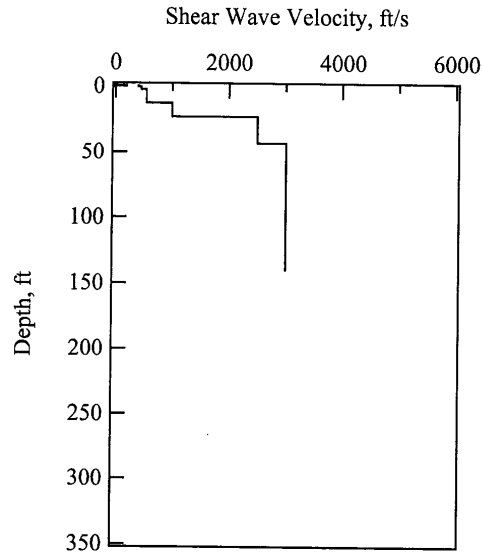
\*\* Additional layering used in matching the theoretical dispersion curve to the complete experimental dispersion curve

\*\*\* Poisson's ratio and mass density from Wong (2002c, Appendix 23)

Figure IX-23. SASW-23 Results (continued)

Corresponds to Boring RF#22

APPENDIX A – SEISMIC WAVE VELOCITY



DTN: MO0110SASWWHBS.000

c. SASW-29 Shear Wave Velocity Profile

Location: SASW-29

Layer No.	Thickness, ft	P-Wave Velocity, ft/s	S-Wave Velocity, ft/s	Poisson's Ratio*	Mass Density* pcf
1	0.5	692	400	0.25	120
2	2	779	450	0.25	120
3	10	952	550	0.25	120
4	20	1732	1000	0.25	120
5	20	4330	2500	0.25	120
6	88	5196	3000	0.25	80

DTN: MO0110SASWWHBS.000

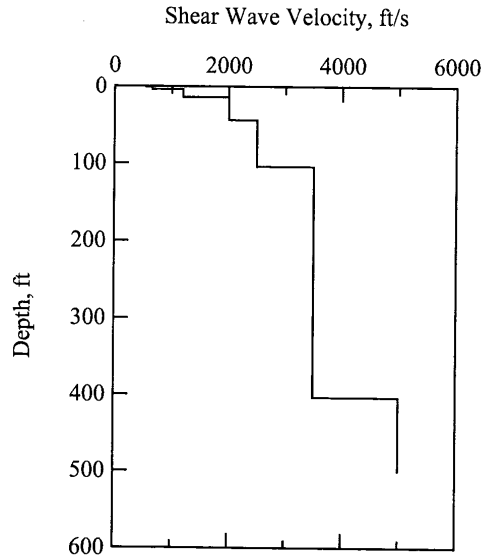
\* Poisson's ratio and mass density from Wong (2002c, Appendix 29)

Figure IX-29. SASW-29 Results (continued)

Corresponds to Boring RF#16



APPENDIX A – SEISMIC WAVE VELOCITY



DTN: MO0110SASWWHBS.000

c. SASW-32+35 Shear Wave Velocity Profile

Location: SASW-32+35

Layer No.	Thickness, ft	P-Wave Velocity, ft/s	S-Wave Velocity, ft/s	Poisson's Ratio*	Mass Density* pcf
1	1	953	550	0.25	120
2	3	1126	650	0.25	120
3	10	2079	1200	0.25	120
4	30	3464	2000	0.25	120
5	60	4330	2500	0.25	120
6	300	5543	3500	0.25	80
7	96	8660	5000	0.25	145

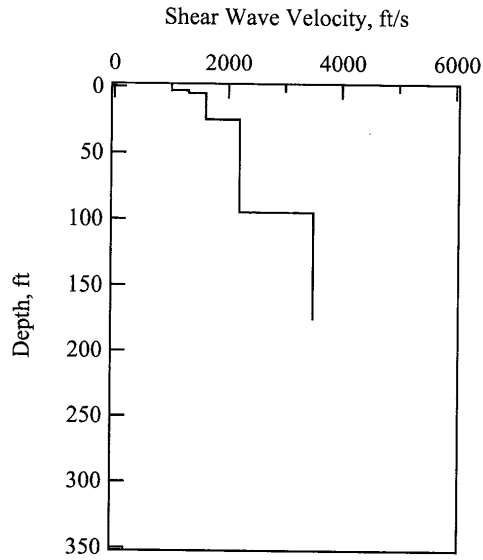
DTN: MO0110SASWWHBS.000

\* Poisson's ratio and mass density from Wong (2002c, Appendix 32)

Figure IX-32. SASW-32+35 Results (continued)

Corresponds to Boring RF#23

APPENDIX A – SEISMIC WAVE VELOCITY



DTN: MO0110SASWWHBS.000

c. SASW-33 Shear Wave Velocity Profile

Location: SASW-33

Layer No.	Thickness, ft	P-Wave Velocity, ft/s	S-Wave Velocity, ft/s	Poisson's Ratio*	Mass Density* pcf
1	3	1732	1000	0.25	120
2	2	2252	1300	0.25	120
3	20	2771	1600	0.25	120
4	70	3810	2200	0.25	120
5	80	6062	3500	0.25	80

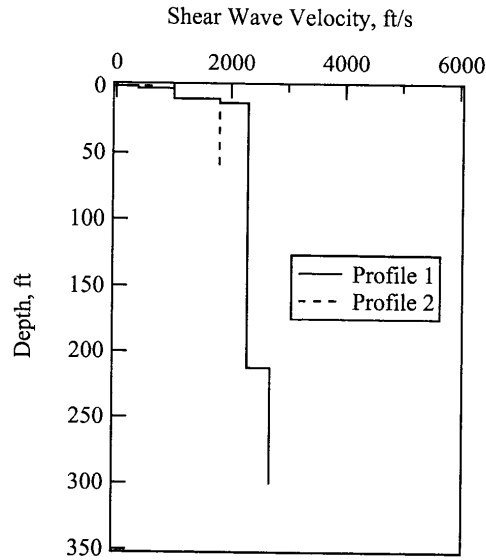
DTN: MO0110SASWWHBS.000

\* Poisson's ratio and mass density from Wong (2002c, Appendix 33)

Figure IX-33. SASW-33 Results (continued)

Corresponds to Boring RF#23

APPENDIX A – SEISMIC WAVE VELOCITY



DTN: MO0110SASWWHBS.000

c. SASW-34+36 Shear Wave Velocity Profile

Location: SASW-34+36 Profile 1

Layer No.	Thickness, ft	P-Wave Velocity, ft/s	S-Wave Velocity, ft/s	Poisson's Ratio*	Mass Density* pcf
1	1.5	650	375	0.25	120
2	8	1732	1000	0.25	120
3	3	3117	1800	0.25	120
4	200	3983	2300	0.25	120
5	88	4676	2700	0.25	120

Location: SASW-34+36 Profile 2

Layer No.	Thickness, ft	P-Wave Velocity, ft/s	S-Wave Velocity, ft/s	Poisson's Ratio*	Mass Density* pcf
1	1	650	375	0.25	120
2	8	1732	1000	0.25	120
3	51	3117	1800	0.25	120

DTN: MO0110SASWWHBS.000

\* Poisson's ratio and mass density from Wong (2002c, Appendix 34)

Figure IX-34. SASW-34+36 Results (continued)

Corresponds to Boring RF#17

APPENDIX A – SEISMIC WAVE VELOCITY

**A8.2 Soil Contact Depths (from BSC 2002a, based on DTN: GS030783114233.001)**

Table 4. WHB Area Boreholes with Contact Depths and Total Depths in Feet

Borehole	Fill	Qal	Tmbt1	Tpki	Tpbt5	Tpcrn	Tpcpul	Tpcpmn	Tpcpll	Tpcpln	Total Depth (ft)
RF#14 (core)		0.0		101.8	192.5	203.4	275.0	395.0	443.7	455.6	550.0
RF#15 (core)	0.0					6.5	78.0	196.0	242.4	256.6	330.0
RF#16 (core)	0.0	22.4		75.7	133.2	137.8	222.0	360.0	403.0	422.5	452.8
RF#17 (core)		0.0	92.4	287.2	348.4	368.9	478.0	587.3	637.6	653.2	667.8
RF#18 (cuttings)		0	60	65		204	292	425	470		493.6
RF#19 (cuttings)		0	120	280	410	420	510	635			645.2
RF#20 (cuttings)	0	28			98	102	127				160.0
RF#21 (cuttings)	0	5				115 <sup>(5)</sup>	165				192.2
RF#22 (cuttings/core)		0	80	318	415	438	530				540.6
RF#23 (cuttings)	0	12		76	92	95					159.1
RF#24 (cuttings)	0	10				30	110	230			268.0
RF#25 (cuttings)	0	10				70	125				159.0
RF#26 (cuttings)	0	14		85	204	211					264.9
RF#28 (cuttings)	0	5				15	70				99.8
RF#29 (cuttings)		0	85	280	370	380					430.0

\*Per Assumptions given in BSC 2002a and BSC 2002b, the following changes were implemented for the calculation herein:

- RF#20 – Qal contact depth at 9ft
- RF#21 – Qal contact depth at 70ft

Table 5. Revised Contact Depths and Total Depths in Feet in Borehole RF#13

Borehole	Fill	Qal	Tmbt1	Tpki	Tpbt5	Tpcrn	Tpcpu I	Tpcpmn	Tpcpll	Tpcpln	Total Depth
RF#13 (cored)	0.0	12.5		98.0	164.4	169.3	219.1	231.5	286.7	300.9	350.1

Notes: Contacts are given as the depths in feet to the tops of the units.  
 A blank cell means that the unit was not encountered.

(per GS030783114233.001)

**A8.3 EXCEL Spreadsheets**

Attached are the EXCEL spreadsheets used to average the alluvium, existing fill, and rock materials for the analysis contained herein.

APPENDIX A - SEISMIC WAVE VELOCITY

Borehole #		13		Redpath (Downhole) UT Austin (SASW)								
Interval	Material	Depth (ft)	Thickness, d (ft)	Shear Wave Velocity, Vs (ft/s)					Compression Wave Velocity, Vp (ft/s)			
				Downhole	Vs x d	Avg	SASW	Vs x d	Avg	Downhole	Vs x d	Avg
	Fill	1	1				500	500				
	Fill	3	2				600	1200				
	Fill	5	2	750	1500		600	1200		1455	2910	
	Fill	9	4	750	3000		700	2800		1455	5820	
	Fill	10	1	750	750		1400	1400		3405	3405	
	Fill	12.5	2.5	1355	3387.5	<b>909</b>	1400	3500	<b>848</b>	3405	8512.5	<b>2173</b>
	Qal	15	2.5	1355	3387.5		1400	3500		3405	8512.5	
	Qal	25	10	1355	13550		1400	14000		3405	34050	
	Qal	26	1	2030	2030		1400	1400		3405	3405	
	Qal	29	3	2030	6090		1400	4200		4685	14055	
2	Qal	30	1	2030	2030	<b>1580</b>	2200	2200	<b>1453</b>	4685	4685	<b>3746</b>
3	Qal	60	30	2030	60900	<b>2030</b>	2200	66000	<b>2200</b>	4685	140550	<b>4685</b>
	Qal	69	9	2030	18270		2200	19800		4685	42165	
	Qal	80	11	2030	22330		3500	38500		4685	51535	
4	Qal	98	18	2740	49320	<b>2366</b>	3500	63000	<b>3192</b>	4685	84330	<b>4685</b>
	Tpki	164.4	66.4	2740	181936	<b>2740</b>	3500	232400	<b>3500</b>	4685	311084	<b>4685</b>
	Tpbt5	169.3	4.9	2740	13426	<b>2740</b>	3500	17150	<b>3500</b>	4685	22956.5	<b>4685</b>
	Tpcrn	200	30.7	2740	84118		3500	107450	<b>3500</b>	4685	143830	
	Tpcrn	219.1	19.1	2740	52334	<b>2740</b>				4685	89483.5	<b>4685</b>
	Tpcpul	226	6.9	2740	18906					4685	32326.5	
	Tpcpul	230	4	2740	10960					9335	37340	
	Tpcpul	231.5	1.5	5800	8700	<b>3110</b>				9335	14002.5	<b>6748</b>
	Tpcpmn	286.7	55.2	5800	320160	<b>5800</b>				9335	515292	<b>9335</b>
	Tpcpll	300.9	14.2	5800	82360	<b>5800</b>				9335	132557	<b>9335</b>
	Tpcpln	345	44.1	5800	255780	<b>5800</b>				9335	411674	<b>9335</b>
	Tpcpln	350.1	5.1									
				<b>ALL ROCK TOTAL</b>		<b>4080</b>			<b>3500</b>	<b>6785</b>		
				<b>UPPER ROCK TOTAL</b>		<b>2774</b>			<b>3500</b>	<b>4877</b>		
				<b>LOWER ROCK TOTAL</b>		<b>5800</b>			<b>NA</b>	<b>9335</b>		

Notes:

1. Average Seismic Velocity = Sum of (Velocity x Thickness) / Sum of Thickness for each soil/rock layer
2. Qal is divided into 4 intervals - (1) 0-15', (2) 15-30', (3) 30-60', and (4) 60-100'

APPENDIX A - SEISMIC WAVE VELOCITY

Borehole # 13 GEOVision (Downhole)

Qal Interval	Material	Depth (ft)	Thickness, d (ft)	Shear Wave Velocity, Vs (ft/s)						Compression Wave Velocity, Vp (ft/s)		
				Downhole	Vs x d	Avg	SASW	Vs x d	Avg	Downhole	Vs x d	Avg
		0		NA								
	Fill	12.5	12.5	1090	13625	<b>1090</b>				2110	26375	<b>2110</b>
1	Qal	15	2.5	1090	2725					2110	5275	
2	Qal	30	15	1960	29400	<b>1960</b>				3700	55500	<b>3700</b>
	Qal	36	6	1960	11760					3700	22200	
3	Qal	60	24	2490	59760	<b>2384</b>				3970	95280	<b>3916</b>
4	Qal	98	38	2490	94620	<b>2490</b>				3970	150860	<b>3970</b>
	Tpki	99	1	2490	2490					3970	3970	
	Tpki	100	1	2810	2810					4900	4900	
	Tpki	164.4	64.4	2810	180964	<b>2805</b>				4900	315560	<b>4886</b>
	Tpbt5	169.3	4.9	2810	13769	<b>2810</b>				4900	24010	<b>4900</b>
	Tpcrn	215	45.7	2810	128417					4900	223930	
	Tpcrn	219.1	4.1	6490	26609	<b>3113</b>				11180	45838	<b>5417</b>
	Tpcpul	231.5	12.4	6490	80476	<b>6490</b>				11180	138632	<b>11180</b>
	Tpcpmn	286.7	55.2	6490	358248	<b>6490</b>				11180	617136	<b>11180</b>
	Tpcpll	300.9	14.2	6490	92158	<b>6490</b>				11180	158756	<b>11180</b>
	Tpcpln	345	44.1	6490	286209	<b>6490</b>				11180	493038	<b>11180</b>
	Tpcpln	350.1	5.1									
				<b>ALL ROCK TOTAL</b>		<b>4746</b>				<b>NA</b>		<b>8201</b>
				<b>UPPER ROCK TOTAL</b>		<b>3262</b>				<b>NA</b>		<b>5669</b>
				<b>LOWER ROCK TOTAL</b>		<b>6490</b>				<b>NA</b>		<b>11180</b>

Notes:

1. Average Seismic Velocity = Sum of (Velocity x Thickness) / Sum of Thickness for each soil/rock layer
2. Qal is divided into 4 intervals - (1) 0-15', (2) 15-30', (3) 30-60', and (4) 60-100'

APPENDIX A - SEISMIC WAVE VELOCITY

Borehole # 14 Redpath (Downhole)

Interval	Qal	Material	Depth (ft)	Thickness, d (ft)	Shear Wave Velocity, Vs (ft/s)					Compression Wave Velocity, Vp (ft/s)			
					Downhole	Vs x d	Avg	SASW	Vs x d	Avg	Downhole	Vs x d	Avg
	Qal		3				NA						
	Qal		5	2	1240	2480							
	Qal		6	1	1240	1240							
	Qal		12	6	1240	7440				2530	15180		
1	Qal		15	3	1240	3720	<b>1240</b>			3805	11415	<b>2955</b>	
2	Qal		30	15	1700	25500	<b>1700</b>			3805	57075	<b>3805</b>	
	Qal		38	8	1700	13600				3805	30440		
3	Qal		60	22	2375	52250	<b>2195</b>			4300	94600	<b>4168</b>	
4	Qal		100	40	2375	95000	<b>2375</b>			4300	172000	<b>4300</b>	
	Qal		101.8	1.8	2375	4275				4300	7740		
	Tpki		110	8.2	2375	19475				4300	35260		
	Tpki		114	4	2375	9500				5900	23600		
	Tpki		165	51	3390	172890				5900	300900		
	Tpki		192.5	27.5	2640	72600	<b>3091</b>			5900	162250	<b>5900</b>	
	Tpbt5		203.4	10.9	2640	28776	<b>2640</b>			5900	64310	<b>5900</b>	
	Tpcrn		275	71.6	2640	189024	<b>2640</b>			5900	422440	<b>5900</b>	
	Tpcpul		304	29	2640	76560				5900	171100		
	Tpcpul		305	1	2640	2640				7500	7500		
	Tpcpul		395	90	5000	450000	<b>4410</b>			7500	675000	<b>7113</b>	
	Tpcpmn		420	25	5000	125000				7500	187500		
	Tpcpmn		443.7	23.7	5000	118500	<b>5000</b>			11000	260700	<b>9203</b>	
	Tpcpll		455.6	11.9	5000	59500	<b>5000</b>			11000	130900	<b>11000</b>	
	Tpcpln		520	64.4	5000	322000	<b>5000</b>			11000	708400	<b>11000</b>	
	Tpcpln		550	30									
					<b>ALL ROCK TOTAL</b>			<b>3937</b>		<b>NA</b>			<b>7532</b>
					<b>UPPER ROCK TOTAL</b>			<b>3484</b>		<b>NA</b>			<b>6352</b>
					<b>LOWER ROCK TOTAL</b>			<b>5000</b>		<b>NA</b>			<b>10300</b>

Notes:

1. Average Seismic Velocity = Sum of (Velocity x Thickness) / Sum of Thickness for each soil/rock layer
2. Qal is divided into 4 intervals - (1) 0-15', (2) 15-30', (3) 30-60', and (4) 60-100'

APPENDIX A - SEISMIC WAVE VELOCITY

Borehole #		15		Redpath (Downhole) UT Austin (SASW)									
Qal	Material	Depth	Thickness, d	Shear Wave Velocity, Vs (ft/s)					Compression Wave Velocity, Vp (ft/s)				
Interval		(ft)	(ft)	Downhole	Vs x d	Avg	SASW	Vs x d	Avg	Downhole	Vs x d	Avg	
	Fill	1	1				1300	1300					
	Fill	3	2				1300	2600					
	Fill	5	2	1935	3870		1300	2600		3215	6430		
	Fill	6.5	1.5	1935	2902.5	<b>1935</b>	1300	1950	<b>1300</b>	3215	4822.5	<b>3215</b>	
	Tpcrn	9	2.5	1935	4837.5		1300	3250		3215	8037.5		
	Tpcrn	14	5	1935	9675		1600	8000		3215	16075		
	Tpcrn	15	1	1935	1935		2200	2200		3215	3215		
	Tpcrn	18	3	1935	5805		2200	6600		3215	9645		
	Tpcrn	30	12	1935	23220		2200	26400		3815	45780		
	Tpcrn	34	4	1935	7740		2200	8800		3815	15260		
	Tpcrn	38	4	1935	7740		3300	13200		3815	15260		
	Tpcrn	39	1	2700	2700		3300	3300		3815	3815		
	Tpcrn	60	21	2700	56700		3300	69300		4600	96600		
	Tpcrn	78	18	2700	48600	<b>2363</b>	3300	59400	<b>2803</b>	4600	82800	<b>4147</b>	
	Tpcpul	100	22	2700	59400		3300	72600		4600	101200		
	Tpcpul	122	22	2700	59400	<b>2700</b>	3300	72600		4600	101200		
	Tpcpul	133	11	3380	37180		3300	36300		4600	50600		
	Tpcpul	184	51	3380	172380		3300	168300		9850	502350		
	Tpcpul	196	12	3380	40560	<b>3126</b>	5000	60000	<b>3473</b>	9850	118200	<b>7403</b>	
	Tpcpmn	210	14	3380	47320		5000	70000		9850	137900		
	Tpcpmn	230	20	3380	67600		5000	100000		14000	280000		
	Tpcpmn	242.4	12.4	5900	73160	<b>4053</b>	5000	62000	<b>5000</b>	14000	173600	<b>12748</b>	
	Tpcpll	250	7.6	5900	44840		5000	38000	<b>5000</b>	14000	106400		
	Tpcpll	256.6	6.6	5900	38940	<b>5900</b>				14000	92400	<b>14000</b>	
	Tpcpln	320	63.4	5900	374060	<b>5900</b>				14000	887600	<b>14000</b>	
	Tpcpln	330	10										
				<b>ALL ROCK TOTAL</b>					<b>3776</b>		<b>3615</b>		<b>9084</b>
				<b>UPPER ROCK TOTAL</b>					<b>2838</b>		<b>3220</b>		<b>6174</b>
				<b>LOWER ROCK TOTAL</b>					<b>5209</b>		<b>5000</b>		<b>13531</b>

Notes:

- Average Seismic Velocity = Sum of (Velocity x Thickness) / Sum of Thickness for each soil/rock layer
- Qal is divided into 4 intervals - (1) 0-15', (2) 15-30', (3) 30-60', and (4) 60-100'





APPENDIX A - SEISMIC WAVE VELOCITY

Borehole # 17 GEOVision (Downhole)  
 UT Austin (SASW)

Interval	Material	Depth (ft)	Thickness, d (ft)	Shear Wave Velocity, Vs (ft/s)					Compression Wave Velocity, Vp (ft/s)			
				Downhole	Vs x d	Avg	SASW	Vs x d	Avg	Downhole	Vs x d	Avg
	Qal	1.5	1.5	1210	1815		375	562.5		2510	3765	
	Qal	5	3.5	1210	4235		1000	3500		2510	8785	
	Qal	9.5	4.5	1210	5445		1000	4500		2510	11295	
	Qal	12.5	3	1210	3630		1800	5400		2510	7530	
1	Qal	15	2.5	1210	3025	<b>1210</b>	2300	5750	<b>1565</b>	2510	6275	<b>2510</b>
2	Qal	30	15	1880	28200	<b>1880</b>	2300	34500	<b>2300</b>	4160	62400	<b>4160</b>
3	Qal	60	30	2490	74700	<b>2490</b>	2300	69000	<b>2300</b>	4060	121800	<b>4060</b>
4	Qal	92.4	32.4	2490	80676	<b>2490</b>	2300	74520	<b>2300</b>	4060	131544	<b>4060</b>
	Tmbt1	100	7.6	2490	18924		2300	17480		4060	30856	
	Tmbt1	212.5	112.5	3160	355500		2300	258750		5580	627750	
	Tmbt1	287.2	74.7	3160	236052	<b>3134</b>	2700	201690	<b>2453</b>	5580	416826	<b>5521</b>
	Tpki	300.5	13.3	3160	42028		2700	35910	<b>2700</b>	5580	74214	
	Tpki	348.4	47.9	3160	151364	<b>3160</b>				5580	267282	<b>5580</b>
	Tpbt5	368.9	20.5	3160	64780	<b>3160</b>				5580	114390	<b>5580</b>
	Tpcrn	400	31.1	3160	98276					5580	173538	
	Tpcrn	478	78	3890	303420	<b>3890</b>				7190	560820	<b>6731</b>
	Tpcpul	500	22	3890	85580					7190	158180	
	Tpcpul	587.3	87.3	4520	394596	<b>4393</b>				10210	891333	<b>9602</b>
	Tpcpmn	620	32.7	4520	147804	<b>4520</b>				10210	333867	<b>10210</b>
	Tpcpmn	637.6	17.6									
	Tpcpll	653.2	15.6									
	Tpcpln	667.8	14.6									
				<b>ALL ROCK TOTAL</b>		<b>3598</b>			<b>2469</b>	<b>6916</b>		
				<b>UPPER ROCK TOTAL</b>		<b>3537</b>			<b>2469</b>	<b>6699</b>		
				<b>LOWER ROCK TOTAL</b>		<b>4520</b>			<b>NA</b>	<b>10210</b>		

Notes:

1. Average Seismic Velocity = Sum of (Velocity x Thickness) / Sum of Thickness for each soil/rock layer
2. Qal is divided into 4 intervals - (1) 0-15', (2) 15-30', (3) 30-60', and (4) 60-100'



APPENDIX A - SEISMIC WAVE VELOCITY

Borehole # 18 Redpath (Downhole)

Interval	Qal	Material	Depth (ft)	Thickness, d (ft)	Shear Wave Velocity, Vs (ft/s)					Compression Wave Velocity, Vp (ft/s)			
					Downhole	Vs x d	Avg	SASW	Vs x d	Avg	Downhole	Vs x d	Avg
	Qal		3	3				NA					
1	Qal		5	2	1435	2870					3305	6610	
	Qal		15	10	1435	14350	<b>1435</b>				3305	33050	<b>3305</b>
	Qal		24	9	1435	12915					3305	29745	
2	Qal		30	6	1670	10020	<b>1529</b>				3305	19830	<b>3305</b>
	Qal		48	18	1670	30060					3305	59490	
3	Qal		60	12	2900	34800	<b>2162</b>				4600	55200	<b>3823</b>
	Tmbt1		65	5	2900	14500	<b>2900</b>				4600	23000	<b>4600</b>
	Tpki		78	13	2900	37700					4600	59800	
	Tpki		100	22	3860	84920					5850	128700	
	Tpki		204	104	3860	401440	<b>3770</b>				5850	608400	<b>5733</b>
	Tpcrn		220	16	3860	61760					5850	93600	
	Tpcrn		250	30	2400	72000					5850	175500	
	Tpcrn		290	40	4200	168000					5850	234000	
	Tpcrn		292	2	4200	8400	<b>3525</b>				7200	14400	<b>5881</b>
	Tpcpul		390	98	4200	411600	<b>4200</b>				7200	705600	
	Tpcpul		425	35	4200	147000	<b>4200</b>				8300	290500	<b>7489</b>
	Tpcpmn		470	45	4200	189000	<b>4200</b>				8300	373500	<b>8300</b>
	Tpcpll		480	10	4200	42000	<b>4200</b>				8300	83000	<b>8300</b>
	Tpcpll		485	5							8300		
	Tpcpll		493.6	8.6									
					<b>ALL ROCK TOTAL</b>			<b>3901</b>		<b>NA</b>	<b>6643</b>		
					<b>UPPER ROCK TOTAL</b>			<b>3856</b>		<b>NA</b>	<b>6393</b>		
					<b>LOWER ROCK TOTAL</b>			<b>4200</b>		<b>NA</b>	<b>8300</b>		

Notes:

1. Average Seismic Velocity = Sum of (Velocity x Thickness) / Sum of Thickness for each soil/rock layer
2. Qal is divided into 4 intervals - (1) 0-15', (2) 15-30', (3) 30-60', and (4) 60-100'

APPENDIX A - SEISMIC WAVE VELOCITY

Borehole # 19 Redpath (Downhole)

Interval	Qal	Material	Depth (ft)	Thickness, d (ft)	Shear Wave Velocity, Vs (ft/s)					Compression Wave Velocity, Vp (ft/s)				
					Downhole	Vs x d	Avg	SASW	Vs x d	Avg	Downhole	Vs x d	Avg	
	Qal		3	3				NA						
	Qal		5	2	1285	2570					1710	3420		
	Qal		9	4	1285	5140					1710	6840		
1	Qal		15	6	1285	7710	<b>1285</b>				3440	20640	<b>2748</b>	
	Qal		18	3	1285	3855					3440	10320		
2	Qal		30	12	1810	21720	<b>1705</b>				3440	41280	<b>3440</b>	
	Qal		39	9	1810	16290					3440	30960		
3	Qal		60	21	2305	48405	<b>2157</b>				3950	82950	<b>3797</b>	
	Qal		96	36	2305	82980					3950	142200		
4	Qal		100	4	2740	10960	<b>2349</b>				3950	15800	<b>3950</b>	
	Qal		104	4	2740	10960					3950	15800		
	Qal		120	16	2740	43840					5000	80000		
	Tmbt1		280	160	2740	438400	<b>2740</b>				5000	800000	<b>5000</b>	
	Tpki		282	2	2740	5480					5000	10000		
	Tpki		294	12	3780	45360					5000	60000		
	Tpki		410	116	3780	438480	<b>3780</b>				6350	736600	<b>6205</b>	
	Tpbt5		420	10	3780	37800	<b>3780</b>				6350	63500	<b>6350</b>	
	Tpcrn		510	90	3780	340200	<b>3780</b>				6350	571500	<b>6350</b>	
	Tpcpul		550	40	3780	151200					6350	254000		
	Tpcpul		635	85	4250	361250	<b>4100</b>				6350	539750	<b>6350</b>	
	Tpcpmn		640	5	4250	21250	<b>4250</b>				6350	31750	<b>6350</b>	
	Tpcpmn		645.2	5.2										
							<b>ALL ROCK TOTAL</b>	<b>3537</b>			<b>NA</b>		<b>5898</b>	
							<b>UPPER ROCK TOTAL</b>	<b>3530</b>			<b>NA</b>		<b>5894</b>	
							<b>LOWER ROCK TOTAL</b>	<b>4250</b>			<b>NA</b>		<b>6350</b>	

Notes:

1. Average Seismic Velocity = Sum of (Velocity x Thickness) / Sum of Thickness for each soil/rock layer
2. Qal is divided into 4 intervals - (1) 0-15', (2) 15-30', (3) 30-60', and (4) 60-100'

APPENDIX A - SEISMIC WAVE VELOCITY

Borehole # 20 Redpath (Downhole)

Interval	Material	Depth (ft)	Thickness, d (ft)	Shear Wave Velocity, Vs (ft/s)						Compression Wave Velocity, Vp (ft/s)			
				Downhole	Vs x d	Avg	SASW	Vs x d	Avg	Downhole	Vs x d	Avg	
	Fill	3	3				NA						
	Fill	5	2	1200	2400					1935	3870		
	Fill	9	4	1200	4800	1200				1935	7740	1935	
1	Qal	13	4	1200	4800					1935	7740		
	Qal	15	2	1200	2400	1200				3540	7080	2470	
2	Qal	24	9	1200	10800					3540	31860		
	Qal	30	6	2020	12120	1528				3540	21240	3540	
3	Qal	60	30	2020	60600	2020				3540	106200	3540	
4	Qal	70	10	2020	20200					3540	35400		
	Qal	98	28	2800	78400	2595				4320	120960	4115	
	Tpbt5	100	2	2800	5600					4320	8640		
	Tpbt5	102	2	2800	5600	2800				4320	8640	4320	
	Tpcrn	127	25	2800	70000	2800				4320	108000	4320	
	Tpcpul	155	28	2800	78400	2800				4320	120960	4320	
	Tpcpul	160	5										
				<b>ALL ROCK TOTAL</b>		<b>2800</b>				<b>NA</b>			<b>4320</b>
				<b>UPPER ROCK TOTAL</b>		<b>2800</b>				<b>NA</b>			<b>4320</b>
				<b>LOWER ROCK TOTAL</b>		<b>NA</b>				<b>NA</b>			<b>NA</b>

Notes:

1. Average Seismic Velocity = Sum of (Velocity x Thickness) / Sum of Thickness for each soil/rock layer
2. Qal is divided into 4 intervals - (1) 0-15', (2) 15-30', (3) 30-60', and (4) 60-100'

APPENDIX A - SEISMIC WAVE VELOCITY

Borehole # 21 Redpath (Downhole)  
 UT Austin (SASW)

Interval	Material	Depth (ft)	Thickness, d (ft)	Shear Wave Velocity, Vs (ft/s)						Compression Wave Velocity, Vp (ft/s)		
				Downhole	Vs x d	Avg	SASW	Vs x d	Avg	Downhole	Vs x d	Avg
	Fill	1	1				600	600				
	Fill	3	2				1300	2600				
	Fill	5	2	1310	2620	1310	1300	2600	1160	2845	5690	2845
1	Qal	6	1	1310	1310		1300	1300		2845	2845	
	Qal	15	9	1310	11790	1310	1600	14400	1570	2845	25605	2845
2	Qal	20	5	1310	6550		1600	8000		2845	14225	
	Qal	21	1	1930	1930		1600	1600		2845	2845	
	Qal	30	9	1930	17370	1723	2500	22500	2140	2845	25605	2845
3	Qal	57	27	1930	52110		2500	67500		2845	76815	
	Qal	60	3	1930	5790	1930	2500	7500	2500	3900	11700	2951
	Qal	70	10	1930	19300		2500	25000		3900	39000	
	Tpcrn	84	14	1930	27020		2500	35000		3900	54600	
	Tpcrn	96	12	2500	30000		2500	30000		3900	46800	
	Tpcrn	100	4	2500	10000		2500	10000		3900	15600	
	Tpcrn	120	20	2500	50000		2500	50000	2500	3900	78000	
	Tpcrn	165	45	2500	112500	2500				4850	218250	4350
	Tpcpul	185	20	2500	50000	2500				4850	97000	4850
	Tpcpul	192.2	7.2									
				<b>ALL ROCK TOTAL</b>		<b>2431</b>			<b>2500</b>			<b>4437</b>
				<b>UPPER ROCK TOTAL</b>		<b>2431</b>			<b>2500</b>			<b>4437</b>
				<b>LOWER ROCK TOTAL</b>		<b>NA</b>			<b>NA</b>			<b>NA</b>

Notes:

1. Average Seismic Velocity = Sum of (Velocity x Thickness) / Sum of Thickness for each soil/rock layer
2. Qal is divided into 4 intervals - (1) 0-15', (2) 15-30', (3) 30-60', and (4) 60-100'

APPENDIX A - SEISMIC WAVE VELOCITY

Borehole #		22		Redpath (Downhole) UT Austin (SASW)									
Qal	Material	Depth	Thickness, d	Shear Wave Velocity, Vs (ft/s)					Compression Wave Velocity, Vp (ft/s)				
Interval		(ft)	(ft)	Downhole	Vs x d	Avg	SASW	Vs x d	Avg	Downhole	Vs x d	Avg	
	Qal	1	1				500	500					
	Qal	3	2				900	1800					
	Qal	5	2	1465	2930		900	1800		2445	4890		
1	Qal	15	10	1465	14650	<b>1465</b>	2200	22000	<b>2200</b>	2445	24450	<b>2445</b>	
	Qal	21	6	1465	8790		2200	13200		2445	14670		
	Qal	24	3	2200	6600		2200	6600		2445	7335		
2	Qal	30	6	2200	13200	<b>1906</b>	2200	13200	<b>2200</b>	4185	25110	<b>3141</b>	
3	Qal	60	30	2200	66000	<b>2200</b>	2200	66000	<b>2200</b>	4185	125550	<b>4185</b>	
	Qal	70	10	2200	22000		2200	22000		4185	41850		
4	Qal	80	10	2200	22000	<b>2200</b>	2200	22000	<b>2200</b>	4185	41850	<b>4185</b>	
	Tmbt1	83	3	2200	6600		2200	6600		4185	12555		
	Tmbt1	87	4	3540	14160		2200	8800		4185	16740		
	Tmbt1	100	13	3540	46020		2200	28600		5560	72280		
	Tmbt1	120	20	3540	70800		2200	44000		5560	111200		
	Tmbt1	175	55	3540	194700		3500	192500		5560	305800		
	Tmbt1	180	5	1400	7000	<b>1400</b>	3500	17500	<b>2980</b>	5560	27800		
	Tmbt1	192	12	1400	16800					5560	66720		
	Tmbt1	318	126	3500	441000	<b>3349</b>				5560	700560	<b>5520</b>	
	Tpki	415	97	3500	339500	<b>3393</b>				5560	539320	<b>5560</b>	
	Tpbt5	438	23	3500	80500	<b>3500</b>				5560	127880	<b>5560</b>	
	Tpcrn	500	62	3500	217000	<b>3500</b>				5560	344720		
	Tpcrn	505	5							5560	27800	<b>5560</b>	
	Tpcrn	530	25										
	Tpcpul	540.6	10.6										
				<b>ALL ROCK TOTAL</b>		<b>3414</b>			<b>2980</b>	<b>5537</b>			
				<b>UPPER ROCK TOTAL</b>		<b>3414</b>			<b>2980</b>	<b>5537</b>			
				<b>LOWER ROCK TOTAL</b>		<b>NA</b>			<b>NA</b>	<b>NA</b>			

Notes:

1. Average Seismic Velocity = Sum of (Velocity x Thickness) / Sum of Thickness for each soil/rock layer
2. Qal is divided into 4 intervals - (1) 0-15', (2) 15-30', (3) 30-60', and (4) 60-100'



APPENDIX A - SEISMIC WAVE VELOCITY

Borehole #		23		Redpath (Downhole) UT Austin (SASW)								
Qal	Material	Depth	Thickness, d	Shear Wave Velocity, Vs (ft/s)					Compression Wave Velocity, Vp (ft/s)			
Interval		(ft)	(ft)	Downhole	Vs x d	Avg	SASW	Vs x d	Avg	Downhole	Vs x d	Avg
	Fill	1	1				550	550				
	Fill	3	2				650	1300				
	Fill	4	1	690	690		650	650		2000	2000	
	Fill	5	1	690	690		1200	1200		2000	2000	
	Fill	9	4	690	2760		1200	4800		2000	8000	
	Fill	12	3	1565	4695	<b>982</b>	1200	3600	<b>1008.3</b>	2000	6000	<b>2000</b>
	Qal	14	2	1565	3130		1200	2400		2000	4000	
	Qal	15	1	1565	1565		2000	2000		2000	2000	
	Qal	18	3	1565	4695		2000	6000		2000	6000	
	Qal	21	3	1565	4695		2000	6000		3765	11295	
2	Qal	30	9	2100	18900	<b>1886</b>	2000	18000	<b>2000</b>	3765	33885	<b>3412</b>
	Qal	44	14	2100	29400		2000	28000		3765	52710	
3	Qal	60	16	2100	33600	<b>2100</b>	2500	40000	<b>2267</b>	3765	60240	<b>3765</b>
	Qal	72	12	2100	25200		2500	30000		3765	45180	
	Qal	76	4	2865	11460		2500	10000		4700	18800	
	Tpki	92	16	2865	45840	<b>2865</b>	2500	40000	<b>2500</b>	4700	75200	<b>4700</b>
	Tpbt5	95	3	2865	8595	<b>2865</b>	2500	7500	<b>2500</b>	4700	14100	<b>4700</b>
	Tpcrn	100	5	2865	14325		2500	12500		4700	23500	
	Tpcrn	104	4	2865	11460		2500	10000		4700	18800	
	Tpcrn	110	6	2865	17190		3500	21000		4700	28200	
	Tpcrn	120	10	3600	36000		3500	35000		4700	47000	
	Tpcrn	155	35	3600	126000	<b>3416</b>	3500	122500		5500	192500	<b>5167</b>
	Tpcrn	159.1	4.1				3500	14350	<b>3360</b>			
		404	244.9				3500	857150				
		500	96				5000	480000				
				<b>ALL ROCK TOTAL</b>		<b>3284</b>			<b>3163</b>	<b>5054</b>		
				<b>UPPER ROCK TOTAL</b>		<b>3284</b>			<b>3163</b>	<b>5054</b>		
				<b>LOWER ROCK TOTAL</b>		<b>NA</b>			<b>NA</b>	<b>NA</b>		

Notes:

1. Average Seismic Velocity = Sum of (Velocity x Thickness) / Sum of Thickness for each soil/rock layer
2. Qal is divided into 4 intervals - (1) 0-15', (2) 15-30', (3) 30-60', and (4) 60-100'

APPENDIX A - SEISMIC WAVE VELOCITY

Borehole # 24 Redpath (Downhole)

Interval	Qal	Material	Depth (ft)	Thickness, d (ft)	Shear Wave Velocity, Vs (ft/s)					Compression Wave Velocity, Vp (ft/s)				
					Downhole	Vs x d	Avg	SASW	Vs x d	Avg	Downhole	Vs x d	Avg	
		Fill	3	3				NA						
		Fill	5	2	1195	2390					1425	2850		
		Fill	10	5	1195	5975	<b>1195</b>				1425	7125	<b>1425</b>	
1		Qal	12	2	1195	2390					1425	2850		
		Qal	15	3	1195	3585	<b>1195</b>				2785	8355	<b>2241</b>	
2		Qal	18	3	1195	3585					2785	8355		
		Qal	30	12	1535	18420	<b>1467</b>				2785	33420	<b>2785</b>	
		Tpcrn	33	3	1535	4605					2785	8355		
		Tpcrn	60	27	2070	55890					4960	133920		
		Tpcrn	100	40	2070	82800					4960	198400		
		Tpcrn	110	10	2070	20700	<b>2050</b>				4960	49600	<b>4878</b>	
		Tpcpul	230	120	2070	248400	<b>2070</b>				4960	595200	<b>4960</b>	
		Tpcpmn	260	30	2070	62100	<b>2070</b>				4960	148800	<b>4960</b>	
		Tpcpmn	268	8										
					<b>ALL ROCK TOTAL</b>		<b>2063</b>			<b>NA</b>			<b>4932</b>	
					<b>UPPER ROCK TOTAL</b>		<b>2062</b>			<b>NA</b>			<b>4927</b>	
					<b>LOWER ROCK TOTAL</b>		<b>2070</b>			<b>NA</b>			<b>4960</b>	

Notes:

1. Average Seismic Velocity = Sum of (Velocity x Thickness) / Sum of Thickness for each soil/rock layer
2. Qal is divided into 4 intervals - (1) 0-15', (2) 15-30', (3) 30-60', and (4) 60-100'

APPENDIX A - SEISMIC WAVE VELOCITY

Borehole #		26		Redpath (Downhole) UT Austin (SASW)								
Qal	Material	Depth	Thickness, d	Shear Wave Velocity, Vs (ft/s)						Compression Wave Velocity, Vp (ft/s)		
Interval		(ft)	(ft)	Downhole	Vs x d	Avg	SASW	Vs x d	Avg	Downhole	Vs x d	Avg
	Fill	1	1				300	300				
	Fill	3	2				450	900				
	Fill	5	2	465	930		450	900		840	1680	
	Fill	10	5	465	2325		450	2250		840	4200	
	Fill	11	1	465	465		450	450		4115	4115	
	Fill	12	1	465	465		1000	1000		4115	4115	
	Fill	14	2	1745	3490	<b>698</b>	1000	2000	<b>557</b>	4115	8230	<b>2031</b>
	Qal	15	1	1745	1745		1000	1000		4115	4115	
2	Qal	30	15	1745	26175	<b>1745</b>	1000	15000	<b>1000</b>	4115	61725	<b>4115</b>
	Qal	31	1	1745	1745		1000	1000		4115	4115	
	Qal	46	15	1745	26175		2500	37500		4115	61725	
	Qal	51	5	2550	12750		2500	12500		4115	20575	
3	Qal	60	9	2550	22950	<b>2121</b>	3000	27000	<b>2600</b>	4115	37035	<b>4115</b>
4	Qal	85	25	2550	63750	<b>2550</b>	3000	75000	<b>3000</b>	4115	102875	<b>4115</b>
	Tpki	95	10	2550	25500		3000	30000		4115	41150	
	Tpki	100	5	3780	18900	<b>3780</b>	3000	15000		7030	35150	
	Tpki	101	1	3780	3780		3000	3000	<b>3000</b>	7030	7030	
	Tpki	140	39	3780	147420					7030	274170	
	Tpki	204	64	3780	241920	<b>3677</b>				5750	368000	<b>6097</b>
	Tpbt5	211	7	3780	26460	<b>3780</b>				5750	40250	<b>5750</b>
	Tpcrn	260	49	3780	185220	<b>3780</b>				5750	281750	<b>5750</b>
	Tpcrn	264.9	4.9									
				<b>ALL ROCK TOTAL</b>		<b>3710</b>			<b>3000</b>			<b>5986</b>
				<b>UPPER ROCK TOTAL</b>		<b>3710</b>			<b>3000</b>			<b>5986</b>
				<b>LOWER ROCK TOTAL</b>		<b>NA</b>			<b>NA</b>			<b>NA</b>

Notes:

1. Average Seismic Velocity = Sum of (Velocity x Thickness) / Sum of Thickness for each soil/rock layer
2. Qal is divided into 4 intervals - (1) 0-15', (2) 15-30', (3) 30-60', and (4) 60-100'

APPENDIX A - SEISMIC WAVE VELOCITY

Borehole # 25 Redpath (Downhole)

Interval	Qal	Material	Depth (ft)	Thickness, d (ft)	Shear Wave Velocity, Vs (ft/s)					Compression Wave Velocity, Vp (ft/s)				
					Downhole	Vs x d	Avg	SASW	Vs x d	Avg	Downhole	Vs x d	Avg	
		Fill	3	3				NA						
		Fill	5	2	1645	3290					2710	5420		
		Fill	10	5	1645	8225	<b>1645</b>				2710	13550	<b>2710</b>	
1	Qal		15	5	1645	8225	<b>1645</b>				2710	13550	<b>2710</b>	
2	Qal		30	15	1645	24675	<b>1645</b>				2710	40650	<b>2710</b>	
	Qal		37	7	1645	11515					2710	18970		
	Qal		41	4	2940	11760					2710	10840		
3	Qal		60	19	2940	55860	<b>2638</b>				4840	91960	<b>4059</b>	
	Qal		70	10	2940	29400					4840	48400		
		Tpcrn	86	16	2940	47040					4840	77440		
		Tpcrn	100	14	2100	29400					3400	47600		
		Tpcrn	105	5	2100	10500					3400	17000		
		Tpcrn	125	20	2100	42000	<b>2344</b>				4800	96000	<b>4328</b>	
		Tpcpul	155	30	2100	63000	<b>2100</b>				4800	144000	<b>4800</b>	
		Tpcpul	159	4										
					#DIV/0!									
					ALL ROCK TOTAL					2258	NA	4495		
					UPPER ROCK TOTAL					2258	NA	4495		
					LOWER ROCK TOTAL					NA	NA	NA		

Notes:

1. Average Seismic Velocity = Sum of (Velocity x Thickness) / Sum of Thickness for each soil/rock layer
2. Qal is divided into 4 intervals - (1) 0-15', (2) 15-30', (3) 30-60', and (4) 60-100'

APPENDIX A - SEISMIC WAVE VELOCITY

Borehole #		28		Redpath (Downhole) UT Austin (SASW)									
Interval	Material	Depth (ft)	Thickness, d (ft)	Shear Wave Velocity, Vs (ft/s)					Compression Wave Velocity, Vp (ft/s)				
				Downhole	Vs x d	Avg	SASW	Vs x d	Avg	Downhole	Vs x d	Avg	
	Fill	0.5	0.5				700	350					
	Fill	2	1.5				900	1350					
	Fill	3	1				1000	1000					
	Fill	4	1	1305	1305		1000	1000		3995	3995		
	Fill	5	1	1305	1305	<b>1305</b>	1500	1500	<b>1040</b>	3995	3995	<b>3995</b>	
	Qal	10	5	1305	6525		1500	7500		3995	19975		
	Qal	12	2	1980	3960		1500	3000		3995	7990		
1	Qal	15	3	1980	5940	<b>1643</b>	2500	7500	<b>1800</b>	3995	11985	<b>3995</b>	
	Tpcrn	30	15	1980	29700		2500	37500		3995	59925		
	Tpcrn	39	9	1980	17820		2500	22500		3995	35955		
	Tpcrn	42	3	3300	9900		2500	7500		5640	16920		
	Tpcrn	60	18	3300	59400		3200	57600		5640	101520		
	Tpcrn	70	10	3300	33000	<b>2724</b>	3200	32000	<b>2856</b>	5640	56400	<b>4922</b>	
	Tpcpul	95	25	3300	82500	<b>3300</b>	3200	80000		5640	141000		
	Tpcpul	96	1				3200	3200		5640	5640	<b>5640</b>	
	Tpcpul	99.8	3.8				3200	12160	<b>3200</b>				
		150	50.2				3200	160640					
				<b>ALL ROCK TOTAL</b>		<b>2904</b>			<b>2977</b>			<b>5147</b>	
				<b>UPPER ROCK TOTAL</b>		<b>2904</b>			<b>2977</b>			<b>5147</b>	
				<b>LOWER ROCK TOTAL</b>		<b>NA</b>			<b>NA</b>			<b>NA</b>	

Notes:

1. Average Seismic Velocity = Sum of (Velocity x Thickness) / Sum of Thickness for each soil/rock layer
2. Qal is divided into 4 intervals - (1) 0-15', (2) 15-30', (3) 30-60', and (4) 60-100'

APPENDIX A - SEISMIC WAVE VELOCITY

Borehole #		29		Redpath (Downhole) UT Austin (SASW)								
Qal	Material	Depth	Thickness, d	Shear Wave Velocity, Vs (ft/s)					Compression Wave Velocity, Vp (ft/s)			
Interval		(ft)	(ft)	Downhole	Vs x d	Avg	SASW	Vs x d	Avg	Downhole	Vs x d	Avg
	Qal	3	3									
	Qal	5	2	1660	3320					2875	5750	
1	Qal	15	10	1660	16600	<b>1660</b>				2875	28750	<b>2875</b>
2	Qal	30	15	1660	24900	<b>1660</b>				2875	43125	<b>2875</b>
	Qal	33	3	1660	4980					2875	8625	
3	Qal	60	27	2170	58590	<b>2119</b>				3675	99225	<b>3595</b>
	Qal	75	15	2170	32550					3675	55125	
4	Qal	85	10	2560	25600	<b>2326</b>				4500	45000	<b>4005</b>
	Tmbt1	100	15	2560	38400					4500	67500	
	Tmbt1	135	35	2560	89600					4500	157500	
	Tmbt1	138	3	2560	7680					6040	18120	
	Tmbt1	230	92	3320	305440					6040	555680	
	Tmbt1	280	50	3800	190000	<b>3237</b>				6040	302000	<b>5645</b>
	Tpki	370	90	3800	342000	<b>3800</b>				6040	543600	<b>6040</b>
	Tpbt5	380	10	3800	38000	<b>3800</b>				6040	60400	<b>6040</b>
	Tpcrn	405	25	3800	95000	<b>3800</b>				6040	151000	<b>6040</b>
	Tpcrn	430	25									
				<b>ALL ROCK TOTAL</b>	<b>3457</b>				<b>NA</b>			<b>5799</b>
				<b>UPPER ROCK TOTAL</b>	<b>3457</b>				<b>NA</b>			<b>5799</b>
				<b>LOWER ROCK TOTAL</b>	<b>NA</b>				<b>NA</b>			<b>NA</b>

Notes:

1. Average Seismic Velocity = Sum of (Velocity x Thickness) / Sum of Thickness for each soil/rock layer
2. Qal is divided into 4 intervals - (1) 0-15', (2) 15-30', (3) 30-60', and (4) 60-100'

APPENDIX B - BEARING CAPACITY AND SETTLEMENT

---

## Appendix B Contents

Page Number

<b>B1</b>	<b>Objective .....</b>	<b>B-2</b>
<b>B2</b>	<b>Inputs.....</b>	<b>B-2</b>
	<b>B2.1 Foundation Geometry .....</b>	<b>B-2</b>
	<b>B2.2 Allowable Settlements .....</b>	<b>B-3</b>
	<b>B2.3 Soil Profile and Parameters .....</b>	<b>B-3</b>
	<b>B2.4 Factor of Safety.....</b>	<b>B-4</b>
<b>B3</b>	<b>Background.....</b>	<b>B-5</b>
<b>B4</b>	<b>Methodology .....</b>	<b>B-5</b>
	<b>B4.1 Allowable Foundation Pressure .....</b>	<b>B-5</b>
	<b>B4.2 Short-term Settlements for Shallow Footings.....</b>	<b>B-6</b>
	<b>B4.3 Elastic Settlements for Mat Foundations .....</b>	<b>B-7</b>
	<b>B4.4 Long-term Settlements .....</b>	<b>B-7</b>
<b>B5</b>	<b>Assumptions.....</b>	<b>B-7</b>
<b>B6</b>	<b>Calculations .....</b>	<b>B-8</b>
	<b>B6.1 Bearing Capacity for Shallow Footings.....</b>	<b>B-8</b>
	<b>B6.2 Short-term Settlements for Shallow Footings.....</b>	<b>B-12</b>
	<b>B6.3 Foundation Pressure Considering Maximum Allowable Short-term Settlements (<math>S_c = \delta_{max}</math>).....</b>	<b>B-20</b>
	<b>B6.4 Design Foundation Pressure .....</b>	<b>B-24</b>
	<b>B6.5 Settlements for Different Foundation Pressures .....</b>	<b>B-28</b>
	<b>B6.6 Long-term Settlements.....</b>	<b>B-39</b>
	<b>B6.7 Elastic Settlement for Mat Foundation .....</b>	<b>B-42</b>
<b>B7</b>	<b>Results and Conclusions.....</b>	<b>B-50</b>

## APPENDIX B - BEARING CAPACITY AND SETTLEMENT

---

### B1 Objective

This calculation documents the alluvium bearing capacity and short-term settlement analyses for shallow footings and mat foundations at the surface facilities area at the Yucca Mountain Project (YMP) site.

Design charts for allowable for foundation pressure for square and strip footings are provided. The recommended foundation pressures consider maximum allowable bearing capacity and maximum permissible foundation settlement.

Short-term settlement evaluations under the center and corner of mat foundations are also considered in these analyses.

### B2 Inputs

The following input data is required to perform the analyses:

#### B2.1 Foundation Geometry

Footings with widths ranging from 2 to 30 feet and foundation embedment depths of 2, 4, and 6-feet are considered in the analyses for bearing capacity and settlement analyses of shallow footings.

##### Footing widths

$B_0 := 2\text{ft}$	Minimum footing width
$\Delta B := 0.1\text{ft}$	Footing width increment
$B_f := 30\text{ft}$	Maximum footing width
$B_1 := B_0 + \Delta B$	
$B := B_0, B_1 \dots B_f$	Footing width range

##### Embedment depths

$d_f := 2\text{-ft}, 4\text{ft} \dots 6\text{ft}$	Depth of embedment range
---	--------------------------

A square 400 feet by 300 feet mat is considered in the bearing capacity and settlement analyses for mat foundations.



## APPENDIX B - BEARING CAPACITY AND SETTLEMENT

---

### B2.2 Allowable Settlements

Maximum footing and mat foundation settlements of ½ and 1 inch are considered in this calculation. A 50-year lifetime for the foundations is used to estimate long-term settlements.

$\delta_{\max} := 0.5\text{in}, 0.75\text{in}.. 6.00\text{in}$	Maximum settlement for calculations.
$t := 50\text{-year}$	Lifetime of structure for long-term settlement estimate (BSC 2006b, Section 2.2.2.8)

### B2.3 Soil Stratigraphy and Parameters

Based on BSC (2002a, Section 6.6.2) the subsurface conditions at the site consist of 5 to 28 feet of undocumented fill underlain by alluvial material. The surface facilities will be resting directly on the alluvial material. The undocumented fill will be removed from the surface facilities area. The alluvial material thickness varies from a few feet up to 120 feet. Bedrock is found beneath the surface deposits of fill and alluvium.

The groundwater table is located at a typical depth of 1,270 feet below the present ground surface (see BSC, 2002a, Section 6.6.3).

The following material parameters for the alluvium are considered in the bearing capacity and settlement analyses:

$\gamma := 114\text{pcf}$	Moist density (see Table 2-1 of report)
$\phi_{\text{eff}} := 39\text{deg}$	Equivalent effective friction angle (see Table 2-1 of report)
$c_{\text{m}} := 0\text{psf}$	Cohesion (see see Table 2-1 of report)

The elastic settlements of shallow footings and mat foundations are evaluated with an alluvium Young's modulus profile that is obtained from the measurements of seismic shear wave velocities (see Appendix A of this report).

The average shear wave velocity and elastic modulus profiles are represented by the following best-fit equations:

## APPENDIX B - BEARING CAPACITY AND SETTLEMENT

---

### Shear wave velocity profile

$m_0 := 14.4 \cdot \frac{1}{s}$	Slope of equation fit
$b := 1410 \frac{ft}{s}$	Intercept of equation fit
$V(z) := m_0 \cdot z + b$	Linear fit equation for shear wave velocity vs. depth; fitted from Figure A6-1.
$\nu := 0.3$	Poisson's ratio (Appendix A, Section A6.3 of report)

### Young's modulus profile

$K := 0.1$	The fitted shear wave velocity line to obtain Young's modulus is for small strains. A reduction factor, K, of 0.1 is applied to obtain Young's modulus for large strain conditions. As demonstrated in Figure B6-19, the factor is conservative for the expected range of strains (<1%).
$G_{max}(z) := V(z)^2 \cdot \frac{\gamma}{g}$	Shear modulus (at small strains) calculated from shear wave velocity.
$E(z) := 2 \cdot K \cdot (1 + \nu) \cdot G_{max}(z)$	Young's modulus equation using linear fit shear wave velocity equation.

### B2.4 Factor of Safety

A 3.0 factor of safety against bearing capacity failure of the alluvial material is implemented in the analyses to compute the allowable bearing capacity.

FS := 3.0	Factor of safety against bearing capacity failure
-----------	---

## B3 Background

These analyses are the basis for recommendations and design guidelines for shallow footings and mat foundations for the surface facilities at the YMP site.

Ultimate bearing capacity values at the surface facilities area were previously presented in BSC (2002b, Section 9.2).

## APPENDIX B - BEARING CAPACITY AND SETTLEMENT

---

The current study presents shallow footings and mat foundations recommendations based on the material parameters presented in this report, Section 6.4. These recommendations are based on the field and laboratory test results reported in BSC (2002a, Section 6). These results include shear strength tests and in-situ shear wave velocity measurements in the alluvial material.

### B4 Methodology

This section presents the methodology used to compute the bearing capacity and short-term settlement analyses for shallow footings and mat foundations.

#### B4.1 Foundation Pressures

The recommended foundation pressures for shallow footings is computed for square and strip footings and for different foundation embedment depths. These recommended pressures are limited by the following criteria:

- The recommended foundation pressure should not exceed the allowable foundation capacity that considers a factor of safety of 3.0 against the soil shear failure. This allowable value is computed using the general ultimate capacity equation reported in Bowles (1996, Table 4-1 and Table 4-5a).
- The induced footing settlements cause by the recommended foundation pressure should not exceed the maximum allowable foundation settlement. Elastic settlements are computed using the settlement analyses procedures proposed by Burland and Burbidge, and by Schmertmann et al. as reported in Terzaghi et al. (1996, Sections 50.2.5 and 50.2.6).

#### B4.2 Short-term Settlements for Shallow Footings

Short-term settlements of shallow foundations are computed for square and strip footings using the Burland and Burbidge, and the Schmertmann et al. methods as presented in Terzaghi et al. (1996, Sections 50.2.5 and 50.2.6). Both methods use elastic theory to evaluate immediate settlements.

The Burland and Burbidge method is based on field measurements of foundation settlements. It uses the soil average standard penetration test blow count ( $N_{60}$ ) values to estimate the soil's vertical compression. The Schmertmann et al. method is based on field measurements of vertical strain beneath shallow footings. It uses the elastic soil modulus to estimate settlements.

The following discussion describes the methodology used to obtain the  $N_{60}$  values and the elastic modulus for the alluvial material to be used as input parameters in the short-term settlement estimates.

## APPENDIX B - BEARING CAPACITY AND SETTLEMENT

---

### $N_{60}$

$N_{60}$  results on the alluvial material are reported in only one of the exploration boreholes drilled in the WHB area. The reported values are unrealistically high and, therefore, are not used in the settlement analyses.

As an alternative to determine the  $N_{60}$  values for the alluvial material, two different procedures that correlate  $N_{60}$  values with experimental soil parameters were reviewed. The soil parameters reviewed in these correlations are as follows:

Using the correlations presented in Seed and Idris (1970) and Seed et al. (1986),  $N_{60}$  values for the alluvial material were evaluated using the extensive seismic shear wave velocity measurements performed at the site (see BSC 2002a, Section 6; and Appendix A of this report). The estimated  $N_{60}$  values with these correlations were unrealistically high for the given velocity measurements and thus are not used in the settlement analyses.

$N_{60}$  values for the alluvial material were correlated to the internal friction angle of the alluvium. The basis for the internal friction angle was from relative density measurements discussed in Section 6.4.1.1.2. The relationship proposed by Peck et al. (1974, page 310), is used to correlate  $N_{60}$  values with internal friction angle. These values were used in the short-term settlement analyses (see Section B4.2).

### **Young's modulus**

Estimate of the soil's Young's modulus are obtained from the seismic shear wave velocity measurements performed at the site (see Appendix A of this report). The average shear wave velocity profile adopted in this calculation is presented in Section B2.3.

### **B4.3 Elastic Settlements for Mat Foundation**

Settlements of a mat foundation on the alluvial sand were determined using elastic theory.

The stress profile under the mat was computed using a Boussinesq equation for a uniform vertical load. The incremental strain profile under the mat was computed using an iterative procedure that accounted for the degradation of Young's modulus with strain. In the iterative procedure, an initial small-strain Young's modulus was determined from the shear wave velocity profile presented in Section B2.3.

The shear modulus degradation curve for sands (Seed et al, 1986) was used to represent the Young's modulus degradation behavior of the alluvial material. For the purpose of the analysis herein, this assumption is considered conservative.

## APPENDIX B - BEARING CAPACITY AND SETTLEMENT

---

### B4.4 Long-term Settlements

The Burland and Burbidge procedure was implemented to compute the long-term settlements of footings (see Terzaghi et al, 1996, Section 50.2.5). This method estimates settlements based on the soil standard penetration test blow count ( $N_{60}$ ) values.

## B5 Assumptions

It is conservatively assumed that bedrock is very deep and that it has no effect on the bearing capacity and settlement analyses for shallow footings and mat foundations.

Additionally, the Young's modulus,  $E$ , is assumed to degrade the same as the shear modulus,  $G$ , for sands. This yields conservative results since Poisson's ratio does not remain constant with strain. It is also assumed that there is no rock strain for the mat analysis.

No eccentric or inclined loading is considered in the analyses.

The preconsolidated characteristics of the alluvial material due to the removal of the overlaying undocumented fill is not considered in the short-term settlement analyses. This is a conservative assumption.

A 50-year lifetime for the surface structures is assumed in the long-term settlements calculations (Subsurface Facility Description Document, BSC, 2004a, Section 2.3.1).

All of these assumptions are either sufficiently conservative or represent typical standards used in the industry and do not require further verification.

## B6 Calculations

Calculations were performed using Mathcad and EXCEL on a stand-alone PC. The PC is networked for printing and file storage but the programs used are loaded on the PC. These programs started and operated normally during calculation preparation.

The allowable bearing capacity results consider an adequate margin of safety against bearing capacity failure with associated tolerable footing settlement. The following schematic (Figure B6-1) for a shallow footing presents the definitions of the different symbols used in the bearing capacity and short-term settlement analyses:

APPENDIX B - BEARING CAPACITY AND SETTLEMENT

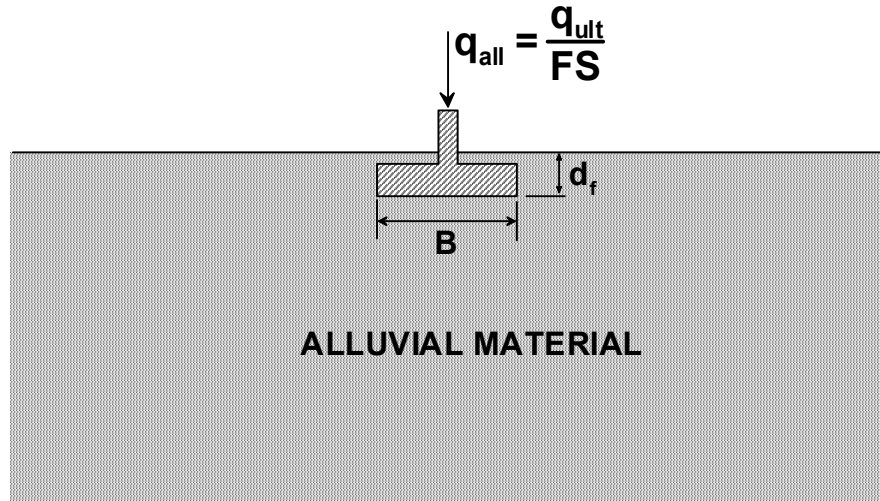


Figure B6-1. Schematic for shallow footing.

**B6.1 Bearing Capacity for Shallow Footings**

The bearing capacity of shallow footings was computed using the general ultimate capacity equation reported in Bowles (1996, Table 4-1 and Table 4-5a).

**Effective overburden pressure**

$$q(d_f) := d_f \cdot \gamma$$

Check values

$$q(2\text{ft}) = 228 \cdot \text{psf}$$

**Bearing capacity factors**

$$N_q(\phi) := e^{\pi \cdot \tan(\phi)} \cdot \tan\left(45\text{deg} + \frac{\phi}{2}\right)^2$$

Check values

$$N_q(0\text{deg}) = 1$$

$$N_\gamma(\phi) := 2 \cdot (N_q(\phi) + 1) \cdot \tan(\phi)$$

$$N_\gamma(0\text{deg}) = 0$$

$$N_c(\phi) := \begin{cases} \pi + 2 & \text{if } \phi = 0 \\ (N_q(\phi) - 1) \cdot \cot(\phi) & \text{otherwise} \end{cases}$$

$$N_c(0\text{deg}) = 5.142$$

APPENDIX B - BEARING CAPACITY AND SETTLEMENT

**Shape factors**

Check values

***Square footings***

$$s_{q\_square}(\phi) := 1 + \tan(\phi)$$

$$s_{q\_square}(0deg) = 1$$

$$s_{\gamma\_square} := 0.6$$

$$s_{\gamma\_square} = 0.6$$

$$s_{c\_square}(\phi) := 1 + \frac{N_q(\phi)}{N_c(\phi)}$$

$$s_{c\_square}(0deg) = 1.194$$

***Strip footings***

$$s_{q\_strip} := 1$$

$$s_{q\_strip} = 1$$

$$s_{\gamma\_strip} := 1$$

$$s_{\gamma\_strip} = 1$$

$$s_{c\_strip} := 1$$

$$s_{c\_strip} = 1$$

**Ultimate bearing capacity**

***Square footings***

$$q_{ult\_square}(B, d_f, c, \phi, \gamma) := c \cdot N_c(\phi) \cdot s_{c\_square}(\phi) + q(d_f) \cdot N_q(\phi) \cdot s_{q\_square}(\phi) + 0.5 \cdot \gamma \cdot B \cdot N_{\gamma}(\phi) \cdot s_{\gamma\_square}$$

***Strip footings***

$$q_{ult\_strip}(B, d_f, c, \phi, \gamma) := c \cdot N_c(\phi) \cdot s_{c\_strip} + q(d_f) \cdot N_q(\phi) \cdot s_{q\_strip} + 0.5 \cdot \gamma \cdot B \cdot N_{\gamma}(\phi) \cdot s_{\gamma\_strip}$$

$$q_{ult\_square}(10ft, 2ft, c, \phi_{eff}, \gamma) = 54638 \cdot psf \quad \longleftarrow \text{Check value}$$

$$q_{ult\_strip}(10ft, 2ft, c, \phi_{eff}, \gamma) = 65339 \cdot psf \quad \longleftarrow \text{Check value}$$

**Allowable bearing capacity**

***Square footings***

$$q_{all\_square}(B, d_f, c, \phi, \gamma) := \frac{q_{ult\_square}(B, d_f, c, \phi, \gamma)}{FS}$$

APPENDIX B - BEARING CAPACITY AND SETTLEMENT

**Strip footings**

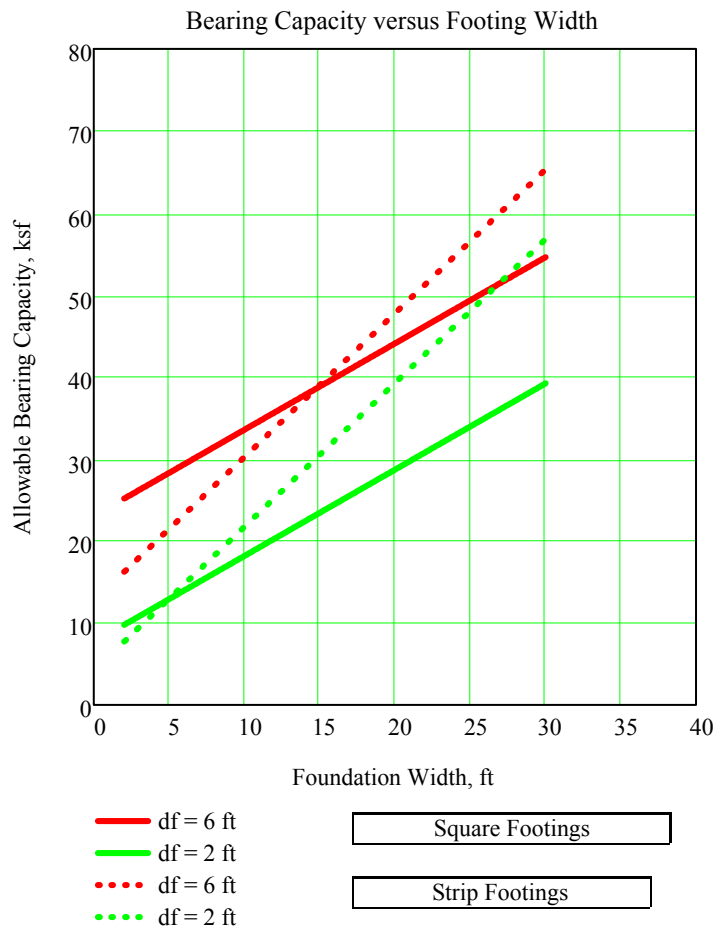
$$q_{all\_strip}(B, d_f, c, \phi, \gamma) := \frac{q_{ult\_strip}(B, d_f, c, \phi, \gamma)}{FS}$$

$$q_{all\_square}(10ft, 2ft, c, \phi_{eff}, \gamma) = 18213 \cdot psf \quad \longleftarrow \text{Check value}$$

$$q_{all\_strip}(10ft, 2ft, c, \phi_{eff}, \gamma) = 21780 \cdot psf \quad \longleftarrow \text{Check value}$$

**Results**

Figure B6-2 presents the allowable bearing capacities for square and strip footings. Results for 2-foot and 6-foot foundation embedment depths are presented in these figures.



**Figure B6-2.** Allowable bearing pressure versus foundation width for square and strip footings



APPENDIX B - BEARING CAPACITY AND SETTLEMENT

**B6.2 Short-term Settlements for Shallow Footings**

Short-term settlements of shallow foundations are computed for square and strip footings using the Burland and Burbidge, and Schmertmann et al. methods as presented in Terzaghi et al. (1996, Sections 50.2.5 and 50.2.6). Both methods use elastic theory to evaluate immediate settlements..

**Burland and Burbidge (Terzaghi et al. 1996, Section 50.2.5) Method**

$N_{60}$

The following equation correlates  $N_{60}$  values with  $\phi$ . This equation is the regression curve to the chart presented by Peck et al. (1974, page 310).

Note: the computed  $N_{60}$  values are bounded to a maximum value of 60 blows per foot and a minimum value of 3 blows per foot.

$$N_{60}(\phi) := \begin{cases} .0027305858 - 17.924589 \cdot \frac{\phi}{\text{deg}} + 1.4246932 \cdot \left(\frac{\phi}{\text{deg}}\right)^2 & \dots \text{ if } \phi \geq 28\text{deg} \\ + -.03770745 \cdot \left(\frac{\phi}{\text{deg}}\right)^3 + .00035020841 \cdot \left(\frac{\phi}{\text{deg}}\right)^4 & \\ 3 & \text{otherwise} \end{cases}$$

$N_{60}(\phi) := \min(60, N_{60}(\phi))$  ← Bound  $N_{60}$  to a maximum value of 60 blows per foot

$N_{60}(\phi_{\text{eff}}) = 41$  ← Check value

**Effective preconstruction pressure at the footing base**

Check value

$\sigma_{vo}(d_f) := d_f \cdot \gamma$

$\sigma_{vo}(1\text{ft}) = 114 \cdot \text{psf}$

**Zone of footing influence**

The following equation corresponds to Equation 50.6 presented by Terzaghi et al. (1996, page 395).

Check value

$Z_I(B) := \left(\frac{B}{\text{m}}\right)^{0.75} \text{ m}$

$Z_I(10\text{ft}) = 2.307 \text{ m}$

**APPENDIX B - BEARING CAPACITY AND SETTLEMENT**

***Average coefficient of vertical compression***

The following equation corresponds to Equation 50.7 presented by Terzaghi et al. (1996, page 395).

$$m_v(\phi) := \frac{1.7}{N_{60}(\phi)^{1.4}} \text{MPa}^{-1} \qquad \text{Check value} \qquad m_v(\phi_{\text{eff}}) = 0.0093 \cdot \text{MPa}^{-1}$$

***Foundation length-to-width ratio***

The following values are derived from Equation 50.14 presented by Terzaghi et al. (1996, page 397).

***Square Footings***

$$S_{c\_sq} := 1$$

***Strip Footings***

$$S_{c\_st} := 1.56$$

***Immediate settlement equation for square and strip***

The following equations correspond to Equations 50.11a and 50.11b presented by Terzaghi et al. (1996, page 396). Equation 50.11a is applicable for foundation pressures greater than the effective preconsolidation pressure. Equation 50.11b is applicable for foundation pressures less than the effective preconsolidation pressure.

***Square footings***

$$S_{c1\_sq}(B, d_f, c, \phi, \gamma) := \begin{cases} Z_I(B) \cdot m_v(\phi) \cdot \left[ q_{\text{all\_square}}(B, d_f, c, \phi, \gamma) \dots \right] \cdot S_{c\_sq} & \text{if } q_{\text{all\_square}}(B, d_f, c, \phi, \gamma) > \sigma_{vo}(d_f) \\ + \left( \frac{2}{3} \cdot \sigma_{vo}(d_f) \right) \cdot (-1) \\ \frac{1}{3} \cdot Z_I(B) \cdot m_v(\phi) \cdot q_{\text{all\_square}}(B, d_f, c, \phi, \gamma) \cdot S_{c\_sq} & \text{otherwise} \end{cases}$$

***Strip footings***

$$S_{c1\_st}(B, d_f, c, \phi, \gamma) := \begin{cases} Z_I(B) \cdot m_v(\phi) \cdot \left[ q_{\text{all\_strip}}(B, d_f, c, \phi, \gamma) \dots \right] \cdot S_{c\_st} & \text{if } q_{\text{all\_strip}}(B, d_f, c, \phi, \gamma) > \sigma_{vo}(d_f) \\ + \left( \frac{2}{3} \cdot \sigma_{vo}(d_f) \right) \cdot (-1) \\ \frac{1}{3} \cdot Z_I(B) \cdot m_v(\phi) \cdot q_{\text{all\_strip}}(B, d_f, c, \phi, \gamma) \cdot S_{c\_st} & \text{otherwise} \end{cases}$$

APPENDIX B - BEARING CAPACITY AND SETTLEMENT

$$S_{c1\_sq}(5\text{ft}, 0\text{ft}, c, \phi_{\text{eff}}, \gamma) = 0.126 \cdot \text{in} \quad \longleftarrow \text{Check value}$$

$$S_{c1\_st}(5\text{ft}, 0\text{ft}, c, \phi_{\text{eff}}, \gamma) = 0.328 \cdot \text{in} \quad \longleftarrow \text{Check value}$$

**Schmertmann (Terzaghi et al. 1996, Section 50.2.6) Method**

***Embedment correction factor (regression equation)***

This equation is the regression curve to the chart presented in Figure 50.10 by Terzaghi et al. (1996, Section 50.2.6).

$$C_1(B, d_f) := \frac{1.0561309 + 0.66610907 \cdot \left(\frac{d_f}{B}\right)}{1 + 1.2514064 \cdot \left(\frac{d_f}{B}\right) - 0.0024535149 \cdot \left(\frac{d_f}{B}\right)^2}$$

$$C_{1\text{max}}(B, d_f) := \min(1, C_1(B, d_f)) \quad \longleftarrow \text{Bound } C_1 \text{ to a maximum value of 1}$$

***Strain influence equations for square and strip footings***

These equations correspond to the curves presented in Figure 50.9 presented by Terzaghi et al. (1996, Section 50.2.6) for square ( $L/B = 1$ ) and strip ( $L/B > 10$ ) footings.  $L$  is the footing length.

***Square footings***

$$I_{z\_sq}(z, B, d_f) := \begin{cases} \frac{4}{5 \cdot B} \cdot (z - d_f) + \frac{1}{5} & \text{if } z \leq \left(d_f + \frac{B}{2}\right) \\ \frac{-2}{5 \cdot B} \cdot (z - d_f) + \frac{4}{5} & \text{otherwise} \end{cases}$$

***Strip footings***

$$I_{z\_st}(z, B, d_f) := \begin{cases} \frac{4}{5 \cdot B} \cdot (z - d_f) + \frac{1}{5} & \text{if } z \leq \left(d_f + \frac{B}{2}\right) \\ \frac{-6}{35 \cdot B} \cdot (z - d_f) + \frac{24}{35} & \text{otherwise} \end{cases}$$

APPENDIX B - BEARING CAPACITY AND SETTLEMENT

---

**Immediate settlement equations**

These equations represent the continuous form of Equations 50.23a and 50.23b presented by Terzaghi et al. (1996, Section 50.2.6).

**Square footings**

$$S_{c2a\_sq}(B, d_f) := \int_{d_f}^{d_f+2B} \frac{I_{z\_sq}(z, B, d_f)}{E(z)} dz$$

$$S_{c2\_sq}(B, d_f, c, \phi, \gamma) := C_1(B, d_f) \cdot (q_{all\_square}(B, d_f, c, \phi, \gamma) - \sigma_{vo}(d_f)) \cdot S_{c2a\_sq}(B, d_f)$$

**Strip footings**

$$S_{c2a\_st}(B, d_f) := \int_{d_f}^{d_f+4B} \frac{I_{z\_st}(z, B, d_f)}{E(z)} dz$$

$$S_{c2\_st}(B, d_f, c, \phi, \gamma) := C_1(B, d_f) \cdot (q_{all\_strip}(B, d_f, c, \phi, \gamma) - \sigma_{vo}(d_f)) \cdot S_{c2a\_st}(B, d_f)$$

$$S_{c2\_sq}(5\text{ft}, 0\text{ft}, c, \phi_{eff}, \gamma) = 0.104 \cdot \text{in} \quad \longleftarrow \quad \text{Check value}$$

$$S_{c2\_st}(5\text{ft}, 0\text{ft}, c, \phi_{eff}, \gamma) = 0.313 \cdot \text{in} \quad \longleftarrow \quad \text{Check value}$$

**Results**

Figures B6-3 and B6-4 present settlement estimates versus allowable bearing capacities for square and strip footings, respectively. Settlements are evaluated with the Burland and Burbidge, and Schmertmann Methods. Results for 2-foot and 6-foot foundation embedment depths are presented in these figures.

APPENDIX B - BEARING CAPACITY AND SETTLEMENT

For plotting purposes let:

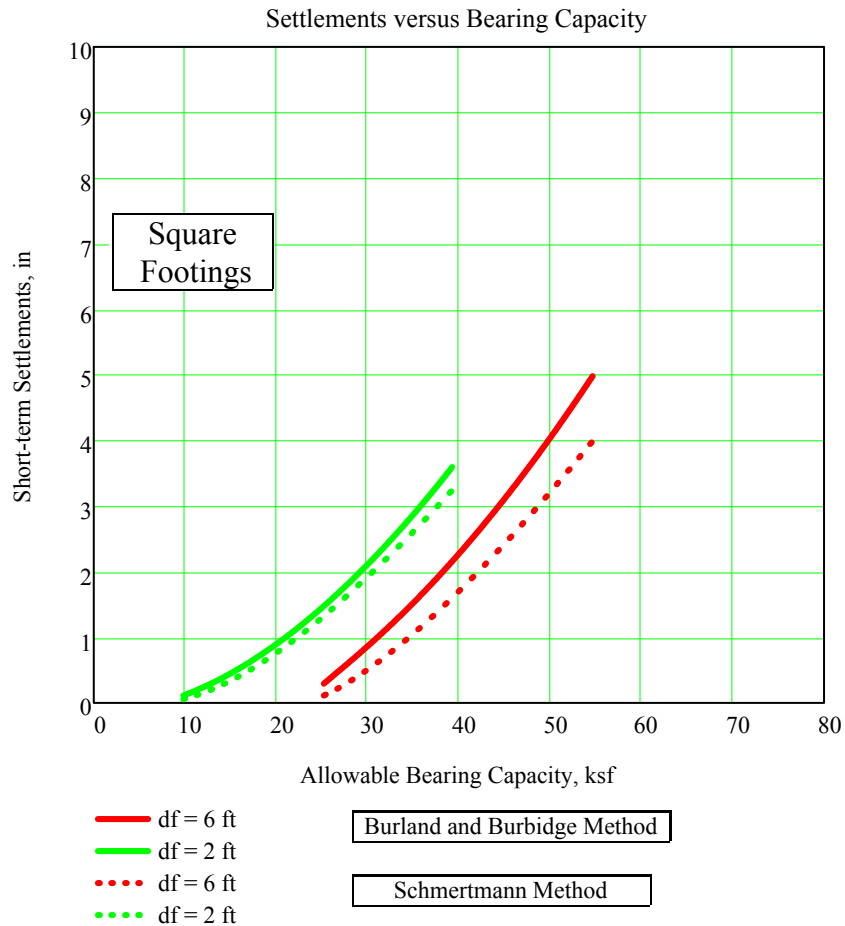
$$q_{all\_sq\_6ft}(B) := q_{all\_square}(B, 6ft, c, \phi_{eff}, \gamma)$$

$$q_{all\_sq\_2ft}(B) := q_{all\_square}(B, 2ft, c, \phi_{eff}, \gamma)$$

$$q_{all\_st\_6ft}(B) := q_{all\_strip}(B, 6ft, c, \phi_{eff}, \gamma)$$

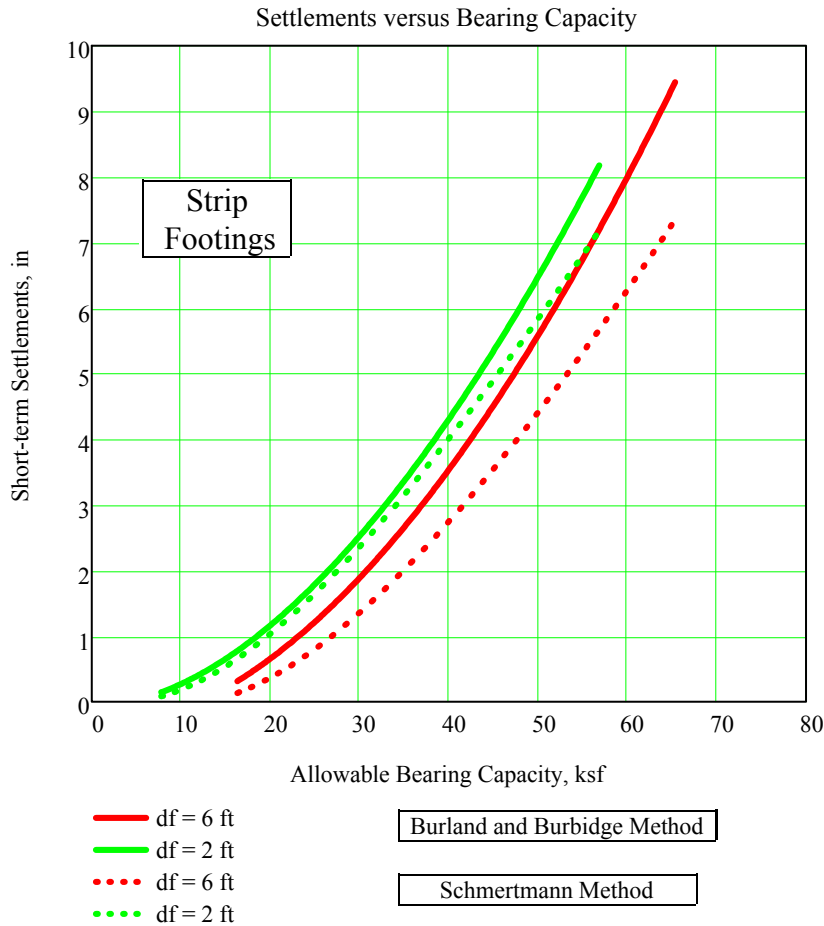
$$q_{all\_st\_2ft}(B) := q_{all\_strip}(B, 2ft, c, \phi_{eff}, \gamma)$$

in Figures B6-3 and B6-4 below.



**Figure B6-3.** Short-term settlement estimates versus allowable bearing capacities for square footings

APPENDIX B - BEARING CAPACITY AND SETTLEMENT



**Figure B6-4.** Short-term settlement estimates versus allowable bearing capacities for strip footings

**B6.3 Foundation Pressure Considering a Maximum Allowable Short-term Settlement**  
 $(S_c = \delta_{max})$

The allowable foundation pressure is constrained to a pressure that produces a footing maximum allowable short-term settlement,  $\delta_{max}$ . This capacity is computed using the methods proposed by Burland and Burbidge, and Schmertmann et al. as reported in Terzaghi et al. (1996, Sections 50.2.5 and 50.2.6).

APPENDIX B - BEARING CAPACITY AND SETTLEMENT

**Burland and Burbidge (Terzaghi et al. 1996, Section 50.2.5) Method**

The following equations correspond to Equations 50.11a and 50.11b presented by Terzaghi et al. (1996), page 396.

**Square footings**

$$q_{\delta_{\max\_c1\_sq}(B, d_f, c, \phi, \gamma, \delta_{\max})} := \begin{cases} \frac{\delta_{\max}}{Z_I(B) \cdot m_v(\phi) \cdot S_{c\_sq}} + \frac{2}{3} \cdot \sigma_{vo}(d_f) & \text{if } q_{\text{all\_square}}(B, d_f, c, \phi, \gamma) > \sigma_{vo}(d_f) \\ \frac{3 \cdot \delta_{\max}}{Z_I(B) \cdot m_v(\phi) \cdot S_{c\_sq}} & \text{otherwise} \end{cases}$$

**Strip footings**

$$q_{\delta_{\max\_c1\_st}(B, d_f, c, \phi, \gamma, \delta_{\max})} := \begin{cases} \frac{\delta_{\max}}{Z_I(B) \cdot m_v(\phi) \cdot S_{c\_st}} + \frac{2}{3} \cdot \sigma_{vo}(d_f) & \text{if } q_{\text{all\_strip}}(B, d_f, c, \phi, \gamma) > \sigma_{vo}(d_f) \\ \frac{3 \cdot \delta_{\max}}{Z_I(B) \cdot m_v(\phi) \cdot S_{c\_st}} & \text{otherwise} \end{cases}$$

$q_{\delta_{\max\_c1\_sq}(5\text{ft}, 0\text{ft}, c, \phi_{\text{eff}}, \gamma, 0.5\text{in})} = 20.825 \cdot \text{ksf}$  ← Check value

$q_{\delta_{\max\_c1\_st}(5\text{ft}, 0\text{ft}, c, \phi_{\text{eff}}, \gamma, 0.5\text{in})} = 13.35 \cdot \text{ksf}$  ← Check value

**Schmertmann (Terzaghi et al. 1996, Section 50.2.6) Method**

These equations represent the continuous form of Equations 50.23a and 50.23b presented by Terzaghi et al. (1996, Section 50.2.6).

**Square footings**

$$q_{\delta_{\max\_c2\_sq}(B, d_f, \delta_{\max})} := \frac{\delta_{\max}}{C_1(B, d_f) \cdot (S_{c2a\_sq}(B, d_f))} + \sigma_{vo}(d_f)$$

**Strip footings**

$$q_{\delta_{\max\_c2\_st}(B, d_f, \delta_{\max})} := \frac{\delta_{\max}}{C_1(B, d_f) \cdot (S_{c2a\_st}(B, d_f))} + \sigma_{vo}(d_f)$$

$q_{\delta_{\max\_c2\_sq}(5\text{ft}, 0\text{ft}, 0.5\text{in})} = 25.391 \cdot \text{ksf}$  ← Check value

$q_{\delta_{\max\_c2\_st}(5\text{ft}, 0\text{ft}, 0.5\text{in})} = 14.017 \cdot \text{ksf}$  ← Check value

APPENDIX B - BEARING CAPACITY AND SETTLEMENT

Results

Figures B6-5 and B6-6 present the maximum foundation pressure versus foundation width for square and strip footings, respectively. Settlements are evaluated with the Burland and Burbidge, and Schmertmann methods. Results for 2-foot and 6-foot foundation embedment depths are presented in these figures.

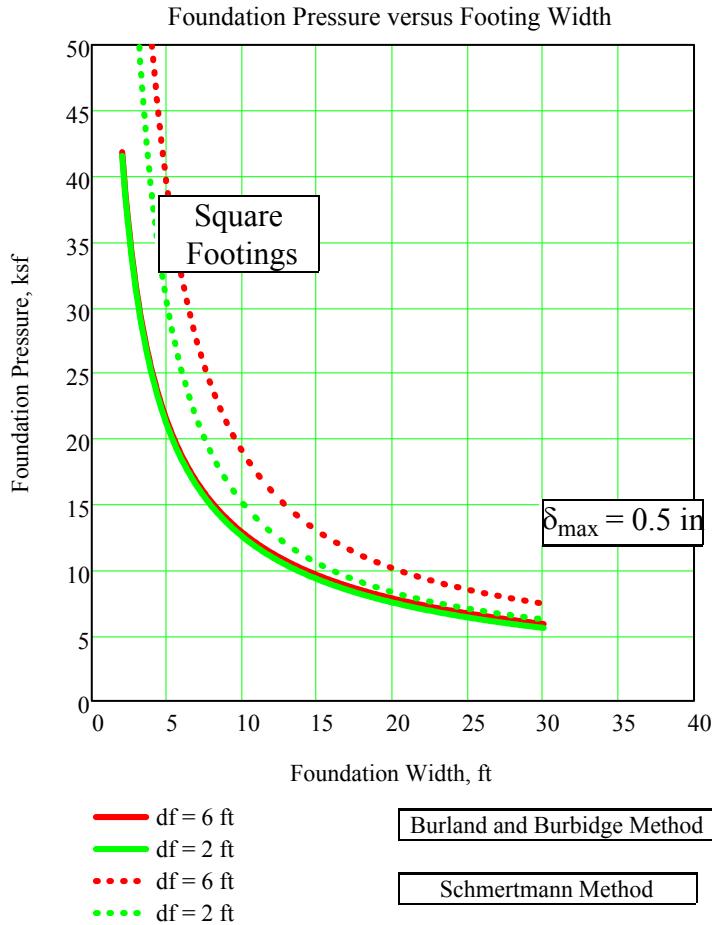
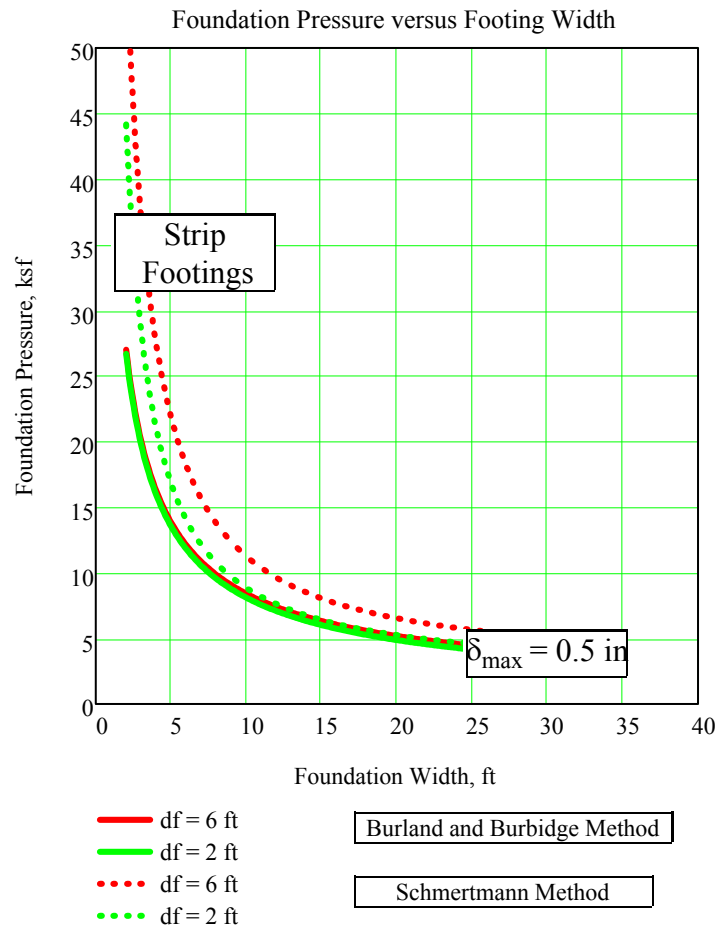


Figure B6-5. Foundation pressure versus foundation width for square footings considering a maximum allowable foundation settlement of 0.5 in



APPENDIX B - BEARING CAPACITY AND SETTLEMENT



**Figure B6-6.** Foundation pressure versus foundation width for strip footings considering a maximum allowable foundation settlement of 0.5 in

### B6.4 Design Foundation Pressure

The design foundation pressure is computed as the minimum of the allowable bearing capacity or the foundation pressure as determined above from Sections B6.1 and B6.3.

The maximum foundation pressure for design is further limited by a cutoff value. This value corresponds to the minimum pressure of the values determined in Sections B6.1 and B6.3 for a 2-foot wide footing.

APPENDIX B - BEARING CAPACITY AND SETTLEMENT

**Burland and Burbidge (Terzaghi et al. 1996) method**

***Square footings***

$$q_{fp\_c1\_sq}(B, d_f, c, \phi, \gamma, \delta_{max}) := \begin{cases} q_{all\_square}(B, d_f, c, \phi, \gamma) & \text{if } S_{c1\_sq}(B, d_f, c, \phi, \gamma) \leq \delta_{max} \\ q_{\delta_{max}\_c1\_sq}(B, d_f, c, \phi, \gamma, \delta_{max}) & \text{otherwise} \end{cases}$$

$$q_{fp\_c1\_sq0}(d_f, c, \phi, \gamma, \delta_{max}) := q_{fp\_c1\_sq}(B_0, d_f, c, \phi, \gamma, \delta_{max}) \quad \longleftarrow \quad \text{Cutoff value}$$

$$q_{fp\_c1\_sq}(B, d_f, c, \phi, \gamma, \delta_{max}) := \begin{cases} q_{fp\_c1\_sq0}(d_f, c, \phi, \gamma, \delta_{max}) & \text{if } q_{fp\_c1\_sq}(B, d_f, c, \phi, \gamma, \delta_{max}) > q_{fp\_c1\_sq0}(d_f, c, \phi, \gamma, \delta_{max}) \\ q_{fp\_c1\_sq}(B, d_f, c, \phi, \gamma, \delta_{max}) & \text{otherwise} \end{cases}$$

***Strip footings***

$$q_{fp\_c1\_st}(B, d_f, c, \phi, \gamma, \delta_{max}) := \begin{cases} q_{all\_strip}(B, d_f, c, \phi, \gamma) & \text{if } S_{c1\_st}(B, d_f, c, \phi, \gamma) \leq \delta_{max} \\ q_{\delta_{max}\_c1\_st}(B, d_f, c, \phi, \gamma, \delta_{max}) & \text{otherwise} \end{cases}$$

$$q_{fp\_c1\_st0}(d_f, c, \phi, \gamma, \delta_{max}) := q_{fp\_c1\_st}(B_0, d_f, c, \phi, \gamma, \delta_{max}) \quad \longleftarrow \quad \text{Cutoff value}$$

$$q_{fp\_c1\_st}(B, d_f, c, \phi, \gamma, \delta_{max}) := \begin{cases} q_{fp\_c1\_st0}(d_f, c, \phi, \gamma, \delta_{max}) & \text{if } q_{fp\_c1\_st}(B, d_f, c, \phi, \gamma, \delta_{max}) > q_{fp\_c1\_st0}(d_f, c, \phi, \gamma, \delta_{max}) \\ q_{fp\_c1\_st}(B, d_f, c, \phi, \gamma, \delta_{max}) & \text{otherwise} \end{cases}$$

$$q_{fp\_c1\_sq}(20ft, 0ft, c, \phi_{eff}, \gamma, 0.5in) = 2.103 \cdot ksf \quad \longleftarrow \quad \text{Check value}$$

$$q_{fp\_c1\_st}(20ft, 0ft, c, \phi_{eff}, \gamma, 0.5in) = 3.505 \cdot ksf \quad \longleftarrow \quad \text{Check value}$$

**Schmertmann (Terzaghi et al. 1996) method**

***Square footings***

$$q_{fp\_c2\_sq}(B, d_f, c, \phi, \gamma, \delta_{max}) := \begin{cases} q_{all\_square}(B, d_f, c, \phi, \gamma) & \text{if } S_{c2\_sq}(B, d_f, c, \phi, \gamma) \leq \delta_{max} \\ q_{\delta_{max}\_c2\_sq}(B, d_f, \delta_{max}) & \text{otherwise} \end{cases}$$

APPENDIX B - BEARING CAPACITY AND SETTLEMENT

$$q_{fp\_c2\_sq0}(d_f, c, \phi, \gamma, \delta_{max}) := q_{fp\_c2\_sq}(B_0, d_f, c, \phi, \gamma, \delta_{max}) \quad \longleftarrow \text{Cutoff value}$$

$$q_{fp\_c2\_sq}(B, d_f, c, \phi, \gamma, \delta_{max}) := \begin{cases} q_{fp\_c2\_sq0}(d_f, c, \phi, \gamma, \delta_{max}) & \text{if } q_{fp\_c2\_sq}(B, d_f, c, \phi, \gamma, \delta_{max}) > q_{fp\_c2\_sq0}(d_f, c, \phi, \gamma, \delta_{max}) \\ q_{fp\_c2\_sq}(B, d_f, c, \phi, \gamma, \delta_{max}) & \text{otherwise} \end{cases}$$

**Strip footings**

$$q_{fp\_c2\_st}(B, d_f, c, \phi, \gamma, \delta_{max}) := \begin{cases} q_{all\_strip}(B, d_f, c, \phi, \gamma) & \text{if } S_{c2\_st}(B, d_f, c, \phi, \gamma) \leq \delta_{max} \\ q_{\delta_{max}\_c2\_st}(B, d_f, \delta_{max}) & \text{otherwise} \end{cases}$$

$$q_{fp\_c2\_st0}(d_f, c, \phi, \gamma, \delta_{max}) := q_{fp\_c2\_st}(B_0, d_f, c, \phi, \gamma, \delta_{max}) \quad \longleftarrow \text{Cutoff value}$$

$$q_{fp\_c2\_st}(B, d_f, c, \phi, \gamma, \delta_{max}) := \begin{cases} q_{fp\_c2\_st0}(d_f, c, \phi, \gamma, \delta_{max}) & \text{if } q_{fp\_c2\_st}(B, d_f, c, \phi, \gamma, \delta_{max}) > q_{fp\_c2\_st0}(d_f, c, \phi, \gamma, \delta_{max}) \\ q_{fp\_c2\_st}(B, d_f, c, \phi, \gamma, \delta_{max}) & \text{otherwise} \end{cases}$$

$$q_{fp\_c2\_sq}(20\text{ft}, 0\text{ft}, c, \phi_{eff}, \gamma, 0.5\text{in}) = 2.103 \cdot \text{ksf} \quad \longleftarrow \text{Check value}$$

$$q_{fp\_c2\_st}(20\text{ft}, 0\text{ft}, c, \phi_{eff}, \gamma, 0.5\text{in}) = 3.505 \cdot \text{ksf} \quad \longleftarrow \text{Check value}$$

**Results**

Figures B6-7 and B6-8 present the design foundation pressure versus foundation width for square and strip footings, respectively. Settlements are evaluated with the Burland and Burbidge, and Schmertmann methods. Results for 2-foot and 6-foot foundation embedment depths are presented in these figures.

APPENDIX B - BEARING CAPACITY AND SETTLEMENT

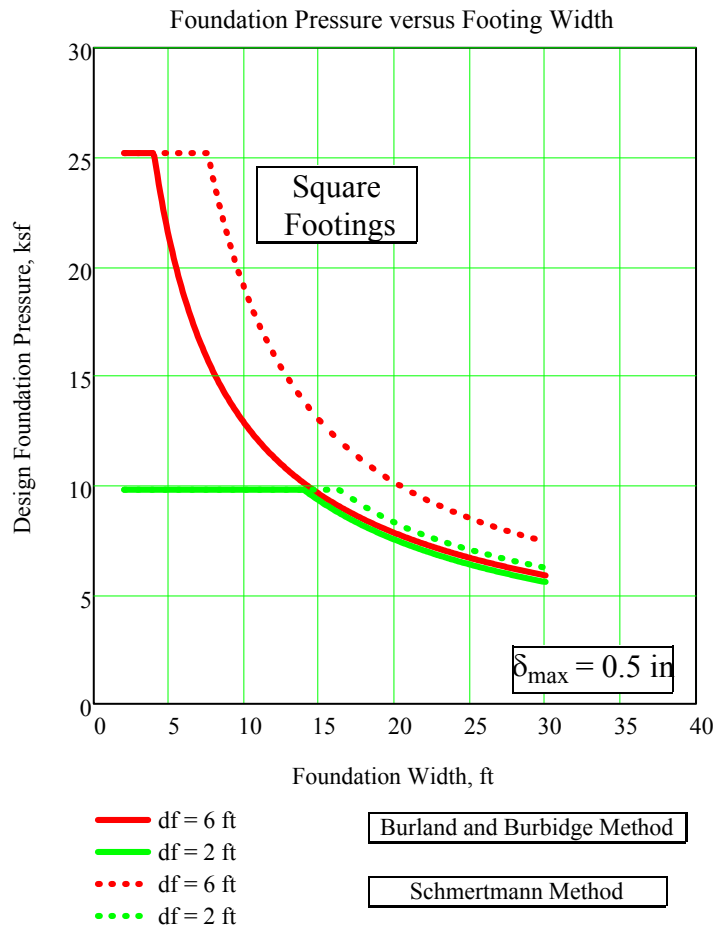


Figure B6-7. Design foundation pressure versus foundation width for square footings considering a maximum allowable foundation settlement of 0.5 in

APPENDIX B - BEARING CAPACITY AND SETTLEMENT

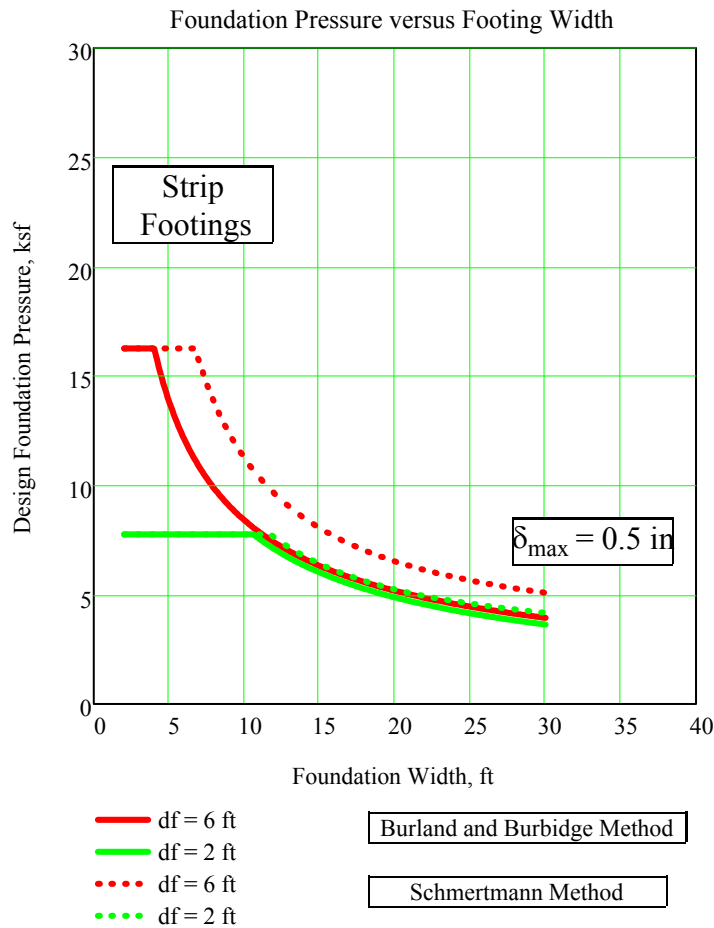


Figure B6-8. Design foundation pressure versus foundation width for strip footings considering a maximum allowable foundation settlement of 0.5 in

B6.5 Settlements for Different Foundation Pressures

The short-term settlements for different foundation pressures are computed using the procedures by Burland and Burbidge, and Schmertmann et al. as reported in Terzaghi et al. (1996, Sections 50.2.5 and 50.2.6).

The following bearing pressure range is considered in the analyses:

APPENDIX B - BEARING CAPACITY AND SETTLEMENT

$$q_{bp} := 0.5\text{ksf}, 0.6\text{ksf} \dots 40\text{ksf}$$

Bearing pressure range

**Burland and Burbidge (Terzaghi et. al 1996) method**

The following equations correspond to Equations 50.11a and 50.11b presented by Terzaghi et al. (1996, Section 50.2.5).

**Square Footings**

$$S_{bp\_c1\_sq}(B, d_f, \phi, q_{bp}) := \begin{cases} Z_I(B) \cdot m_v(\phi) \cdot \left( q_{bp} - \frac{2}{3} \cdot \sigma_{vo}(d_f) \right) \cdot S_{c\_sq} & \text{if } q_{bp} > \sigma_{vo}(d_f) \\ \frac{1}{3} \cdot Z_I(B) \cdot m_v(\phi) \cdot q_{bp} \cdot S_{c\_sq} & \text{otherwise} \end{cases}$$

**Strip Footings**

$$S_{bp\_c1\_st}(B, d_f, \phi, q_{bp}) := \begin{cases} Z_I(B) \cdot m_v(\phi) \cdot \left( q_{bp} - \frac{2}{3} \cdot \sigma_{vo}(d_f) \right) \cdot S_{c\_st} & \text{if } q_{bp} > \sigma_{vo}(d_f) \\ \frac{1}{3} \cdot Z_I(B) \cdot m_v(\phi) \cdot q_{bp} \cdot S_{c\_st} & \text{otherwise} \end{cases}$$

Check values

$$S_{bp\_c1\_sq}(5\text{ft}, 0\text{ft}, \phi_{eff}, q_{bp}) =$$

0.012	·in
0.014	
...	

$$q_{bp} =$$

0.5	·ksf
0.6	
...	

$$S_{bp\_c1\_st}(5\text{ft}, 0\text{ft}, \phi_{eff}, q_{bp}) =$$

0.019	·in
0.022	
...	

$$q_{bp} =$$

0.5	·ksf
0.6	
...	

**Schmertmann (Terzaghi et. al 1996) method**

These equations represent the continuous form of Equations 50.23a and 50.23b presented by Terzaghi et al. (1996, Section 50.2.6).

**Square Footings**

**APPENDIX B - BEARING CAPACITY AND SETTLEMENT**

$$S_{bp\_c2a\_sq}(B, d_f) := \int_{d_f}^{d_f+2B} \frac{I_{z\_sq}(z, B, d_f)}{E(z)} dz$$

$$S_{bp\_c2\_sq}(B, d_f, q_{bp}) := C_1(B, d_f) \cdot (q_{bp} - \sigma_{vo}(d_f)) \cdot S_{bp\_c2a\_sq}(B, d_f)$$

**Strip Footings**

$$S_{bp\_c2a\_st}(B, d_f) := \int_{d_f}^{d_f+4B} \frac{I_{z\_st}(z, B, d_f)}{E(z)} dz$$

$$S_{bp\_c2\_st}(B, d_f, q_{bp}) := C_1(B, d_f) \cdot (q_{bp} - \sigma_{vo}(d_f)) \cdot S_{bp\_c2a\_st}(B, d_f)$$

Check values

$$S_{bp\_c2\_sq}(5\text{ft}, 0\text{ft}, q_{bp}) = \begin{array}{|c|} \hline 0.01 \\ \hline 0.012 \\ \hline \dots \\ \hline \end{array} \cdot \text{in} \qquad q_{bp} = \begin{array}{|c|} \hline 0.5 \\ \hline 0.6 \\ \hline \dots \\ \hline \end{array} \cdot \text{ksf}$$

$$S_{bp\_c2\_st}(5\text{ft}, 0\text{ft}, q_{bp}) = \begin{array}{|c|} \hline 0.018 \\ \hline 0.021 \\ \hline \dots \\ \hline \end{array} \cdot \text{in} \qquad q_{bp} = \begin{array}{|c|} \hline 0.5 \\ \hline 0.6 \\ \hline \dots \\ \hline \end{array} \cdot \text{ksf}$$

**Results**

Figures B6-9 through B6-12 present the estimated settlements versus foundation pressure for square and strip footings. Settlements are evaluated with the Burland and Burbidge, and Schmertmann methods. Figures B6-9 and B6-10 present the results for square and strip footings with 6-foot foundation embedment depth, respectively. Figures B6-11 and B6-12 present the results for square and strip footings with 2-foot foundation embedment depth, respectively.

APPENDIX B - BEARING CAPACITY AND SETTLEMENT

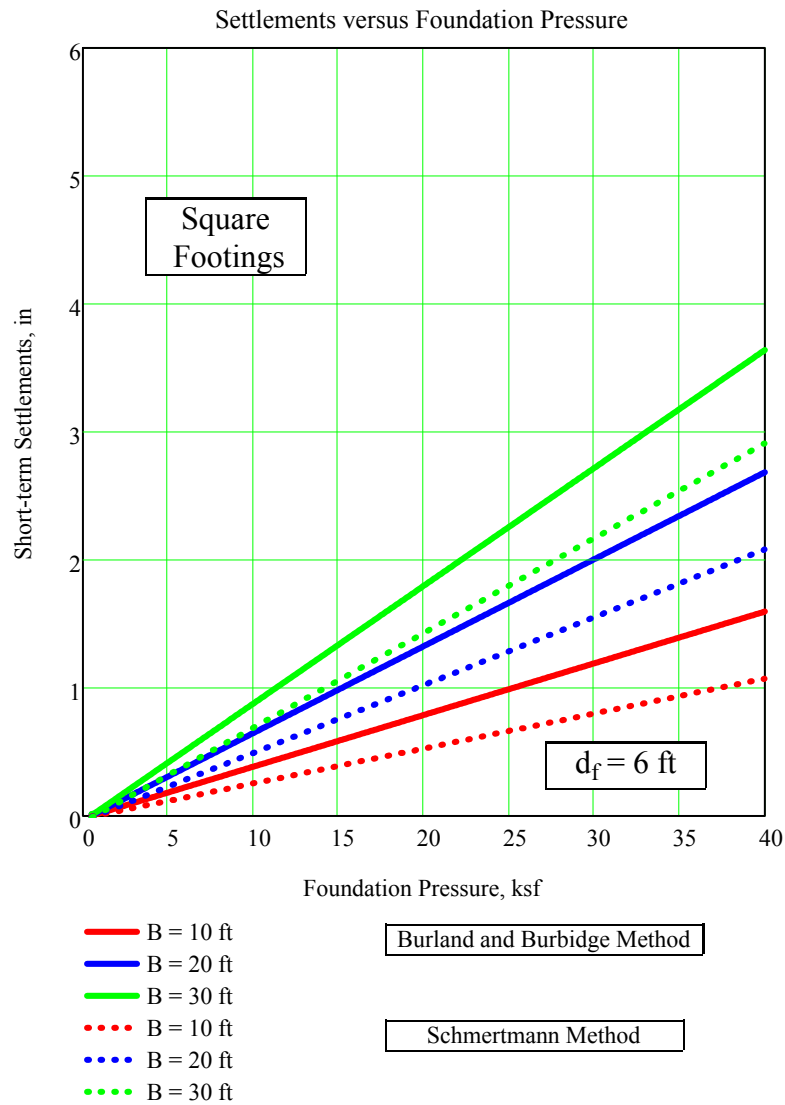


Figure B6-9. Short-term settlements versus foundation pressure for square footings



APPENDIX B - BEARING CAPACITY AND SETTLEMENT

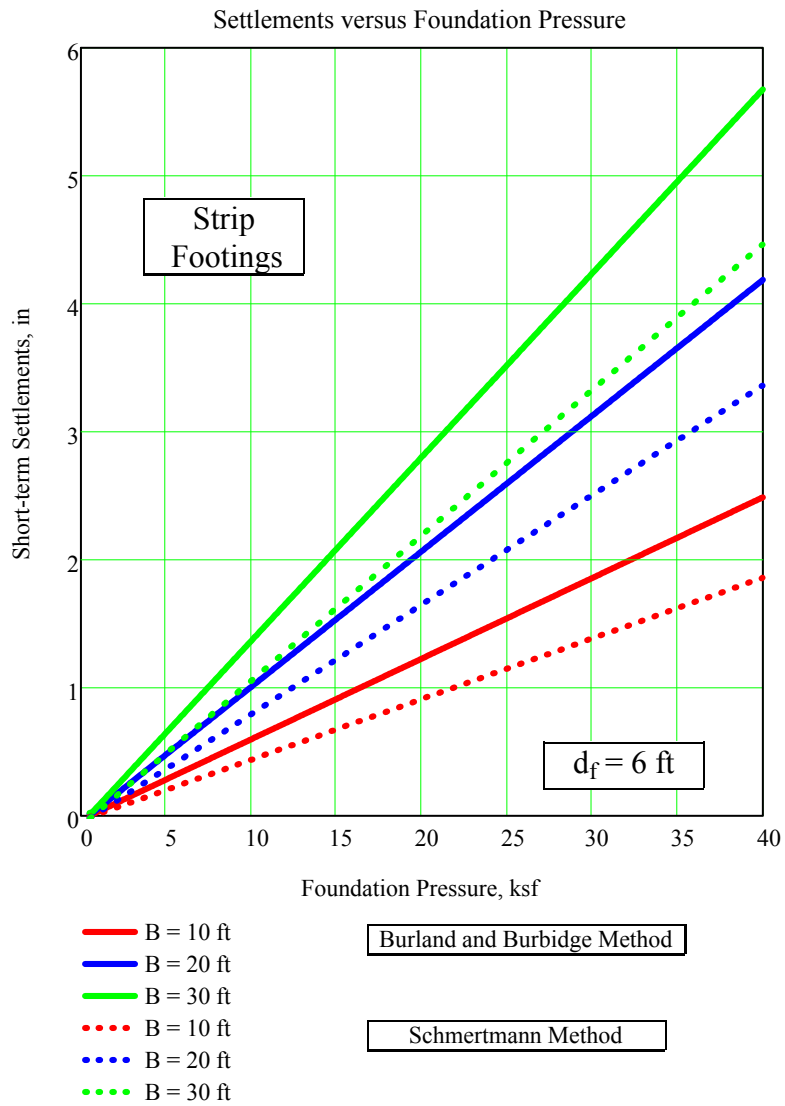


Figure B6-10. Short-term settlements versus foundation pressure for strip footings

APPENDIX B - BEARING CAPACITY AND SETTLEMENT

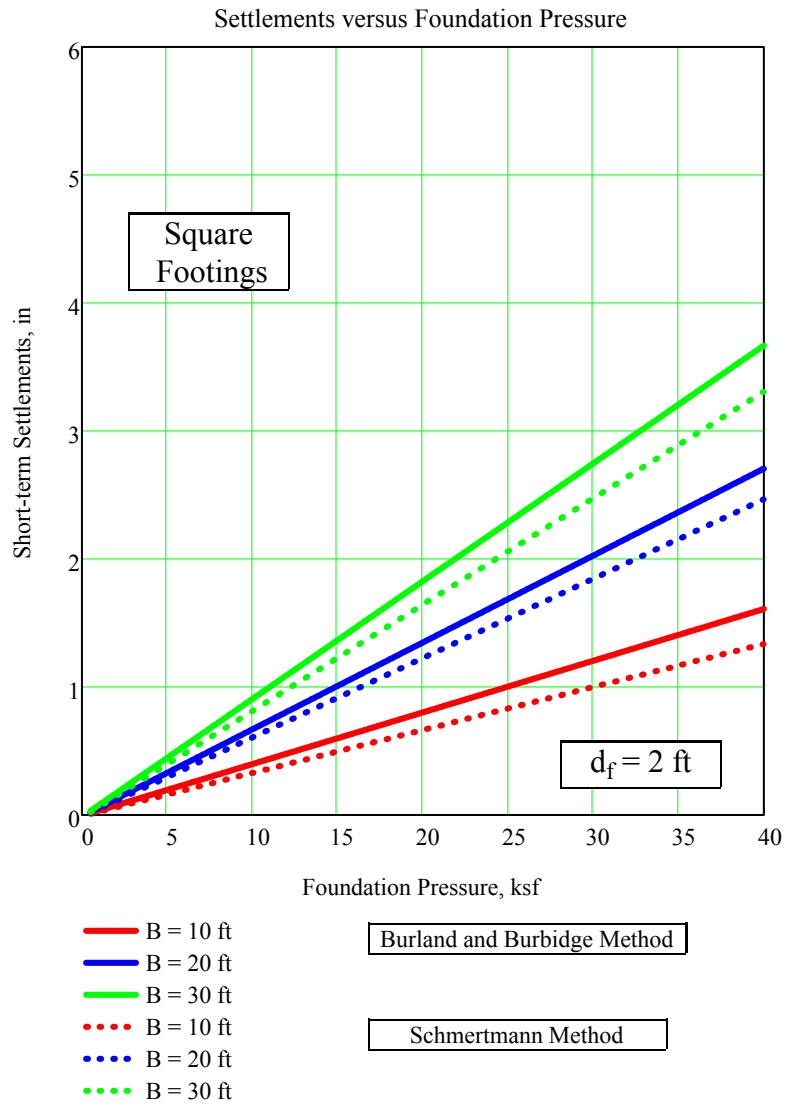


Figure B6-11. Short-term settlements versus foundation pressure for square footings

APPENDIX B - BEARING CAPACITY AND SETTLEMENT

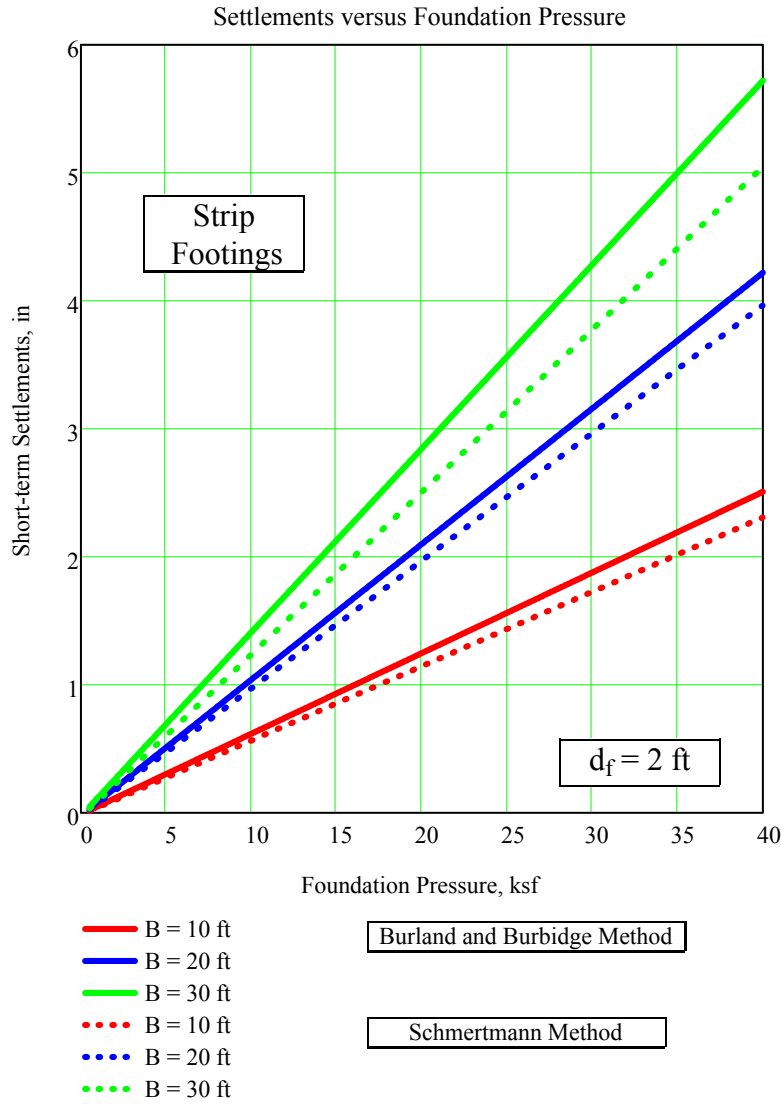


Figure B6-12. Short-term settlements versus foundation pressure for strip footings

APPENDIX B - BEARING CAPACITY AND SETTLEMENT

A comparison of the above methods show similar results for the design pressure. Results from the Schmertmann method are adopted since more data from the project (shear wave velocity) is available for this method. The Burland and Burbidge method uses an  $N_{60}$  value, which was derived from relative density measurements. The design pressure calculated by the Schmertmann method is limited for larger footing sizes for conservatism.

Figures B6-13 through B6-16 present our recommendations to the project for allowable foundation pressures and immediate settlements.

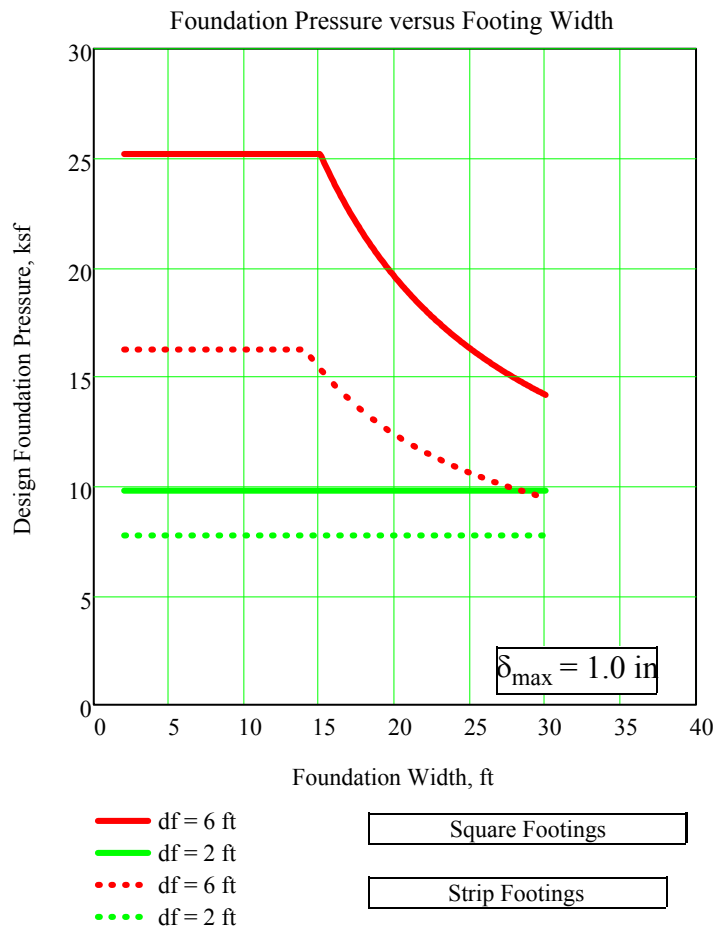


Figure B6-13. Design foundation pressure versus foundation width for square and strip footings considering a maximum allowable foundation settlement of 1.0 in

APPENDIX B - BEARING CAPACITY AND SETTLEMENT

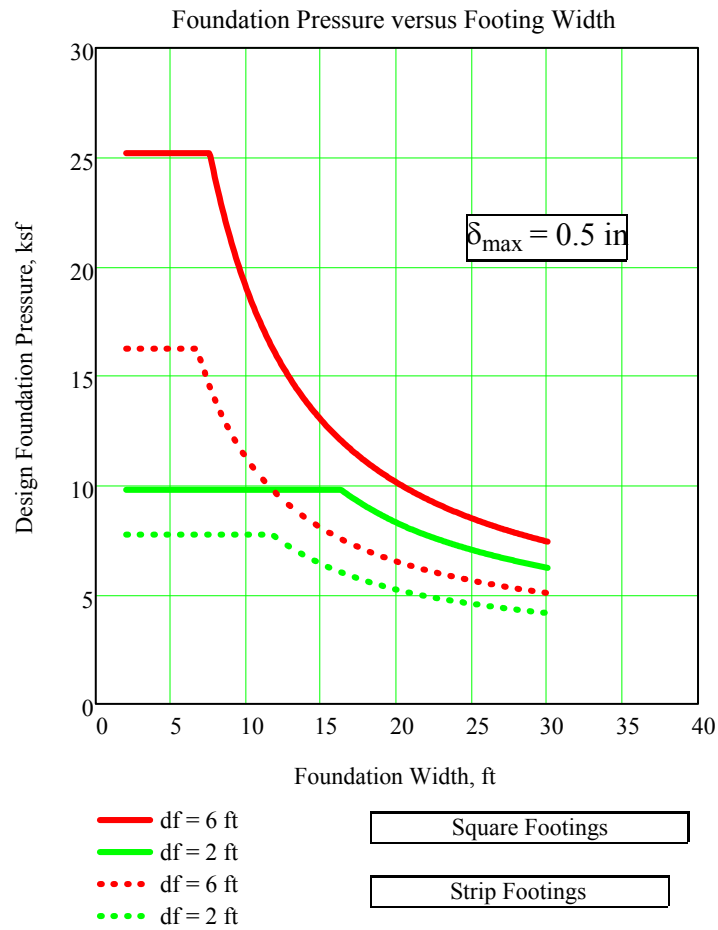


Figure B6-14. Design foundation pressure versus foundation width for square and strip footings considering a maximum allowable foundation settlement of 0.5 in

APPENDIX B - BEARING CAPACITY AND SETTLEMENT

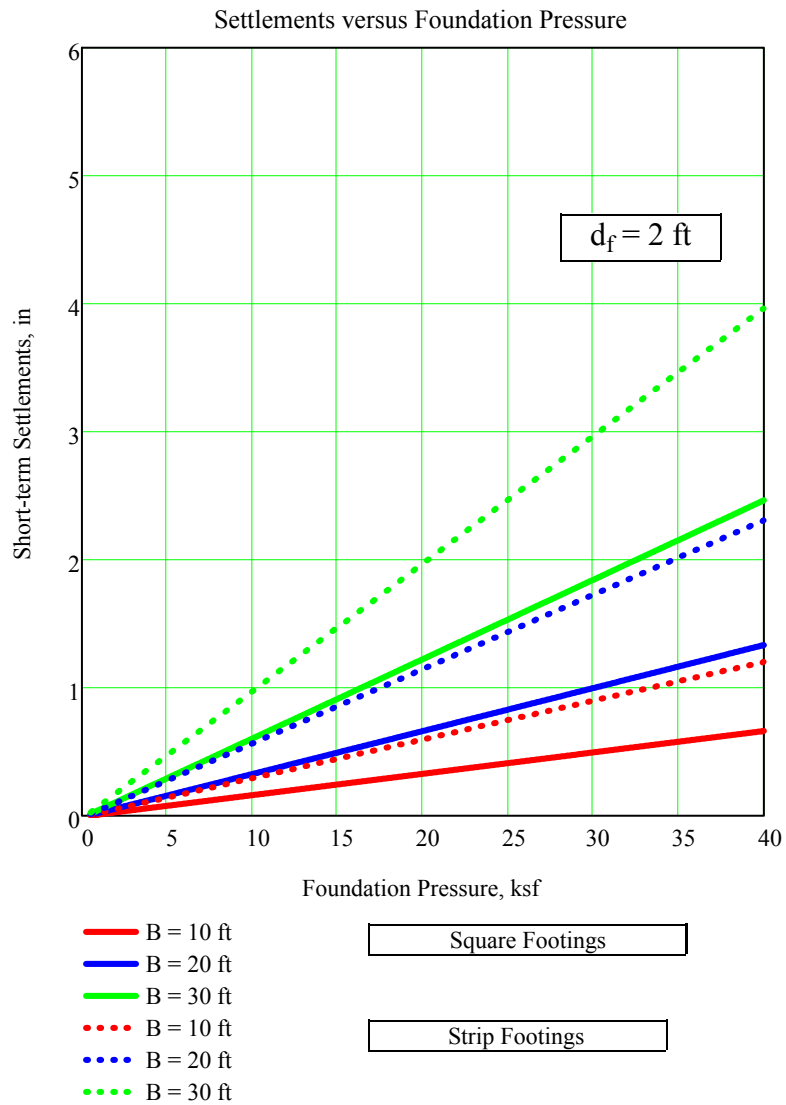


Figure B6-15. Short-term settlements versus foundation pressure for strip footings

APPENDIX B - BEARING CAPACITY AND SETTLEMENT

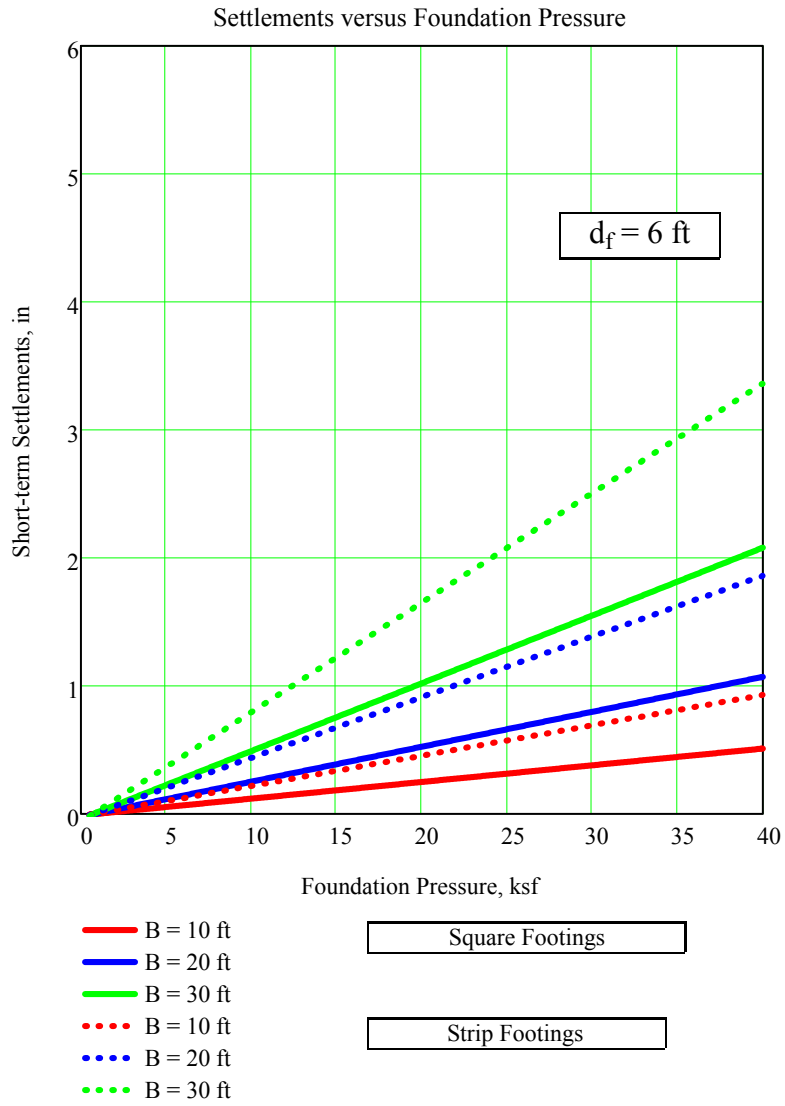


Figure B6-16. Short-term settlements versus foundation pressure for strip footings

APPENDIX B - BEARING CAPACITY AND SETTLEMENT

**B6.6 Long-term Settlements**

The Burland and Burbidge procedure was implemented to compute the footings long-term settlements (see Terzaghi et al, 1996, Section 50.2.5). This method estimates settlements based on the soil standard penetration test blow count ( $N_{60}$ ) values.

***Compression strain***

***Square footings***

$$\epsilon_{c\_sq}(B, d_f, c, \phi, \gamma) := \begin{cases} \frac{1.4}{N_{60}(\phi)^{1.4}} & \text{if } q_{all\_square}(B, d_f, c, \phi, \gamma) > \sigma_{vo}(d_f) \\ \frac{1}{3} \cdot \frac{1.4}{N_{60}(\phi)^{1.4}} & \text{if } q_{all\_square}(B, d_f, c, \phi, \gamma) \leq \sigma_{vo}(d_f) \end{cases}$$

***Strip footings***

$$\epsilon_{c\_st}(B, d_f, c, \phi, \gamma) := \begin{cases} \frac{1.4}{N_{60}(\phi)^{1.4}} & \text{if } q_{all\_strip}(B, d_f, c, \phi, \gamma) > \sigma_{vo}(d_f) \\ \frac{1}{3} \cdot \frac{1.4}{N_{60}(\phi)^{1.4}} & \text{if } q_{all\_strip}(B, d_f, c, \phi, \gamma) \leq \sigma_{vo}(d_f) \end{cases}$$

$$\epsilon_{c\_sq}(5\text{ft}, 0\text{ft}, c, \phi_{eff}, \gamma) = 7.647 \times 10^{-3} \quad \longleftarrow \quad \text{Check value}$$

$$\epsilon_{c\_st}(5\text{ft}, 0\text{ft}, c, \phi_{eff}, \gamma) = 7.647 \times 10^{-3} \quad \longleftarrow \quad \text{Check value}$$

***Secondary compression strain index***

***Square footings***

$$\epsilon_{\alpha\_sq}(B, d_f, c, \phi, \gamma) := 0.02 \cdot \epsilon_{c\_sq}(B, d_f, c, \phi, \gamma)$$



APPENDIX B - BEARING CAPACITY AND SETTLEMENT

---

**Strip footings**

$$\varepsilon_{\alpha\_st}(B, d_f, c, \phi, \gamma) := 0.02 \cdot \varepsilon_{c\_st}(B, d_f, c, \phi, \gamma)$$

$$\varepsilon_{\alpha\_sq}(5\text{ft}, 0\text{ft}, c, \phi_{\text{eff}}, \gamma) = 1.529 \times 10^{-4} \quad \longleftarrow \quad \text{Check value}$$

$$\varepsilon_{\alpha\_st}(5\text{ft}, 0\text{ft}, c, \phi_{\text{eff}}, \gamma) = 1.529 \times 10^{-4} \quad \longleftarrow \quad \text{Check value}$$

**Long-term settlement equation**

**Square footings**

$$S_{c3\_sq}(B, d_f, c, \phi, \gamma) := \varepsilon_{\alpha\_sq}(B, d_f, c, \phi, \gamma) \cdot Z_1(B) \cdot \log\left(\frac{\frac{t}{\text{year}} \cdot \text{day}}{1 \cdot \text{day}}\right)$$

**Strip footings**

$$S_{c3\_st}(B, d_f, c, \phi, \gamma) := \varepsilon_{\alpha\_st}(B, d_f, c, \phi, \gamma) \cdot Z_1(B) \cdot \log\left(\frac{\frac{t}{\text{year}} \cdot \text{day}}{1 \cdot \text{day}}\right)$$

$$S_{c3\_sq}(5\text{ft}, 0\text{ft}, c, \phi_{\text{eff}}, \gamma) = 0.014 \cdot \text{in} \quad \longleftarrow \quad \text{Check value}$$

$$S_{c3\_st}(5\text{ft}, 0\text{ft}, c, \phi_{\text{eff}}, \gamma) = 0.014 \cdot \text{in} \quad \longleftarrow \quad \text{Check value}$$

**Results**

Figures B6-17 presents the estimated long-term settlements versus foundation pressure for square and strip footings and embedment depth considered herein. Settlement are evaluated with the Burland and Burbidge method.

APPENDIX B - BEARING CAPACITY AND SETTLEMENT

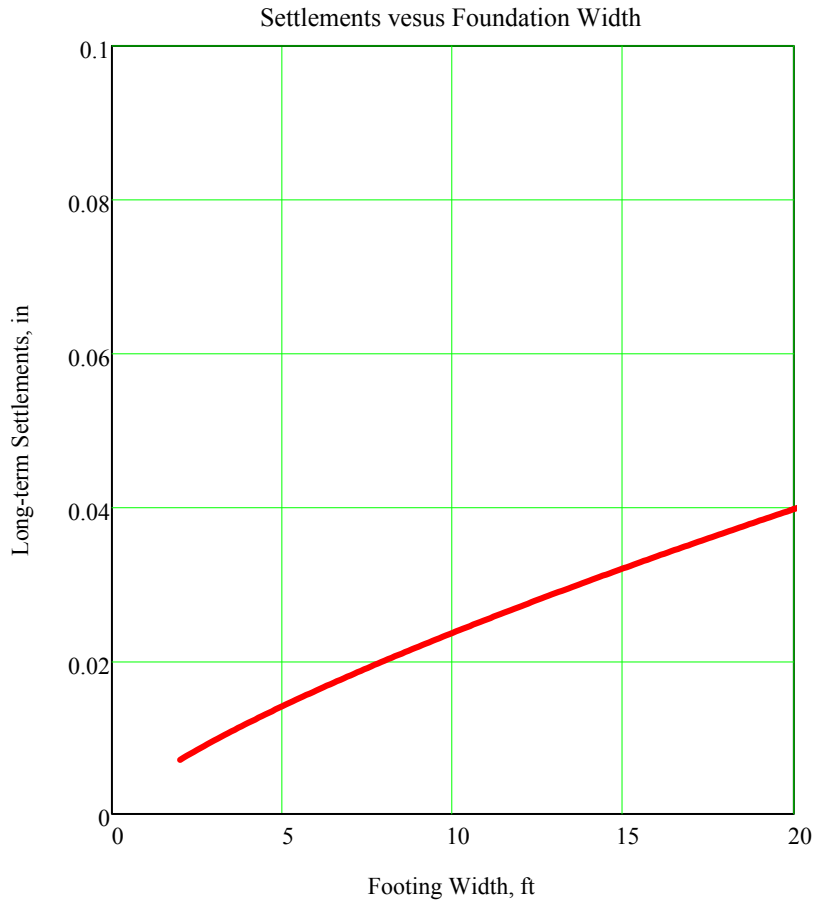


Figure B6-17. Long-term settlements versus footing width for square and strip footings and embedment depth considered herein (i.e., 2 ft and 6 ft).

**Units:**

$kPa \equiv 1000 \cdot Pa$	$psf \equiv \frac{lbf}{ft^2}$	$pcf \equiv \frac{lbf}{ft^3}$	$year \equiv 365 \cdot day$
$MPa \equiv 10^3 \cdot kPa$	$ksf \equiv \frac{1000lbf}{ft^2}$	$tsf \equiv \frac{2000lbf}{ft^2}$	$fps \equiv \frac{ft}{s}$

APPENDIX B – BEARING CAPACITY AND SETTLEMENT

---

**B6.7 Elastic Settlement for Mat Foundation**

Elastic settlements are computed based on a uniform vertical stress distribution, representative average shear wave velocities, and modulus degradation curves for sands. The settlements are determined for uniform vertical loads of 3, 5, and 7 ksf. The following are performed for the computation:

- **Alluvium Thickness** – Divide the alluvium layer (120 feet thick) into 1 ft sublayers ( $h_1, h_2 \dots h_i$ ), where  $i$  = sublayer number. Since the mat thickness used in the analysis is assumed to be 3 feet, subtract 3 feet from the top portion of the alluvium.
- **Vertical Stress Distribution,  $\sigma_z$**  – Compute the vertical stress distribution below the mat (corner and center) for the entire alluvium layer. For a uniform load on a rectangular mat (beneath the mat corner), use the following equation from p. 54 of Poulos and Davis (1991):

$$\sigma_z = \frac{q}{2\pi} \left[ \tan^{-1} \frac{\ell b}{zR_3} + \frac{\ell b z}{R_3} \left( \frac{1}{R_1^2} + \frac{1}{R_2^2} \right) \right], \text{ where} \tag{B1}$$

$$z = \text{depth}$$

$$\ell = \frac{L}{2} \text{ (for distribution at center of foundation)}$$

$$\ell = L \text{ (for distribution at corner of foundation)}$$

$$b = \frac{B}{2} \text{ (for distribution at center of foundation)}$$

$$b = B \text{ (for distribution at corner of foundation)}$$

$$R_1 = (\ell^2 + z^2)^{1/2}$$

$$R_2 = (b^2 + z^2)^{1/2}$$

$$R_3 = (\ell^2 + b^2 + z^2)^{1/2}$$

Multiply Eq. (B1) by 4 for the stress distribution at the center of foundation. Figure B6-18 below shows the stress distributions for the 3 uniform vertical loads.

APPENDIX B – BEARING CAPACITY AND SETTLEMENT

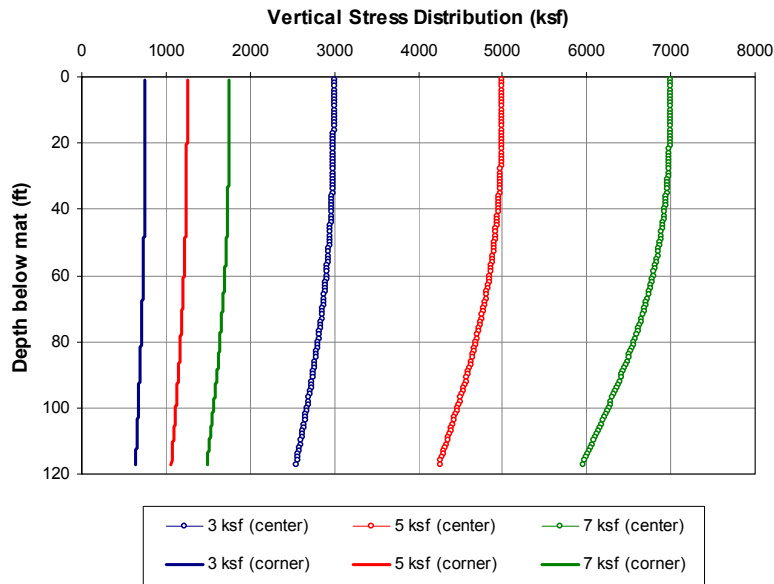


Figure B6-18. Vertical stress distribution versus depth for vertical loads of 3, 5, and 7 ksf.

- Modulus Degradation Curves** – Select appropriate modulus degradation curves ( $G/G_{max}$  versus shear strain,  $\gamma_t$ ) to be used to determine the strains induced in the alluvium layer during vertical loading. Dynamic testing was performed on one reconstituted alluvium sample in BSC (2002a). The modulus degradation curve obtained from the testing closely follows the mean curve from Seed and Idriss (1970) for sands as shown below:

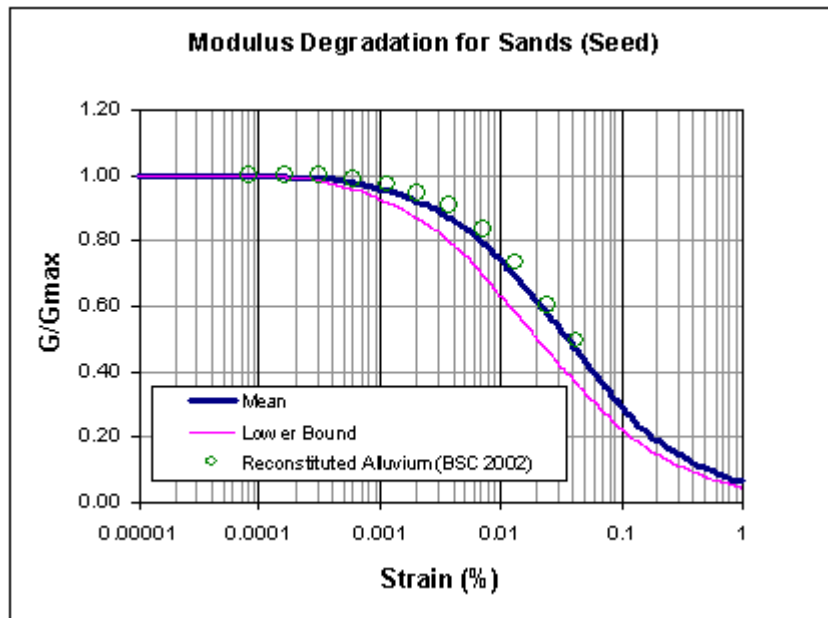


Figure B6-19. Modulus degradation curves for sandy material.

The lower bound curve from Seed and Idriss (1970) is included in the analyses for conservatism.

APPENDIX B – BEARING CAPACITY AND SETTLEMENT

- **Shear Wave Velocity,  $V_s$**  – Select representative shear wave velocity values for the alluvium layer to be used for the analyses. Table B6-1 (data determined in Appendix A) summarizes the lower bound (mean minus one standard deviation) and mean  $V_s$  values used at different depths in the alluvium for the analysis:

**Table B6-1. Average shear wave velocity values (computed in Appendix A).**

Depth from ground surface (ft)	Lower bound (ft/s)	Mean (ft/s)
0-15	1,200	1,500
15-30	1,400	1,700
30-60	2,000	2,200
60-120	2,200	2,500

- **Young’s Modulus of Elasticity,  $E$  and axial strain,  $\epsilon_a$**  – Use the vertical stress distribution (3, 5, and 7 ksf), the modulus degradation curves (mean and lower bound), and shear wave velocity averages (mean and lower bound) to determine Young’s Modulus and the amount of axial strain induced in the alluvium layer.

The modulus degradation curves are modified to show elastic modulus versus axial strain. It is assumed that the shear modulus degradation relationship,  $G/G_{max}$  is analogous to the elastic modulus degradation,  $E/E_{max}$ . This is a conservative assumption since it is known that the elastic modulus degrades less than the shear modulus. Calculate dynamic  $G_{max}$  from the shear wave velocity values using:

$$G_{max} = \frac{V_s^2 \gamma}{g} \tag{B2}$$

where  $\gamma = 114$  pcf (unit weight of alluvium). Using this, the degradation curves can be modified to show  $G$  versus  $\gamma_t$  for each velocity average.  $E$  can then be determined by:

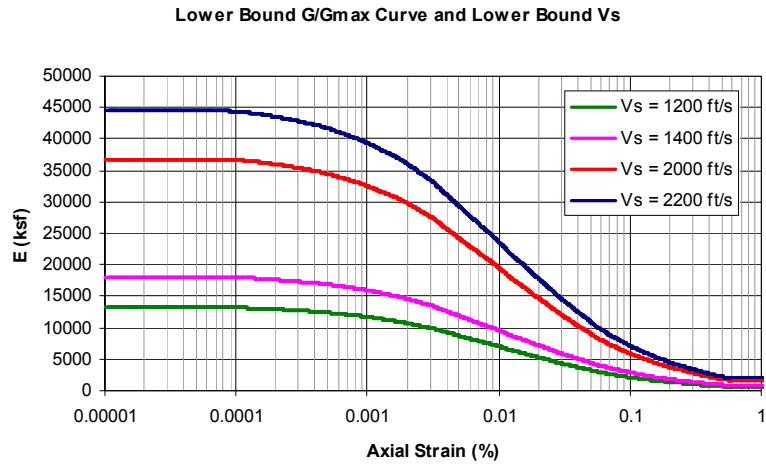
$$E = 2G(1 + \nu) \tag{B3}$$

where  $\nu = 0.3$  (Poisson’s ratio of alluvium). The shear strain,  $\gamma_t$ , can be expressed as axial strain,  $\epsilon_a$ , by the following relationship (Equation 11 of Vucetic and Dobry 1986):

$$\epsilon_a = \frac{\gamma_t}{1.73} \tag{B4}$$

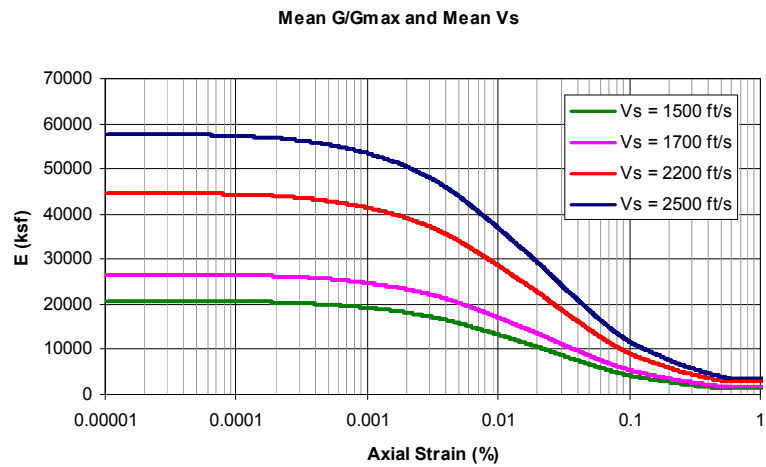
Using (B3) and (B4), the degradation curves can be modified to show  $E$  versus  $\epsilon_a$ . The following curves for combinations of mean and lower bound values of modulus degradation curves and shear wave velocity value are generated:

APPENDIX B – BEARING CAPACITY AND SETTLEMENT



(a)

(b)



(c)

Figure B6-20 (a)-(c). Young's Modulus versus axial strain.

**APPENDIX B – BEARING CAPACITY AND SETTLEMENT**

---

Using the appropriate curve, an initial axial strain can be used to determine the corresponding E. The new axial strain can then be computed using:

$$\varepsilon_a = \frac{\sigma_z}{E} \tag{B5}$$

where  $\sigma_z$  is computed in (B1) for 3, 5, and 7 ksf vertical loading. The new strain can then be used with the curves to determine a new E. This iterative process using (B5) is continued until the axial strain converges, which represents the amount of strain induced in the alluvium due to the vertical loading.

- **Settlement** – Compute the total settlement of the alluvium from the final axial strains by summing the settlements in each alluvium layer using:

$$Settlement = \sum_{i=1}^{120} \varepsilon_i h_i \tag{B6}$$

The calculations are performed for each vertical load case (3, 5, and 7 ksf) for the following bound conditions of modulus degradation and shear wave velocity (Table B6-2):

**Table B6-2. Shear wave velocity and modulus degradation curve bound conditions used in analysis.**

Shear wave velocity	Modulus degradation
Lower	Lower
Lower	Mean
Mean	Mean

Table B6-3 shows a sample EXCEL spreadsheet calculation (center of the mat foundation under 5 ksf loading using mean values of the shear wave velocity and modulus degradation curve for sands).

The results of the analyses (center and corner of the mat for different shear wave velocity and modulus degradation bound conditions and for various loadings) are shown in Table B6-4. A summary of the expected elastic settlements is shown in Section B7 of this calculation. Because of the conservatism in assuming that Young’s modulus, E, degrades the same as the shear modulus for sands, the calculated settlements may be unrealistically high. Hence, for the summary table in Section B7, the settlements computed using the lower bounds of the shear wave velocity and modulus degradation are not used.

APPENDIX B – BEARING CAPACITY AND SETTLEMENT

Table B6-3. Example EXCEL spreadsheet to calculate elastic settlement.

MEAN VELOCITY PROFILE

MEAN SEED AND IDRIS (1970) CURVE

B = 300 ft      B/2 = 150 ft  
 L = 400 ft      L/2 = 200 ft  
 q = 5000 psf      ↵ 114 pcf  
                          ↵ 0.3

SETTLEMENT TOTAL	0.54	in
STRAIN LEVEL	0.15	%

Depth from bottom of mat (ft)	z (ft)	Stress distribution for Uniform Loading on Rectangular Area				Initial strains from Vs					Iterative process E		Sett. (in)	
		R1	R2	R3	z (psf)	Vs (ft/s)	Gmax (ksf)	Emax (ksf)	ε <sub>initial</sub> (%)	ε <sub>initial</sub> (%)	static (ksf)	ε <sub>final</sub> (%)		
0		200	150	250										
1	1	200	150	250	5000	1500	7966	20711	0.024	0.014	3326	0.15	0.018	
2	1	200	150	250	5000	1500	7966	20711	0.024	0.014	3326	0.15	0.018	
3	1	200	150	250	5000	1500	7966	20711	0.024	0.014	3326	0.15	0.018	
4	1	200	150	250	5000	1500	7966	20711	0.024	0.014	3326	0.15	0.018	
5	1	200	150	250	5000	1500	7966	20711	0.024	0.014	3326	0.15	0.018	
6	1	200	150	250	5000	1500	7966	20711	0.024	0.014	3326	0.15	0.018	
7	1	200	150	250	5000	1500	7966	20711	0.024	0.014	3326	0.15	0.018	
8	1	200	150	250	5000	1500	7966	20711	0.024	0.014	3326	0.15	0.018	
9	1	200	150	250	4999	1500	7966	20711	0.024	0.014	3326	0.15	0.018	
10	1	200	150	250	4999	1500	7966	20711	0.024	0.014	3326	0.15	0.018	
11	1	200	150	250	4999	1500	7966	20711	0.024	0.014	3326	0.15	0.018	
12	1	200	150	250	4999	1500	7966	20711	0.024	0.014	3326	0.15	0.018	
13	1	200	151	250	4998	1700	10232	26602	0.019	0.011	6381	0.08	0.009	
14	1	200	151	250	4998	1700	10232	26602	0.019	0.011	6381	0.08	0.009	
15	1	201	151	250	4997	1700	10232	26602	0.019	0.011	6381	0.08	0.009	
16	1	201	151	251	4997	1700	10232	26602	0.019	0.011	6381	0.08	0.009	
17	1	201	151	251	4996	1700	10232	26602	0.019	0.011	6381	0.08	0.009	
18	1	201	151	251	4995	1700	10232	26602	0.019	0.011	6381	0.08	0.009	
19	1	201	151	251	4995	1700	10232	26602	0.019	0.011	6381	0.08	0.009	
20	1	201	151	251	4994	1700	10232	26602	0.019	0.011	6381	0.08	0.009	
21	1	201	151	251	4993	1700	10232	26602	0.019	0.011	6381	0.08	0.009	
22	1	201	152	251	4992	1700	10232	26602	0.019	0.011	6381	0.08	0.009	
23	1	201	152	251	4990	1700	10232	26602	0.019	0.011	6381	0.08	0.009	
24	1	201	152	251	4989	1700	10232	26602	0.019	0.011	6394	0.08	0.009	
25	1	202	152	251	4988	1700	10232	26602	0.019	0.011	6394	0.08	0.009	
26	1	202	152	251	4986	1700	10232	26602	0.019	0.011	6394	0.08	0.009	
27	1	202	152	251	4985	1700	10232	26602	0.019	0.011	6394	0.08	0.009	
28	1	202	153	252	4983	2200	17135	44552	0.011	0.006	21057	0.02	0.003	
29	1	202	153	252	4981	2200	17135	44552	0.011	0.006	21057	0.02	0.003	
30	1	202	153	252	4979	2200	17135	44552	0.011	0.006	21057	0.02	0.003	
31	1	202	153	252	4977	2200	17135	44552	0.011	0.006	21102	0.02	0.003	
32	1	203	153	252	4975	2200	17135	44552	0.011	0.006	21102	0.02	0.003	
33	1	203	154	252	4973	2200	17135	44552	0.011	0.006	21102	0.02	0.003	
34	1	203	154	252	4970	2200	17135	44552	0.011	0.006	21102	0.02	0.003	
35	1	203	154	252	4968	2200	17135	44552	0.011	0.006	21102	0.02	0.003	
36	1	203	154	253	4965	2200	17135	44552	0.011	0.006	21102	0.02	0.003	
37	1	203	154	253	4962	2200	17135	44552	0.011	0.006	21191	0.02	0.003	
38	1	204	155	253	4959	2200	17135	44552	0.011	0.006	21191	0.02	0.003	
39	1	204	155	253	4956	2200	17135	44552	0.011	0.006	21236	0.02	0.003	
40	1	204	155	253	4952	2200	17135	44552	0.011	0.006	21236	0.02	0.003	
41	1	204	156	253	4949	2200	17135	44552	0.011	0.006	21236	0.02	0.003	
42	1	204	156	254	4945	2200	17135	44552	0.011	0.006	21236	0.02	0.003	
43	1	205	156	254	4942	2200	17135	44552	0.011	0.006	21269	0.02	0.003	
44	1	205	156	254	4938	2200	17135	44552	0.011	0.006	21269	0.02	0.003	
45	1	205	157	254	4934	2200	17135	44552	0.011	0.006	21269	0.02	0.003	

continued on next page



APPENDIX B – BEARING CAPACITY AND SETTLEMENT

continued from previous page

46	1	205	157	254	4929	2200	17135	44552	0.011	0.006	21269	0.02	0.003
47	1	205	157	254	4925	2200	17135	44552	0.011	0.006	21269	0.02	0.003
48	1	206	157	255	4920	2200	17135	44552	0.011	0.006	21314	0.02	0.003
49	1	206	158	255	4916	2200	17135	44552	0.011	0.006	21314	0.02	0.003
50	1	206	158	255	4911	2200	17135	44552	0.011	0.006	21314	0.02	0.003
51	1	206	158	255	4906	2200	17135	44552	0.011	0.006	21381	0.02	0.003
52	1	207	159	255	4901	2200	17135	44552	0.011	0.006	21381	0.02	0.003
53	1	207	159	256	4895	2200	17135	44552	0.011	0.006	21425	0.02	0.003
54	1	207	159	256	4890	2200	17135	44552	0.011	0.006	21425	0.02	0.003
55	1	207	160	256	4884	2200	17135	44552	0.011	0.006	21425	0.02	0.003
56	1	208	160	256	4878	2200	17135	44552	0.011	0.006	21470	0.02	0.003
57	1	208	160	256	4872	2200	17135	44552	0.011	0.006	21470	0.02	0.003
58	1	208	161	257	4866	2500	22127	57531	0.008	0.005	32481	0.01	0.002
59	1	209	161	257	4860	2500	22127	57531	0.008	0.005	32481	0.01	0.002
60	1	209	162	257	4853	2500	22127	57531	0.008	0.005	32481	0.01	0.002
61	1	209	162	257	4847	2500	22127	57531	0.008	0.005	32539	0.01	0.002
62	1	209	162	258	4840	2500	22127	57531	0.008	0.005	32539	0.01	0.002
63	1	210	163	258	4833	2500	22127	57531	0.008	0.005	32582	0.01	0.002
64	1	210	163	258	4826	2500	22127	57531	0.008	0.005	32582	0.01	0.002
65	1	210	163	258	4818	2500	22127	57531	0.008	0.005	32582	0.01	0.002
66	1	211	164	259	4811	2500	22127	57531	0.008	0.005	32640	0.01	0.002
67	1	211	164	259	4803	2500	22127	57531	0.008	0.005	32640	0.01	0.002
68	1	211	165	259	4795	2500	22127	57531	0.008	0.005	32683	0.01	0.002
69	1	212	165	259	4788	2500	22127	57531	0.008	0.005	32683	0.01	0.002
70	1	212	166	260	4779	2500	22127	57531	0.008	0.005	32741	0.01	0.002
71	1	212	166	260	4771	2500	22127	57531	0.008	0.005	32741	0.01	0.002
72	1	213	166	260	4763	2500	22127	57531	0.008	0.005	32799	0.01	0.002
73	1	213	167	260	4754	2500	22127	57531	0.008	0.005	32799	0.01	0.002
74	1	213	167	261	4746	2500	22127	57531	0.008	0.005	32842	0.01	0.002
75	1	214	168	261	4737	2500	22127	57531	0.008	0.005	32842	0.01	0.002
76	1	214	168	261	4728	2500	22127	57531	0.008	0.005	32871	0.01	0.002
77	1	214	169	262	4719	2500	22127	57531	0.008	0.005	32871	0.01	0.002
78	1	215	169	262	4709	2500	22127	57531	0.008	0.005	32871	0.01	0.002
79	1	215	170	262	4700	2500	22127	57531	0.008	0.005	32957	0.01	0.002
80	1	215	170	262	4690	2500	22127	57531	0.008	0.005	33015	0.01	0.002
81	1	216	170	263	4681	2500	22127	57531	0.008	0.005	33015	0.01	0.002
82	1	216	171	263	4671	2500	22127	57531	0.008	0.005	33087	0.01	0.002
83	1	217	171	263	4661	2500	22127	57531	0.008	0.005	33130	0.01	0.002
84	1	217	172	264	4651	2500	22127	57531	0.008	0.005	33130	0.01	0.002
85	1	217	172	264	4640	2500	22127	57531	0.008	0.005	33173	0.01	0.002
86	1	218	173	264	4630	2500	22127	57531	0.008	0.005	33173	0.01	0.002
87	1	218	173	265	4620	2500	22127	57531	0.008	0.005	33332	0.01	0.002
88	1	219	174	265	4609	2500	22127	57531	0.008	0.005	33332	0.01	0.002
89	1	219	174	265	4598	2500	22127	57531	0.008	0.005	33433	0.01	0.002
90	1	219	175	266	4587	2500	22127	57531	0.008	0.005	33476	0.01	0.002
91	1	220	175	266	4576	2500	22127	57531	0.008	0.005	33476	0.01	0.002
92	1	220	176	266	4565	2500	22127	57531	0.008	0.005	33534	0.01	0.002
93	1	221	176	267	4554	2500	22127	57531	0.008	0.005	33591	0.01	0.002
94	1	221	177	267	4543	2500	22127	57531	0.008	0.005	33649	0.01	0.002
95	1	221	178	267	4531	2500	22127	57531	0.008	0.005	33649	0.01	0.002
96	1	222	178	268	4520	2500	22127	57531	0.008	0.005	33707	0.01	0.002
97	1	222	179	268	4508	2500	22127	57531	0.008	0.005	33721	0.01	0.002
98	1	223	179	269	4496	2500	22127	57531	0.008	0.005	33721	0.01	0.002
99	1	223	180	269	4484	2500	22127	57531	0.008	0.005	33779	0.01	0.002
100	1	224	180	269	4472	2500	22127	57531	0.008	0.004	33836	0.01	0.002
101	1	224	181	270	4460	2500	22127	57531	0.008	0.004	33836	0.01	0.002
102	1	225	181	270	4448	2500	22127	57531	0.008	0.004	33894	0.01	0.002
103	1	225	182	270	4436	2500	22127	57531	0.008	0.004	33937	0.01	0.002
104	1	225	183	271	4423	2500	22127	57531	0.008	0.004	33966	0.01	0.002
105	1	226	183	271	4411	2500	22127	57531	0.008	0.004	33966	0.01	0.002
106	1	226	184	272	4398	2500	22127	57531	0.008	0.004	33995	0.01	0.002
107	1	227	184	272	4386	2500	22127	57531	0.008	0.004	34053	0.01	0.002
108	1	227	185	272	4373	2500	22127	57531	0.008	0.004	34053	0.01	0.002
109	1	228	185	273	4360	2500	22127	57531	0.008	0.004	34096	0.01	0.002
110	1	228	186	273	4347	2500	22127	57531	0.008	0.004	34139	0.01	0.002
111	1	229	187	274	4334	2500	22127	57531	0.008	0.004	34226	0.01	0.002
112	1	229	187	274	4321	2500	22127	57531	0.008	0.004	34327	0.01	0.002
113	1	230	188	274	4308	2500	22127	57531	0.007	0.004	34356	0.01	0.002
114	1	230	188	275	4295	2500	22127	57531	0.007	0.004	34471	0.01	0.001
115	1	231	189	275	4282	2500	22127	57531	0.007	0.004	34485	0.01	0.001
116	1	231	190	276	4269	2500	22127	57531	0.007	0.004	34485	0.01	0.001
117	1	232	190	276	4255	2500	22127	57531	0.007	0.004	34529	0.01	0.001

APPENDIX B – BEARING CAPACITY AND SETTLEMENT

Table B6-4. Results of elastic settlement analyses.

Load (ksf)	V <sub>s</sub> Bound	G / G <sub>max</sub> Bound	Depth (ft)	V <sub>s</sub> (ft/s)	Settlement Under Center of Mat					Settlement Under Corner of Mat				
					Sett (in)	E <sub>max</sub> (ksf)	□ <sub>b</sub> _initial (%)	E final (ksf)	□ <sub>b</sub> _final (%)	Sett (in)	E <sub>max</sub> (ksf)	□ <sub>b</sub> _initial (%)	E final (ksf)	□ <sub>b</sub> _final (%)
3	Lower	Lower	0 - 12	1200	<b>0.8</b>	13255	0.01	1028	0.29	<b>0.1</b>	13255	0.00	6776	0.01
			13 - 27	1400		18042	0.01	2733	0.11		18042	0.00	10806	0.01
			28 - 57	2000		36820	0.00	14533	0.02		36820	0.00	28364	0.00
			58 - 117	2200		44552	0.00	20633	0.01		44552	0.00	35784	0.00
	Lower	Mean	0 - 12	1200	<b>0.4</b>	13255	0.01	2352	0.13	<b>0.0</b>	13255	0.00	8929	0.01
			13 - 27	1400		18042	0.01	5535	0.05		18042	0.00	13459	0.01
			28 - 57	2000		36820	0.00	21176	0.01		36820	0.00	31670	0.00
			58 - 117	2200		44552	0.00	28313	0.01		44552	0.00	39328	0.00
	Mean	Mean	0 - 12	1500	<b>0.2</b>	20711	0.01	7693	0.04	<b>0.0</b>	20711	0.00	16038	0.00
13 - 27			1700	26602		0.01	12520	0.02	26602		0.00	21773	0.00	
28 - 57			2200	44552		0.00	28045	0.01	44552		0.00	39305	0.00	
58 - 117			2500	57531		0.00	40151	0.01	57531		0.00	52057	0.00	
5	Lower	Lower	0 - 12	1200	<b>2.8</b>	13255	0.02	587	0.85	<b>0.1</b>	13255	0.01	4494	0.03
			13 - 27	1400		18042	0.02	798	0.63		18042	0.00	8093	0.02
			28 - 57	2000		36820	0.01	7823	0.06		36820	0.00	23879	0.01
			58 - 117	2200		44552	0.01	12850	0.04		44552	0.00	31194	0.00
	Lower	Mean	0 - 12	1200	<b>1.6</b>	13255	0.02	818	0.61	<b>0.1</b>	13255	0.01	7082	0.02
			13 - 27	1400		18042	0.02	2208	0.23		18042	0.00	11217	0.01
			28 - 57	2000		36820	0.01	14626	0.03		36820	0.00	28954	0.00
			58 - 117	2200		44552	0.01	21503	0.02		44552	0.00	36521	0.00
	Mean	Mean	0 - 12	1500	<b>0.5</b>	20711	0.01	3326	0.15	<b>0.1</b>	20711	0.00	13629	0.01
13 - 27			1700	26602		0.01	6381	0.08	26602		0.00	19079	0.01	
28 - 57			2200	44552		0.01	21057	0.02	44552		0.00	36509	0.00	
58 - 117			2500	57531		0.00	32481	0.01	57531		0.00	49051	0.00	
7	Lower	Lower	0 - 12	1200	<b>4.4</b>	13255	0.03	587	1.19	<b>0.2</b>	13255	0.01	2879	0.06
			13 - 27	1400		18042	0.02	798	0.88		18042	0.01	6013	0.03
			28 - 57	2000		36820	0.01	4199	0.17		36820	0.00	20760	0.01
			58 - 117	2200		44552	0.01	7666	0.09		44552	0.00	27242	0.01
	Lower	Mean	0 - 12	1200	<b>2.9</b>	13255	0.03	818	0.86	<b>0.1</b>	13255	0.01	5421	0.03
			13 - 27	1400		18042	0.02	1114	0.63		18042	0.01	9476	0.02
			28 - 57	2000		36820	0.01	8721	0.08		36820	0.00	26333	0.01
			58 - 117	2200		44552	0.01	15476	0.04		44552	0.00	33784	0.01
	Mean	Mean	0 - 12	1500	<b>1.3</b>	20711	0.02	1587	0.44	<b>0.1</b>	20711	0.00	11693	0.01
13 - 27			1700	26602		0.02	3717	0.19	26602		0.00	16906	0.01	
28 - 57			2200	44552		0.01	14951	0.05	44552		0.00	33739	0.01	
58 - 117			2500	57531		0.01	26038	0.03	57531		0.00	46352	0.00	

Notes:

1. Assume 120 ft thick Alluvium layer
2. Assume that upper 3 ft of Alluvium will be removed for mat thickness (120 - 3 = 117 total feet of alluvium)
3. Assume Poisson's ratio of Alluvium = 0.3
4. Assume unit weight of soil = 114 pcf
5. Mat dimensions, B = 300 ft, L = 400 ft
6. G/G<sub>max</sub> for Seed and Idriss (1970) curve assumed constant for strains > 1%
7. Iterate strains until difference < 0.001%

APPENDIX B – BEARING CAPACITY AND SETTLEMENT

---

## B7 Results and Conclusion

The following figures and table summarize the results of the bearing capacity and settlement analyses contained herein:

<u>Figure</u>	<u>Description</u>
B7-1	Allowable foundation pressure for square and strip footings on alluvium vs. foundation width and foundation embedment (1-inch design settlement).
B7-2	Allowable foundation pressure for square and strip footings on alluvium vs. foundation width and foundation embedment (1/2-inch design settlement).
B7-3	Immediate settlements for different widths of square and strip footings on alluvium vs. foundation pressure ( $d_f = 2$ ft).
B7-4	Immediate settlements for different widths of square and strip footings on alluvium vs. foundation pressure ( $d_f = 6$ ft).
B7-5	Long-term settlements for square and strip footings with different depths of foundation embedment.
B7-6	Elastic settlement of mat foundation (3 ksf vertical load).
B7-7	Elastic settlement of mat foundation (5 ksf vertical load).
B7-8	Elastic settlement of mat foundation (7 ksf vertical load).

<u>Table</u>	<u>Description</u>
B7-1	Results of elastic settlement of 500' × 450' mat foundation analyses

## **APPENDIX B – BEARING CAPACITY AND SETTLEMENT**

---

Figures B7-1 through B7-4 pertain to bearing capacity and immediate settlement calculations for shallow square and strip footings. For these figures, the results from the Schmertmann method are used since more data (shear wave velocity) is available for this method. The Burland and Burbidge (Terzaghi et al. 1996) method, which is based on blow counts, was not considered reliable. Few blow counts were recorded at the site and due to the high gravel content of the alluvium, are not representative of the more compressible matrix material.

Figure B7-5 presents the long-term settlements evaluation for square and strip footings using the Burland and Burbidge (Terzaghi et al. 1996) method.

Figures B7-6 to B7-8 show the variation with depth of percent of total settlement and percent strain for elastic settlements in the center and corner of a mat foundation. A summary of the predicted total and maximum differential elastic settlements (center and corner of mat foundation) is shown in Table B6-1. The predicted settlements are considered to be very conservative due to the assumption that Young's modulus degrades the same as the shear modulus for sands (alluvium). In actuality, the predicted settlements should be less. Additionally, for the elastic settlement analyses, the stiffness of the mat foundation is not considered to redistribute the loads.

The results of the analyses contained herein appear reasonable for the design of foundations for the expected loading at the Yucca Mountain Project.

APPENDIX B – BEARING CAPACITY AND SETTLEMENT

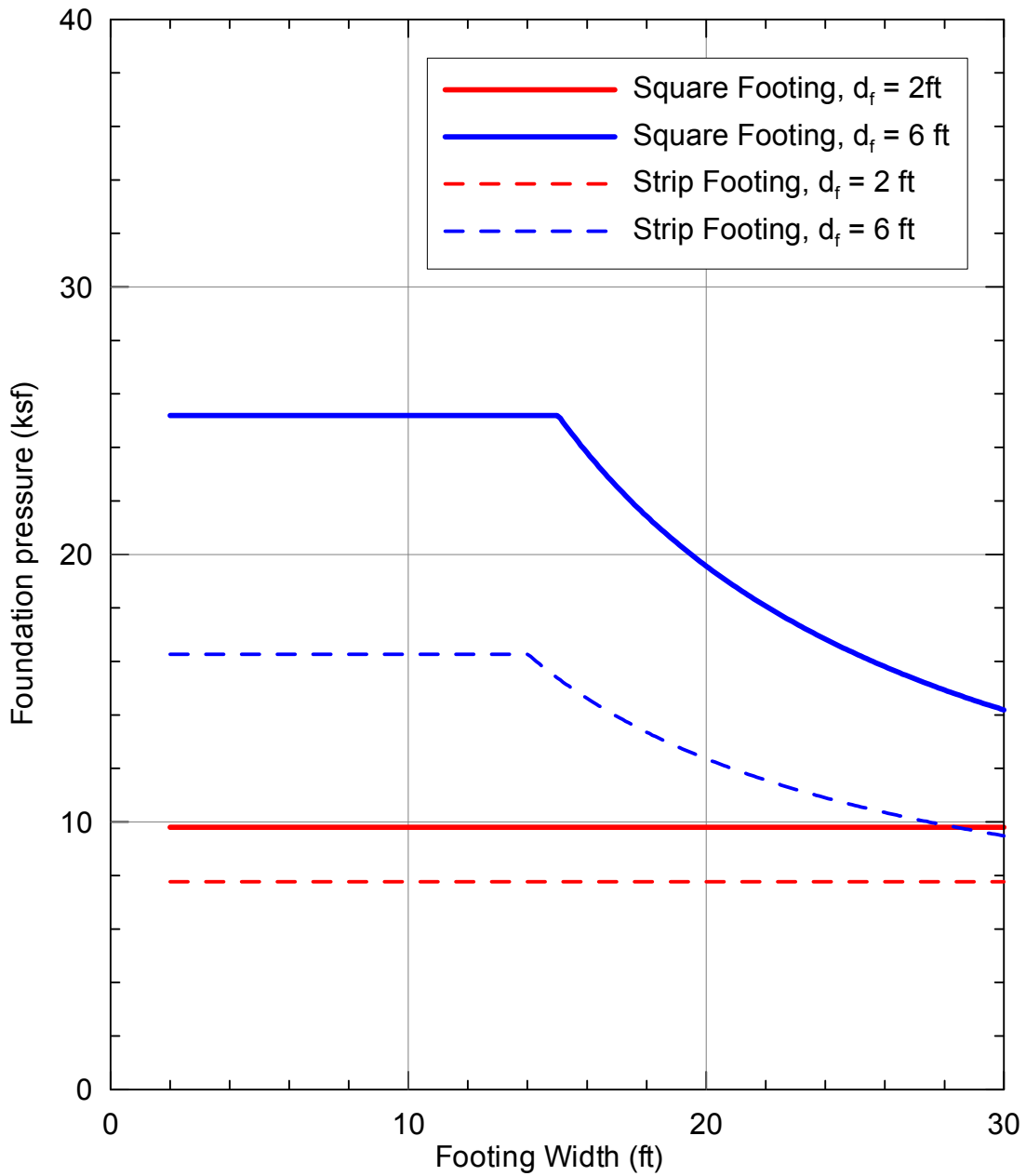


Figure B7-1. Allowable foundation pressure for square and strip footings on alluvium vs. foundation width and foundation embedment (1-inch design settlement).

APPENDIX B – BEARING CAPACITY AND SETTLEMENT

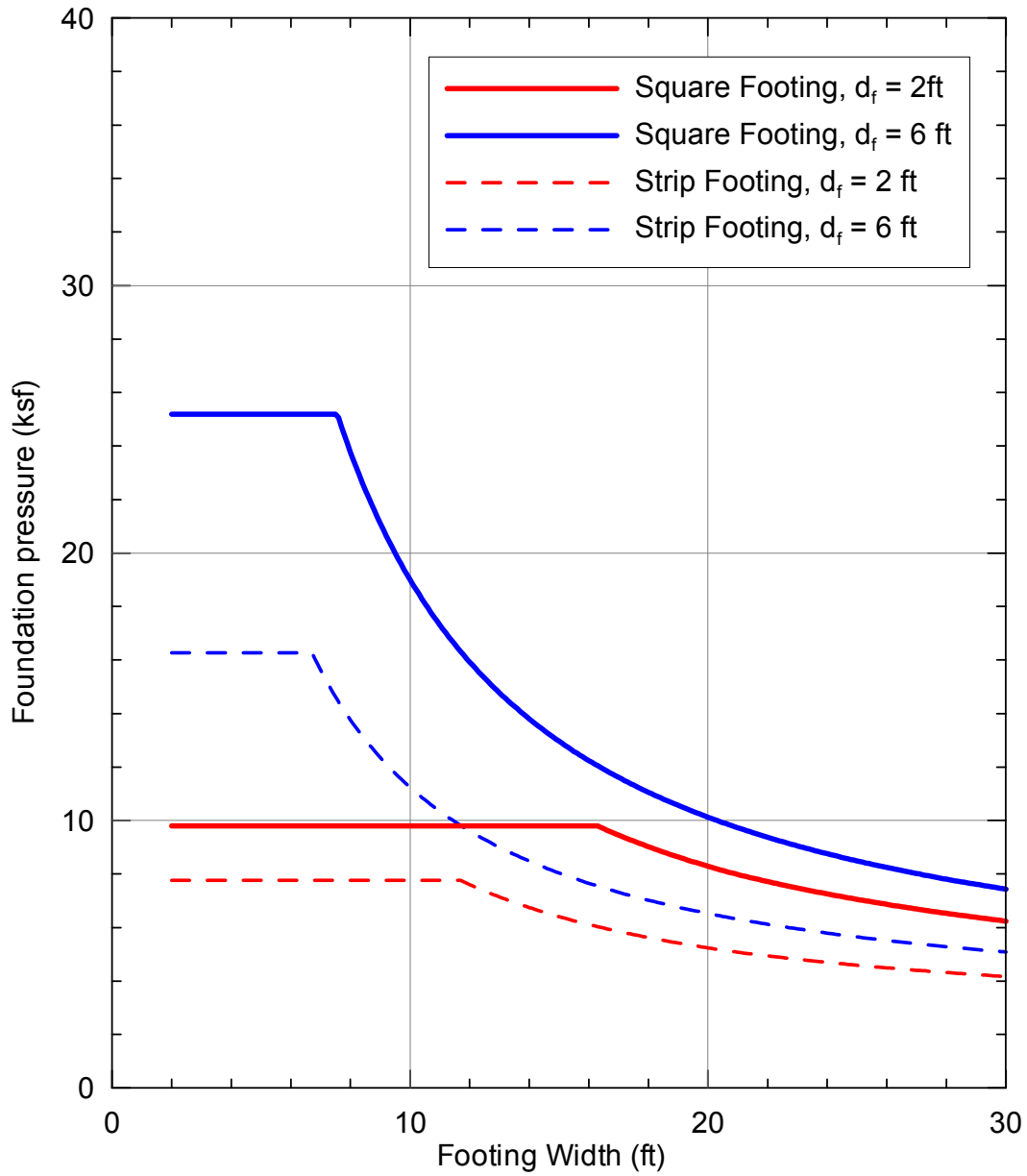


Figure B7-2. Allowable foundation pressure for square and strip footings on alluvium vs. foundation width and foundation embedment (½-inch design settlement).

APPENDIX B – BEARING CAPACITY AND SETTLEMENT

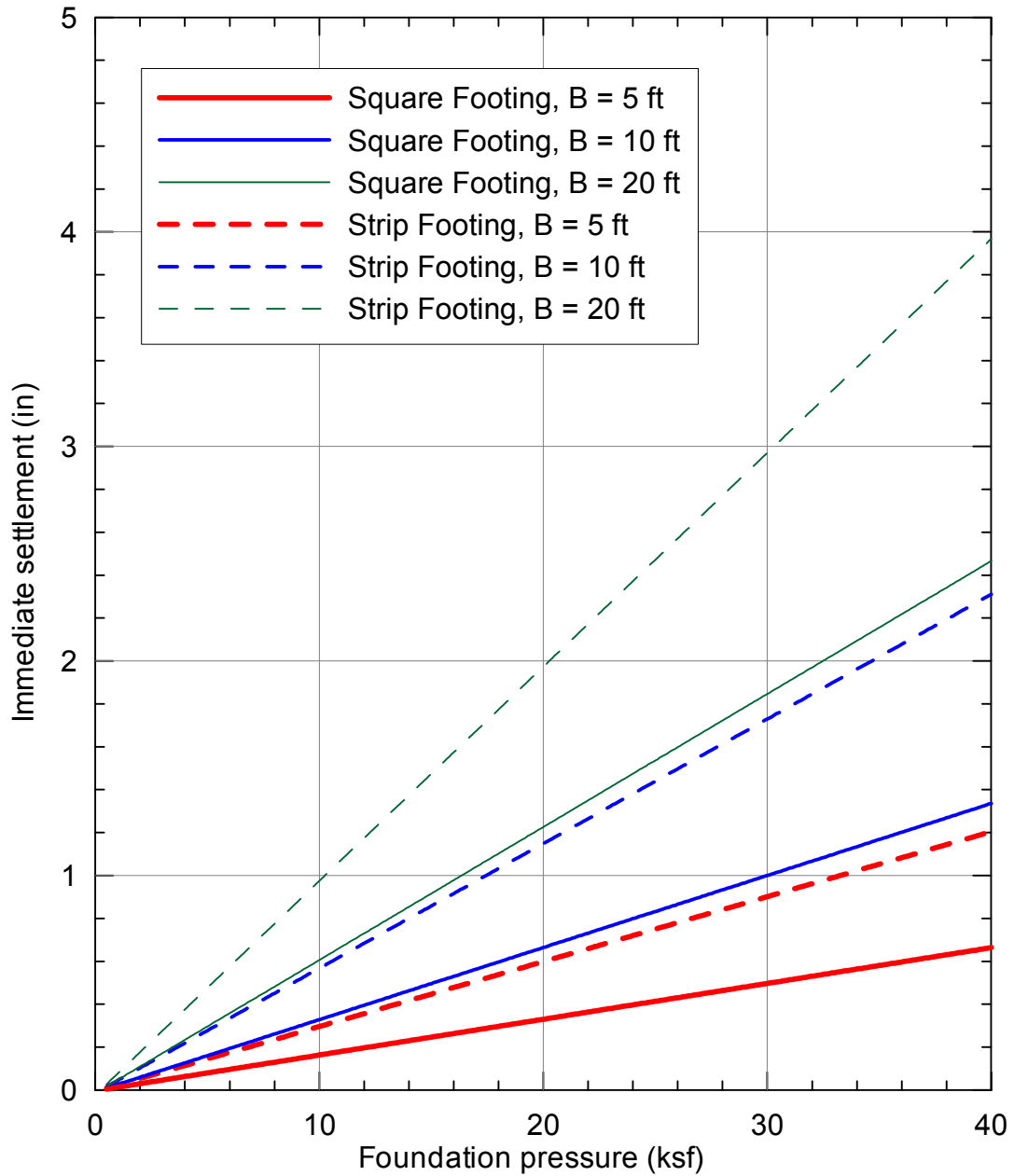


Figure B7-3. Immediate settlements for different widths of square and strip footings on alluvium vs. foundation pressure ( $d_f = 2$  ft)

APPENDIX B – BEARING CAPACITY AND SETTLEMENT

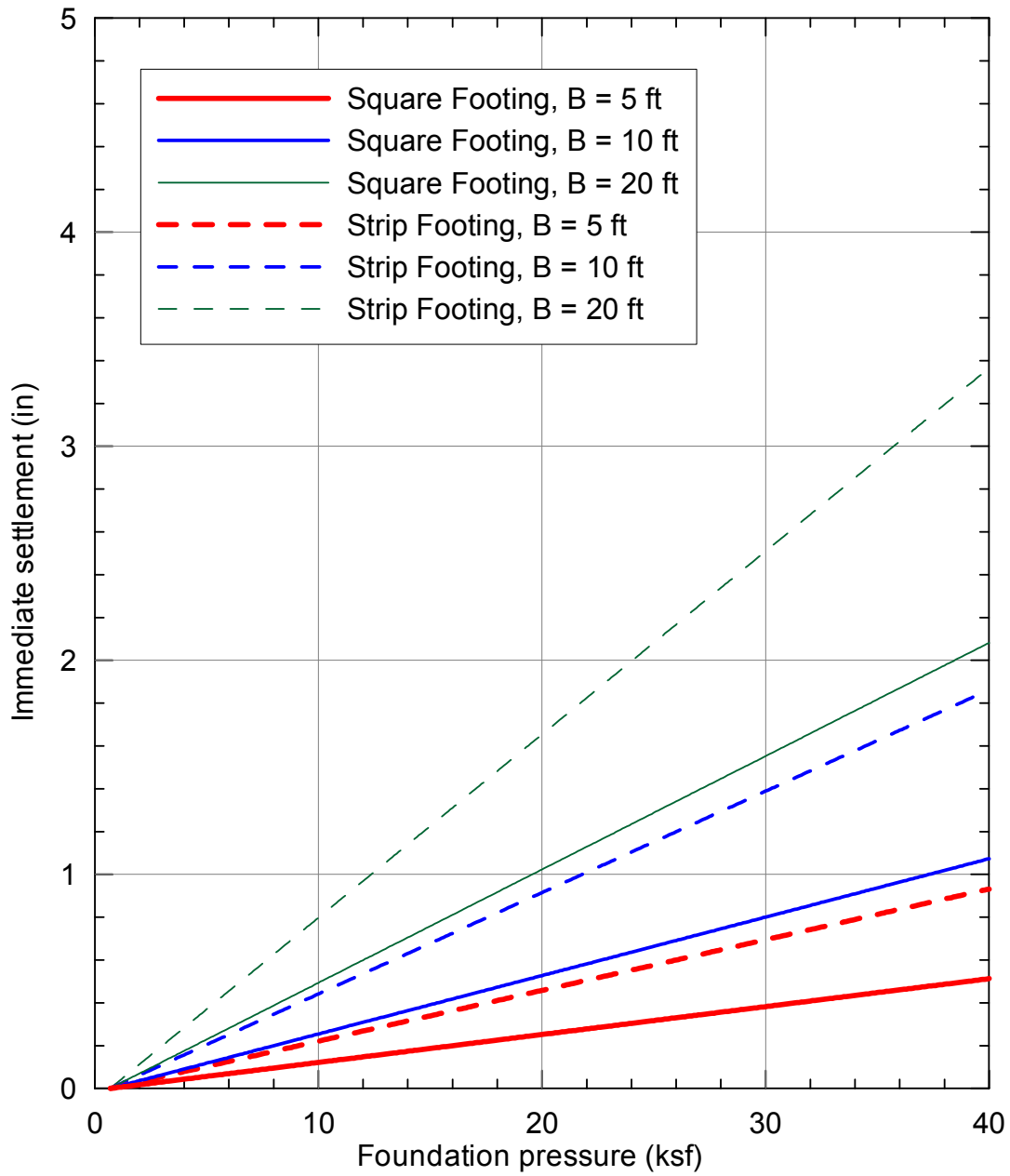
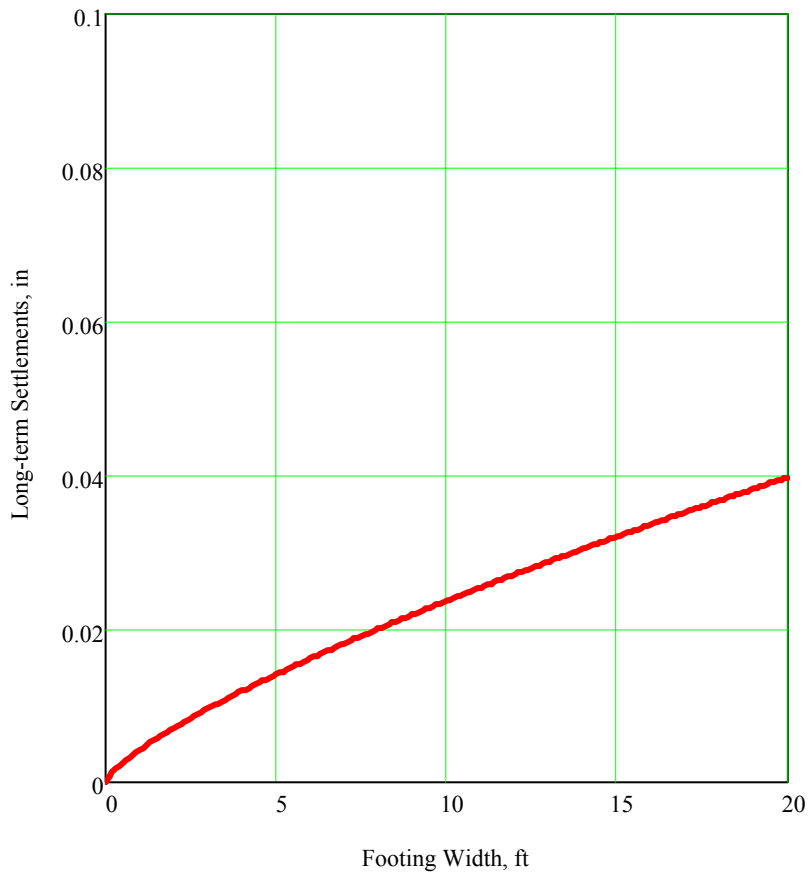


Figure B7-4. Immediate settlements for different widths of square and strip footings on alluvium vs. foundation pressure ( $d_f = 6$  ft).



APPENDIX B – BEARING CAPACITY AND SETTLEMENT

---

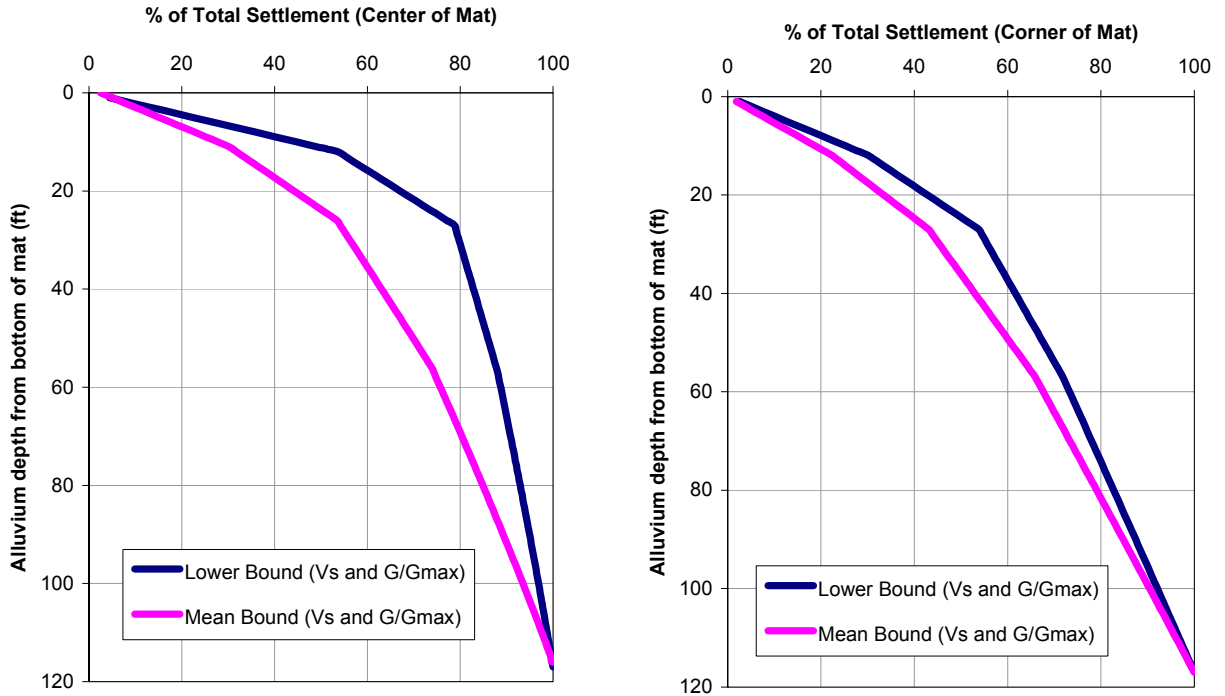


**Figure B7-5. Long-term settlements for square and strip footings and different depths of foundation embedment (for square and strip footings with  $d_f = 2$  ft and 6 ft).**

APPENDIX B – BEARING CAPACITY AND SETTLEMENT

MAT DIMENSIONS: B = 300 FT, L = 400 FT, ASSUME THICKNESS = 3 FT

PERCENT OF TOTAL SETTLEMENT WITH DEPTH FOR 3 KSF LOAD



PERCENT STRAIN WITH DEPTH FOR 3 KSF LOAD

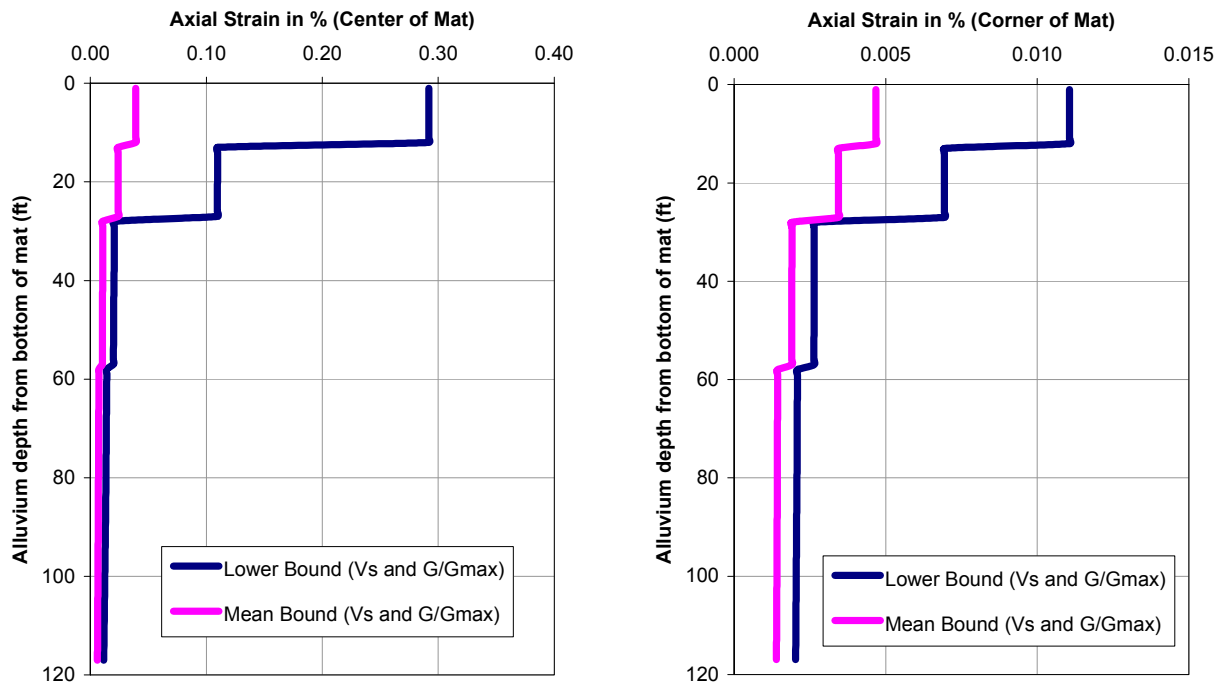
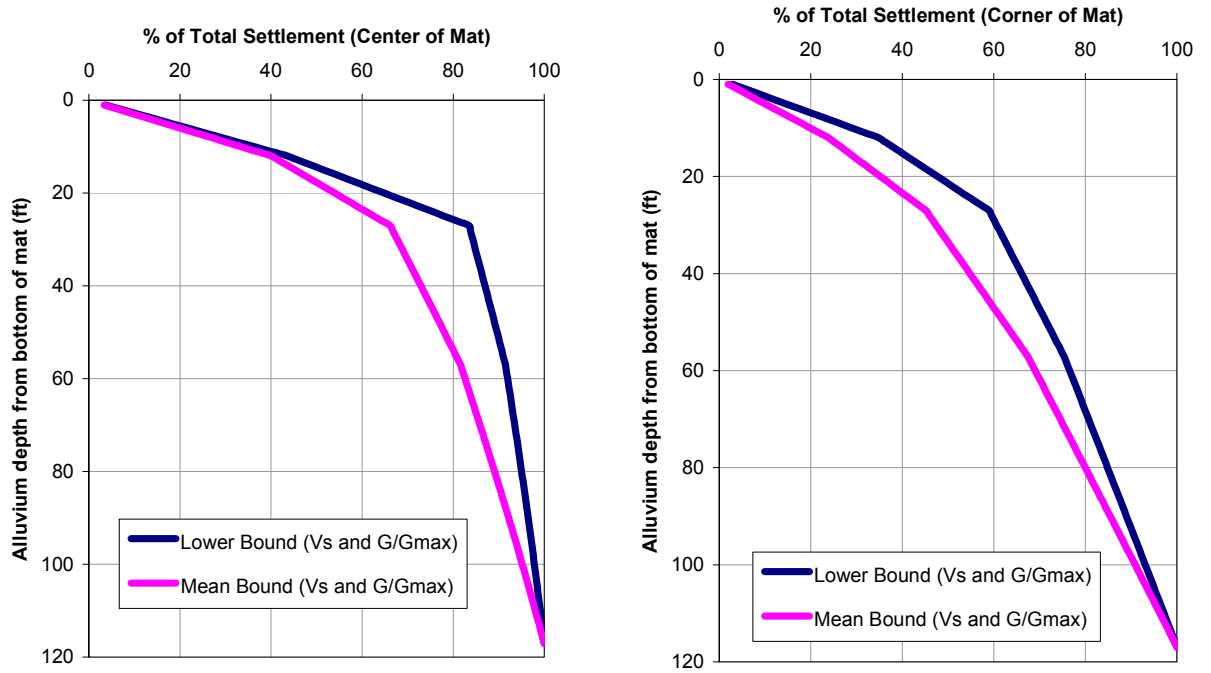


Figure B7-6. Elastic settlement of mat foundation (3 ksf vertical load).

APPENDIX B – BEARING CAPACITY AND SETTLEMENT

MAT DIMENSIONS: B = 300 FT, L = 400 FT, ASSUME THICKNESS = 3 FT

PERCENT OF TOTAL SETTLEMENT WITH DEPTH FOR 5 KSF LOAD



PERCENT STRAIN WITH DEPTH FOR 5 KSF LOAD

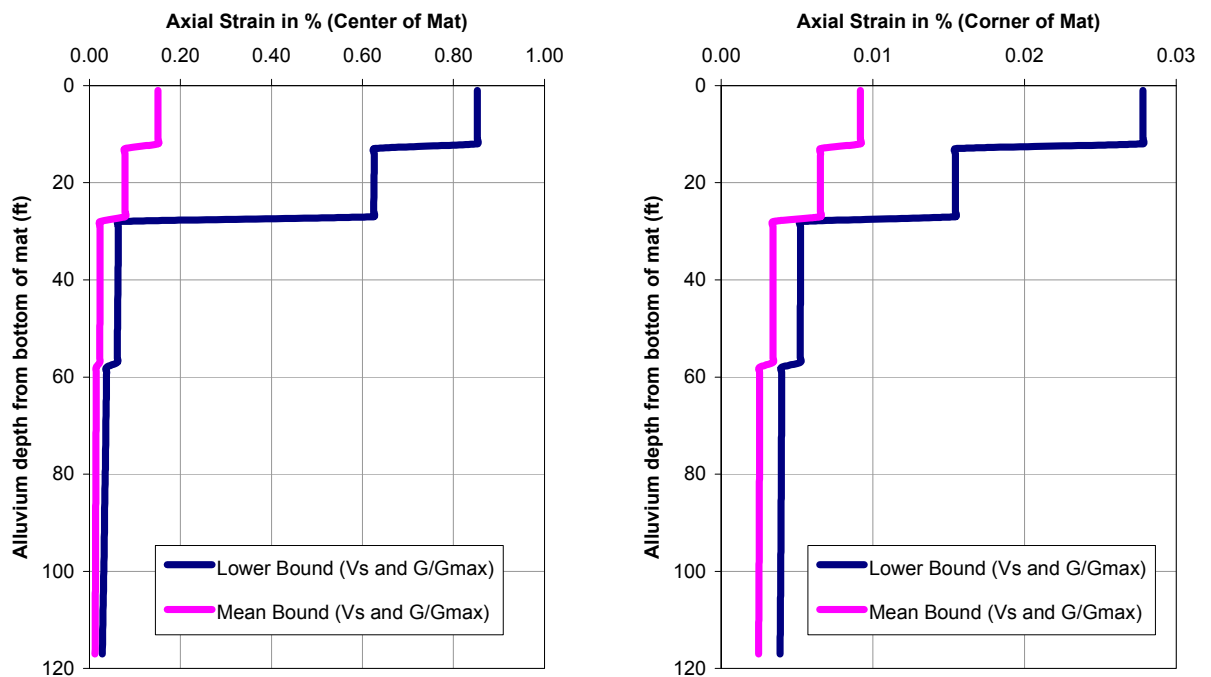
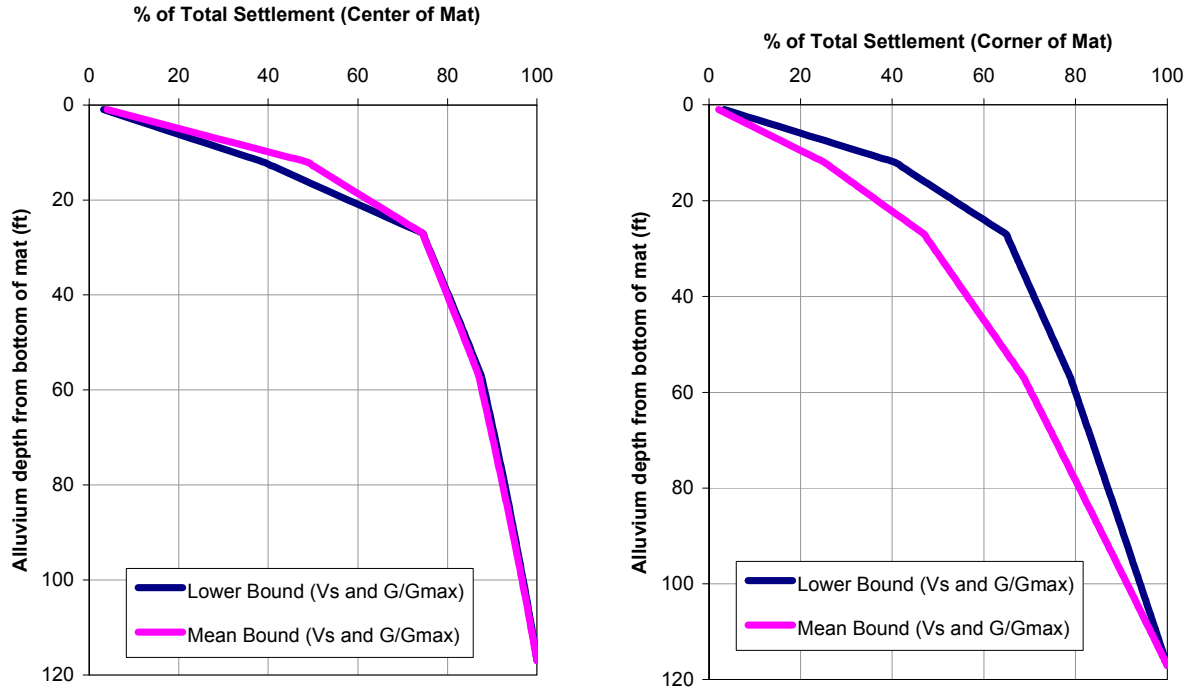


Figure B7-7. Elastic settlement of mat foundation (5 ksf vertical load).

APPENDIX B – BEARING CAPACITY AND SETTLEMENT

MAT DIMENSIONS: B = 300 FT, L = 400 FT, ASSUME THICKNESS = 3 FT

PERCENT OF TOTAL SETTLEMENT WITH DEPTH FOR 7 KSF LOAD



PERCENT STRAIN WITH DEPTH FOR 7 KSF LOAD

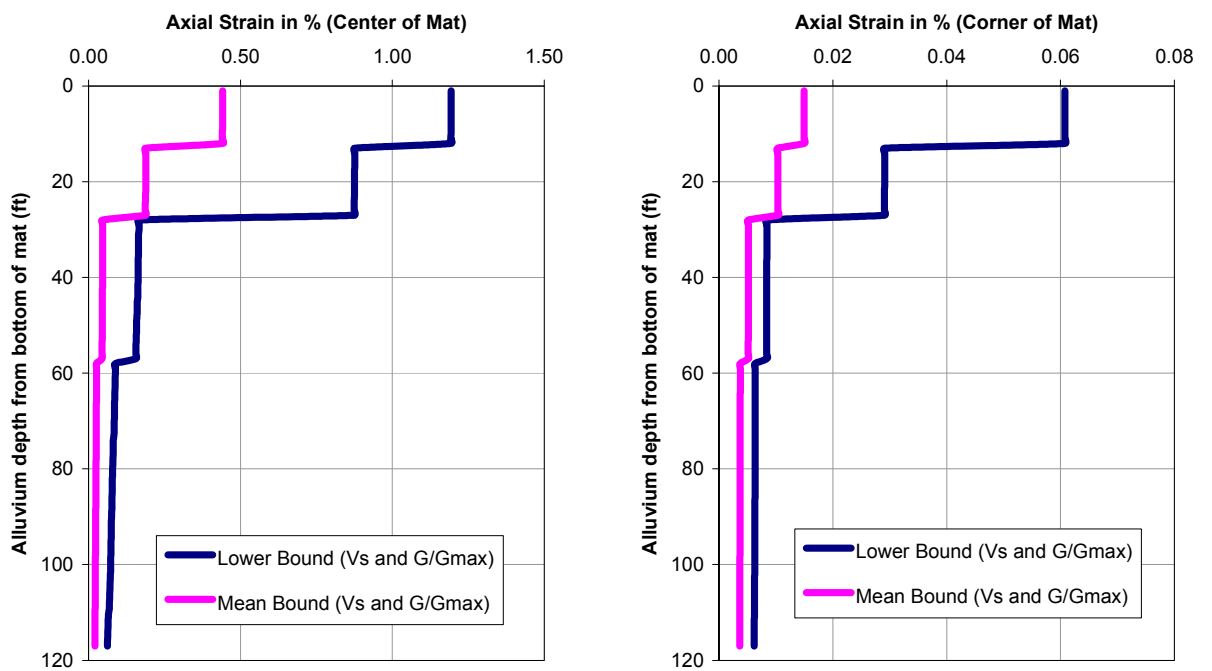


Figure B7-8. Elastic settlement of mat foundation (7 ksf vertical load).

**APPENDIX B – BEARING CAPACITY AND SETTLEMENT**

---

**Table B7-1. Results of elastic settlement of 400' × 300' mat foundation analyses.**

Load (ksf)	Total Settlement		Maximum Differential
	Center of Mat	Corner of Mat	Corner to Center of Mat (340ft)
3	0.2 – 0.4 in	Negligible	0.4 in
5	0.5 – 1.6 in	~ 0.1 in	1.5 in
7	1.3 – 2.9 in	~ 0.1 in	2.9 in

APPENDIX C – LATERAL EARTH PRESSURES AND RESISTANCE TO LATERAL LOADS

---

<b>Appendix C Contents</b>	<b>Page Number</b>
<b>C1 Objective</b> .....	<b>C-2</b>
<b>C2 Inputs</b> .....	<b>C-2</b>
<b>C3 Background</b> .....	<b>C-3</b>
<b>C4 Methodology</b> .....	<b>C-3</b>
C4.1 Static lateral earth pressures .....	C-3
C4.2 Dynamic lateral earth pressures (yielding walls) .....	C-3
C4.3 Dynamic lateral earth pressures (non-yielding walls) .....	C-3
C4.4 Surcharge pressures .....	C-3
C4.5 Compaction-induced pressures.....	C-3
C4.6 Temporary shoring pressure .....	C-4
C4.7 Resistance to lateral loads .....	C-4
<b>C5 Assumptions</b> .....	<b>C-4</b>
<b>C6 Calculations</b> .....	<b>C-4</b>
C6.1 Static lateral earth pressures .....	C-4
C6.2 Dynamic Lateral Pressures .....	C-5
C6.3 Surcharge pressures .....	C-7
C6.4 Compaction-Induced Pressures.....	C-7
C6.5 Temporary Shoring Pressure .....	C-8
C6.6 Resistance to Lateral Loads .....	C-8
C6.6.1 Passive Pressures .....	C-8
C6.6.2 Interface Friction Coefficient .....	C-8
<b>C7 Results / Conclusions</b> .....	<b>C-9</b>
C7.1 Lateral Earth Pressures on Yielding Walls:.....	C-9
C7.2 Lateral Earth Pressures on Non-Yielding Walls.....	C-12
C7.3 Temporary Shoring Pressure .....	C-18
C7.4 Resistance to Lateral Loads .....	C-18
<b>C8 MathCad Worksheets</b> .....	<b>C-18</b>

**APPENDIX C – LATERAL EARTH PRESSURES AND RESISTANCE TO LATERAL LOADS**

## C1 Objective

The purpose of this analysis is to estimate the potential lateral pressures acting at the waste handling surface facilities at Yucca Mountain for yielding and non-yielding walls under static and dynamic conditions. Lateral pressures due to roller and plate compactors and surcharge loads, and lateral pressures acting on temporary shoring are also considered.

Calculations for the resistance to lateral loads resulting from passive resistance or base friction are also performed.

## C2 Inputs

Table C2-1 below lists the parameters used in the analysis contained herein (as determined in Section 10 of this study). Although engineered backfill may be used locally at the site (and is stronger than alluvium), the properties of the alluvium are used in the calculations of this analysis for conservatism. A horizontal seismic coefficient,  $k_h$ , and Poisson's ratio,  $\nu$ , are necessary to determine the dynamic lateral earth pressures and, hence, are also listed below. A coefficient of horizontal acceleration,  $k_h$ , of 1 g is used in the analysis so that it may be scaled for any selected peak ground acceleration, PGA.

**Table C2-1. Parameter Inputs**

Parameter	Alluvium	Engineered Fill
Friction angle, $\phi$	39 deg	42 deg
Unit weight, $\gamma$	117 pcf	127 pcf
Horizontal seismic coefficient, $k_h$	1.0*	-
Poisson's ratio, $\nu$	0.3	-

\*to be scaled for any selected PGA

Several input parameters are needed in order to estimate the lateral earth pressures created from compaction equipment acting on the soil. Table C2-2 below lists the input parameters used in the analysis herein. If a plate compactor is considered, the width and length of the particular equipment is needed for the analysis and thus is also shown in the table below.

**Table C2-2. Compaction Equipment Inputs (Duncan et al. 1991).**

Compactor		Static & Dynamic Force (lbf)	Roller Width (in)	Plate Width (in)	Plate Length (in)	Compactor Distance from Wall (ft)
Name	Type					
Dynapac CA15D	Single-drum vibratory roller	28,800	66	-	-	2, 3, 5
Dynapac CA25	Single-drum vibratory roller	55,800	84	-	-	2, 3, 5
Ingersoll-Rand DX-70	Walk-behind vibratory roller	6,000	25	-	-	0.5, 1, 2
Bomag BP30	Vibratory plate	6,830	-	15	31.1	0, 0.5, 1
Wacker BS62Y	Rammer plate	3,140	-	13	13	0, 0.5, 1

---

**APPENDIX C – LATERAL EARTH PRESSURES AND RESISTANCE TO LATERAL LOADS**

---

## **C3 Background**

The surface of the WHB area is currently covered by generally 5 to 9 feet of existing fill. One isolated location recorded 28 ft of fill, but there is some doubt as to its validity (see Section 5, Assumption 10 of BSC 2002b). The fill is underlain by approximately 10 to 120 feet of alluvium BSC (2002a). It is understood that all of the existing fill is to be removed, and the WHB facility will lie directly on the alluvium.

At this time, a 55-foot below-grade pool is planned to be constructed within the wet-process building. Upon completion of its walls, backfill will be placed against it. Hence, stresses induced by compaction equipment must be considered in calculating the earth pressures acting on this wall.

Due to continuous changes in design, other walls (yielding and non-yielding) may potentially be constructed at the YMP site.

## **C4 Methodology**

The following sections outline the methods used and provide the theory and references that are adopted for the analysis.

### **C4.1 Static lateral earth pressures**

The static analysis is based on the Rankine theory (Fang 1991) for determining earth pressures acting on a wall. Lateral at-rest (for non-yielding walls) and active (for yielding walls) earth pressure forces for a vertical wall with horizontal backfill are determined.

### **C4.2 Dynamic lateral earth pressures (yielding walls)**

The seismic analysis for yielding walls is based on simplified methods to determine the dynamic active earth pressure force. The simplified method developed by Seed and Whitman (1970) is used in this analysis to determine the seismic active pressure force increment.

### **C4.3 Dynamic lateral earth pressures (non-yielding walls)**

Procedures outlined in Section 3.5 of ASCE 4-98 are followed to determine the seismic stress increment acting on non-yielding walls. The analysis does not include the dynamic contribution due to surcharge loads.

### **C4.4 Surcharge pressures**

Static lateral surcharge pressures for non-yielding walls are determined based on elastic solutions. Equations used for various surcharge loads for yielding walls (USN 1986) are shown in Figure C7-2 and Figure C7-3 of this appendix. Live loads are not considered in the analysis.

### **C4.5 Compaction-induced pressures**

Procedures outlined in Duncan and Seed (1986), Duncan et al. (1991), and USN (1986) are followed to determine the additional lateral earth pressures that will develop due to various types of compaction equipment. A comparison with the method outlined in USN (1986) is also performed.



## APPENDIX C – LATERAL EARTH PRESSURES AND RESISTANCE TO LATERAL LOADS

---

### C4.6 Temporary shoring pressure

The pressure acting on temporary shoring during excavation of the alluvium is estimated using Figure 12.22e of Fang (1991) for soldier piles.

### C4.7 Resistance to lateral loads

Sliding friction is estimated based on Table 1 of USN (1986) and per recommendations in BSC (2002a). The Rankine theory is used to estimate passive resistance.

## C5 Assumptions

The following assumptions are made in the analysis:

- Walls are to be vertical with a horizontal backfill.
- Groundwater is deep enough that it will not affect the lateral earth pressures.
- Bedrock is deep enough that it will not affect the lateral earth pressures.
- Wall friction is conservatively assumed to be zero.

All of these assumptions are either sufficiently conservative or represent typical standards used in the industry and do not require further verification.

## C6 Calculations

All calculations are conducted using the computer program Mathcad. The Mathcad worksheets containing the calculations are all located in Section C8 of this calculation. The following sections outline the procedures performed.

### C6.1 Static lateral earth pressures

The following equations are used to determine the static earth pressure coefficients,  $K$ , for various conditions:

$$K_o = 1 - \sin \phi \quad \text{At-rest} \quad (C1)$$

$$K_A = \tan\left(45 - \frac{\phi}{2}\right)^2 \quad \text{Active} \quad (C2)$$

$$K_P = \tan\left(45 + \frac{\phi}{2}\right)^2 \quad \text{Passive} \quad (C3)$$

The distributed pressure and resultant force of each condition are calculated using the following equations:

$$p = K\gamma H \quad \text{Distributed pressure} \quad (C4)$$

$$P = K\gamma \frac{H^2}{2} \quad \text{Resultant force} \quad (C5)$$

where,

H = height of wall

**APPENDIX C – LATERAL EARTH PRESSURES AND RESISTANCE TO LATERAL LOADS**

---

Pressure distribution diagrams are shown in Section C7 of this calculation. Table C6-1 below shows the computed static earth pressure coefficients using the properties of the alluvium. Equivalent fluid weights,  $K\gamma$ , is multiplied by the wall height,  $H$ , to determine lateral earth pressures.

**Table C6-1. Earth Pressure Coefficients.**

Condition	Earth Pressure Coefficient, K	
	Alluvium	Engineered Fill
At-Rest, $K_o$	0.37	0.33
Active, $K_A$	0.23	0.20
Passive, $K_P$	4.4	5.0

**C6.2 Dynamic Lateral Pressures**

Using the simplified method developed by Seed and Whitman (1970), the seismic active earth pressure increment coefficient for a yielding wall is calculated using the following equation:

$$\Delta K_{AE} = \frac{3}{4} k_h \tag{C6}$$

As stated in Section C2, a coefficient of horizontal acceleration,  $k_h$ , of 1 g is used in the analysis so that it may be scaled to any given PGA. The distributed pressure and resultant force increment are calculated using the following equations:

$$\Delta p_{ae} = \Delta K_{AE} \gamma H \quad \text{Distributed pressures} \tag{C7}$$

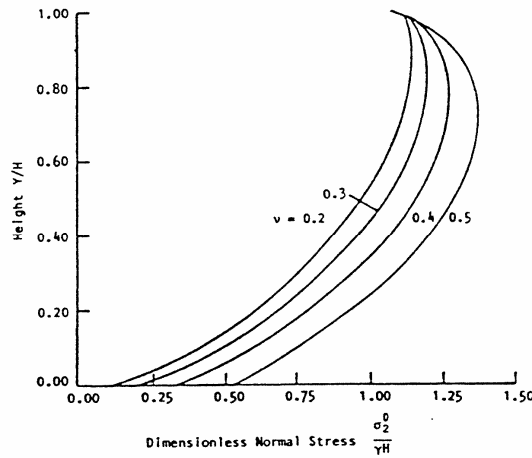
$$\Delta P_{AE} = \Delta K_{AE} \gamma \frac{H^2}{2} \quad \text{Resultant force} \tag{C8}$$

Seed and Whitman (1970) suggest that the component of the resultant force may be taken to act at approximately 0.6H above the wall base. The sum of the initial static active earth pressure force (equation C5), and the dynamic active earth pressure force increment (equation C8) produces the dynamic lateral pressure for a yielding wall:

$$P_{AE} = \Delta P_{AE} + P_A \tag{C9}$$

For non-yielding walls, procedures outlined in Section 3.5 of ASCE 4-98 are followed to determine the incremental stresses developed due to seismic loading. A conservative estimate of the dynamic soil pressures may be obtained from Figure 3500-1 of ASCE 4-98 shown as Figure C6-1 below.

APPENDIX C – LATERAL EARTH PRESSURES AND RESISTANCE TO LATERAL LOADS

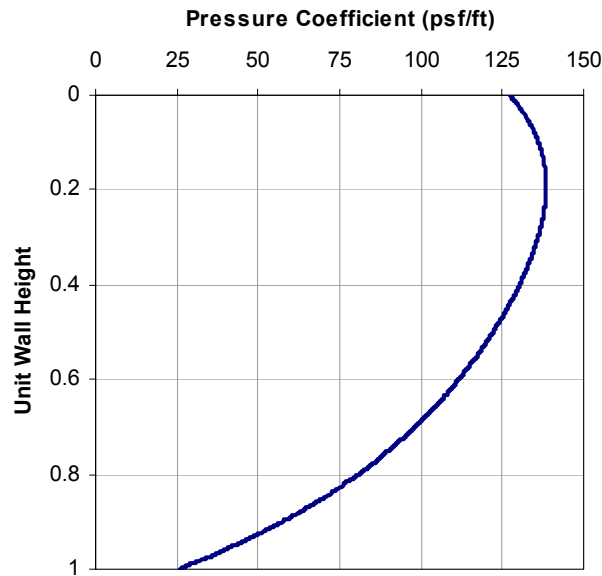


*Explanation*

$H$  = embedment height  
 $\gamma$  = distance from base of retaining structure  
 $\gamma$  = soil unit weight  
 $\nu$  = Poisson's ratio  
 $\sigma_2^0$  = lateral dynamic soil pressure against the retaining structure for 1.0g horizontal earthquake acceleration

**Figure C6-1. Variation of normal dynamic soil pressures for the elastic solution.**

Assuming  $H = 50\text{ft}$ ,  $\gamma = 117\text{ pcf}$ , and  $\nu = 0.3$  (Section 2) for the alluvium, the seismic pressure is determined using Figure C6-1. The pressure can then be scaled to any given coefficient of horizontal acceleration. For the above parameters, Figure C6-2 shows a plot of the seismic pressure coefficient scaled to 1g acceleration versus the unit height of a non-yielding wall. Note that the analysis does not include the dynamic contribution due to surcharge loads.



**Figure C6-2. Seismic pressure coefficient scaled to 1g versus unit height for non-yielding walls (per ASCE 4-98).**

APPENDIX C – LATERAL EARTH PRESSURES AND RESISTANCE TO LATERAL LOADS

C6.3 Surcharge pressures

Static surcharge pressures for non-yielding walls may be calculated as  $K_o \times q$  where  $K_o$  is the static earth pressure coefficient at rest (0.37), and  $q$  is the surcharge load to be applied. The pressure distribution diagrams are shown in Section 7 of this calculation. For yielding walls, refer to the schematic recommendations provided in Section C7 of this calculation. The analysis does not include live loads.

C6.4 Compaction-Induced Pressures

The procedures outlined in Duncan and Seed (1986) are followed to determine the incremental horizontal stresses due to compaction. The equation for the incremental horizontal pressure due to a point load ( $\Delta\sigma_h$ ) presented in Poulos and Davis (1991) is used and modified to taken into account either a roller or plate compactor, the compactor distance from the wall, roller width, plate area, and friction angle of the soil.

Duncan et al. (1991) is used to select various compaction equipment (summarized in Table C2-2). Results are shown as lateral earth pressures due to compaction versus depth. For the analysis, the lateral pressure increment due to compaction is determined and limited to not exceed the passive earth pressures. The pressure increment linearly increases from the depth where it intersects the passive pressure line or where it the pressure is locally at a maximum value near the surface, whichever is larger, until it converges with the at-rest soil pressure line.

The calculations and equations used are provided in Section C8 of this calculation. To avoid redundancy, only one sample calculation for a roller compactor is shown. A check of the results against recommendations from USN (1986) is also included. Figure C6-3 shown below from the USN (1986) manual is used for the check.

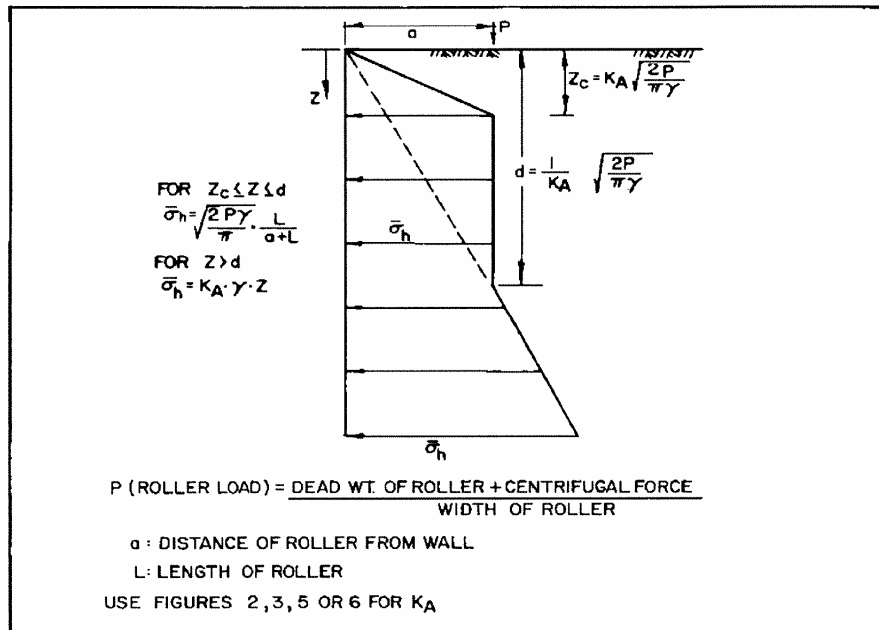


Figure C6-3. Design pressure envelope for non-yielding walls with compaction effects (Figure 13 from USN 1986).

Results of the analysis are shown in Section C7 of this calculation.

APPENDIX C – LATERAL EARTH PRESSURES AND RESISTANCE TO LATERAL LOADS

---

### C6.5 Temporary Shoring Pressure

The pressure of the alluvium acting on temporary shoring provided by soldier piles are estimated using Figure 12.22e in Fang (1991) for sands. The pressure is considered to be uniform acting on the full height of the shoring wall and is expressed by:

$$p_{ts} = 0.65K_A\gamma H = 17.5H \quad (C10)$$

### C6.6 Resistance to Lateral Loads

Resistance to lateral loads can be developed from passive pressure against the vertical face of the sub-grade walls and footings, and from the friction against the base.

#### C6.6.1 Passive Pressures

The coefficient for resistance developed from passive pressures was calculated in Section C6.1. The distributed passive pressure is calculated to be:

$$p_p = K_p\gamma H = 515H \quad (C11)$$

#### C6.6.2 Interface Friction Coefficient

The interface resistance between the soil and structures placed in it is a function of the soil and the structure. Typically, the interface friction coefficient,  $f$ , is estimated to be equal to  $\tan \phi$ , where  $\phi$  is the internal friction angle of the soil. Other adjustments, based on the structural material type and a factor of safety, FS, are also included in the final design value.

The recommended interface friction coefficient between alluvium and concrete is derived from consideration of the soil internal friction angle determined in Section 9 of this study and recommended typical values of interface friction angles published in the literature as described below.

- Internal friction angle,  $\phi$  (see Section C2) = 39 deg
- Estimated base friction,  $f$  =  $\tan 39 \text{ deg} = 0.81$

Bowles 1996 recommends  $f = \tan(\phi)$ . This corresponds to  $f = 0.81$ .

USN 1986 (pp. 7.2-121) recommends for cofferdam allowable design to use  $f = 0.5$  on smooth rock, or  $\tan(\phi)$  otherwise. The worst case is 0.5 (for steel acting against soil). USN 1986 (pp. 7.2-63) recommends ultimate interface friction coefficients between mass concrete and the following soils:

- Clean gravel, gravel sand mixtures and coarse sand 0.55 to 0.6
- Clean fine to med. sand, silty med. to coarse sand, silty or clayey gravel 0.45 to 0.55
- Clean fine sand, silty or clayey fine to med. sand 0.35 to 0.45

The alluvium materials at the site consist of coarse sand and gravel. Hence, the average ultimate interface friction coefficient between mass concrete and the alluvial material is estimated to be about 0.55.

It is recommended to use **0.81** as the ultimate friction coefficient for the alluvium. The ultimate interface resistance for engineered fill is calculated in the same fashion as the alluvium, except that the internal friction angle is 42 degrees. The ultimate interface friction coefficient for the engineered fill is determined to be **0.91**. For engineered

APPENDIX C – LATERAL EARTH PRESSURES AND RESISTANCE TO LATERAL LOADS

fill, a reduced value corresponding to a factor of safety of at least 1.5, should be used when determining the overall resistance against sliding for a structural element.

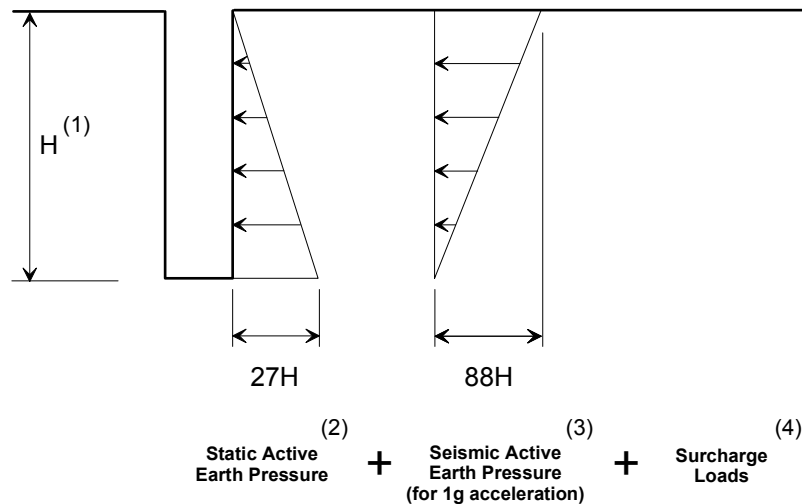
## C7 Results / Conclusions

### C7.1 Lateral Earth Pressures on Yielding Walls:

The combined lateral earth pressures acting on a yielding wall are as follows:

**Static Active + Seismic Active Increment + Static Surcharge**

Figure C7-1, Figure C7-2, and Figure C7-3 show the pressure distribution sketch.

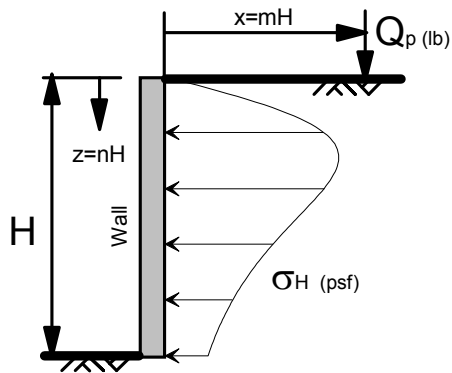


**Notes:**

- (1) Height of wall,  $H$ , is presented in feet.
- (2) Static active earth pressure for alluvium:  $K_A = 0.23$ ,  $\gamma = 117$  pcf.
- (3) Seismic active earth pressure for alluvium based on Seed and Whitman (1970) simplified method where  $K_h = 1g$  (to be scaled by actual peak ground acceleration, PGA).
- (4) Surcharge loads are shown in next figure.
- (5) Pressures are presented in psf.

**Figure C7-1. Pressure Distribution Sketch for Yielding Walls (not to scale)**

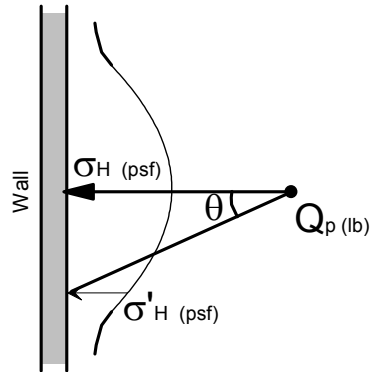
APPENDIX C – LATERAL EARTH PRESSURES AND RESISTANCE TO LATERAL LOADS



$$\sigma_H = 0.28 \frac{Q_p}{H^2} \frac{n^2}{(0.16+n^2)^3} \quad (\text{for } m \leq 0.4)$$

$$\sigma_H = 1.77 \frac{Q_p}{H^2} \frac{m^2 n^2}{(m^2+n^2)^3} \quad (\text{for } m > 0.4)$$

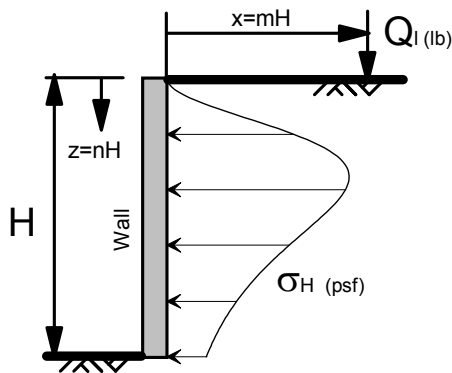
Elevation View



$$\sigma'_H = \sigma_H \cos^2(1.1\theta)$$

Plan View

**Lateral Pressure due to Point Load**



$$\sigma_H = 0.20 \frac{Q_l}{H} \frac{n}{(0.16+n^2)^2} \quad (\text{for } m \leq 0.4)$$

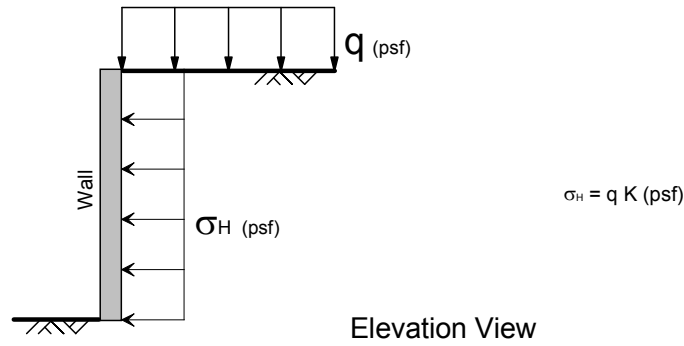
$$\sigma_H = 1.28 \frac{Q_l}{H} \frac{m^2 n}{(m^2+n^2)^2} \quad (\text{for } m > 0.4)$$

Elevation View

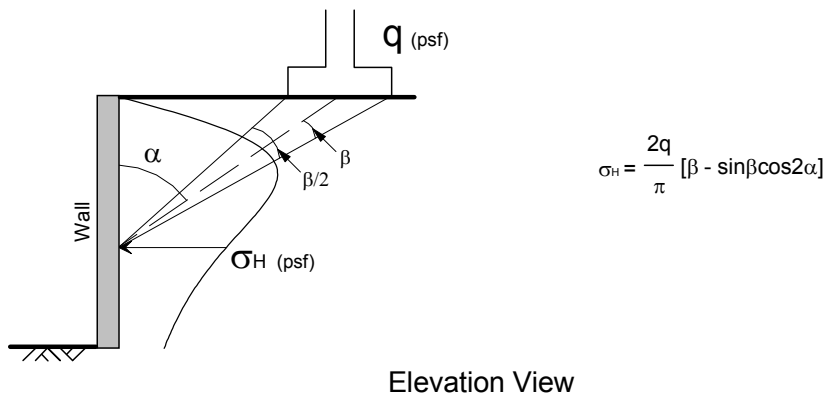
**Lateral Pressure due to Line Load**

Figure C7-2. Surcharge loads for yielding walls (taken from USN 1986).

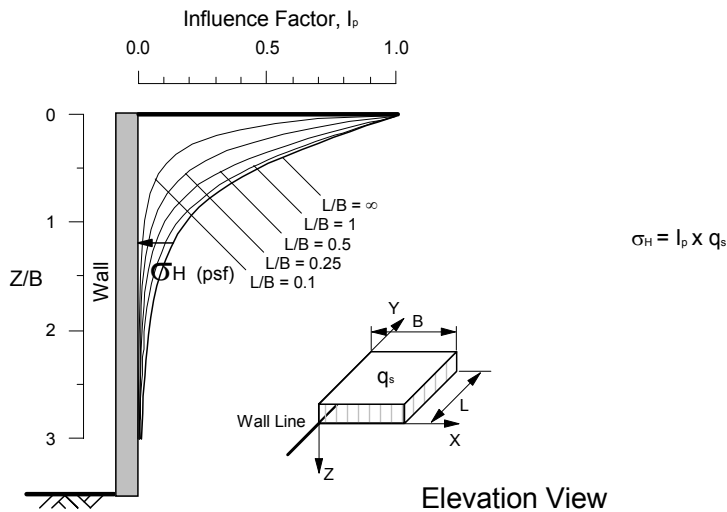
APPENDIX C – LATERAL EARTH PRESSURES AND RESISTANCE TO LATERAL LOADS



**Lateral Pressure due to Uniform Surcharge**



**Lateral Pressure due to Strip Load**



**Lateral Pressure due to Footing**

Figure C7-3. Surcharge loads for yielding walls continued (taken from USN 1986)



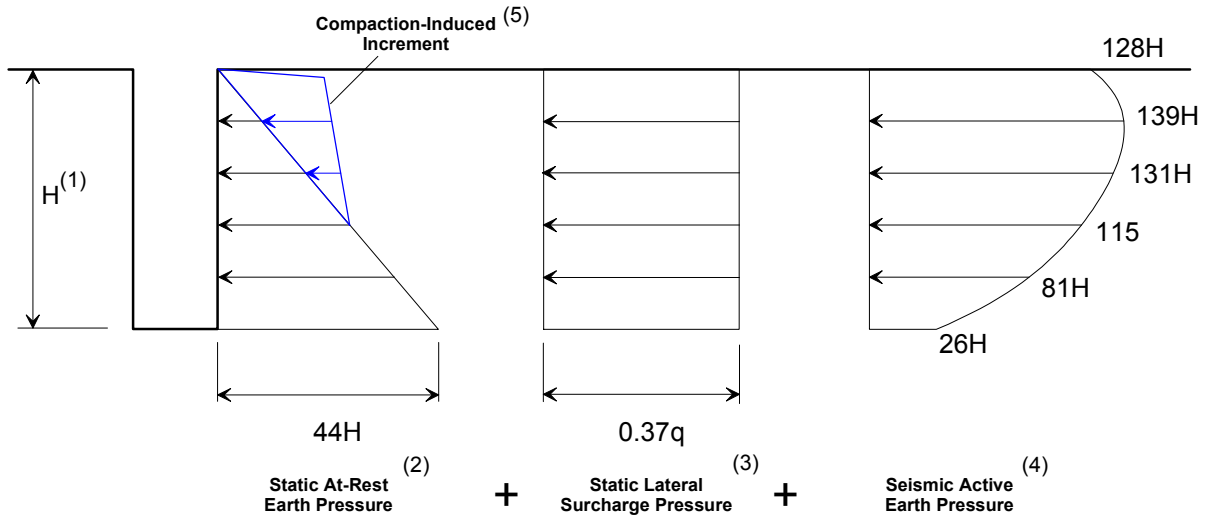
APPENDIX C – LATERAL EARTH PRESSURES AND RESISTANCE TO LATERAL LOADS

**C7.2 Lateral Earth Pressures on Non-Yielding Walls**

The combined lateral earth pressures acting on a non-yielding wall are as follows:

**Static At-Rest + Compaction-Induced Increment + Static Surcharge + Seismic Active**

The pressure distribution sketch for non-yielding walls is shown in Figure C7-4 through Figure C7-9.



**Notes:**

- (1) Height of wall, H, is presented in feet.
- (2) Static at-rest earth pressures for alluvium:  $K_o = 0.37$ ,  $\gamma = 117$  pcf.
- (3) Static lateral surcharge pressure based on  $K_o q$ , where q is surcharge to be determined.
- (4) Seismic active earth pressure based on methods from ASCE 4-98, where  $k_n = 1g$  (to be scaled by actual peak ground acceleration, PGA); does not include the dynamic contribution due to surcharge loads.
- (5) Compaction-induced pressure increments for specific compaction equipment provided in the next following figures.
- (6) Pressures are presented in psf.

**Figure C7-4. Pressure Distribution Sketch for Non-Yielding Walls (not to scale)**

APPENDIX C – LATERAL EARTH PRESSURES AND RESISTANCE TO LATERAL LOADS

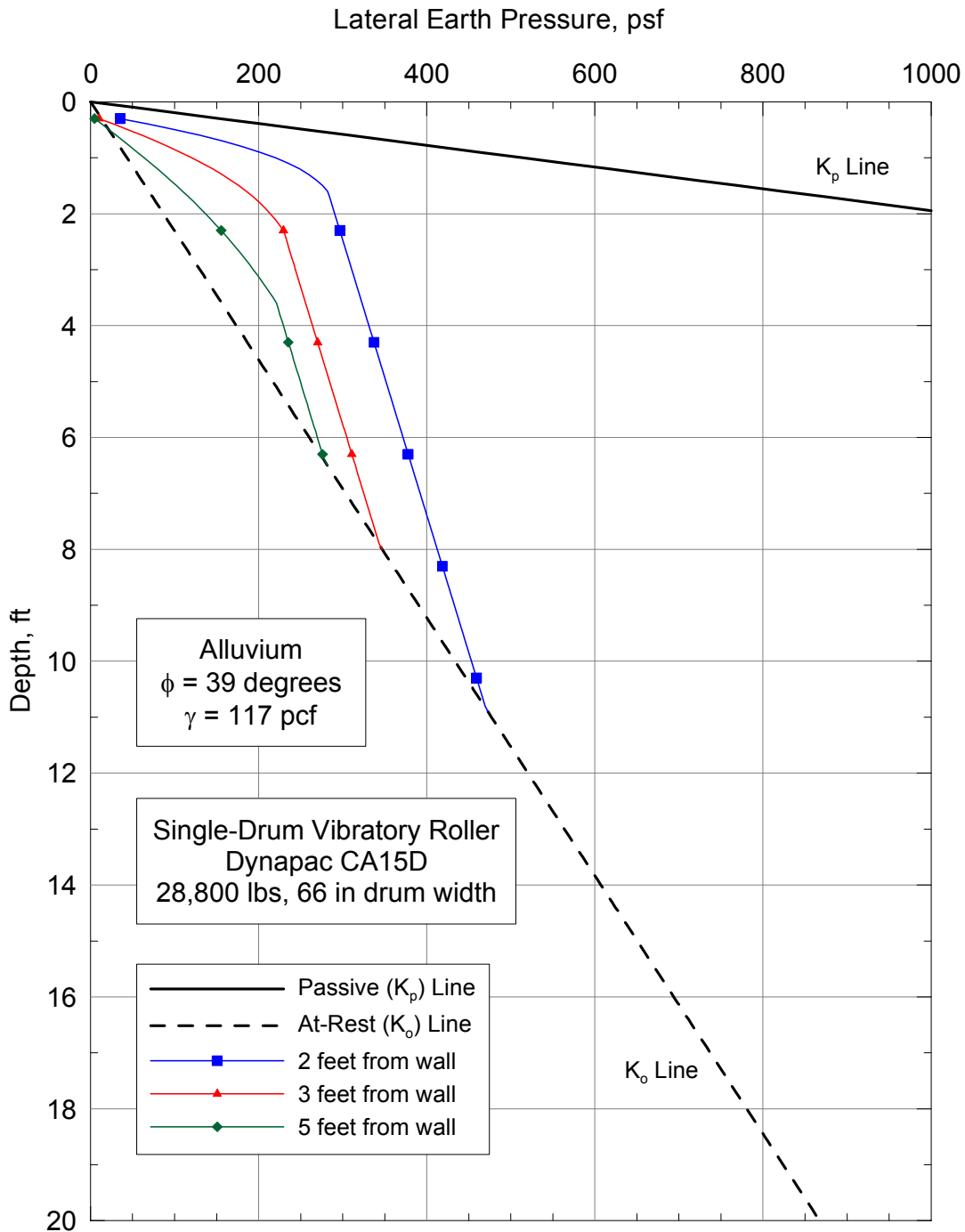


Figure C7-5. Compactor-induced pressures from roller compactor (Dynapac CA15D).

APPENDIX C – LATERAL EARTH PRESSURES AND RESISTANCE TO LATERAL LOADS

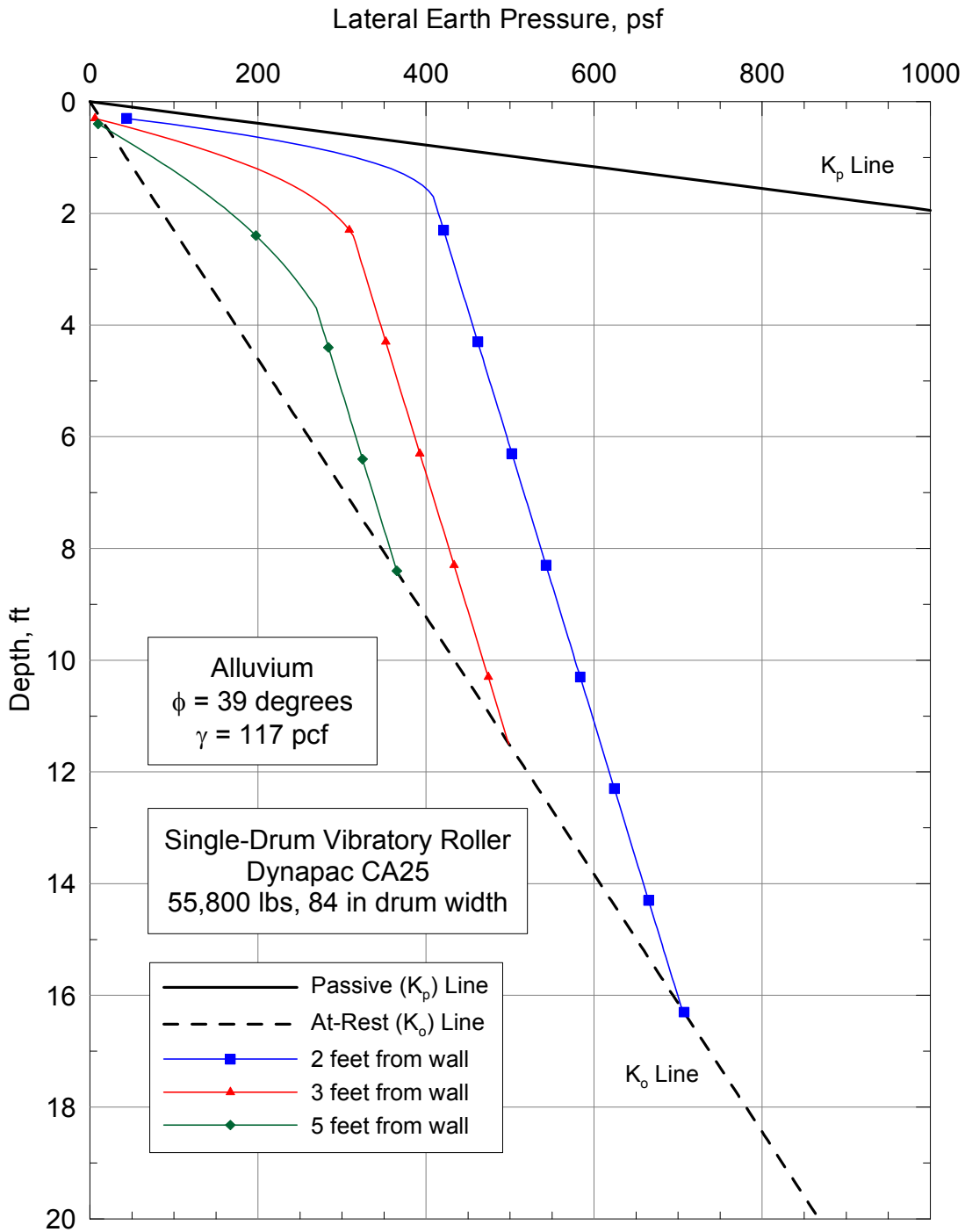


Figure C7-6. Compactor-induced pressures from roller compactor (Dynapac CA25).

APPENDIX C – LATERAL EARTH PRESSURES AND RESISTANCE TO LATERAL LOADS

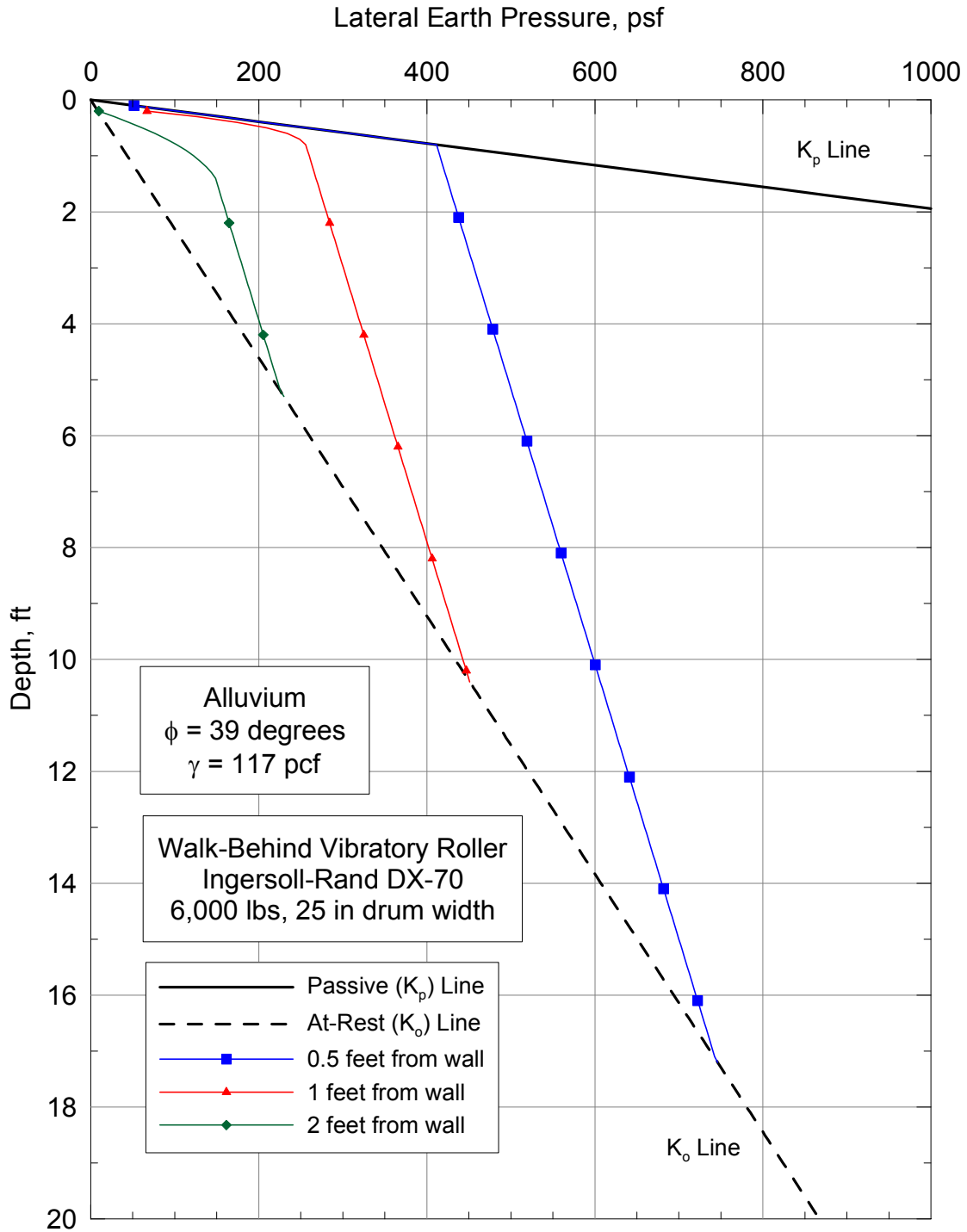


Figure C7-7. Compactor-induced pressures from roller compactor (Ingersoll-Rand DX-70).

APPENDIX C – LATERAL EARTH PRESSURES AND RESISTANCE TO LATERAL LOADS

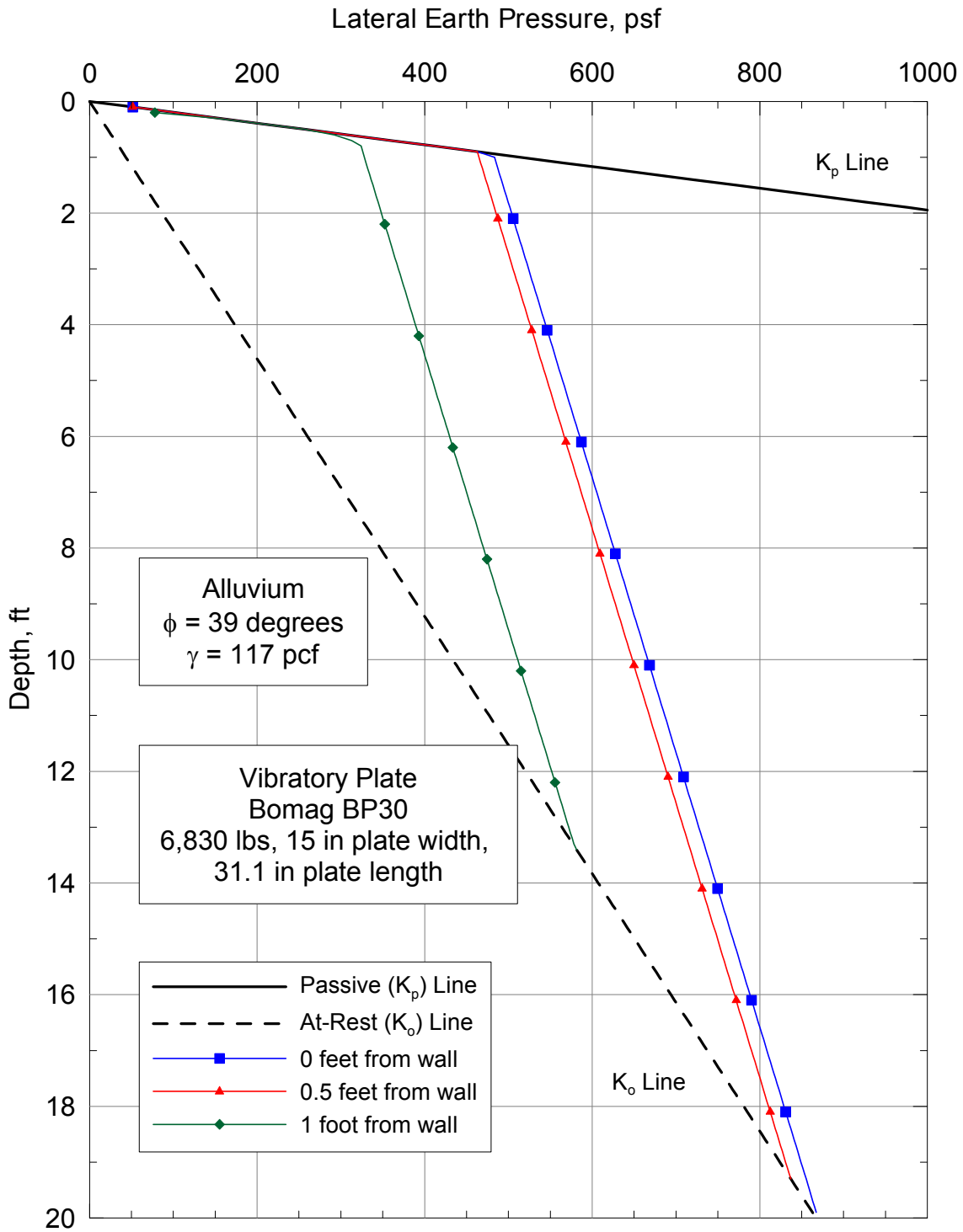


Figure C7-8. Compactor-induced pressures from plate compactor (Bomag BP30).

APPENDIX C – LATERAL EARTH PRESSURES AND RESISTANCE TO LATERAL LOADS

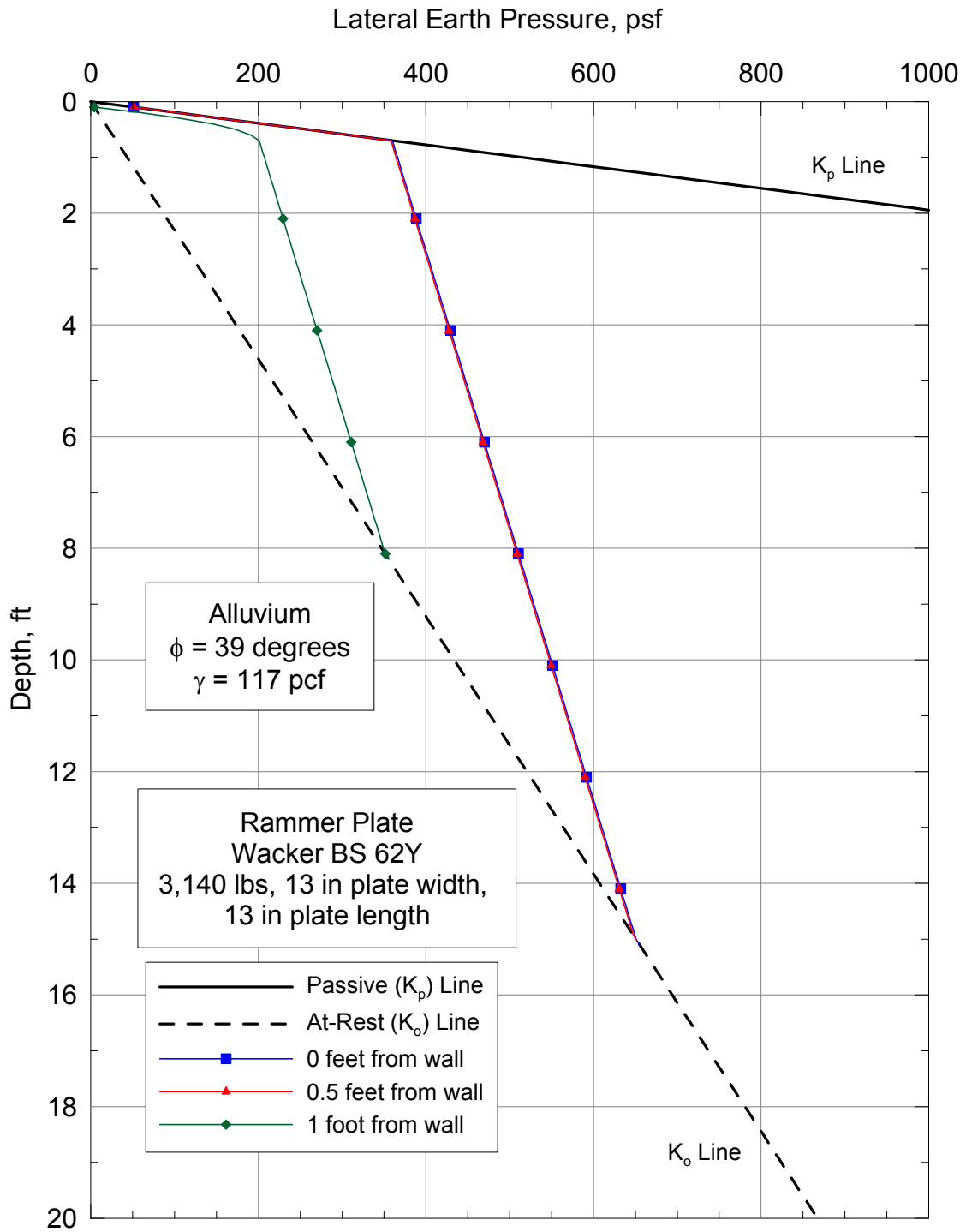


Figure C7-9. Compactor-induced pressures from plate compactor (Wacker BS 62Y).

**APPENDIX C – LATERAL EARTH PRESSURES AND RESISTANCE TO LATERAL LOADS**

---

**C7.3 Temporary Shoring Pressure**

The pressure of the alluvium acting on temporary shoring provided by soldier piles is estimated to be 17.5H.

**C7.4 Resistance to Lateral Loads**

The coefficient for resistance developed from passive pressures was calculated in Section C6.1. The passive pressure against the vertical face of the sub-grade walls and footings is calculated to be 515H.

The average interface friction coefficient between mass concrete and the alluvium or potential engineered fill is estimated to be **0.5**, where  $\tan \delta = 0.5$ . An appropriate factor of safety should be applied to this value.

**C8 MathCad Worksheets**

APPENDIX C - LATERAL EARTH PRESSURES AND RESISTANCE TO LATERAL LOADS

---

## MathCad Calculations

### Alluvium parameters

$\phi_{\text{alluv}} := 39\text{deg}$	Friction angle
$\gamma_{\text{alluv}} := 117\text{pcf}$	Unit weight
$\nu := 0.3$	Poisson's ratio

### Static Lateral Pressures

For Non-Yielding Walls (USN 1986, Fig 2, p. 7.2-62):

- At Rest Pressures (based on alluvium properties)

$$K_o := 1 - \sin(\phi_{\text{alluv}}) \quad \text{Static At-Rest Earth Pressure Coefficient}$$
$$K_o = 0.37$$

$$p_r(H) := K_o \cdot \gamma_{\text{alluv}} \cdot H \quad \text{Distributed Static At-Rest Earth Pressure}$$

$$p_r(H) = 43.37 \cdot H \cdot \frac{\text{psf}}{\text{ft}}$$

$$P_R(H) := K_o \cdot \gamma_{\text{alluv}} \cdot \frac{H^2}{2} \quad \text{Resultant Static At-Rest Earth Force}$$

For Yielding Walls (USN 1986, Fig 2, p. 7.2-62)::

- Active Pressures (based on alluvium properties)

$$K_A := \tan\left(45\text{deg} - \frac{\phi_{\text{alluv}}}{2}\right)^2 \quad \text{Static Active Earth Pressure Coefficient}$$
$$K_A = 0.23$$

$$p_a(H) := K_A \cdot \gamma_{\text{alluv}} \cdot H \quad \text{Distributed Static Active Earth Pressure}$$

$$p_a(H) = 26.618 \cdot H \cdot \frac{\text{psf}}{\text{ft}}$$

$$P_A(H) := K_A \cdot \gamma_{\text{alluv}} \cdot \frac{H^2}{2} \quad \text{Resultant Static Active Earth Force}$$



APPENDIX C - LATERAL EARTH PRESSURES AND RESISTANCE TO LATERAL LOADS

**Dynamic Lateral Pressures (yielding walls)**

- Active Pressures

$$k_h := 1$$

$$\Delta K_{AE} := \frac{3}{4} \cdot k_h$$

Seismic Active Earth Pressure Increment Coefficient

$$\Delta K_{AE} = 0.75$$

$$\Delta p_{ae}(H) := \Delta K_{AE} \cdot \gamma_{alluv} \cdot H$$

Distributed Seismic Active Earth Pressure Increment

$$\Delta p_{ae}(H) = 87.75 \cdot H \cdot \frac{\text{psf}}{\text{ft}}$$

$$\Delta P_{AE}(H) := \Delta K_{AE} \cdot \gamma_{alluv} \cdot \frac{H^2}{2}$$

Resultant Seismic Active Earth Pressure Force Increment. It is suggested that the component may be taken to act at approximately 0.6H per Seed and Whitman (1970).

$$P_{AE}(H) := \Delta P_{AE}(H) + P_A(H)$$

Sum of initial static active earth pressure force and dynamic active earth pressure force increment

**Dynamic Lateral Pressures (nonyielding walls)**

a := 1                      Acceleration [g], to be multiplied by kh

$\frac{H}{W}$  := 20ft                      Wall height

d := 0ft, 0.1ft.. H

Coefficients for ASCE 4-98 seismic stresses:

$$M := \begin{pmatrix} 1.0829167 & 0.070869084 & -3.1836133 & 3.5952709 & -2.0641442 \\ 1.0888187 & 1.1176702 & -4.0053697 & 4.333532 & -2.3203657 \\ 1.0968336 & 1.7075112 & -5.3728278 & 5.6727378 & -2.7717642 \\ 1.0788775 & 2.2549514 & -5.719958 & 5.1033643 & -2.1980003 \end{pmatrix}$$

$$y(\text{eqtn}, x) := M_{\text{eqtn},0} + M_{\text{eqtn},1} \cdot x + M_{\text{eqtn},2} \cdot x^2 + M_{\text{eqtn},3} \cdot x^3 + M_{\text{eqtn},4} \cdot x^4$$

$$\text{eqtn}_0 := \begin{cases} \text{trunc}\left(\frac{\nu}{0.1}\right) - 2 & \text{if } \nu \geq 0.2 \\ 0.2 & \text{otherwise} \end{cases} \quad \text{eqtn}_1 := \text{eqtn}_0 + 1$$

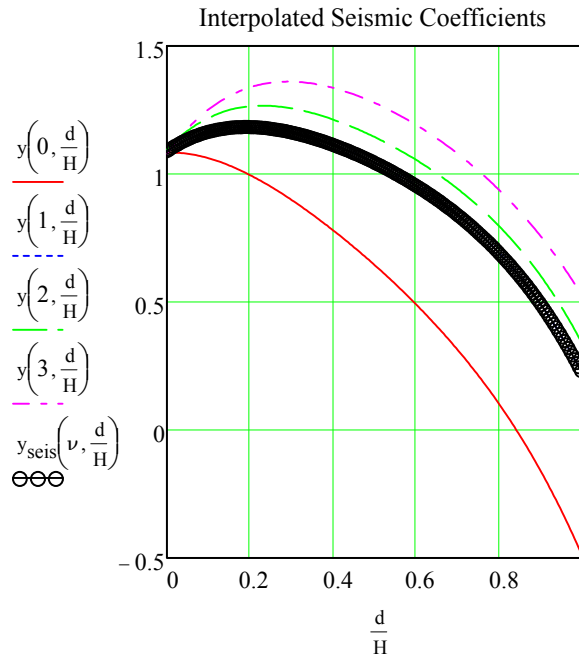
APPENDIX C - LATERAL EARTH PRESSURES AND RESISTANCE TO LATERAL LOADS

eqtn<sub>0</sub> = 1

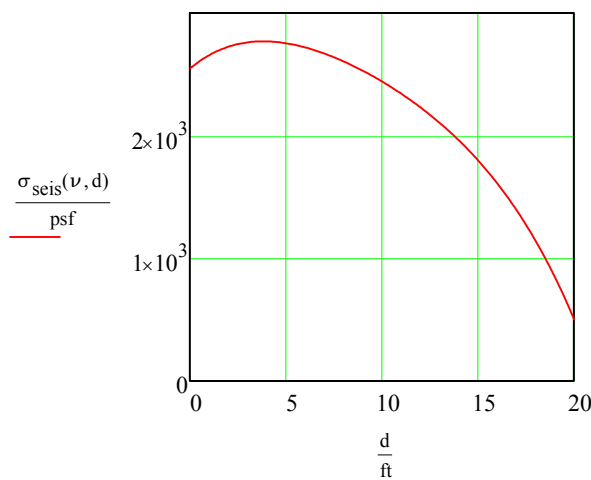
eqtn<sub>1</sub> = 2

$$y_{\text{seis}}(\nu, d) := \frac{\nu - (\text{eqtn}_0 + 2) \cdot 0.1}{.1} \cdot (y(\text{eqtn}_1, d) - y(\text{eqtn}_0, d)) + y(\text{eqtn}_0, d)$$

The interpolated seismic coefficients per ASCE 4-98 are shown below:



The seismic pressure increment are calculated from  $\sigma_{\text{seis}}(\nu, x) := y_{\text{seis}}\left(\nu, \frac{x}{H}\right) \cdot \gamma_{\text{alluv}} \cdot H \cdot a$



$$\sigma_{\text{seis}}(\nu, 0H) = 127.392 \cdot H \cdot \frac{\text{psf}}{\text{ft}}$$

$$\sigma_{\text{seis}}(\nu, .2H) = 138.422 \cdot H \cdot \frac{\text{psf}}{\text{ft}}$$

$$\sigma_{\text{seis}}(\nu, .4H) = 130.218 \cdot H \cdot \frac{\text{psf}}{\text{ft}}$$

$$\sigma_{\text{seis}}(\nu, .6H) = 111.479 \cdot H \cdot \frac{\text{psf}}{\text{ft}}$$

$$\sigma_{\text{seis}}(\nu, .8H) = 80.48 \cdot H \cdot \frac{\text{psf}}{\text{ft}}$$

$$\sigma_{\text{seis}}(\nu, H) = 25.071 \cdot H \cdot \frac{\text{psf}}{\text{ft}}$$

**APPENDIX C - LATERAL EARTH PRESSURES AND RESISTANCE TO LATERAL LOADS**

**Compaction-Induced Lateral Earth Pressures  
 (Duncan and Seed 1986 and Duncan et al. 1991 procedure)**

Methodology:

1. Solve Bousinesq stress due to load
2. Reduce Item 1 using factor, F, and add to Ko stress
3. Limit Item 2 so as to not exceed Kp stress
4. Find depth to peak stress
5. Smooth relationship below peak Bousinesq stress

Input:

**Example using Dynapac CA15D**

P := 28800lbf      Static + dynamic force of compactor  
 CHD := 0.01ft      Closest distance from compactor edge to wall  
 φ := 39deg      Internal friction angle of alluvium  
 γ := 117pcf      Unit weight of alluvium  
 Type := "roller"      Type of analysis (plate or roller), **use lower case**  
 width := 66in      Compactor width  
 length := 31.1in      Compactor length  
 $\nu := \frac{4 - 3 \sin(\phi)}{8 - 4 \sin(\phi)}$       Poisson's ratio per Duncan et. al (1991)

Calculations :

Roller Calcs:  $R(x, y, z) := \sqrt{x^2 + y^2 + z^2}$

$$\Delta\sigma_h(x, y, z) := \frac{P}{2 \cdot \pi} \left[ \frac{3 \cdot (x^2 + y^2) \cdot z}{R(x, y, z)^5} - \frac{1 - 2 \cdot \nu}{R(x, y, z)^2 + z \cdot R(x, y, z)} \right]$$

Equation 2.2b from pp. 16 of Poulos and Davis (1991)

$\nu = 0.385$

**Bousinesq stress due to compaction:**

$$\Delta\sigma(d) := \begin{cases} \frac{2}{width} \left( \int_{CHD}^{CHD+width} \Delta\sigma_h(x, 0ft, d) dx \right) & \text{if Type = "roller"} \\ \frac{2}{width \cdot length} \left( \int_{CHD}^{CHD+width} \int_{-\frac{length}{2}}^{\frac{length}{2}} \Delta\sigma_h(x, y, d) dy dx \right) & \text{otherwise} \end{cases}$$

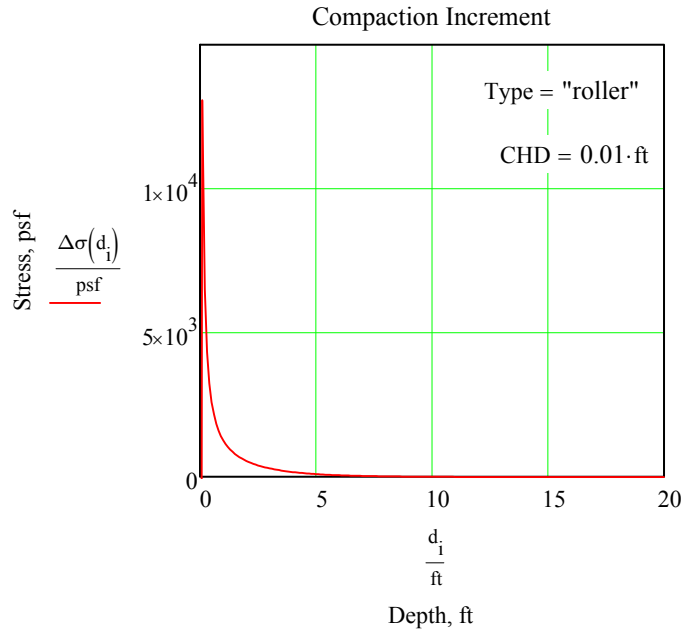
Double stress increment per Duncan et al. (1991)

**APPENDIX C - LATERAL EARTH PRESSURES AND RESISTANCE TO LATERAL LOADS**

$$i := 0.. \frac{H}{0.1\text{ft}}$$

$$d_i := i \cdot 0.1\text{ft}$$

The unmodified stresses due only to compaction are shown below:



This stress increment is modified per Duncan et al. (1986):

$$\alpha := 0.7794423 - 0.51338219 \cdot e^{-19.574578 \cdot \sin(\phi)^{4.9554863}} \quad \alpha = 0.708$$

$$F := \frac{5^\alpha}{4} - 0.25 \quad F = 0.531$$

$$K_p := \tan\left(45\text{deg} + \frac{\phi}{2}\right)^2 \quad \text{passive pressure} \quad K_p = 4.395$$

$$K_0 := 1 - \sin(\phi) \quad \text{at-rest pressure} \quad K_0 = 0.371$$

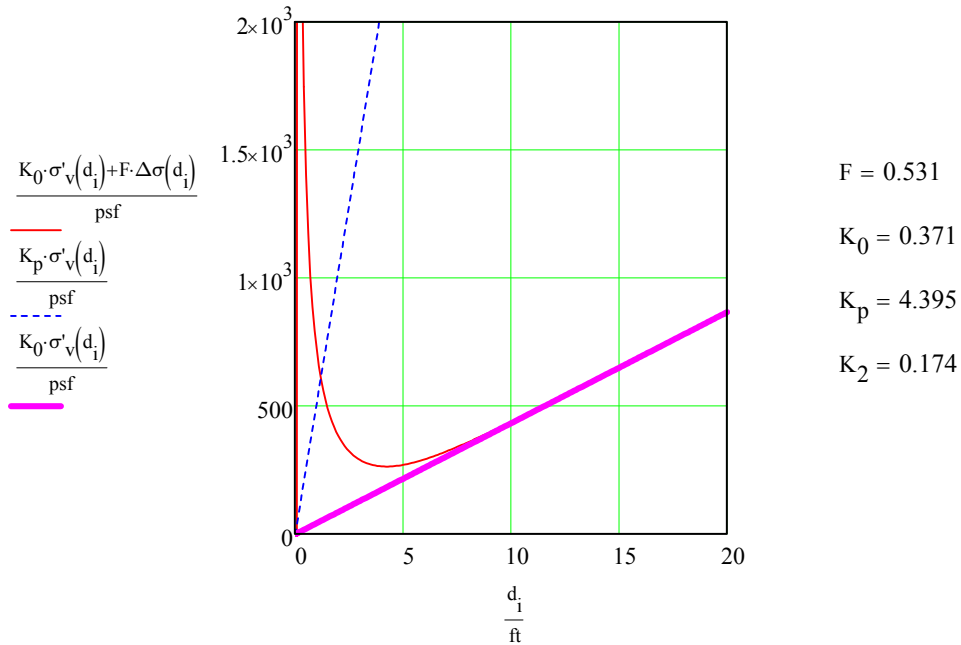
$$K_2 := K_0 \cdot (1 - F) \quad K_2 = 0.174$$

$$\sigma'_v(d) := \gamma \cdot d$$

APPENDIX C - LATERAL EARTH PRESSURES AND RESISTANCE TO LATERAL LOADS

Limit stress in upper portion of wall to passive pressure

$$\sigma'_h(d) := \begin{cases} K_0 \cdot \sigma'_v(d) + F \cdot \Delta\sigma(d) & \text{if } (K_0 \cdot \sigma'_v(d) + F \cdot \Delta\sigma(d)) \leq K_p \cdot \sigma'_v(d) \\ K_p \cdot \sigma'_v(d) & \text{otherwise} \end{cases}$$



Find critical depth where stress,  $\sigma'_h(d)$ , is a maximum off the  $K_0$ -line

$$k_i := \sigma'_h(d_i) - K_0 \cdot \sigma'_v(d_i)$$

$k_{\text{max}}$  is the maximum stress increment off the  $K_0$ -line

$$\text{depth} := .2\text{ft}$$

$$d_c := \text{root}(\max(k) - \sigma'_h(\text{depth}) + K_0 \cdot \sigma'_v(\text{depth}), \text{depth})$$

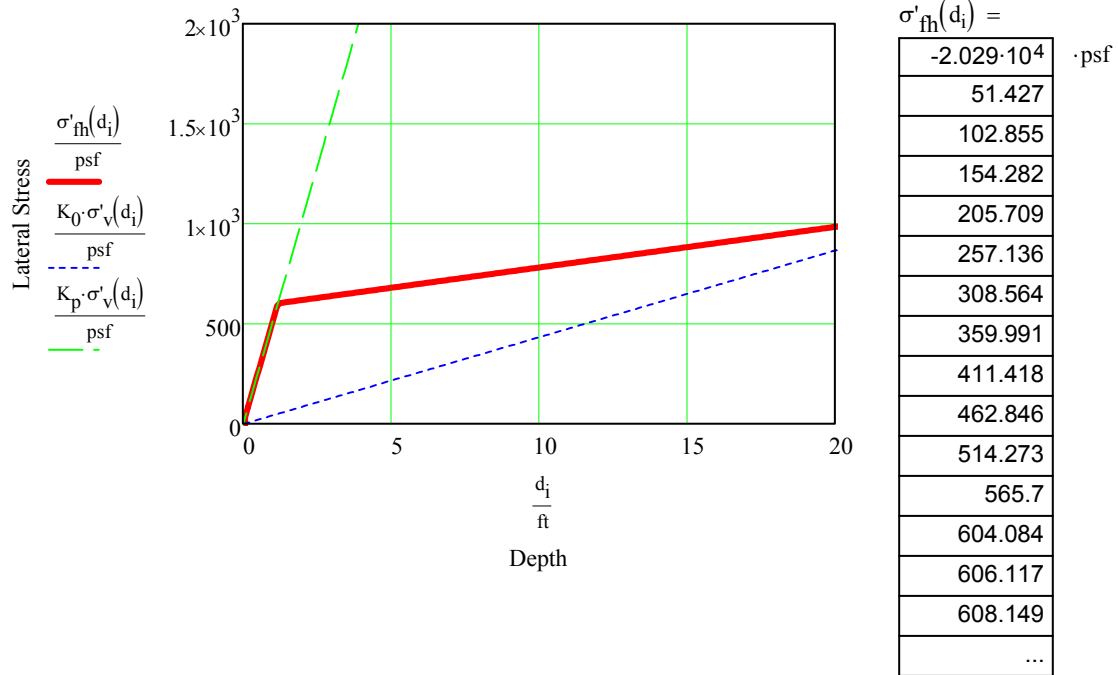
$$d_c = 1.174 \cdot \text{ft} \quad \text{Critical depth}$$

The total of static and compaction stresses for the wall are determined as follows (note: stress must not go below  $K_0$  line):

$$\sigma'_{fh}(d) := \begin{cases} \sigma'_h(d) & \text{if } d \leq d_c \\ \text{otherwise} \\ \begin{cases} \sigma'_h(d_c) + K_2 \cdot \sigma'_v(d - d_c) & \text{if } (\sigma'_h(d_c) + K_2 \cdot \sigma'_v(d - d_c)) \geq K_0 \cdot \sigma'_v(d) \\ K_0 \cdot \sigma'_v(d) & \text{otherwise} \end{cases} \end{cases}$$

APPENDIX C - LATERAL EARTH PRESSURES AND RESISTANCE TO LATERAL LOADS

The combined static and compaction stresses are shown below:



Check results against NavFac DM7.02 (USN 1986)  
 Using equations from Figure 13:

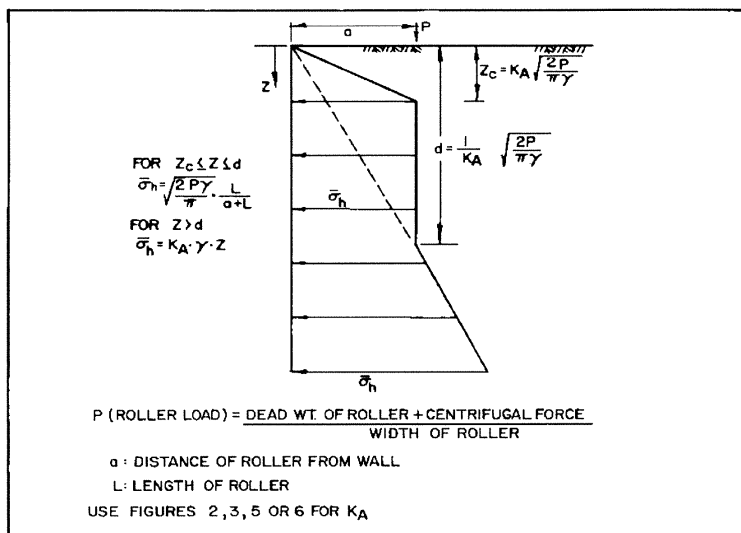


FIGURE 13  
 Horizontal Pressure on Walls from Compaction Effort

APPENDIX C - LATERAL EARTH PRESSURES AND RESISTANCE TO LATERAL LOADS

Redefine some variables to correspond to NavFac:

$$K_a := \frac{1}{K_p} \quad \frac{P}{\text{width}} \quad z_1 := d_1 \quad a := 0 \text{ ft}$$

$$K_a = 0.228 \quad P = 5.236 \times 10^3 \frac{\text{lbf}}{\text{ft}}$$

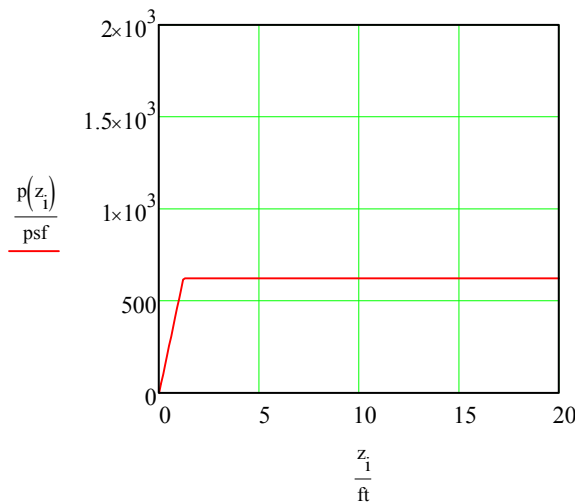
$$z_{\text{cr}} := K_a \sqrt{\frac{2 \cdot P}{\pi \cdot \gamma}} \quad \text{Critical depth}$$

$$z_{\text{cr}} = 1.214 \text{ ft}$$

$$d := \frac{1}{K_a} \sqrt{\frac{2 \cdot P}{\pi \cdot \gamma}} \quad \text{Depth where compaction effects merge with pressure line}$$

$$d = 23.462 \text{ ft}$$

$$p(z) := \begin{cases} \left( \sqrt{\frac{2 \cdot P \cdot \gamma}{\pi}} \cdot \frac{\text{length}}{a + \text{length}} \right) \cdot \left( \frac{z}{z_{\text{cr}}} \right) & \text{if } z < z_{\text{cr}} \\ \text{otherwise} \\ \sqrt{\frac{2 \cdot P \cdot \gamma}{\pi}} \cdot \frac{\text{length}}{a + \text{length}} & \text{if } z_{\text{cr}} \leq z \leq d \\ K_a \cdot \gamma \cdot z & \text{if } z > d \end{cases}$$



Solution assumes that the compactor is used at the wall (distance from wall = 0')

This matches relatively well with the solution obtained from the Duncan et al. (1986) and (1991) solution.

$$\text{psf} \equiv \frac{\text{lbf}}{\text{ft}^2}$$

$$\text{pcf} \equiv \frac{\text{lbf}}{\text{ft}^3}$$

**PAGE INTENTIONALLY  
LEFT BLANK**



**Attachment F**

**Supplemental Soils Report**  
**Calculation/Analysis Change Notice**

**PAGE INTENTIONALLY  
LEFT BLANK**

**BSC**

# Calculation/Analysis Change Notice

1. QA: QA  
2. Page 1 of 5

*Complete only applicable items.*

3. Document Identifier: <b>100-SOC-CY00-00100-000</b>		4. Rev.: <b>00D</b>	5. CACN: <b>CACN002</b>
6. Title: <b>Supplemental Soils Report</b>			
7. Reason for Change: To supercede CACN001 of the Supplemental Soils Report to correct Block 1 from QA:N/A to QA:QA.			
1) Data included in Table 1-1 have been refined to be consistent with sources of information for ready reference. None of the data shown in this table is used as input to the calculation.  2) Better formatted versions of Tables 2-1 and 2-2 are available to allow ease of use and better understanding of the information presented in these tables.			
8. Supersedes Change Notice:	<input checked="" type="checkbox"/> Yes	If, Yes, CACN No.: <u>100-SOC-CY00-00100-000-00D</u> <u>CACN001</u>	<input type="checkbox"/> No
9. Change Impact:			
Inputs Changed:	<input checked="" type="checkbox"/> Yes <input type="checkbox"/> No	Results Impacted:	<input type="checkbox"/> Yes <input checked="" type="checkbox"/> No
Assumptions Changed:	<input type="checkbox"/> Yes <input checked="" type="checkbox"/> No	Design Impacted:	<input type="checkbox"/> Yes <input checked="" type="checkbox"/> No
10. Description of Change:			
1) Replace the existing Table 1-1 with the revised Table 1-1 (see attached).			
In Section 2.2.1 <u>Input Documents</u> , remove:			
<ul style="list-style-type: none"> <li>• BSC (Bechtel SAIC Company) 2007. Emergency Diesel Generator Facility – Diesel Generator Foundation Calculation. 26D-SOC-EG00-00500-000-00A. Las Vegas, Nevada: Bechtel SAIC Company. ACC: ENG.20070718.0006.</li> <li>• BSC (Bechtel SAIC Company) 2007. Initial Handling Facility – Initial Handling Facility Foundation Design. 51A-SSC-IH00-00400-000-00A. Las Vegas, Nevada: Bechtel SAIC Company.</li> <li>• BSC (Bechtel SAIC Company) 2007. Receipt Facility (RF) Foundation Design. 200-DBC-RF00-00300-000-00A. Las Vegas, Nevada: Bechtel SAIC Company. ACC: ENG.20070328.0004. (DIRS 184037)</li> <li>• BSC (Bechtel SAIC Company) 2007. Wet Handling Facility Subgrade Structure and Foundation Design. 050-SYC-WH00-00500-000-00A. Las Vegas, Nevada: Bechtel SAIC Company. ACC: ENG.20070601.0017. (DIRS 184031)</li> </ul>			
and add:			
<ul style="list-style-type: none"> <li>• BSC (Bechtel SAIC Company) 2007. Emergency Diesel Generator Facility – Mass Analysis &amp; Moments of Inertia. 26D-SYC-EG00-00300-000-00A. Las Vegas, Nevada: Bechtel SAIC Company. ACC: ENG.20070323.0003.</li> <li>• BSC (Bechtel SAIC Company) 2008. Initial Handling Facility (IHF) Foundation Design. 51A-DBC-IH00-00200-000-00B. Las Vegas, Nevada: Bechtel SAIC Company. ACC: ENG.20080221.0005.</li> <li>• BSC (Bechtel SAIC Company) 2006. Receipt Facility (RF) Mass Properties. 200-SYC-RF00-00100-000-00A. Las Vegas, Nevada: Bechtel SAIC Company. ACC: ENG.20061206.0001.</li> <li>• BSC (Bechtel SAIC Company) 2007. Wet Handling Facility (WHF) Mass Properties. 050-SYC-WH00-00300-000-00B. Las Vegas, Nevada: Bechtel SAIC Company. ACC: ENG.20070326.0001.</li> </ul>			

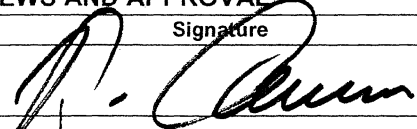
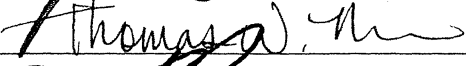

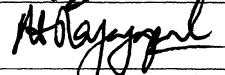
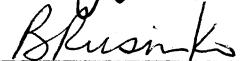
In Section 2.2.4 Drawings, remove:

- BSC (Bechtel SAIC Company) 2007. Initial Handling Facility General Arrangement Ground Floor Plan. 51A-P10-IH00-00102-000 REV 00B. Las Vegas, Nevada: Bechtel SAIC Company. ACC: ENG.20071101.0003. (DIRS 183793)
- Nuclear Facilities Buildings, Cannister Receipt and Closure Facility #1, Forming Plan at TOC El. 0'-0", 060-DB0-CR00-00101-000, Rev. 00A, 7/30/07, Las Vegas, Nevada: Bechtel SAIC Company.
- Nuclear Facilities Buildings, Receipt Facility, Forming Plan at TOC El. 0'-0", 200-DB0-RF00-00101-000, Rev. 00A, 5/29/07, Las Vegas, Nevada: Bechtel SAIC Company.
- Nuclear Facilities Buildings, Wet Handling Facility, Forming Plan at TOC El. 0'-0", 050-DB0-WH00-00102-000, Rev 00A, 7/30/07, Las Vegas, Nevada: Bechtel SAIC Company.

and add:

- BSC (Bechtel SAIC Company) 2007. Emergency Diesel Generator Facility General Arrangement Ground Floor Plan. 26D-P10-EG00-00102-000, Rev. 00A. Las Vegas, Nevada: Bechtel SAIC Company. ACC: ENG.20071026.0009.
- BSC (Bechtel SAIC Company) 2007. Initial Handling Facility General Arrangement Ground Floor Plan. 51A-P10-IH00-00102-000, Rev. 00B. Las Vegas, Nevada: Bechtel SAIC Company. ACC: ENG.20071226.0017.  
*C Jct 3/24/08*
- BSC (Bechtel SAIC Company) 2008. Nuclear Facilities Buildings Canister Receipt and Closure Facility #1 Forming Plan at TOC EL 0'-0", 060-DB0-CR00-00101-000, Rev. 00B. Las Vegas, Nevada: Bechtel SAIC Company. ACC: ENG.20080117.0025.
- BSC (Bechtel SAIC Company) 2008. Nuclear Facilities Buildings Receipt Facility Forming Plan at TOC EL 0'-0", 200-DB0-RF00-00101-000, Rev. 00B. Las Vegas, Nevada: Bechtel SAIC Company. ACC: ENG.20080205.0002.
- BSC (Bechtel SAIC Company) 2008. Nuclear Facilities Buildings Wet Handling Facility Forming Plan at TOC EL 0'-0", 050-DB0-WH00-00102-000, Rev. 00B. Las Vegas, Nevada: Bechtel SAIC Company. ACC: ENG.20080107.0004.

2) See attached pages for the better-formatted Tables 2-1 and 2-2.

11. REVIEWS AND APPROVAL		
Printed Name	Signature	Date
11a. Originator: <b>JAMES T. CAMERON</b>		3/21/08
11b. Checker: <b>Thomas W. Ma</b>		3/21/08
11c. EGS: <b>James A. Clark</b>		3.21.2008
11d. DEM: <b>RAJ S. RAJAGOPAL</b>		3/24/2008
11e. Design Authority: <b>B. Rusinko</b>		3/24/08

**Table 1-1. Summary of Planned Buildings**

						References for Dimensions and Loads	
Building	Plan Dimensions (ft)	Slab Thickness (ft)	Bottom of Slab Elev (ft)	Load (1000 kips)	Pressure (ksf)	Drawing Reference	Calculation
Receipt Facility, RF	284 x 242	7	3651	189.7	3.45	200-DB0-RF00-00101-000, Rev. 00B	200-SYC-RF00-00100-000-00A
Emergency Diesel Generator Facility	98 x 174	4	3663	28.7	1.68	26D-P10-EG00-00102-000, Rev. 00A	26D-SYC-EG00-00300-000-00A
Canister Receipt and Closure Facility , CRCF #1	262 x 421	6	3656	314.2	3.33	060-DB0-CR00-00101-000, Rev. 00B	060-DBC-CR00-00200-000-00A
Canister Receipt and Closure Facility , CRCF #2			3657				
Canister Receipt and Closure Facility , CRCF #3			3660				
Initial Handling Facility, IHF Large Structure (IHF Cask Process Area Main Structure)	170 x 196.5	6	3665	56.7	1.70	51A-P10-IH00-00102-000, Rev. 00C	51A-DBC-IH00-00200-000-00B
Initial Handling Facility, IHF Small Structure (IHF Loadout Area Concrete Structure)	141.5 x 75			32.3	3.05		
Wet Handling Facility, WHF (pool)	114 x 116	8	3607	42.6	3.22	050-DB0-WH00-00101-000, Rev. 00A	050-SYC-WH00-00300-000-00B
Wet Handling Facility, WHF (building)	270 x 214	6	3661	269.7	4.67	050-DB0-WH00-00102-000, Rev. 00B	

Note: Building dimensions, weights, elevations, and associated drawings and references are all subject to change as design progresses.

This table is provided as an approximation of the current building design information. The most up to date information should be used for final design.

However, it is not expected that future changes in the building designs will have any significant impact on the conclusions of this report.

**Table 2-1. Recommended Material Parameters**

Design Parameter <sup>a</sup>	Layer			
	Engineered Fill	Roller Compacted Cement <sup>b</sup>	Alluvium	Bedrock
Moist Density, $\gamma$ (pcf)	127 pcf	130–140 pcf	114–117 pcf	100 pcf
Specific Gravity, $G_s$	2.5		2.5	Not Applicable
Shear Strength Parameters	$\phi = 42^\circ$ $c = 0$	$\phi = 0$ $c = 400$ psi (unconf. comp.)	$\phi = 39^\circ$ $c = 0$	Not Applicable
At-Rest Earth Pressure Coefficient, $K_o$	0.33	Not Applicable	0.37	Not Applicable
Active Earth Pressure Coefficient, $K_A$	0.20	Not Applicable	0.23	Not Applicable
Passive Earth Pressure Coefficient, $K_P$	5.0	Not Applicable	4.4	Not Applicable
Static Elastic Modulus, E (ksi)	14–28	Not Available	30–75	Not Applicable
Poisson's Ratio, $\nu$	0.3–0.4	0.3	0.23–0.44	0.3
Shear Wave Velocity, $V_s$ (fps)	630–1,500	2,000–3,000	Figure 6-27, Figure 6-29, and Base Case - Figure 6-31	Figure 6-32 and Figure 6-34
Compression Wave Velocity, $V_p$ (fps)	1,500–3,700	3,700–5,600	Figure 6-28 and Figure 6-30	Figure 6-33 and Figure 6-35
Low-Strain Shear Modulus, G (ksi)	10–60	100–270	40–200	150–1,000
Low-Strain Elastic Modulus, E (ksi)	30–170	260–700	100–500	400–2,500
Shear Modulus Reduction, $G/G_{max}$	Figure 6-38	Figure 6-40	Figure 6-36–upper figure	Figure 6-37–upper figure
Material Damping Ratio, D%	Figure 6-39	Figure 6-41	Figure 6-36–lower figure	Figure 6-37–lower figure
Resistivity (ohm-m)	To Be Determined	To Be Determined	To Be Determined	Not Applicable
CBR	20-60	Not Applicable	20–60	Not Applicable
Soil Profile Type (ICC 2000)	$S_D$ (stiff soil)	$S_C$ (very dense soil and soft rock) to $S_B$ (rock)	$S_C$ (very dense soil and soft rock)	$S_B$ (rock) to $S_A$ (hard rock)

<sup>a</sup> see applicable sections in calculation or appendices for basis of parameters<sup>b</sup> additional testing required for verification

**Table 2-2. Summary of Recommended Surface Facilities Foundation Design Parameters**

<b>Design Parameter</b>	<b>Results / Recommendations</b>																
Soil Material Properties	Table 2-1																
Foundation Pressure	Settlement controls design Square and Continuous footings: Figure 7-2 and Figure 7-3																
Estimated Settlements	<u>Square and strip footings</u> Figure 7-4 through Figure 7-6  <u>Mat foundation (300' × 400')</u> <table border="1"> <thead> <tr> <th>Load (ksf)</th> <th>Center (in)</th> <th>Corner (in)</th> <th>Differential (in)</th> </tr> </thead> <tbody> <tr> <td>3</td> <td>0.2-0.4</td> <td>negligible</td> <td>0.4</td> </tr> <tr> <td>5</td> <td>0.5-1.6</td> <td>&lt; 0.1</td> <td>1.5</td> </tr> <tr> <td>7</td> <td>1.3-2.9</td> <td>&lt; 0.1</td> <td>2.9</td> </tr> </tbody> </table>	Load (ksf)	Center (in)	Corner (in)	Differential (in)	3	0.2-0.4	negligible	0.4	5	0.5-1.6	< 0.1	1.5	7	1.3-2.9	< 0.1	2.9
Load (ksf)	Center (in)	Corner (in)	Differential (in)														
3	0.2-0.4	negligible	0.4														
5	0.5-1.6	< 0.1	1.5														
7	1.3-2.9	< 0.1	2.9														
Lateral Pressures	<u>Yielding walls</u> Static and seismic pressures: Figure 7-7 Surcharge loads: Figure 7-8 and Figure 7-9  <u>Non-yielding walls</u> Static and seismic pressures: Figure 7-10 Compactor-induced pressures: Figure 7-11 thru Figure 7-15																
Lateral Load Resistance	Friction Coefficient, $\tan \phi$ for alluvium: 0.81 for engineered fill: 0.90 Passive resistance: 515 pcf equivalent fluid																
Temporary Shoring	For braced excavation Lateral pressure: 17H psf																
Temporary Slopes	1.5H:1V																
Permanent Slopes	2H:1V																
Modulus of Subgrade Reaction (static loading; ranges may be doubled for short-term loading)	<table border="1"> <thead> <tr> <th></th> <th><u>Alluvium</u></th> <th><u>Engineered Fill</u></th> </tr> </thead> <tbody> <tr> <td>Horizontal:</td> <td>104-120 kcf (60-70 pci)</td> <td>60-96 kcf (35-55 pci)</td> </tr> <tr> <td>Vertical:</td> <td></td> <td></td> </tr> <tr> <td>1ft × 1ft footing</td> <td>1000 kcf (580 pci)</td> <td>600 kcf (350 pci)</td> </tr> <tr> <td>Large mats</td> <td>155-520 kcf (90-300 pci)</td> <td>75-250 kcf (45-145 pci)</td> </tr> </tbody> </table>		<u>Alluvium</u>	<u>Engineered Fill</u>	Horizontal:	104-120 kcf (60-70 pci)	60-96 kcf (35-55 pci)	Vertical:			1ft × 1ft footing	1000 kcf (580 pci)	600 kcf (350 pci)	Large mats	155-520 kcf (90-300 pci)	75-250 kcf (45-145 pci)	
	<u>Alluvium</u>	<u>Engineered Fill</u>															
Horizontal:	104-120 kcf (60-70 pci)	60-96 kcf (35-55 pci)															
Vertical:																	
1ft × 1ft footing	1000 kcf (580 pci)	600 kcf (350 pci)															
Large mats	155-520 kcf (90-300 pci)	75-250 kcf (45-145 pci)															
Saturated Permeability	$5 \times 10^{-5}$ to $5 \times 10^{-4}$ fpm																
Percolation Rate	1.8 in/hr																
Depth of Frost Penetration	10 inches: see Figure 7-16																
Minimum Footing Depth	2 feet																