



International Agreement Report

Simulation of the Propagation of Pressure Waves in Piping Systems with RELAP5/MOD 3.2.2

Comparison of Computed and Measured Results

Prepared by:

Jürgen Perlia, Wolfgang Münch

TÜV SÜD

Section Thermo- and Fluidynamics

Westendstraße 199

D-80686 Munich, Germany

M.B. Rubin, NRC Project Manager

Office of Nuclear Regulatory Research

U.S. Nuclear Regulatory Commission

Washington, DC 20555-0001

June 2007

Prepared as part of

The Agreement on Research Participation and Technical Exchange

Under the International Code Assessment and Maintenance Program (CAMP)

Published by

U.S. Nuclear Regulatory Commission

AVAILABILITY OF REFERENCE MATERIALS IN NRC PUBLICATIONS

NRC Reference Material

As of November 1999, you may electronically access NUREG-series publications and other NRC records at NRC's Public Electronic Reading Room at <http://www.nrc.gov/reading-rm.html>. Publicly released records include, to name a few, NUREG-series publications; *Federal Register* notices; applicant, licensee, and vendor documents and correspondence; NRC correspondence and internal memoranda; bulletins and information notices; inspection and investigative reports; licensee event reports; and Commission papers and their attachments.

NRC publications in the NUREG series, NRC regulations, and *Title 10, Energy*, in the Code of *Federal Regulations* may also be purchased from one of these two sources.

1. The Superintendent of Documents
U.S. Government Printing Office
Mail Stop SSOP
Washington, DC 20402-0001
Internet: bookstore.gpo.gov
Telephone: 202-512-1800
Fax: 202-512-2250
2. The National Technical Information Service
Springfield, VA 22161-0002
www.ntis.gov
1-800-553-6847 or, locally, 703-605-6000

A single copy of each NRC draft report for comment is available free, to the extent of supply, upon written request as follows:

Address: U.S. Nuclear Regulatory Commission
Office of Administration
Mail, Distribution and Messenger Team
Washington, DC 20555-0001

E-mail: DISTRIBUTION@nrc.gov
Facsimile: 301-415-2289

Some publications in the NUREG series that are posted at NRC's Web site address <http://www.nrc.gov/reading-rm/doc-collections/nuregs> are updated periodically and may differ from the last printed version. Although references to material found on a Web site bear the date the material was accessed, the material available on the date cited may subsequently be removed from the site.

Non-NRC Reference Material

Documents available from public and special technical libraries include all open literature items, such as books, journal articles, and transactions, *Federal Register* notices, Federal and State legislation, and congressional reports. Such documents as theses, dissertations, foreign reports and translations, and non-NRC conference proceedings may be purchased from their sponsoring organization.

Copies of industry codes and standards used in a substantive manner in the NRC regulatory process are maintained at—

The NRC Technical Library
Two White Flint North
11545 Rockville Pike
Rockville, MD 20852-2738

These standards are available in the library for reference use by the public. Codes and standards are usually copyrighted and may be purchased from the originating organization or, if they are American National Standards, from—

American National Standards Institute
11 West 42nd Street
New York, NY 10036-8002
www.ansi.org
212-642-4900

Legally binding regulatory requirements are stated only in laws; NRC regulations; licenses, including technical specifications; or orders, not in NUREG-series publications. The views expressed in contractor-prepared publications in this series are not necessarily those of the NRC.

The NUREG series comprises (1) technical and administrative reports and books prepared by the staff (NUREG-XXXX) or agency contractors (NUREG/CR-XXXX), (2) proceedings of conferences (NUREG/CP-XXXX), (3) reports resulting from international agreements (NUREG/IA-XXXX), (4) brochures (NUREG/BR-XXXX), and (5) compilations of legal decisions and orders of the Commission and Atomic and Safety Licensing Boards and of Directors' decisions under Section 2.206 of NRC's regulations (NUREG-0750).

DISCLAIMER: This report was prepared under an international cooperative agreement for the exchange of technical information. Neither the U.S. Government nor any agency thereof, nor any employee, makes any warranty, expressed or implied, or assumes any legal liability or responsibility for any third party's use, or the results of such use, of any information, apparatus, product or process disclosed in this publication, or represents that its use by such third party would not infringe privately owned rights.



International Agreement Report

Simulation of the Propagation of Pressure Waves in Piping Systems with RELAP5/MOD 3.2.2

Comparison of Computed and Measured Results

Prepared by:
Jürgen Perlia, Wolfgang Münch
TÜV SÜD
Section Thermo- and Fluidynamics
Westendstraße 199
D-80686 Munich, Germany

M.B. Rubin, NRC Project Manager

Office of Nuclear Regulatory Research
U.S. Nuclear Regulatory Commission
Washington, DC 20555-0001

June 2007

Prepared as part of
The Agreement on Research Participation and Technical Exchange
Under the International Code Assessment and Maintenance Program (CAMP)

Published by
U.S. Nuclear Regulatory Commission

ABSTRACT

The present paper demonstrates the suitability of the computer code RELAP5/MOD 3.2.2 to describe the propagation of pressure waves in piping systems.

First of all a pressure wave in a simple straight pipe was analyzed with RELAP5. The results of the computation were compared with the outcomes we obtained with the computer code DWELL. DWELL is an in-house development based on the method of characteristics. The results of both codes showed a very good agreement.

Further we analyzed the following two transients for a 1200 MW_e PWR-plant:

- turbine trip
- shutting down of a feed water pump

In both cases, pressure versus time was recorded at several positions of the piping system concerned. The measured pressure signal curves were compared with the results of post test calculations performed with RELAP5.

A comparison of the results showed a good agreement and proved that RELAP5 is able to solve pressure wave problems.

PAPERWORK REDUCTION ACT STATEMENTS

This NUREG does not contain information collection requirements and, therefore, is not subject to the requirements of the Paperwork Reduction Act of 1995 (44 U.S.C. 3501 et seq.).

Public Protection Notification

The NRC may not conduct or sponsor, and a person is not required to respond to, a request for information or an information collection requirement unless the requesting document displays a currently valid OMB control number.

FOREWORD

This work was generated by international partners under the Code Assessment and Maintenance Program (CAMP) and constitutes the contributing organization's contribution to international thermal hydraulic code development. The contents of this report should not be viewed as an official NRC endorsement of the products or services of other persons or entities that may be referred to herein. Nor should this report be viewed as binding the NRC in its rulemaking, licensing or adjudicatory process.

CONTENTS

| | Page |
|---|-------|
| Abstract | .iii |
| Foreword | .v |
| Contents | .vii |
| Figures..... | .viii |
| Executive Summary | .ix |
| Acknowledgments | .xi |
| Acronyms and Abbreviations | .xiii |
| | |
| 1. INTRODUCTION..... | 1 |
| 2. PRESSURE WAVE PROPAGATION IN A PIPE, COMPARISON OF THE RESULTS OF THE CODES RELAP5/MOD 3.2.2 AND DWELL..... | 3 |
| 3. PROPAGATION OF A PRESSURE WAVE IN THE MAIN STEAM LINE SYSTEM OF PWR CAUSED BY A TURBINE TRIP | 5 |
| 3.1 Description of the Experiment..... | 5 |
| 3.2 Calculated Results..... | 6 |
| 4. PRESSURE WAVES IN THE FEED WATER SYSTEM OF A PWR CAUSED BY SHUTTING DOWN A FEEDWATER PUMP | 13 |
| 4.1 Description of the Feed Water Pump Shut down Test | 13 |
| 4.2 Post-test Calculation of the Experiment by RELAP5..... | 16 |
| 5 CONCLUSIONS AND SUMMARY | 19 |
| 6 REFERENCES | 21 |

FIGURES

| | | |
|------|---|----|
| 2-1 | Two Time Dependent Volumes Connected With a Pipe | 3 |
| 2-2 | Comparison of RELAP5 and DWELL Results..... | 4 |
| 3-1 | Scheme of Main Steam Line System..... | 5 |
| 3-2 | Valve Stem Versus Time..... | 6 |
| 3-3 | Nodalization Scheme | 7 |
| 3-4 | Turbine Trip – Comparison between Experiment and Calculation (Pressure 10P01)..... | 8 |
| 3-5 | Turbine Trip – Comparison Between Experiment and Calculation (Pressure 11P02)..... | 8 |
| 3-6 | Turbine Trip – Comparison Between Experiment and Calculation (Pressure 14P03)..... | 9 |
| 3-7 | Comparison of the Measured and Calculated Pressure Amplitudes Versus Time | 9 |
| 3-8 | Quotient of Measured and Calculated Pressure Amplitude..... | 10 |
| 3-9 | Corrected Pressure Versus Time at Position 10P01..... | 11 |
| 3-10 | Corrected Pressure Versus Time at Position 11P02..... | 11 |
| 3-11 | Corrected Pressure Versus Time at Position 14P03..... | 12 |
| 4-1 | Feed Water Line Section..... | 14 |
| 4-2 | Nodalization Scheme of the Feed Water Line Section..... | 15 |
| 4-3 | Measured Pressure at Position CP702..... | 15 |
| 4-4 | Pressure Comparison at Position CP 701 | 17 |
| 4-5 | Pressure Comparison at Position CP 706 | 17 |
| 4-6 | Pressure Comparison at Position CP 710..... | 18 |

EXECUTIVE SUMMARY

To show that RELAP5 is suitable to describe the propagation of pressure waves in pipes three example calculations were carried out.

- The propagation of a pressure wave in a straight pipe was calculated by the code DWELL that we have developed to analyze the propagation of pressure waves. A second calculation by RELAP5 was performed as code to code comparison.
- In a 1200MW PWR a turbine trip at 50% power was carried out. At several positions of the main steam supply system the pressure was recorded as a function of time. A post test calculation was performed with RELAP5.
- Further a feed water pump at the same power plant was switched off. The backflow caused hereby closed a check valve which gave rise to a pressure surge. The pressure as a function of time was recorded at various measuring points of the feed water supply system. Also for this case a post-test calculation with RELAP5 we carried out.

The calculated or measured results were compared with the outcomes of RELAP5 which are documented in this report.

ACKNOWLEDGMENTS

We thank RWE POWER AG and FRAMATOME ANP, formerly KWU for attending the pressure measurements on the power plant and for making the measured data available to us.

ABBREVIATIONS AND SYMBOLS

| | |
|-------------------|--|
| RA | designation of steam line |
| PO | pressure measuring point (steam line) |
| CP | pressure measuring point (feed water line) |
| A | area |
| A_r | pressure amplitude (calculated) |
| A_v | pressure amplitude (measured) |
| c | velocity of sound |
| \dot{m} | mass flow |
| MOC | method of characteristics |
| p | pressure |
| p_{corr} | pressure (corrected) |
| PWR | pressurized water reactor |
| t | time |
| T | time constant |

1. INTRODUCTION

Pressure waves in piping systems can be caused e. g. by opening or closing valves or by starting or stopping pumps. To verify the suitability of RELAP5 to deal with pressure wave problems, we performed the following studies:

- Description of the propagation of pressure waves in a straight tube, code to code comparison
- Post test calculation of pressure waves in the main steam lines of a 1200MW_e PWR caused by a turbine trip
- Post test calculation of pressure waves in the feed water system of a PWR caused by shutting down of a main feed water pump.

2. PRESSURE WAVE PROPAGATION IN A PIPE, COMPARISON OF THE RESULTS OF THE CODES RELAP5/MOD 3.2.2 AND DWELL

To demonstrate in principle the suitability of RELAP5 to describe pressure wave phenomena, a pressure wave in a 10 m long pipe filled with subcooled water was analyzed. The pipe is located between two time dependent volumes A and B (s. Fig. 2-1). The fluid temperature lies at 30°C; the initial system pressure is 70 bars. The pipe is subdivided into 90 subsections. Raising the pressure in volume A from 70 to 80 bars by a step function generates the pressure wave.

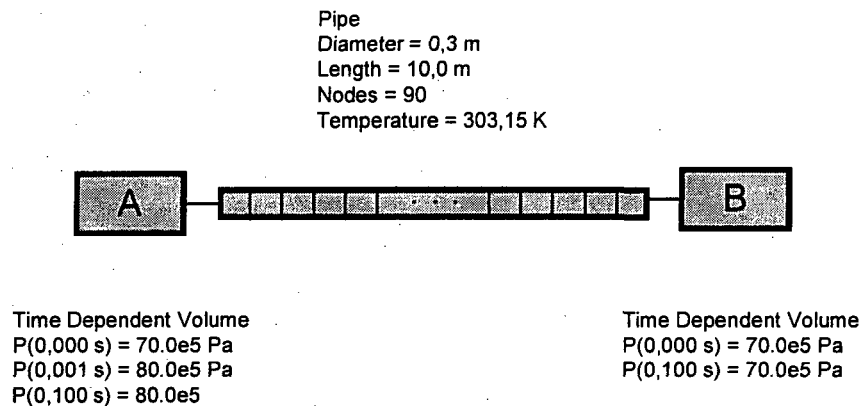

Fig. 2-1 Two Time Dependent Volumes Connected With a Pipe

Two calculations were performed. The first one was carried out using the computer code DWELL /1/. This code solves the conservation equations of mass and momentum for one phase flow by the method of characteristics which is an acknowledged procedure to deal with pressure wave problems in pipes. The second calculation was done using RELAP5. The computation was based on a time step of 10^{-5} s. A further reduction of the time step respectively an increase of the number of nodes had no influence on the results.

The computed pressures versus time are shown in Figure 2-2. The results of DWELL and RELAP5 show a very good agreement, a reduction of the edge steepness of the curves as a result of numerical attenuation cannot be observed. But the results obtained with DWELL show a slightly higher wave velocity. The example presented however, demonstrates that RELAP5 can be used to analyze pressure wave propagation in pipes at least in the case of incompressible flow.

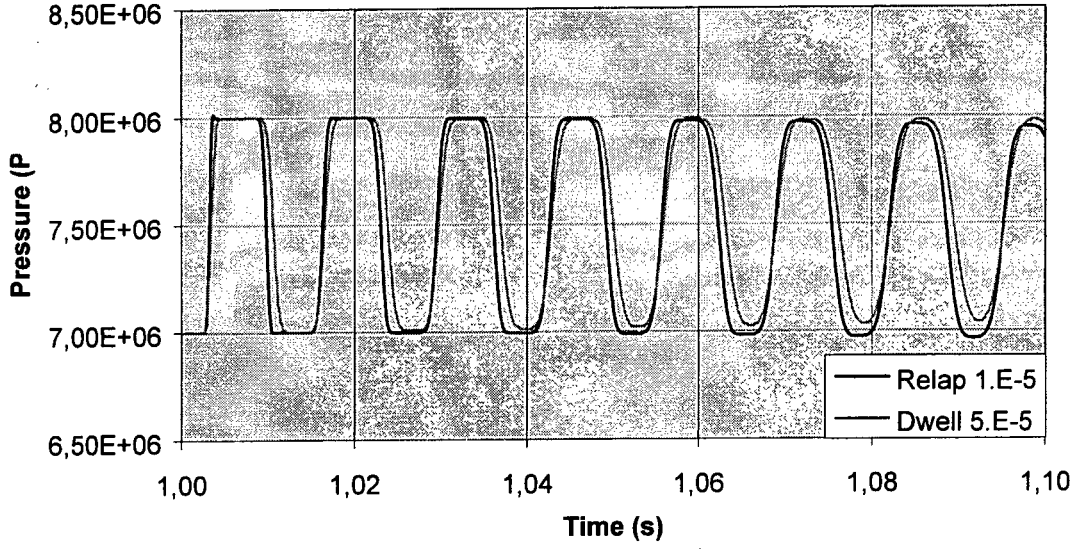

Fig. 2-2 Comparison of RELAP5 and DWELL Results

3. PROPAGATION OF A PRESSURE WAVE IN THE MAIN STEAM LINE SYSTEM OF A PWR CAUSED BY A TURBINE TRIP

3.1 Description of the Experiment

To demonstrate that RELAP5 can be used to analyze pressure wave propagation in steam line systems, a turbine trip at a 1200 MW_e plant of KWU design was analyzed. The most important features of the experiment are described in the following:

Fig. 3-1 shows a simplified view of the steam line system concerned consisting of the four main steam lines RA 01, RA02, RA03 and RA04. The positions at which pressure sensors were attached are indicated.

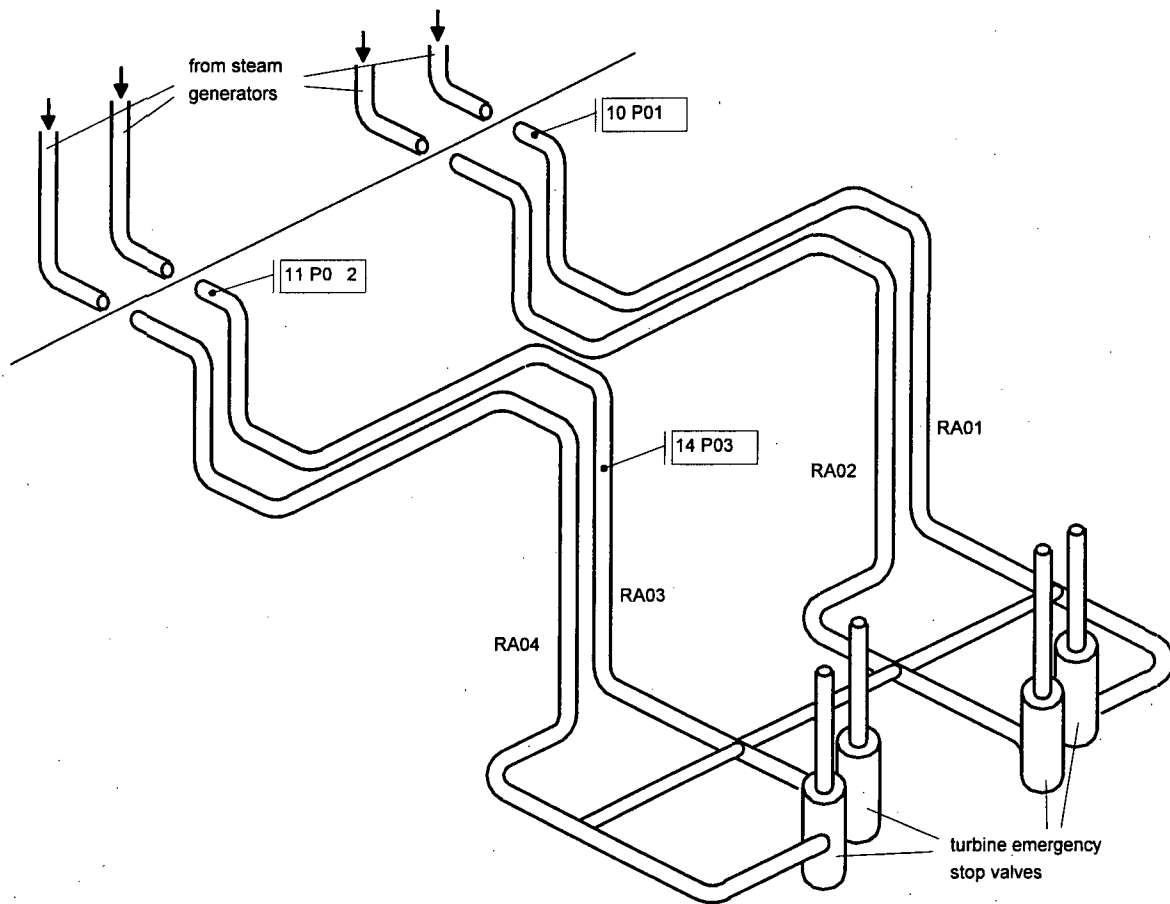

Fig. 3-1 Scheme of Main Steam Line System

The test was carried out during shut down of the plant at a reactor power of 52%. Starting from this power level the four turbine emergency stop valves were closed simultaneously. Fig. 3-2, for example, shows the measured stem position versus time for the steam line RA03. The stem position is proportional to the flow area which again is proportional to the mass flow in the case of critical mass flow. Critical mass flow can be assumed under the given conditions.

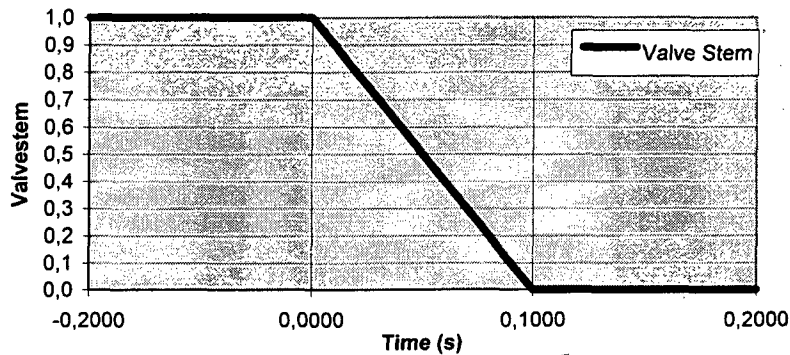

Fig. 3-2 Valve Stem Versus Time

3.2 Calculated Results

A post test calculation of the experiment was performed with RELAP5. The results obtained by the code were compared with the pressure versus time functions recorded at the indicated positions. But before discussing the results, we evaluated the expected pressure rise.

According to Joukowsky's law the height of the pressure rise can be calculated by

$$\Delta p = c \frac{\dot{m}}{A}$$

where c indicates the velocity of sound, \dot{m} the mass flow and A the flow area. A steam generator pressure of 72 bar yields a sound velocity in saturated steam of:

$$c = 490 \frac{m}{s}$$

With the mass flow rate at 52% power

$$m = 189 \frac{kg}{s}$$

and a flow area diameter of

$$d = 0.784m$$

follows a pressure rise of

$$\Delta p = 1.92 \cdot 10^5 Pa$$

This value is in accordance with the first pressure peak in Fig.3-4 where the pressure recorded at position 10P01 is represented. The pressure functions measured at the remaining positions (see Fig. 3-5 and 3-6) differ slightly from this curve because the initial stem positions of the emergency turbine stop valves are not exactly equal in the beginning of the transient.

To carry out a post test calculation with RELAP5 the steam line system was subdivided into pipes. These again were split into volumes the lengths of which amount to 0.6 m. As we found by test, a further decrease in volume length did not influence the results. The turbine trip valves were represented in RELAP by their measured stem position versus time function (Fig.3.2). The nodalization scheme the calculation is based on is shown in Fig. 3-3.

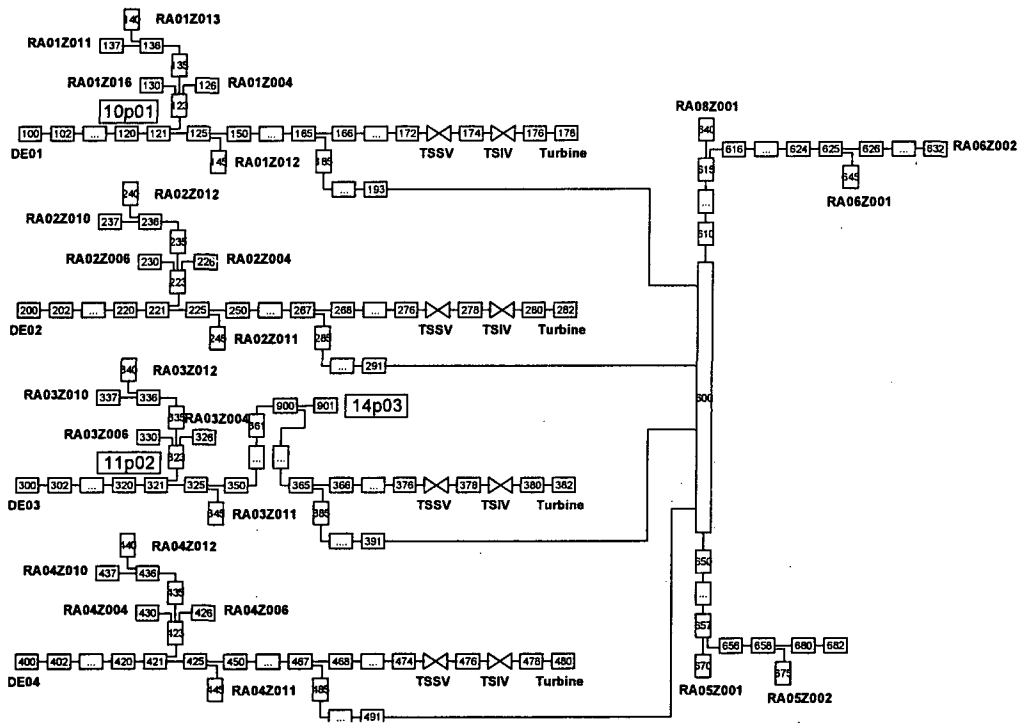

Fig. 3-3 Nodalization Scheme

A comparison of the measured and calculated results is plotted in Fig. 3-4 to Fig. 3-6. Qualitatively the curves show a pretty good agreement. The edge steepness of the curves is well reproduced by the code. The code, however, significantly overestimates the pressure amplitudes in advancing time. Furthermore a phase displacement between the measured and calculated functions can be noticed, since the computed speed of sound is about 7% higher than the measured one. These differences are mainly caused by the definition of pressure loss coefficients used in RELAP5 that are determined by formulae describing steady-uniform flow. The influence of temporal and local variability of the flow velocity within the flow cross sectional area on the friction losses, for instance, is not taken into consideration.

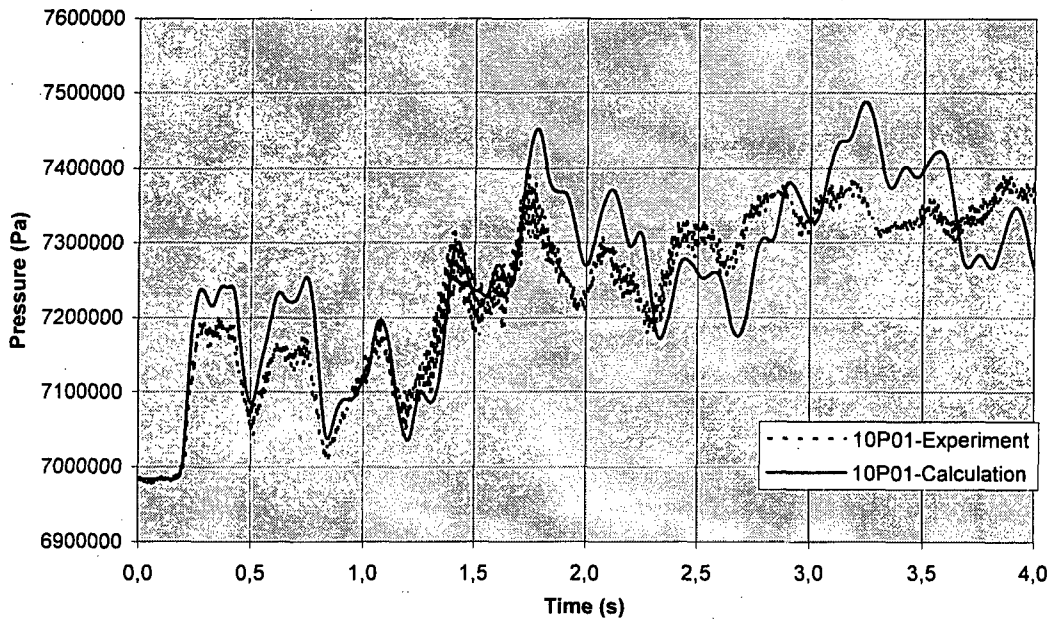

Fig. 3-4 Turbine Trip – Comparison Between Experiment and Calculation (Pressure 10P01)

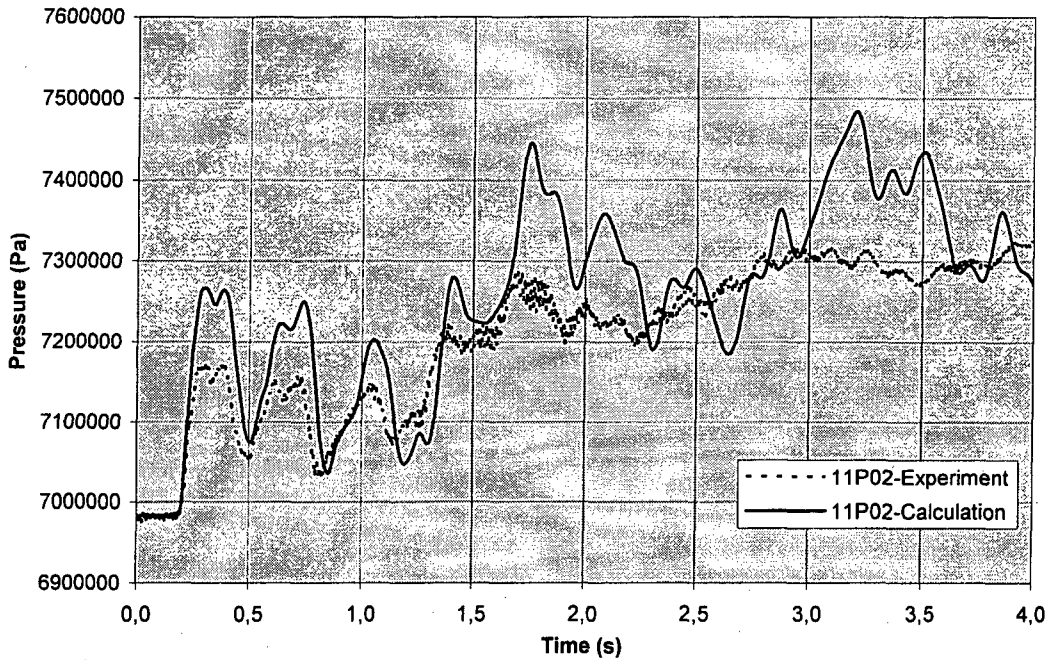

Fig. 3-5 Turbine Trip – Comparison Between Experiment and Calculation (Pressure 11P02)

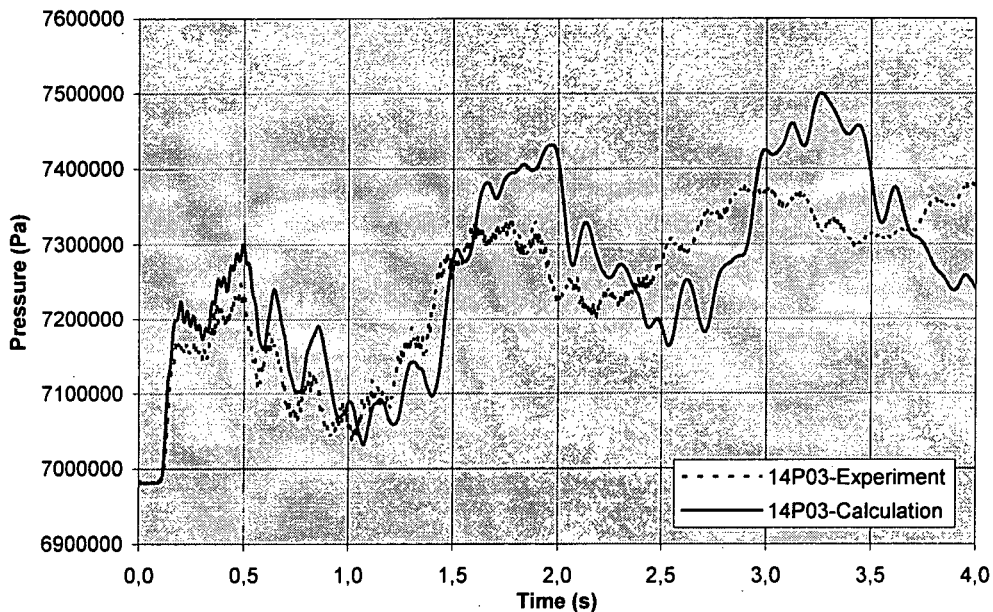

Fig. 3-6 Turbine Trip – Comparison Between Experiment and Calculation (Pressure 14P03)

We did not make efforts to solve the problem theoretically but used a simple formulation utilizing the comparison between the measured and computed results to account for the attenuation of the pressure oscillations.

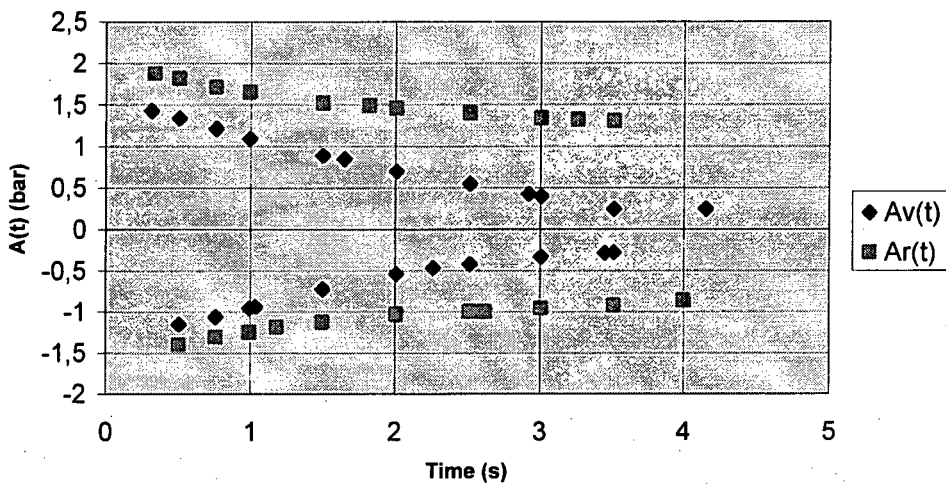

Fig. 3-7 Comparison of the Measured and Calculated Pressure Amplitudes Versus Time

Fig. 3-7 shows the measured amplitudes $A_v(t)$ and the calculated amplitudes $A_r(t)$ versus time. Their quotients are represented in Fig. 3-8 as a function of time. The curves in Fig. 3-8 can be fitted by the function $\text{Exp}(t/T)$ where t indicates the time. With this relation, we get a corrected pressure function $p_{\text{corr}}(t)$ from the calculated function $p(t)$

$$p_{\text{corr}}(t) = p(t)e^{-\frac{t}{T}}$$

considering the attenuation of the pressure. Choosing the time constant $T=3\text{s}$ we obtain a still conservative but more realistic approximation of the actual pressure functions which can be used to determine the pressure wave generated forces acting on the pipe segments of the steam line system concerned. The relation mentioned above is valid for all four loop plants of KWU design because their steam line systems have a similar geometry. The corrected pressure versus time functions is shown in Fig. 3-9, Fig. 3-10 and Fig. 3-11.

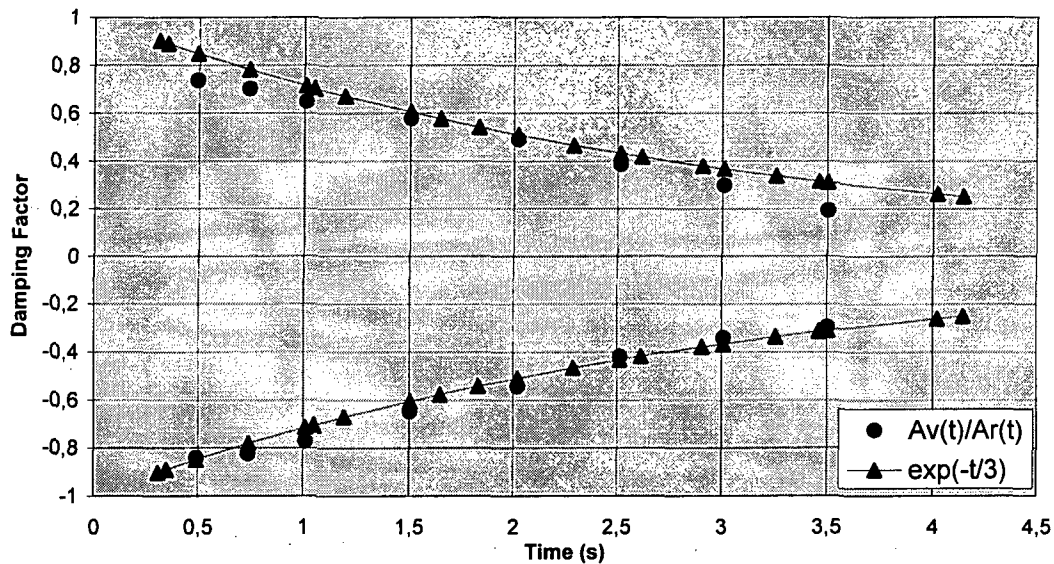

Fig. 3-8 Quotient of Measured and Calculated Pressure Amplitudes

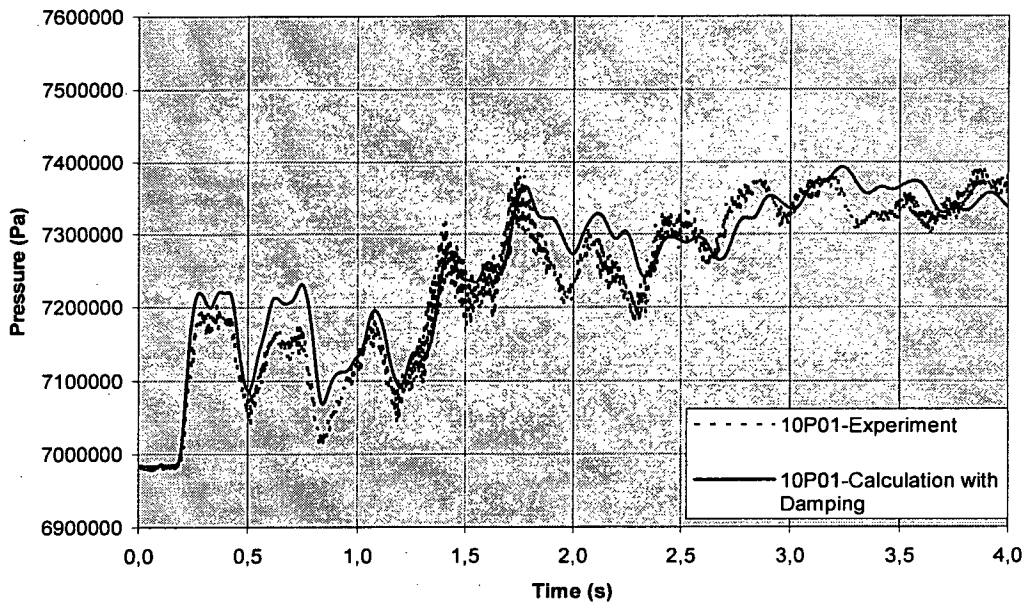

Fig. 3-9 Corrected Pressure Versus Time at Position 10P01

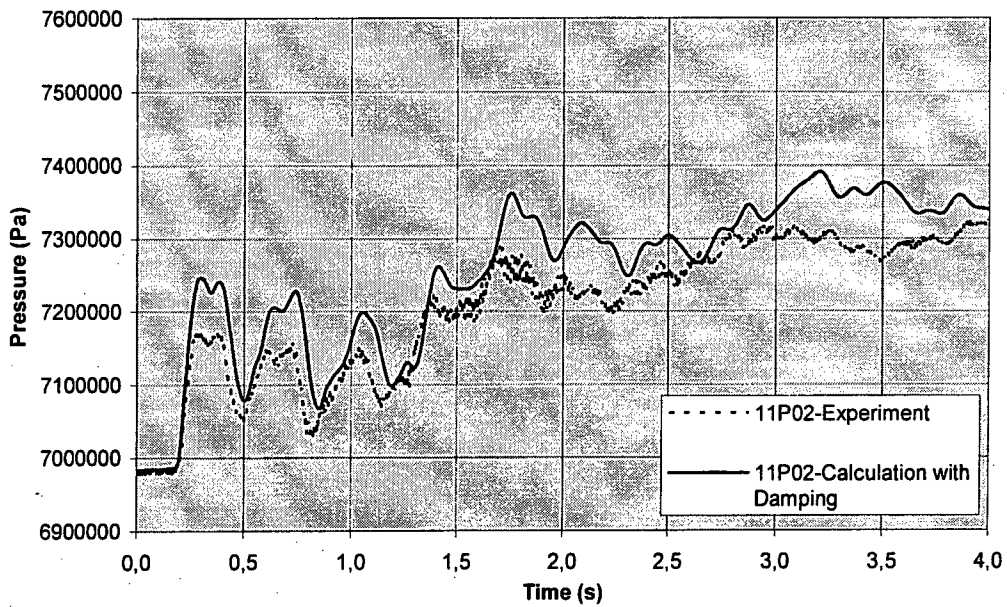

Fig. 3-10 Corrected Pressure Versus Time at Position 11P02

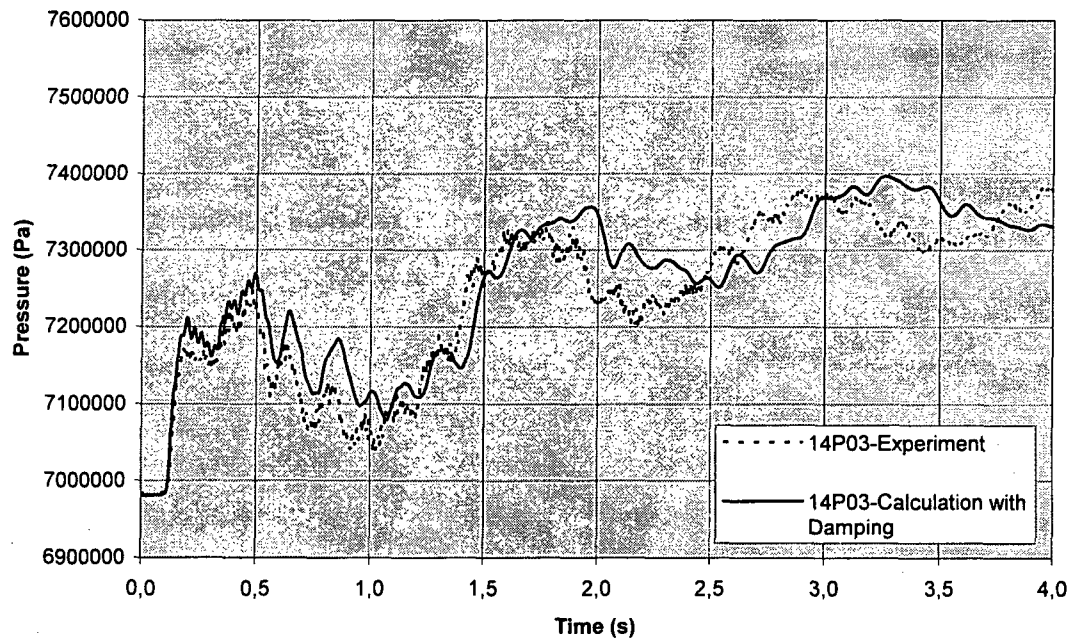

Fig. 3-11 Corrected Pressure Versus Time at Position 14P03

4. PRESSURE WAVES IN THE FEEDWATER SYSTEM OF A PWR CAUSED BY SHUTTING DOWN A FEEDWATER PUMP

4.1 Description of the Feed Water Pump Shut down Test

The feed water system of PWR of Siemens design essentially consists of three feed water lines. Each of them is equipped with a feed water pump comprising a forwarding pump and a main pump. The pumps deliver the feed water from the feed water storage tank to a header from which it is transferred to the steam generators.

During normal operation two pumps are working, the third one serves as standby unit. If one of the working pumps fails, back flow occurs in the leg under consideration as the still running pump maintains the back pressure. The back flow closes a swing check valve, which is situated at the outlet of the main pump. The closing check valve stops the back flow. Hereby a pressure wave is caused that runs as a compression wave in the direction of the steam generator and as an expansion wave in the direction of the feed water tank.

In the present case, the loads caused by the expansion wave in the feed water line are of interest in the context outlined below.

Having carried out mass reductions at the flaps of the feed water check valves of a 1200 MW_e PWR, the effect of this measure on the pressure wave behavior of the feed waterlines was tested by shutting down a feed water pump at reactor power of 60%. In the feed water line section located between the feed water tank and the position behind the swing check valve pressure versus time was recorded at three measuring points. Fig. 4-1 shows a simplified three dimensional sketch of the feed water line section concerned.

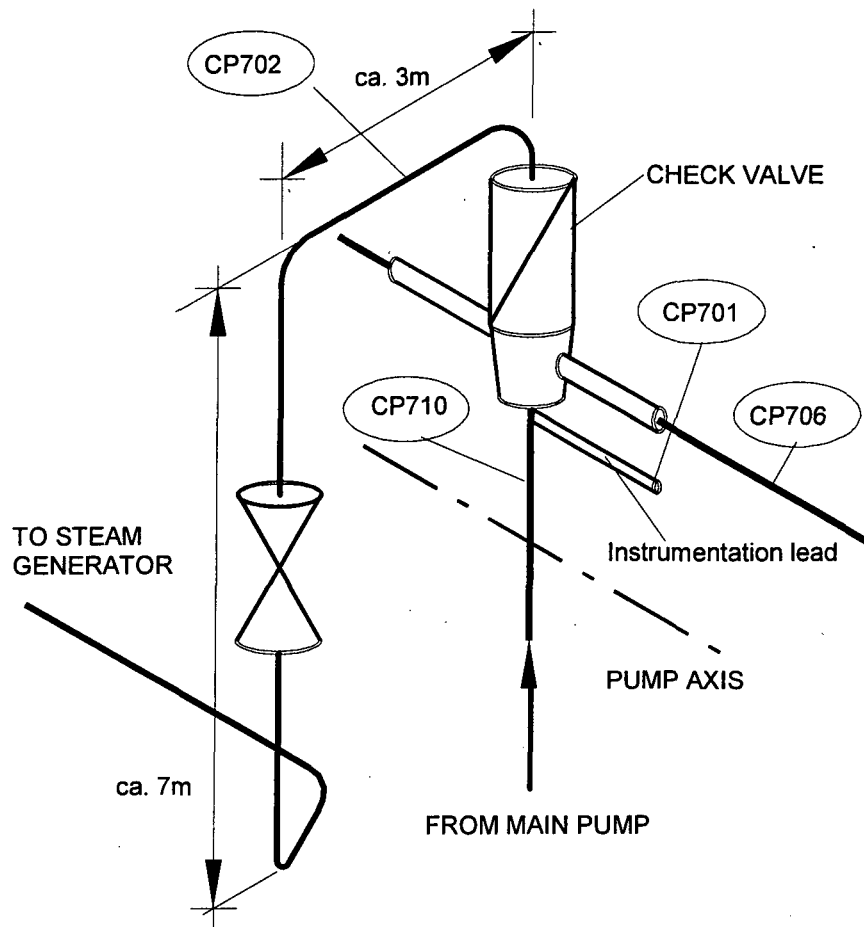

Fig. 4-1 Feed Water Line Section

The nodalization scheme used for the RELAP5 calculation is shown in Fig. 4-2. Here the measuring points are also indicated. A pressure sensor was used at the position CP701. At the remaining positions CP702, CP706 and CP 710 strain gauges were applied.

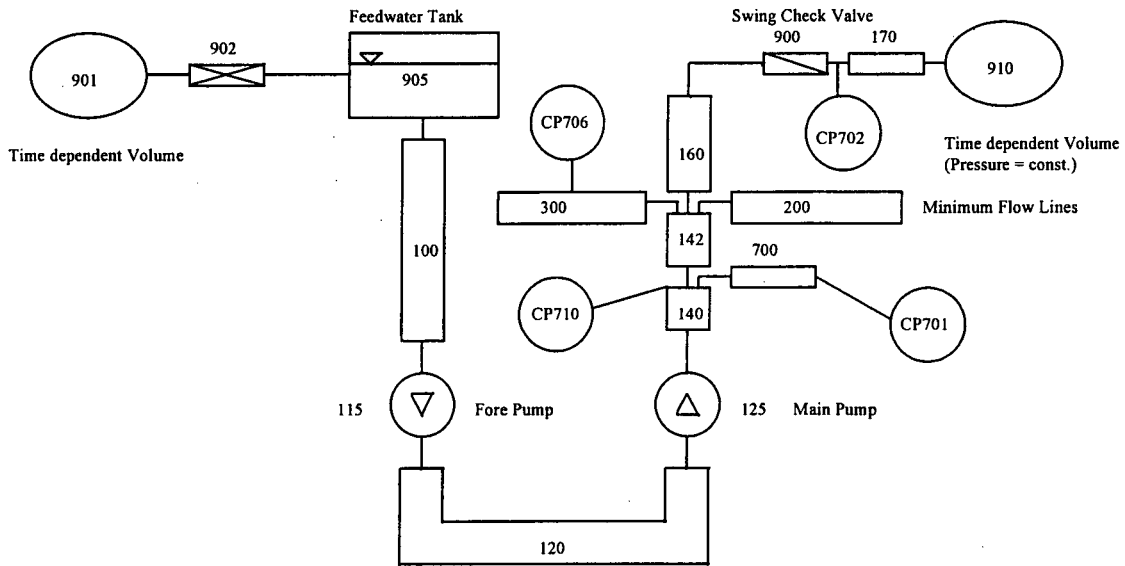

Fig. 4-2 Nodalization Scheme of the Feed Water Line Section

The data recorded at the measuring point situated behind the check valve (position CP702) is represented in Fig. 4-3. The pressure pattern shows many overshoots. An analysis of the signal proved that they were not physical but caused by ovalization oscillations of the pipe. Taking account of the measuring error we came to a pressure rise of

$$\Delta p = 8 \text{ bar} = 8 \cdot 10^5 \text{ Pa}$$

at the position behind the check valve. The pressure characteristics measured at the remaining positions are shown in Figs. 4.4 to 4.6. The data evaluation proved that they were unadulterated.

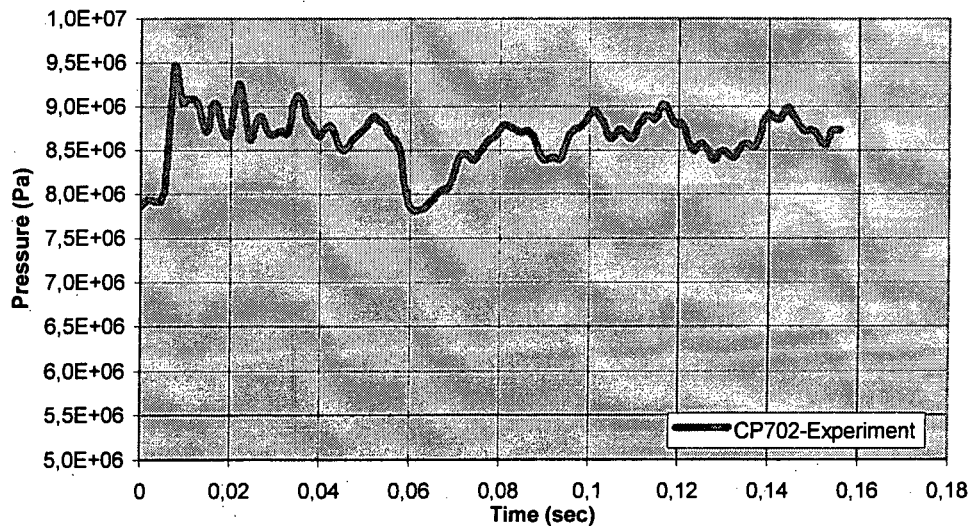

Fig. 4-3 Measured Pressure at Position CP702

4.2 Post-Test Calculation of the Experiment by RELAP5

In order to perform a post test calculation with RELAP5 the feed water line was nodalized from the feed water tank to the high pressure pre-heater. The mean nodalization length amounts 0.5 m. As system boundaries serve the feed water tank and the high pressure pre-heater. Because they are large vessels, they can be represented by time depended volumes. The feed water pump unit is characterized by its homologous curves. A motor valve describes the check valve. The nodalization scheme follows from Fig. 4-2.

The RELAP5 analysis was performed under the following initial conditions:

| | |
|--|-----------------------|
| Initial system pressure (steam generator pressure) | 67 bar |
| Fluid temperature | 165°C |
| Fluid density | 908 kg/m ³ |

From Joukowsky's law follows the mass flow to be decelerated

$$\dot{m} = \frac{\Delta p \cdot A}{c}$$

With the estimated pressure rise $\Delta p = 8\text{bar}$, the flow of area $A=0.167\text{m}^2$ and the velocity of sound $c = 1424 \text{ m/s}$, we obtain

$$\dot{m} \approx 100 \text{ kg / s .}$$

At the beginning of the calculation we assume the mass flow in the feed water line to be zero. If the mass flow in the volume situated behind the check valve (seen in main flow direction) reaches the above mentioned amount of 100 kg/s the check valve is closed in 100 ms. This simplification is admissible because the check valve does not become effective until the flapper is nearly closed. Fig. 4-4 to Fig. 4-6 show the comparison between the measured and the calculated results. Until the problem time of 0.01s the data show a good agreement. The first computed amplitudes match the measured ones. After 0.03 s we can notice a large difference between the measured and calculated data. This may be caused by wave reflections at pipe cross section changes which are neglected by the calculation. Furthermore we see that the code underestimates the attenuation.

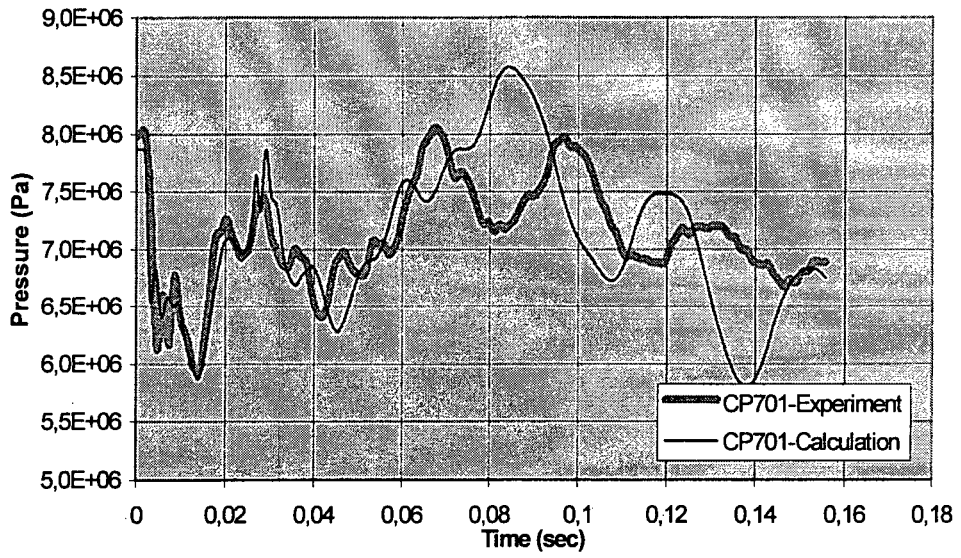

Fig. 4-4 Pressure Comparison at Position CP 701

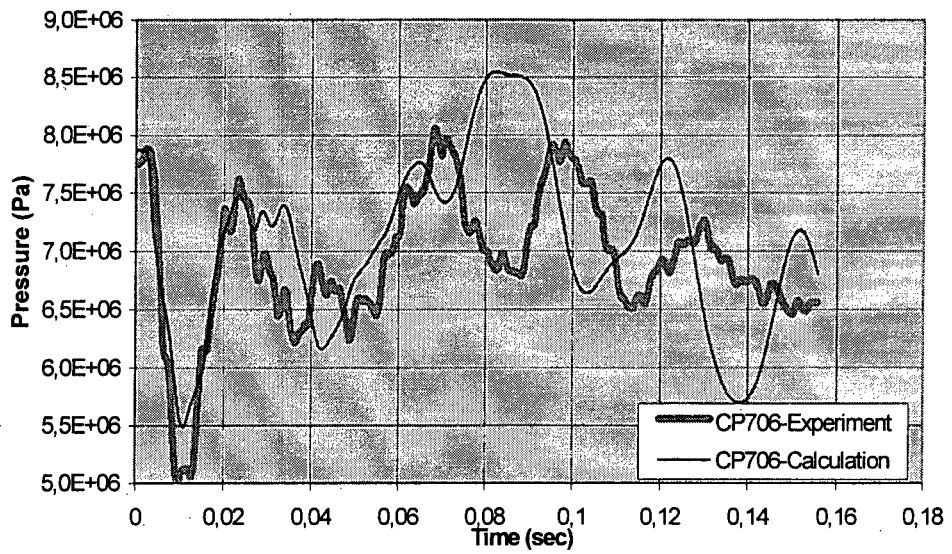

Fig. 4-5 Pressure Comparison at Position CP 706

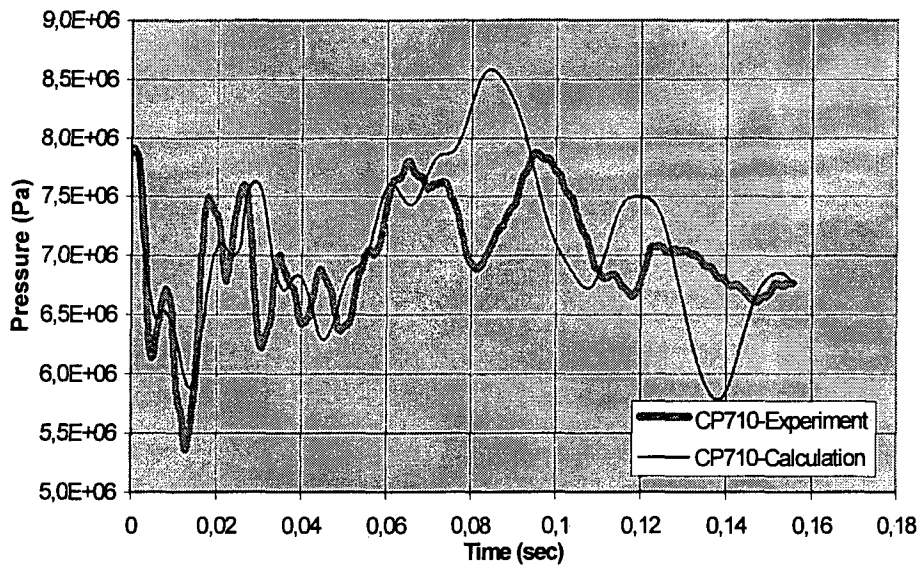

Fig. 4-6 Pressure Comparison at Position CP 710

5. CONCLUSIONS AND SUMMARY

Fast temporal variations of pressure or mass flow in piping systems induce pressure waves. The pressure waves propagate in the piping system where they cause forces acting on the pipe segments. These forces have to be taken into consideration when designing the piping system concerned. Pressure wave generating events, for instance, are opening and closing of valves or shutting down of pumps. The present report demonstrates the suitability of RELAP5 for calculating the propagation of pressure waves in piping systems by the following studies:

- Calculation of the propagation of pressure waves in a straight pipe by RELAP5 and by the Method of Characteristics (MOC).
- Post test analysis of the propagation of pressure waves in the main steam system of a pressurized reactor caused by a turbine trip using RELAP5
- Post test analysis of the propagation of pressure waves in the main feed water system of a pressurized reactor caused by shutting down of a feed water pump using RELAP5

The results obtained with RELAP5 agreed very well with those ones computed with the MOC which is an approved method to determine loads caused by pressure waves.

The post test analyses of the experiments showed a good to satisfactory agreement between measured and computed results. The computed results showed an overestimation of pressure amplitudes and of sound velocity, probably due to the disregard of the time dependence of friction losses.

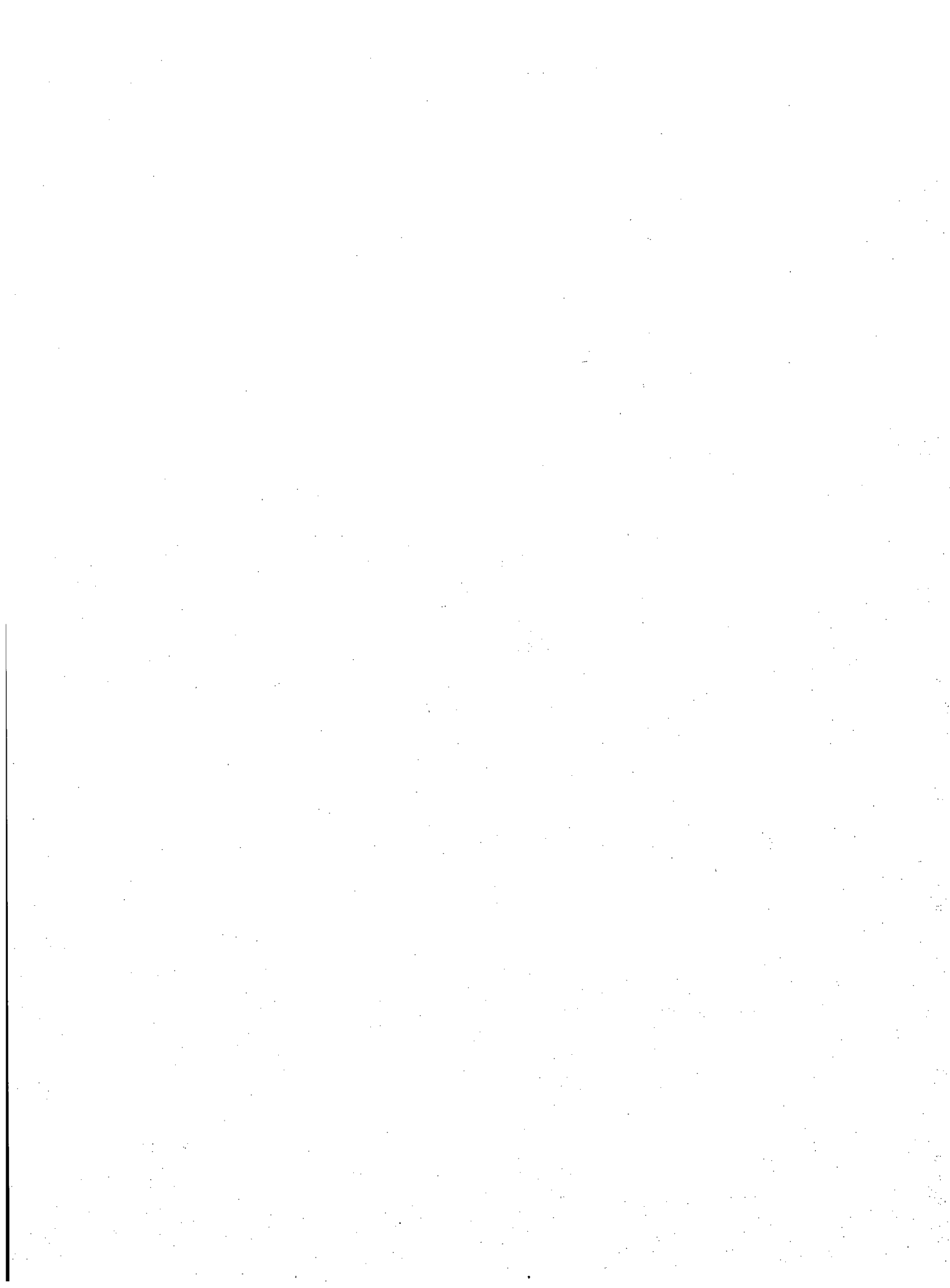

6. REFERENCES

/1/ DWELL: A Computer Code for the Simulation of Pressure Waves in Piping systems considering the Fluid Structure Interaction

TÜV Süddeutschland AG, München, 2002

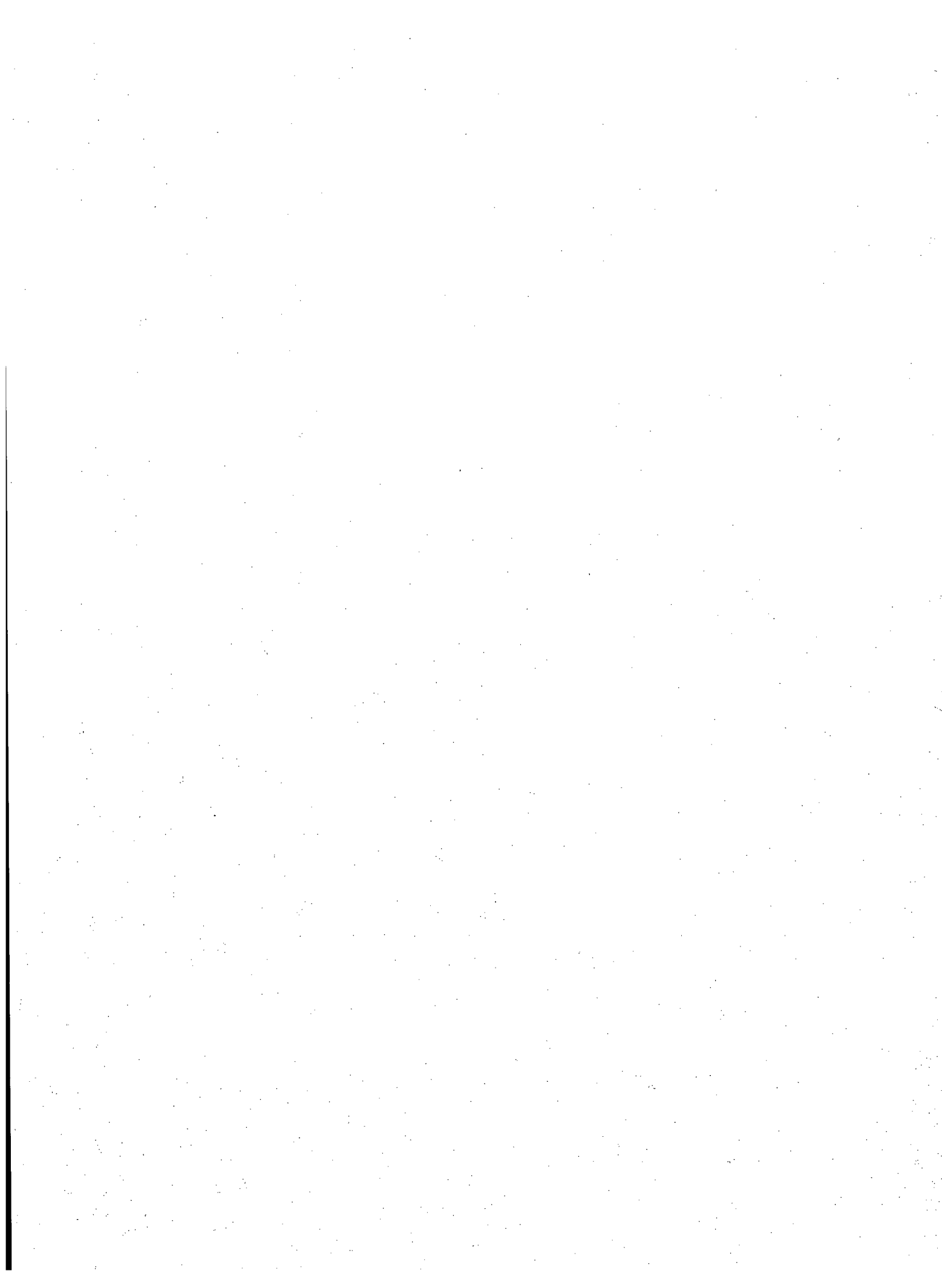

BIBLIOGRAPHIC DATA SHEET

(See instructions on the reverse)

NUREG/IA-0206

2. TITLE AND SUBTITLE

Simulation of the Propagation of Pressure Waves for Compressible Flow in Piping Systems
with RELAP5/MOD 3.2.2

Comparison of Computed and Measured Results

3. DATE REPORT PUBLISHED

MONTH

YEAR

June

2007

4. FIN OR GRANT NUMBER

5. AUTHOR(S)

Jurgen Perlia
Jorg Thomas Bornemann

6. TYPE OF REPORT

NUREG/IA

7. PERIOD COVERED (Inclusive Dates)

8. PERFORMING ORGANIZATION - NAME AND ADDRESS (If NRC, provide Division, Office or Region, U.S. Nuclear Regulatory Commission, and mailing address; if contractor, provide name and mailing address.)

TUV Sddeutschland AG Munchen Section Thermo and Fluid Dynamics
WestendraBe 199, D-80686 Munchen, German

9. SPONSORING ORGANIZATION - NAME AND ADDRESS (If NRC, type "Same as above"; if contractor, provide NRC Division, Office or Region, U.S. Nuclear Regulatory Commission, and mailing address.)

Division of Risk Assessment and Special Projects
Office of Nuclear Regulatory Research
U. S. Nuclear Regulatory Commission
Washington, DC 20555-0001

10. SUPPLEMENTARY NOTES

Michael B. Rubin, NRC Project Manager

11. ABSTRACT (200 words or less)

The present paper demonstrates the suitability of the computer code RELAP5 Mod 3.2.2 to describe the propagation of pressure waves in piping systems.

First a pressure wave in a simple straight pipe was analyzed with RELAP5. Results of the computation were compared with the outcomes obtained with the computer code DWELL. DWELL was developed by TUV using the method of characteristics. Results of both codes showed very good agreement.

Further the authors analyzed the following two transients for a 1200 MWe PWR-plant:

- o turbine trip
- o shutting down of a feedwater pump

In both cases, pressure versus time was recorded at several positions of the piping system concerned. The measured pressure signal curves were compared with the results of post test calculations performed with RELAP5.

A comparison of the results showed good to satisfactory agreement and proved that RELAP5 is able to solve pressure wave problems.

12. KEY WORDS/DESCRIPTORS (List words or phrases that will assist researchers in locating the report.)

RELAP5, pressure waves, pressure surge, piping systems, turbine trip, feedwater pump shutdown

13. AVAILABILITY STATEMENT

unlimited

14. SECURITY CLASSIFICATION

(This Page)

unclassified

(This Report)

unclassified

15. NUMBER OF PAGES

16. PRICE

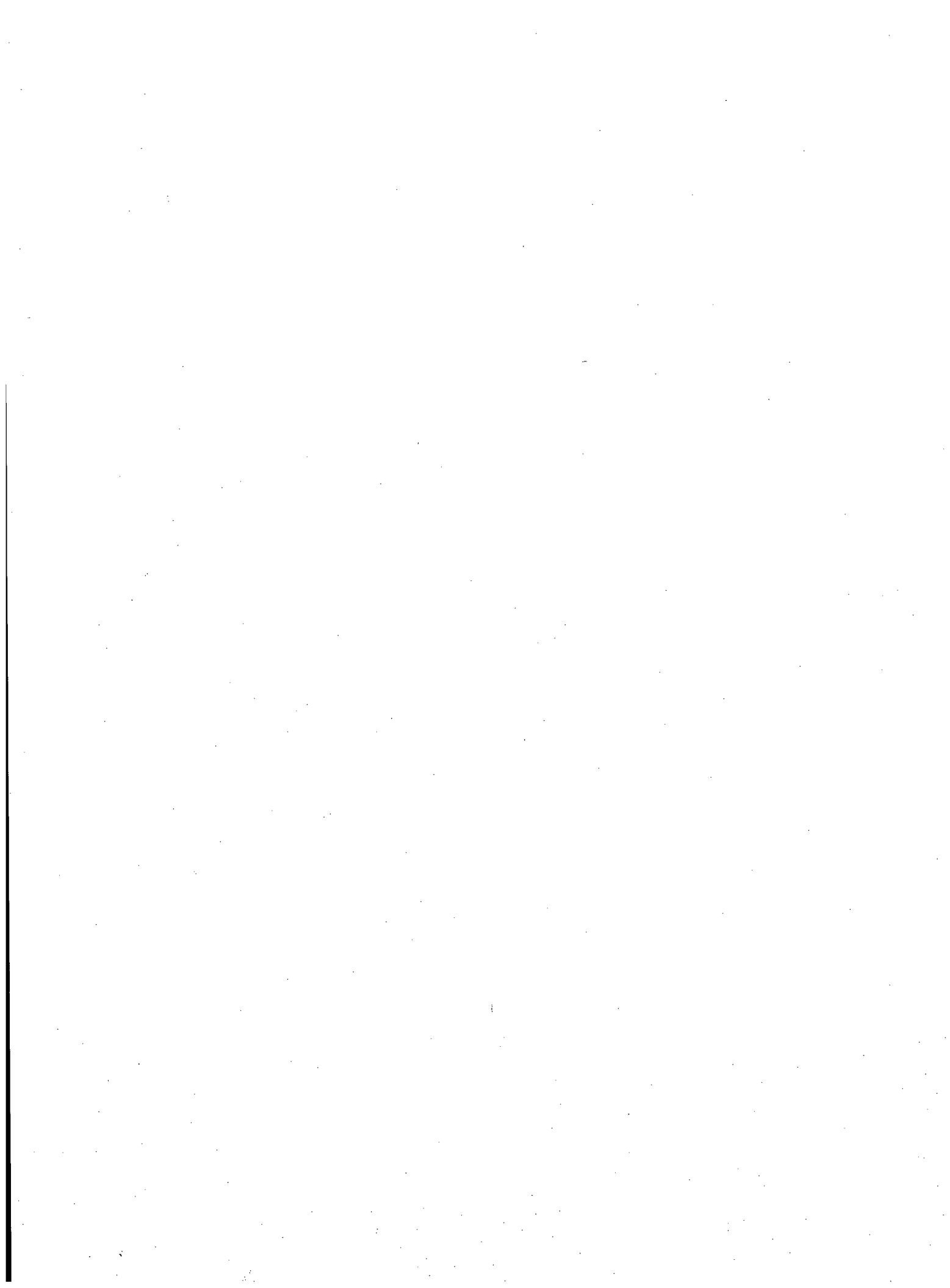



Federal Recycling Program



NUREG/IA-0206

**SIMULATION OF THE PROPAGATION OF PRESSURE WAVES IN PIPING SYSTEMS
WITH RELAP5/MOD 3.2.2
COMPARISON OF COMPUTED AND MEASURED RESULTS**

JUNE 2007

**UNITED STATES
NUCLEAR REGULATORY COMMISSION
WASHINGTON, DC 20555-0001**

OFFICIAL BUSINESS