

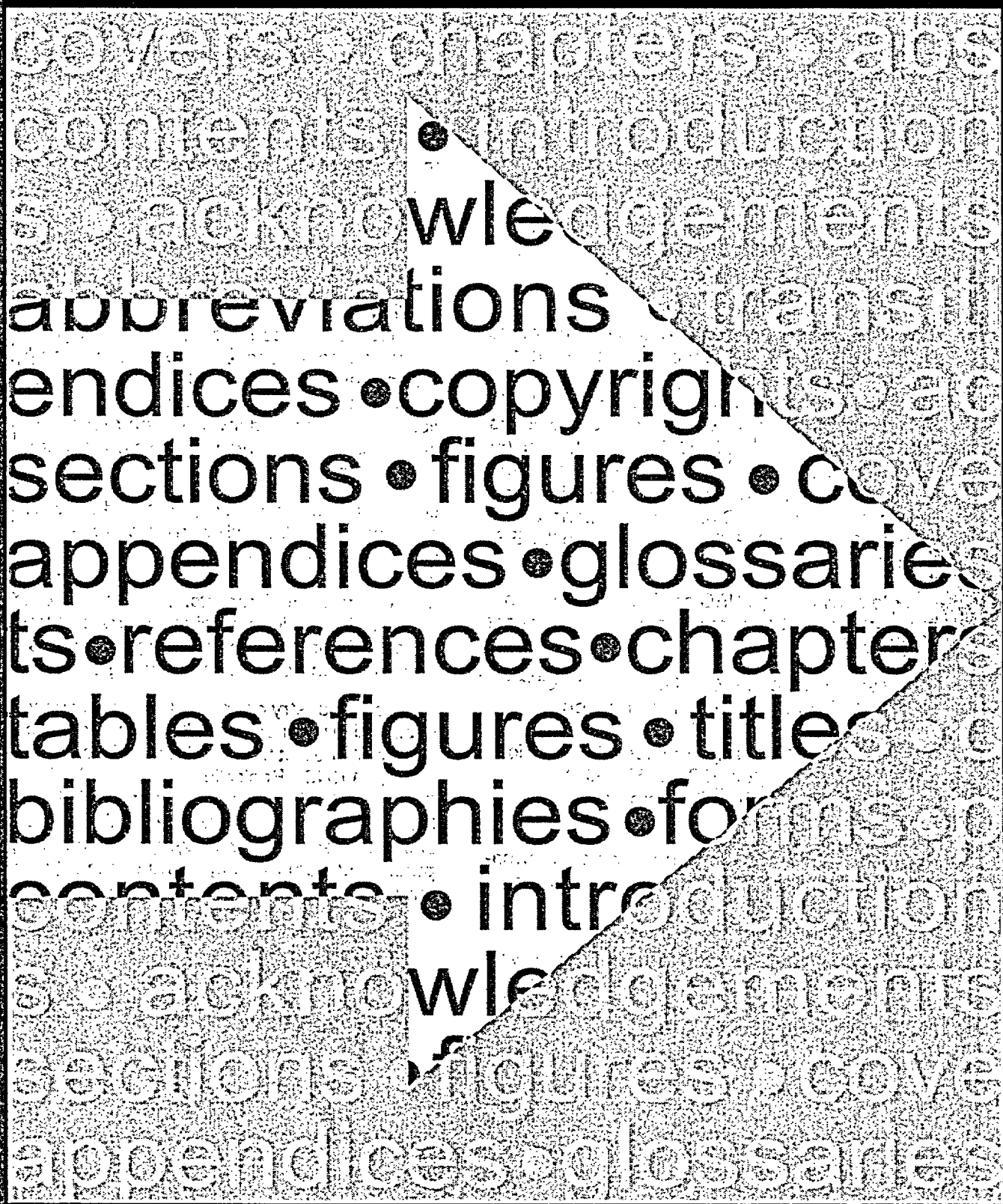

U.S. Nuclear
Regulatory
Commission

Preparing NUREG-Series Publications

Office of the Chief Information Officer



AVAILABILITY NOTICE

Availability of Reference Materials Cited in NRC Publications

NRC publications in the NUREG series, NRC regulations, and *Title 10, Energy, of the Code of Federal Regulations*, may be purchased from one of the following sources:

1. The Superintendent of Documents
U.S. Government Printing Office
P.O. Box 37082
Washington, DC 20402-9328
<http://www.access.gpo.gov/su_docs>
202-512-1800
2. The National Technical Information Service
Springfield, VA 22161-0002
<<http://www.ntis.gov/ordernow>>
703-487-4650

The NUREG series comprises (1) brochures (NUREG/BR-XXXX), (2) proceedings of conferences (NUREG/CP-XXXX), (3) reports resulting from international agreements (NUREG/IA-XXXX), (4) technical and administrative reports and books [(NUREG-XXXX) or (NUREG/CR-XXXX)], and (5) compilations of legal decisions and orders of the Commission and Atomic and Safety Licensing Boards and of Office Directors' decisions under Section 2.206 of NRC's regulations (NUREG-XXXX).

A single copy of each NRC draft report is available free, to the extent of supply, upon written request as follows:

Address: Office of the Chief Information Officer
Reproduction and Distribution
Services Section
U.S. Nuclear Regulatory Commission
Washington, DC 20555-0001
E-mail: <DISTRIBUTION@nrc.gov>
Facsimile: 301-415-2289

A portion of NRC regulatory and technical information is available at NRC's World Wide Web site:

<<http://www.nrc.gov>>

All NRC documents released to the public are available for inspection or copying for a fee, in paper, microfiche, or, in some cases, diskette, from the Public Document Room (PDR):

NRC Public Document Room
2120 L Street, N.W., Lower Level
Washington, DC 20555-0001
<<http://www.nrc.gov/NRC/PDR/pdr1.htm>>
1-800-397-4209 or locally 202-634-3273

Microfiche of most NRC documents made publicly available since January 1981 may be found in the Local Public Document Rooms (LPDRs) located in the vicinity of nuclear power plants. The locations of the LPDRs may be obtained from the PDR (see previous paragraph) or through:

<<http://www.nrc.gov/NRC/NUREGS/SR1350/V9/lpdr/html>>

Publicly released documents include, to name a few, NUREG-series reports; *Federal Register* notices; applicant, licensee, and vendor documents and correspondence; NRC correspondence and internal memoranda; bulletins and information notices; inspection and investigation reports; licensee event reports; and Commission papers and their attachments.

Documents available from public and special technical libraries include all open literature items, such as books, journal articles, and transactions, *Federal Register* notices, Federal and State legislation, and congressional reports. Such documents as theses, dissertations, foreign reports and translations, and non-NRC conference proceedings may be purchased from their sponsoring organization.

Copies of industry codes and standards used in a substantive manner in the NRC regulatory process are maintained at the NRC Library, Two White Flint North, 11545 Rockville Pike, Rockville, MD 20852-2738. These standards are available in the library for reference use by the public. Codes and standards are usually copyrighted and may be purchased from the originating organization or, if they are American National Standards, from—

American National Standards Institute
11 West 42nd Street
New York, NY 10036-8002
<<http://www.ansi.org>>
212-642-4900



Preparing NUREG-Series Publications

U.S. Nuclear Regulatory Commission
Washington, DC 20555-0001

Office of the Chief Information Officer
Information Management Division

January 1999

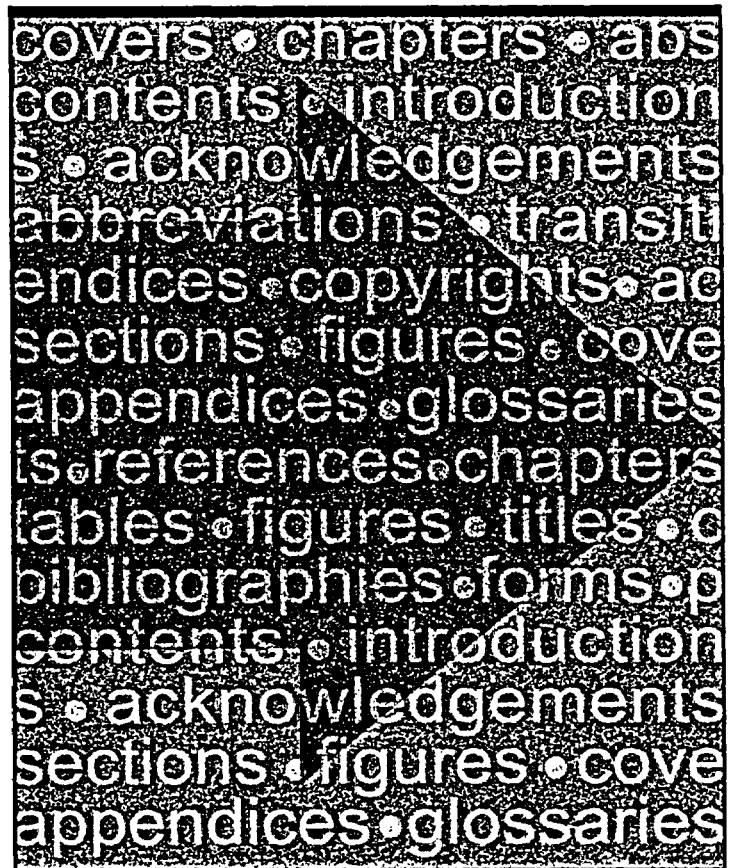

NUREG-0650, Revision 2

ABSTRACT

The guidance in this publication is for the staff and contractors who prepare manuscripts to be published in the NUREG series for the U.S. Nuclear Regulatory Commission (NRC). This Revision 2 to NUREG-0650, "Publishing Documents in the NUREG Series," is retitled "Preparing NUREG-Series

Publications." It gives more concise and up-to-date guidance, including certain Internet and World Wide Web addresses. It describes how to cite references to electronic information and, in addition, refers the NRC staff to online style guidance for Web site publishing.

Content of a NUREG-Series Publication

Before you decide to draft a NUREG-series publication, consider whether your information is appropriate to be published in the NUREG series. Does the information give—

- support for a regulatory decision;
- results of licensing studies preliminary to licensing actions;
- results of generic regulatory or technical analyses;
- managerial, programmatic, or administrative analyses of interest to the staff, the industry, and the public;
- research about, or resolution of, a problem of interest to the nuclear industry at large;
- action plans and guidance for meeting NRC requirements;
- a team report on a specific topic; or
- proceedings of a conference or workshop?

Legally binding regulatory requirements are stated only in laws; NRC regulations; licenses, including technical specifications; or orders. Although the NRC staff may suggest a course of action in a NUREG-series publication, these suggestions are not legally binding and the regulated community may use other approaches to satisfy regulatory requirements. Only unclassified information is published in this series.

CONTENTS

| | Page |
|--|------|
| ABSTRACT | iii |
| 1 INTRODUCTION | 1 |
| 1.1 Objectives of These Guidelines | 1 |
| 1.2 Publishing Policy | 1 |
| 1.3 Publishing Services | 1 |
| 2 TYPES OF PUBLICATIONS | 3 |
| 2.1 Reports | 3 |
| 2.2 Brochures | 3 |
| 2.3 Conference Proceedings | 3 |
| 2.4 International Agreement Reports | 3 |
| 2.5 Books | 3 |
| 2.6 Report Designators | 3 |
| 3 PLANNING YOUR DOCUMENT | 5 |
| 3.1 Electronic Submission of Manuscripts | 5 |
| 3.2 Metrication | 5 |
| 3.3 Consistency | 5 |
| 3.4 Page Format | 6 |
| 3.5 Visual Material | 6 |
| 3.5.1 Selecting and Preparing Visuals | 6 |
| 3.5.2 Style | 6 |
| 3.5.3 Color | 7 |
| 3.6 Guidelines for Figures | 7 |
| 3.7 Guidelines for Tables | 8 |
| 3.8 Copyright Clearance | 8 |
| 3.9 Patent Clearance | 9 |
| 3.10 Security Clearance | 9 |
| 4 GENERAL FORMAT AND CONTENT | 17 |
| 4.1 Front Matter | 17 |
| 4.1.1 Cover | 17 |
| 4.1.2 Availability Notice | 18 |
| 4.1.3 Title Page | 18 |
| 4.1.4 Previous Reports in Series | 18 |
| 4.1.5 Abstract | 18 |

| | | |
|-----------|--|----|
| 4.1.6 | Contents | 19 |
| 4.1.6.1 | Figures | 19 |
| 4.1.6.2 | Tables | 19 |
| 4.1.7 | Executive Summary | 19 |
| 4.1.8 | Preface | 19 |
| 4.1.9 | Foreword | 19 |
| 4.1.10 | Acknowledgments | 20 |
| 4.1.11 | Abbreviations | 20 |
| 4.1.12 | Symbols | 20 |
| 4.2 | Body of the Report | 20 |
| 4.2.1 | First Section | 20 |
| 4.2.2 | Subsequent Sections | 20 |
| 4.2.3 | Findings, Conclusions, and Recommendations | 20 |
| 4.2.4 | References | 21 |
| 4.2.4.1 | Generic Information for Reference Citations | 21 |
| 4.2.4.2 | Reference Citations for Electronic Information | 22 |
| 4.2.4.3 | Identifying References in Text | 22 |
| 4.2.4.3.1 | Printed Documents | 22 |
| 4.2.4.3.2 | Electronic Documents | 23 |
| 4.3 | Back Matter | 23 |
| 4.3.1 | Bibliography | 23 |
| 4.3.2 | Glossary | 23 |
| 4.3.3 | Appendix | 24 |
| 4.3.4 | Index | 24 |
| 5 | PUBLISHING FORMS | 35 |

Appendix

| | |
|---------------------|----|
| SAMPLE REPORT | 42 |
|---------------------|----|

Figures

| | | |
|-----|---|----|
| 3.1 | Sample Style Sheet | 10 |
| 3.2 | Sample Photograph | 11 |
| 3.3 | Sample Map | 12 |
| 3.4 | Sample Figure Denoting Size of Object | 13 |
| 3.5 | Sample Figure with Legend | 14 |
| 3.6 | Sample Table | 15 |

| | | |
|-----|---|----|
| 3.7 | Sample Copyright Permission Letter | 16 |
| 4.1 | Sample Contents | 26 |
| 4.2 | Sample List of Abbreviations | 27 |
| 4.3 | Sample List of Symbols | 28 |
| 4.4 | Sample List of References: Listed Alphabetically by Author or Corporate Author | 29 |
| 4.5 | Sample List of References: Listed Numerically as Referred to in Text | 31 |
| 4.6 | Sample Bibliography | 32 |
| 4.7 | Sample Glossary | 33 |
| 5.1 | NRC Form 335, "Bibliographic Data Sheet" | 36 |
| 5.2 | Sample Completed NRC Form 335 | 37 |
| 5.3 | NRC Form 426, "Authorization To Publish a NUREG-Series Document Prepared by the NRC Staff" | 38 |
| 5.4 | Sample Completed NRC Form 426 | 39 |
| 5.5 | NRC Form 426A, "Authorization To Publish a NUREG-Series Document Prepared by a Contractor for the NRC Staff" | 40 |
| 5.6 | Sample Completed NRC Form 426A | 41 |

Tables

| | | |
|-----|---|----|
| 4.1 | Organization and Pagination for a NUREG-Series Report | 34 |
|-----|---|----|

1 INTRODUCTION

1.1 Objectives of These Guidelines

This style guide is for the staff and contractors who prepare manuscripts to be published in the NUREG series for the U.S. Nuclear Regulatory Commission (NRC). The objectives of these guidelines are to—

- improve readability;
- standardize format;
- ensure consistency;
- facilitate information retrieval;
- ensure accuracy of references;
- ensure public availability of references; and
- ensure that the format is Web-compatible, as necessary.

The guide describes appropriate content and the scope of information published by the NRC in its NUREG-series publications: technical reports, including those prepared for international agreements; conference proceedings; books; and a variety of brochures. Next, it provides essential background information for planning a publication, such as considering the use of graphics and taking into account patent clearance, security reviews, and the need for permission to use copyrighted material. Then, it describes in detail the common components in agency technical reports. Finally, it describes the forms necessary for authorizing publication. The appendix is a sample manuscript for a NUREG-series publication.

The NRC staff may access online guidance for preparing manuscripts that will be coded with hypertext markup language (HTML) for posting to the NRC World Wide Web (WWW) site at <http://www.internal.nrc.gov/NRC/PLAIN/STYLE/WP/index.html>.

For additional information about abbreviations, see “NRC Collection of Abbreviations” (NUREG-0544, Rev. 4). For NRC editorial style for (1) capital letters, (2) hyphenation, (3) numbers, (4) equations, and (5) punctuation, see “NRC Editorial Style Guide” (NUREG-1379).

1.2 Publishing Policy

The policy governing these publications is found in the following NRC Management Directives:

- 3.7 Staff Publications in the NUREG Series
- 3.8 Contractor-Prepared Publications in the NUREG Series
- 3.11 Conferences and Conference Proceedings

If you are not an NRC employee, order these directives and final NUREG-series publications by calling the Government Printing Office (GPO) at 202-512-1800 or sending your order to the WWW address http://www.access.gpo.gov/su_docs. If you are an NRC employee, call 415-2070 or send your electronic mail (e-mail) request to <DISTRIBUTION>.

1.3 Publishing Services

For the NRC staff to coordinate the following services for a NUREG-series publication, send a message to the Publishing Services Branch at e-mail address <pubs>. These services include—

- obtaining a publication designator,
- editing,
- coordinating graphics and composition,
- approval for use of color,
- manuscript review,

- publishing and reprinting, and
- distribution.

For the NRC staff to discuss posting a publication to the WWW site, send a request by e-mail to <nrcweb>, and check WWW in Block 5 of NRC Form 426, the

authorization to publish (see Section 5 of this publication).

The Publishing Services Branch is part of the Information Management Division in NRC's Office of the Chief Information Officer.

2 TYPES OF PUBLICATIONS

The NRC prepares the following types of publications in its NUREG series:

- reports, including those prepared for international agreements;
- brochures;
- conference proceedings; and
- books.

2.1 Reports

NRC reports cover a variety of regulatory and technical subjects of interest to the staff and the nuclear industry. They include licensing, research, investigative, and administrative topics related to the agency's mission.

2.2 Brochures

Brochures include pamphlets, directories, handbooks, manuals, procedural guides, and periodicals, such as newsletters. Some are intended principally for NRC staff use.

2.3 Conference Proceedings

Conference proceedings are compilations of formal papers, presentations, and transcripts from technical conferences, seminars, or workshops.

2.4 International Agreement Reports

NRC international agreement reports result from international information exchange agreements between the NRC and foreign governments and organizations. In these agreements, foreign participants agree to submit *unclassified* nuclear safety information to the NRC for publication.

2.5 Books

The NRC publishes books to serve a unique technical purpose or to meet an industry-wide need. An NRC book is considered a permanent reference, a textbook, or a major critical review of a technical or regulatory topic. Its contents must be broadly valid and applicable for at least 5 years after publication. Each book undergoes stringent peer review.

2.6 Report Designators

Each NRC publication is identified by a unique alphanumeric designator, for example, NUREG-1555 or NUREG/CR-1666. The alpha designation "NUREG" identifies the publication as an NRC publication (Nuclear Regulatory); it is followed by a four-digit number, or it is followed by two letters further identifying the type of report and a four-digit number to form the complete designator.

Publications that the staff prepare bear the following designators:

NUREG-XXXX for a report or book;

NUREG/BR-XXXX for a brochure;
NUREG/CP-XXXX for a conference proceedings;

NUREG/IA-XXXX for a report resulting from an international agreement.

Publications that contractors prepare for the staff bear the NRC designator and usually bear the contractor's designator under it as follows:

NUREG/CR--XXXX
ORNL-XXXX

Request the publication designator as close to the publication date as possible to avoid

cumulation of unused designators in our publications tracking system (see Block 1

on NRC Form 426 or 426A—Figures 5.3 and 5.5 in this guide).

3 PLANNING YOUR DOCUMENT

Legally binding regulatory requirements are stated only in laws; NRC regulations; licenses, including technical specifications; or orders. Although the NRC staff may suggest a course of action in a NUREG-series publication, these suggestions are not legally binding and the regulated community may use other approaches to satisfy regulatory requirements. Only unclassified information is published in this series.

Following guidance in this and subsequent sections, you will ultimately prepare a camera-ready copy of your manuscript for publication.

3.1 Electronic Submission of Manuscripts

As the age of technology demands multimedia publishing and electronic access to publications, we are planning for submission of manuscripts in both electronic and hardcopy media. The NRC prefers that manuscripts for NUREG-series publications be created in WordPerfect 6.1 or a later version. Our current agency standard is WordPerfect 8.0. To the extent possible, all visual material except photographs should be importable into the WordPerfect file. These files may be submitted on compact disk (CD ROM), in a variety of magnetic media, and over the internet along with camera-ready copy.

NRC is also beginning to publish its documents on compact disks (CDs) and will accept CDs for publication in addition to camera-ready copy. NRC is still required by law to publish hardcopy.

3.2 Metrication

The NRC Policy Statement titled "Conversion to the Metric System" (57 FR 46202, 10/07/92) states, in part:

...the NRC will publish...in dual units...
NUREG-series documents.... In

dual-unit documents, the first unit presented will be in the International System of Units with the English unit shown in brackets.

It goes on to except licensee-specific documents from the dual-unit system by stating:

Documents specific to a licensee, such as inspection reports...will be in the system of units employed by the licensee. This protocol reflects a general approach that only documents applicable to all licensees, or to all licensees of a given type in which a licensee may operate in the metric system will contain dual units, otherwise English or metric units alone are permissible.

3.3 Consistency

If a document is written by multiple authors, a lead author should review the entire document to ensure that it is consistent throughout. The lead author is the sole contact with the editor or with others involved in producing the document. The lead author and the editor should create a one- or two-page document style sheet (Figure 3.1) for contributing authors before they begin to write. The style sheet may include an outline of how to treat the recurrent features of a document, such as abbreviations, capital letters, numbers, hyphens, and reference citations. Consult NUREG-1379 and NUREG-0544, Rev. 4, for additional information. The style sheet may contain

the following kinds of guidance and is usually amended as work progresses:

- how to format and identify sections;
- the preferred way to identify licensees, contractors, and subcontractors;
- the preferred term or terms for equipment, measurements, personnel (i.e., job titles), and the like;
- when to use “shall,” “must,” “should,” “may,” or “may not”;
- when to use the present and past verb tenses;
- how to identify and abbreviate procedures referred to in the text; and
- how to cite references.

The sheet may also include any special instructions to text processing operators about formatting, version control, coordinating drafts, and handling computer files.

Ensure also that report terminology in the document is consistent throughout. For example, do not refer to the same phenomenon as a “percentage” in the text and as a “proportion” in a table or figure.

3.4 Page Format

Single-space the manuscript, leaving one-inch margins on all sides. Publications other than reports may have unique formats (see Section 4). Use two-column layout except for a report composed primarily (75 to 80 %) of mathematical equations, formulae, tables, or visual material. In these exceptions, prepare a double-spaced camera-ready copy in single-column format. Place the complete NUREG-series designator on the bottom right-hand corner of an odd-numbered page and on the bottom left-hand corner of an even-numbered page. Place the page numbers in the center of each page (see the pages in the appendix to this guide).

3.5 Visual Material

Tables, graphs, photographs, drawings, charts, and maps—often collectively called *visuals*—can frequently express ideas or convey information that words alone cannot. Tables allow the easy comparison of large numbers of statistics that would be difficult to understand if they appeared in sentence form. Graphs make trends and mathematical relationships immediately evident. And drawings, photographs, charts, and maps can indicate shapes and relationships in space more concisely and efficiently than text alone. See Sample Figures 3.2 through 3.5 at the end of this section for illustrations of properly prepared visuals.

3.5.1 Selecting and Preparing Visuals

When the NRC staff is preparing a document that includes visual material, consult the Publishing Services Branch at e-mail address <pubs> to have an editor work with you and the Graphics Staff to determine—

- whether the material meets publication standards;
- how to integrate the material in the text;
- whether the design of the material is consistent with the design of the document; and
- whether the material is in the best form to convey the intended message.

Edit the visual material against the text in the document to ensure that the data and terminology in both are consistent. Prepare tables using the table feature in word processing software. Doing so is especially important for publications that will be posted to NRC’s WWW site.

3.5.2 Style

Use a consistent style for all the same components—caption, head, and

legend—of visual material. For example, use an initial capital letter for each major word of the caption or for all axis labels or an initial capital letter for the first word of the caption. Whatever your choice, adhere to it consistently throughout the same document. Avoid the use of abbreviations except for measurements. Use the same font for all figures in the document to the extent possible.

3.5.3 Color

Visual material must generally be in black and white or shades of grey because color printing is significantly more expensive. When the NRC staff wants approval to use more than one color for visual material or any part of the publication, contact the Publishing Services Branch at e-mail address <pubs>.

3.6 Guidelines for Figures

Three options are available for preparing figures: (1) ask the Graphics Staff to prepare the material; (2) use existing material; or (3) use computer-prepared material, printed on a laser printer with a resolution of no fewer than 600 dots per square inch (DPI). Follow these guidelines regardless of how figures are prepared:

- Place a number and caption for each figure under the figure.
- Number figures consecutively throughout a publication (e.g., Figure 1, Figure 2) or consecutively within each section or appendix of a publication (e.g., Figure 1.1, Figure 2.1 or Figure A.1, Figure A.2).
- Include a key (legend) that lists and explains any symbols.
- Refer to the figure and explain its significance in the text immediately preceding the figure.
- Place the figure as close as possible after its first reference in the text.
- If a report includes five or more figures, list each figure number, its caption, and page number under "Figures" in the "Contents" section. Figures in an appendix may be listed in the "Contents" section for the appendix.
- Obtain the original or the most reproducible copy of each figure for printing. If a figure will not print well, eliminate it or redo it.
- Avoid the use of color if at all possible to reduce printing costs.
- Use high-contrast, glossy, clear black and white photographs, and submit the original photographs.
- Indicate the orientation for the photograph and the relative size of the significant person or object in the photograph by placing a familiar object, a person, a rule, or a scale, in the photograph (see Figure 3.4).
- Handle an original photograph with care. Do not draw crop marks on the original. Instead, make a copy of it, draw crop marks on the copy, and submit it with the original for printing. Do not trim the original to size. Do not use paper clips without padding or write on an original figure, a photograph, or an overlay because either practice will leave an impression on the original that may be visible in the printed publication. Also, do not fold or roll a photograph as these practices will crack the emulsion, and the crack will be visible after the photograph is printed.
- For maps, identify all boundaries clearly and eliminate unnecessary boundaries. Include a scale of miles or

kilometers to inches to indicate proportions. Indicate which direction is north. Show the features you wish to emphasize by using shading, dots, crosshatching, or appropriate symbols when color reproduction cannot be used. Include a key or legend identifying the different shadings, symbols, or colors used (see Figure 3.3).

3.7 Guidelines for Tables

Use the following guidelines, and see Figure 3.6 for a sample table:

- Place a number and title for each table above the table.
- If a table requires more than one page, repeat the table number and title, followed by "(continued)," on each subsequent page.
- If a report includes five or more tables, list each table number, its caption, and page number under "Tables" in the "Contents." Tables in an appendix may be listed in the "Contents" for the appendix.
- Number tables consecutively throughout a publication (e.g., Table 1, Table 2) or consecutively within each section or appendix (e.g., Table 1.1, Table 2.1 or Table A.1, Table A.2).
- Present data on only one subject in each table.
- Explain the purpose of the table or the significance of its information in the text preceding the table.
- Place the table as close as possible after its first reference in the text.
- If a table is so long that it would interfere with reading the text, place it

at the end of the section in which it is cited.

3.8 Copyright Clearance

Copyrighted material, either text or visual, cannot be reproduced in NRC publications without written permission from the copyright holder. Figure 3.7 is a sample letter for requesting such permission.

In accordance with copyright law (17 U.S.C. 101 et seq.), non-Government publications created after January 1, 1978, receive copyright protection whether or not they bear a copyright notice—copyright notices usually appear on the back of the work's title page. Therefore, material drawn from a non-Government publication is most likely subject to copyright protection and should not be reproduced without first obtaining copyright permission from the copyright holder. Copyrighted visual material such as a figure or table also requires permission for use from the copyright holder. To obtain permission, send the copyright holder a copyright permission request letter (see Figure 3.7) to sign and return before the document is printed. If the need for permission is immediate, send the letter by facsimile and request that the copyright permission release be returned by facsimile. The signed letter can subsequently be mailed.

If permission to reproduce the copyrighted material is granted, cite the copyright holder in a source line where the information is referenced. If the holder does not request a particular source line, use the following:

Permission to use this copyrighted material is granted by (name of copyright holder).

In accordance with the Fair Use Provision of copyright law, up to 200 words of material from a copyrighted work may

generally be used without the permission of or payment to the copyright holder as long as the use is reasonable and not harmful to the rights of the copyright holder and as long as the source is cited.

Contact the NRC's Office of the General Counsel (OGC) for advice when (1) you cannot determine who holds the copyright, (2) the copyright owner will not grant permission for reproduction, or (3) you have any doubt about using material from a non-Government work.

In addition, publications that explain the copyright law in detail are available from the Copyright Office, Library of Congress, Washington, DC 20540-0001. The Web address is <<http://www.loc.gov>>.

Although works published by the U.S. Government are in the public domain and are not protected by copyright, an NRC employee may obtain a private copyright for a work related to NRC functions that is not prepared as part of the employee's official duties. Consult the OGC for a ruling on whether to seek a private copyright for a work related to NRC functions.

3.9 Patent Clearance

If a publication involves a patent, consult the Patent Counsel in the OGC about

obtaining patent clearance and have the OGC counsel sign and date NRC Form 426, the publication release form (see Section 5 of this publication).

3.10 Security Clearance

Request that the Division of Facilities and Security, Office of Administration, review any document to be published in the NUREG series that contains or may contain *classified* or *sensitive unclassified* information.

If a document contains *classified* information (Restricted Data, Formerly Restricted Data, or National Security Information) or *sensitive unclassified* information (Limited Official Use, Official Use Only, Proprietary, or Safeguards) that requires markings, follow the procedures for preparing and marking these documents or for reproducing or disseminating them, if permitted, in accordance with Management Directive (MD) 12.2, "NRC Classified Information Security Program," or MD 12.6, "NRC Sensitive Unclassified Information Security Program." Ensure that an *unclassified* version of a *classified* document receives a security review before it is published. Only *unclassified* information is published in the NUREG series.

STYLE SHEET FOR DEPARTMENT OF ENERGY PILOT PROJECT REPORTS*

VERSION CONTROL SYSTEM: While writing separate sections before you compile the first complete draft report, label each section Draft 1, 2, and so forth, and date each one (using the date code feature) so that no confusion arises about which draft is the most recent. Place this information in a footer on each page. For the complete document, use the same system applied to control of the separate sections. Using this system will eliminate the teams reviewing the incorrect draft.

Follow the sample report and draft style guide for (1) formatting; (2) formulating the list of abbreviations, symbols, and references; (3) referring to references within the text; and (4) preparing tables and figures.

Create a 5- to 10-page Executive Summary for the report.

Spell out each abbreviation at its first use in each section or appendix.

Request that authors define unusual terms as they write from which you can formulate a glossary if needed.

Treat each appendix as though it were a standalone document. An appendix may have a table of contents, list of references, and so forth. Often, a third-party appendix published in its entirety will include these elements. Appendices may also contain the team's charter, pc-generated data, or other information.

Use one term consistently for the same object, procedure, or phenomenon throughout, including in the visual material.

Use "licensee," "position title," or "staff" rather than an individual's name.

Write in the active voice whenever possible (e.g., "The licensee recorded events in the log." rather than "Events were recorded in the log by the licensee.")

Usually when information is included in a report, events have already transpired and the past tense works in most constructions (e.g., "The licensee recorded...." rather than "The licensee records....")

Refer to each table or graph before it is inserted in the document and place it as close to its first reference as possible. Use the table feature in WordPerfect so that the tables are Web compatible.

*The editor will often amend a style sheet as team work progresses.

Figure 3.1 Sample Style Sheet



Figure 1.1 An Aerial View of the Millstone Nuclear Power Plant in New London, Connecticut.

Figure 3.2 Sample Photograph

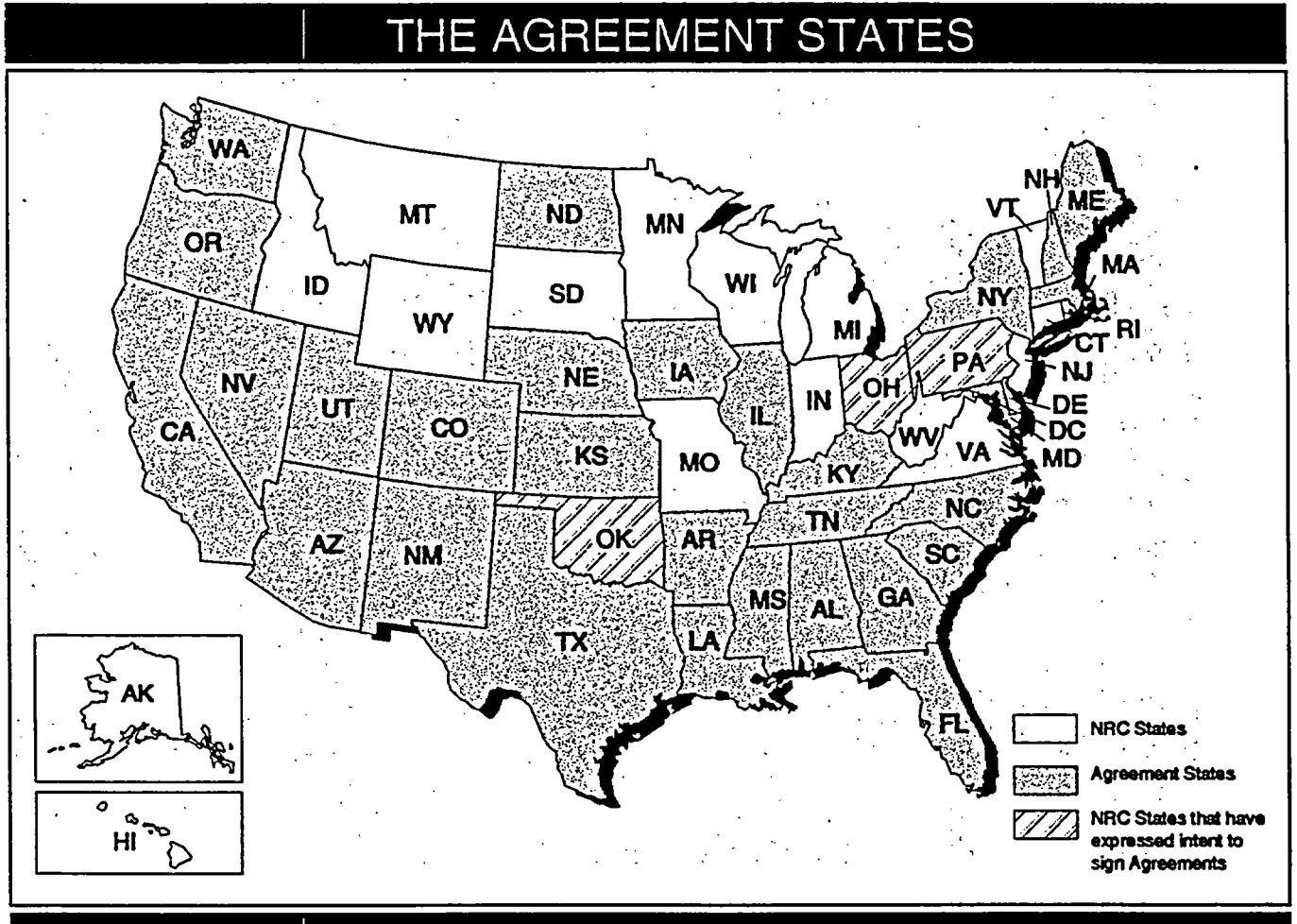

Figure 3.3 Map Showing States That Have Agreements With the NRC

Figure 3.3 Sample Map

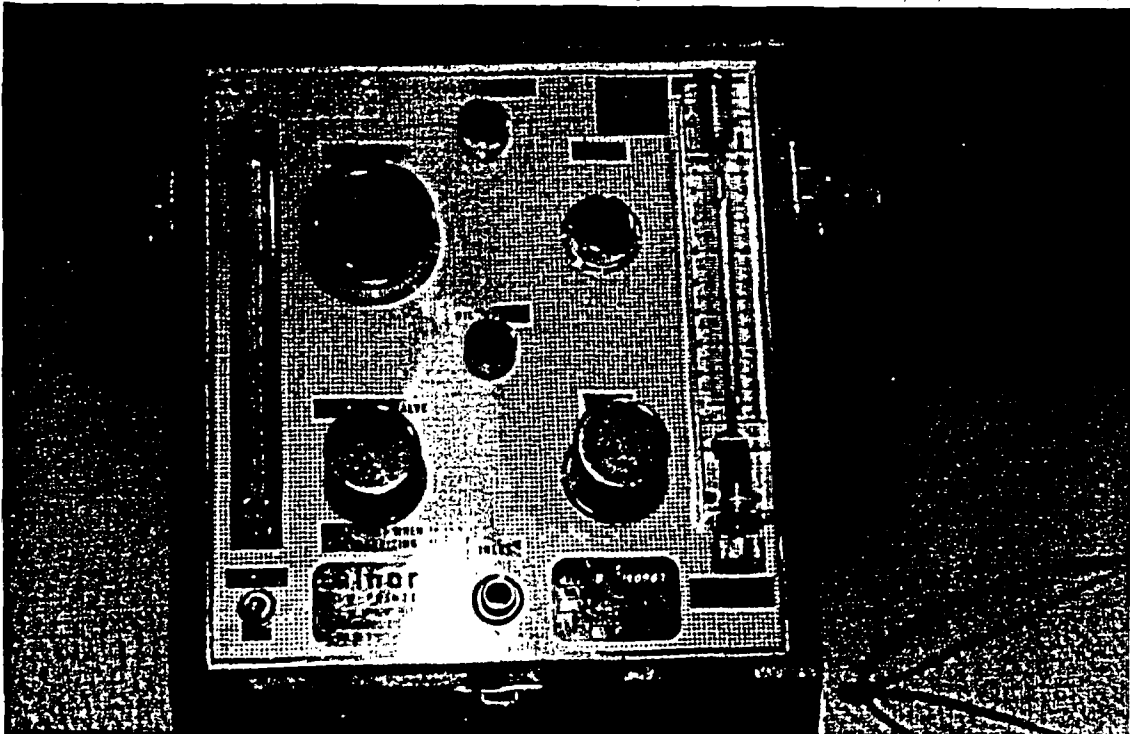
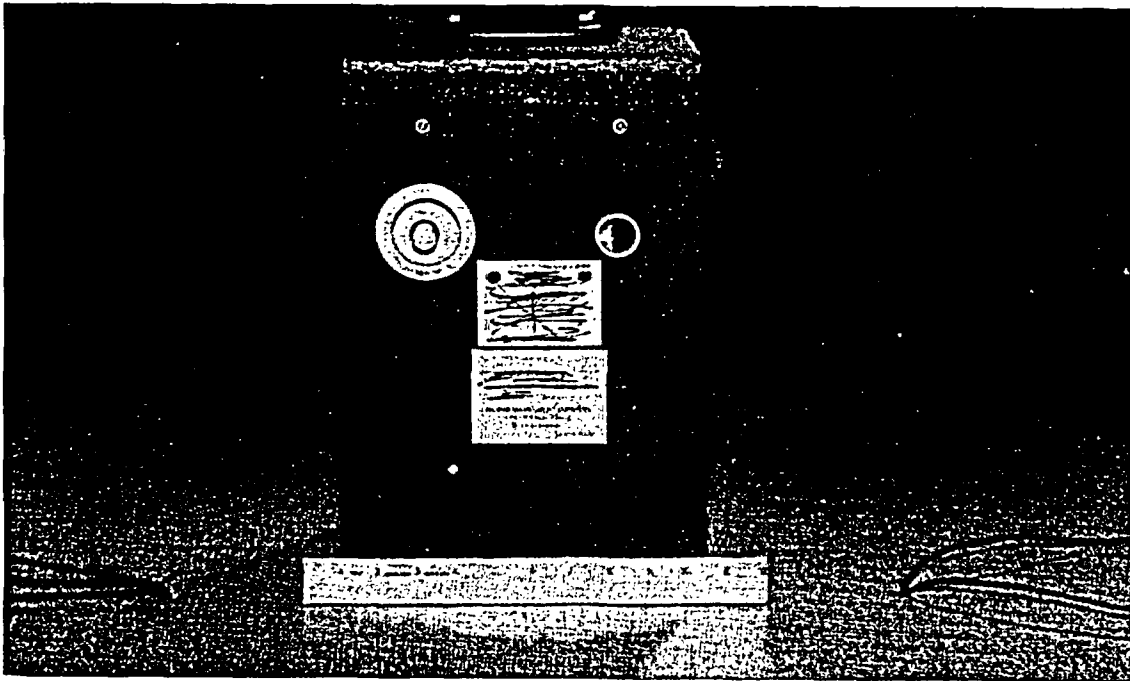

Figure 2.1 The Portable Alnor Dewpointer, Which Measures the Moisture Content in Gases, Is 10-1/4-Inches Wide. The Opened View Shows a Thermometer on the Left and a Flowmeter on the Right.

Figure 3.4 Sample Figure Denoting Size of Object

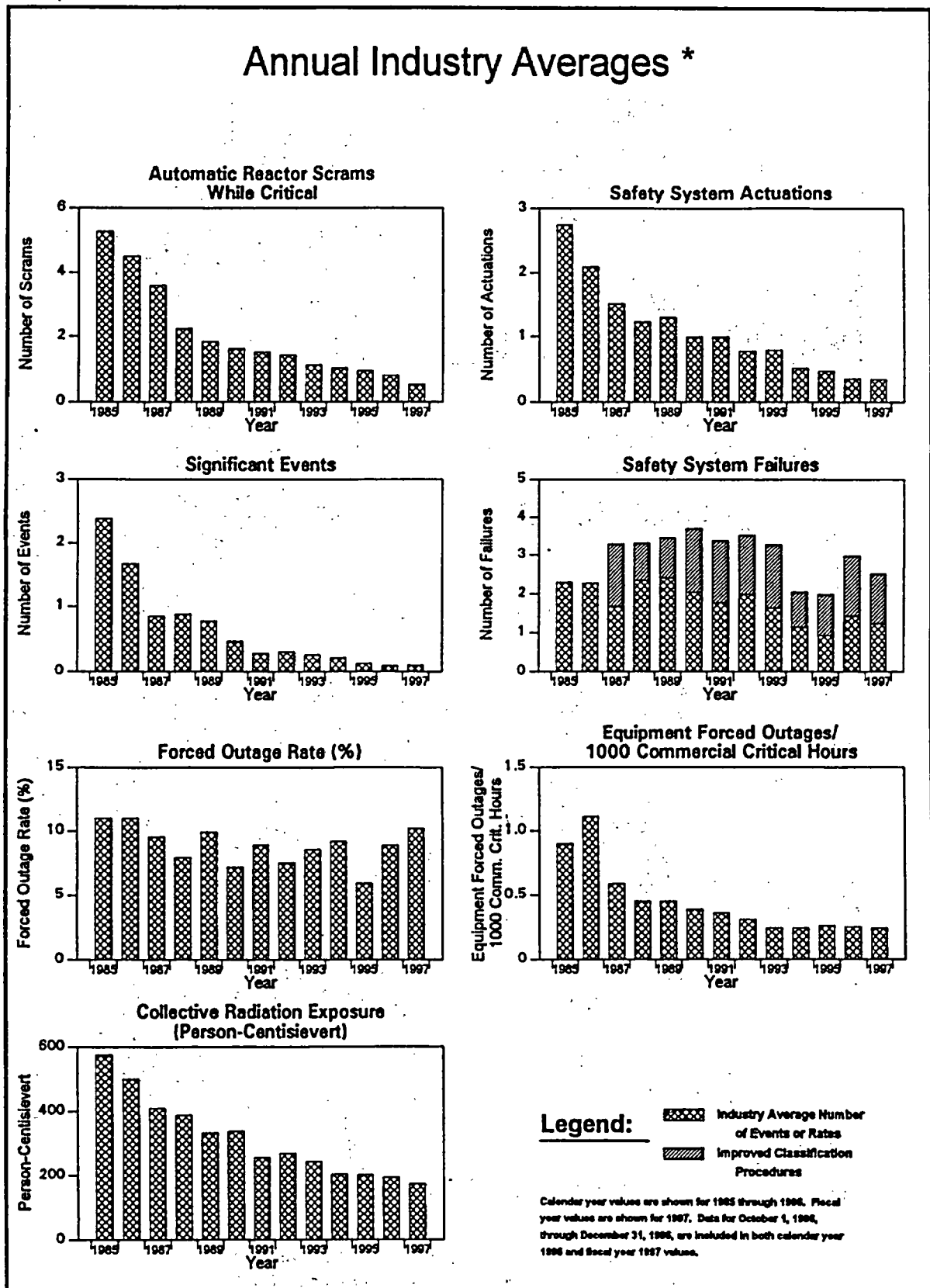

Figure 2.1 Performance Indicators – Annual Industry Averages

Figure 3.5 Sample Figure with Legend

| Table 1. Estimated Emissions from Electric Power Generation (Tons per Gigawatthour) | | | | | |
|--|----------------------------|----------------------------|-------------------------------|---------------------------|---|
| Fuel | Sulphur Dioxide | Nitrogen Oxides | Particulate Matter | Carbon Dioxide | Volatile Organic Compounds |
| Eastern Coal | 1.74 | 2.90 | 0.10 | 1,000 | 0.06 |
| Western Coal | 0.81 | 2.20 | 0.06 | 1,039 | 0.09 |
| Gas | 0.003 | 0.57 | 0.02 | 640 | 0.05 |
| Biomass | 0.06 | 1.25 | 0.11 | 0 ^a | 0.61 |
| Oil | 0.51 | 0.63 | 0.02 | 840 | 0.03 |
| Wind | 0 | 0 | 0 | 0 | 0 |
| Geothermal | 0 | 0 | 0 | 0 | 0 |
| Hydro | 0 | 0 | 0 | 0 | 0 |
| Solar | 0 | 0 | 0 | 0 | 0 |
| Nuclear | 0 | 0 | 0 | 0 | 0 |
| ^a Net emissions. | | | | | |
| Source: Department of Energy | | | | | |

Figure 3.6 Sample Table



UNITED STATES
NUCLEAR REGULATORY COMMISSION
WASHINGTON, D.C. 20555-0001

January xx, xxxx

[Addressee]

Dear _____:

Subject: Request for Permission To Reprint Copyrighted Material

I am preparing a [type of publication] entitled ["title"] for the U.S. Nuclear Regulatory Commission (NRC), which is a Federal agency. Works prepared and published by the U.S. Government are not copyrighted and are in the public domain.

I would like your permission to reproduce the following material that is to be included in a U.S. Nuclear Regulatory Commission publication:

Author: _____

Title and date of publication: _____

Selection or illustration: [first and last words if a quotation; figure or page number if an illustration] _____

Page _____ to page _____

Approximate number of words _____ and pages _____

The NRC will give full credit to the author and publisher. Please indicate any special wording you may require in a source line.

If you are not the copyright holder and I need to obtain permission from another source, will you please identify this source.

A release form is provided for your convenience. The duplicate copy of this request is for your files. Should you have any questions about this request, please call me at [area code-xxx-xxx-xxxx] or e-mail [xxx.nrc.gov].

Sincerely,

Name and Title

_____ For a printed publication _____

[I or We] grant the NRC permission to use the material as stipulated For posting to the WWW _____
for the purposes checked.

_____ Date Signature

_____ Title

Preferred Source Line

Figure 3.7 Sample Copyright Permission Letter

4 GENERAL FORMAT AND CONTENT

In preparing most manuscripts for publication in the NUREG series, adhere to the following format guidelines. However, certain staff- and contractor-prepared manuscripts, such as safety evaluations or standard review plans or environmental impact statements, have unique formats that are dictated by licensing guidelines and NRC regulations. In addition, brochures, conference proceedings, international agreement reports, and books may have unique formats that differ from the format for most other publications. Consult the Publishing Services Branch at e-mail address <pubs> for information about the format for these documents.

Organize generic technical reports, including drafts, using only those elements appropriate to each report. Number the pages of the report consecutively throughout, including appendices. Ensure that each new section, or chapter in the case of a book, begins on an odd-numbered page. If a report includes a preprinted appendix from another source, number each appendix separately, beginning with A-1, A-2, B-1, B-2, as appropriate. Follow the guidance in Table 4.1 at the end of this section.

4.1 Front Matter

The front matter of a printed version of a NUREG-series publication may include the cover, the availability notice, the title page, a list of previous publications in a series, the abstract, the table of contents, the executive summary, the preface or foreword, any acknowledgments, and a list of abbreviations. Some of these components are optional as shown in Table 4.1. If the document is posted to the NRC WWW site, information from the title page

will appear online in the "Publication Information" section, and the cover will not appear.

4.1.1 Cover

The Publishing Services Branch creates, or has designed, the cover for most publications in the NUREG series.

Staff Report: Supply the Publishing Services Branch the following information for the cover: (1) full title; (2) subtitle, if any; (3) type of report (e.g., draft, final, annual, team); (4) sponsoring office; and (5) report number—obtain from the Publishing Services Branch (see Block 1 in Figures 5.3 and 5.5).

Contractor Report: Supply the Publishing Services Branch the following information for the cover: (1) full title; (2) subtitle, if any; (3) type (e.g., draft, final, annual, team); (4) contractor; (5) report number—obtain from the Publishing Services Branch (see Block 1 in Figures 5.3 and 5.5); and (6) secondary contractor report number.

Omission of any of this information will delay publication.

Title of Report: Select a succinct title that is specific to the topic and that suggests the report's scope. Such a title helps a prospective user decide whether the topic is of sufficient interest or importance to read the abstract, executive summary, or the entire report. If the report covers a specific period, such as a month, quarter, or year, include this fact in the title or in a subtitle.

Example:

Enforcement Actions: Significant
Actions Resolved (Title)

Quarterly Report for July–September
1997 (Subtitle)

Do not include in the title—

- the name of an NRC office;
- the word “report” or “technical report,” which is self-evident;
- abbreviations.

Good example:

Response Capabilities of Local Law Enforcement Agencies

Poor example:

Office of Nuclear Reactor Regulation
Technical Report on LLEA Response

4.1.2 Availability Notice

The Publishing Services Branch inserts the appropriate availability notice for each publication. An availability notice lists the publicly available sources of information cited in reference lists and bibliographies in NRC publications. These sources may include the WWW or Internet sources in addition to traditional sources for paper copies.

4.1.3 Title Page

The Publishing Services Branch creates, or has designed, the title page for most publications in the NUREG series.

Staff Report: In addition to the information supplied for the cover, supply the (1) manuscript completion date, (2) desired publication date, and (3) the name of the division authorizing publication of the report.

Contractor Report: In addition to the information supplied for the cover, supply the (1) manuscript completion date; (2) NRC job code number (JCN), and (3) the complete mailing address for the contractor and any subcontractor.

Omission of any of this information will delay publication.

4.1.4 Previous Reports in Series

If the report being prepared is one in a series, list all previous reports in the series on a separate page or several pages, if necessary. Include the complete report designator (volume, number, and revision, if applicable) and the issuance date for each report in the series.

4.1.5 Abstract

The abstract is a concise summary of the report. This summary should be sufficient in scope to enable readers to decide whether to read the full work. Limit the abstract to a single paragraph of 200 or fewer words.

To prepare an abstract—

- Begin with a sentence that states the report’s main thesis; do not merely rephrase the report’s title.
- Summarize several major findings or points.
- To help you limit the length of the abstract—
 - Use the active rather than the passive voice wherever possible (e.g., “The licensee identified three deficiencies,” rather than “Three deficiencies were identified by the licensee.”)
 - Use the passive voice only to emphasize the object or recipient of the action when either is more important than the doer.
- Use the third person: “the staff” or “the author,” rather than “we” or “I.”
- Avoid the use of unfamiliar terms, abbreviations, or symbols. If any are

included, define them the first time they occur.

- Avoid the use of equations and formulas unless the abstract cannot be understood without them.
- Cite any computer code central to the topic of the report. Describe a research technique or data source only to the degree necessary.
- Avoid mentioning tables, figures, or references unless the abstract cannot be understood without them.

4.1.6 Contents

List the title of each section and subsection and the page number on which it begins to the third level of subordination (1., 1.1, 1.1.1). List appendices, figures, and tables as part of the Contents (Figure 4.1).

Ensure that the page numbers and the section titles in the contents match those in the report. In the HTML version, link each title to the appropriate section; page numbers are unnecessary.

4.1.6.1 Figures

If five or more figures appear in the body of the report, list the figure numbers, captions, and page numbers in sequence in the Contents. Fewer than five figures may be listed. Ensure that the figure numbers and captions match those in the report. In an HTML version, link in sequence each figure and title to the appropriate figure; page numbers are unnecessary.

4.1.6.2 Tables

If five or more tables appear in the body of the report, list the table numbers, titles, and page numbers in the Contents. Fewer than five tables may be listed. Ensure that the table numbers and titles match those in the report. In an HTML version, link each

table number to the appropriate table; page numbers are unnecessary.

4.1.7 Executive Summary

An executive summary is optional. This summary is more complete than an abstract. It (1) states the purpose of a report, (2) gives a brief account of the procedures or methodology used, (3) includes a concise overview of the document, and (4) gives major findings, conclusions, and recommendations. This summary is usually 5 to 10 pages, depending on the scope and complexity of the report. Longer summaries tend to defeat the purpose of allowing a reader to glean the crux of the report from the summary and determine whether to peruse certain sections or the entire report.

4.1.8 Preface

The preface is an optional introductory statement, usually written by the author, that announces the purpose, background, and scope of the report. Sometimes the preface specifies the audience for whom the report is intended or highlights the relationship of the report to a given project or program. A preface may also acknowledge assistance received during the project or while preparing the report. If the report does not require a preface, place this type of information, if it is essential, in the introductory section. The author's name may or may not appear at the end of the preface.

4.1.9 Foreword

A foreword is an optional introductory statement written by someone other than the author. The writer of the foreword is usually an authority in the field, whose name and affiliation and the date the statement was written appear at the end of the foreword. The author of the foreword may also be a senior official of the

organization sponsoring or funding the publication. The foreword provides background information about the study's significance or its relationship to other works written in the field.

4.1.10 Acknowledgments

An acknowledgments section, which is optional, gives credit to any persons or groups who assisted in preparing and producing the publication.

4.1.11 Abbreviations

The list of abbreviations in a document includes initialisms and acronyms and may include units of measurement (Figure 4.2). This list usually appears as the last section of the front matter, unless it is followed by a list of symbols, or the list may appear as an appendix. An acronym is a pronounceable term formed from the initial letters of a compound expression (e.g., LOCA for loss-of-coolant accident). An initialism is a nonpronounceable term formed from the initial letters of a compound expression; the initial letters are pronounced as separate letters (e.g., NRC for the Nuclear Regulatory Commission).

4.1.12 Symbols

The list of symbols includes any printed or written sign used to represent an operation, an element, or a quantity, quality, or relation, as in mathematics. This list appears as the last section of the front matter or as an appendix (Figure 4.3).

4.2 Body of the Report

Organize the text of the report so that readers understand the subject and the scope of information it will cover; the details and their relationships; and, finally, any findings, conclusions, and recommendations.

4.2.1 First Section

In the first section, often called the Introduction, indicate in a concise manner the subject and purpose of the report, the scope of information covered, and the methodology used in analyzing the subject. State why the report was written. Define the limitations and boundary conditions explicitly so that the reader is able to ascertain quickly what the report does and does not do. To illustrate, for an inspection report, specify the areas or systems inspected. Describe the contents of each subsequent section and each appendix in no more than one sentence for each.

4.2.2 Subsequent Sections

Include a title and an introductory paragraph for each major section. Indicate in the introductory paragraph the material covered in that section and the relationship of this material to the overall report.

4.2.3 Findings, Conclusions, and Recommendations

Findings provide the bases for conclusions and recommendations. Nothing should appear as a conclusion or a recommendation unless the basis for it was provided elsewhere in the report. Conversely, significant findings in the report are reflected in the conclusions and, where appropriate, are the bases for recommendations.

Distinguish clearly between findings and conclusions, especially in inspection, investigatory, and research reports:

- A *finding* is information obtained during the inspection, investigation, or research. For example, a piece of equipment failed; its failure caused the loss of a system; plant operators did not respond quickly to the system failure; procedure manuals do not

address this specific sequence of events.

- A *conclusion* is a judgment based on the significance or implications of a finding. For example, plausible conclusions that follow from the foregoing findings are that the equipment failed because of poor maintenance, that the maintenance program has weaknesses, and that operators were not properly trained to respond to the sequence of events that occurred.
- A *recommendation* suggests a course of action on the basis of one conclusion or a set of conclusions. For example, the maintenance program should be improved, the procedures should be revised, and operators should be trained in the new procedures.

4.2.4 References

A list of references gives each source of information used to prepare the publication that is identified in the text (compare with Section 4.3.1). A number of systems for reference style are available. To name a few, acceptable style guides are published by the University of Chicago, Modern Language Association of America, American Institute of Physics, American Psychological Association, and the American Mathematical Society. Although a variety of styles is available, NRC has adapted a style similar to that of the American Psychological Association's *Publication Manual*. Using the adapted style, list the references in one of two ways as illustrated in Figures 4.4 and 4.5:

1. alphabetically by author and corporate author or
2. numerically in the sequence they are referred to in the text.

Select one way, and use it consistently throughout a single document or a collection of related documents.

4.2.4.1 Generic Information for Reference Citations

Each reference must include sufficient information for the reader to find it, as follows:

- *author*: individual, agency, corporation, or association;
- *title*: italicize the title of a book; place the title of a journal article or the chapter of a book in quotation marks; place the title of a journal article before the italicized name of a journal; and enclose in quotation marks the title of a technical report, such as a NUREG-series report, a regulatory guide, an industry code, or an industry standard;
- *volume*, if needed, or *report number*;
- *publisher* and *location*; and
- *date*.

Basically, the elements of each reference citation are arranged as follows:

(1) author; three or fewer authors are listed by last name and two initials, if available; and, if the work has more than three authors, follow the first author with *et al.*; (2) titles, using initial capital letters for principal words; (3) location of the publisher; (4) publisher; (5) in the case of a journal article, volume and page numbers, or in the case of a report, its number; and (6) date. Items (3) and (4) are separated by a colon; all other items are separated by periods.

Each reference listed in an NRC publication must be publicly available. Do not include documents from the Institute of Nuclear Power Operations (INPO) as a

reference or discuss INPO documents in the publication without INPO's express permission.

4.2.4.2. Reference Citations for Electronic Information

A number of styles for citing electronic information and verifying the information's source are available online and in hardcopy. One useful guide is *Electronic styles: A Handbook for citing electronic information* (1996), by Information Today, Inc. <<http://www.uvm.edu/~ncrane/estyles/>>.

For citing a document at a WWW site, use the following format:

- author's name (if known)
- title of document in quotation marks
- title of complete work (if applicable), in italics
- date of publication or last revision (if known)
- uniform resource locator (URL), in angle brackets
- date of access, in parentheses

Example:

U.S. Nuclear Regulatory Commission, "United States Nuclear Regulatory Commission 1997 Information Digest." 1997. <<http://www.nrc.gov/NUREG/SR1350/V9/index.html>> (18 February 1998).

For citing an E-mail Message, use the following format:

- author's name (if known)
- author's e-mail address, in angle brackets

- subject line from posting, in quotation marks
- date of transmission
- type of communication (personal e-mail; distribution list, including listserv; office communication)
- date of access, in parentheses

Example:

Malliakos, Asimios. <ACM1@nrc.gov> "NUREG/IA-0010-Reply" 7 January 1998. [office communication]. (9 January 1998).

4.2.4.3 Identifying References in Text

4.2.4.3.1 Printed Documents

- If listing references numerically, identify them in text in one of the following ways:
 - Capitalize and spell out the word reference if it is part of a sentence:

"As indicated in Reference 1, each organization develops its own identity, often unrecognized."
 - For a single reference, place in parentheses at the end of the statement the abbreviation for the word reference and the reference number:

"Organizations change their identity over time (Ref. 1)."
 - For multiple references, place in parentheses at the end of the statement the abbreviation for the word references and the reference numbers:

"To identify your type of organization, consult the guidance in one of the NRC-endorsed standards (Refs. 1, 3, and 6)."

- If listing references by author, use this format:

“Members of an organization are usually not conscious of its identity (Diamond, 1987).”

- If listing several references by one author, identify them first by date, and then by date and lowercase letter if the date would not distinguish one reference from another:

“Is it helpful for executives to recognize their organization’s identity (Diamond, 1987)”

“Most human resource organizations agree that an executive should know the organization’s identity (Diamond, 1987, 1988a, 1988b).”

- If listing references by organization, use this format:

“Performance of deep soil foundations under seismic loading is described in ASCE Geotechnical Special Publication 51.”

4.2.4.3.2 Electronic Documents

Identify electronic sources in text much as you would printed sources, referring to the author or title of the source followed by the year.

- To introduce a brief quotation or paraphrase or summarize material, use either a signal phrase set off by a comma or a signal verb with a “that...” clause.

Examples:

According to the U. S. Nuclear Regulatory Commission (NRC, 1997), 110 commercial nuclear power reactors

were licensed to operate in 32 States in 1996.

NRC (1997) stated that it assesses approximately 1700 reports of reactor events a year.

Documents posted to the WWW are not paginated; therefore, to reference a particular section of an electronic document, substitute the name of a section of text for the page number you would generally include for a printed document.

Example:

The Radioactive Waste Section (1997) states that NRC classifies low-level waste on the basis of its potential hazards as Class A, B, or C, Class A containing the lowest concentrations of radioactive material.

4.3 Back Matter

For NRC publications, back matter may include a bibliography, a list of references, a glossary, one or more appendices, and a subject index.

4.3.1 Bibliography

A bibliography is a list of publications and other materials (e.g., WWW source, unpublished theses) used by the author to prepare a report. It differs from a reference list in that it lists all research sources used to prepare the document, including those specifically identified in the text and included in the list of references. In other words, a bibliography is a supplement to a list of references (see Section 4.2.4). As with entries in the list of References, separate the location of the publisher and the publisher with a colon and all other items by a period (Figure 4.6).

4.3.2 Glossary

A glossary defines terms that may be unfamiliar to the intended audience.

Arrange the terms alphabetically, beginning each new entry and its definition on a new line (Figure 4.7).

4.3.3 Appendix

An appendix includes information that is supplemental to the publication, such as—

- explanatory or supportive information not essential to the text,
- long charts, tables, or computer printouts,
- a chronology,
- a bibliography,
- a glossary,
- a list of references,
- a list of abbreviations, or
- a list of symbols.

Identify each appendix with a heading and title (e.g., Appendix A, "Burial Site Price Schedules for the Current Year"). A single appendix is not assigned a letter or number while each appendix in a report having more than one appendix receives a designator such as Appendix A, Appendix B or Appendix 1, Appendix 2, and so forth. Ensure that references in the text to Appendix A come before references to Appendix B, and so forth. Provide a table of contents for a lengthy appendix. Treat each appendix as a stand-alone document, making it clear and complete. Prepare a list of abbreviations, symbols, or references, as appropriate.

4.3.4 Index

An index lists all pertinent topics discussed in the publication in alphabetical order and cites the page number where each topic can be found within the text. The index is always the last section of a report. Divide the index entries into headings that specify

particular subjects discussed within the text and give their page references. A complete entry consists of the principal entry, subentries, and cross-references, if any. Place each entry on a separate line as indicated in the following example:

Principal entry:

Monitoring programs, 27–49

Subentries:

aquatic, 42
ecological, 40–49
meteorological, 37
radiological, 30
terrestrial, 41, 43–44
thermal, 27

Cross-reference:

See also Programs

Cross-references in the index are devices inserted at appropriate places to guide the reader to the complete information in the text. They consist of two general kinds: "See" references and "See also" references. Use "See" references—

- when the indexer has chosen among several key words:
 - Economic costs
 - See Benefit-cost analysis
- when the subject has been treated as a subentry to a principal entry:
 - Radiological impacts
 - See Environmental effects of station operation, radiological impacts
- when the reference represents a popular or shortened form of a term, not the official, scientific, or full form:
 - China syndrome
 - See Reactor core meltdown

Use "See also" references when additional information can be found in another entry or subentry:

- Ecological programs, 40-49
- See also Monitoring programs

CONTENTS

| | Page |
|----------------------------------|-------------|
| Abstract | iii |
| Executive Summary | vii |
| Abbreviations | ix |
| 1 Objectives | 1 |
| 2 Relay Selection Basis | 3 |
| 3 Experimental Arrangement | 7 |
| 3.1 Relay Aging Procedures | 7 |
| 3.2 Relay Fire Testing | 9 |
| 4 Experimental Results | 11 |
| 5 Conclusions | 19 |
| 6 References | 21 |

Appendices

| | |
|--|----|
| A Temperature Exposure Plots for All Relays Tested. | 23 |
| B Glossary | 35 |

Figures

| | |
|--|----|
| 1 Schematic of a Typical Armature Style Relay | 4 |
| 2 Measurement Schematic for Each Contact Pair | 7 |
| 3 Severe Combined Environments Test Chamber | 12 |
| 4 Temperature Exposure Profiles | 15 |
| 5 Relay with Contact Stuck by Melted Contact Carrier | 20 |

Tables

| | |
|--|----|
| 1 Relay Identification Scheme | 5 |
| 2 Overall Relay Test Results | 10 |
| 3 Temperatures Used With Each Experiment | 11 |
| 4 Types of Test Chambers | 18 |
| 5 Types of Contact Pairs | 19 |

Figure 4.1 Sample Contents

ABBREVIATIONS

| | |
|-------|--|
| AI | Automated Industries |
| BNL | Brookhaven National Laboratory |
| CAL | Confirmatory Action Letter |
| CFR | Code of Federal Regulations |
| DOT | Department of Transportation (U.S.) |
| DU | depleted uranium |
| HMR | Hazardous Materials Regulation |
| HMTA | Hazardous Materials Transportation Act |
| IAEA | International Atomic Energy Agency |
| IATA | International Air Transportation Association |
| ICAO | International Civil Aviation Organization |
| IN | information notice |
| KINS | Korean Institute of Nuclear Safety |
| KIT | Korean Industrial Testing Company |
| LCO | limiting condition for operation |
| LOOP | loss of offsite power |
| LP | low pressure |
| MOST | Ministry of Science and Technology (Korea) |
| MOU | Memorandum of Understanding |
| NRC | Nuclear Regulatory Commission (U.S.) |
| NVOCC | non-vessel operating common carrier |
| ORAU | Oak Ridge Associated Universities |
| PPQ | plant protection quarantine |
| PST | Pacific Standard Time |
| RSO | Radiation Safety Officer |
| SG | steam generator |
| SI | safety injection |
| UN | United Nations |
| USCG | Coast Guard (U.S.) |
| USDA | Department of Agriculture (U.S.) |
| WCG | West Coast Group |

Figure 4.2 Sample List of Abbreviations

SYMBOLS









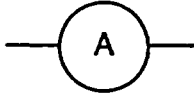
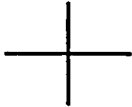
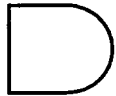
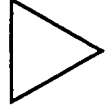
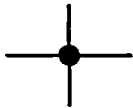
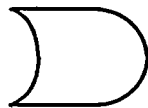
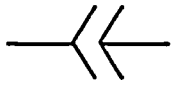

| | | | |
|-----------------|---|-----------------------|---|
| Anmeter |  | No connection |  |
| AND gate |  | Operational amplifier |  |
| Connection |  | OR gate |  |
| Connector |  | Oscilloscope |  |
| Current source |  | Resistor |  |
| DC Power supply |  | Sine-wave generator |  |
| Ground |  | Square-wave generator |  |
| Inductor |  | Variable resistor |  |

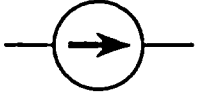
Figure 4.3 Sample List of Symbols

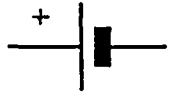
SAMPLE REFERENCES

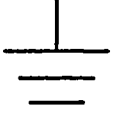
- Statute** *Administrative Procedure Act*, Sec. 6, 5 U.S.C. Sec. 555 (1982), 22 U.S.C. Sec. 2567 (Supp. 1, 1983).
- Book: three authors** Alekseenko, S. V., V.E. Nakoryakov, and B. G. Pokusaev. Institute of Thermophysics, Russian Academy of Sciences, Novosibirsk. *Wave Flow of Liquid Films*. Fukuoka, Japan: Begell House. 1994.
- Reports: corporate author** American Society of Civil Engineers (ASCE). "Analyses for Soil-Structure Interaction Effects for Nuclear Power Plants." Ad Hoc Group on Soil Interaction of the Committee on Nuclear Structures and Materials of the Structural Division. ASCE: New York. 1979.
- "Performance of Deep Foundations Under Seismic Loading." Geotechnical Special Publication 51. Proceeding of sessions sponsored by the Deep Foundations and Soil Properties Committees of the Geotechnical Engineering Division. ASCE: New York. 1995.
- "Seismic and Dynamic Analysis and Design Considerations for High Level Nuclear Waste Repositories." Subcommittee on Dynamic Analysis and Design of High Level Nuclear Waste Repositories of the Technical Activities Division of the Structural Engineering Institute. ASCE: New York. 1997.
- Book: one author** Bradley, D. J. *Behind the Nuclear Curtain: Radioactive Waste in the Former Soviet Union*. Richland, Washington: Battelle Press. 1997.
- Newspaper article** Broad, W. J. "New Work Proposed for Shuttles: Salvage in Space." *New York Times* (national edition), pp. B9, B14. September 16, 1997.
- Federal regulation** Code of Federal Regulations, *Title 10, Energy, Part 72*, "Licensing Requirements for the Independent Storage of Spent Nuclear Fuel and High-Level Radioactive Waste."
- Book: committee author** Committee on Innovative Remediation Technologies, National Research Council. *Innovations in Ground Water and Soil Cleanup*. Washington, D.C.: National Academy Press. 1997.
- Journal article** King, N. "E-Mail Reinvents Itself." *Internet World*. Vol. 8, No. 11: November 1997.
- Book: two authors** Lutes, L. D. and S. Sarkani. *Stochastic Analysis of Structural and Mechanical Vibrations*. Prentice Hall: Upper Saddle River, New Jersey. 1997.
- E-mail message** Malliakos, Asimios. <ACM1@nrc.gov> "NUREG/IA-0010-Reply" 7 January 1998. (9 January 1998).

Figure 4.4 Sample List of References: Listed Alphabetically by Author or Corporate Author

SAMPLE REFERENCES (continued)

- Federal Register notice** Nuclear Regulatory Commission (U.S.), Washington, D.C. "Electronic Freedom of Information Act: Implementation." *Federal Register*. Vol. 63, No. 12. pp. 2873–2883. January 20, 1998.
- Information: WWW** Nuclear Regulatory Commission (U.S.), "United States Nuclear Regulatory Commission 1997 Information Digest." 1997. <<http://www.nrc.gov/NUREG/SR1350/V9/index.html>> (18 February 1998).
- Reports: Federal Agency** Nuclear Regulatory Commission (U.S.) (NRC). NUREG–1568, "License Renewal Demonstration Program: NRC Observations and Lessons Learned." NRC: Washington, D.C. December 1996.
- NUREG–1612, "Status Report: Reactor Vessel Integrity Database." NRC: Washington, D.C. July 1997.
- NUREG/CR–6451, "A Safety and Regulatory Assessment of Generic BWR and PWR Permanently Shutdown Nuclear Power Plants." NRC: Washington, D.C. August 1997.
- Report: foreign organization** Organisation for Economic Co-operation and Development. "PSA Based Plant Modifications and Backfits." OCDE/GD(97)130. OECD: Paris, France. 1997.
- Conference proceedings** Proceedings of an International Conference on Radiation and Society. "Radiation and Society: Comprehending Radiation Risk." International Atomic Energy Agency (IAEA), Paris 24–28 October 1994. IAEA: Vienna, Austria. 1997.
- Team report** Information Infrastructure Task Force: Intellectual Property and the National Information Infrastructure, The Report of the Working Group on Intellectual Property Rights. "Managing Rights in Protected Works." U.S. Patent and Trademark Office: Washington, D.C. September 1995.
- Public Law Statutes at Large** Chief Financial Officers Act of 1990, Pub. L. 101–576, 104 Stat. 2838 (1990).

**Figure 4.4 Sample List of References: Listed Alphabetically
by Author or Corporate Author**

SAMPLE REFERENCES

1. Diamond, M. A. *The Unconscious Life of Organizations, Interpreting Organizational Identity*. Quorum Books: Westport, Connecticut. 1993.
2. Lutes, L. D. and S. Sarkani. *Stochastic Analysis of Structural and Mechanical Vibrations*. Prentice Hall: Upper Saddle River, New Jersey. 1997.
3. Proceedings of an International Conference on Radiation and Society. "Radiation and Society: Comprehending Radiation Risk," International Atomic Energy Agency (IAEA), Paris 24–28 October 1994. IAEA: Vienna, Austria. 1997.
4. Turner, D. B. *Workbook of Atmospheric Dispersion Estimates: An Introduction to Dispersion Modeling, Second Edition with Floppy Diskette*. Lewis Publishers: Ann Arbor, Michigan. 1997.
5. King, N. "E-Mail Reinvents Itself," *Internet World*, Vol.8, No.11. November 1997.
6. Halmshaw, R. *Introduction to the Non-Destructive Testing of Welded Joints, Second Edition*. Abington Publishing: Cambridge, England. 1996.
7. Terzaghi, K., R. B. Peck, and G. Mesri. *Soil Mechanics in Engineering Practice, Third Edition*. John Wiley & Sons, Inc.: New York. 1996.
8. Alekseenko, S. V., V. E. Nakoryakov, and B. G. Pokusaev. Institute of Thermophysics, Russian Academy of Sciences, Novosibirsk. *Wave Flow of Liquid Films*. Begell House: Fukuoka, Japan. 1994.
9. Bradley, D. J. *Behind the Nuclear Curtain: Radioactive Waste Management in the Former Soviet Union*. Battelle Press: Richland, Washington. 1997.
10. *Administrative Procedure Act*, Sec. 6, 5 U.S.C. Sec. 555 (1982), 22 U.S. C. Sec. 2567 (Supp. 1, 1983).
11. Reagan, S. B., et al. *Writing from A to Z: The Easy-to-Use Reference Handbook*. Mayfield Publishing Company: Mountain View, California. 1994.
12. Alred, G. J., W. E. Oliu, and C. T. Brusaw. *The Professional Writer, A Guide for Advanced Technical Writing*. St. Martin's Press: New York. 1992.

**Figure 4.5 Sample List of References: Listed Numerically
as Referred to in Text**

BIBLIOGRAPHY

- Book: three or fewer authors** Alred, G. J., W. E. Oliu, and C. T. Brusaw. *The Professional Writer, A Guide for Advanced Technical Writing*. St. Martin's Press: New York. 1992. pp. 330–336.
- Translation** Daudel, R. *The realm of molecules* McGraw Hill: New York. 1993. (N. Harmann, Transl.). McGraw Hill: New York. 1993
- Public Law: Statutes at Large** Government Performance and Results Act, Pub. L. 103–62, 107 Stat. 285 (1993).
- Team report** Information Infrastructure Task Force: Intellectual Property and the National Information Infrastructure, The Report of the Working Group on Intellectual Property Rights. "Managing Rights in Protected Works." U.S. Patent and Trademark Office: Washington, D.C. pp. 191–194. September 1995.
- Journal article** King, N. "E-Mail Reinvents Itself." *Internet World*, Vol. 8, No. 11: pp. 80–95. November 1997.
- Directory: corporate author** Lockheed Martin Corporation. *1996 Directory of Public Information Contacts*. Bethesda, Maryland. 1995
- Federal Register notice** Nuclear Regulatory Commission (U.S.), Washington, D.C. "Electronic Freedom of Information Act: Implementation." *Federal Register*, Vol. 63, No. 12: pp. 2873–2883. January 20, 1998.
- Regulatory brochure** Nuclear Regulatory Commission (U.S.), Washington, D.C. "Instructions for Completing NRC's Uniform Low-Level Radioactive Waste Manifest" (NUREG/BR–0204, Rev. 1).
- Dictionary: single author** Pfaffenberger, Bryan, Ph.D. *QUE's Computer and Internet Dictionary*, 6h Edition. Que Corporation: Indianapolis, Indiana. 1995
- Conference proceedings** Proceedings of an International Conference on Radiation and Society; "Radiation and Society: Comprehending Radiation Risk." International Atomic Energy Agency: Paris; 24–28 Sec. 3. October 1994.
- Book: More than three authors** Reagan, S. B., et al. *Writing from A to Z: The Easy-to-Use Reference Handbook*. Mayfield Publishing Company: Mountain View, California. 1994.

Figure 4.6 Sample Bibliography

GLOSSARY

Activity: a measure of the strength of a radioactive source, measured in units of curies.

Attenuation: reduction of radiation intensity as it passes through any material, for example, lead shielding.

Background radiation: radiation emitted from naturally occurring radioactive materials in the earth or from cosmic rays.

Breeder: A reactor that produces more nuclear fuel than it consumes. A fertile material, such as uranium-238, when bombarded by neutrons, is transformed into a fissile material, such as plutonium-239, which can be used as fuel.

Byproduct material: radioactive material obtained as a byproduct from nuclear reactors.

Critical mass: The smallest mass of fissionable material that will support a self-sustaining chain reaction.

Cytogenic evaluation: the study of blood cells to determine chromosomal aberrations induced by radiation exposure.

Decommission: The process of closing down a facility followed by reducing residual radioactivity to a level that permits the release of the property for unrestricted use (see 10 CFR 20.1003).

Geiger-Mueller counter: a gas-filled radiation-detection device that is highly sensitive.

Gray: the International System unit of absorbed dose. One gray is equal to an absorbed dose of one Joule per kilogram (100 rads) (Gy).

Hot Cell: a shielded box or enclosure for sorting, processing, manufacturing or testing radioactive materials that must be handled remotely.

Isotope: One of two or more atoms with the same number of protons but different numbers of neutrons in their nuclei. Thus, carbon-12, carbon-13, and carbon-14 are isotopes of the element carbon, the numbers denoting the approximate atomic weights. Isotopes have very nearly the same chemical properties but often different physical properties (for example, carbon-12 and -13 are stable; carbon-14 is radioactive).

Labelling: a procedure in which one or more radioactive atoms are attached to a molecule or compound in order to follow the compound or its fragments through physical, chemical, or biological processes by observing the radioactivity.

Liquid scintillation counting: the detection of light emissions resulting from the decay of radioactive material immersed in a special chemical mixture.

Time and motion study: an evaluation of the proximity and duration that an individual was near a source of radiation for the purposes of estimating radiation exposure.

Figure 4.7 Sample Glossary

| Table 4.1 Organization and Pagination for a NUREG-Series Report | | |
|--|---|---|
| Element | Page number (Printed Version) | Starts on right- or left-hand page (Printed Version) |
| Cover | None (prepared by NRC) | Right |
| Availability Notice | None (inserted by NRC) | Left |
| Title Page | None (prepared by NRC) | Right |
| Previous Reports in Series | None (optional ii) | Left |
| Abstract | iii | Right |
| Contents | v | Right |
| Figures | Number consecutively as part of contents | |
| Tables | Number consecutively as part of contents | |
| Appendices | Number consecutively as part of contents | |
| Executive Summary (optional) | Small Roman (odd) | Right |
| Preface (optional) | Small Roman (odd) | Right |
| Foreword (optional) | Small Roman (odd) | Right |
| Acknowledgments (optional) | Small Roman (odd or even) | Right or left |
| Abbreviations (optional) | Small Roman (odd) | Right |
| Symbols (optional) | Small Roman (odd) | Right |
| Text (first section of text) | Arabic 1 Continue consecutive numbering with Arabic numerals. | Right Begin each section on new right-hand page. |
| References | Continue consecutive numbering with Arabic numerals. | Right |
| Bibliography (optional) | Continue consecutive numbering with Arabic numerals. | Right |
| Index (optional) | Continue consecutive numbering with Arabic numerals unless intervening appendices are numbered independently. In this case, number consecutively, beginning with I-1. | Right |

5 PUBLISHING FORMS

The forms described in this section are available electronically on the NRC *Inform*s system. The Publishing Services Branch will send contractors appropriate forms upon request (Figures 5.1 through 5.6). Complete and submit them with camera-ready copy to the Publishing Services Branch to authorize publication of a NUREG-series document. These forms are self-explanatory. Complete an NRC Form 335 for all publications prepared by the staff or by contractors except that you need only complete this form for a brochure that will be available to the public. Some brochures are intended only for internal NRC use.

Staff-Prepared NUREG-Series Publication

- NRC Form 426, "Authorization To

Publish a NUREG-Series Document Prepared by the NRC Staff"

- NRC Form 335, "Bibliographic Data Sheet"

Contractor-Prepared NUREG-Series Publication

- NRC Form 426A, "Authorization To Publish a NUREG-Series Document Prepared by a Contractor for the NRC Staff"
- NRC Form 335, "Bibliographic Data Sheet"

For assistance in determining appropriate NRC-established mailing lists to enter on NRC Form 426 or 426A, call the Publishing Services Branch.

| | | |
|---|-------------------------------------|--|
| NRC FORM 335 (2-89) NRCM 1102, 3201, 3202 | U.S. NUCLEAR REGULATORY COMMISSION | 1. REPORT NUMBER (Assigned by NRC, Add Vol., Supp., Rev., and Addendum Numbers, if any.) |
| BIBLIOGRAPHIC DATA SHEET | | |
| (See instructions on the reverse) | | |
| 2. TITLE AND SUBTITLE | 3. DATE REPORT PUBLISHED | |
| | MONTH YEAR | |
| | 4. FIN OR GRANT NUMBER | |
| 5. AUTHOR(S) | 6. TYPE OF REPORT | |
| | 7. PERIOD COVERED (Inclusive Dates) | |
| 8. PERFORMING ORGANIZATION – NAME AND ADDRESS (If NRC, provide Division, Office or Region, U.S. Nuclear Regulatory Commission, and mailing address; if contractor, provide name and mailing address.) | | |
| 9. SPONSORING ORGANIZATION – NAME AND ADDRESS (If NRC, type "Same as above"; if contractor, provide NRC Division, Office or Region, U.S. Nuclear Regulatory Commission, and mailing address.) | | |
| 10. SUPPLEMENTARY NOTES | | |
| 11. ABSTRACT (200 words or less) | | |
| 12. KEY WORDS/DESCRIPTORS (List words or phrases that will assist researchers in locating the report.) | 13. AVAILABILITY STATEMENT | |
| | 14. SECURITY CLASSIFICATION | |
| | (This Page) | |
| | (This Report) | |
| 15. NUMBER OF PAGES | | |
| 16. PRICE | | |

NRC FORM 335 (2-89)

Figure 5.1 NRC Form 335, "Bibliographic Data Sheet"

| | | | | | | |
|--|---|---|-------|------|---------|------|
| <p>NRC FORM 335 (2-89) NRCM 1102, 3201, 3202</p> | <p>U.S. NUCLEAR REGULATORY COMMISSION</p> | <p>1. REPORT NUMBER (Assigned by NRC, Add Vol., Supp., Rev., and Addendum Numbers, if any.)</p> | | | | |
| <p>BIBLIOGRAPHIC DATA SHEET (See instructions on the reverse)</p> | | <p>NUREG/CR-6511, Vol. 4 ANL-98/15</p> | | | | |
| <p>2. TITLE AND SUBTITLE</p> <p>Steam Generator Tube Integrity Program</p> <p>Annual Report October 1996 - September 1997</p> | | <p>3. DATE REPORT PUBLISHED</p> <table border="1"> <tr> <td>MONTH</td> <td>YEAR</td> </tr> <tr> <td>January</td> <td>1999</td> </tr> </table> | MONTH | YEAR | January | 1999 |
| MONTH | YEAR | | | | | |
| January | 1999 | | | | | |
| <p>5. AUTHOR(S)</p> <p>D.R. Diercks, S. Bakhtiari, K.E. Kasza, D.S. Kupperman, S. Majumdar, J.Y. Park, W.J. Shack</p> | | <p>4. FIN OR GRANT NUMBER</p> <p>W6487</p> | | | | |
| <p>8. PERFORMING ORGANIZATION - NAME AND ADDRESS (If NRC, provide Division, Office or Region, U.S. Nuclear Regulatory Commission, and mailing address; if contractor, provide name and mailing address.)</p> <p>Argonne National Laboratory 9700 South Cass Avenue Argonne, IL 60439</p> | | <p>6. TYPE OF REPORT</p> <p>Technical; Annual</p> | | | | |
| <p>9. SPONSORING ORGANIZATION - NAME AND ADDRESS (If NRC, type "Same as above"; if contractor, provide NRC Division, Office or Region, U.S. Nuclear Regulatory Commission, and mailing address.)</p> <p>Division of Engineering Technology Office of Nuclear Regulatory Research U.S. Nuclear Regulatory Commission Washington, DC 20555-0001</p> | | <p>7. PERIOD COVERED (Inclusive Dates)</p> <p>Oct. 1996 - Sept. 1997</p> | | | | |
| <p>10. SUPPLEMENTARY NOTES</p> <p>J. Muscara, NRC Project Manager</p> | | | | | | |
| <p>11. ABSTRACT (200 words or less)</p> <p>This report summarizes work performed by Argonne National Laboratory on the Steam Generator Tube Integrity Program during the period October 1996 through September 1997. The program is divided into five tasks: (1) assessment of Inspection Reliability, (2) Research on ISI (in-service-inspection) Technology, (3) Research on Degradation Modes and Integrity, (4) Tube Removals from Steam Generators, and (5) Program Management. Under Task 1, progress is reported on the assembly of a steam generator tube mockup for round-robin studies and on the evaluation of NDE techniques for characterizing the tubes going into the mockup. Inspection data from the Duke Power Company's McGuire Nuclear Station were evaluated to optimize the selection of tube samples for removal from two retired steam generators. Under Task 2, results are reported on the application of signal processing, visualization, and data analysis schemes to improve the NDE of service-degraded tubing. Results are also presented on implementation of multivariate linear and nonlinear models to study potential correlations between eddy current measurements and flaw size and tube failure pressure. In Task 3, a model boiler multitube corrosion cracking facility has been designed to simulate steam generator thermal-hydraulic and chemistry conditions for the tube/crevice chemistry. A Pressure and Leak-Rate Test Facility is being built to determine failure pressures and leak rates for flawed tubing under normal operating and design-basis accident conditions. An autoclave system and a room-temperature cracking facility are being used to produce cracked specimens for pressure and leak-rate tests and NDE studies. The results of 15 severe-accident pressure tests on Alloy 600 tubing with machined circumferential part-throughwall flaws are also reported. Under Task 4, the selection and removal of service degraded tubes, tube sheet samples, and tube support plate samples from the McGuire Nuclear Station are described.</p> | | | | | | |
| <p>12. KEY WORDS/DESCRIPTORS (List words or phrases that will assist researchers in locating the report.)</p> <p>Steam Generator Tubes Stress Corrosion Cracking Eddy Current Testing Nondestructive Evaluation In-service Inspection Pressure Testing Tube Burst Leak Rate Alloy 600, Inconel 600</p> | | <p>13. AVAILABILITY STATEMENT</p> <p>Unlimited</p> <p>14. SECURITY CLASSIFICATION</p> <p>(This Page) Unclassified</p> <p>(This Report) Unclassified</p> <p>15. NUMBER OF PAGES</p> <p>16. PRICE</p> | | | | |

Figure 5.2 Sample Completed NRC Form 335

| | | | | | | |
|--|------------------|---|--|---|--|--|
| NRC FORM 426 (1-1999) | | U.S. NUCLEAR REGULATORY COMMISSION | | 1. REPORT NUMBER – Obtain number from the Technical Publications Section, Telephone: 301-415-7174, or E-mail address: jfb1@nrc.gov | | |
| AUTHORIZATION TO PUBLISH A NUREG-SERIES DOCUMENT PREPARED BY THE NRC STAFF | | | | | | |
| 2. TITLE AND SUBTITLE (State in full, using capital letters as they should appear on the report.) | | | | TYPE OF DOCUMENT <input type="checkbox"/> REPORT <input type="checkbox"/> BROCHURE <input type="checkbox"/> BOOK <input type="checkbox"/> CONFERENCE PROCEEDINGS <input type="checkbox"/> INTERNATIONAL AGREEMENT REPORT | | |
| 3. DISTRIBUTION A. List alphanumeric codes for distribution lists, such as 1B or CY. See NUREG/BR-0188, "Distribution List Descriptions for NRC Reports and Documents", or call 301-415-2070 to obtain a copy. B. Provide peel-off mailing labels for addressees not included in NRC distribution lists; if NRC staff, provide name and mail stop only; if non-NRC addressees, provide complete mailing address. C. If more than one copy is required for an addressee, indicate the number of copies in parentheses on the label. D. Include number of copies for the NRC Publication Project Manager, giving name and mail stop. | | | | | | |
| 4. CERTIFICATION (ANSWER ALL QUESTIONS) (Contact the IT Customer Services Branch, Office of the Chief Information Officer, at 301-415-1234 for instructions if the report contains a computer code) | | | | | | |
| YES | NO | <input type="checkbox"/> <input type="checkbox"/> A. REFERENCE AVAILABILITY – Is all material referenced in this report available to the public either through a public library, the Government Printing Office, the National Technical Information Service, or the NRC Public Document Room? If no, list below the specific availability of each referenced document. | | | | |
| | | SPECIFIC AVAILABILITY (Include attachment if necessary) | | | | |
| | | <input type="checkbox"/> <input type="checkbox"/> B. COPYRIGHTED MATERIAL – Does this report contain copyrighted material? If yes, attach a letter of release to print or to post to the www from the source that holds the copyright. See NUREG-0650, Rev. 2, "Preparing NUREG-Series Publications." | | | | |
| | | <input type="checkbox"/> <input type="checkbox"/> C. PATENT CLEARANCE – Does this report require patent clearance? If yes, the NRC Patent Counsel must signify clearance by signing below. | | | | |
| | | NRC PATENT COUNSEL (Type or print name) | SIGNATURE | DATE | | |
| | | <input type="checkbox"/> <input type="checkbox"/> E. METRIC UNIT CONVERSION – Does this report contain measurement and weight values? If yes, all must be converted to the International System of Units, followed by the English units in brackets, pursuant to the NRC Policy Statement implementing the Omnibus Trade and Competitiveness Act of 1988, Executive Order 12770, July 25, 1991. | | | | |
| | | <input type="checkbox"/> <input type="checkbox"/> F. FEDERAL REGISTER NOTICE – Will a Federal Register Notice of Availability be issued? If yes, submit copy of draft notice with manuscript. | | | | |
| | | <input type="checkbox"/> <input type="checkbox"/> H. COLOR PRINTING – Will this report require color printing? If yes, use of color must be approved by the Chief, Publishing Services Branch, OClO. Attach a copy of approval. | | | | |
| Contact the Records Management Branch (RMB), Office of the Chief Information Officer, at 301-415-7233 or E-mail address BJS1, to review this NUREG-series document and have RMB staff sign below. | | | | | | |
| | | RMB STAFF (Type or print name) | SIGNATURE | DATE | | |
| A NUREG-series publication may not contain a legally binding regulatory requirement. Your signature in Block 7 certifies that this publication contains none. | | | | | | |
| 5. PUBLICATION FORMATS (Check appropriate box) In addition to paper, publish in the following formats: | | | | | | |
| | | <input type="checkbox"/> DISKETTE If a diskette, submit two copies with manuscript. | <input type="checkbox"/> WWW If to be posted on the www, send request by e-mail to <nrcweb> | | | |
| 6. NRC PUBLICATION PROJECT MANAGER | | | 7. AUTHORIZATION TO PRINT (Cannot be the same person listed in block 6.) | | | |
| NAME (Type or print) | | | NRC OFFICIAL AUTHORIZING PUBLICATION (Type or print name) | | | |
| OFFICE/DIVISION | TELEPHONE NUMBER | MAIL STOP | E-MAIL I.D. | SIGNATURE | | |
| SIGNATURE | | | DATE | | | |

Figure 5.3 NRC Form 426, "Authorization To Publish a NUREG-Series Document Prepared by the NRC Staff"

| | | |
|---|---|--|
| <p>NRC FORM 426 (1-1999)</p> <p style="text-align: center;">U.S. NUCLEAR REGULATORY COMMISSION</p> <p style="text-align: center;">AUTHORIZATION TO PUBLISH A NUREG-SERIES DOCUMENT PREPARED BY THE NRC STAFF</p> | | <p>1. REPORT NUMBER - Obtain number from the Technical Publications Section, Telephone: 301-415-7174, or E-mail address: jrb1@nrc.gov</p> <p style="text-align: center;">NUREG-1531</p> |
| <p>2. TITLE AND SUBTITLE (State in full, using capital letters as they should appear on the report.)</p> <p>Final Environmental Impact Statement Related to the Reclamation of the Uranium Mill Tailings at the Atlas Site, Moab, Utah, Source Material License No. SUA 917 Docket No. 40-3453, Atlas Corporation</p> | | <p>TYPE OF DOCUMENT</p> <p><input checked="" type="checkbox"/> REPORT</p> <p><input type="checkbox"/> BROCHURE</p> <p><input type="checkbox"/> BOOK</p> <p><input type="checkbox"/> CONFERENCE PROCEEDINGS</p> <p><input type="checkbox"/> INTERNATIONAL AGREEMENT REPORT</p> |
| <p>3. DISTRIBUTION</p> <p>A. List alphanumeric codes for distribution lists, such as 1B or CY. See NUREG/BR-0188, "Distribution List Descriptions for NRC Reports and Documents", or call 301-415-2070 to obtain a copy.</p> <p>B. Provide pool-off mailing labels for addressees not included in NRC distribution lists; if NRC staff, provide name and mail stop only; if non-NRC addressees, provide complete mailing address.</p> <p>C. If more than one copy is required for an addressee, indicate the number of copies in parentheses on the label.</p> <p>D. Include number of copies for the NRC Publication Project Manager, giving name and mail stop.</p> | | <p>1H</p> <p>M. Fliegel, T7-J8 (75)</p> |
| <p>4. CERTIFICATION (ANSWER ALL QUESTIONS)</p> <p>(Contact the IT Customer Services Branch, Office of the Chief Information Officer, at 301-415-1234 for instructions if the report contains a computer code)</p> | | |
| YES | NO | <p><input checked="" type="checkbox"/> <input type="checkbox"/> A. REFERENCE AVAILABILITY - Is all material referenced in this report available to the public either through a public library, the Government Printing Office, the National Technical Information Service, or the NRC Public Document Room? If no, list below the specific availability of each referenced document.</p> |
| <p><input type="checkbox"/> SPECIFIC AVAILABILITY (include attachment if necessary)</p> | | |
| <p><input type="checkbox"/> <input checked="" type="checkbox"/> B. COPYRIGHTED MATERIAL - Does this report contain copyrighted material? If yes, attach a letter of release to print or to post to the www from the source that holds the copyright. See NUREG-0650, Rev. 2, "Preparing NUREG-Series Publications."</p> | | |
| <p><input type="checkbox"/> <input checked="" type="checkbox"/> C. PATENT CLEARANCE - Does this report require patent clearance? If yes, the NRC Patent Counsel must signify clearance by signing below.</p> | | |
| <p><input type="checkbox"/> NRC PATENT COUNSEL (Type or print name)</p> | | <p>SIGNATURE</p> |
| | | <p>DATE</p> |
| <p><input checked="" type="checkbox"/> <input type="checkbox"/> E. METRIC UNIT CONVERSION - Does this report contain measurement and weight values? If yes, all must be converted to the International System of Units, followed by the English units in brackets, pursuant to the NRC Policy Statement Implementing the Omnibus Trade and Competitiveness Act of 1988, Executive Order 12770, July 25, 1991.</p> | | |
| <p><input type="checkbox"/> <input checked="" type="checkbox"/> F. FEDERAL REGISTER NOTICE - Will a Federal Register Notice of Availability be issued? If yes, submit copy of draft notice with manuscript.</p> | | |
| <p><input type="checkbox"/> <input checked="" type="checkbox"/> H. COLOR PRINTING - Will this report require color printing? If yes, use of color must be approved by the Chief, Publishing Services Branch, OCIO. Attach a copy of approval.</p> | | |
| <p>Contact the Records Management Branch (RMB), Office of the Chief Information Officer, at 301-415-7233 or E-mail address BJS1, to review this NUREG-series document and have RMB staff sign below.</p> | | |
| <p><input type="checkbox"/> RMB STAFF (Type or print name)</p> | | <p>SIGNATURE</p> |
| | | <p>DATE</p> |
| <p>A NUREG-series publication may not contain a legally binding regulatory requirement. Your signature in Block 7 certifies that this publication contains none.</p> | | |
| <p>5. PUBLICATION FORMATS (Check appropriate box)</p> <p>In addition to paper, publish in the following formats:</p> <p><input type="checkbox"/> DISKETTE - If a diskette, submit two copies with manuscript.</p> <p><input checked="" type="checkbox"/> WWW - If to be posted on the www, send request by e-mail to <nrcweb></p> | | |
| <p>6. NRC PUBLICATION PROJECT MANAGER</p> | | <p>7. AUTHORIZATION TO PRINT (Cannot be the same person listed in Block 6.)</p> |
| <p>NAME (Type or print)</p> <p>Myron Fliegel</p> | | <p>NRC OFFICIAL AUTHORIZING PUBLICATION (Type or print name)</p> <p>M. King Stablein</p> |
| <p>OFFICE/DIVISION</p> <p>NMSS/DWM</p> | <p>TELEPHONE NUMBER</p> <p>415-6629</p> | <p>SIGNATURE</p> |
| <p>MAIL STOP</p> <p>T7-J8</p> | <p>E-MAIL I.D.</p> <p>MHF1</p> | <p>DATE</p> |
| <p>SIGNATURE</p> | | <p>DATE</p> |

Figure 5.4 Sample Completed NRC Form 426

Publishing Forms

| | | | | | |
|---|--|--|--|--|--|
| NRC FORM 426A (1-1999) | | U.S. NUCLEAR REGULATORY COMMISSION | | 1. REPORT NUMBER - Obtain number from the Technical Publications Section Telephone: 301-415-7085, E-mail address: tps2@nrc.gov; or Telephone: 301-415-6840, E-mail address: ebw1@nrc.gov | |
| AUTHORIZATION TO PUBLISH A NUREG-SERIES DOCUMENT PREPARED BY A CONTRACTOR FOR THE NRC STAFF | | | | | |
| 2. TITLE AND SUBTITLE (State in full, using capital letters as they should appear on the report.) | | | | 3. NRC JOB CODE (Do not list DOE contract number) | |
| 4. AUTHORS (List all with last name and first two initials.) | | | | 5. TYPE OF DOCUMENT (Check appropriate box) <input type="checkbox"/> A. Contractor-Prepared Report <input type="checkbox"/> B. International Agreement Report <input type="checkbox"/> C. Conference Proceedings | |
| 6. CONTRACTOR (SUBCONTRACTOR, if applicable) NAME AND COMPLETE MAILING ADDRESS FOR EACH (include ZIP code) | | | | TELEPHONE NUMBER E-MAIL I.D. | |
| 7. PUBLICATION FORMATS (Check appropriate box) In addition to paper, publish in the following formats: | | | | <input type="checkbox"/> DISKETTE If a diskette, submit two copies with manuscript. | |
| | | | | <input type="checkbox"/> WWW If to be posted on the www, send request by e-mail to <nrcweb> | |
| 8. DISTRIBUTION A. List alphanumeric codes for distribution lists, such as 1M or C3. See NUREG/BR-0188, "Distribution List Descriptions for NRC Reports and Documents", or call 310-415-2070 to obtain a copy. B. Provide peel-off mailing labels for addressees not included in NRC distribution lists; if NRC staff, provide name and mail stop only; if non-NRC addressees, provide complete mailing address. C. If more than one copy is required for an addressee, indicate the number of copies in parentheses on the label. D. Include number of copies for the NRC Publication Project Manager, giving name and mail stop. | | | | | |
| 9. CERTIFICATION (ANSWER ALL QUESTIONS) (Contact the IT Customer Services Branch, Office of the Chief Information Officer, at 301-415-1234 for instructions if the report contains a computer code) | | | | | |
| <input type="checkbox"/> YES <input type="checkbox"/> NO | | <input type="checkbox"/> A. REFERENCE AVAILABILITY - Is all material referenced in this report available to the public either through a public library, the Government Printing Office, the National Technical Information Service, or the NRC Public Document Room? If no, list below the specific availability of each referenced document. | | | |
| SPECIFIC AVAILABILITY (Include attachment if necessary) | | | | | |
| <input type="checkbox"/> B. COPYRIGHTED MATERIAL | | - Does this report contain copyrighted material? If yes, attach a letter of release to print or to post to the www from the source that holds the copyright. See NUREG-0650, Rev. 2, "Preparing NUREG-Series Publications." | | | |
| <input type="checkbox"/> C. PATENT CLEARANCE | | - Does this report require patent clearance? If yes, the NRC Patent Counsel must signify clearance by signing below. | | | |
| <input type="checkbox"/> D. METRIC UNIT CONVERSION | | - Does this report contain measurement and weight values? If yes, all must be converted to the International System of Units, followed by the English units in brackets, pursuant to the NRC Policy Statement implementing the Omnibus Trade and Competitiveness Act of 1988, Executive Order 12770, July 25, 1991. | | | |
| <input type="checkbox"/> E. FEDERAL REGISTER NOTICE | | - Will a Federal Register Notice of Availability be issued? If yes, submit copy of draft notice with manuscript. | | | |
| <input type="checkbox"/> F. COLOR PRINTING | | - Will this report require color printing? If yes, use of color must be approved by the Chief, Publishing Services Branch, OClO. Attach a copy of approval. | | | |
| Contact the Records Management Branch (RMB), Office of the Chief Information Officer, at 301-415-7233 or E-mail address BJS1, to review this NUREG-series document and have RMB staff sign below. | | | | | |
| <input type="checkbox"/> RMB STAFF (Type or print name) | | SIGNATURE | | DATE | |
| A NUREG-series publication may not contain a legally binding regulatory requirement. Your signature in Block 10C certifies that this publication contains none. | | | | | |
| 10. AUTHORIZATION TO PRINT | | | | | |
| <input type="checkbox"/> A. CONTRACTOR AUTHORIZING OFFICIAL (if applicable - type or print) | | SIGNATURE | | DATE | |
| <input type="checkbox"/> B. NRC PUBLICATION PROJECT MANAGER (Type or print name) | | SIGNATURE | | DATE | |
| OFFICE/DIVISION | | TELEPHONE NUMBER | | MAIL STOP | |
| | | | | E-MAIL I.D. | |
| <input type="checkbox"/> C. NRC OFFICIAL AUTHORIZING PUBLICATION (Type or print) | | SIGNATURE | | DATE | |
| OFFICE/DIVISION | | TELEPHONE NUMBER | | MAIL STOP | |
| | | | | E-MAIL I.D. | |

Figure 5.5 NRC Form 426A, "Authorization To Publish a NUREG-Series Document Prepared by a Contractor for the NRC Staff"

| | | | | | |
|--|--|---|--|---|--|
| NRC FORM 426A (1-1999) | | U.S. NUCLEAR REGULATORY COMMISSION | | 1. REPORT NUMBER - Obtain number from the Technical Publications Section Telephone: 301-415-7085, E-mail address: its2@nrc.gov ; or Telephone: 301-415-6840, E-mail address: sbm1@nrc.gov | |
| AUTHORIZATION TO PUBLISH A NUREG-SERIES DOCUMENT PREPARED BY A CONTRACTOR FOR THE NRC STAFF | | | | NUREG/CR-6131 | |
| 2. TITLE AND SUBTITLE (State in full, using capital letters as they should appear on the report.) VICTORIA 2.0: A Mechanistic Model for Radionuclide Behavior in a Nuclear Reactor Coolant System Under Severe Accident Conditions | | | | 3. NRC JOB CODE (Do not list DOE contract number) W6466 | |
| 4. AUTHORS (List all with last name and first two initials.) N.E. Bixler | | | | 5. TYPE OF DOCUMENT (Check appropriate box) <input checked="" type="checkbox"/> A. Contractor-Prepared Report <input type="checkbox"/> B. International Agreement Report <input type="checkbox"/> C. Conference Proceedings | |
| 6. CONTRACTOR (SUBCONTRACTOR, if applicable) NAME AND COMPLETE MAILING ADDRESS FOR EACH (include ZIP code) Sandia National laboratories Albuquerque, NM 87185 | | | | TELEPHONE NUMBER 505-845-3144 E-MAIL ID. nbixler@sandia.gov. | |
| 7. PUBLICATION FORMATS (Check appropriate box) In addition to paper, publish in the following formats: | | | | <input type="checkbox"/> DISKETTE If a diskette, submit two copies with manuscript. | |
| | | | | <input type="checkbox"/> WWW If to be posted on the www, send request by e-mail to <nrcweb> | |
| 8. DISTRIBUTION A. List alphanumeric codes for distribution lists, such as 1M or C3. See NUREG/BR-0188, "Distribution List Descriptions for NRC Reports and Documents", or call 310-415-2070 to obtain a copy. B. Provide peel-off mailing labels for addressees not included in NRC distribution lists; if NRC staff, provide name and mail stop only; if non-NRC addressees, provide complete mailing address. C. If more than one copy is required for an addressee, indicate the number of copies in parentheses on the label. D. Include number of copies for the NRC Publication Project Manager, giving name and mail stop. | | | | R3, CY J.Schaperow, T10-K8 (10) | |
| YES NO | | 9. CERTIFICATION (ANSWER ALL QUESTIONS) (Contact the IT Customer Services Branch, Office of the Chief Information Officer, at 301-415-1234 for instructions if the report contains a computer code) | | | |
| <input checked="" type="checkbox"/> <input type="checkbox"/> | | A. REFERENCE AVAILABILITY - Is all material referenced in this report available to the public either through a public library, the Government Printing Office, the National Technical Information Service, or the NRC Public Document Room? If no, list below the specific availability of each referenced document. | | | |
| <input type="checkbox"/> | | SPECIFIC AVAILABILITY (include attachment if necessary) | | | |
| <input type="checkbox"/> <input checked="" type="checkbox"/> | | B. COPYRIGHTED MATERIAL - Does this report contain copyrighted material? If yes, attach a letter of release to print or to post to the www from the source that holds the copyright. See NUREG-0650, Rev. 2, "Preparing NUREG-Series Publications." | | | |
| <input type="checkbox"/> <input checked="" type="checkbox"/> | | C. PATENT CLEARANCE - Does this report require patent clearance? If yes, the NRC Patent Counsel must signify clearance by signing below. | | | |
| <input type="checkbox"/> | | NRC PATENT COUNSEL (Type or print name) | | SIGNATURE | |
| <input type="checkbox"/> | | | | DATE | |
| <input type="checkbox"/> <input checked="" type="checkbox"/> | | D. METRIC UNIT CONVERSION - Does this report contain measurement and weight values? If yes, all must be converted to the International System of Units, followed by the English units in brackets, pursuant to the NRC Policy Statement implementing the Omnibus Trade and Competitiveness Act of 1988, Executive Order 12770, July 25, 1991. | | | |
| <input type="checkbox"/> <input checked="" type="checkbox"/> | | E. FEDERAL REGISTER NOTICE - Will a Federal Register Notice of Availability be issued? If yes, submit copy of draft notice with manuscript. | | | |
| <input type="checkbox"/> <input checked="" type="checkbox"/> | | F. COLOR PRINTING - Will this report require color printing? If yes, use of color must be approved by the Chief, Publishing Services Branch, OCHO. Attach a copy of approval. | | | |
| Contact the Records Management Branch (RMB), Office of the Chief Information Officer, at 301-415-7233 or E-mail address BJS1, to review this NUREG-series document and have RMB staff sign below. | | | | | |
| <input type="checkbox"/> | | RMB STAFF (Type or print name) | | SIGNATURE | |
| <input type="checkbox"/> | | | | DATE | |
| A NUREG-series publication may not contain a legally binding regulatory requirement. Your signature in Block 10C certifies that this publication contains none. | | | | | |
| 10. AUTHORIZATION TO PRINT | | | | | |
| A. CONTRACTOR AUTHORIZING OFFICIAL (if applicable - type or print) | | SIGNATURE | | DATE | |
| J. King | | | | | |
| B. NRC PUBLICATION PROJECT MANAGER (Type or print name) | | SIGNATURE | | DATE | |
| J. Schaperow | | | | | |
| OFFICE/DIVISION | | TELEPHONE NUMBER | | MAIL STOP | |
| RES/DST | | 415-6770 | | T10-K8 | |
| C. NRC OFFICIAL AUTHORIZING PUBLICATION (Type or print) | | SIGNATURE | | DATE | |
| C.G. Linkler | | | | | |
| OFFICE/DIVISION | | TELEPHONE NUMBER | | MAIL STOP | |
| RES/DST | | 415-6770 | | T10-K8 | |
| | | E-MAIL ID. | | | |
| | | | | jhs1 | |
| | | | | cqt | |

Figure 5.6 Sample Completed NRC Form 426A

APPENDIX

This appendix contains a sample NUREG-series publication. The contents of the various sections of this sample publication are not necessarily related, for example, the abbreviations may not appear in the text. Each section is designed to illustrate appropriate formatting or necessary components of the section. For example, the sample shows references, how to refer to a reference in the text, and how to refer to each appendix in the text in the order of its placement in the report (see pages 1 and 3 of this appendix). Note that the pages in the appendix are numbered consecutively as they would be in a report rather than as described in Section 4 of this guide.

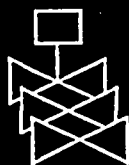
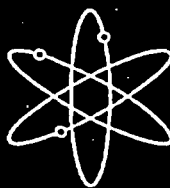
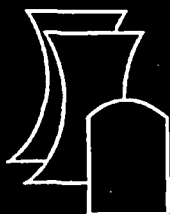

An Assessment of Fire Vulnerability for Aged Electrical Relays

Sandia National Laboratories

SAMPLE REPORT

U.S. Nuclear Regulatory Commission
Office of Nuclear Regulatory Research
Washington, DC 20555-0001



MAY 19XX

AN ASSESSMENT OF FIRE VULNERABILITY FOR AGED ELECTRICAL RELAYS

NUREG/CR-6220

NUREG/CR-6220
SAND94-0769

An Assessment of Fire Vulnerability for Aged Electrical Relays

Manuscript Completed: May 19XX
Date Published: May 19XX

Prepared by
R. A. Vigil,* S. P. Nowlen

Sandia National Laboratories
Albuquerque, NM 87185-0737

J. E. Doe, NRC Project Manager

Prepared for
Division of Engineering
Office of Nuclear Regulatory Research
U.S. Nuclear Regulatory Commission
Washington, DC 20555-0001
NRC Job Code A1833

*Science & Engineering Associates, Inc.
6100 Uptown Blvd. NE
Albuquerque, NM 87110

ABSTRACT

This report describes testing to assess the impact of aging on the fire vulnerability of Agastat and General Electric relays. Both aged and unaged relays were tested. Aged relays were subjected to operational cycling under rated load and thermally aged for 60 days. All relays were exposed to one of three different fire temperature profiles in the Severe Combined Environments Test Chamber located at Sandia National

Laboratories. The ability to operate properly in the given fire environment was monitored. Results for the aged and unaged relays were examined to determine the impact of aging on the relays' ability to sustain operation under the test conditions. Overall results indicated that the aged relays' performance was not significantly different from that of the unaged relays.

CONTENTS

| | <i>Page</i> |
|---|-------------|
| Abstract | iii |
| Executive Summary | vii |
| Abbreviations | ix |
| 1 Introduction and Objectives | 1 |
| 2 Relay Selection Basis and Results | 3 |
| 3 Experimental Arrangement | 7 |
| 3.1 Relay Aging Procedures | 7 |
| 3.2 Relay Fire Testing | 7 |
| 3.3 Relay Operational Assessments | 9 |
| 4 Experimental Results | 11 |
| 4.1 Aging | 11 |
| 4.2 Thermal Exposure Results | 11 |
| 4.2.1 Agastat GPI Results | 12 |
| 4.2.2 General Electric HMA Results | 13 |
| 4.2.3 General Electric HGA Results | 14 |
| 4.2.4 General Electric HFA Results | 16 |
| 5 Conclusions | 19 |
| 6 References | 21 |

Appendices

| | |
|---|-----|
| A SCETCh Temperature Exposure Plots for All Relays Tested | A-1 |
| B Glossary | B-1 |

Figures

| | |
|--|----|
| 1 Schematic of a Typical Armature Style Relay | 4 |
| 2 Severe Combined Environments Test Chamber (SCETCh) at Sandia National Laboratories | 7 |
| 3 SCETCh Temperature Exposure Profiles | 8 |
| 4 Measurement Schematic for Each Contact Pair and Measurement Matrix | 9 |
| 5 Agastat A1 Relay With Normally Open Contact Stuck Because of a Melted Contact Carrier | 12 |

CONTENTS (continued)

| | <i>Page</i> |
|---|-------------|
| 6 General Electric HMA Relay B-3 After Thermal Exposure | 14 |
| 7 General Electric HGA Relay C-1 After Failure of the Spool's Top Plate | 15 |
| 8 General Electric HGA Relay C-4 Failure of the Armature Because of Blockage | 16 |
| 9 General Electric HFA Relay D-1 After Thermal Exposure | 17 |

Tables

| | |
|-------------------------------------|----|
| 1 Relay Identification Scheme | 5 |
| 2 Overall Relay Test Results | 18 |

EXECUTIVE SUMMARY

The purpose of this test program was to assess whether the fire vulnerability of electrical relays increased with aging. A five-step sequence followed for the test program was to (1) identify specific relay types, (2) develop three fire scenarios, (3) artificially age several relays, (4) test the unaged and aged relays in the fire exposure scenarios, and (5) compare the results.

The relays tested were Agastat GPI, General Electric (GE) HMA, HGA, and HFA. At least two relays of each type were artificially aged and at least two relays of each type were new. Relays were operationally aged by cycling the relay under rated load for 2000 operations. These relays were then thermally aged for 60 days with their coil energized.

Temperature exposure testing was conducted in Sandia's Severe Combined Environments Test Chamber (SCETCh). Three exposure profiles were developed for this test program, which were representative of a generic mild, moderate, or severe thermal exposure. The exposure profile consisted of two phases: The initial phase consisted of a temperature ramp to either 250 °C, 350 °C, or 450 °C, a 10–20 minute dwell at the desired temperature, and then a temperature decrease toward ambient. The second phase began shortly after the end of the first phase and consisted of a temperature ramp at a rate of 10 °C per minute until failure was observed. The second phase was only performed if the relay survived the first phase.

Results for the Agastat GPI relays indicated that aging would not significantly affect the thermal vulnerability of the relay. All of the relays tested were observed to fail at temperatures ranging from 206 to 250 °C. In fact, of the relays tested, only one—an aged sample—survived the initial phase of the mild exposure profile. Failures were generally traced to either the coil rectification circuit or the base socket.

Results for the GE HMA relays indicated that the aged samples were, in fact, somewhat more rugged than the unaged samples. During exposures to the moderate exposure profile, an unaged sample was observed to fail whereas an aged sample survived the initial phase of this profile. All failures were attributed to failure of the armature. In three of the four cases, actuation of the armature failed because of an accumulation of an unknown substance that formed on the top of the coil's spool just below the armature. The final failure was attributed to the armature becoming used to the relay's housing.

Results for the GE HGA relays indicated that aging did not impact the thermal vulnerability of the relays. However, one of the aged samples displayed a unique failure in that it failed during the cool-down portion of the first phase of the moderate exposure profile. The remaining three relays survived to temperatures in excess of 450 °C. Three of the relay failures were attributed to the accumulation of an unknown substance that formed on the top of the coil's spool just below the armature. The final failure was attributed to deformation of the coil top plate.

Results for the GE HFA relays indicated that aging did not significantly impact the thermal vulnerability. Both aged and unaged samples were observed to survive the initial phase of the mild exposure profile while failing during the initial phase of the moderate exposure profile. All failures were attributed to failures of the armature.

In general, the conclusion was that aging did not adversely affect the thermal vulnerability of relays. Depending on the type of relay, the effect of exposure to even mild temperature excursions (>200 °C) may degrade relay performance regardless of the relay's age. Failure mechanisms were generally attributed to failures in the armature.

ABBREVIATIONS

| | |
|-------|--|
| AI | Automated Industries |
| BNL | Brookhaven National Laboratory |
| CAL | Confirmatory Action Letter |
| CFR | Code of Federal Regulations |
| DOT | U.S. Department of Transportation |
| DU | depleted uranium |
| ECG | East Coast Group |
| EST | Eastern Standard Time |
| HMR | Hazardous Materials Regulations |
| HMTA | Hazardous Materials Transportation Act |
| IAEA | International Atomic Energy Agency |
| IATA | International Air Transportation Association |
| ICAO | International Civil Aviation Organization |
| KINS | Korean Institute of Nuclear Safety |
| KIT | Korean Industrial Testing Company |
| LSA | low specific activity |
| MOST | Ministry of Science and Technology (Korea) |
| MOU | Memorandum of Understanding |
| NRC | U.S. Nuclear Regulatory Commission |
| NVOCC | non-vessel operating common carrier |
| ORAU | Oak Ridge Associated Universities |
| PPQ | plant protection quarantine |
| PST | Pacific Standard Time |
| RSO | Radiation Safety Officer |
| S/N | serial number |
| UN | United Nations |
| USCG | United States Coast Guard |
| USDA | U.S. Department of Agriculture |
| WCG | West Coast Group |

1 INTRODUCTION AND OBJECTIVES

Regulators of the nuclear industry have been concerned that as nuclear power plants age, protective measures taken to control and minimize the impact of fire may become ineffective or significantly less effective and, hence, result in an increased fire risk. One objective of the Fire Vulnerability of Aged Electrical Components Program is to assess the effects of aging and service wear on the fire vulnerability of electrical equipment. An increased fire vulnerability of components may lead to an overall increase in fire risk to the plant.

Because of their widespread use in various

electrical safety systems, electromechanical relays were chosen to be the initial components for evaluation (Ref. 1). This test program assessed the impact of operational and thermal aging on the vulnerability of these relays to fire-induced damage. Only thermal effects of a fire were examined in this test program. The impact of smoke, corrosive materials, or fire suppression effects on relay performance were not addressed in this test program. In addition to discussing this test program and conclusions drawn from it in Sections 2 through 5 of this report, Appendix A has temperature exposure profiles for each relay tested and Appendix B is a glossary.

2 RELAY SELECTION BASIS AND RESULTS

An earlier study performed as a part of the Fire Vulnerability of Aged Electrical Components Program identified and prioritized nuclear power plant electrical equipment potentially vulnerable to age-related increases in fire vulnerability (Ref. 1). This study included an evaluation of industry practice and component count totals. As a result, relays were identified as one of the high priority components.

Relays used in safety-related applications can typically be divided into four categories: protective, auxiliary, control, and timing. Protective relays serve to protect electrical distribution systems from electrical overloads. Auxiliary relays serve to assist protective relays, especially when loads up to 35 amps are present in the distribution system. Control relays serve as direct controlling mechanisms for various mechanical components. Timing relays perform similarly to control relays with the exception that these relays are combined with a timing device that actuates the contacts after a time period has passed from the receipt of a control signal (Ref. 2).

The dominant aging-related stress for relays identified in Reference 1 is the thermal aging of synthetic parts caused by continuous energization or elevated cabinet temperatures. Reference 1 also identifies the following possible failure modes and causes:

Relay Failure Modes:

- Failure to actuate when commanded
- Actuates without command
- Does not make or break current
- Failure to carry current
- High contact resistance
- Set-point shift
- Time delay shift

Relay Failure Causes:

- Phase-to-ground short

- Coil insulation breakdown
- Contact wear
- Binding of contacts because of carrier warpage
- Pitting, corrosion, and accumulation of contaminants on contacts
- Wear of moving parts
- Loss of integrity of relay pin/socket connection
- Vibration damage: contact chatter, loosening of connections
- Shift in resistance and capacitive values affecting time delay and relay set-point values

Reference 1 identifies those relay models having the greatest numbers in nuclear power plants. In particular, three General Electric (GE) models are identified as the most widely used in industry: the GE model HFA (21%), GE model HGA (12%), and GE model HMA (7%). General Electric supplies approximately 52 percent of all electromechanical relays to the utilities that responded to the survey (Ref. 1). Results of the survey showed that Agastat/Amerace relays provided 10 percent of all relays. In light of the survey results, the following relays were chosen to be tested in this program:

- General Electric 12HFA51A49F
5 relays tested
- General Electric I2HMA111A9
4 relays tested
- General Electric I2HGA11A70F
4 relays tested
- Agastat/Amerace GPI
6 relays tested

All the relays chosen are armature style relays and are rated for operation at 115 V and 12 amps (except for the Agastats, which are rated at 10 amps). Figure 1 shows the basic components of a typical armature style relay.

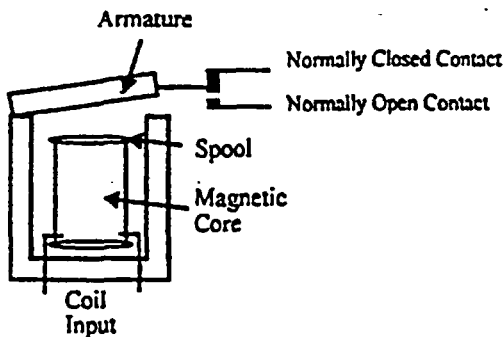

Figure 1 Schematic of a Typical Armature Style Relay

The relays tested in this program were obtained directly from the suppliers. They are effectively identical to UL recognized and Class 1E qualified devices sold to nuclear power plants, although they were not procured to Class 1E specifications. The major difference lies in the traceability of the relay production.

General Electric relays are constructed with either the standard life coil design or the Century series coil design. Further analysis of the survey data from Reference 2 indicates that both types of coil designs for these relay models are in use in various systems in nuclear power plants. The GE HGA and HFA relays tested in this program were constructed using the standard life relay coil design. The GE HMA models tested in this program were constructed using the Century Series coil design.

Basic design features of the Century Series coil include the following:

- the coil's spool is comprised of high thermal strength, glass-filled polyester for extended life at elevated temperatures;
- the wire insulation is a polyamideimide wire coating (180 °C rating) that retains insulation integrity and mechanical strength at elevated temperatures; and
- the encapsulation is described by the manufacturer as polybutadiene, solventless, and impregnant.

Accelerated life tests conducted at an elevated temperature and maximum voltage have established a projected service life of 40 years at 55 °C and 110 percent of rated voltage for this coil design. The standard life coils are simple coil designs with a phenolic spool and an exterior tape wrap. The wire insulation is similar to that of the Century Series.

The Agastat GPI relays are constructed using an electromagnetic core. A W-shaped mechanism is connected to the core to provide contact switching movement. The coil provides a low mean turn length and assists in heat dissipation. The GPI relays also have a built-in rectification circuit that retains the dc efficiency of the electromagnet. The current peak upon coil energization is also eliminated through the use of a capacitor. The GPI relays require a screw terminal molded socket for operation. Note that two socket models are available. The model number of the socket used in this test program was CR0067.

In all, 19 relays were tested as a part of this program. Table 1 lists the scheme used to identify each of the relays tested.

| Table 1 Relay Identification Scheme | | |
|-------------------------------------|----------------|-----------------|
| Relay Identification | Model Number | Aging Condition |
| A1 | Agastat GPI | Aged |
| A2 | Agastat GPI | Aged |
| A3 | Agastat GPI | Unaged |
| A4 | Agastat GPI | Unaged |
| A5 | Agastat GPI | Unaged |
| A6 | Agastat GPI | Unaged |
| B1 | GE 12HMA111A9 | Aged |
| B2 | GE 12HMA111A9 | Aged |
| B3 | GE 12HMA111A9 | Unaged |
| B4 | GE 12HMA111A9 | Unaged |
| C1 | GE 12HGA11A70F | Aged |
| C2 | GE 12HGA11A70F | Aged |
| C3 | GE 12HGA11A70F | Unaged |
| C4 | GE 12HGA11A70F | Unaged |
| D1 | GE 12HFA51A49F | Aged |
| D2 | GE 12HFA51A49F | Aged |
| D3 | GE 12HFA51A49F | Unaged |
| D4 | GE 12HFA51A49F | Unaged |
| D5 | GE 12HFA51A49F | Unaged |

3 EXPERIMENTAL ARRANGEMENT

3.1 Relay Aging Procedures

A general aging procedure was established based on the information contained in IEEE C37.105-1987, "Standard for Qualifying Class 1E Protective Relays." This procedure included both operational and thermal aging. Radiation aging of the relays was not included in the aging procedure.

The relays to be aged were cycled individually under rated load for 2000 cycles to fulfill the basic operational aging requirements defined in IEEE C37.105-1987. The relay coils were energized every minute for 0.4 seconds. After each set of 500 cycles, the coil resistance was measured for each relay.

After completion of the operational aging, the relays were thermally aged in an oven for 60 days at 110 °C. During this entire period, the coil of each relay was energized to simulate the additional thermal load produced by the self-heating effects of the coil. (Note that the

two Agastat bases were not included with the relays in the thermal aging portion of the test.)

The thermal aging procedure was intended to represent a generic aging condition. That is, the thermal aging protocol was not based on achieving a particular aged condition for any of the specific relay materials. Rather, the protocol was intended to provide nominal aging conditions for the relay as a whole.

3.2 Relay Fire Testing

The fire exposure tests were conducted in Sandia National Laboratories' (SNLs) Severe Combined Environments Test Chamber (SCETCH). The SCETCH facility, shown in Figure 2, is able to simulate both transient and steady-state thermal conditions. The SCETCH facility was designed to simulate fire environment effects. Additional capabilities of the SCETCH facility include steam testing and hydrogen burn simulation. The facility may be used as a high temperature pressure vessel. The SCETCH facility is designed to operate at elevated temperatures as high as 1500 °C.

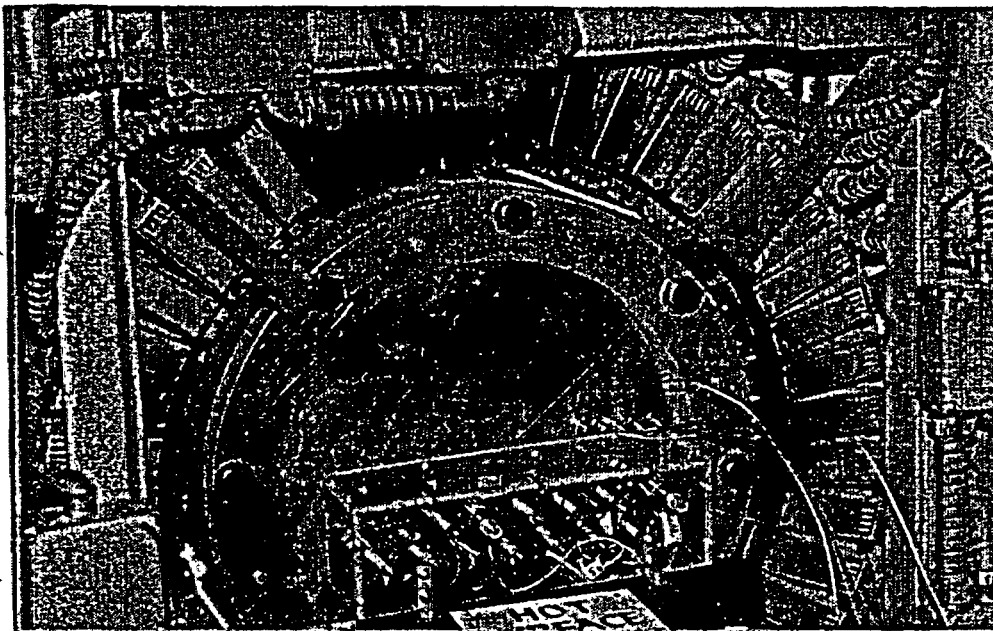

Figure 2 Severe Combined Environments Test Chamber (SCETCH) at Sandia National Laboratories

The SCETCH chamber is a cylindrical chamber measuring 24-inches long by 18-inches in diameter. The shell and cover plates are constructed from Inconel 625. The elevated temperatures are generated by a series of quartz lamps mounted around the chamber. Resistance coil heaters are used to heat incoming fresh air for the chamber. The desired temperature exposure profiles are achieved using a computer-controlled 480 V ac power supply.

Each of the sample relays was tested using one of three thermal exposure profiles. These profiles were intended to be representative of generic mild, moderate, and severe thermal exposures, respectively. That is, the profiles were intended to represent various commonly identified generic fire scenarios rather than any given specific fire scenario. Transient profile ramp rates, peak exposure temperatures, and profile durations were determined

on the basis of the results of available test data and actual nuclear power plant fire event reports. (Refs. 3-7)

Each of the three profiles consists of two phases as shown in Figure 3. During the first phase of the exposure—

- the exposure temperature was increased from ambient at a rate of approximately 20 °C/min (initial ramp);
- upon attaining a predetermined temperature, the exposure was held constant for a specified time (plateau); and
- the exposure temperature was decreased toward ambient conditions over a period of approximately 20 minutes (cool-down).

For the mild exposure profile, the initial ramp lasted for approximately 10 minutes, reaching

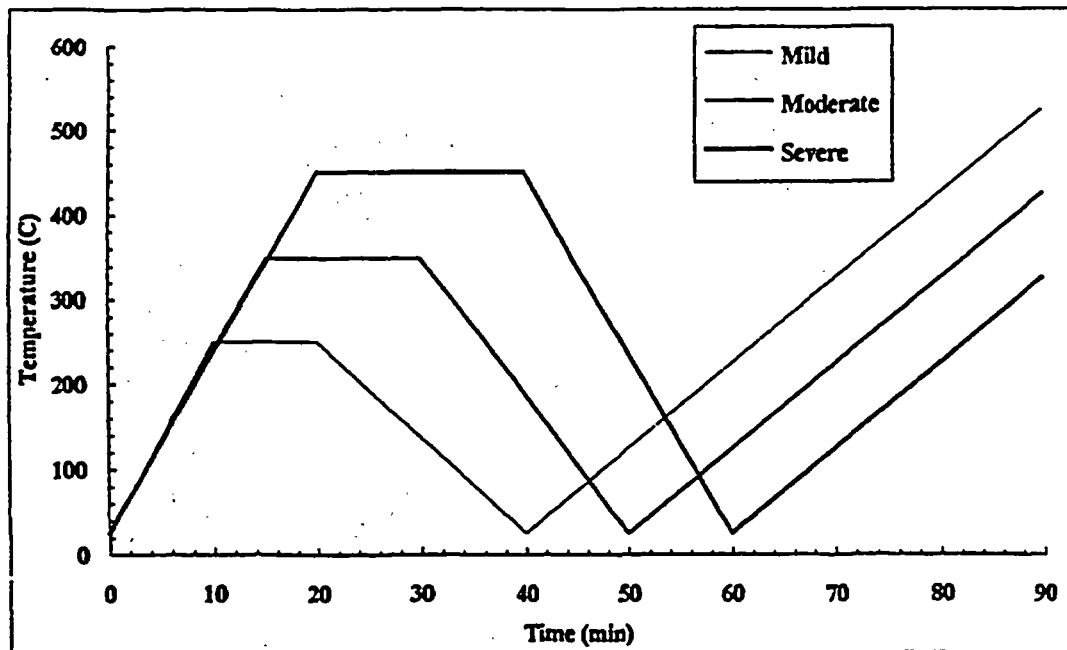

Figure 3 SCETCH Temperature Exposure Profiles

a plateau temperature of 250 °C, which was held for an additional 10 minutes. For the moderate exposure profile, the initial ramp lasted for approximately 15 minutes, reaching a plateau temperature of 350 °C, which was held for an additional 15 minutes. For the severe exposure profile, the initial ramp lasted for approximately 20 minutes, reaching a plateau temperature of 450 °C, which was held for an additional 20 minutes.

The second phase of each exposure profile consisted of an upward ramp in temperature at a rate of 10 °C/min until relay failure was detected. The relay under test would undergo the second phase only if it had survived the first phase of the exposure profile. This second phase of the exposure profile was intended to assess the relative margin by which a relay had survived the initial phase of the exposure profile. For example, if the relay failed at a substantially higher temperature than the first phase plateau temperature, then it could be

concluded that the relay had survived the first phase with significant margin.

3.3 Relay Operational Assessments

During each exposure, the test relay was operated under a 1 amp load for each contact set and was periodically required to actively switch this load. In particular, each 60-second measurement cycle consisted of a period of 50 seconds during which the coil was energized and 10 seconds when the coil was de-energized. The relay's ability to switch the load was monitored to verify operability.

Additional measurements made during each measurement cycle included the relay's coil resistance, contact set resistance, and leakage currents. An electrical schematic of the simulated load and performance monitoring circuit used for each contact set is shown in Figure 4. The measurement matrix is also included for clarification.

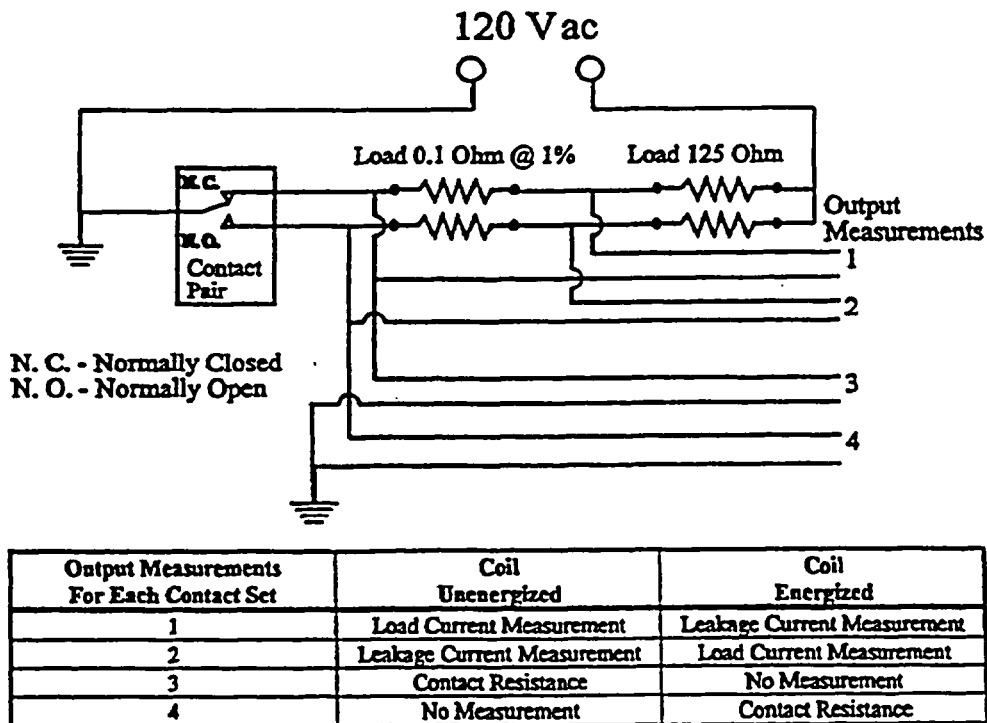

Figure 4 Measurement Schematic for Each Contact Set and Measurement Matrix

This mode of operation is not representative of typical in-plant applications. Typically, a relay would be called upon either to hold its current position throughout an event or to switch positions once and hold the new position. However, the objectives of this test program require that the relative performance of the aged and unaged relays be compared.

Hence, assessing both the timing of relay failure during a particular exposure profile as well as the fact of survival or failure was important. To meet this objective, the relays had to be operated periodically to assess the continuing operability throughout the exposure.

4 EXPERIMENTAL RESULTS

4.1 Aging

No anomalies were recorded during the operational cycling of the relays. The coil resistance varied less than 4 percent during the cycling for each of the relay types. No coil failures or test equipment anomalies were detected during the thermal aging of the relays.

However, after the thermal aging, note that the armature of the HGA relay was malfunctioning. As the HGA coils were energized, the armatures for each relay easily switched from the normally closed to the normally open position. However, when the coils were deenergized, the armature did not completely return to the normally closed position. The hypothesis was that the thermal aging might have caused the degradation of some unknown lubricant in the pivot. (However, the manufacturer stated that no lubricant was used in the armature.) The manufacturer hypothesized that particulates from outgassing during the thermal aging may prevent the armature from returning to the normally closed position.

Another possibility for the improper operation of the relay was the failure of the return spring. The return action of the armature was controlled by a spring attached to a slotted flange on the armature. A spring from an unaged relay was substituted for the one from the aged relay. With the new spring in place, the relay still did not return to the normally closed position, which indicated that the spring itself was not the cause of the problem. The spring from the aged relay was returned to the original position on the aged relay. The spring was in the original slot position, which was the middle slot on the flange, during operational and thermal aging. As the spring was adjusted to provide the greatest closing force, the first relay still would not return to the normally closed position.

By using low pressure air, the armature from the first aged relay was cleaned to try to

remove any particulates that might be hampering the armature movement. After the pressurized air cleaning and the adjustment of the spring's position, the armature returned to the normally closed position when the relay's coil was de-energized. The second relay was also cleaned with pressurized air, and it also had the spring adjusted to provide maximum closing force. Likewise, this relay now performed as required. The position of this spring remained in the slot that provided the greatest closing force so that the remainder of the test program could be completed. The exact cause of this failure was not fully determined during this test program, but it may warrant further investigation. The remaining relays did not experience any problems upon completion of the thermal aging.

4.2 Thermal Exposure Results

For each relay type, the first exposure was performed using the unaged samples followed by testing of the aged samples. For each group the first relay sample was subjected to the moderate exposure profile. Based on the result of this exposure, the next sample was subjected to either the mild or severe exposure profile. That is, if the first sample survived the entire first phase of the moderate profile, then the second sample was subjected to the severe profile. Conversely, if the first sample failed during the first phase of the moderate profile, then the second sample was subjected to the mild profile. Certain exceptions to this general test sequence were exercised as described in the next four paragraphs.

In preparation for testing, relays were energized for approximately 5 minutes before the thermal exposure. Failures were determined by either a loss of load-switching capability or the opening of a 1-amp fuse located on the coil input. Upon indication of failure, the experimental control program was allowed to complete another full measurement cycle to verify that a persistent failure had occurred. The power to the SCETCH chamber, the relay load, and the coil power was then shut off. The

test relay remained in the chamber until the chamber's temperature decreased.

Each relay type was tested in its expected mounting position. The mounting hardware included with each relay was used during the testing. Complete panels were not used, only frame supports as necessary to provide for mounting.

The complete results for all relays tested can be found in Table 2 at the end of this section. Temperature exposure profiles of each relay can be found in Appendix A. The specific details for each relay type are discussed in the following sections.

4.2.1 Agastat GPI Results

A previous test program, which evaluated relay functionality during exposures to secondary environments created by a fire, indicated that the Agastat relays were not likely to survive the mild exposure profile (Ref. 7). Therefore, all of the Agastat samples were tested in the mild exposure profile.

The Agastat A1 relay survived 64 minutes into the mild thermal exposure, failing during the

second-phase temperature ramp. The temperature at the time of relay failure was 250 °C. Post-test analysis revealed two failure mechanisms. The first failure was detected in the base where two terminals were shorted together because of warpage of the base socket. The second failure discovered was a melted contact carrier that prevented the armature from returning to the normally closed position, as shown in Figure 5. During the previous test program (Ref. 7), an Agastat GPI relay displayed a similar contact carrier failure at a temperature of approximately 210 °C. (Note that this earlier program utilized a slowly increasing temperature profile until failure was detected.)

The second aged Agastat relay, A2, survived approximately 24 minutes, failing during the early stages of the cool-down period. The peak exposure temperature was 241 °C, and the temperature at the time of failure was 210 °C.

Post-test analysis revealed that a capacitor in the oil rectification circuit had a visible burnt crack at the top portion of the device. A continuity check of the coil rectification circuit indicated an open circuit.



Figure 5 Agastat A1 Relay with Normally Open Contact Stuck Because of a Melted Contact Carrier

The unaged Agastat relays, A3 and A4, failed approximately 11 and 14 minutes into the exposure, respectively. In each case, the failures occurred early in the plateau period. The temperatures at the time of failure were 206 °C and 221 °C, respectively. The failure mode was similar to that of relay A2, namely, an open circuit in the coil rectification circuits. The capacitors did not display visible cracking as in A2.

Agastat unaged relays A5 and A6 failed approximately 11 and 12 minutes into the exposure, respectively. In each case, the failures occurred early in the plateau period. The temperatures at the time of failure were 215 °C in both cases. In each case the failures were traced to the bases. Post-test analysis revealed that a short had occurred between two terminal sockets in each base. The short caused each relay to fail.

Contact resistance measurements for all Agastat delays were typically below 70 mΩ. The highest recorded contact resistance for any relay was 86 mΩ. Load currents remained stable until failures were observed. Open contact leakage currents were generally erratic and provided limited information.

Failures for the Agastat relays were attributed to three failure modes: shorting of the base, failure of the built-in rectification circuit, or warpage of the contact carriers. The manufacturer recommended operating-temperature range for this relay is 0 °C to 60 °C. All the failures observed occurred at temperatures in excess of 200 °C.

The aged samples survived longer in the test environment than the unaged samples, which suggests that the aging protocol enhanced the relay's ruggedness. The aging process is suspected to have annealed the coil rectification circuit components, increasing their tolerance to thermal exposures.

4.2.2 General Electric HMA Results

The first aged relay, B1, was tested in the moderate profile and failed at the end of the cooldown portion of the exposure. The peak

exposure temperature was 352 °C, and the temperature at failure was 129 °C. The failure observed was associated with an armature actuation failure. Post-test analysis revealed that a substance, apparently released from the coil's spool, accumulated on the top of the coil and prevented the armature from actuating.

The second aged relay, B2, was tested in the severe profile and failed early in the plateau period. The temperature at the time of failure was 447 °C. The mode of failure was identical to that of relay B1.

The first unaged relay, B3, was tested in the moderate profile and failed midway through the plateau period. The temperature at the time of failure was 348 °C. The mode of failure was again associated with an armature failure. However, in this case a closer inspection revealed that the armature had fused to the relay's housing. The point of the fusing is shown in Figure 6. The armature arm was separated from the housing when slight pressure was applied. However, it still did not actuate freely because of warpage of the relay's housing.

The second unaged relay, B4, was tested in the mild profile. The relay survived the entire first phase of the exposure and failed during the second phase. The temperature at the time of failure was approximately 400 °C. The mode of failure was identical to that observed for relay B1.

These results showed that the aged specimens performed slightly better than the unaged specimens. Three of the four failures, including both of the aged and one of the unaged samples, were attributed to the accumulation of an unknown substance on top of the coil and under the armature. The fourth failure was attributed to fusing of the armature to the relay housing.

Contact resistance measurements for all GE HMA relays were typically below 60 mΩ. Load currents remained stable until failure was observed. Open contact leakage currents were generally under 0.1 amp until failure occurred.

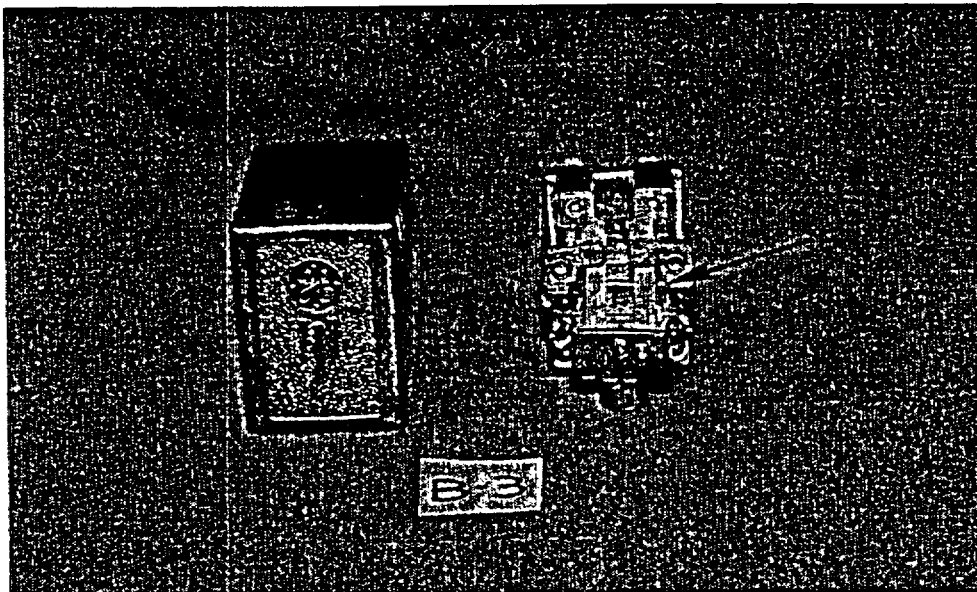

Figure 6 General Electric HMA Relay B-3 After Thermal Exposure

Note that during an earlier test program (Ref. 7) an HMA relay (without a cover) was also tested. During this test, failure occurred at approximately 400 °C. However, this failure was attributed to the external coil power lead wires shorting together, rather than to a failure in the relay itself. This failure also caused the lead wire to ignite, and the resulting fire destroyed the relay.

4.2.3 General Electric HGA Results

The first aged relay, C1, was tested in the moderate profile and failed during the late stages of the cool-down. The peak exposure temperature was 353 °C, and the temperature at the time of failure was approximately 150 °C.

(Note: Data during the cool-down portion of the exposure were not recorded because of a data logging error. The time of failure was recorded by the test operator, but the final temperature was not recorded. The temperature shown in Figure A-11 of Appendix A is an estimate based on other profiles.) The failure was caused by warpage of the top plate of the coil's spool, which curled upwards and

prevented the armature from actuating as shown in Figure 7. Note that this was the only instance in which this particular failure mode was observed.

Since the first aged relay, C1, failed on the cool-down before completing the first phase of the moderate exposure, a decision was made to deviate from the nominal testing protocol. In particular, the second aged relay, C2, was also tested in the moderate profile. This deviation was implemented in order to verify the results.

The second aged relay, C2, survived the first phase of the profile and failed during the second phase. At an exposure temperature of 480 °C, the specimen self-ignited. Shortly thereafter, failure of the relay was observed. The failure was associated with a loss of armature actuation capability. Inspection of the charred remains of the coil and the armature showed that the armature and coil had become fused together because of the accumulation of an unknown substance beneath the armature. (Recall that similar behavior was noted in three of the four HMA relays tested.)

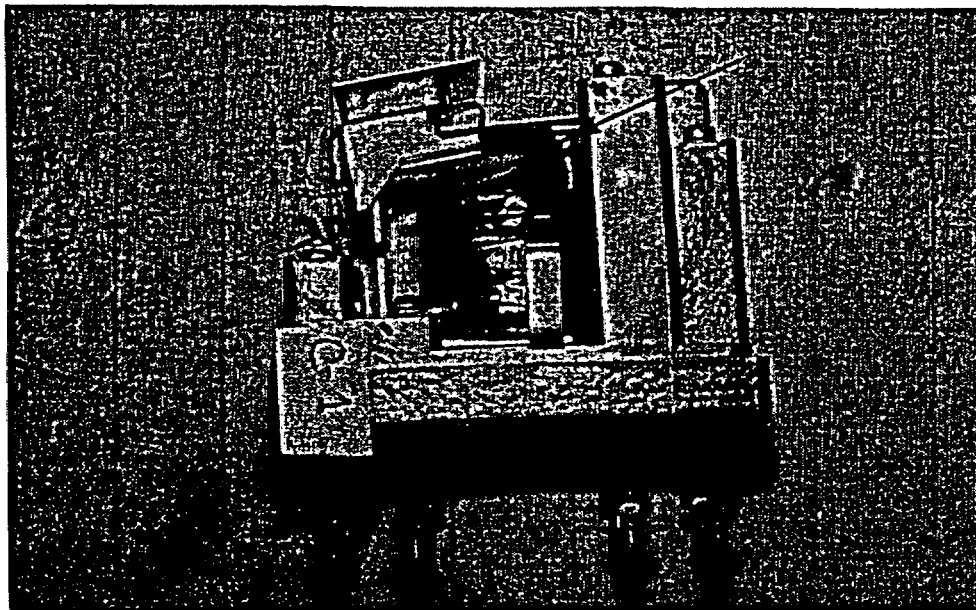

Figure 7 General Electric HGA Relay C-1 After Failure of the Spool's Top Plate

The first unaged relay, C3, was tested in the moderate profile and survived the entire first phase of the exposure. Failure was noted during the second phase at a temperature of 488 °C. Failure was attributed to the accumulation of an unknown substance underneath the armature on top of the coil's spool. This substance prevented the armature from actuating. (Note that similar failure mechanisms occurred for the two different coil designs, the GE HMA and GE HGA.)

The C3 relay was the first GE relay tested from among all relays. The control program used in this test was identical to that used for the Agastat tests. Because of the variation between the actual and the intended profile, the control program was modified to compensate for this variation. The variation can be observed by comparing Figure A-13 to A-11 or to A-12. The difference was determined to be caused by the controlling thermocouple's location relative to the chamber and the test specimen. The remaining relays were tested using the new control

program, which produced exposure profiles that were very similar to the desired exposure profiles.

The second unaged relay, C4, was tested in the severe profile and failed at the end of the plateau period. The temperature at the time of failure was 453 °C. The failure mode was identical to that of relay C3; namely, an accumulation of an unknown substance underneath the armature prevented the armature from actuating. This substance can be seen in Figure 8.

Based on the time to failure and final temperature, the two unaged relays appear to have performed slightly better than the aged relays, given these temperature profiles. However, the difference in the results for the aged and unaged relays is not significant.

Contact resistance measurements for all GE HGA relays were typically below 60 mΩ. Load currents remained stable until failure was observed. Open contact leakage currents were generally under 0.1 amp until failure occurred.

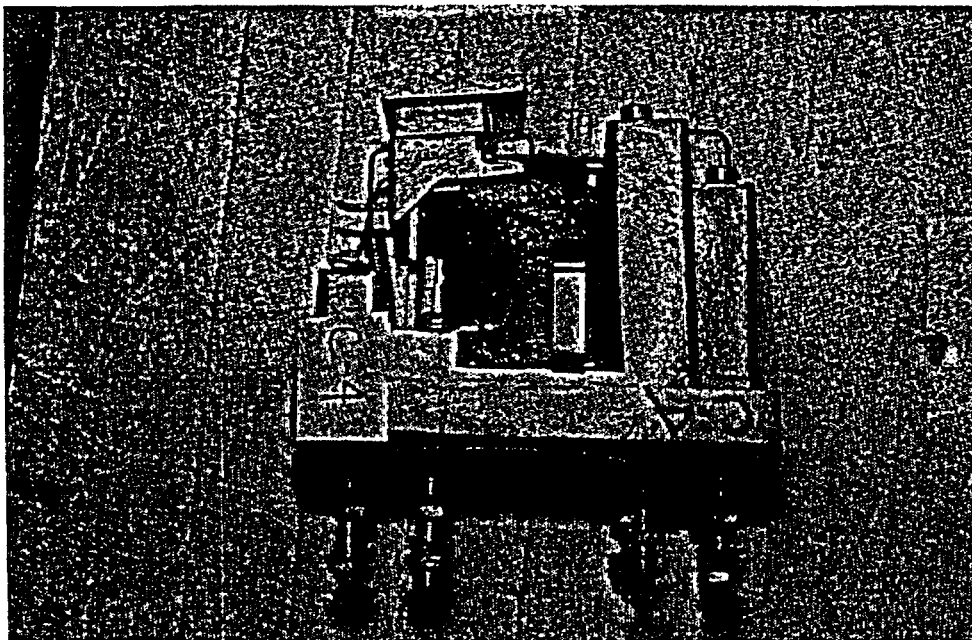

Figure 8 General Electric HGA Relay C-4 Failure of the Armature Because of Blockage

4.2.4 General Electric HFA Results

The first aged relay, D1, was tested in the moderate profile and failed early in the cool-down period. The peak exposure temperature was 359 °C, and the temperature at failure was 349 °C. The failure of two of the six contacts pairs was noted in load current measurements. Inspection showed that the armature was warped or bowed. This warpage was severe enough to prevent the closure of two of the six contact pairs. However, the coil remained functional during post-test analysis.

The second aged relay, D2, was tested in the mild profile. The relay survived the first phase of the exposure and failed during the second phase at a temperature of 485 °C. The failure was attributed to severe deformation of the relay body. The relay's components were misaligned, and the armature movement was not free enough to complete contact (make or break).

Relay D3 was tested in the moderate profile and failed midway through the cool-down. The peak exposure temperature was 348 °C, and

the temperature at failure was 298 °C. The mode of failure was similar to relay D1.

Relay D4 was tested in the severe profile and failed midway through the plateau. At an exposure temperature of approximately 450 °C, the specimen self-ignited. Shortly thereafter, failure of the relay was observed. The ensuing fire destroyed the relay.

The final relay tested was D5. It was tested in the mild environment. The relay survived the first phase of the exposure and failed during the second phase at a temperature of 440 °C. The test data indicated that the coil did not actuate when power was applied. However, post-test analysis did not find any problems with the coil or the armature. The armature was slightly misaligned and slightly warped, but the contacts were all making contact. The exact cause of the failure was not evident, but when the coil was energized, the relay hummed and chattered loudly. On one subsequent energization, the armature failed to actuate. Hence it was concluded that this relay was subject to an intermittent failure.

These results indicate that the aged and unaged relays behaved quite similarly under the given test conditions. The results of the aged and unaged HFA relays suggest that the relays will most likely survive in a fire with an exposure similar to the mild profile. Survival in fires corresponding to the moderate and severe profiles is doubtful.

Contact resistance measurements for all GE HFA relays were typically below 90 mΩ. Load currents remained stable until failure was observed. Open contact leakage currents were

erratic but generally under 0.2 amp until failure occurred.

All of the relays tested showed signs of deformation of the relay body. Many of the outer shells were cracked. Most of the relay bodies were also bowed or warped, as can be seen in Figure 9. The deformation of the relay body was evident in each of the GE HFA relays, with some more severe than others. The failures for four of the GE HFA relays were attributed to warpage of the armature.

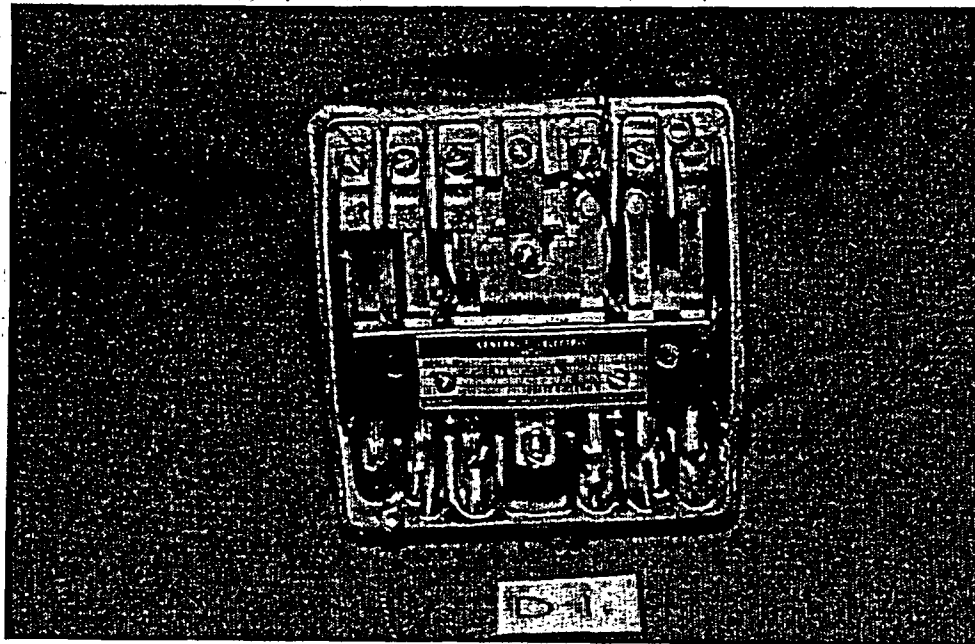

Figure 9 General Electric HFA Relay D-1 After Thermal Exposure

| Table 2 Overall Relay Test Results | | | | | | | | |
|---|----------------|----------|------------|--------------------|-------------------------|-----------------------|-----------------------------|---|
| Relay # | Aged or Unaged | Profile | Test Order | Survived 1st phase | Time of Failure (hh:mm) | Peak Temperature (°C) | Temperature at Failure (°C) | Failure Mode |
| Agastat A1 | Aged | Mild | 5 | Yes | 01:04 | 250.4 | 250.4 | Stuck contact & Base shorted |
| Agastat A2 | Aged | Mild | 6 | No | 00:24 | 241.1 | 209.7 | Rectification circuit failure |
| Agastat A3 | Unaged | Mild | 1 | No | 00:11 | 206.4 | 206.4 | Rectification circuit failure |
| Agastat A4 | Unaged | Mild | 2 | No | 00:13 | 220.7 | 220.7 | Rectification circuit failure |
| Agastat A5 | Unaged | Mild | 3 | No | 00:11 | 214.4 | 214.4 | Base shorted |
| Agastat A6 | Unaged | Mild | 4 | No | 00:12 | 214.5 | 214.5 | Base shorted |
| GE HMA B1 | Aged | Moderate | 13 | Yes | 00:49 | 352.4 | 129.1 | Armature failed to actuate |
| GE HMA B2 | Aged | Severe | 14 | No | 00:23 | 446.9 | 446.9 | Armature failed to actuate |
| GE HMA B3 | Unaged | Moderate | 11 | No | 00:20 | 348.2 | 348.2 | Armature fused to side of relay |
| GE HMA B4 | Unaged | Mild | 12 | Yes | 01:19 | 402.9 | 402.9 | Armature failed to actuate |
| GE HGA C1 | Aged | Moderate | 9 | No | 00:43* | 352.6* | 150* | Armature blocked by warped top coil plate |
| GE HGA C2 | Aged | Moderate | 10 | Yes | 01:38 | 745.6** | 551.9** | Armature blocked, relay destroyed |
| GE HGA C3 | Unaged | Moderate | 7 | Yes | 01:40 | 487.7 | 487.7 | Armature failed to actuate |
| GE HGA C4 | Unaged | Severe | 8 | No | 00:36 | 453.4 | 453.2 | Armature failed to actuate |
| GE HFA D1 | Aged | Moderate | 18 | No | 00:31 | 358.9 | 348.7 | Armature warped |
| GE HFA D2 | Aged | Mild | 19 | Yes | 01:26 | 484.7 | 484.7 | Armature warped |
| GE HFA D3 | Unaged | Moderate | 15 | No | 00:34 | 348.2 | 297.5 | Armature warped |
| GE HFA D4 | Unaged | Severe | 17 | No | 00:34 | 563.8** | 563.8** | Completely destroyed by fire |
| GE HFA D5 | Unaged | Mild | 16 | Yes | 01:23 | 440.0 | 440.4 | Intermittent Failure |
| *Exact time and temperature of failure not recorded because of a data logging error. Failure occurred during cool-down ramp at the listed estimated time and temperature. | | | | | | | | |
| **Temperatures are higher than expected because the relay's materials ignited and burned. | | | | | | | | |

5 CONCLUSIONS

This test program assessed the impact of operational and thermal aging on the thermal vulnerability of relays. The relays evaluated were Agastat GPI, General Electric HMA, General Electric HGA, and General Electric HFA. At least two relays of each type were tested in an unaged condition and at least two relays of each type were artificially aged before testing. The aged samples were operationally aged by cycling the relay under rated load for 2000 operations. These relays were then subjected to thermal aging for 60 days at a temperature of 110 °C with their coils energized.

Thermal exposure testing was conducted in SNL's Severe Combined Environments Test Chamber (SCETCH). Three exposure profiles were developed for this test program. These profiles were representative of generic mild, moderate, or severe thermal exposures, respectively.

The Agastat GPI relay results indicated that most relays would not survive in a mild exposure (250 °C) environment. However, the aged samples survived longer than the unaged samples. Failures were generally traced to the coil rectification circuit. However, failures in the base socket were also encountered.

The GE HMA and GE HGA failures were generally attributed to failure of the armature to actuate properly. For both relay types, most of the failures were attributed to an accumu-

lated substance that formed on the top plate of the coil's spool just below the armature. One GE HMA relay failure was attributed to the armature becoming fused to the relay's housing. One GE HGA relay failure was caused by the armature failing to actuate because the top plate of the coil had curled upwards, preventing movement of the armature. Aging was not a significant factor in any of the failures.

The GE HFA relay failures were generally caused by warpage of the armature arm. This warpage prevented certain contacts from fully engaging. One GE HFA displayed an intermittent coil actuation failure. All of the relays tested exhibited severe distortion of the relay body. Aging was not a significant factor in the failures.

In general, the conclusion is that the effect of aging on the fire vulnerability of relays appears to be insignificant. Depending on the relay type, the effect of exposure to even mild temperature excursions (>200 °C) may affect relay integrity independent of the relay's age.

Note that a relay may function properly at a high temperature for a period of time and subsequently fail upon cooling. This was observed in four of the relays tested in this program (one sample from each relay type). The most common failure mode observed was failure of the armature to actuate on command because of blockage or warpage.

6 REFERENCES

1. Lowry, W. and Vigil, R. A., "Prioritization of Reactor Control Components Susceptible to Fire Damage as a Consequence of Aging," NUREG/CR-6103, SAND93-7107, Science & Engineering Associates, Inc., for Sandia National Laboratories, January 1994.
2. Toman, G. J., Bacanskas, V. P., Shook, T. A. and Ladlow, C. C., "An Aging Assessment of Relays and Circuit Breakers and System Interactions," Franklin Research Center, NUREG/CR-4715 (BNL-NUREG-52017), June 1987.
3. Lambright, J. A., Nowlen, S. P., Nicolette, V. F., and Bohn, M. P., "Fire Risk Scoping Study: Investigation of Nuclear Power Plant Fire Risk, including Previously Unaddressed Issues," NUREG/CR-5088, SAND88-0177, Sandia National Laboratories, January 1989.
4. Cline, D. D., von Rieseemann, W. A., Chavez, J. M., "Investigation of Twenty-Foot Separation Distance as a Fire Protection Method as Specified in 10 CFR Part 50, Appendix R," NUREG/CR-3192, SAND83-0306, Sandia National Laboratories, October 1983.
5. Nowlen, S. P., "Enclosure Environment Characterization Testing for the Base Line Validation of Computer Fire Simulation Codes," NUREG/CR-4681, Sandia National Laboratories, March 1987.
6. Chavez, J. M., Nowlen, S. P. "An Experimental Investigation of Internally Ignited Fires in Nuclear Power Plant Control Cabinets: Part 1: Cabinet Effects Test, Part 2: Room Effects Test, Part 2: Room Effects Tests," NUREG/CR-4527, Vols. 1 and 2, SAND86-0336, Vols. 1 and 2, Sandia National Laboratories, April 1987 and November 1988.
7. Jacobus, M. J., "Screening Tests of Representative Nuclear Power Plant Components Exposed to Secondary Environments Created by Fires," NUREG/CR-4596, SAND86-0394, June 1986.

APPENDIX A

**SCETCH TEMPERATURE EXPOSURE PLOTS
FOR ALL RELAYS TESTED**

INTRODUCTION

In this appendix, the temperature exposure profiles are shown for each relay tested. Each figure contains the desired profile (mild, moderate, or severe) and the actual temperature profile. Note that the relays were

tested in the order listed in Table 2 in the report. The thermal exposures were performed in Sandia National Laboratories' Severe Combined Environments Test Chamber (SCETCH).

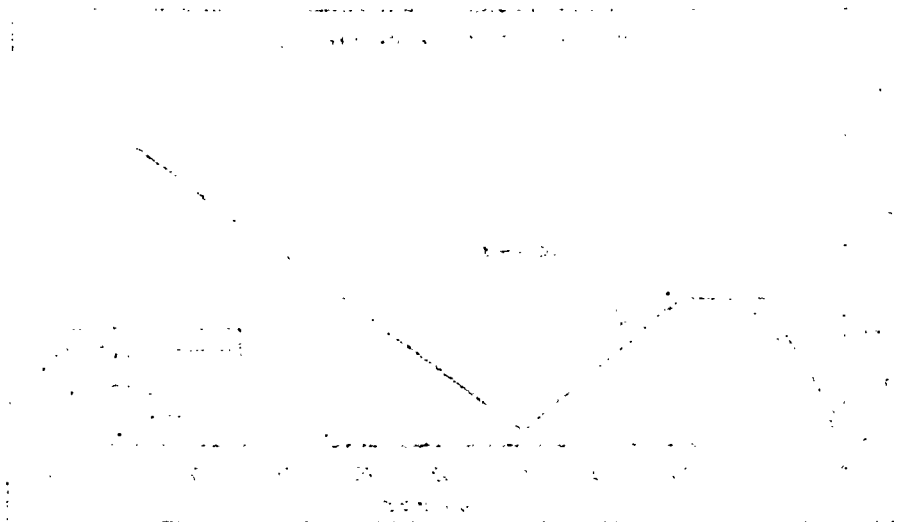

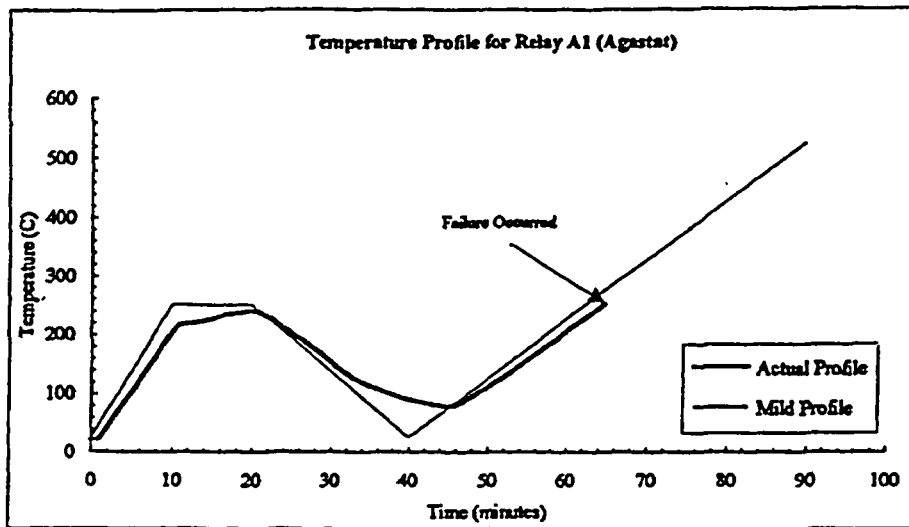

Figure A-1 SCETCH temperature exposure for relay A1

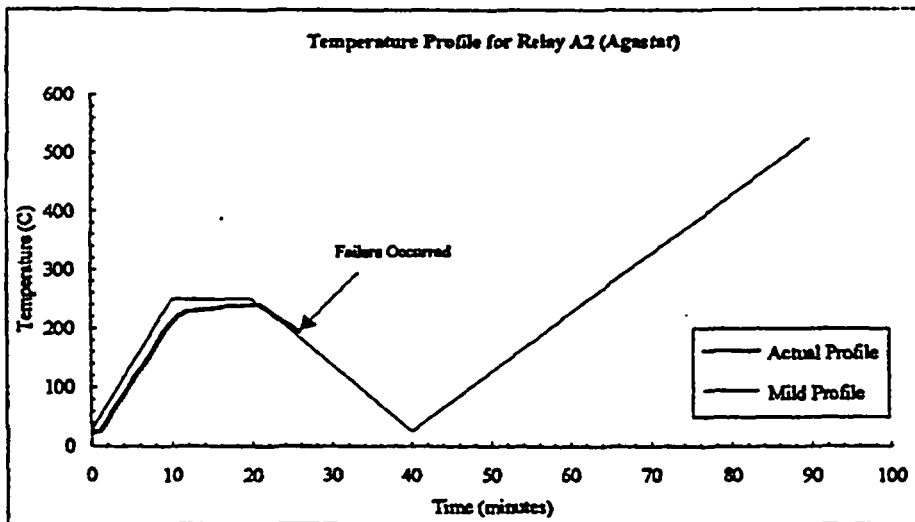

Figure A-2 SCETCH temperature exposure for relay A2

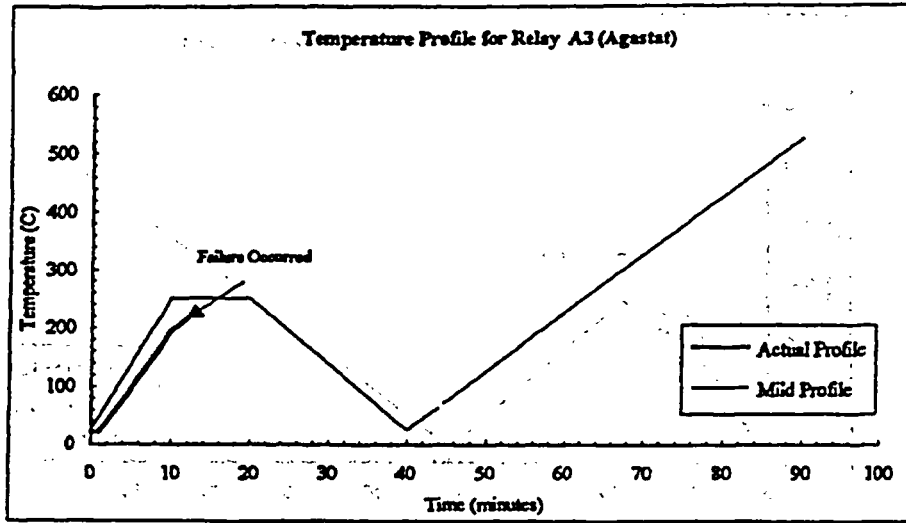

Figure A-3 SCETCH temperature exposure for relay A3

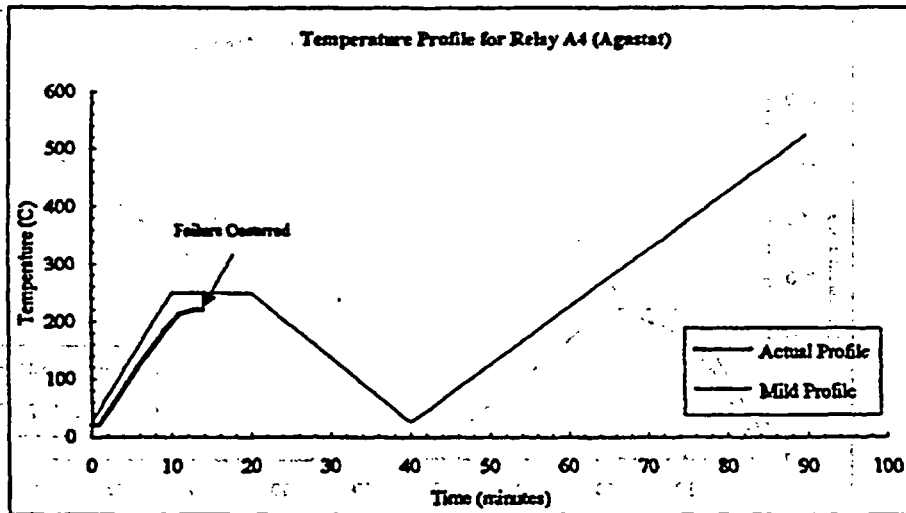

Figure A-4 SCETCH temperature exposure for relay A4

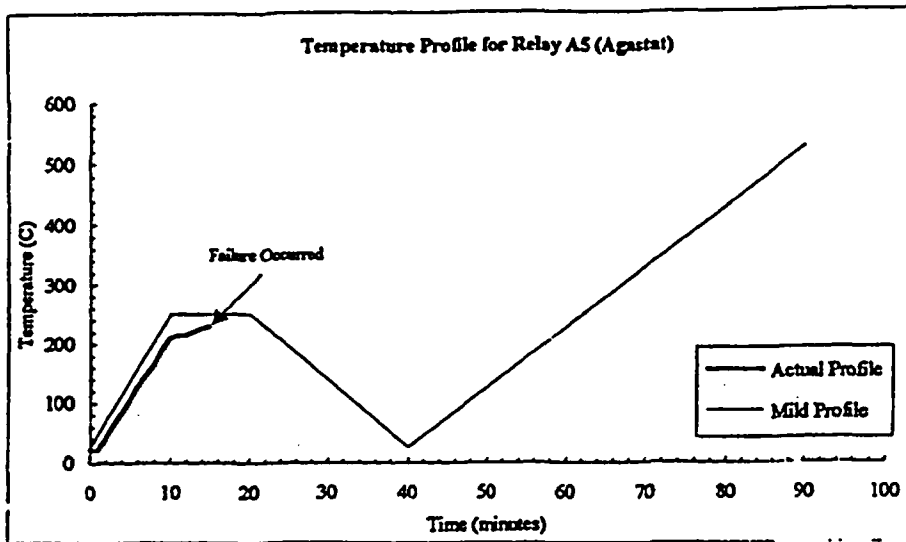

Figure A-5 SCETCH temperature exposure for relay A5

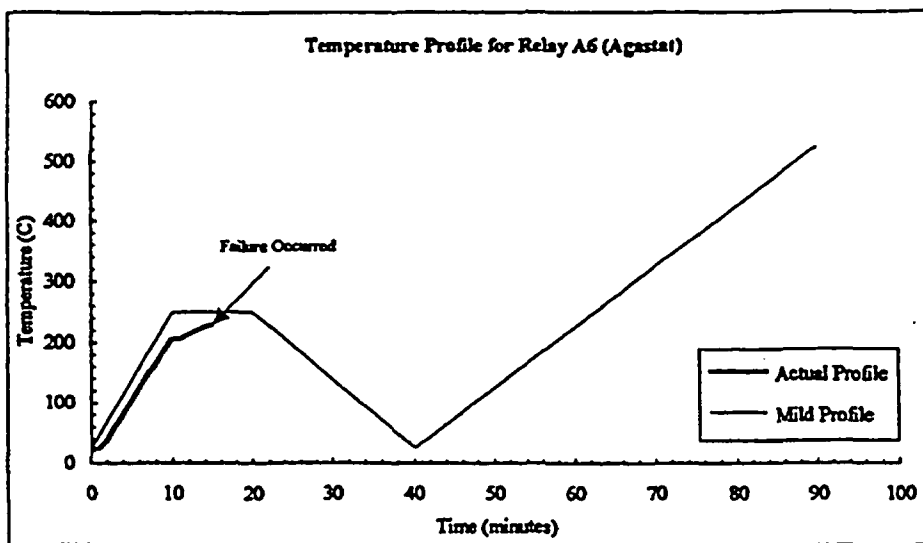

Figure A-6 SCETCH temperature exposure for relay A6

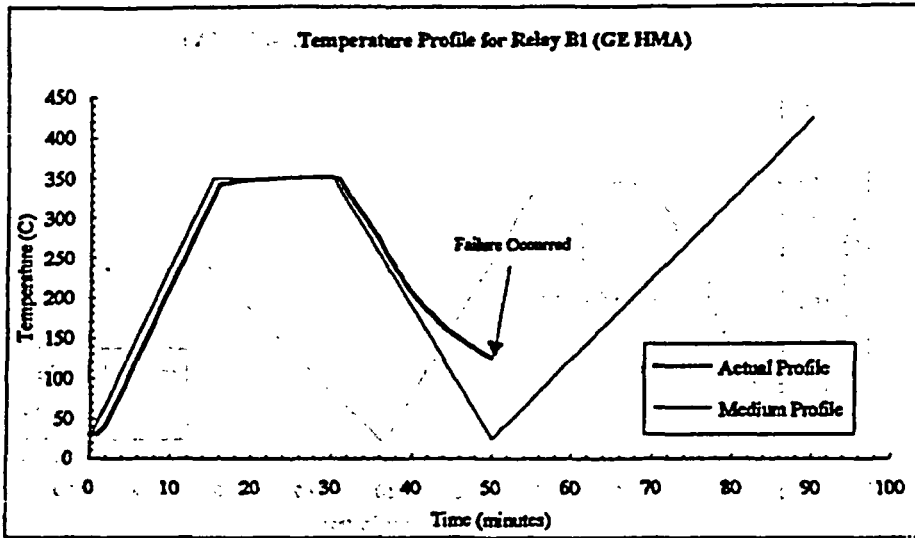

Figure A-7 SCETCH temperature exposure for relay B1

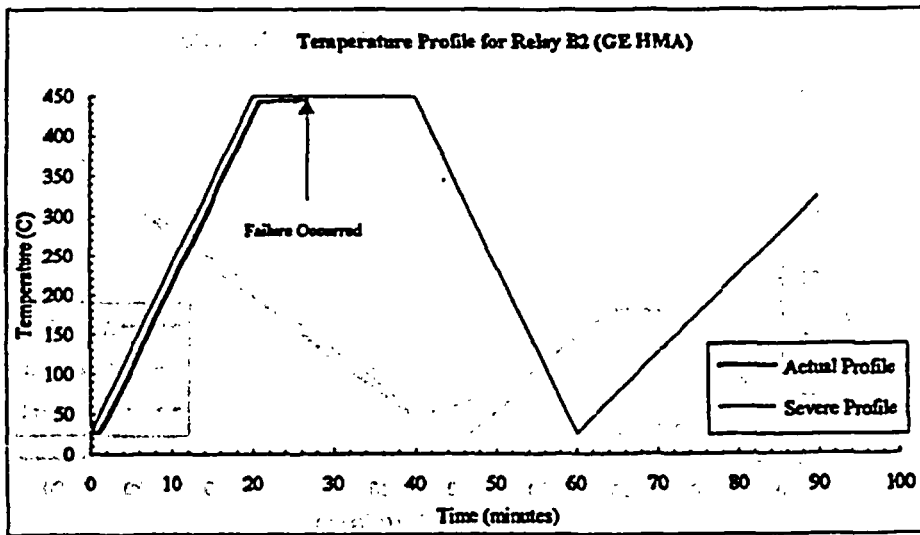

Figure A-8 SCETCH temperature exposure for relay B2

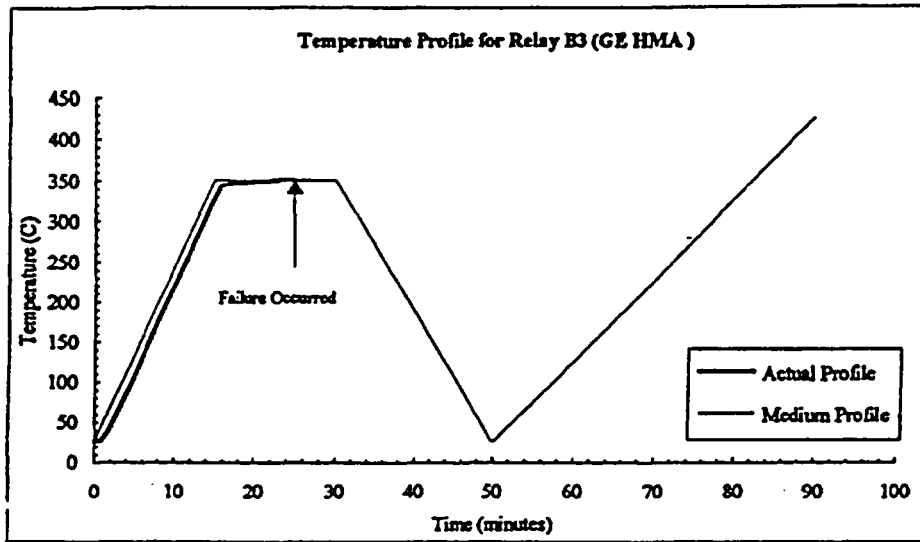

Figure A-9 SCETCH temperature exposure for relay B3

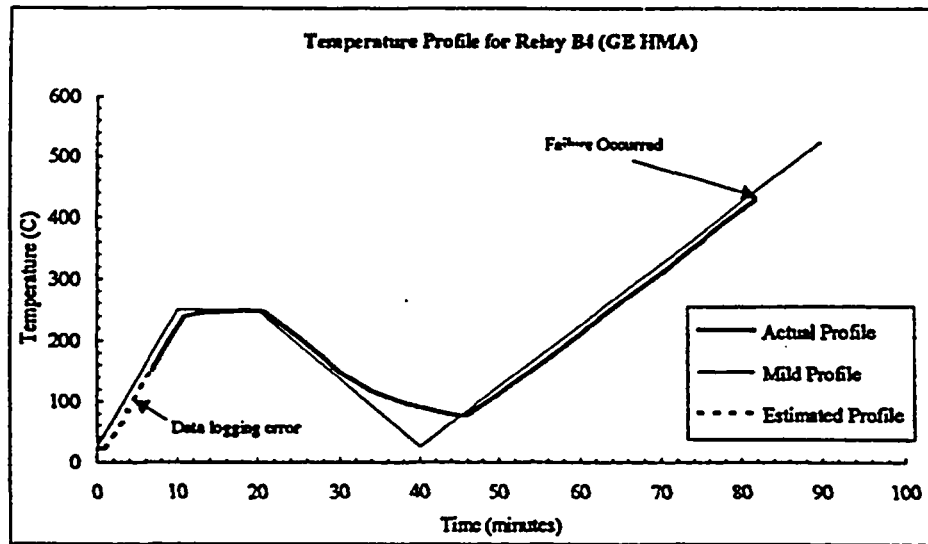

Figure A-10 SCETCH temperature exposure for relay B4

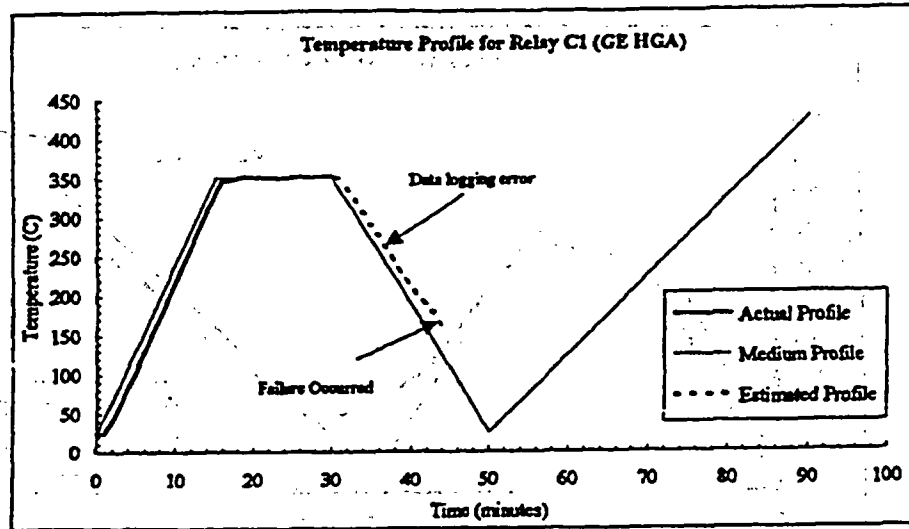

Figure A-11 SCETCH temperature exposure for relay C1

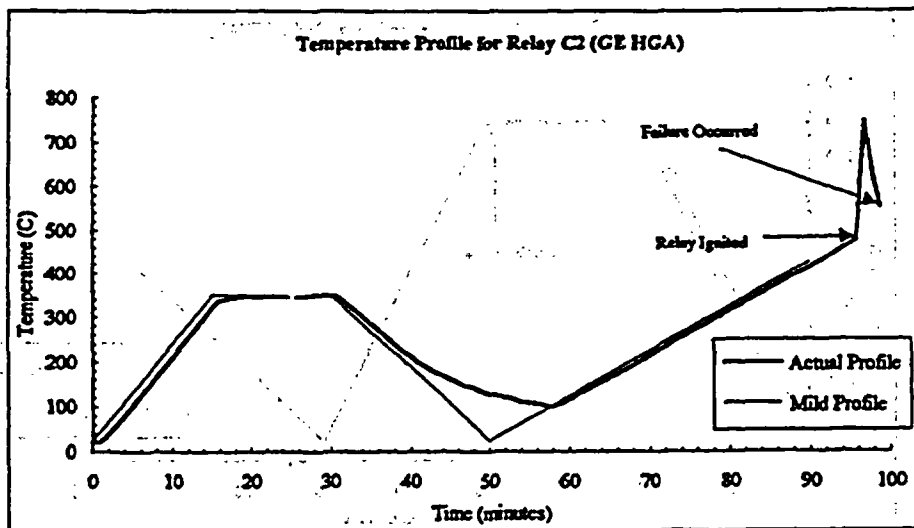

Figure A-12 SCETCH temperature exposure for relay C2

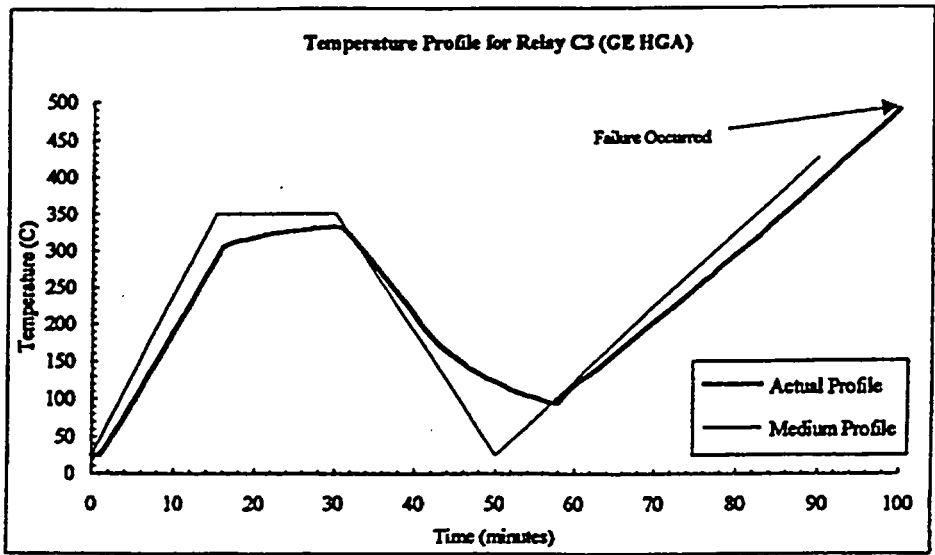

Figure A-13 SCETCH temperature exposure for relay C3

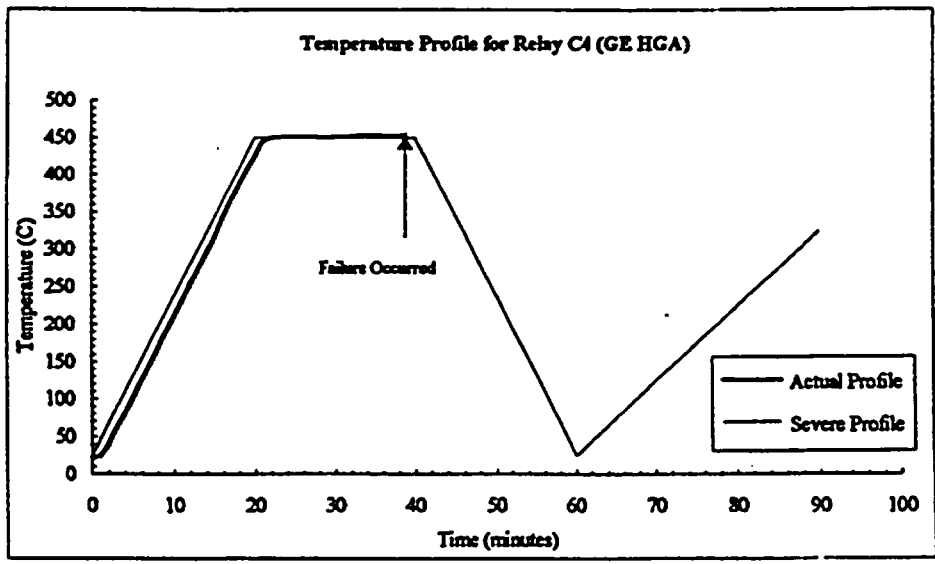

Figure A-14 SCETCH temperature exposure for relay C4

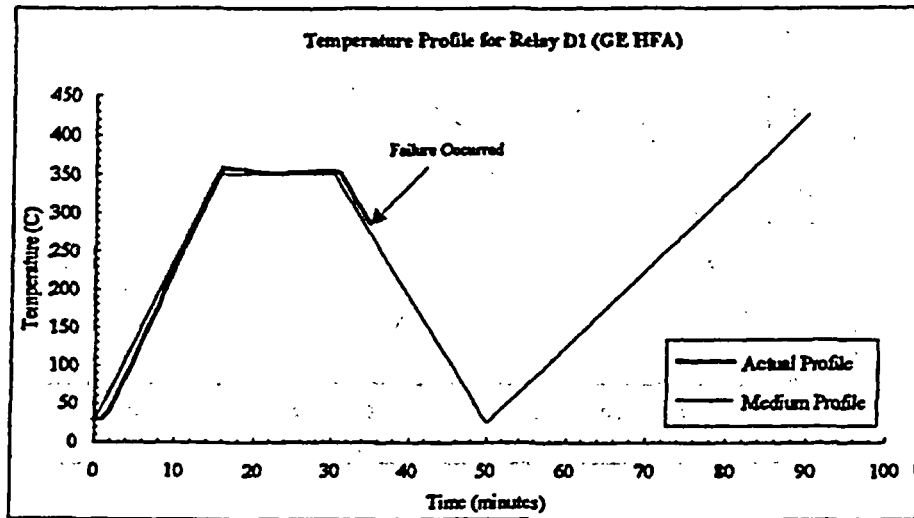

Figure A-15 SCETCH temperature exposure for relay D1

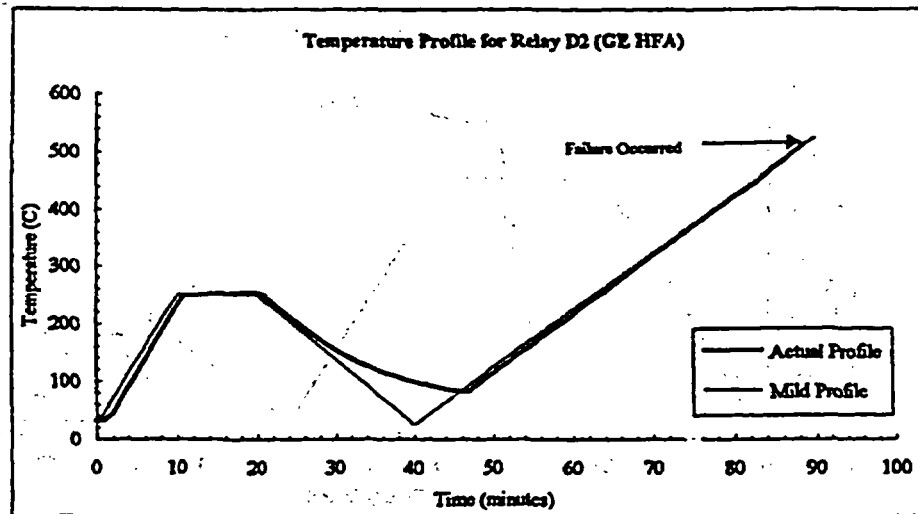

Figure A-16 SCETCH temperature exposure for relay D2

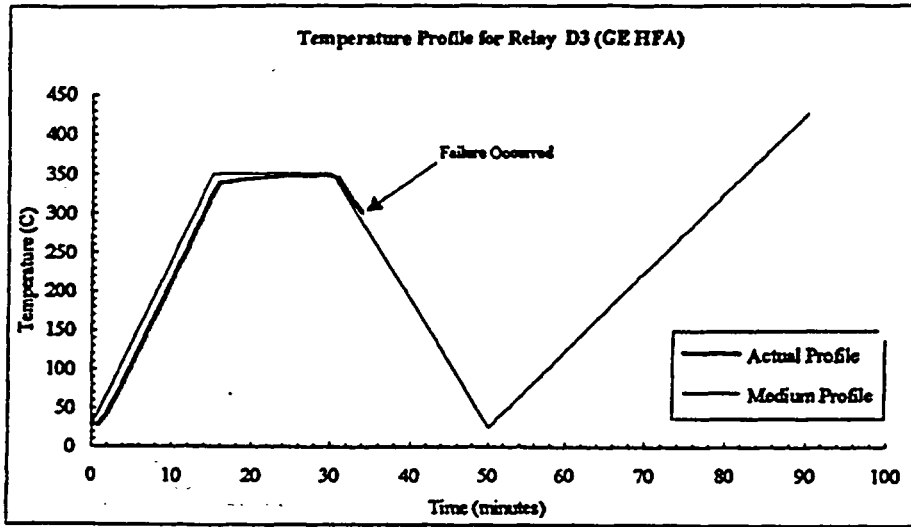

Figure A-17 SCETCH temperature exposure for relay D3

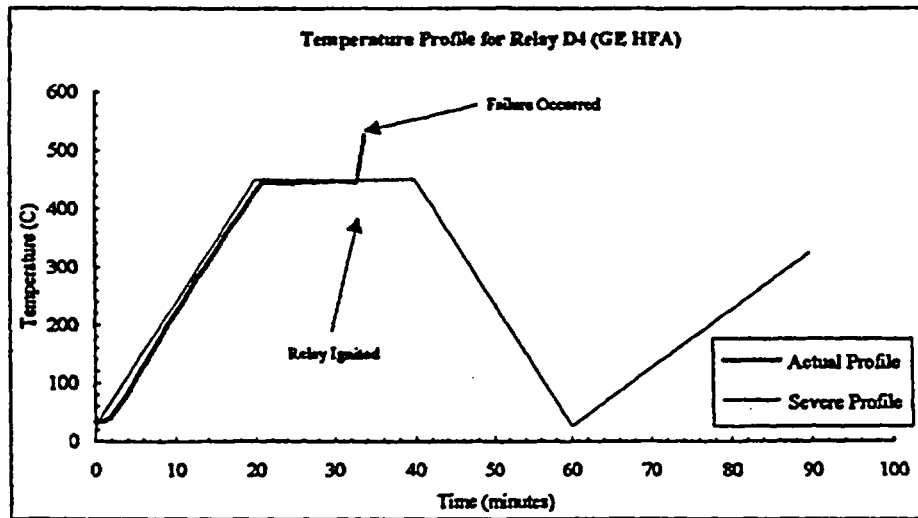

Figure A-18 SCETCH temperature exposure for relay D4

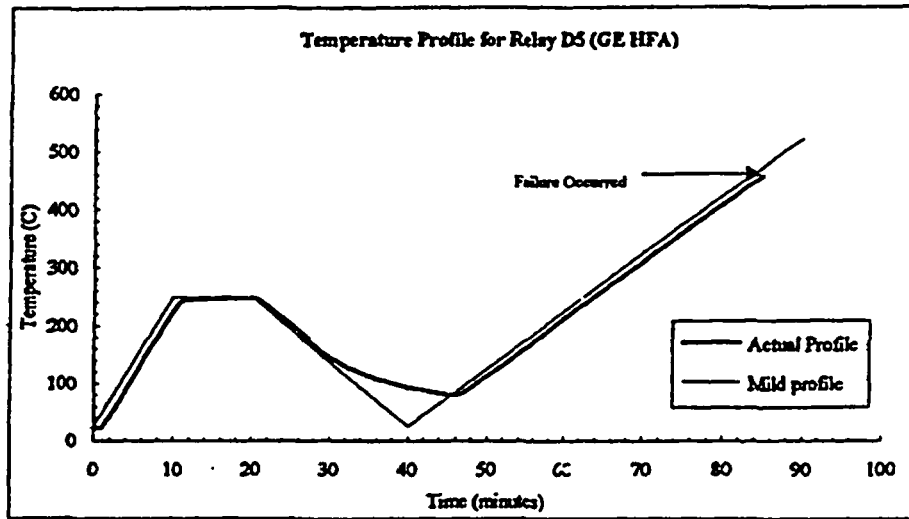

Figure A-19 SCETCH temperature exposure for relay D5

APPENDIX B

GLOSSARY

GLOSSARY

um—a micron, one millionth of a meter.

uW—a microwatt, one millionth of a watt (a unit of power).

angle of incidence—the angle that a ray of light falling on a surface makes with a perpendicular to the surface at the point of incidence.

angle of reflection—the angle between a reflected ray of light and a perpendicular to the surface at the point of reflection.

attenuation—reduction of signal magnitude, or loss, normally measured in decibels (dB).

avalanche photodiode (APD)—one of two semiconductor devices commonly used to detect light signals and convert them to electrical signals. The APD can detect very faint light. The other device is the PIN diode.

bandwidth—the difference between the high and low frequencies of a transmission band. With regard to light signals, the highest frequency that can be transmitted in analog operation.

bandwidth-length product—the measure of a fiber's ability to transmit high-speed signals, stated in MHz-km. It is influenced by modal dispersion. The bandwidth-length product is used to determine the bandwidth of a particular length of fiber by dividing the length into the bandwidth-length product.

biconic connector—a threaded fiber-optic connector used in high-speed telecommunications. It is designed to bring two fiber ends into physical contact, minimizing loss.

bit—a binary digit, the smallest unit of information in a binary system of notation.

bit rate—the rate, or speed, at which bits (binary digits) are transmitted (e.g., bits per second).

buffer—the protective coating that covers an optical fiber.

chromatic dispersion—pulse spreading caused by variation in light propagation with wavelength. Units are picoseconds (of dispersion) per kilometer (of fiber length) per nanometer (of source spectral width). Laser sources minimize this effect due to their narrow spectral width.

cladding—the reflective outer layer of an optical fiber that surrounds the light-carrying core. The cladding retains the light in the core and allows the fiber to guide light from one end to the other. The cladding has a lower index of refraction than the core.

disintegration per minute (dpm)—a unit of activity commonly used in laboratory work because it is convenient for expressing the quantities typically used. One curie equals 2.22×10^{12} dpm ($1 \text{ dpm} = 1.67 \times 10^{-2} \text{ Bq}$).

dose rate—the absorbed dose delivered per unit time.

effective dose equivalent (H_E)—the sum of the products of the dose equivalent to the organ or tissue (H_T) and the weighting factors (W_T) applicable to each of the body organs or tissues that are irradiated.

exposure—being exposed to ionizing radiation or to radioactive material.

gamma ray—short-wave length electromagnetic radiation of nuclear origin emitted from the nucleus.

Geiger-Mueller counter—a gas-filled radiation-detection device that is highly sensitive.

labelling (radiolabelling)—a procedure in which one or more radioactive atoms are attached to a molecule or compound in order to follow the compound or its fragments through physical, chemical, or biological processes by observing the radioactivity.

liquid scintillation counting—the detection of light emissions (scintillation) resulting from

decay of radioactive material immersed in a special chemical mixture.

metric prefixes—prefixes used with metric units to express numbers in a convenient form.

| | |
|-----------------------------|-------------------|
| micro (μ) = 10^{-6} | mega (M) = 10^6 |
| milli (m) = 10^{-3} | giga (G) = 10^9 |
| kilo (k) = 10^3 | |

phantom—a device used to approximate a human body for the calibration and adjustment of radiation-measuring instruments

public dose—the dose received by a member of the public from exposure to radiation and to radioactive material released by a licensee, or to another source of radiation either within a licensee's controlled area or in an unrestricted area. It does not include occupational dose or dose received from background radiation, as a patient from medical practices, or from voluntary participation in medical research programs.

quality assurance (QA)—planned and systematic actions to ensure the accuracy of measurements.

quality control (QC)—routine inspections and tests to verify the continued accuracy of the measurements.

radioactive decay—the disintegration of the nucleus of an unstable nuclide by spontaneous emission of charged particles and/or photons.

radioactive half-life—the time required for a radioactive substance to lose 50 percent of its activity by decay.

radionuclide—a radioactive nuclide; a nuclide is characterized by the number of protons and the number of neutrons in its nucleus.

Standard Man—a person with the anatomical and physiological characteristics defined in the report of the ICRP Task Group on Reference Man (ICRP Publication 23).

sievert—the SI unit of any of the quantities expressed as dose equivalent. The dose equivalent in sieverts is equal to the absorbed dose in grays multiplied by the quality factor (1 Sv = 100 rems).

survey—an evaluation of the radiological conditions and potential hazards incident to the production, use, transfer, release, disposal, or presence of radioactive material or other sources of radiation.

total effective dose equivalent (TEDE)—the sum of the deep-dose equivalent (for external exposures) and the committed effective dose equivalent (for internal exposures).

Type A specific license of broad scope—a specific license of broad scope authorizes a wide range of radionuclides in any chemical or physical form for a variety of purposes. A Type A licensee is required to establish a radiation protection committee.

void—verb: to evacuate urine; noun: the entire volume of body waste eliminated in a particular time.

whole-body counting—to measure directly the radiation emitted from radioactive material deposited in the organs and tissues of a body, using one or more radiation detectors to scan the entire body or a large fraction of the body. A variety of detector systems are used for whole-body counting.

wipe test—an evaluation of removable contamination on a surface or object, wherein an absorbent material such as paper is rubbed across a surface and subsequently analyzed for radioactivity by a counting instrument.

| | | | | | | |
|--|--|---|--|---|-----|------|
| NRC FORM 335 (2-89) NRCM 1102, 3201, 3202 | U.S. NUCLEAR REGULATORY COMMISSION BIBLIOGRAPHIC DATA SHEET (See instructions on the reverse) | 1. REPORT NUMBER (Assigned by NRC, Add Vol., Supp., Rev., and Addendum Numbers, if any.) NUREG/CR-6220 SAND94-0769 | | | | |
| 2. TITLE AND SUBTITLE An Assessment of Fire Vulnerability for Aged Electrical Relays | 3. DATE REPORT PUBLISHED | <table border="1"> <tr> <td style="text-align: center;">MONTH</td> <td style="text-align: center;">YEAR</td> </tr> <tr> <td style="text-align: center;">May</td> <td style="text-align: center;">19XX</td> </tr> </table> | MONTH | YEAR | May | 19XX |
| | MONTH | YEAR | | | | |
| | May | 19XX | | | | |
| 4. FIN OR GRANT NUMBER A1833 | | | | | | |
| 5. AUTHOR(S) R. A. Vigil,* S. P. Nowlen | 6. TYPE OF REPORT Technical | 7. PERIOD COVERED (Inclusive Dates) | | | | |
| | 8. PERFORMING ORGANIZATION - NAME AND ADDRESS (If NRC, provide Division, Office or Region, U.S. Nuclear Regulatory Commission, and mailing address; if contractor, provide name and mailing address.) <table style="width: 100%;"> <tr> <td style="width: 50%; vertical-align: top;"> Sandia National Laboratories Albuquerque, NM 87185-0737 </td> <td style="width: 50%; vertical-align: top;"> *Science & Engineering Associates, Inc. 6100 Uptown Blvd. NE Albuquerque, NM 87110 </td> </tr> </table> | | Sandia National Laboratories Albuquerque, NM 87185-0737 | *Science & Engineering Associates, Inc. 6100 Uptown Blvd. NE Albuquerque, NM 87110 | | |
| Sandia National Laboratories Albuquerque, NM 87185-0737 | *Science & Engineering Associates, Inc. 6100 Uptown Blvd. NE Albuquerque, NM 87110 | | | | | |
| 9. SPONSORING ORGANIZATION - NAME AND ADDRESS (If NRC, type "Same as above"; if contractor, provide NRC Division, Office or Region, U.S. Nuclear Regulatory Commission, and mailing address.) Division of Engineering Office of Nuclear Regulatory Research U.S. Nuclear Regulatory Commission Washington, DC 20555-0001 | | | | | | |
| 10. SUPPLEMENTARY NOTES John E. Doe, NRC Project Manager | | | | | | |
| 11. ABSTRACT (200 words or less) <p>This report describes testing to assess the impact of aging on the fire vulnerability of Agastat and General Electric relays. Both aged and unaged relays were tested. Aged relays were subjected to operational cycling under rated load and thermally aged for 60 days. All relays were exposed to one of three different fire temperature profiles in the Severe Combined Environments Test Chamber located at Sandia National Laboratories. The ability to operate properly in the given fire environment was monitored. Results for the aged and unaged relays were examined to determine the impact of aging on the relays' ability to sustain operation under the test conditions. Overall results indicated that the aged relays' performance was not significantly different from that of the unaged relays.</p> | | | | | | |
| 12. KEY WORDS/DESCRIPTORS (List words or phrases that will assist researchers in locating the report.) Aging Relays Fire vulnerability | 13. AVAILABILITY STATEMENT Unlimited | 14. SECURITY CLASSIFICATION (This Page) | | | | |
| | Unclassified (This Report) | 15. NUMBER OF PAGES | | | | |
| | 16. PRICE | | | | | |

BIBLIOGRAPHIC DATA SHEET

(See instructions on the reverse)

1. REPORT NUMBER
(Assigned by NRC, Add Vol., Supp., Rev.,
and Addendum Numbers, if any.)

NUREG-0650, Rev. 2

2. TITLE AND SUBTITLE

Preparing NUREG-Series Publications

3. DATE REPORT PUBLISHED

| MONTH | YEAR |
|---------|------|
| January | 1999 |

4. FIN OR GRANT NUMBER

5. AUTHOR(S)

6. TYPE OF REPORT

7. PERIOD COVERED *(Inclusive Dates)*

8. PERFORMING ORGANIZATION - NAME AND ADDRESS *(If NRC, provide Division, Office or Region, U.S. Nuclear Regulatory Commission, and mailing address; if contractor, provide name and mailing address.)*

Information Management Division
Office of the Chief Information Officer
U. S. Nuclear Regulatory Commission
Washington, DC 20555-0001

9. SPONSORING ORGANIZATION - NAME AND ADDRESS *(If NRC, type "Same as above"; if contractor, provide NRC Division, Office or Region, U.S. Nuclear Regulatory Commission, and mailing address.)*

10. SUPPLEMENTARY NOTES

Juanita F. Beeson, Project Manager

11. ABSTRACT *(200 words or less)*

The guidance in this publication is for the staff and contractors who prepare manuscripts to be published in the NUREG series for the U.S. Nuclear Regulatory Commission (NRC). This revision 2 to NUREG-0650, "Publishing Documents in the NUREG Series," is retitled "Preparing NUREG-Series Publications. It gives more concise and up-to-date guidance, including certain Internet and World Wide Web addresses. It describes how to cite references to electronic information and, in addition, refers the NRC staff to online style guidance for Web site publishing.

12. KEY WORDS/DESCRIPTORS *(List words or phrases that will assist researchers in locating the report.)*

NUREG-series publications
NRC publications in the NUREG series
report guidance
report style
reports

13. AVAILABILITY STATEMENT

unlimited

14. SECURITY CLASSIFICATION

(This Page)

unclassified

(This Report)

unclassified

15. NUMBER OF PAGES

16. PRICE



Federal Recycling Program