



Appendix J

Transportation

<u>Section</u>	<u>Page</u>
J.2 Evaluation of Rail and Intermodal Transportation	J-74
J.2.1 Legal-Weight Truck Casks on Railcars Scenario	J-74
J.2.2 Large-Scale Barge Scenario	J-75
J.2.3 Effects of Using Dedicated Trains or General Freight Service	J-76
J.2.4 Impacts of the Shipment of Commercial Spent Nuclear Fuel by Barge and Heavy-Haul Truck from 24 Sites Not Served by a Railroad	J-76
J.2.4.1 Routes for Barges and Heavy-Haul Trucks	J-76
J.2.4.2 Analysis of Incident-Free Impacts for Barge and Heavy-Haul Truck Transportation	J-77
J.2.4.2.1 Radiological Impacts of Incident-Free Transportation	J-77
J.2.4.2.2 Nonradiological Impacts of Incident-Free Transportation	J-85
J.2.4.3 Analysis of Impacts of Accidents for Barge and Heavy-Haul Truck Transportation	J-85
J.2.4.3.1 Radiological Impacts of Accidents	J-85
J.2.4.3.2 Nonradiological Accident Risks	J-85
J.2.4.3.3 Maximum Reasonably Foreseeable Accidents	J-87
J.3 Nevada Transportation	J-87
J.3.1 Transportation Modes, Routes, and Number of Shipments	J-88
J.3.1.1 Routes in Nevada for Legal-Weight Trucks	J-88
J.3.1.2 Highway and Rail Routes in Nevada for Transporting Rail Casks	J-88
J.3.1.3 Sensitivity of Analysis Results to Routing Assumptions	J-99
J.3.2 Analysis of Incident-Free Transportation in Nevada	J-116
J.3.3 Analysis of Transportation Accident Scenarios in Nevada	J-116
J.3.3.1 Intermodal Transfer Station Accident Methodology	J-116
J.3.4 Impacts in Nevada from Incident-Free Transportation for Inventory Modules 1 and 2	J-119
J.3.4.1 Mostly Legal-Weight Truck Scenario	J-119
J.3.4.2 Nevada Rail Implementing Alternatives	J-121
J.3.4.3 Nevada Heavy-Haul Truck Implementing Alternatives	J-121
J.3.5 Impacts in Nevada from Transportation Accidents for Inventory Modules 1 and 2	J-123
J.3.5.1 Mostly Legal-Weight Truck Scenario	J-123
J.3.5.2 Nevada Rail Implementing Alternatives	J-124
J.3.5.3 Nevada Heavy-Haul Truck Implementing Alternatives	J-126
J.3.6 Impacts from Transportation of Other Materials	J-127
J.3.6.1 Transportation of Personnel and Materials to Repository	J-128
J.3.6.2 Impacts of Transporting Wastes from the Repository	J-131
J.3.6.3 Impacts from Transporting Other Materials and People in Nevada for Inventory Modules 1 and 2	J-132
J.4 State-Specific Impacts and Route Maps	J-133
References	J-188

LIST OF TABLES

<u>Table</u>	<u>Page</u>
J-1 Summary of estimated number of shipments for the various inventory and national transportation analysis scenario combinations	J-11
J-2 Analysis basis—national and Nevada transportation scenarios	J-12
J-3 Shipping cask configurations	J-14
J-4 Shipments of commercial spent nuclear fuel, mostly legal-weight truck scenario	J-16
J-5 Shipments of commercial spent nuclear fuel, mostly rail scenario	J-18
J-6 DOE and naval spent nuclear fuel shipments by site	J-20
J-7 High-level radioactive waste shipments by site	J-20
J-8 Commercial Greater-Than-Class-C waste shipments	J-21
J-9 DOE Special-Performance-Assessment-Required waste shipments	J-22
J-10 Highway distances for legal-weight truck shipments from commercial and DOE sites to Yucca Mountain, mostly legal-weight truck transportation	J-26
J-11 Rail transportation distances from commercial and DOE sites to Nevada ending rail nodes	J-28
J-12 Average cesium-137, actinide isotope, and total radioactive material content in a rail shipping cask	J-33
J-13 Principal logistics bases and results for the reference at-reactor loading operations	J-34
J-14 At-reactor reference loading operations—collective impacts to involved workers	J-35
J-15 Input parameters and parameter values used for the incident-free national truck and rail transportation analysis, except stops	J-37
J-16 Population within 800 meters of routes for incident-free transportation using 2035 population	J-37
J-17 Input parameter values for stop doses for routine incident-free transportation	J-39
J-18 Incident-free dose factors	J-41
J-19 Loss-of-shielding conditional probabilities, radiation dose rates, and exposure factors for four cask types and six accident severity categories	J-55
J-20 Grouping of accident cases into accident categories	J-55
J-21 Frequency of atmospheric and wind speed conditions – U.S. averages	J-56
J-22 Frequency and consequence of rail accidents	J-61
J-23 Frequency and consequence of truck accidents	J-62
J-24 Consequences of maximum reasonably foreseeable accidents in national transportation	J-62
J-25 Comparison of general freight and dedicated train service	J-77
J-26 National transportation distances from commercial sites to Nevada ending rail nodes	J-82
J-27 Barge shipments and ports	J-83
J-28 Risk factors for incident-free heavy-haul truck and barge transportation of spent nuclear fuel and high-level radioactive waste	J-84
J-29 Comparison of population doses and impacts from incident-free national transportation mostly rail heavy-haul truck scenario, mostly rail barge scenario, and mostly truck scenario	J-84
J-30 Estimated population health impacts from vehicle emissions during incident-free national transportation for mostly rail heavy-haul truck and barge scenarios and the mostly legal-weight truck scenario	J-85
J-31 Release fractions and conditional probabilities for spent nuclear fuel transported by barge	J-86
J-32 Comparison of accident risks for the mostly rail heavy-haul truck and barge shipping scenarios	J-87
J-33 Routing characteristics in Nevada for legal-weight truck, rail and heavy-haul truck implementing alternatives	J-92

<u>Table</u>	<u>Page</u>
J-34 Routing characteristics in Nevada for existing commercial rail lines	J-93
J-35 Populations in Nevada within 800 meters of routes	J-94
J-36 Potential road upgrades for Caliente route	J-94
J-37 Potential road upgrades for Caliente/Chalk Mountain route	J-95
J-38 Potential road upgrades for Caliente/Las Vegas route	J-95
J-39 Potential road upgrades for Apex/Dry Lake route	J-95
J-40 Potential road upgrades for Sloan/Jean route	J-95
J-41 Possible variations of the Caliente Corridor	J-97
J-42 Possible variations of the Carlin Corridor	J-98
J-43 Possible variations of the Caliente-Chalk Mountain Corridor	J-99
J-44 Possible variations of the Jean Corridor	J-100
J-45 Possible variations of the Valley Modified Corridor	J-100
J-46 Nevada routing sensitivity cases analyzed for a legal-weight truck	J-116
J-47 Comparison of national impacts from the sensitivity analyses	J-117
J-48 Comparison of Nevada impacts from the sensitivity analyses	J-117
J-49 Input parameters and parameter values used for incident-free Nevada truck and rail transportation different from national parameters	J-118
J-50 Per-shipment unit risk factors for incident-free transportation of spent nuclear fuel and high-level radioactive waste in Nevada	J-118
J-51 Screening analysis of external events considered potential accident initiators at intermodal transfer station	J-120
J-52 Aircraft engine projectile characteristics (located in Volume IV of this EIS)	J-119
J-53 Results of aircraft projectile penetration analysis (located in Volume IV of this EIS)	J-119
J-54 Population doses and radiological impacts from incident-free Nevada transportation for mostly legal-weight truck scenario—Modules 1 and 2	J-121
J-55 Population health impacts from vehicle emissions during incident-free Nevada transportation for the mostly legal-weight truck scenario—Modules 1 and 2	J-121
J-56 Radiological and nonradiological impacts from incident-free Nevada transportation for the rail implementing alternative – Modules 1 and 2	J-122
J-57 Collective worker doses from transportation of a single cask	J-122
J-58 Doses and radiological health impacts to involved workers from intermodal transfer station operations – Modules 1 and 2	J-123
J-59 Radiological and nonradiological health impacts from incident-free transportation for the heavy-haul truck implementing alternatives – Modules 1 and 2	J-123
J-60 Accident impacts for Modules 1 and 2 – Nevada transportation	J-124
J-61 Rail corridor operation worker physical trauma impacts	J-124
J-62 Industrial health impacts from heavy-haul truck route operations	J-126
J-63 Annual physical trauma impacts to workers from intermodal transfer station operations	J-126
J-64 Human health and safety impacts from national and Nevada shipments of material to the repository	J-128
J-65 Health impacts and fuel consumption from transportation of construction and operations workers	J-129
J-66 Impacts of disposal container shipments for 24 years of the Proposed Action	J-130
J-67 Listed pollutants and pollutant of interest	J-130
J-68 Annual range of carbon monoxide emitted to Las Vegas Valley airshed from transport of personnel and material to repository for all modes of the Proposed Action	J-130
J-69 Health impacts and fuel consumption from transportation of waste from the Yucca Mountain repository	J-131
J-70 Health impacts from transportation of materials, consumables, personnel, and waste for Modules 1 and 2	J-133

<u>Table</u>	<u>Page</u>
J-71	Estimated transportation impacts for the States of Alabama and Georgia J-134
J-72	Estimated transportation impacts for the State of Arkansas J-136
J-73	Estimated transportation impacts for the States of Arizona and New Mexico J-138
J-74	Estimated transportation impacts for the State of California J-140
J-75	Estimated transportation impacts for the States of Colorado, Kansas, and Nebraska J-142
J-76	Estimated transportation impacts for the States of Connecticut, Rhode Island, and New York J-145
J-77	Estimated transportation impacts for the States of Delaware, Maryland, Virginia, West Virginia, and the District of Columbia J-148
J-78	Estimated transportation impacts for the State of Florida J-152
J-79	Estimated transportation impacts for the State of Iowa J-154
J-80	Estimated transportation impacts for the States of Idaho, Oregon, and Washington J-156
J-81	Estimated transportation impacts for the States of Indiana, Michigan, and Ohio J-159
J-82	Estimated transportation impacts for the State of Illinois J-162
J-83	Estimated transportation impacts for the States of Kentucky and Tennessee J-164
J-84	Estimated transportation impacts for the States of Louisiana and Mississippi J-166
J-85	Estimated transportation impacts for the States of Maine, Massachusetts, New Hampshire, and Vermont J-168
J-86	Estimated transportation impacts for the States of Minnesota and Wisconsin J-171
J-87	Estimated transportation impacts for the State of Missouri J-173
J-88	Estimated transportation impacts for the States of Montana, North Dakota, and South Dakota J-175
J-89	Estimated transportation impacts for the States of New Jersey and Pennsylvania J-178
J-90	Estimated transportation impacts for the States of North Carolina and South Carolina J-180
J-91	Estimated transportation impacts for the States of Oklahoma and Texas J-182
J-92	Estimated transportation impacts for the States of Utah and Wyoming J-184
J-93	Estimated transportation impacts for the State of Nevada J-186

LIST OF FIGURES

<u>Figure</u>	<u>Page</u>
J-1	Methods and approach for analyzing transportation radiological health risk J-3
J-2	Methods and approach for analyzing transportation nonradiological health risk J-4
J-3	Artist’s conception of a truck cask on a legal-weight tractor-trailer truck J-13
J-4	Artist’s conception of a large rail cask on a railcar J-13
J-5	Representative truck routes from commercial and DOE sites to Yucca Mountain analyzed for the Proposed Action and Inventory Modules 1 and 2 J-24
J-6	Representative rail routes from commercial and DOE sites to Yucca Mountain analyzed for the Proposed Action and Inventory Modules 1 and 2 J-25
J-7	Comparison of GA-4 cask dose rate and spent nuclear fuel burnup and cooling time J-47
J-8a	Impact speed and temperature matrix for pressurized-water reactor spent nuclear fuel in a steel-depleted uranium-steel truck cask (located in Volume IV of this EIS)..... J-53
J-8b	Impact speed and temperature matrix for pressurized-water reactor spent nuclear fuel in a steel-lead-steel rail cask (located in Volume IV of this EIS)..... J-53
J-9	Routes analyzed for barge transportation from sites to nearby railheads J-78
J-10	Potential Nevada routes for legal-weight trucks and estimated number of shipments J-89
J-11	Potential Nevada rail routes to Yucca Mountain and estimated number of shipments J-90
J-12	Potential Nevada routes for heavy-haul trucks and estimated number of shipments J-91
J-13	Land-use conflicts along Nevada rail corridors, overview J-101
J-14	Land-use conflicts along Nevada rail corridors, Apex Industrial Park J-102

<u>Figure</u>	<u>Page</u>
J-15 Land-use conflicts along Nevada rail corridors, Nellis Air Force Range, Goldfield area	J-102
J-16 Land-use conflicts along Nevada rail corridors, Nellis Air Force Range, Indian Springs area	J-103
J-17 Land-use conflicts along Nevada rail corridors, Ivanpah Valley Airport Public Lands Transfer Act	J-104
J-18 Land-use conflicts along Nevada rail corridors, Nellis Air Force Range, Scottys Junction area	J-104
J-19 Land-use conflicts along Nevada rail corridors, Timbisha Shoshone Trust Lands	J-105
J-20 Land-use conflicts along Nevada rail corridors, Wilderness Study Areas	J-105
J-21 Nevada minority census blocks in relation to the Caliente Corridor	J-106
J-22 Nevada minority census blocks in relation to the Carlin Corridor	J-107
J-23 Nevada minority census blocks in relation to the Caliente-Chalk Mountain Corridor	J-108
J-24 Nevada minority census blocks in relation to the Jean Corridor	J-109
J-25 Nevada minority census blocks in relation to the Valley Modified Corridor	J-110
J-26 Nevada minority census blocks in relation to the Caliente heavy-haul truck implementing alternative	J-111
J-27 Nevada minority census blocks in relation to the Caliente/Chalk Mountain route for heavy-haul trucks	J-112
J-28 Nevada minority census blocks in relation to the Caliente/Las Vegas route for heavy-haul trucks	J-113
J-29 Nevada minority census blocks in relation to the Sloan/Jean route for heavy-haul trucks	J-114
J-30 Nevada minority census blocks in relation to the Apex/Dry Lake route for heavy-haul trucks	J-115
J-31 Highway and rail routes used to analyze transportation impacts – Alabama and Georgia	J-135
J-32 Highway and rail routes used to analyze transportation impacts – Arkansas	J-137
J-33 Highway and rail routes used to analyze transportation impacts – Arizona and New Mexico	J-139
J-34 Highway and rail routes used to analyze transportation impacts – California	J-141
J-35 Highway and rail routes used to analyze transportation impacts – Colorado, Kansas, and Nebraska	J-144
J-36 Highway and rail routes used to analyze transportation impacts – Connecticut, Rhode Island, and New York	J-147
J-37 Highway and rail routes used to analyze transportation impacts – Delaware, Maryland, Virginia, West Virginia, and the District of Columbia	J-151
J-38 Highway and rail routes used to analyze transportation impacts – Florida	J-153
J-39 Highway and rail routes used to analyze transportation impacts – Iowa	J-155
J-40 Highway and rail routes used to analyze transportation impacts – Idaho, Oregon, and Washington	J-158
J-41 Highway and rail routes used to analyze transportation impacts – Indiana, Michigan, and Ohio	J-161
J-42 Highway and rail routes used to analyze transportation impacts – Illinois	J-163
J-43 Highway and rail routes used to analyze transportation impacts – Kentucky and Tennessee	J-165
J-44 Highway and rail routes used to analyze transportation impacts – Louisiana and Mississippi	J-167
J-45 Highway and rail routes used to analyze transportation impacts – Maine, Massachusetts, New Hampshire, and Vermont	J-170

<u>Figure</u>		<u>Page</u>
J-46	Highway and rail routes used to analyze transportation impacts – Minnesota and Wisconsin	J-172
J-47	Highway and rail routes used to analyze transportation impacts – Missouri	J-174
J-48	Highway and rail routes used to analyze transportation impacts – Montana, North Dakota, and South Dakota	J-177
J-49	Highway and rail routes used to analyze transportation impacts – New Jersey and Pennsylvania	J-179
J-50	Highway and rail routes used to analyze transportation impacts – North Carolina and South Carolina	J-181
J-51	Highway and rail routes used to analyze transportation impacts – Oklahoma and Texas	J-183
J-52	Highway and rail routes used to analyze transportation impacts – Utah and Wyoming	J-185
J-53	Highway and rail routes used to analyze transportation impacts – Nevada	J-187

APPENDIX J. TRANSPORTATION

This appendix provides additional information for readers who wish to gain a better understanding of the methods and analyses the U.S. Department of Energy (DOE or the Department) used to determine the human health impacts of transportation for the Proposed Action and Inventory Modules 1 and 2 discussed in this environmental impact statement (EIS). The materials included in Module 1 are the 70,000 metric tons of heavy metal (MTHM) for the Proposed Action and additional quantities of spent nuclear fuel and high-level radioactive waste that DOE could dispose of in the repository as part of a reasonably foreseeable future action. The materials included in Module 2 include the materials in Module 1 and other highly radioactive materials. Appendix A describes materials included in Modules 1 and 2. This appendix also provides the information DOE used to estimate traffic fatalities that would be associated with the long-term maintenance of storage facilities at 72 commercial sites and 5 DOE sites.

The appendix describes the key data and assumptions DOE used in the analyses and the analysis tools and methods the Department used to estimate impacts of loading operations at 72 commercial and 5 DOE sites; incident-free transportation by highway, rail and barge; intermodal transfer; and transportation accidents. The references listed at the end of this appendix contain additional information.

This appendix presents information on analyses of the impacts of national transportation and on analyses of the impacts that could occur in Nevada. Section J.1 presents information on the analysis of occupational and public health and safety impacts for the transportation of spent nuclear fuel and high-level radioactive waste from the 77 sites to the repository. Section J.2 presents information on the analysis of rail and intermodal transportation alternatives. Section J.3 presents information on the analysis of transportation in Nevada. Section J.4 presents state-specific transportation impacts and maps of analyzed state-specific transportation routes.

J.1 Methods Used To Estimate Potential Impacts of Transportation

This section provides information on the methods and data DOE used to estimate impacts from shipping spent nuclear fuel and high-level radioactive waste from 72 commercial sites and 5 DOE sites throughout the United States to the Yucca Mountain Repository.

MOSTLY LEGAL-WEIGHT TRUCK AND MOSTLY RAIL SCENARIOS

The Department would prefer most shipments to a Yucca Mountain repository be made using rail transportation. It also expects that the mostly rail scenario described in this EIS best represents the mix of rail and truck transportation that would be used. However, it cannot be certain of the actual mix of rail and truck transportation that would occur over the 24 years of the Proposed Action. Consequently, DOE used the mostly legal-weight truck and mostly rail scenarios as a basis for the analysis of potential impacts to ensure the analysis addressed the range of possible transportation impacts. The estimated number of shipments for the mostly legal-weight truck and mostly rail scenarios represents the two extremes in the possible mix of transportation modes, thereby covering the range of potential impacts to human health and safety and to the environment for the transportation modes DOE could use for the Proposed Action.

J.1.1 ANALYSIS APPROACH AND METHODS

Three types of impacts could occur to the public and workers from transportation activities associated with the Proposed Action. These would be a result of the transportation of spent nuclear fuel and

high-level radioactive waste and of the personnel, equipment, materials, and supplies needed to construct, operate and monitor, and close the proposed Yucca Mountain Repository. The first type, radiological impacts, would be measured by radiological dose to populations and individuals and the resulting estimated number of latent cancer fatalities that would be caused by radiation from shipments of spent nuclear fuel and high-level radioactive waste from the 77 sites under normal and accident transport conditions. The second and third types would be nonradiological impacts—potential fatalities resulting from vehicle emissions and caused by vehicle accidents. The analysis also estimated impacts due to the characteristics of hazardous cargoes from accidents during the transportation of nonradioactive hazardous materials to support repository construction, operation and monitoring, and closure. For perspective, about 11 fatalities resulting from hazardous material occur each year during the transportation of more than 300 million shipments of hazardous materials in the United States (DIRS 156755-BLS 2001, Table A-8). Therefore, DOE expects that the risks from exposure to hazardous materials that could be released during shipments to and from the repository sites would be very small (see Section J.1.4.2.4). The analysis evaluated the impacts of traffic accidents and vehicle emissions arising from these shipments.

The analysis used a step-wise process to estimate impacts to the public and workers. The process used the best available information from various sources and computer programs and associated data to accomplish the steps. Figures J-1 and J-2 show the steps followed in using data and computer programs. DOE has determined that the computer programs identified in the figure are suitable, and provide results in the appropriate measures, for the analysis of impacts performed for this EIS.

The CALVIN computer program (DIRS 155644-CRWMS M&O 1999, all) was used to estimate the numbers of shipments of spent nuclear fuel from commercial sites. This program used information on spent nuclear fuel stored at each site and an assumed scenario for picking up the spent fuel from each site. The program also used information on the capacity of shipping casks that could be used.

The HIGHWAY computer program (DIRS 104780-Johnson et al. 1993, all) is a routing tool used to select existing highway routes that would satisfy U.S. Department of Transportation route selection regulations and that DOE could use to ship spent nuclear fuel and high-level radioactive waste from the 77 sites to the repository.

The INTERLINE computer program (DIRS 104781-Johnson et al. 1993, all) is a routing tool used to select existing rail routes that railroads would be likely to use to ship spent nuclear fuel and high-level radioactive waste from the 77 sites to the repository.

The RADTRAN 5 computer program (DIRS 150898-Neuhauser and Kanipe 2000, all; DIRS 155430-Neuhauser, Kanipe, and Weiner 2000, all) was used in estimating the radiological doses and dose risks to populations and transportation workers resulting from incident-free transportation and to the general population from accident scenarios. For the analysis of incident-free transportation risks, the code used scenarios for persons who would share transportation routes with shipments—called *onlink populations*, persons who live along the route of travel—*offlink populations*, and persons exposed at stops. For accident risks, the code evaluated the range of possible accident scenarios from high probability and low consequence to low probability and high consequence.

The RISKIND computer program (DIRS 101483-Yuan et al. 1995, all) was used to estimate radiological doses to maximally exposed individuals for incident-free transportation and to populations and maximally exposed individuals for accident scenarios. To estimate incident-free doses to maximally exposed individuals, RISKIND used geometry to calculate the dose rate at specified locations that would arise from a source of radiation. RISKIND was also used to calculate the radiation dose to a population and hypothetical maximally exposed individuals from releases of radioactive materials postulated to occur in maximum reasonably foreseeable accident scenarios.

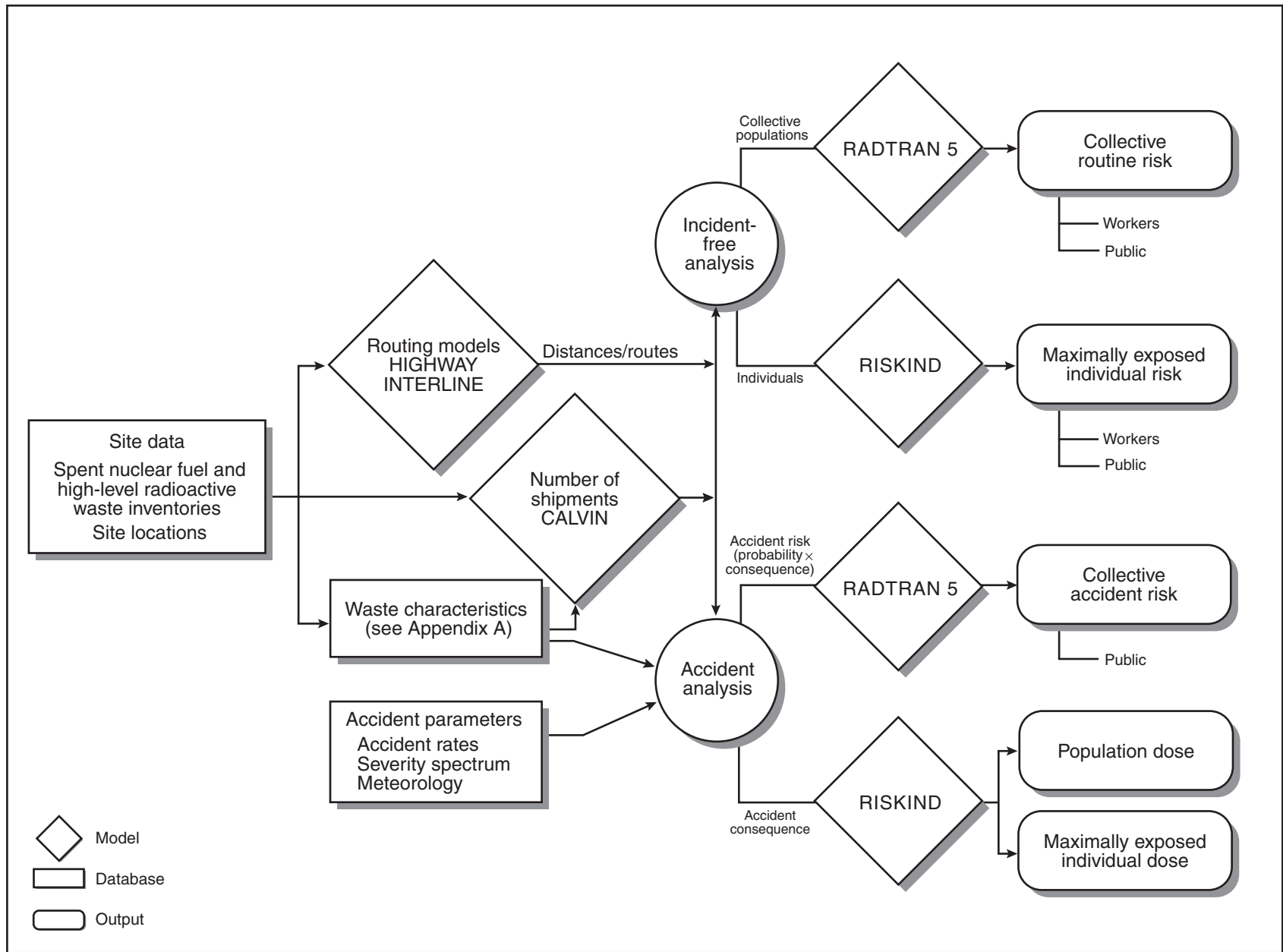

Figure J-1. Methods and approach for analyzing transportation radiological health risk.

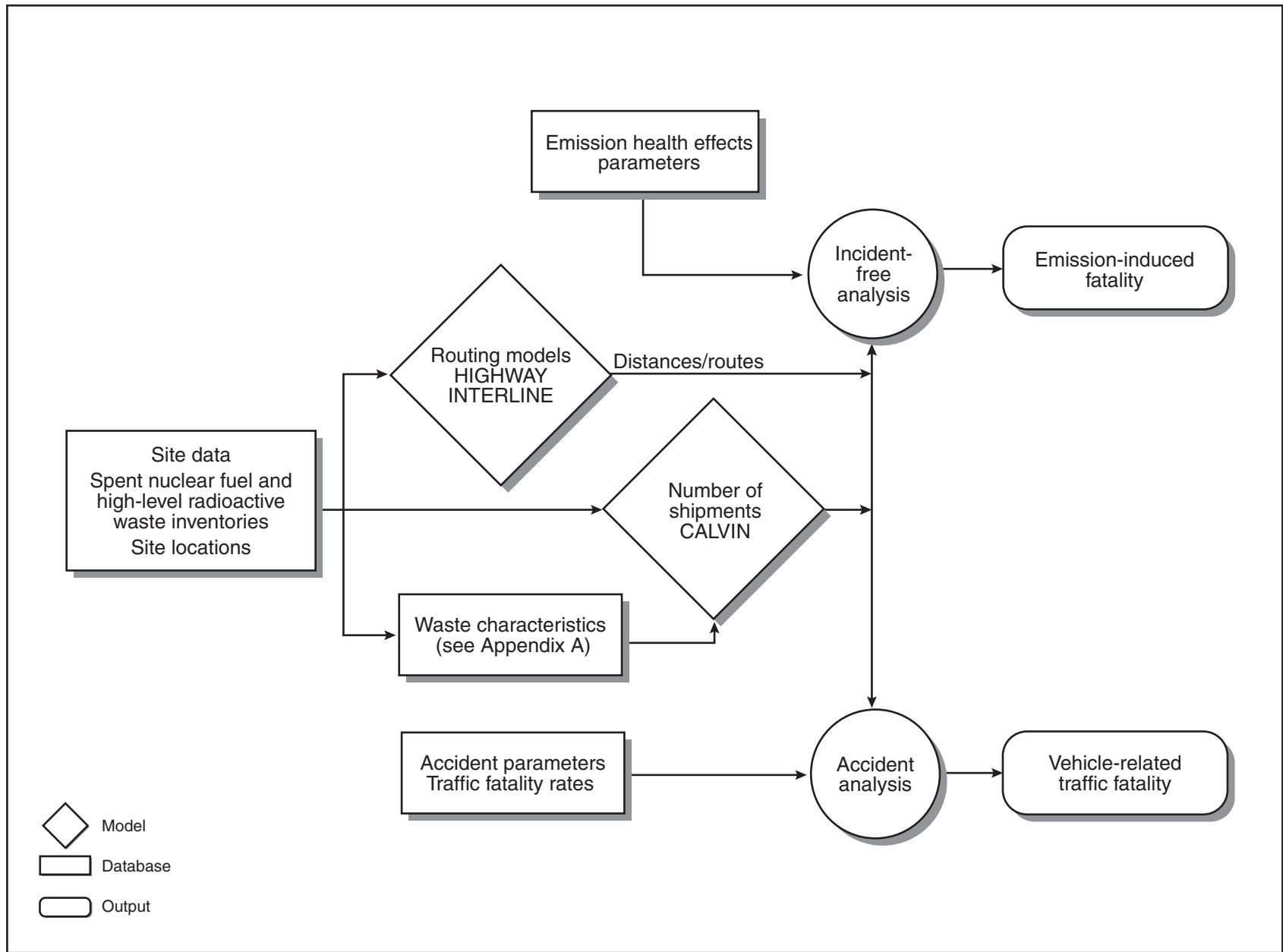

Figure J-2. Methods and approach for analyzing transportation nonradiological health risk.

DOSE RISK

Dose risk is a measure of radiological impacts to populations – public or workers – from the potential for exposure to radioactive materials. Thus, a potential of 1 chance in 1,000 of a population receiving a collective dose of 1 rem (1 person-rem) from an accident would result in a dose risk of 0.001 person-rem (0.001 is the product of 1 person-rem and the quotient of 1 over 1,000). The risk of latent cancer fatalities (a commonly used measure of radiological impact to populations) is obtained by multiplying the dose risk (in person-rem) by a conversion factor of 0.0005 fatal cancer per person-rem for the public. For workers, the conversion factor is 0.0004 fatal cancer per person-rem.

The use of dose risk to measure radiological impacts allows a comparison of alternatives with differing characteristics in terms of radiological consequences that could result and the likelihood that the consequences would actually occur.

The following sections describe these programs in detail.

J.1.1.1 CALVIN

The Civilian Radioactive Waste Management System Analysis and Logistics Visually Interactive (CALVIN) model (DIRS 155644-CRWMS M&O 1999, all) was developed to be a planning tool to estimate the logistic and cost impacts of various operational assumptions for accepting radioactive wastes. CALVIN was used in transportation modeling to determine the number of shipments of commercial spent nuclear fuel from each reactor site. The parameters that the CALVIN model used to determine commercial spent nuclear fuel movement include the shipping cask specifications including heat limits, k_{∞} (measure of criticality) limits for the contents of the casks, capacity (assemblies or canisters/cask), burnup/enrichment curves, and cooling time for the fuel being shipped.

The source data used by CALVIN for commercial spent nuclear fuel projections include the RW-859 historic data collected by the Energy Information Administration, and the corresponding projection produced based on current industry trends for commercial fuel (see Appendix A). This EIS used CALVIN to estimate commercial spent nuclear fuel shipment numbers based on the cask capacity (see Section J.1.2) and the shipping cask handling capabilities at each site. For the mostly rail national transportation scenario, CALVIN assumed that shipments would use the largest cask a site would be capable of handling. In some cases the analysis, using CALVIN, estimated that the characteristics of the spent nuclear fuel that would be picked up at a site (principally the estimated heat generation rate) would limit the number of fuel assemblies that could be transported to fewer than the full capacity of the cask. In such cases, to provide a realistic estimate of the number of shipments that would be made, CALVIN assumed the cask would contain the smaller number of assemblies. The reduction in capacity was sufficient to accommodate the characteristics of the spent nuclear fuel the program estimated for pickup at the site. In addition, the analysis assumed that sites without sufficient crane capacity to handle a rail cask while operational would be upgraded after reactor shutdown such that the sites could handle rail casks.

J.1.1.2 HIGHWAY

The HIGHWAY computer program (DIRS 104780-Johnson et al. 1993, all) was used to select highway routes for the analysis of impacts presented in this EIS. Using data for actual highways and rules that apply to carriers of Highway Route-Controlled Quantities of Radioactive Materials (49 CFR 397.101),

HIGHWAY selected highway routes for legal-weight truck shipments from each commercial and DOE site to the Yucca Mountain site. In addition, DOE used this program to estimate the populations within 800 meters (0.5 mile) of the routes it selected. These population densities were used in calculating incident-free radiological risks to the public along the routes.

One of the features of the HIGHWAY model is its ability to estimate routes for the transport of Highway Route-Controlled Quantities of Radioactive Materials. The U.S. Department of Transportation has established a set of routing regulations for the transport of these materials (49 CFR 397.101). Routes following these regulations are frequently called HM-164 routes. The regulations require the transportation of these shipments on preferred highways, which include:

- Interstate highways
- An Interstate System bypass or beltway around a city
- State-designated preferred routes

State routing agencies can designate preferred routes as an alternative to, or in addition to, one or more Interstate highways. In making this determination, the state must consider the safety of the alternative preferred route in relation to the Interstate route it is replacing, and must register all such designated preferred routes with the U.S. Department of Transportation.

Frequently, the origins and destinations of Highway Route-Controlled Quantities of Radioactive Materials are not near Interstate highways. In general, the U.S. Department of Transportation routing regulations require the use of the shortest route between the pickup location to the nearest preferred route entry location and the shortest route to the destination from the nearest preferred route exit location. In general, HM-164 routes tend to be somewhat longer than other routes; however, the increased safety associated with Interstate highway travel is the primary purpose of the routing regulations.

Because many factors can influence the time in transit over a preferred route, a carrier of Highway Route-Controlled Quantities of Radioactive Materials must select a route for each shipment. Seasonal weather conditions, highway repair or construction, highways that are closed because of natural events (for example, a landslide in North Carolina closed Interstate 40 near the border with Tennessee from June until November 1997), and other events (for example, the 1996 Olympic Games in Atlanta, Georgia) are all factors that must be considered in selecting preferred route segments to reduce time in transit. For this analysis, the highway routes were selected by the HIGHWAY program using an assumption of normal travel and without consideration for factors such as seasons of the year or road construction delays. Although these shipments could use other routes, DOE considers the impacts determined in the analyses to be representative of other possible routings that would also comply with U.S. Department of Transportation regulations. Specific route mileages for truck transportation are presented in Section J.1.2.2.1.

In selecting existing routes for use in the analysis, the HIGHWAY program determined the length of travel in each type of population zone—rural, suburban, and urban. The program characterized rural, suburban, and urban population areas according to the following breakdown: rural population densities range from 0 to 54 persons per square kilometer (0 to 140 persons per square mile); the suburban range is 55 to 1,300 persons per square kilometer (140 to 3,300 persons per square mile); and urban is all population densities greater than 1,300 persons per square kilometer (3,300 persons per square mile). The population densities along a route used by the HIGHWAY program are derived from 1990 data from the Bureau of the Census. In addition, the analysis used results of the 2000 Census for state populations as well as population forecasts published by the Bureau of the Census in estimating radiological impacts to populations that would live along transportation routes (see Sections J.1.3.2.1 and J.1.4.2.1).

J.1.1.3 INTERLINE

Shipments of radioactive materials by rail are not subject to route restrictions imposed by regulations. For general freight rail service, DOE anticipates that railroads would route shipments of spent nuclear fuel and high-level radioactive waste to provide expeditious travel and the minimum practical number of interchanges between railroads. The selection of a route determines the potentially exposed population along the route as well as the expected frequency of transportation-related accidents. The analysis used the INTERLINE computer program (DIRS 104781-Johnson et al. 1993, all) to project the railroad routes that DOE would use to ship spent nuclear fuel and high-level radioactive waste from the sites to the Yucca Mountain site. Specific routes were projected for each originating generator with the exception of six that do not have capability to handle or load a rail transportation cask (see Section J.1.2.1.1). INTERLINE computes rail routes based on rules that simulate historic routing practices of U.S. railroads. The INTERLINE database consists of 94 separate subnetworks and represents various competing rail companies in the United States. The database, which was originally based on data from the Federal Railroad Administration and reflected the U.S. railroad system in 1974, has been expanded and modified extensively over the past two decades. The program is updated periodically to reflect current track conditions and has been benchmarked against reported mileages and observations of commercial rail firms. The program also provides an estimate of the population within 800 meters (0.5 mile) of the routes it selected. This population estimate was used to calculate incident-free radiological risk to the public along the routes selected for analysis.

In general, rail routes are calculated by minimizing the value of a factor called *impedance* between the origin and the destination. The impedance is determined by considering trip distance along a route, the mainline classification of the rail lines that would be used, and the number of interchanges that would occur between different railroad companies involved. In general, impedance determined by the INTERLINE program:

- Decreases as the distance traveled decreases
- Is reduced by use of mainline track that has the highest traffic volume (see below)
- Is reduced for shipments that involve the fewest number of railroad companies

Thus, routes that are the most direct, that use high-traffic volume mainline track, and that involve only one railroad company would have the lowest impedance. The most important of these characteristics from a routing standpoint is the *mainline classification*, which is the measure of traffic volume on a particular link. The mainline classifications used in the INTERLINE routing model are as follows:

- A – mainline – more than 20 million gross ton miles per year
- B – mainline – between 5 and 20 million gross ton miles per year
- A – branch line – between 1 and 5 million gross ton miles per year
- B – branch line – less than 1 million gross ton miles per year

The INTERLINE routing algorithm is designed to route a shipment preferentially on the rail lines having the highest traffic volume. Frequently traveled routes are preferred because they are generally well maintained because the railroad depends on these lines for a major portion of its revenue. In addition, routing along the high-traffic lines usually replicates railroad operational practices.

The population densities along a route were derived from 1990 data from the Bureau of the Census, as described above for the HIGHWAY computer program. In addition, the analysis used the results of the 2000 Census for state populations as well as population forecasts published by the Bureau of the Census to estimate radiological impacts to populations that would live along transportation routes (see Sections J.1.3.2.1 and J.1.4.2.1).

DOE anticipates that routing of rail shipments in dedicated (special) train service, if used, would be similar to routing of general freight shipments for the same origin and destination pairs. However, because cask cars would not be switched between trains at classification yards, dedicated train service would be likely to result in less time in transit.

J.1.1.4 RADTRAN 5

DOE used the RADTRAN 5 computer program (DIRS 150898-Neuhauser and Kanipe 2000, all; DIRS 155430-Neuhauser, Kanipe, and Weiner 2000, all) in conjunction with a Microsoft Access database for the routine and accident cargo-related risk assessment to estimate radiological impacts to collective populations. The Department used RADTRAN 5 to generate risk factors such as transportation impacts per kilometer of travel. The database was used to manage the large amount of data and results for the analysis. Sandia National Laboratories developed RADTRAN 5 to calculate population risks associated with the transportation of radioactive materials by a variety of modes, including truck, rail, air, ship, and barge. The RADTRAN codes, which have been reviewed and updated periodically, have been used extensively by DOE for transportation risk assessment since the late 1970s. In 1995, DIRS 101845-Maheras and Phippen (1995, p. iii) conducted an analysis “to validate the estimates made by” selection of computer codes used to estimate radiation doses from the transportation of radioactive materials. The RADTRAN 4 computer code was included in the analysis. The analysis demonstrated that the RADTRAN 4 code, an earlier version of RADTRAN 5 yielded acceptable results. In the context of this analysis, “acceptable results” means that the differences between the estimates generated by the RADTRAN 4 code and hand calculations were small [that is, less than 5 percent (DIRS 101845-Maheras and Phippen 1995, p. 3-1)]. DIRS 153967-Steinman and Kearfott (2000, all) compared RADTRAN 5 results to measured radiation doses from moving sources, and found that RADTRAN 5 overpredicts the measured radiation dose to the receptor.

The RADTRAN 5/database calculations for routine (or incident-free) dose are based on expressing the dose rate as a function of distance from a point source. Associated with the calculation of routine doses for each exposed population group are parameters such as the radiation field strength, the source-receptor distance, the duration of the exposure, vehicle speed, stopping time, traffic density, and route characteristics such as population density and route segment length. The radiation dose to the exposed population decreases as the source-receptor distance and the vehicle speed increase. The radiation dose to the exposed population increases as the other parameters mentioned above increase. In calculating population doses from incident-free transportation, RADTRAN 5 and the database used population density data provided by the HIGHWAY and INTERLINE computer programs. These data are based on the 1990 Census. The results of the RADTRAN 5/database analyses were escalated to account for population growth to 2035.

In addition to routine doses, the RADTRAN 5/database combination was used to estimate dose risk from a spectrum of accident scenarios. This spectrum encompasses the range of possible accidents, including low-probability accident scenarios that have high consequences, and high-probability accident scenarios that have low consequences (fender benders). The RADTRAN 5/database calculation of collective accident risks for populations along routes employed models that quantified the range of potential accident severities and the responses of the shipping casks to those scenarios. The spectrum of accident severity was divided into categories. Each category of severity has a conditional probability of occurrence; that is, the probability that an accident will be of a particular severity if it occurs. A release fraction, which is the fraction of the material in a shipping cask that could be released in an accident, is assigned to each accident scenario severity category on the basis of the physical and chemical form of the material being transported. The analysis also considered accidents that would lose lead radiation shielding but with no release of radioactive material. The model also considers the mode of transportation, the state-specific accident rates, and population densities for rural, suburban, and urban population zones through which shipments would pass to estimate accident risks for this analysis. The

RADTRAN 5/database calculation used actual population densities within 800 meters (0.5 mile) of the transportation routes based on 1990 Census data to estimate populations within 80 kilometers (50 miles).

For accident scenarios involving releases of radioactive material, RADTRAN 5 assumes that the material is dispersed in the environment (as described by a Gaussian dispersion model). The dispersion analysis assumed that meteorological conditions are national averages for wind speed and atmospheric stability. For the risk assessment, the analysis used these meteorological conditions and assumed an instantaneous ground-level release and a small-diameter source cloud (DIRS 155430-Neuhauser, Kanipe, and Weiner 2000, Section 4.1.1). The calculation of the collective population dose following the release and the dispersal of radioactive material includes the following exposure pathways:

- External exposure to the passing radioactive cloud
- External exposure to contaminated ground
- Internal exposure from inhalation of airborne contaminants
- Internal exposure from ingestion of contaminated food

For the ingestion pathway, the analysis used the ground deposition calculated using RADTRAN 5 and state-specific food transfer factors, which relate the amount of radioactive material ingested to the amount deposited on the ground, as input to the database. Radiation doses from the ingestion or inhalation of radionuclides were calculated by using standard dose conversion factors from Federal Guidance Reports No. 11 and 12 (DIRS 104800-CRWMS M&O 1999, p. 36).

POTENTIAL HUMAN HEALTH IMPACTS OF TRANSPORTATION ACCIDENTS THAT COULD CONTAMINATE SURFACE-WATER AND GROUNDWATER RESOURCES

The EIS does not specifically analyze a transportation accident involving contamination of surface water or groundwater. Analyses performed in previous EISs (see Chapter 1, Section 1.5.3 and Table 1-1) have consistently shown that the airborne pathway has the greatest potential for exposing large numbers of people to radioactive material in the event of a release of such material during a severe transportation accident. A paper by R.M. Ostmeyer analyzed the potential importance of water pathway contamination for spent nuclear fuel transportation accident risk using a worst-case water contamination scenario. The analysis showed that the impacts of the water contamination scenario were about 1/50th of the impacts of a comparable accident in an urban area (DIRS 104784-Ostmeyer 1986, all).

J.1.1.5 RISKIND

The RISKIND computer program (DIRS 101483-Yuan et al. 1995, all) was used as a complement to the RADTRAN 5 calculations to estimate scenario-specific doses to maximally exposed individuals for both routine operations and accident conditions and to estimate population impacts for the assessment of accident scenario consequences. The RISKIND code was originally developed for the DOE Office of Civilian Radioactive Waste Management specifically to analyze radiological consequences to individuals and population subgroups from the transportation of spent nuclear fuel and is used now to analyze the transport of other radioactive materials, as well as spent nuclear fuel.

The RISKIND external dose model considers direct external exposure and exposure from radiation scattered from the ground and air. RISKIND was used to calculate the dose as a function of distance from a shipment on the basis of the dimensions of the shipment (millirem per hour for stationary exposures and millirem per event for moving shipments). The code approximates the shipment as a cylindrical volume source, and the calculated dose includes contributions from secondary radiation scatter from buildup

(scattering by material contents), cloudshine (scattering by air), and groundshine (scattering by the ground). Credit for potential shielding between the shipment and the receptor was not considered.

The RISKIND code was also used to provide a scenario-specific assessment of radiological consequences of severe transportation-related accidents. Whereas the RADTRAN 5 risk assessment considers the entire range of accident severities and their related probabilities, the RISKIND consequence assessment focuses on accident scenarios that result in the largest releases of radioactive material to the environment that are reasonably foreseeable. The consequence assessment was intended to provide an estimate of the potential impacts posed by a severe, but highly unlikely, transportation-related accident scenario.

The dose to each maximally exposed individual considered was calculated with RISKIND for an exposure scenario defined by a given distance, duration, and frequency of exposure specific to that receptor. The distances and durations were similar to those given in previous transportation risk assessments. The scenarios were not meant to be exhaustive but were selected to provide a range of potential exposure situations.

J.1.2 NUMBER AND ROUTING OF SHIPMENTS

This section discusses the number of shipments and routing information used to analyze potential impacts that would result from preparation for and conduct of transportation operations to ship spent nuclear fuel and high-level radioactive waste to the Yucca Mountain site. Table J-1 summarizes the estimated numbers of shipments for the various inventory and national shipment scenario combinations.

J.1.2.1 Number of Shipments

DOE used two analysis scenarios—mostly legal-weight truck and mostly train (rail)—as bases for estimating the number of shipments of spent nuclear fuel and high-level radioactive waste from 72 commercial and 5 DOE sites. The number of shipments for the scenarios was used in analyzing transportation impacts for the Proposed Action and Inventory Modules 1 and 2. DOE selected the scenarios because, more than 10 years before the projected start of operations at the repository, it cannot accurately predict the actual mix of rail and legal-weight truck transportation that would occur from the 77 sites to the repository. Therefore, the selected scenarios enable the analysis to bound (or bracket) the ranges of legal-weight truck and rail shipments that could occur.

The analysis estimated the number of shipments from commercial sites where spent nuclear fuel would be loaded and shipped and from DOE sites where spent nuclear fuel, naval spent nuclear fuel, and high-level radioactive waste would be loaded and shipped.

For the mostly legal-weight truck scenario, with one exception, shipments were assumed to use legal-weight trucks. Overweight, overdimensional trucks weighing between about 36,300 and 52,200 kilograms (80,000 and 115,000 pounds) but otherwise similar to legal-weight trucks could be used for some spent nuclear fuel and high-level radioactive waste (for example, spent nuclear fuel from the South Texas reactors). The exception that gives the scenario its name—mostly legal-weight truck—was for shipments of naval spent nuclear fuel. Under this scenario, naval spent nuclear fuel would be shipped by rail, as decided in the *Record of Decision for a Dry Storage Container System for the Management of Naval Spent Nuclear Fuel* (62 FR 1095; January 8, 1997).

For the mostly rail scenario, the analysis assumed that all sites would ship by rail, with the exception of those with physical limitations that would make rail shipment impractical. The exception would be for shipments by legal-weight trucks from six commercial sites that do not have the capability to load rail casks. However, the analysis also assumed that these six sites would be upgraded to handle a rail cask after the reactors were shut down and would ship either by direct rail or by heavy-haul truck or barge to

Table J-1. Summary of estimated number of shipments for the various inventory and national transportation analysis scenario combinations.

	Mostly truck		Mostly rail	
	Truck	Rail	Truck	Rail
<i>Proposed Action</i>				
Commercial spent nuclear fuel	41,001	0	1,079	7,218
High-level radioactive waste	8,315	0	0	1,663
DOE spent nuclear fuel	3,470	300	0	765
Greater-Than-Class-C waste	0	0	0	0
Special-Performance-Assessment-Required waste	0	0	0	0
<i>Proposed Action totals</i>	<i>52,786</i>	<i>300</i>	<i>1,079</i>	<i>9,646</i>
<i>Module 1^a</i>				
Commercial spent nuclear fuel	79,684	0	3,122	12,989
High-level radioactive waste	22,280	0	0	4,458
DOE spent nuclear fuel	3,721	300	0	796
Greater-Than-Class-C waste	0	0	0	0
Special-Performance-Assessment-Required waste	0	0	0	0
<i>Module 1 totals</i>	<i>105,685</i>	<i>300</i>	<i>3,122</i>	<i>18,243</i>
<i>Module 2^a</i>				
Commercial spent nuclear fuel	79,684	0	3,122	12,989
High-level radioactive waste	22,280	0	0	4,458
DOE spent nuclear fuel	3,721	300	0	796
Greater-Than-Class-C waste	1,096	0	0	282
Special-Performance-Assessment-Required waste	1,763	55	0	410
<i>Module 2 totals</i>	<i>108,544</i>	<i>355</i>	<i>3,122</i>	<i>18,935</i>

a. The number of shipments for Module 1 includes all shipments of spent nuclear fuel and high-level radioactive waste included in the Proposed Action and shipments of additional spent nuclear fuel and high-level radioactive waste as described in Appendix A. The number of shipments for Module 2 includes all the shipments in Module 1 and additional shipments of highly radioactive materials described in Appendix A.

nearby railheads. Of these six sites, two are direct rail sites and four are indirect rail sites. Of the four indirect rail sites, three are adjacent to navigable waterways and could ship by barge. In addition, under this scenario, the analysis assumed that 24 commercial sites that do not have direct rail service but that could handle large casks would ship by barge or heavy-haul truck to nearby railheads with intermodal capability.

For commercial spent nuclear fuel, the CALVIN code was used to compute the number of shipments. The number of shipments of DOE spent nuclear fuel and high-level radioactive waste was estimated based on the data in Appendix A and information provided by the DOE sites. The numbers of shipments were estimated based on the characteristics of the materials shipped, mode interface capability (for example, the lift capacity of the cask-handling crane) of each shipping facility, and the modal-mix case analyzed. Table J-2 summarizes the basis for the national and Nevada transportation impact analysis.

Detailed descriptions of spent nuclear fuel and high-level radioactive waste that would be shipped to the Yucca Mountain site are presented in Appendix A.

J.1.2.1.1 *Commercial Spent Nuclear Fuel*

For the analysis, the CALVIN model used 31 shipping cask configurations: 9 for legal-weight truck casks (Figure J-3) and 22 for rail casks (Figure J-4). Table J-3 lists the legal-weight truck and rail cask configurations used in the analysis and their capacities. The analysis assumed that all shipments would use one of the 31 configurations. If the characteristics of the spent nuclear fuel projected for shipment

Table J-2. Analysis basis—national and Nevada transportation scenarios.^{a,b}

Material	Mostly legal-weight truck scenario national and Nevada	National mostly rail scenario	
		Nevada rail scenario	Nevada heavy-haul truck scenario
<i>Casks</i>			
Commercial SNF	Truck casks – about 1.8 MTHM per cask	Rail casks – 6 to 12 MTHM per cask for shipments from 66 sites Truck casks – about 1.8 MTHM per cask for shipments from 6 sites ^c	Rail casks – 6 to 12 MTHM per cask for shipments from 66 sites Truck casks – about 1.8 MTHM per cask for shipments from 6 sites
DOE HLW and DOE SNF, except naval SNF	Truck casks – 1 SNF or HLW canister per cask	Rail casks – four to nine SNF or HLW canisters per cask	Rail casks – four to nine SNF or HLW canisters per cask
Naval SNF	Disposal canisters in large rail casks for shipment from INEEL	Disposable canisters in large rail casks for shipments from INEEL	Disposable canisters in large rail casks for shipments from INEEL
<i>Transportation modes</i>			
Commercial SNF	Legal-weight trucks	Direct rail from 49 sites served by railroads to repository Heavy-haul trucks from 7 sites to railhead, then rail to repository Heavy-haul trucks or barges ^d from 17 sites to railhead, then rail to repository	Rail from 49 sites served by railroads to intermodal transfer station in Nevada, then heavy-haul trucks to repository Heavy-haul trucks from 7 sites to railheads, then rail to intermodal transfer station in Nevada, then heavy-haul trucks to repository Heavy-haul trucks or barges ^d from 17 sites to railheads, then rail to intermodal transfer station in Nevada, then heavy-haul trucks to repository
DOE HLW and DOE SNF, except naval SNF	Legal-weight trucks	Legal-weight trucks from 6 sites to repository ^c Rail from DOE sites ^e to repository	Legal-weight trucks from 6 sites to repository ^c Rail from DOE sites ^e to intermodal transfer station in Nevada, then heavy-haul trucks to repository
Naval SNF	Rail from INEEL to intermodal transfer station in Nevada, then heavy-haul trucks to repository	Rail from INEEL to repository	Rail from INEEL to intermodal transfer station in Nevada, then heavy-haul trucks to repository

- a. Abbreviations: SNF = spent nuclear fuel; MTHM = metric tons of heavy metal; HLW = high-level radioactive waste; INEEL = Idaho National Engineering and Environmental Laboratory.
- b. G. E. Morris facility is included with the Dresden reactor facilities in the 72 commercial sites.
- c. The analysis assumed that the six legal-weight truck sites would upgrade their crane capacity upon reactor shutdown and would ship all remaining spent nuclear fuel by rail. Of those six sites, four are heavy-haul sites and two are direct rail sites. Three of the heavy-haul sites have barge capability (Pilgrim, St. Lucie 1, and Indian Point).
- d. Seventeen of 24 commercial sites not served by a railroad are on or near a navigable waterway. Some of these 17 sites could ship by barge rather than by heavy-haul truck to a nearby railhead. Salem/Hope Creek treated as two sites for heavy-haul or barge analysis.
- e. Hanford Site, Savannah River Site, Idaho National Engineering and Environmental Laboratory, West Valley Demonstration Project, and Ft. St. Vrain.

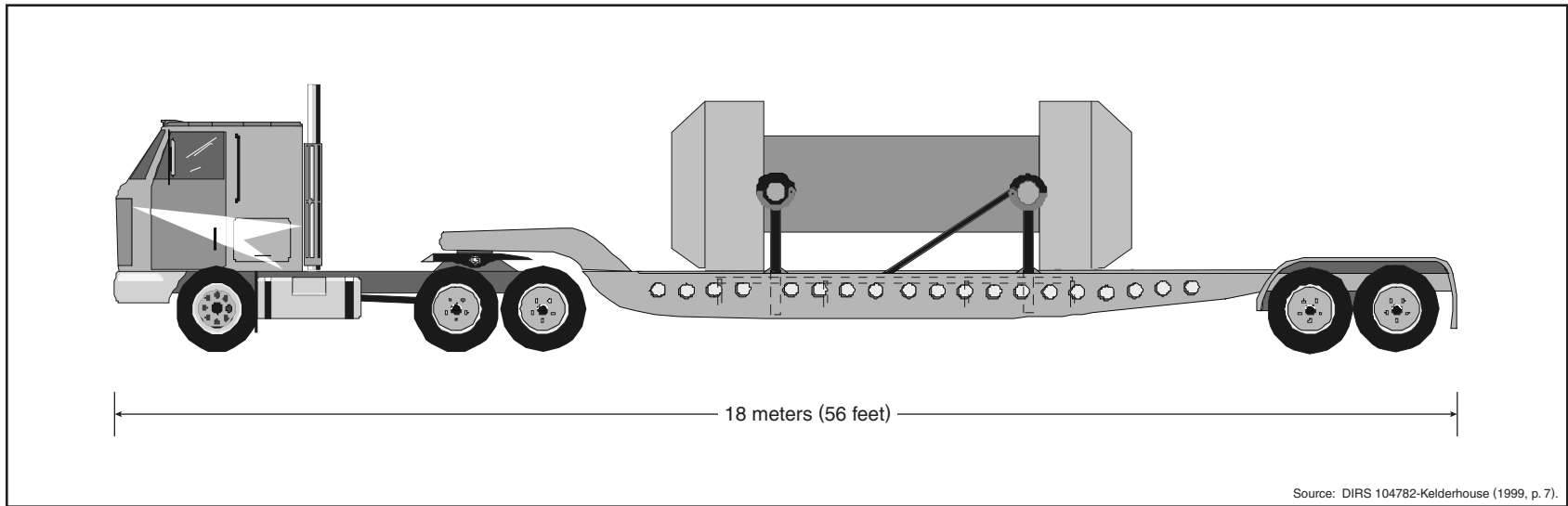

Figure J-3. Artist's conception of a truck cask on a legal-weight tractor-trailer truck.

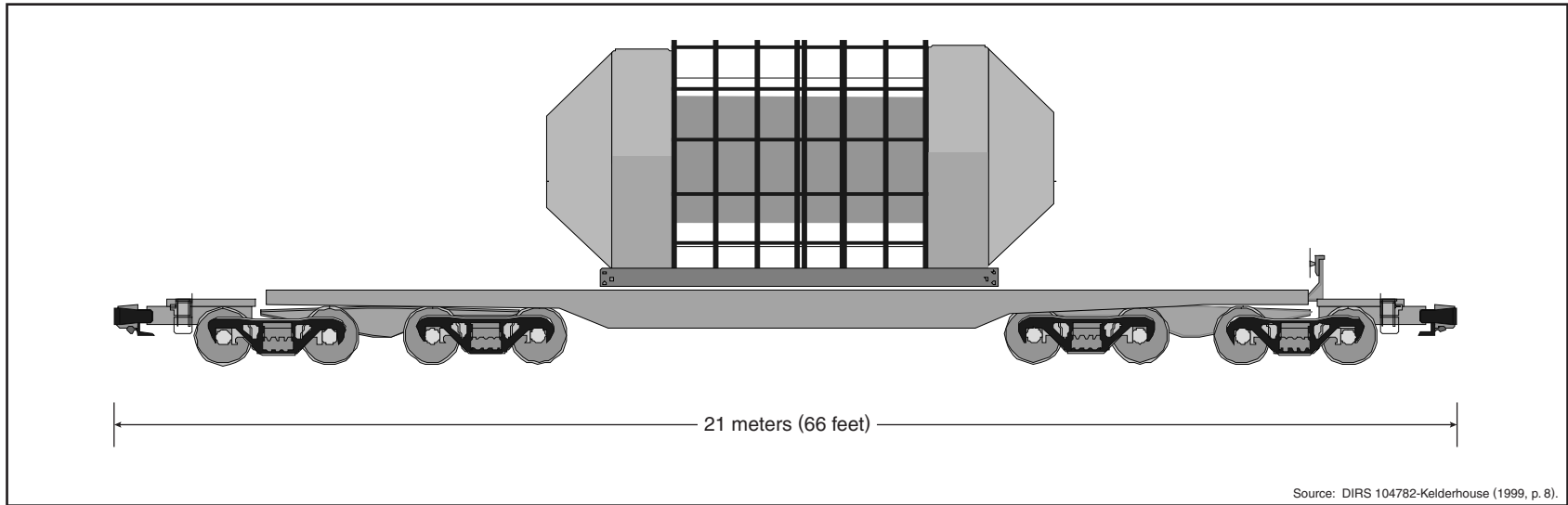

Figure J-4. Artist's conception of a large rail cask on a railcar.

Table J-3. Shipping cask configurations.

Shipping cask	Capacity (number of spent nuclear fuel assemblies)	Description ^{a,b}
<i>Rail</i>		
B-R-32-SP	32	BWR single-purpose shipping container
B-R-32-SP-HH	32	BWR single-purpose high-heat-capacity shipping container
B-R-44-SP	44	Medium BWR single-purpose shipping container
B-R-68-OV	68	Large BWR overpack shipping container
B-R-68-SP	68	Large BWR single-purpose shipping container
B-R-BP64-OV	64	Plant-unique overpack shipping container
B-R-HI68-OV	68	BWR HISTAR overpack shipping container
B-R-NAC56-OV	56	BWR NAC UMS overpack shipping container
P-R-12-SP	12	Small PWR single-purpose shipping container
P-R-12-SP-HH	12	Small PWR single-purpose high-heat-capacity shipping container
P-R-21-SP	21	Medium PWR single-purpose shipping container
P-R-24-OV	24	Large PWR overpack shipping container
P-R-24-SP	24	Large PWR single-purpose shipping container
P-R-7-SP-HH	7	PWR high heat shipping container
P-R-9-OV-MOX	9	PWR mixed-oxide overpack shipping container
P-R-9-SP-MOX	9	PWR mixed-oxide single-purpose shipping container
P-R-MP24-OV	24	PWR MP-187 (large) overpack shipping container
P-R-NAC26-OV	26	PWR NAC UMS overpack shipping container
P-R-ST17-SP	17	PWR plant-unique single-purpose shipping container
P-R-VSC24-OV	24	PWR Transtor ventilated storage cask overpack shipping container
P-R-WES21-OV	21	PWR WESFLEX overpack shipping container
P-R-YR36-OV	36	PWR plant-unique overpack shipping container
<i>Truck</i>		
B-T-9/9-SP	9	BWR single-purpose shipping container
B-T-9/7-SP	7	Derated BWR single-purpose shipping container
P-T-4/4-SP	4	Primary PWR single-purpose shipping container
P-T-4/3-SP	3	Derated PWR single-purpose shipping container
P-T-4/2-SP	2	Derated PWR single-purpose shipping container
P-T-4/4-SP-ST	4	PWR plant-unique single-purpose shipping container
P-T-4/3-SP-ST	3	PWR Derated plant-unique single-purpose shipping container
P-T-4/4-SP-MOX	4	PWR Mixed-oxide single-purpose shipping container
P-T-4/4-SP-BP	1	PWR plant-unique single-purpose shipping container

a. Source: DIRS 157206-CRWMS M&O (2000, all).

b. BWR = boiling-water reactor; PWR = pressurized-water reactor; SNF = spent nuclear fuel.

exceeded the capabilities of one of the casks, the model reduced the cask’s capacity for the affected shipments. The reduction, which is sometimes referred to as cask derating, was needed to satisfy nuclear criticality, shielding, and thermal constraints. For shipments that DOE would make using specific casks, derating would be accomplished by partially filling the assigned casks in compliance with provisions of applicable Nuclear Regulatory Commission certificates of compliance. An example of derating is discussed in Section 5 of the GA-4 legal-weight truck shipping cask design report (DIRS 101831-General Atomics 1993, p. 5.5-1). The analysis addresses transport of two high-burnup or short cooling time pressurized-water reactor assemblies rather than four design basis assemblies.

RAIL SHIPMENTS

This appendix assumes that rail shipments of spent nuclear fuel would use large rail shipping casks, one per railcar. DOE anticipates that as many as five railcars with casks containing spent nuclear fuel or high-level radioactive waste would move together in individual trains with buffer cars and escort cars. For general freight service, a train would include other railcars with other materials. In dedicated (or special) service, trains would move only railcars containing spent nuclear fuel or high-level radioactive waste and the buffer and escort cars.

For the mostly rail scenario, six sites without sufficient crane capacity to lift a rail cask or without other factors such as sufficient floor loading capacity or ceiling height were assumed to ship by legal-weight truck. However, the analysis assumed that these sites would be upgraded to handle rail casks once the reactors were shut down, and all remaining spent nuclear fuel would ship by rail. Of these six sites, two are direct rail and four are indirect rail sites. Of the four with indirect rail access, three have access to a navigable waterway. The 24 sites with sufficient crane capacity but without direct rail access were assumed to ship by heavy-haul truck to the nearest railhead. Of these 24 sites, 17 with access to navigable waterways were analyzed for shipping by barge to a railhead (see Section J.2.4). The number of rail shipments (direct or indirect) was estimated based on each site using the largest cask size feasible based on the load capacity of its cask handling crane. In calculating the number of shipments from the sites, the model used the *Acceptance, Priority Ranking & Annual Capacity Report* (DIRS 104382-DOE 1995, all). Using CALVIN, the number of shipments of legal-weight truck casks (Figure J-3) of commercial spent nuclear fuel estimated for the Proposed Action (63,000 MTHM of commercial spent nuclear fuel) for the mostly legal-weight truck scenario, would be about 15,000 containing boiling-water reactor assemblies and 26,000 containing pressurized-water reactor assemblies. Under Inventory Modules 1 and 2, for which approximately 105,000 MTHM of commercial spent nuclear fuel would be shipped to the repository (see Appendix A), the estimated number of shipments for the mostly legal-weight truck scenario would be 29,000 for boiling-water reactor spent nuclear fuel and 51,000 for pressurized-water reactor spent nuclear fuel. Table J-4 lists the number of shipments of commercial spent nuclear fuel for the mostly legal-weight truck scenario. Specifically, it lists the site, plant, and state where shipments would originate, the total number of shipments from each site, and the type of spent nuclear fuel that would be shipped. A total of 72 commercial sites with 104 plants (or facilities) are listed in the table.

The number of shipments of truck and rail casks (Figure J-4) of commercial spent nuclear fuel estimated for the Proposed Action for the mostly rail scenario would be approximately 2,700 for boiling-water reactor spent nuclear fuel and 5,600 for pressurized-water reactor spent nuclear fuel. Under Modules 1 and 2, the estimated number of shipments for the mostly rail scenario would be approximately 5,400 containing boiling-water reactor spent nuclear fuel and 10,700 containing pressurized-water reactor spent nuclear fuel. Table J-5 lists the number of shipments for the mostly rail scenario. It also lists the site and state where shipments would originate, the total number of shipments from each site, the size of rail cask assumed for each site, and the type of spent nuclear fuel that would be shipped. In addition, it lists the 24 sites not served by a railroad that would ship rail casks by barge or heavy-haul trucks to a nearby railhead and the 6 commercial sites without capability to load a rail cask.

J.1.2.1.2 DOE Spent Nuclear Fuel and High-Level Radioactive Waste

To estimate the number of DOE spent nuclear fuel and high-level radioactive waste shipments, the analysis used the number of handling units or number of canisters and the number of canisters per shipment reported by the DOE sites in 1998 (see Appendix A, p. A-34; DIRS 104778-Jensen 1998, all). To determine the number of shipments of DOE spent nuclear fuel and high-level radioactive waste, the analysis assumed one canister would be shipped in a legal-weight truck cask. For rail shipments, the analysis assumed that five 61-centimeter (24-inch)-diameter high-level radioactive waste canisters would be shipped in a rail cask. For rail shipments of DOE spent nuclear fuel, the analysis assumed that rail casks would contain nine approximately 46-centimeter (18-inch) canisters or four approximately 61-centimeter canisters. The number of DOE spent nuclear fuel canisters of each size is presented in Appendix A.

Under the mostly legal-weight truck scenario for the Proposed Action, DOE would transport a total of 11,785 truck shipments of DOE spent nuclear fuel and high-level radioactive waste (one high-level waste canister per shipment) to the repository. In addition, DOE would transport 300 shipments of naval spent nuclear fuel by rail from the Idaho National Engineering and Environmental Laboratory to the repository

Table J-4. Shipments of commercial spent nuclear fuel, mostly legal-weight truck scenario^a
(page 1 of 2).

Site	Reactor	State	Fuel type	Proposed Action (2010-2033)	Modules 1 and 2 (2010-2048)
Browns Ferry	Browns Ferry 1	AL	B ^b	738	1,550
	Browns Ferry 3	AL	B	324	807
Joseph M. Farley	Joseph M. Farley 1	AL	P ^c	363	779
	Joseph M. Farley 2	AL	P	330	843
Arkansas Nuclear One	Arkansas Nuclear One, Unit 1	AR	P	362	645
	Arkansas Nuclear One, Unit 2	AR	P	432	905
Palo Verde	Palo Verde 1	AZ	P	383	694
	Palo Verde 2	AZ	P	375	691
	Palo Verde 3	AZ	P	360	716
Diablo Canyon	Diablo Canyon 1	CA	P	359	971
	Diablo Canyon 2	CA	P	370	1,130
Humboldt Bay	Humboldt Bay	CA	B	44	44
Rancho Seco	Rancho Seco 1	CA	P	124	124
San Onofre	San Onofre 1	CA	P	52	52
	San Onofre 2	CA	P	408	817
	San Onofre 3	CA	P	393	829
Haddam Neck	Haddam Neck	CT	P	255	255
Millstone	Millstone 1	CT	B	321	321
	Millstone 2	CT	P	361	694
	Millstone 3	CT	P	310	1,008
Crystal River	Crystal River 3	FL	P	277	621
St. Lucie	St. Lucie 1	FL	P	426	849
	St. Lucie 2	FL	P	380	987
Turkey Point	Turkey Point 3	FL	P	291	574
	Turkey Point 4	FL	P	292	570
Edwin I. Hatch	Edwin I. Hatch 1	GA	B	939	1,820
Vogtle	Vogtle 1	GA	P	725	1,379
Duane Arnold	Duane Arnold	IA	B	324	576
Braidwood	Braidwood 1	IL	P	565	1,142
Byron	Byron 1	IL	P	617	1,136
Clinton	Clinton 1	IL	B	363	636
Dresden/Morris	Dresden 1	IL	B	76	76
	Dresden 2	IL	B	459	726
	Dresden 3	IL	B	514	760
	Morris ^d	IL	B	319	319
	Morris ^d	IL	P	88	88
LaSalle	LaSalle 1	IL	B	769	2,080
Quad Cities	Quad Cities 1	IL	B	979	1,567
Zion	Zion 1	IL	P	557	557
Wolf Creek	Wolf Creek 1	KS	P	396	678
River Bend	River Bend 1	LA	B	353	636
Waterford	Waterford 3	LA	P	374	607
Pilgrim	Pilgrim 1	MA	B	322	575
Yankee-Rowe	Yankee-Rowe 1	MA	P	134	134
Calvert Cliffs	Calvert Cliffs 1	MD	P	867	1,612
Maine Yankee	Maine Yankee	ME	P	356	356
Big Rock Point	Big Rock Point	MI	B	110	111
D. C. Cook	D. C. Cook 1	MI	P	832	1,759
Fermi	Fermi 2	MI	B	377	662
Palisades	Palisades	MI	P	409	660
Monticello	Monticello	MN	B	257	435
Prairie Island	Prairie Island 1	MN	P	665	1,109
Callaway	Callaway 1	MO	P	435	701
Grand Gulf	Grand Gulf 1	MS	B	592	1,383
Brunswick	Brunswick 1	NC	P	40	40
	Brunswick 2	NC	P	36	36
	Brunswick 1	NC	B	281	702
	Brunswick 2	NC	B	282	657

Table J-4. Shipments of commercial spent nuclear fuel, mostly legal-weight truck scenario^a
(page 2 of 2).

Site	Reactor	State	Fuel type	Proposed Action (2010-2033)	Modules 1 and 2 (2010-2048)
Shearon Harris	Shearon Harris 1	NC	P	289	549
	Shearon Harris	NC	B	152	152
McGuire	McGuire 1	NC	P	372	932
	McGuire 2	NC	P	419	1,069
Cooper Station	Cooper Station	NE	B	272	621
Fort Calhoun	Fort Calhoun	NE	P	260	457
Seabrook	Seabrook 1	NH	P	277	590
Oyster Creek	Oyster Creek 1	NJ	B	451	658
Salem/Hope Creek	Salem 1	NJ	P	329	725
	Salem 2	NJ	P	304	826
	Hope Creek	NJ	B	444	796
James A. FitzPatrick/ Nine Mile Point	James A. FitzPatrick	NY	B	413	732
	Nine Mile Point 1	NY	B	426	628
	Nine Mile Point 2	NY	B	387	722
GINNA	GINNA	NY	P	320	472
Indian Point	Indian Point 1	NY	P	40	40
	Indian Point 2	NY	P	400	805
	Indian Point 3	NY	P	285	694
Davis-Besse	Davis-Besse 1	OH	P	343	786
Perry	Perry 1	OH	B	293	528
Trojan	Trojan	OR	P	195	195
Beaver Valley	Beaver Valley 1	PA	P	309	649
	Beaver Valley 2	PA	P	248	472
Limerick	Limerick 1	PA	B	740	1,354
Peach Bottom	Peach Bottom 2	PA	B	567	1,023
	Peach Bottom 3	PA	B	575	1,035
Susquehanna	Susquehanna 1	PA	B	1,044	2,482
Three Mile Island	Three Mile Island 1	PA	P	320	654
Catawba	Catawba 1	SC	P	327	555
	Catawba 2	SC	P	310	574
Oconee	Oconee 1	SC	P	970	1,668
	Oconee 3	SC	P	324	666
H. B. Robinson	H. B. Robinson 2	SC	P	249	470
Summer	Summer 1	SC	P	281	713
Sequoyah	Sequoyah	TN	P	644	1,768
Watts Bar	Watts Bar 1	TN	P	158	552
Comanche Peak	Comanche Peak 1	TX	P	665	1,409
South Texas	South Texas 1	TX	P	271	614
	South Texas 2	TX	P	257	590
North Anna	North Anna 1	VA	P	675	1,588
Surry	Surry 1	VA	P	863	1,457
Vermont Yankee	Vermont Yankee 1	VT	B	380	613
Columbia Generating Station	Columbia Generating Station	WA	B	415	1,006
Kewaunee	Kewaunee	WI	P	306	516
LaCrosse	LaCrosse	WI	B	37	37
Point Beach	Point Beach	WI	P	653	1,051
Total BWR ^b				15,229	28,719
Total PWR ^c				25,772	50,965

- a. Source: DIRS 157206-CRWMS M&O (2000, all).
- b. B = boiling-water reactor (BWR).
- c. P = pressurized-water reactor (PWR).
- d. Morris is a storage facility located close to the three Dresden reactors.

Table J-5. Shipments of commercial spent nuclear fuel, mostly rail scenario^a (page 1 of 2).

Site	Reactor	State	Fuel type	Cask	Proposed Action 2010 - 2033	Modules 1 and 2 2010 - 2048
Browns Ferry	Browns Ferry 1	AL	B ^b	Rail	122	247
	Browns Ferry 3	AL	B	Rail	51	120
Joseph M. Farley	Joseph M. Farley 1	AL	P ^c	Rail	57	132
	Joseph M. Farley 2	AL	P	Rail	53	131
Arkansas Nuclear One	Arkansas Nuclear One, Unit 1	AR	P	Rail	57	108
	Arkansas Nuclear One, Unit 2	AR	P	Rail	64	149
Palo Verde	Palo Verde 1	AZ	P	Rail	65	97
	Palo Verde 2	AZ	P	Rail	62	94
	Palo Verde 3	AZ	P	Rail	66	102
Diablo Canyon	Diablo Canyon 1	CA	P	Rail	60	148
	Diablo Canyon 2	CA	P	Rail	61	160
Humboldt Bay	Humboldt Bay	CA	B	Rail	6	6
Rancho Seco	Rancho Seco 1	CA	P	Rail	21	21
San Onofre	San Onofre 1	CA	P	Rail	9	9
	San Onofre 2	CA	P	Rail	65	131
	San Onofre 3	CA	P	Rail	64	137
Haddam Neck Millstone	Haddam Neck	CT	P	Rail	40	40
	Millstone 1	CT	B	Rail	91	91
	Millstone 2	CT	P	Rail	115	199
	Millstone 3	CT	P	Rail	49	138
Crystal River	Crystal River 3	FL	P	Rail	25	17
Crystal River	Crystal River 3	FL	P	Truck	133	437
St. Lucie	St. Lucie 1	FL	P	Rail	12	13
St. Lucie	St. Lucie 1	FL	P	Truck	358	751
	St. Lucie 2	FL	P	Rail	61	147
Turkey Point	Turkey Point 3	FL	P	Rail	52	85
	Turkey Point 4	FL	P	Rail	52	86
Edwin I. Hatch	Edwin I. Hatch 1	GA	B	Rail	116	288
Vogtle	Vogtle 1	GA	P	Rail	205	283
Duane Arnold	Duane Arnold	IA	B	Rail	57	129
Braidwood	Braidwood 1	IL	P	Rail	94	162
Byron	Byron 1	IL	P	Rail	101	159
Clinton	Clinton 1	IL	B	Rail	59	87
Dresden/Morris	Dresden 1	IL	B	Rail	11	11
	Dresden 2	IL	B	Rail	83	158
	Dresden 3	IL	B	Rail	89	160
	Morris ^d	IL	B	Rail	43	43
	Morris ^d	IL	P	Rail	15	15
LaSalle	LaSalle 1	IL	B	Rail	101	305
Quad Cities	Quad Cities 1	IL	B	Rail	172	329
Zion	Zion 1	IL	P	Rail	93	93
Wolf Creek	Wolf Creek 1	KS	P	Rail	63	97
River Bend	River Bend 1	LA	B	Rail	57	87
Waterford	Waterford 3	LA	P	Rail	66	93
Pilgrim	Pilgrim 1	MA	B	Rail	24	18
Pilgrim	Pilgrim 1	MA	B	Truck	154	394
Yankee-Rowe	Yankee-Rowe 1	MA	P	Rail	15	15
Calvert Cliffs	Calvert Cliffs 1	MD	P	Rail	169	320
Maine Yankee	Maine Yankee	ME	P	Rail	55	55
Big Rock Point	Big Rock Point	MI	B	Rail	7	7
D. C. Cook	D. C. Cook 1	MI	P	Rail	149	268
Fermi	Fermi 2	MI	B	Rail	61	91
Palisades	Palisades	MI	P	Rail	70	122
Monticello	Monticello	MN	B	Rail	32	19
Monticello	Monticello	MN	B	Truck	8	250
Prairie Island	Prairie Island 1	MN	P	Rail	103	205
Callaway	Callaway 1	MO	P	Rail	71	101
Grand Gulf	Grand Gulf 1	MS	B	Rail	80	215

Table J-5. Shipments of commercial spent nuclear fuel, mostly rail scenario^a (page 2 of 2).

Site	Reactor	State	Fuel type	Cask	Proposed Action 2010 - 2033	Modules 1 and 2 2010 - 2048
Brunswick	Brunswick 1	NC	P ^c	Rail	14	14
	Brunswick 2	NC	P	Rail	12	12
	Brunswick 1	NC	B ^b	Rail	78	142
	Brunswick 2	NC	B	Rail	78	140
Shearon Harris	Shearon Harris 1	NC	P	Rail	89	146
	Shearon Harris	NC	B	Rail	43	43
McGuire	McGuire 1	NC	P	Rail	83	164
	McGuire 2	NC	P	Rail	89	173
Cooper Station	Cooper Station	NE	B	Rail	42	124
Fort Calhoun	Fort Calhoun	NE	P	Rail	61	120
Seabrook	Seabrook 1	NH	P	Rail	49	80
Oyster Creek	Oyster Creek 1	NJ	B	Rail	64	110
Salem/Hope Creek	Salem 1	NJ	P	Rail	59	101
	Salem 2	NJ	P	Rail	54	108
	Hope Creek	NJ	B	Rail	67	105
	FitzPatrick	NY	B	Rail	60	121
James A. FitzPatrick/ Nine Mile Point	Nine Mile Point 1	NY	B	Rail	72	99
	Nine Mile Point 2	NY	B	Rail	65	105
Ginna	Ginna	NY	P	Rail	36	22
Ginna	Ginna	NY	P	Truck	91	297
Indian Point	Indian Point 1	NY	P	Truck	40	40
	Indian Point 2	NY	P	Rail	35	34
	Indian Point 2	NY	P	Truck	150	471
	Indian Point 3	NY	P	Rail	22	19
	Indian Point 3	NY	P	Truck	145	482
	Davis-Besse 1	OH	P	Rail	64	140
Davis-Besse	Davis-Besse 1	OH	P	Rail	64	140
Perry	Perry 1	OH	B	Rail	42	67
Trojan	Trojan	OR	P	Rail	33	33
Beaver Valley	Beaver Valley 1	PA	P	Rail	52	94
	Beaver Valley 2	PA	P	Rail	41	76
Limerick	Limerick 1	PA	B	Rail	148	216
Peach Bottom	Peach Bottom 2	PA	B	Rail	82	157
	Peach Bottom 3	PA	B	Rail	80	157
Susquehanna	Susquehanna 1	PA	B	Rail	201	460
Three Mile Island	Three Mile Island 1	PA	P	Rail	57	97
Catawba	Catawba 1	SC	P	Rail	70	109
	Catawba 2	SC	P	Rail	69	107
Oconee	Oconee 1	SC	P	Rail	208	353
	Oconee 3	SC	P	Rail	64	129
H. B. Robinson	H. B. Robinson 2	SC	P	Rail	82	128
Summer	Summer 1	SC	P	Rail	46	113
Sequoyah	Sequoyah	TN	P	Rail	95	275
Watts Bar	Watts Bar 1	TN	P	Rail	26	74
Comanche Peak	Comanche Peak 1	TX	P	Rail	154	250
South Texas	South Texas 1	TX	P	Rail	58	104
	South Texas 2	TX	P	Rail	57	105
North Anna	North Anna 1	VA	P	Rail	143	289
Surry	Surry 1	VA	P	Rail	197	330
Vermont Yankee	Vermont Yankee 1	VT	B	Rail	73	137
Columbia Generating Station	Columbia Generating Station	WA	B	Rail	77	159
Kewaunee	Kewaunee	WI	P	Rail	51	87
La Crosse	La Crosse	WI	B	Rail	5	5
Point Beach	Point Beach	WI	P	Rail	130	213
Total BWR ^b					2,701	5,402
Total PWR ^c					5,596	10,709

- a. Source: DIRS 157206-CRWMS M&O (2000, all).
- b. B = boiling-water reactor (BWR).
- c. P = pressurized-water reactor (PWR).
- d. Morris is a storage facility located close to the three Dresden reactors.

(one naval spent nuclear fuel canister per rail cask). For Modules 1 and 2 under the mostly legal-weight truck scenario, the analysis estimated 26,001 DOE spent nuclear fuel and high-level radioactive waste truck shipments, as well as the 300 naval spent nuclear fuel shipments by rail.

Under the mostly rail scenario for the Proposed Action, the analysis estimated that DOE would transport 2,128 railcar shipments of DOE spent nuclear fuel and high-level radioactive waste (five high-level waste canisters per shipment), as well as the 300 shipments of naval spent nuclear fuel. For Modules 1 and 2 under this scenario, DOE would transport 4,954 railcar shipments of DOE spent nuclear fuel and high-level radioactive waste, as well as the 300 shipments of naval spent nuclear fuel. Table J-6 lists the estimated number of shipments of DOE and naval spent nuclear fuel from each of the sites for both the Proposed Action and Modules 1 and 2. Table J-7 lists the number of shipments of high-level radioactive waste for the Proposed Action and for Modules 1 and 2.

Table J-6. DOE and naval spent nuclear fuel shipments by site.

Site	Proposed Action		Module 1 or 2	
	Mostly truck	Mostly rail	Mostly truck	Mostly rail
INEEL ^a	1,388 ^b	433	1,467 ^c	442
Savannah River Site	1,316	149	1,411	159
Hanford	754	147	809	157
Fort St. Vrain	312	36	334	38
Totals	3,770	765	4,021	796

- a. INEEL = Idaho National Engineering and Environmental Laboratory.
- b. Includes 1,088 truck shipments of DOE spent nuclear fuel and 300 railcar shipments of naval spent nuclear fuel.
- c. Includes 1,167 truck shipments of DOE spent nuclear fuel and 300 railcar shipments of naval spent nuclear fuel.

Table J-7. High-level radioactive waste shipments by site.^a

Site	Proposed Action		Module 1 or 2	
	Mostly truck ^b	Mostly rail ^c	Mostly truck ^b	Mostly rail ^c
INEEL ^d	0	0	1,292	260 ^e
Hanford	1,960	392	14,500	2,900
Savannah River Site	6,055	1,211	6,188	1,238
West Valley ^f	300	60	300	60
Totals	8,315	1,663	22,280	4,458

- a. The total U.S. inventory of high-level radioactive waste at the time of shipment would be 22,280 canisters. Under the Proposed Action, DOE would only ship 8,315 canisters. Under Inventory Module 1 or 2, DOE would ship the entire inventory.
- b. One canister per shipment.
- c. Five canisters per shipment.
- d. INEEL = Idaho National Engineering and Environmental Laboratory.
- e. 238 shipments of Idaho Nuclear Technology and Engineering Center glass form waste, 20 shipments of Argonne National Laboratory-West ceramic form waste, and 2 shipments of Argonne National Laboratory-West metallic form waste (see Appendix A, Section A.2.3.5.1).
- f. High-level radioactive waste at West Valley is commercial rather than DOE waste.

J.1.2.1.3 Greater-Than-Class-C and Special-Performance-Assessment-Required Waste Shipments

Reasonably foreseeable future actions could include shipment of Greater-Than-Class-C and Special-Performance-Assessment-Required waste to the Yucca Mountain Repository (Appendix A describes Greater-Than-Class-C and Special-Performance-Assessment-Required wastes). Commercial nuclear

powerplants, research reactors, radioisotope manufacturers, and other manufacturing and research institutions generate low-level radioactive waste that exceeds the Nuclear Regulatory Commission Class C shallow-land-burial disposal limits. In addition to DOE-held material, there are three other sources or categories of Greater-Than-Class-C low-level radioactive waste:

- Nuclear utilities
- Sealed sources
- Other generators

The activities of nuclear electric utilities and other radioactive waste generators to date have produced relatively small quantities of Greater-Than-Class-C low-level radioactive waste. As the utilities take their reactors out of service and decommission them, they could generate more waste of this type.

DOE Special-Performance-Assessment-Required low-level radioactive waste could include the following materials:

- Production reactor operating wastes
- Production and research reactor decommissioning wastes
- Non-fuel-bearing components of naval reactors
- Sealed radioisotope sources that exceed Class C limits for waste classification
- DOE isotope production-related wastes
- Research reactor fuel assembly hardware

The analysis estimated the number of shipments of Greater-Than-Class-C and Special-Performance-Assessment-Required waste by assuming that 10 cubic meters (about 350 cubic feet) would be shipped in a rail cask and 2 cubic meters (about 71 cubic feet) would be shipped in a truck cask. Table J-8 lists the resulting number of commercial Greater-Than-Class-C shipments in Inventory Module 2 for both truck and rail shipments. The shipments of Greater-Than-Class-C waste from commercial utilities would originate among the commercial reactor sites. Typically, boiling-water reactors would ship a total of about 9 cubic meters (about 318 cubic feet) of Greater-Than-Class-C waste per site, while pressurized-water reactors would ship about 20 cubic meters (about 710 cubic feet) per site (see Appendix A). The impacts of transporting this waste were examined for each reactor site. The analysis assumed that sealed sources and Greater-Than-Class-C waste identified as “other” would be shipped from the DOE Savannah River Site (see Table J-8).

Table J-8. Commercial Greater-Than-Class-C waste shipments.^a

Category	Truck	Rail
Commercial utilities	742	210
Sealed sources	121	25
Other	233	47
Totals	1,096	282

a. Source: Appendix A.

The analysis assumed DOE Special-Performance-Assessment-Required waste would be shipped from four DOE sites listed in Table J-9. Naval reactor and Argonne East Special-Performance-Assessment-Required waste is assumed to be shipped from the Idaho National Engineering and Environmental Laboratory.

Table J-9. DOE Special-Performance-Assessment-Required waste shipments.^a

Site ^b	Rail	Truck
Hanford	2	10
INEEL ^c	58	66
SRS (ORNL)	294	1,466
West Valley	56	276
Totals	410	1,763

- a. Source: Appendix A; rounded.
- b. Abbreviations: INEEL = Idaho National Engineering and Environmental Laboratory; SRS = Savannah River Site; ORNL = Oak Ridge National Laboratory.
- c. Includes 55 rail shipments of naval Special-Performance-Assessment-Required waste. These shipments would travel by rail regardless of scenario.

J.1.2.1.4 Sensitivity of Transportation Impacts to Number of Shipments

As discussed in Section J.1.2.1, the number of shipments from commercial and DOE sites to the repository would depend on the mix of legal-weight truck and rail shipments. At this time, many years before shipments could begin, it is impossible to predict the mix with a reasonable degree of accuracy. Therefore, the analysis used two scenarios to provide results that bound the range of anticipated impacts. Thus, for a mix of legal-weight truck and rail shipments within the range of the mostly legal-weight truck and mostly rail scenarios, the impacts would be likely to lie within the bounds of the impacts predicted by the analysis. For example, a mix that is different from the scenarios analyzed could consist of 10,000 legal-weight truck shipments and 8,000 rail shipments over 24 years (compared to approximately 1,100 and 9,600, respectively, for the mostly rail scenario). In this example, the number of traffic fatalities would be between 3.1 (estimated for the Proposed Action under the mostly rail scenario) and 4.5 (estimated for the mostly legal-weight truck scenario). Other examples that have different mixes within the ranges bounded by the scenarios would lead to results that would be within the range of the evaluated impacts.

In addition to mixes within the brackets, the number of shipments could fall outside the ranges used for the mostly legal-weight truck and rail transportation scenarios. If, for example, the mostly rail scenario used smaller rail casks than the analysis assumed, the number of shipments would be greater. If spent nuclear fuel was placed in the canisters before they were shipped, the added weight and size of the canisters would reduce the number of fuel assemblies that a given cask could accommodate; this would increase the number of shipments. However, for the mostly rail scenario, even if the capacity of the casks was half that used in the analysis, the impacts would remain below those forecast for the mostly legal-weight truck scenario. Although impacts would be related to the number of shipments, because the number of rail shipments would be very small in comparison to the total railcar traffic on the Nation's railroads, increases or decreases would be small for impacts to biological resources, air quality, hydrology, noise, and other environmental resource areas. Thus, the impacts of using smaller rail casks would be covered by the values estimated in this EIS.

For legal-weight truck shipments, the use of casks carrying smaller payloads than those used in the analysis (assuming the shipment of the same spent nuclear fuel) would lead to larger impacts for incident-free transportation and traffic fatalities and about the same level of radiological accident risk. The relationship is approximately linear; if the payloads of truck shipping casks in the mostly legal-weight truck scenario were less by one-half, the incident-free impacts would increase by approximately a factor of 2. Conversely, because the amount of radioactive material in a cask would be less (assuming shipment of the same spent nuclear fuel), the radiological consequences of maximum reasonably foreseeable accident scenarios would be less with the use of smaller casks. If smaller casks were used to

accommodate shipments of spent nuclear fuel with shorter cooling time and higher burnup, the radiological consequences of maximum reasonably foreseeable accident scenarios would be about the same.

J.1.2.2 Transportation Routes

At this time, about 10 years before shipments could begin, DOE has not determined the specific routes it would use to ship spent nuclear fuel and high-level radioactive waste to the proposed repository. Nonetheless, this analysis used current regulations governing highway shipments and historic rail industry practices to select existing highway and rail routes to estimate potential environmental impacts of national transportation. Routing for shipments of spent nuclear fuel and high-level radioactive waste to the proposed repository would comply with applicable regulations of the U.S. Department of Transportation and the Nuclear Regulatory Commission in effect at the time the shipments occurred, as stated in the proposed DOE revised policy and procedures (DIRS 104741-DOE 1998, all) for implementing Section 180(c) of the Nuclear Waste Policy Act, as amended (NWPA).

Approximately 4 years before shipments to the proposed repository began, the Office of Civilian Radioactive Waste Management plans to identify the preliminary routes that DOE anticipates using in state and tribal jurisdictions so it can notify governors and tribal leaders of their eligibility for assistance under the provisions of Section 180(c) of the NWPA. DOE has published a revised proposed policy statement that sets forth its revised plan for implementing a program of technical and financial assistance to states and Native American tribes for training public safety officials of appropriate units of local government and tribes through whose jurisdictions the Department plans to transport spent nuclear fuel or high-level radioactive waste (63 *FR* 23756, January 2, 1998) (see Appendix M, Section M.8).

The analysis of impacts of the Proposed Action and Modules 1 and 2 used characteristics of routes that shipments of spent nuclear fuel and high-level radioactive waste could travel from the originating sites listed in Tables J-4 through J-7. Existing routes that could be used were identified for the mostly legal-weight truck and mostly rail transportation scenarios and included the 10 rail and heavy-haul truck implementing alternatives evaluated in the EIS for transportation in Nevada. The route characteristics used were the transportation mode (highway, railroad, or navigable waterway) and, for each of the modes, the total distance between an originating site and the repository. In addition, the analysis estimated the fraction of travel that would occur in rural, suburban, and urban areas for each route. The fraction of travel in each population zone was determined using 1990 Census data (see Section J.1.1.2 and J.1.1.3) to identify population-zone impacts for route segments. The highway routes were selected for the analysis using the HIGHWAY computer program and routing requirements of the U.S. Department of Transportation for shipments of Highway Route-Controlled Quantities of Radioactive Materials (49 CFR 397.101). Shipments of spent nuclear fuel and high-level radioactive waste would contain Highway Route-Controlled Quantities of Radioactive Materials.

J.1.2.2.1 Routes Used in the Analysis

Routes used in the analysis of transportation impacts of the Proposed Action and Inventory Modules 1 and 2 are highways and rail lines that DOE anticipates it could use for legal-weight truck or rail shipments from each origin to Nevada. For rail shipments that would originate at sites not served by railroads, routes used for analysis include highway routes for heavy-haul trucks or barge routes from the sites to railheads. Figures J-5 and J-6 show the truck and rail routes, respectively, analyzed for the Proposed Action and Inventory Modules 1 and 2. Tables J-10 and J-11 list the lengths of trips and the distances of the highway and rail routes, respectively, in rural, suburban, and urban population zones. Sites that would be capable of loading rail casks, but that do not have direct rail access, are listed in Table J-11. The analysis used six ending rail nodes in Nevada (Beowawe, Caliente, Dry Lake, Eccles,

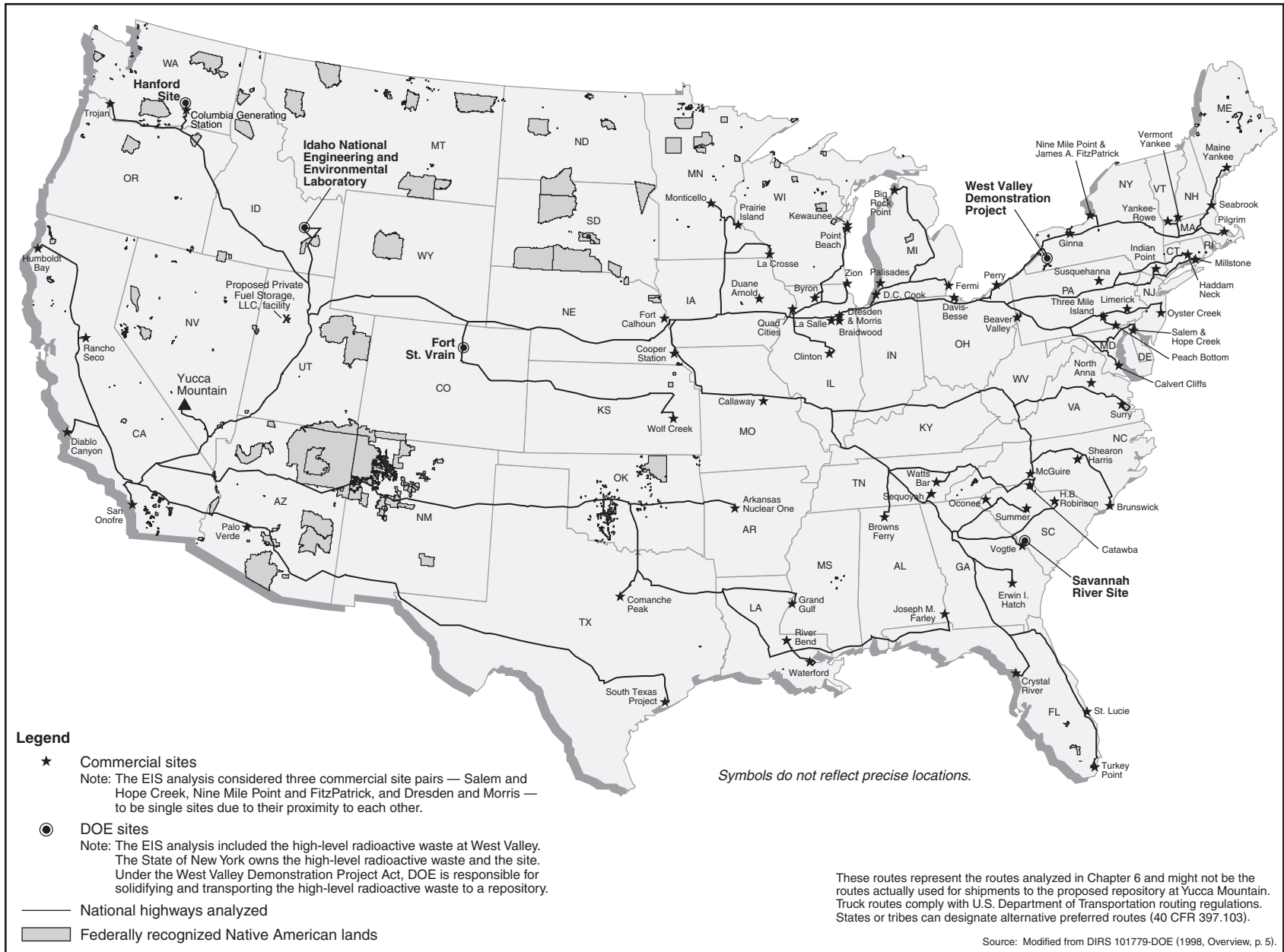

Figure J-5. Representative truck routes from commercial and DOE sites to Yucca Mountain analyzed for the Proposed Action and Inventory Modules 1 and 2.

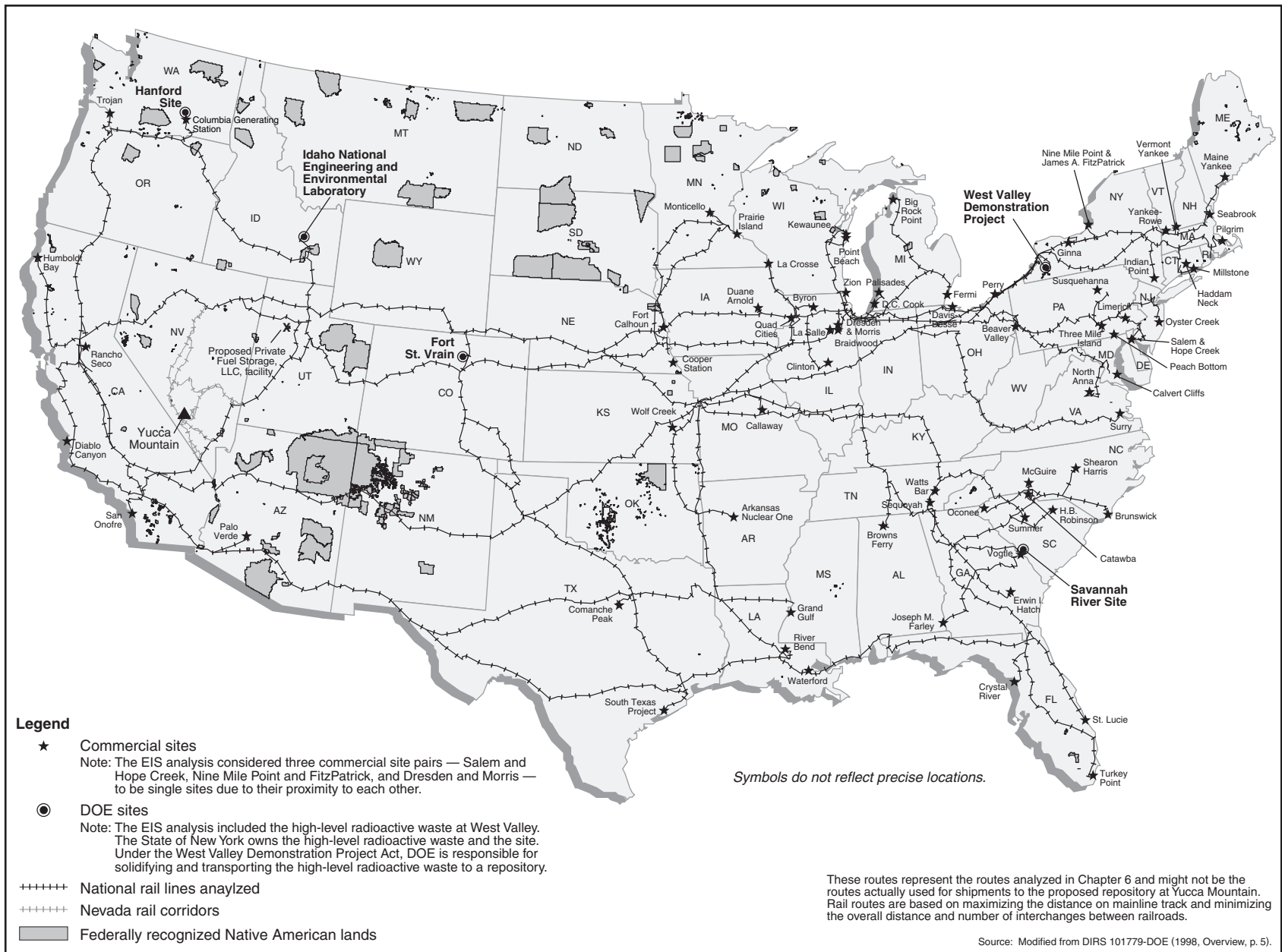

Figure J-6. Representative rail routes from commercial and DOE sites to Yucca Mountain analyzed for the Proposed Action and Inventory Modules 1 and 2.

Table J-10. Highway distances for legal-weight truck shipments from commercial and DOE sites to Yucca Mountain, mostly legal-weight truck transportation (kilometers)^{a,b} (page 1 of 2).

Origin	State	Total ^c	Rural	Suburban	Urban
Browns Ferry	AL	3,798	3,344	393	61
Joseph M. Farley	AL	4,149	3,617	463	69
Arkansas Nuclear One	AR	2,810	2,588	191	30
Palo Verde	AZ	1,007	886	100	21
Diablo Canyon	CA	1,015	828	119	68
Humboldt Bay	CA	1,749	1,465	192	92
Rancho Seco	CA	1,228	1,028	124	76
San Onofre	CA	694	517	89	87
Haddam Neck	CT	4,519	3,708	736	75
Millstone	CT	4,527	3,673	746	109
Crystal River	FL	4,675	3,928	672	75
St. Lucie	FL	4,944	4,115	748	80
Turkey Point	FL	5,198	4,210	840	148
Edwin I. Hatch	GA	4,342	3,695	572	74
Vogtle	GA	4,294	3,623	592	79
Duane Arnold	IA	2,773	2,544	189	40
Braidwood	IL	3,063	2,796	231	36
Byron	IL	3,032	2,773	223	36
Clinton	IL	3,104	2,814	252	38
Dresden/Morris	IL	3,059	2,798	225	36
La Salle	IL	3,017	2,766	215	36
Quad Cities	IL	2,877	2,631	211	36
Zion	IL	3,167	2,834	284	50
Wolf Creek	KS	2,686	2,474	173	38
River Bend	LA	3,479	3,097	322	60
Waterford	LA	3,565	3,159	346	59
Pilgrim	MA	4,722	3,697	930	94
Yankee-Rowe	MA	4,615	3,692	831	92
Calvert Cliffs	MD	4,278	3,511	684	82
Maine Yankee	ME	4,894	3,733	1,052	108
Big Rock Point	MI	3,866	3,266	547	52
D. C. Cook	MI	3,196	2,827	318	51
Fermi	MI	3,524	3,014	449	61
Palisades	MI	3,244	2,855	338	51
Monticello	MN	3,003	2,702	261	41
Prairie Island	MN	2,993	2,720	232	41
Callaway	MO	2,988	2,721	225	43
Grand Gulf	MS	3,354	2,989	311	54
Brunswick	NC	4,773	3,994	696	82
Shearon Harris	NC	4,543	3,815	649	79
McGuire	NC	4,347	3,737	535	74
Cooper Station	NE	2,523	2,328	160	36
Fort Calhoun	NE	2,348	2,165	148	35
Seabrook	NH	4,725	3,675	942	107
Oyster Creek	NJ	4,424	3,530	825	69
Salem/Hope Creek	NJ	4,350	3,531	739	79
Ginna	NY	4,089	3,356	642	91
Indian Point	NY	4,382	3,695	620	67
James A. FitzPatrick/ Nine Mile Point	NY	4,234	3,461	688	85

Table J-10. Highway distances for legal-weight truck shipments from commercial and DOE sites to Yucca Mountain, mostly legal-weight truck transportation (kilometers)^{a,b} (page 2 of 2).

Origin	State	Total ^c	Rural	Suburban	Urban
Davis-Besse	OH	3,520	3,106	358	55
Perry	OH	3,693	3,157	464	73
Trojan	OR	2,137	1,865	236	36
Beaver Valley	PA	3,779	3,214	500	64
Limerick	PA	4,287	3,484	741	62
Peach Bottom	PA	4,205	3,479	662	63
Susquehanna	PA	4,126	3,539	528	59
Three Mile Island	PA	4,147	3,443	643	60
Catawba	SC	4,350	3,686	594	70
Oconee	SC	4,208	3,586	551	71
H. B. Robinson	SC	4,467	3,739	647	81
Summer	SC	4,352	3,704	576	71
Sequoyah	TN	3,856	3,361	433	61
Watts Bar	TN	3,933	3,460	413	61
Comanche Peak	TX	2,794	2,547	213	34
South Texas	TX	3,011	2,652	295	64
North Anna	VA	4,437	3,825	533	79
Surry	VA	4,611	3,898	629	83
Vermont Yankee	VT	4,615	3,675	846	94
Colombia Generating Station	WA	1,880	1,669	178	32
Kewaunee	WI	3,347	2,978	314	55
La Crosse	WI	3,014	2,773	198	43
Point Beach	WI	3,341	2,972	314	55
Ft. St. Vrain ^d	CO	1,637	1,501	108	28
INEEL ^e	ID	1,201	1,044	129	27
West Valley ^f	NY	3,959	3,322	562	75
Savannah River ^e	SC	4,294	3,622	593	79
Hanford ^e	WA	1,881	1,671	178	32

- a. To convert kilometers to miles, multiply by 0.62137.
- b. Distances determined for purposes of analysis using HIGHWAY computer program.
- c. Totals might differ from sums due to method of calculation and rounding.
- d. DOE spent nuclear fuel site.
- e. DOE spent nuclear fuel and high-level radioactive waste site.
- f. High-level radioactive waste site.

Jean, and Apex) to select rail routes from the 77 sites. These rail nodes would be starting points for the rail and heavy-haul truck implementing alternatives analyzed for transportation in Nevada.

Selection of Highway Routes. The analysis of national transportation impacts used route characteristics of existing highways, such as distances, population densities, and state-level accident statistics. The analysis of highway shipments of spent nuclear fuel and high-level radioactive waste used the HIGHWAY computer model (DIRS 104780-Johnson et al. 1993, all) to determine highway routes using regulations of the U.S. Department of Transportation (49 CFR 397.101) that specify how routes are selected. The selection of “preferred routes” is required for shipment of these materials. DOE has determined that the HIGHWAY program is appropriate for calculating highway routes and related information (DIRS 101845-Maheras and Pippen 1995, pp. 2 to 5). HIGHWAY is a routing tool that DOE has used in previous EISs [for example, the programmatic EIS on spent nuclear fuel (DIRS 101802-DOE 1995, Volume 1, p. I-6) and the Waste Isolation Pilot Plant Supplement II EIS (DIRS 101814-DOE 1997, pp. 5 to 13)] to determine highway routes for impact analysis.

Table J-11. Rail transportation distances from commercial and DOE sites to Nevada ending rail nodes^a (kilometers)^{b,c} (page 1 of 3).

Site	Total ^d	Rural	Suburban	Urban
<i>Commercial sites with direct rail access</i>				
Arkansas Nuclear One	2,593 - 2,930	2,427 - 2,720	149 - 181	17 - 29
Beaver Valley	3,242 - 3,579	2,675 - 2,968	452 - 484	115 - 127
Braidwood	2,586 - 2,923	2,260 - 2,553	253 - 286	73 - 85
Brunswick	4,145 - 4,482	3,363 - 3,656	721 - 753	60 - 72
Byron	2,403 - 2,740	2,207 - 2,500	172 - 204	24 - 35
Catawba	3,819 - 4,156	3,265 - 3,559	495 - 527	59 - 70
Clinton	2,595 - 2,932	2,358 - 2,651	196 - 228	41 - 53
Columbia Generating Station	1,369 - 1,706	1,274 - 1,567	84 - 116	11 - 22
Comanche Peak	2,492 - 2,678	2,218 - 2,401	213 - 236	37 - 43
Crystal River	4,175 - 4,653	3,481 - 3,960	587 - 672	55 - 106
D. C. Cook	2,632 - 2,969	2,261 - 2,555	277 - 309	94 - 105
Davis Besse	2,917 - 3,254	2,452 - 2,745	356 - 389	109 - 121
Dresden/Morris	2,510 - 2,847	2,253 - 2,546	222 - 255	35 - 46
Duane Arnold	2,168 - 2,505	2,014 - 2,307	135 - 167	20 - 31
Edwin I. Hatch	3,929 - 4,266	3,396 - 3,689	480 - 513	53 - 64
Fermi	3,072 - 3,409	2,513 - 2,806	437 - 469	123 - 135
H. B. Robinson	3,889 - 4,226	3,137 - 3,430	685 - 717	68 - 79
Humboldt Bay	724 - 1,412	550 - 1,093	137 - 239	36 - 80
James A. FitzPatrick/Nine Mile Point	3,632 - 3,969	2,848 - 3,141	631 - 663	154 - 165
Joseph M. Farley	4,021 - 4,358	3,438 - 3,731	529 - 561	54 - 66
La Crosse	2,851 - 3,579	2,578 - 3,361	196 - 234	22 - 39
La Salle	2,653 - 3,381	2,396 - 3,179	181 - 220	20 - 37
Limerick	3,934 - 4,271	3,148 - 3,441	664 - 696	123 - 135
Maine Yankee	4,435 - 4,771	3,245 - 3,538	1,008 - 1,040	182 - 193
McGuire	3,916 - 4,253	3,170 - 3,463	679 - 712	66 - 78
Millstone	4,139 - 4,476	3,078 - 3,371	893 - 925	168 - 179
Monticello	2,655 - 2,822	2,347 - 2,543	241 - 265	38 - 44
North Anna	3,944 - 4,281	3,132 - 3,425	639 - 672	172 - 184
Palo Verde	872 - 1,466	778 - 1,113	77 - 252	18 - 101
Perry	3,222 - 3,558	2,836 - 3,129	317 - 349	69 - 80
Prairie Island	2,344 - 2,681	2,100 - 2,393	223 - 255	22 - 33
Quad Cities	2,595 - 3,323	2,324 - 3,108	194 - 233	21 - 38
Rancho Seco	263 - 882	178 - 694	61 - 139	24 - 48
River Bend	3,266 - 3,405	2,966 - 3,027	268 - 358	28 - 68
San Onofre	472 - 1,133	322 - 756	93 - 264	58 - 112
Seabrook	4,282 - 4,619	3,183 - 3,477	920 - 952	179 - 190
Sequoyah	3,366 - 3,703	3,044 - 3,337	277 - 309	46 - 57
Shearon Harris	4,046 - 4,383	3,301 - 3,595	686 - 718	59 - 70
South Texas	2,815 - 3,277	2,539 - 2,770	234 - 434	42 - 73
Summer	3,755 - 4,092	3,291 - 3,584	414 - 446	50 - 62
Susquehanna	3,827 - 4,164	2,883 - 3,176	771 - 803	173 - 185
Three Mile Island	3,828 - 4,165	3,129 - 3,422	588 - 620	111 - 123
Trojan	1,326 - 2,048	1,040 - 1,836	172 - 346	40 - 108
Vermont Yankee	4,078 - 4,415	3,135 - 3,429	778 - 811	164 - 176
Vogtle	3,985 - 4,322	3,443 - 3,736	489 - 522	53 - 64
Waterford	3,408 - 3,540	2,878 - 3,086	293 - 453	63 - 76
Watts Bar	3,310 - 3,647	3,011 - 3,304	254 - 286	46 - 57
Wolf Creek	2,108 - 2,445	1,995 - 2,288	98 - 130	15 - 27
Zion	2,542 - 2,879	2,231 - 2,525	247 - 279	64 - 75

Table J-11. Rail transportation distances from commercial and DOE sites to Nevada ending rail nodes^a (kilometers)^{b,c} (page 2 of 3).

Site	Total ^d	Rural	Suburban	Urban
<i>Commercial sites with indirect rail access</i>				
Big Rock Point HH ^e -20.0 kilometers	3,258 - 3,595	2,766 - 3,059	399 - 431	93 - 105
Browns Ferry HH-55.4 kilometers	3,118 - 3,455	2,723 - 3,016	353 - 386	42 - 53
Callaway HH-18.5 kilometers	2,230 - 2,567	2,103 - 2,396	108 - 140	20 - 32
Calvert Cliffs HH-41.9 kilometers	3,829 - 4,166	3,024 - 3,317	631 - 663	174 - 185
Cooper Station HH-53.8 kilometers	1,852 - 2,189	1,719 - 2,012	109 - 141	25 - 36
Diablo Canyon HH-43.5 kilometers	715 - 789	461 - 522	162 - 181	73 - 105
Fort Calhoun HH-6.0 kilometers	1,736 - 2,073	1,656 - 1,949	70 - 102	10 - 21
Ginna HH-35.1 kilometers	3,532 - 3,869	2,792 - 3,086	604 - 636	136 - 147
Grand Gulf HH-47.8 kilometers	3,108 - 3,445	2,817 - 3,115	259 - 373	28 - 67
Haddam Neck HH-16.6 kilometers	4,105 - 4,442	3,070 - 3,363	868 - 901	167 - 178
Hope Creek HH-51.0 kilometers	3,978 - 4,315	2,842 - 3,135	912 - 944	225 - 236
Indian Point HH-14.2 kilometers	3,981 - 4,318	3,034 - 3,327	781 - 813	166 - 177
Kewanee HH-9.7 kilometers	2,867 - 3,204	2,421 - 2,714	363 - 395	84 - 95
Oconee HH-17.5 kilometers	3,738 - 4,075	3,221 - 3,514	464 - 496	54 - 65
Oyster Creek HH-28.5 kilometers	4,061 - 4,398	2,862 - 3,155	957 - 989	242 - 254
Palisades HH-41.9 kilometers	2,680 - 3,017	2,279 - 2,572	306 - 338	96 - 107
Peach Bottom HH-58.9 kilometers	3,849 - 4,186	3,134 - 3,427	604 - 637	111 - 122
Pilgrim HH-8.7 kilometers	4,263 - 4,600	3,103 - 3,396	986 - 1,018	174 - 185
Point Beach HH-36.4 kilometers	2,820 - 3,157	2,405 - 2,698	338 - 370	78 - 89
Salem HH-51.0 kilometers	3,950 - 4,287	2,868 - 3,161	864 - 896	219 - 230
St. Lucie HH-23.5 kilometers	4,315 - 4,840	3,464 - 3,984	732 - 809	74 - 125
Surry HH-75.2 kilometers	4,065 - 4,402	3,468 - 3,761	523 - 555	74 - 85
Turkey Point HH-17.4 kilometers	4,662 - 5,140	3,696 - 4,175	785 - 870	127 - 179
Yankee-Rowe HH-10.1 kilometers	3,998 - 4,335	3,083 - 3,376	752 - 784	164 - 175

Table J-11. Rail transportation distances from commercial and DOE sites to Nevada ending rail nodes^a (kilometers)^{b,c} (page 3 of 3).

Site	Total ^d	Rural	Suburban	Urban
<i>DOE spent nuclear fuel and high-level radioactive waste</i>				
Ft. St. Vrain ^f	1,039 - 1,321	1,011 - 1,214	24 - 93	3 - 13
Hanford Site ^g	1,356 - 1,693	1,262 - 1,555	84 - 116	11 - 22
INEEL ^g	482 - 819	445 - 738	34 - 66	4 - 15
Savannah River Site ^g	3,751 - 4,088	3,081 - 3,374	605 - 638	65 - 76
West Valley ^h	3,447 - 3,784	2,774 - 3,067	538 - 570	135 - 146

- a. The ending rail nodes (INTERLINE computer program designations) are Apex-14763; Caliente-14770; Beowawe-14791; and Jean-16328.
- b. To convert kilometers to miles, multiply by 0.62137.
- c. This analysis used the INTERLINE computer program to estimate distances.
- d. Totals might differ from sums due to method of calculation and rounding.
- e. HH = heavy-haul truck distance.
- f. DOE spent nuclear fuel.
- g. DOE spent nuclear fuel and high-level radioactive waste.
- h. High-level radioactive waste.

Because the regulations require that the preferred routes result in reduced time in transit, changing conditions, weather, and other factors could result in the use of more than one route at different times for shipments between the same origin and destination. However, for this analysis the program selected only one route for travel from each site to the Yucca Mountain site. Section J.4 describes the highway routes used in the analysis along with estimated impacts of legal-weight truck shipments for each state.

Although shipments could use more than one preferred route in national highway transportation to comply with U.S. Department of Transportation regulations (49 CFR 397.101), under current U.S. Department of Transportation regulations all preferred routes would ultimately enter Nevada on Interstate 15 and travel to the repository on U.S. Highway 95. States or tribes can designate alternative or additional preferred routes for highway shipments (49 CFR 397.103). At this time the State of Nevada has not identified any alternative or additional preferred routes that DOE could use for shipments to the repository.

STATE-DESIGNATED PREFERRED ROUTES

U.S. Department of Transportation regulations specify that states and tribes can designate preferred routes that are alternatives, or in addition to, Interstate System highways including bypasses or beltways for the transportation of Highway Route-Controlled Quantities of Radioactive Materials. Highway Route-Controlled of Radioactive Materials include spent nuclear fuel and high-level radioactive waste in quantities that would be shipped on a truck or railcar to the repository. If a state or tribe designated such a route, highway shipments of spent nuclear fuel and high-level radioactive waste would use the preferred route if (1) it was an alternative preferred route, (2) it would result in reduced time in transit, or (3) it would replace pickup or delivery routes. Fourteen states have designated alternative or additional preferred routes (65 FR 75771; December 4, 2000). Although Nevada has designated a State routing agency to the Department of Transportation (Nevada Revised Statutes, Chapter 408.141), the State has not yet designated alternative or preferred routes for Highway Route-Controlled Quantities of Radioactive Materials. State route designations in the future could require changes in highway routes that would be used for shipments of spent nuclear fuel and high-level radioactive waste from 77 sites to Yucca Mountain. As an example of recent changes, two states notified the U.S. Department of Transportation of state-designated preferred routes (65 FR 75771; December 4, 2000) near or following publication of the Draft EIS.

Selection of Rail Routes. Rail transportation routing of spent nuclear fuel and high-level radioactive waste shipments is not regulated by the U.S. Department of Transportation. As a consequence, the routing rules used by the INTERLINE computer program (DIRS 104781-Johnson et al. 1993, all) assumed that railroads would select routes using historic practices. DOE has determined that the INTERLINE program is appropriate for calculating routes and related information for use in transportation analyses (DIRS 101845-Maheras and Phippen 1995, pp. 2 to 5). Because the routing of rail shipments would be subject to future, possibly different practices of the involved railroads, DOE could use other rail routes. Section J.4 contains maps of the rail routes used in the analysis along with estimated impacts of rail shipments for each state.

For the 24 commercial sites that have the capability to handle and load rail casks but do not have direct rail service, DOE used the HIGHWAY computer program to identify routes for heavy-haul transportation to nearby railheads. For such routes, routing agencies in affected states would need to approve the transport and routing of overweight and overdimensional shipments.

J.1.2.2.2 Routes for Shipping Rail Casks from Sites Not Served by a Railroad

In addition to routes for legal-weight trucks and rail shipments, 24 commercial sites that are not served by a railroad, but that have the capability to load rail casks, could ship spent nuclear fuel to nearby railheads using heavy-haul trucks (see Table J-11). In addition, six of the sites that initially are legal-weight truck sites would be indirect rail sites after plant shutdown.

J.1.2.2.3 Sensitivity of Analysis Results to Routing Assumptions

Routing for shipments of spent nuclear fuel and high-level radioactive waste to the proposed repository would comply with regulations of the U.S. Department of Transportation and the Nuclear Regulatory Commission in effect at the time shipments would occur. Unless the State of Nevada designates alternative or additional preferred routes, to comply with U.S. Department of Transportation regulations all preferred routes would ultimately enter Nevada on Interstate 15 and travel to the repository on U.S. Highway 95. States can designate alternative or additional preferred routes for highway shipments. At this time the State of Nevada has not identified any alternative or additional preferred routes DOE could use for shipments to the repository. Section J.3.1.3 examines the sensitivity of transportation impacts both nationally and regionally (within Nevada) to changes in routing assumptions within Nevada.

J.1.3 ANALYSIS OF IMPACTS FROM INCIDENT-FREE TRANSPORTATION

DOE analyzed the impacts of incident-free transportation for shipments of commercial and DOE spent nuclear fuel and DOE high-level radioactive waste that would be shipped under the Proposed Action and Inventory Modules 1 and 2 from 77 sites to the repository. The analysis estimated impacts to the public and workers and included impacts of loading shipping casks at commercial and DOE sites and other preparations for shipment as well as intermodal transfers of casks from heavy-haul trucks or barges to rail cars.

J.1.3.1 Methods and Approach for Analysis of Impacts for Loading Operations

The analysis used methods and assessments developed for spent nuclear fuel loading operations at commercial sites to estimate radiological impacts to involved workers at commercial and DOE sites. Previously developed conceptual radiation shield designs for shipping casks (DIRS 101747-Schneider et al. 1987, Sections 4 and 5), rail and truck shipping cask dimensions, and estimated radiation dose rates at locations where workers would load and prepare casks (DIRS 104791-DOE 1992, p. 4.2) for shipment were the analysis bases for loading operations. In addition, tasks and time-motion evaluations from these studies were used to describe spent nuclear fuel handling and loading. These earlier evaluations were

based on normal, incident-free operations that would be conducted according to Nuclear Regulatory Commission regulations that establish radiation protection criteria for workers.

The analysis assumed that noninvolved workers would not have tasks that would result in radiation exposure. In a similar manner, the analysis projected that the dose to the public from loading operations would be extremely small, resulting in no or small impacts. A separate evaluation of the potential radiation dose to members of the public from loading operations at commercial nuclear reactor facilities showed that the dose would be very low, less than 0.001 person-rem per metric ton uranium of spent nuclear fuel loaded (DIRS 104731-DOE 1986, p. 2.42, Figure 2.9). Public doses from activities at commercial and DOE sites generally come from exposure to airborne emissions and, in some cases, waterborne effluents containing low levels of radionuclides. However, direct radiation at publicly accessible locations near these sites typically is not measurable and contributes negligibly to public dose and radiological impacts. Though DOE expects no releases from loading operations, this analysis estimated that the dose to the public would be 0.001 person-rem per metric ton uranium, and metric ton equivalents, for DOE spent nuclear fuel and high-level radioactive waste. Noninvolved workers could also be exposed to low levels of radioactive materials and radioactivity from loadout operations. However, because these workers would not work in radiation areas they would receive a very small fraction of the dose received by involved workers. DOE anticipates that noninvolved workers would receive individual doses similar to those received by members of the public. Because the population of noninvolved workers would be small compared to the population of the general public near the 77 sites, the dose to these workers would be a small fraction of the public dose.

The analysis used several basic assumptions to evaluate impacts from loading operations at DOE sites:

- Operations to load spent nuclear fuel and high-level radioactive waste at DOE facilities would be similar to loading operations at commercial facilities.
- Commercial spent nuclear fuel would be in storage pools or in dry storage at the reactors and DOE spent nuclear fuel would be in dry storage, ready to be loaded directly in Nuclear Regulatory Commission-certified shipping casks and then on transportation vehicles. In addition, DOE high-level radioactive waste could be loaded directly in casks. All preparatory activities, including packaging, repackaging, and validating the acceptability of spent nuclear fuel for acceptance at the repository would be complete prior to loading operations.
- Commercial spent nuclear fuel to be placed in the shipping casks would be uncanistered or canistered fuel assemblies, with at least one assembly in a canister. DOE spent nuclear fuel and high-level radioactive waste would be in disposable canisters. Typically, uncanistered assemblies would be loaded into shipping casks under water in storage pools (wet storage). Canistered spent nuclear fuel could be loaded in casks directly from dry storage facilities or storage pools.

In addition, because handling and loading operations for DOE spent nuclear fuel and high-level radioactive waste and commercial spent nuclear fuel would be similar, the analysis assumed that impacts to workers during the loading of commercial spent nuclear fuel could represent those for the DOE materials, even though the radionuclide inventory of commercial fuel and the resultant external dose rate would be higher than those of the DOE materials. This conservative assumption of selecting impacts from commercial handling and loading operations overestimated the impacts of DOE loading operations, but it enabled the use of detailed real information developed for commercial loading operations to assess impacts for DOE operations. Equivalent information was not available for operations at DOE facilities. To gauge the conservatism of the assumption DOE compared the radioactivity of contents of shipments of commercial and DOE spent nuclear fuel and high-level radioactive waste. Table J-12 compares typical inventories of important contributors to the assessment of worker and public health impacts. These are cesium-137 and actinide isotopes (including plutonium) for rail shipments of commercial spent nuclear

Table J-12. Average cesium-137, actinide isotope, and total radioactive material content (curies) in a rail shipping cask.^a

Material	Cesium-137	Actinides	Total (all isotopes)
Commercial spent nuclear fuel (PWR) ^b	816,000	694,000	2,130,000
High-level radioactive waste	27,000	53,000 ^c	180,000
DOE spent nuclear fuel (except naval spent nuclear fuel)	119,000	40,000	265,000
Naval spent nuclear fuel	450,000	28,000	1,100,000

- a. Source: Appendix A. Source estimated based on 24 typical pressurized-water reactor fuel assemblies for commercial spent nuclear fuel; one dual-purpose shipping canister for naval spent fuel; nine canisters of DOE spent nuclear fuel; and five canisters of high-level radioactive waste.
- b. PWR = pressurized-water reactor.
- c. Includes immobilized plutonium with high-level radioactive waste.

fuel, DOE spent nuclear fuel, and DOE high-level radioactive waste. Although other factors are also important (for example, material form and composition), these indicators provide an index of the relative hazard potential of the materials. Appendix A contains additional information on the radionuclide inventory and characteristics of spent nuclear fuel and high-level radioactive waste.

J.1.3.1.1 Radiological Impacts of Loading Operations at Commercial Sites

In 1987, DOE published a study of the estimated radiation doses to the public and workers resulting from the transport of spent nuclear fuel from commercial nuclear power reactors to a hypothetical deep geologic repository (DIRS 101747-Schneider et al. 1987, all). This study was based on a single set of spent nuclear fuel characteristics and a single split [30 percent/70 percent by weight; 900 metric tons uranium/2,100 metric tons uranium per year] between truck and rail conveyances. DOE published its findings on additional radiological impacts on monitored retrievable storage workers in an addendum to the 1987 report (DIRS 104791-DOE 1992, all). The technical approaches and impacts summarized in these DOE reports were used to project involved worker impacts that would result from commercial at-reactor spent nuclear fuel loading operations. DOE did not provide a separate analysis of noninvolved worker impacts in these reports. For the analysis in this EIS, DOE assumed that noninvolved workers would not receive radiation exposures from loading operations. This assumption is appropriate because noninvolved workers would be personnel with managerial or administrative support functions directly related to the loading tasks but at locations, typically in offices, away from areas where loading activities took place.

In the DOE study, worker impacts from loading operations were estimated for a light-water reactor with pool storage of spent nuclear fuel. The radiological characteristics of the spent nuclear fuel in the analysis was 10-year-old, pressurized-water reactor fuel with an exposure history (burnup) of 35,000 megawatt-days per metric ton. In addition, the reference pressurized-water reactor and boiling-water reactor fuel assemblies were assumed to contain 0.46 and 0.19 MTU, respectively, prior to reactor irradiation. The term MTU (metric ton of uranium) is from the DOE study. An MTU is approximately the same quantity of spent nuclear fuel as a metric ton of heavy metal, or MTHM, as described in this EIS. In this section, the terms are used interchangeably to allow the information reported in prior DOE studies to be used without modification. These parameters for spent nuclear fuel are similar to those presented in Appendix A of this EIS. The use of the parameters for spent nuclear fuel presented in Appendix A would be likely to lead to similar results.

In the 1987 study, radiation shielding analyses were done to provide information on (1) the conceptual configuration of postulated reference rail and truck transportation casks, and (2) the direct radiation levels at accessible locations near loaded transportation casks. The study also presented the results of a detailed time-motion analysis of work tasks that used a loading concept of operations. This task analysis was

coupled with cask and at-reactor direct radiation exposure rates to estimate radiation doses to involved workers (that is, those who would participate directly in the handling and loading of the transportation casks and conveyances). Impacts to members of the public from loading operations had been shown to be small [fraction of a person-millirem population dose; (DIRS 101747-Schneider et al. 1987, p. 2.9)] and were eliminated from further analysis in the 1987 report. The at-reactor-loading concept of operations included the following activities:

1. Receiving the empty transportation cask at the site fence
2. Preparing and moving the cask into the facility loading area
3. Removing the cask from the site prime mover trailer
4. Preparing the cask for loading and placing it in the water-filled loading pit
5. Transferring spent nuclear fuel from its pool storage location to the cask
6. Removing the cask from the pool and preparing it for shipment
7. Placing the cask on the site prime mover trailer
8. Moving the loaded cask to the site fence where the trailer is connected to the transportation carrier's prime mover for offsite shipment

The results for loading operations are listed in Table J-13.

Table J-13. Principal logistics bases and results for the reference at-reactor loading operations.^a

Parameter	Conveyance		
	Rail ^b	Truck ^c	Total
Annual loading rate (MTU/year) ^d	2,100	900	3,000
Transportation cask capacity, PWR - BWR (MTU/cask)	6.5 - 6.7	0.92 - 0.93	NA ^e
Annual shipment rate (shipments/year)	320	970	1,290
Average loading duration, PWR - BWR (days) ^f	2.3 - 2.5	1.3 - 1.4	NA
Involved worker specific CD, ^g PWR - BWR (person-rem/MTU)	0.06 - 0.077	0.29 - 0.31	NA

- a. Source: DIRS 101747-Schneider et al. (1987, pp. 2.5 and 2.7).
- b. 14 pressurized-water reactor and boiling-water reactor spent nuclear fuel assemblies per rail transportation cask.
- c. 2 pressurized-water reactor and boiling-water reactor spent nuclear fuel assemblies per truck transportation cask.
- d. MTU = metric tons of uranium. One MTU is approximately equal to 1 MTHM.
- e. NA = not applicable.
- f. Based on single shift operations; carrier drop-off and pick-up delays were not included.
- g. Collective dose expressed as the sum of the doses accumulated by all loading (involved) workers, regardless of the total number of workers assigned to loading tasks.

The loading activities that the study determined would produce the highest collective unit impacts are listed in Table J-14. As listed in this table, the involved worker collective radiation doses would be dominated by tasks in which the workers would be near the transportation cask when it contained spent nuclear fuel, particularly when they were working around the cask lid area. These activities would deliver at least 40 percent of the total collective worker doses. Worker impacts from the next largest dose-producing tasks (working to secure the transportation cask on the trailer) would account for 12 to 19 percent of the total impact. The impacts are based on using crews of 13 workers [the number of workers

Table J-14. At-reactor reference loading operations—collective impacts to involved workers.^a

Task description	Rail		Truck	
	CD per MTU ^{b,c} (PWR - BWR) ^d	Percent of total impact	CD per MTU (PWR - BWR)	Percent of total impact
Install cask lids; flush cask interior; drain, dry and seal cask	0.025 - 0.024	40 - 31	0.126 - 0.126	43 - 40
Install cask binders, impact limiters, personnel barriers	0.010 - 0.009	15 - 12	0.056 - 0.055	19 - 18
Load SNF into cask	0.011 - 0.027	17 - 35	0.011 - 0.027	4 - 9
On-vehicle cask radiological decontamination and survey	0.003 - 0.003	5 - 4	0.018 - 0.018	6 - 6
Final inspection and radiation surveys	0.002 - 0.002	4 - 3	0.016 - 0.015	5 - 5
All other (19) activities	0.011 - 0.012	19 - 16	0.066 - 0.073	23 - 23
<i>Task totals</i>	<i>0.062 - 0.077</i>	<i>100 - 100</i>	<i>0.29 - 0.31</i>	<i>100 - 100</i>

a. Source: DIRS 101747-Schneider et al. (1987, p. 2.9).

b. CD/MTU = Collective dose (person-rem effective dose equivalent) per metric ton uranium. One MTU is approximately equal to 1 MTHM.

c. The at-reactor loading crew size is assumed to be 13 involved workers.

d. PWR = pressurized-water reactor; BWR = boiling-water reactor.

assumed in the DIRS 101747-Schneider et al. (1987, Section 2) study] dedicated solely to performing cask-handling work. The involved worker collective dose was calculated using the following formula:

$$\text{Collective dose (person-rem)} = A \times B \times C \times D \times E$$

where: A = number of pressurized-water or boiling-water reactor spent nuclear fuel shipments being analyzed under each transportation scenario (from Tables J-4 and J-5)

B = number of transportation casks included in a shipment (set at 1 for both transportation scenarios)

C = number of pressurized-water or boiling-water reactor spent nuclear fuel assemblies in a transportation cask (from Table J-3)

D = amount of uranium in the spent nuclear fuel assembly prior to reactor irradiation, expressed as metric tons uranium per assembly (from Table J-13)

E = involved worker-specific collective dose in person-rem/metric ton uranium for each fuel type (from Table J-13)

Because worker doses are linked directly to the number of loading operations performed, the highest average individual doses under each transportation scenario would occur at the reactor sites having the most number of shipments. Accordingly, the average individual dose impacts were calculated for the limiting site using the equation:

$$\text{Average individual dose (rem per involved worker)} = (A \times B \times C \times D \times E) \div F$$

where: A = largest value for the number of shipments from a site under each transportation scenario (from Tables J-4 and J-5)

B = number of transportation casks included in a shipment (set at 1 for both transportation scenarios)

- C = number of spent nuclear fuel assemblies in a transportation cask (from Table J-3)
- D = amount of uranium in the spent nuclear fuel assembly prior to reactor irradiation in metric tons uranium per assembly (from Table J-13)
- E = involved worker-specific collective dose in person-rem per metric ton uranium for each fuel type (from Table J-13)
- F = involved worker crew size (set at 13 persons for both transportation scenarios; from Table J-14)

J.1.3.1.2 Radiological Impacts of DOE Spent Nuclear Fuel and High-Level Radioactive Waste Loading Operations

The methodology used to estimate impacts to workers during loading operations for commercial spent nuclear fuel was also used to estimate impacts of loading operations for DOE spent nuclear fuel and high-level radioactive waste. The exposure factor (person-rem per MTU) for loading boiling-water reactor spent nuclear fuel in truck casks at commercial facilities was used (see Table J-14). The exposure factor for truck shipments of boiling-water reactor spent nuclear fuel was based on a cask capacity of five boiling-water reactor spent nuclear fuel assemblies (about 0.9 MTU or 0.9 MTHM). The analysis used this factor because it would result in the largest estimates for dose per operation.

J.1.3.2 Methods and Approach for Analysis of Impacts from Incident-Free Transportation

The potential exists for human health impacts to workers and members of the public from incident-free transportation of spent nuclear fuel and high level radioactive waste. *Incident-free* transportation means normal accident-free shipment operations during which traffic accidents and accidents in which radioactive materials could be released do not occur (Section J.1.4. discusses accidents). Incident-free impacts could occur from exposure to (1) external radiation in the vicinity of the transportation casks, or (2) transportation vehicle emissions, both during normal transportation.

J.1.3.2.1 Incident-Free Radiation Dose to Populations

The analysis used the RADTRAN 5 computer model and program (DIRS 150898-Neuhauser and Kanipe 2000, all; DIRS 155430-Neuhauser, Kanipe, and Weiner 2000, all) to evaluate incident-free impacts for populations. The RADTRAN 5 input parameters used to estimate incident-free impacts are listed in Table J-15. Through extensive review (DIRS 101845-Maheras and Phippen 1995, Section 3 and 4), DOE has determined that this program provides reasonable, but conservative, estimates of population doses for use in the evaluation of risks of transporting radioactive materials, including spent nuclear fuel and high-level radioactive waste. DOE used the previous version, RADTRAN 4, to analyze transportation impacts for other environmental impact statements (for example, DIRS 101802-DOE 1995, Volume 1, Appendix E; DIRS 101816-DOE 1997, Appendixes F and G). RADTRAN 4 was subjected to extensive review (DIRS 101845-Maheras and Phippen 1995, Sections 3 and 4). RADTRAN 5 is an upgrade to RADTRAN 4, and has been validated by comparison with dose measurements (DIRS 153967-Steinman and Kearfott 2000, all). RADTRAN 5 consistently overestimates doses from transported radioactive materials when the results are compared to measured doses. The program and associated database, using population densities from 1990 Census data escalated to 2035, calculated the collective dose to populations that live along transportation routes [within 800 meters (0.5 mile) of either side of the route]. Table J-16 lists the estimated number of people who live within 800 meters of national routes.

Table J-15. Input parameters and parameter values used for the incident-free national truck and rail transportation analysis, except stops.

Parameter	Legal-weight truck transportation	Rail transportation	Legal-weight truck and rail
<i>Package type</i>			Type B shipping cask
<i>Package dimension</i>	5.2 meters ^a long 1.0 meters diameter	5.06 meters long 2.0 meters diameter	
<i>Dose rate</i>			10 millirem per hour, 2 meters from side of vehicle ^f
<i>Number of crewmen</i>	2	5	
<i>Distance from source to crew</i>	3.1 meters ^a	152 meters ^b	
<i>Speed</i>			
Rural	88 km ^{c,d} per hour	64 km per hour	
Suburban	88 km/hr non-rush hour 44 km/hr rush hour	40 km per hour	
Urban	88 km/hr non-rush hour 44 km/hr rush hour	24 km per hour	
<i>Input for stop doses: see Table J-17</i>			
<i>Number of people per vehicle sharing route</i>	2	3	
<i>Minimum and maximum distances to exposed population</i>			30 meters to 800 meters
<i>Population densities (persons per km²)^d</i>			
Rural			(e)
Suburban			(e)
Urban			(e)
<i>One-way traffic count (vehicles per hour)</i>			
Rural	470	1	
Suburban	780	5	
Urban	2,800	5	

- a. To convert meters to feet, multiply by 3.2808.
- b. Rail crew in transit would be too far and too well shielded from the external cask radiation to receive any dose. This number is not used in the calculation and is provided for information only.
- c. To convert kilometers to miles, multiply by 0.62137.
- d. Assumes general freight rather than dedicated service.
- e. Population densities along transportation routes were estimated using the HIGHWAY and INTERLINE computer programs, then were extrapolated to 2035.
- f. The actual (equivalent) input to RADTRAN 5 is 14 millirem per hour at 1 meter (3.3 feet) from the side of the vehicle.

Table J-16. Population within 800 meters (0.5 mile) of routes for incident-free transportation using 2035 population.

Transportation scenario	2035 population
Mostly legal-weight truck	10,400,000
Mostly rail	16,400,000

RADTRAN 5 uses the following information to estimate collective incident-free doses to the public:

- The external radiation dose rate around shipping casks
- The resident population density (number of people per square kilometer) in the census block groups that contain the route (from HIGHWAY or INTERLINE)
- In urban areas, a factor for nonresident population density
- The speed of the vehicle (truck or train)
- The number of shipments that would be transported over each route
- The density of vehicles (number of vehicles per kilometer) sharing the route with the shipment and the average number of people in each vehicle
- Conditions at vehicle stops, which are described in greater detail below.

Most of these parameters were developed using the data listed in Tables J-15 and J-17. The number of shipments that would use a transportation route was developed with the use of the CALVIN computer program discussed in Section J.1.1.1, the DOE Throughput Study (DIRS 100265-CRWMS M&O 1997, Section 6.1.1), data on DOE spent nuclear fuel and high-level radioactive waste inventories in Appendix A, and data from DOE sites (DIRS 104778-Jensen 1998, all). The analysis used CALVIN to estimate the number of shipments from each commercial site. The Throughput Study provided the estimated number of shipments of high-level radioactive waste from the four DOE sites. Information provided by the DOE National Spent Nuclear Fuel Program (DIRS 104778-Jensen 1998, all) and in Appendix A was used to estimate shipments of DOE spent nuclear fuel.

The analysis used a value of 10 millirem per hour at a distance of 2 meters (6.6 feet) from the side of a transport vehicle for the external dose rate around shipping casks. This value is the maximum allowed by regulations of the U.S. Department of Transportation for shipments of radioactive materials [49 CFR 173.441(b)]. Dose rates at distances greater than 2 meters from the side of a vehicle would be less. The dose rate at 30 meters (98 feet) from the vehicle would be less than 0.2 millirem per hour; at a distance of 800 meters (2,600 feet) the dose rate would be less than 0.0002 millirem per hour.

In addition, the analysis used RADTRAN 5 to estimate doses to people closer to the cask than the resident population along the route, and to people who would be exposed for longer periods of time. These populations would include the truck or rail crew, others working near the cask, people in vehicles that share the route with the shipment, members of the public at truck stops, and residents of the area near the truck and rail stops.

The analysis also uses the potential number of people close enough to shipments to be exposed to radiation from the casks. The analysis determined the estimated offlink number of people [those within the 1.6-kilometer (1-mile) region of influence] by multiplying the population densities (persons per square kilometer) in population zones through which a route would pass by the 1.6-kilometer width of the region of influence and by the length of the route through the population zones. Onlink populations (those sharing the route and people at stops along the route) were estimated using assumptions from other EISs that have evaluated transportation impacts (DIRS 101802-DOE 1995, Volume 1, Appendix I; DIRS 101812-DOE 1996, Appendix E; DIRS 101816-DOE 1997, Appendixes F and G). The travel distance in each population zone was determined for legal-weight truck shipments by using the HIGHWAY computer program (DIRS 104780-Johnson et al. 1993, all) and for rail shipments by using the INTERLINE

Table J-17. Input parameter values for stop doses for routine incident-free transportation.

Stop type	Population exposed	Minimum distance (meters) ^a	Maximum distance (meters) ^a	Stop time	Other
<i>Doses to the public</i>					
People at truck stops	6.9 ^b	1 ^b	15.8 ^b	20 min ^b	845 km ^c between stops
Residents near truck stops	Rural, suburban, or urban ^d	30	800	20 min ^b	845 km between stops
Residents near truck walkaround inspections ^e	Rural, suburban, or urban	30	800	10 min	161 km between stops
Residents near rail classification stops	Rural, suburban, or urban	30	800	30 hr ^a	One stop at each end of trip
Residents near rail crew change stops	Rural, suburban, or urban	30	800	0.033 hr/km ^b	
<i>Occupational stop doses</i>					
Truck crew dose at rest/refuel stops	2	1	15.8	20 min	845 km between stops
Truck crew dose at walkaround inspections	1	1	1	10 min	161 km between stops
	1	Dose rate = 2 mrem/hr by regulation			
Rail crew dose at classification stops	5	(e)		30 hr	One stop at each end of trip
Rail crew dose at crew change stops	5	Calculated by multiplying the classification stop dose by 0.0018/km: a distance-dependent worker exposure factor ^f			

a. To convert meters to feet, multiply by 3.2808.

b. Derived from DIRS 152084-Griego, Smith, and Neuhauser (1996, all).

c. km = kilometer; to convert kilometers to miles, multiply by 0.62137.

d. Values used in DIRS 152476-Sprung et al. (2000, pp. 3-5 to 3-9, Table 3.3).

e. DIRS 155430-Neuhauser, Kanipe, and Weiner (2000, Appendix B) explains this calculation, which has been incorporated into RADTRAN 5.

f. DIRS 150898-Neuhauser and Kanipe (2000, pp. 51 to 52).

program (DIRS 104781-Johnson et al. 1993, all). These programs used 1990 census block group data to identify where highways and railroads enter and exit each type of population zone, which the analysis used to determine the total lengths of the highways and railroads in each population zone.

The third kind of information—the distances individuals live from the route used in the analysis—is the estimated the number of people who live within 800 meters (about 2,600 feet) of the route. The analysis assumed that population density is uniform in population zones.

The analysis used RADTRAN 5 to calculate exposures for the following groups:

- **Public along the route (Offlink Exposure):** Collective doses for persons living or working within 0.8 kilometer (0.5 mile) on each side of the transportation route.
- **Public sharing the route (Onlink Exposure):** Collective doses for persons in vehicles sharing the transportation route; this includes persons traveling in the same or opposite direction and those in vehicles passing the shipment.
- **Public during stops (Stops):** Collective doses for people who could be exposed while a shipment was stopped en route. For truck transportation, these would include stops for refueling, food, and rest and for brief inspections at regular intervals. For rail transportation, stops would occur in railyards at the beginning and end of each trip, and along the route to switch railcars from inbound trains to outbound trains traveling toward the Yucca Mountain site, and to change train crews and equipment (locomotives).

- *Worker exposure (Occupational Exposure)*: Collective doses for truck and rail transportation crew members.
- *Security escort exposure (Occupational Exposure)*: Collective doses for security escorts. In calculating doses to workers the analysis conservatively assumed that the maximum number of escorts required by regulations (10 CFR 73.37) would be present for urban, suburban, and rural population zones.

The sum of the doses for the first three categories is the total nonoccupational (public) dose.

The sensitivity analysis in Section J.1.3.2.2.3 evaluates impacts of requiring additional escorts such as escorts in separate vehicles for all parts of every shipment of loaded legal-weight truck casks and two escorts in all areas for rail shipments.

Table J-17 lists input parameter values for doses to public and workers at stops. RADTRAN 5 models stops separately, and does not use the “hours per kilometer of travel” of the RADTRAN 4 model. Documentation for a stop model for dose to the public at truck rest and refueling stops is in DIRS 152084-Griego, Smith, and Neuhauser (1996, all). Models for calculating doses to members of the public who reside near stops, as well as occupational doses, for truck and rail, are in DIRS 152476-Sprung et al. (2000, pp. 8-14 to 8-18). For each model, the analysis includes a population or population density component, a total stop-time component, and the calculation, using RADTRAN 5, of an “hour per kilometer” equivalent for consistency with the unit risk factors listed in Table J-18. The external dose rate from the cask for all stops is 10 millirem per hour at 2 meters (6.6 feet) from the cask.

Unit dose factors were used to calculate incident-free collective doses. The offlink unit risk factors listed in Table J-18 represent the dose that would be received by a population density of one person per square kilometer for one shipment of radioactive material moving a distance of 1 kilometer (0.62 mile) in the indicated population density zone, and reflect the assumption that the dose rate external to shipments of spent nuclear fuel and high-level radioactive waste would be the maximum value allowed by U.S. Department of Transportation regulations—10 millirem per hour at 2 meters (6.6 feet) from the side of the transport vehicle (49 CFR 173.441). The onlink unit risk factors represent the doses that would be received by occupants of vehicles sharing the transportation route with the cargo. There are two kinds of stop dose unit risk factors: one for the resident population near stops, based on a population density of one person per square kilometer, and another for the public at rest and refueling stops, which is independent of population density. The incident-free dose from transporting a single shipment was determined by multiplying the appropriate unit dose factors by corresponding distances in each of the population zones through which the shipment route would pass and by the population density of the zone. The collective dose from all shipments from a site was determined by multiplying the dose from a single shipment by the number of shipments that would be required to transport the site’s spent nuclear fuel or high-level radioactive waste to the repository. Collective dose was converted to the estimated number of latent cancer fatalities using conversion factors recommended by the International Commission on Radiological Protection (DIRS 101836-ICRP 1991, p. 22). These values are 0.0004 latent cancer fatality per person-rem for radiation workers and 0.0005 latent cancer fatality per person-rem for the general population.

J.1.3.2.2 *Methods Used To Evaluate Incident-Free Impacts to Maximally Exposed Individuals*

To estimate impacts to maximally exposed individuals, the same kinds of information as those used for population doses (except for population size) were needed. The analysis of doses to maximally exposed individuals used projected exposure times, the distance a hypothetical individual would be from a shipment, the number of times an exposure event could occur, and the assumed external radiation dose

Table J-18. Incident-free dose factors.

Factor		Barge	Heavy-haul truck	Rail	Legal-weight truck
<i>Public</i>					
Off-link ^a [rem per (persons per square kilometer) per kilometer]	Rural	1.72×10^{-7}	6.24×10^{-8}	3.90×10^{-8}	2.98×10^{-8}
	Suburban	1.72×10^{-7}	6.24×10^{-8}	6.24×10^{-8}	3.18×10^{-8}
	Urban	1.72×10^{-7}	6.24×10^{-8}	1.04×10^{-7}	3.18×10^{-8}
On-link ^b (person-rem per kilometer)	Rural		1.01×10^{-4}	1.21×10^{-7}	$9.53 \times 10^{-6(c)}$
	Suburban		7.94×10^{-5}	1.55×10^{-6}	2.75×10^{-5}
	Urban		2.85×10^{-4}	4.29×10^{-6}	9.88×10^{-5}
Residents near rest/refueling stops (rem per person per kilometer) ^d	Rural		3.96×10^{-9}	1.24×10^{-7}	5.50×10^{-9}
	Suburban		3.96×10^{-9}	1.24×10^{-7}	5.50×10^{-9}
	Urban		3.96×10^{-9}	1.24×10^{-7}	5.50×10^{-9}
Residents near classification stops (rem per person per square kilometer)	Suburban			1.59×10^{-5}	
Public including workers at rest/refueling stops (person-rem per kilometer)					7.86×10^{-6}
<i>Workers</i>					
Classification stops (person-rem)				8.07×10^{-3}	
In-transit rail stops (person-rem per kilometer)				1.45×10^{-5}	
In moving vehicle (person-rem per kilometer)	Rural	2.11×10^{-6}	5.54×10^{-6}		4.52×10^{-5}
	Suburban	2.11×10^{-6}	5.54×10^{-6}		4.76×10^{-5}
	Urban	2.11×10^{-6}	5.54×10^{-6}		4.76×10^{-5}
Walkaround inspection (person-rem per kilometer)			6.27×10^{-7}		1.93×10^{-5}

- Offlink general population includes persons in the census block groups on the route; the population density in each census block group is assumed to be the population density in the half-mile on either side of the route.
- Onlink general population included persons sharing the road or railway.
- Onlink dose factors are larger than offlink because the onlink population (vehicles and persons per vehicle) is included in the dose factor, and because the vehicles are much closer to the radioactive cargo.
- The methodology, equations, and data used to develop the unit dose factors are discussed in DIRS 152084-Griego, Smith, and Neuhauser (1996, all); DIRS 155430-Neuhauser, Kanipe, and Weiner (2000, Chapter 3); and DIRS 152476-Sprung et al. (2000, Chapter 3).

rate 2 meters (6.6 feet) from a shipment (10 millirem per hour). These analyses used the RISKIND computer program (DIRS 101483-Yuan et al. 1995, all). DOE has used RISKIND for analyses of transportation impacts in other environmental impact statements (DIRS 104382-DOE 1995, Appendix J; DIRS 101812-DOE 1996, Appendix E; DIRS 101816-DOE 1997, Appendix E). RISKIND provides appropriate results for analyses of incident-free transportation and transportation accidents involving radioactive materials (DIRS 101845-Maheras and Phippen 1995, Sections 5.2 and 6.2; DIRS 102060-Biwer et al. 1997, all).

The maximally exposed individual is a hypothetical person who would receive the highest dose. Because different maximally exposed individuals can be postulated for different exposure scenarios, the analysis evaluated the following exposure scenarios.

- Crew Members.** In general, truck crew members, would receive the highest doses during incident-free transportation (see discussions below). The analysis assumed that the crews would be limited to a total job-related exposure of 2 rem per year (DIRS 156764-DOE 1999, Article 211).
- Inspectors (Truck and Rail).** Inspectors would be Federal or state vehicle inspectors. On the basis of information provided by the Commercial Vehicle Safety Alliance (DIRS 104597-Battelle 1998, all;

DIRS 156422-CVSA 2001, all), the analysis assumed an average exposure distance of 1 meter (3 feet) and an exposure duration of 1 hour (see discussion in J.1.3.2.2.2).

- *Railyard Crew Member.* For a railyard crew member working in a rail classification yard assembling trains, the analysis assumed an average exposure distance of 10 meters (33 feet) and an exposure duration of 2 hours (DIRS 101816-DOE 1997, p. E-50).
- *Resident.* The analysis assumed this maximally exposed individual is a resident who lives 30 meters (100 feet) from a point where shipments would pass. The resident would be exposed to all shipments along a particular route (DIRS 101802-DOE 1995, Volume 1, Appendix I, p. I-52).
- *Individual Stuck in Traffic (Truck or Rail).* The analysis assumed that a member of the public could be 1.2 meter (4 feet) from the transport vehicle carrying a shipping cask for 1 hour. Because these circumstances would be random and unlikely to occur more than once for the same individual, the analysis assumed the individual to be exposed only once.
- *Resident Near a Rail Stop.* The analysis assumed a resident who lives within 200 meters (660 feet) of a switchyard and an exposure time of 20 hours for each occurrence. The analysis of exposure for this maximally exposed individual assumes that the same resident would be exposed to all rail shipments to the repository (DIRS 101802-DOE 1995, Volume 1, Appendix I, p. I-52).
- *Person at a Truck Service Station.* The analysis assumed that a member of the public (a service station attendant) would be exposed to shipments for 49 minutes for each occurrence at a distance of 16 meters (52 feet) (DIRS 152084-Griego, Smith, and Neuhauser 1996, all). The analysis also assumed this individual would work at a location where all truck shipments would stop.

As discussed above for exposed populations, the analysis converted radiation doses to estimates of radiological impacts using dose-to-risk conversion factors of the International Commission on Radiological Protection.

J.1.3.2.2.1 Estimation of Incident-Free Maximally Exposed Individuals in Nevada. This section presents the assumptions used to estimate incident-free exposures to maximally exposed individuals in Nevada.

Transporting spent nuclear fuel to the Yucca Mountain site by legal-weight or heavy-haul trucks would require transport through Nevada on existing roads and highways. The proximity of existing structures that could house a maximally exposed individual have been determined and the maximally exposed individual identified and potential dose calculated as discussed in Section J.1.3.2.2. DOE considered a number of different sources of information concerning the proximity of the maximally exposed individual to a passing truck carrying spent nuclear fuel or high-level radioactive waste.

- An analysis prepared for the City of North Las Vegas (DIRS 155112-Berger 2000, p. 104) locates the maximally exposed individual 15 meters (50 feet) from an intersection. This individual would be exposed for 1 minute per shipment and an additional 30 minutes per year due to traffic delays. DOE believes the conditions listed greatly exceed actual conditions that would be encountered. Nevertheless, the estimated dose to this maximally exposed individual would be 530 millirem over 24 years.
- DOE performed a survey to determine the location of and proximity to the proposed routes that identified potential maximally exposed individual locations as follows:
 - Residences approximately 5 meters (15 feet) from Highway 93 in Alamo, Nevada (DIRS 155825-Poston 2001, p. 10). The analysis estimated the dose to a maximally exposed individual at this

location based on 10,000 heavy-haul truck shipments over 24 years. This estimated dose would be 25 millirem.

- The courthouse and fire station in Goldfield, Nevada, are 5.5 and 4.9 meters (18 and 15 feet), respectively (DIRS 155825-Poston 2001, p. 12) from the road. The analysis estimated the dose to maximally exposed individuals at this location assuming potential exposure to 10,000 heavy-haul truck shipments over 24 years. The estimated dose would be 56 millirem.
- The width of the cleared area for a branch rail line would be 60 meters (200 feet); therefore, the closest resident would be at least 30 meters (98 feet) from a branch rail line. A maximally exposed individual who would be a minimum distance of 30 meters from a branch rail line, assuming 10,000 shipments over 24 years, would receive an estimated dose of 2 millirem.
- The *Intermodal and Highway Transportation of Low-Level Radioactive Waste to the Nevada Test Site* (DIRS 155779-DOE 1999, VI pc-23, Table C-11) identifies the maximally exposed individual as residing between Barstow, California, and the Nevada Test Site approximately 10.7 meters (35 feet) from a highway over 24 years of shipments; this individual would receive an estimated 20 millirem.

As identified above, the maximally exposed individual dose over 24 years for transportation in Nevada would range from 2 to 530 millirem.

J.1.3.2.2.2 Incident-Free Radiation Doses to Inspectors. DOE estimated radiation doses to the state inspectors who would inspect shipments of spent nuclear fuel and high-level radioactive waste originating in, passing through, or entering a state. For legal-weight truck and railcar shipments, the analysis assumed that:

- Each inspection would involve one individual working for 1 hour at a distance of 1 meter (3.3 feet) from a shipping cask.
- The radiation field surrounding the cask would be the maximum permitted by regulations of the U.S. Department of Transportation (49 CFR 173.441).
- There would be no shielding between an inspector and a cask.

For rail shipments, the analysis assumed that:

- There would be a minimum of two inspections per trip—one at origin and one at destination—with additional inspections en route occurring at intermediate stops.
- Rail crews would conduct the remaining along-the-route inspections.

For legal-weight truck shipments, the analysis assumed that:

- On average, state officials would conduct two inspections during each trip – one at the origin and one at the destination.
- The inspectors would use the Enhanced North American Uniform Inspection Procedures and Out-of-Service Criteria for Commercial Highway Vehicles Transporting Transuranics, Spent Nuclear Fuel, and High-Level Radioactive Waste (DIRS 156422-CVSA 2001, all).

- The shipments would receive a Commercial Vehicle Safety Alliance inspection sticker on passing inspection and before departing from the 77 sites.
- Display of such a sticker would provide sufficient evidence to state authorities along a route that a shipment complied with U.S. Department of Transportation regulations (unless there was contradictory evidence), and there would be no need for additional inspections.

The analysis used the RISKIND computer program (DIRS 101483-Yuan et al. 1995, all) to determine doses to state inspectors. The data used by the program to calculate dose includes the estimated value for dose rate at 1 meter (3.3 feet) from a cask surface, the length and diameter of the cask, the distance between the location of the individual and the cask surface, and the estimated time of exposure. For rail shipments, using the assumptions outlined above, the estimated value for whole-body dose to an individual inspector for one inspection would be 17 millirem. Under the mostly rail scenario in which approximately 400 rail shipments would arrive in Nevada annually, a Nevada inspector working 1,800 hours per year could inspect as many as 82 shipments in a year. This inspector would receive a dose of 1.4 rem. If this same inspector inspected 82 shipments per year over the 24 years of the Proposed Action, he or she would be exposed to 34 rem.

The use of the dose-to-risk conversion factors published by the International Commission on Radiation Protection projects this exposure to increase the likelihood of the inspector incurring a fatal cancer. The projection would add 2 percent to the likelihood for fatal cancers from all other causes, increasing the likelihood from approximately 23 percent (DIRS 153066-Murphy 2000, p. 5) to 25 percent.

For shipments by legal-weight truck, the analysis used the RISKIND computer program to estimate doses to inspectors (DIRS 101483-Yuan et al. 1995, all). The data used by the program to calculate dose includes the estimated value for dose rate at 1 meter (3.3 feet) from a cask surface, the length and diameter of the cask, the distance between the location of the individual and the cask surface, and the estimated time of exposure. For this calculation, the analysis assumed that an inspector following Commercial Vehicle Safety Alliance procedures (DIRS 156422-CVSA 2001, all) would work for 1 hour at an average distance of 1 meter (3.3 feet) from the cask. The analysis assumed that a typical legal-weight truck cask would be about 1 meter in diameter and about 5 meters (16 feet) long and that the dose rate 1 meter from the cask surface would be 14 millirem per hour. A dose rate of 14 millirem per hour 1 meter from the surface of a truck cask is approximately equivalent to the maximum dose rate allowed by U.S. Department of Transportation regulations for exclusive-use shipments of radioactive materials (49 CFR 173.441).

Using these data, the RISKIND computer program calculated an expected dose of 18 millirem for an individual inspector. Under the mostly legal-weight truck scenario in which approximately 2,200 legal-weight truck shipments would arrive in Nevada annually, a Nevada inspector working 1,800 hours per year could inspect as many as 450 shipments in a year. This inspector would receive a dose of 8.1 rem. If this same inspector inspected all shipments over the 24 years of the Proposed Action, he or she would be exposed to approximately 200 rem. However, DOE would control worker exposure through administrative procedures (see DIRS 156764-DOE 1999, Article 211). Actual worker exposure would likely be 2 rem per year, or a maximum of 48 rem over 24 years. The use of the dose-to-risk conversion factors published by the International Commission on Radiation Protection projects this exposure to increase the likelihood of this individual contracting a fatal cancer. The projection would add about 2 percent to the likelihood for fatal cancers from all other causes, increasing the likelihood from approximately 23 percent (DIRS 153066-Murphy 2000, p. 5) to 25 percent. As discussed below, however, doses to inspectors likely would be much smaller.

DOE implements radiation protection programs at its facilities where there is the potential for worker exposure to cumulative doses from ionizing radiation. The Department anticipates that the potential for

individual whole-body doses such as those reported above would lead an involved state to implement such a radiation protection program. If similar to those for DOE facilities, the administrative control limit on individual dose would not exceed 2 rem per year (DIRS 156764-DOE 1999, Article 211), and the expected maximum exposure for inspectors would be less than 500 millirem per year.

Under the mostly legal-weight truck scenario, the annual dose to inspectors in a state that inspected all incoming legal-weight truck shipments containing spent nuclear fuel or high-level radioactive waste would be as much as 40 person-rem. Over 24 years, the population dose for these inspectors would be about 950 person-rem. This would result in about 0.38 latent cancer fatality (this is equivalent to a 47-percent likelihood that there would be 1 additional latent cancer fatality among the exposed group).

The EIS analysis assumed that shipments would be inspected in the state of origin and in the destination state. If each state required an inspection on entry, the total occupational dose over 24 years of operation for the mostly legal-weight truck scenario would increase from approximately 14,000 person-rem to approximately 21,000 person-rem, resulting in an additional 3 latent cancer fatalities to the occupationally exposed population.

J.1.3.2.2.3 Incident-Free Radiation Doses to Escorts. This section has been moved to Volume IV of this EIS.

J.1.3.2.3 Vehicle Emission Impacts

Human health impacts from exposures to vehicle exhaust depend principally on the distance traveled and on the impact factors for fugitive dust and exhaust particulates from truck (including escort vehicles) or rail emissions (DIRS 151198-Biwer and Butler 1999, all; DIRS 155786-EPA 1997, all; DIRS 155780-EPA 1993, all).

The analysis estimated incident-free impacts using unit risk factors that account for fatalities associated with emissions of pollution in urban, suburban, and rural areas by transportation vehicles, including escort vehicles. Because the impacts would occur equally for trucks and railcars transporting loaded or unloaded shipping casks, the analysis used round-trip distances. Escort vehicle impacts were included only for loaded truck shipment miles, but were included for round trips for rail escort cars.

The analysis used risk factors to estimate impacts. The factors considered the effects of population density near highways and railroads. For urban areas, the value used for truck transportation was about 5 latent fatalities per 100 million kilometers traveled (8 latent fatalities per 100 million miles) by trucks and 2 latent fatalities per 10 million kilometers traveled by railcars (3 latent fatalities per 10 million miles). For trucks traveling in suburban and rural areas, the respective risk factors used are about 3 latent fatalities in 100 million kilometers (5 in 100 million miles) and 3 in 10 billion kilometers (5 in 10 billion miles). For railcars traveling in suburban and rural areas, the respective risk factors used are about 9 latent fatalities in 100 million kilometers (1.5 in 10 million miles) and about 8 in 10 billion kilometers (1.5 in 1 billion miles).

Although the analysis estimated human health and safety impacts of transporting spent nuclear fuel and high-level radioactive waste, exhaust and other pollutants emitted by transport vehicles into the air would not measurably affect national air quality. National transportation of spent nuclear fuel and high-level radioactive waste, which would use existing highways and railroads, would average 14.2 million truck kilometers per year for the mostly truck case and 3.5 million railcar kilometers per year from the mostly rail case. The national yearly average for total highway and railroad traffic is 186 billion truck kilometers and 49 billion railcar kilometers (DIRS 148081-BTS 1999, Table 3-22). Spent nuclear fuel and high-level radioactive waste transportation would represent a very small fraction of the total national highway and railroad traffic (0.008 percent of truck kilometers and 0.007 percent of rail car kilometers). In addition,

the contributions to vehicle emissions in the Las Vegas air basin, where all truck shipments (an average of five per day) would travel under the mostly legal-weight truck scenario, would be small in comparison to those from other vehicle traffic in the area. The annual average daily traffic on I-15 0.3 kilometer (0.2 mile) north of the Sahara Avenue interchange is almost 200,000 vehicles (DIRS 103405-NDOT 1997, p. 7), about 20 percent of which are trucks (DIRS 104727-Cerocke 1998, all). For these reasons, national transportation of spent nuclear fuel and high-level radioactive waste by truck and rail would not constitute a meaningful source of air pollution along the nation's highways and railroads.

J.1.3.2.4 Sensitivity of Dose Rate to Characteristics of Spent Nuclear Fuel

For this analysis, DOE assumed that the dose rate external to all shipments of spent nuclear fuel and high-level radioactive waste would be the maximum value allowed by regulations (49 CFR 173.441). However, the dose rate for actual shipments would not be the maximum value of 10 millirem per hour at 2 meters (6.6 feet) from the sides of vehicles. Administrative margins of safety that are established to compensate for limits of accuracy in instruments and methods used to measure dose rates at the time shipments are made would result in lower dose rates. In addition, the characteristics of spent nuclear fuel and high-level radioactive waste that would be loaded into casks would always be within the limit values allowed by the cask's design and its Nuclear Regulatory Commission certificate of compliance.

For example, DOE used data provided in the *GA-4 Legal-Weight Truck Cask Design Report* (DIRS 101831-General Atomics 1993, pp. 5.5-18 and 5.5-19) to estimate dose rates 2 meters (6.6 feet) from transport vehicles for various characteristics of spent nuclear fuel payloads. Figure J-7 shows ranges of burnup and cooling times for spent nuclear fuel payloads for the GA-4 cask. The figure indicates the characteristics of a typical pressurized-water reactor spent nuclear fuel assembly (see Appendix A). Based on the design data for the GA-4 cask, a shipment of typical pressurized-water reactor spent nuclear fuel would result in a dose rate of about 6 millirem per hour at 2 meters from the side of the transport vehicle, or about 60 percent of the limit established by U.S. Department of Transportation regulations (49 CFR 173.441). Therefore, DOE estimates that, on average, dose rates at locations 2 meters (6.6 feet) from the sides of transport vehicles would be about 50 to 70 percent of the regulatory limits. As a result, DOE expects radiological risks to workers and the public from incident-free transportation to be no more than 50 to 70 percent of the values presented in this EIS.

J.1.4 METHODS AND APPROACH TO ANALYSIS OF ACCIDENT SCENARIOS

J.1.4.1 Accidents in Loading Operations

J.1.4.1.1 Radiological Impacts of Loading Accidents

The analysis used information in existing reports to consider the potential for radiological impacts from accidents during spent nuclear fuel loading operations at the commercial and DOE sites. These included a report that evaluated health and safety impacts of multipurpose canister systems (DIRS 104794-CRWMS M&O 1994, all) and two safety analysis reports for onsite dry storage of commercial spent nuclear fuel at independent spent fuel storage installations (DIRS 103449-PGE 1996, all; DIRS 103177-CP&L 1989, all). The latter reports address the handling and loading of spent nuclear fuel assemblies in large casks similar to large transportation casks. In addition, DOE environmental impact statements on the management of spent nuclear fuel and high-level radioactive waste (DIRS 101802-DOE 1995, all; DIRS 101816-DOE 1997, all) provided information on radiological impacts from loading accidents.

DIRS 104794-CRWMS M&O (1994, Sections 3.2 and 4.2) discusses potential accident scenario impacts of four cask management systems at electric utility and other spent nuclear fuel storage sites. This report concentrated on unplanned contact (bumping) during lift-handling of casks, canisters, or fuel assemblies. The two safety analysis reports for independent spent fuel storage installations for commercial spent

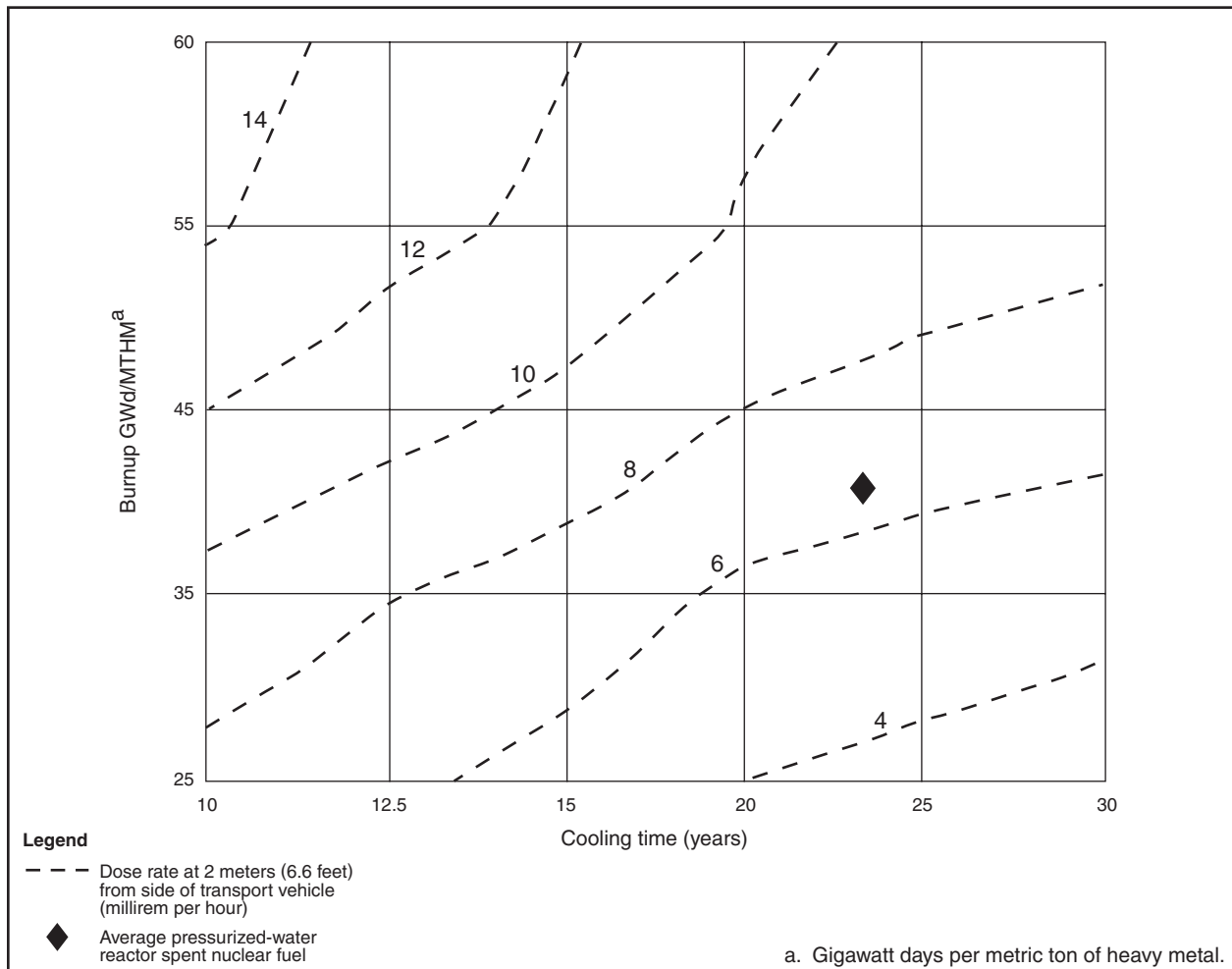

Figure J-7. Comparison of GA-4 cask dose rate and spent nuclear fuel burnup and cooling time.

nuclear fuel (DIRS 103449-PGE 1996, all; DIRS 103177-CP&L 1989, all) evaluated a comprehensive spectrum of accident-initiating events. These events included fires, chemical explosions, seismic events, nuclear criticality, tornado strikes and tornado-generated missile impacts, lightning strikes, volcanism, canister and basket drop, loaded shipping cask drop, and interference (bumping, binding) between the transfer cask and storage module. The DOE environmental impact statements for the interim management of spent nuclear fuel and high-level radioactive waste (DIRS 101802-DOE 1995, Volume 1, Appendix E; DIRS 101816-DOE 1997, Appendixes F and G) included radiological impacts from potential accident scenarios associated with preparing, storing, and shipping these materials. These EISs do not discuss quantitative radiological impacts for accident scenarios associated with material loading, but do contain estimates of radiological impacts from accident scenarios for the spent nuclear fuel and high-level radioactive waste management activities considered. As discussed for routine loading operations, this analysis converted radiation doses to estimates of radiological impacts using dose-to-risk conversion factors of the International Commission on Radiological Protection.

The DIRS 104794-CRWMS M&O (1994, all) study concluded that radiological impacts from handling incidents would be small. The population dose (person-rem) for accidents in handling the four cask systems considered in the study would vary from 0.1 rem to 0.04 rem. This dose would be the total for all persons who would be exposed, onsite workers as well as the public. The highest estimated dose (0.1 person-rem) could result in 0.00005 latent cancer fatality in the exposed population.

J.1.4.1.2 Industrial Safety Impacts of Loading Operations at Commercial Facilities

The principal industrial safety impact parameters of importance to commercial industry and the Federal Government are (1) total recordable (injury and illness) cases, (2) lost workday cases associated with workplace injuries and illnesses, and (3) workplace fatalities. The frequency of these impacts under the Proposed Action and the inventory modules (Modules 1 and 2) was projected using the involved worker level of effort, expressed as the number of full-time equivalent worker multiples, that would be needed to conduct shipment tasks. The workplace loss incidence rate for each impact parameter [as shown in a Bureau of Labor Statistics summary (DIRS 148091-BLS 1998, all)] was used as a multiplier to convert the level of effort to expected industrial safety losses.

DOE did not explicitly analyze impacts to noninvolved workers in its earlier reports (DIRS 101747-Schneider et al. 1987, all; DIRS 104791-DOE 1992, all). However, for purposes of analysis in this EIS, DOE estimated that impacts to noninvolved workers would be 25 percent of the impacts to the involved workforce. This assumption is based on (1) the DOE estimate that about one of five workers assigned to a specific task would perform administrative or managerial duties, and (2) the fact that noninvolved worker loss incidence rates are generally less than those for involved workers (see Appendix F, Section F.2.2.2).

The estimated involved worker full-time equivalent multiples for each shipment scenario were estimated using the following formula:

$$\text{Involved worker full-time equivalent multiples} = (A \times B \times C \times D) \div E$$

where: A = number of shipments (from Tables J-5 and J-6)

B = average loading duration for each shipment by fuel type and conveyance mode (workdays; from Table J-13)

C = workday conversion factor = 8 hours per workday

D = involved worker crew size (13 workers; from Table J-14)

E = full-time equivalent conversion factor = 2,000 worker hours per full-time equivalent

The representative Bureau of Labor Statistics loss incidence rate for each total recordable case, lost workday case, and fatality trauma category (for example, the number of total recordable cases per full-time equivalent) was then multiplied by the involved worker full-time equivalent multiples to project the associated incidence. The involved worker total recordable case incidence rate used was that reported for the Trucking and Warehousing sector for 1998 because neither the Nuclear Regulatory Commission nor the Bureau of Labor Statistics maintains data on commercial power reactor industrial safety losses. The total recordable case incidence rate, 145,700 cases in a workforce of 1.74 million workers (8.4 total recordable cases per 100 full-time equivalents), is the averaged loss experience for 1998. The Trucking and Warehousing sector was chosen because DOE assumed the industrial operations and hazards associated with activities in this sector would be representative of those encountered in handling spent nuclear fuel casks at commercial power reactor sites and DOE facilities. Because lost workday cases are linked to the total recordable case experience (that is, each lost workday case would have to be included in the total recordable case category), the same period of record and facilities was used in the selection of the involved worker lost workday case incidence rate [80,800 lost workday cases in a workforce of 1.74 million workers (4.6 lost workday cases per 100 full-time equivalents)].

The involved worker fatality incidence rate reported by the Bureau of Labor Statistics (1.8 fatalities among 100,000 workers) for the Trucking and Warehousing sector during the DIRS 148091-BLS (1998, all) period of record was used.

DOE used the same Bureau of Labor Statistics data sources to estimate total recordable case, lost workday case, and fatality incidence rates for noninvolved workers.

J.1.4.1.3 Industrial Safety Impacts of DOE Loading Operations

The technical approach and loss multipliers discussed in Section J.1.4.1.2 for commercial power reactor sites analysis were used for the analysis of spent nuclear fuel and high-level radioactive waste loading impacts at DOE sites. Because no information existed on the high-level radioactive waste loading duration for the truck and rail transportation modes, DOE assumed that the number of full-time equivalent involved workers for the two transportation modes would be the same as that for the DOE sites shipping spent nuclear fuel. For those sites, the average number of full-time equivalent workers would be about 0.07 and 0.12 per shipment for the truck and rail transportation modes, respectively.

J.1.4.2 Transportation Accident Scenarios

J.1.4.2.1 Radiological Impacts of Transportation Accidents

Potential consequences and risks of transportation would result from three possible types of accidents: (1) accidents in which there is no effect on the cargo and the safe containment by transportation packages is maintained, (2) accidents in which there is no breach of containment, but there is loss of shielding because of lead shield displacement, and (3) accidents that release and disperse radioactive material from safe containment in transportation packages. Such accidents, if they occurred, would lead to impacts to human health and the environment. The following sections describe the methods for analyzing the risks and consequences of accidents that could occur in the course of transporting spent nuclear fuel and high-level radioactive waste to a nuclear waste repository at the Yucca Mountain site. They discuss the bases for, and methods for, determining rates at which accidents are assumed to occur, the severity of these accidents, and the amounts of materials that could be released. Accident rates, severities, and the corresponding quantities of radioactive materials that could be released are essential data used in the analyses. Appendix A presents the quantities of radioactive materials in a typical pressurized-water reactor spent nuclear fuel assembly used in the analysis of accident consequences and risks. Legal-weight truck casks would usually contain four pressurized-water reactor spent nuclear fuel assemblies, and rail casks would usually contain 24 (see Table J-3).

In addition to accident rates and severities, an important variable in assessing impacts from transportation accident scenarios is the type of material that would be shipped. Accordingly, this appendix presents information used in the analyses of impacts of accidents that could occur in the course of transporting commercial pressurized- and boiling-water reactor fuels, DOE spent nuclear fuels, and DOE high-level radioactive waste.

For exposures to ionizing radiation and radioactive materials following accidents, risks were analyzed in terms of dose and latent cancer fatalities to the public and workers. The analyses of risk also addressed the potential for fatalities that would be the direct result of mechanical forces and other nonradiological effects that occur in everyday vehicle and industrial accidents.

The transportation of spent nuclear fuel and high-level radioactive waste from the 77 sites to the Yucca Mountain site would be conducted in a manner that complied fully with regulations of the U.S. Department of Transportation and Nuclear Regulatory Commission. These regulations specify requirements that promote safety and security in transportation. The requirements apply to carrier

POTENTIAL EFFECTS OF HUMAN ERROR ON ACCIDENT IMPACTS

The accident scenarios described in this chapter would be mostly a direct consequence of error on the part of transport vehicle operators, operators of other vehicles, or persons who maintain vehicles and rights-of-way. The number and severity of the accidents would be minimized through the use of trained and qualified personnel.

Others have argued that other kinds of human error could also contribute to accident consequences: (1) undetected error in the design and certification of transportation packaging (cask) used to ship radioactive material, (2) hidden or undetected defects in the manufacture of these packages, and (3) error in preparing the packages for shipment. DOE has concluded that regulations and regulatory practices of the Nuclear Regulatory Commission and the Department of Transportation address the design, manufacture, and use of transportation packaging and are effective in preventing these kinds of human error by requiring:

- Independent Nuclear Regulatory Commission review of designs to ensure compliance with requirements (10 CFR Part 71)
- Nuclear Regulatory Commission-approved and audited quality assurance programs for design, manufacturing, and use of transportation packages

In addition, Federal provisions (10 CFR Part 21) provide additional assurance of timely and effective actions to identify and initiate corrective actions for undetected design or manufacturing defects. Furthermore, conservatism in the approach to safety incorporated in the regulatory requirements and practices provides confidence that design or manufacturing defects that might remain undetected or operational deficiencies would not lead to a meaningful reduction in the performance of a package under normal or accident conditions of transportation.

operations; in-transit security; vehicles; shipment preparations; documentation; emergency response; quality assurance; and the design, certification, manufacture, inspection, use, and maintenance of packages (casks) that would contain the spent nuclear fuel and high-level radioactive waste.

Because of the high level of performance required by regulations for transportation casks (49 CFR Part 173 and 10 CFR Part 71), the Nuclear Regulatory Commission estimates that in more than 99.99 percent of rail and truck accidents no cask contents would be released (DIRS 152476-Sprung et al. 2000, pp. 7-73 to 7-76). The 0.007 percent of accidents, including those for which there is no release and those that could cause a release of radioactive materials, can be described by a spectrum of accident severity. In general, as the severity of an accident increases, the fraction of radioactive material contents that could be released from transportation casks also increases. However, as the severity of an accident increases it is generally less likely to occur. DIRS 152476-Sprung et al. (2000, all) developed an accident analysis methodology that uses this concept of a spectrum of severe accidents to calculate the probabilities and consequences of accidents that could occur in transporting highly radioactive materials.

The analysis in DIRS 152476-Sprung et al. (2000, pp. 7-74 and 7-76), which DOE adopted for the analysis in the EIS, estimates that 0.01 percent of accidents to steel-lead-steel casks could result in some lead displacement and consequent loss of shielding. The analysis evaluated the radiological impacts (population dose risk) of shielding loss and the impacts of potential releases of radioactive material. The loss-of-shielding analysis included estimates of radiological impacts for the percentage of accidents in which there would be neither loss of shielding nor release of radioactive material. In such accidents, the vehicle carrying the spent nuclear fuel would be stopped along the route for an extended period and nearby residents would not be evacuated.

Although the approach of DIRS 152476-Sprung et al. (2000, pp. 7-7 to 7-12), which is used in this EIS, provides a method for determining the frequency with which severe accidents can be expected to occur, their severity, and their consequences, a method does not exist for predicting where along routes accidents would occur. Therefore, the analyses of impacts presented here used the approach used in RADTRAN 5 (DIRS 155430-Neuhauser, Kanipe, and Weiner 2000, all). This method assumes that accidents could occur at any location along routes, with their frequency of occurrence being determined by the accident rate characteristic of the states through which the route passes, the length of the route, and the number of shipments that travel the route.

The transportation accident scenario analysis evaluated radiological impacts to populations and to hypothetical maximally exposed individuals and estimated fatalities that could occur from traffic accidents. It included both rail and legal-weight truck transportation. The analysis used the RADTRAN 5 (DIRS 150898-Neuhauser and Kanipe 2000, all; DIRS 155430-Neuhauser, Kanipe, and Weiner 2000, all) and RISKIND (DIRS 101483-Yuan et al. 1995, all) models and computer programs to determine accident consequences and risks. DOE has used both codes in recent DOE environmental impact statements (DIRS 101802-DOE 1995, Volume 1, Appendix J; DIRS 101812-DOE 1996, Appendix E; DIRS 101816-DOE 1997, Appendixes F and G) that address impacts of transporting radioactive materials. The analyses used the following information to determine the consequences and risks of accidents for populations:

- Routes from the 77 sites to the repository and their lengths in each state and population zone
- The number of shipments that would be transported over each route
- State-specific accident rates
- The kind and amount of radioactive material that would be transported in shipments
- The type of cask used in spent nuclear fuel and high-level radioactive waste transportation
- Probabilities of amount of lead displacement that would result in loss of shielding
- Probabilities of release and fractions of cask contents that could be released in accidents
- The number of people who could be exposed to radiological material from accidents and how far they lived from the routes
- The length of time people could be exposed to external radiation in accidents that do not involve releases of radioactive material
- Exposure scenarios that include multiple exposure pathways, state-specific agricultural factors, and atmospheric dispersion factors for neutral and stable conditions applicable to the entire country for calculating radiological impacts

The analysis used the same routes and lengths of travel as the analysis of incident-free transportation impacts discussed above.

DOE used the CALVIN computer code discussed earlier, the DOE Throughput Study (DIRS 100265-CRWMS M&O 1997, all), and information provided by the DOE National Spent Nuclear Fuel Program (DIRS 104778-Jensen 1998, all) to calculate the number of shipments from each site and, thus, the number of shipments that would use a particular route.

TRANSPORTATION ACCIDENT RADIOLOGICAL DOSE RISK

The risk to the general public of radiological consequences from transportation accidents is called *dose risk* in this EIS. Dose risk is the sum of the products of the probabilities (dimensionless) and the consequences (in person-rem) of all potential transportation accidents.

The probability of a single accident is usually determined by historical information on accidents of a similar type and severity. The consequences are estimated by analysis of the quantity of radionuclides likely to be released, potential exposure pathways, potentially affected population, likely weather conditions, and other information.

As an example, the dose risk from a single accident that had a probability of 0.001 (1 chance in 1,000), and would cause a population dose of 22,000 person-rem in a population if it did occur, would be 22 person-rem. If that population was subject to 1,000 similar accident scenarios, the total dose risk would be 22,000 person-rem. Using the conversion factor of 0.0005 latent cancer fatality per person-rem, an analysis would estimate a health and safety risk of 11 latent cancer fatalities from this population dose risk.

The state-specific accident rates (accidents and fatalities per kilometer of vehicle travel) used in the analysis included accident statistics for commercial motor carrier operations for the Interstate Highway System, other U.S. highways, and state highways for each of the 48 contiguous states (DIRS 103455-Saricks and Tompkins 1999, all). The analysis also used average accident and fatality rates for railroads in each state. The data specifically reflect accident and fatality rates that apply to commercial motor carriers and railroads.

Appendix A contains information on the radioactive material contents of shipments. Appendix A, Section A.2.1.5 describes the characteristics of the spent nuclear fuel and high-level radioactive waste that would be shipped. The analysis assumed that the inventory of radioactive materials in shipments would be representative pressurized-water reactor spent nuclear fuel that had been removed from reactors for 15 years. Appendix A describes this inventory. The estimated impacts would be less if the analysis used the characteristics of a typical boiling-water reactor spent nuclear fuel, DOE spent nuclear fuel (including naval spent nuclear fuel, which the analysis assumed would be removed from reactors 5 years before its shipment to the repository), or high-level radioactive waste. Section J.1.2.1.1 describes the casks.

The analysis also used the number of people who potentially would be close enough to transportation routes at the time of an accident to be exposed to radiation or radioactive material released from casks, and the distances these people would be from the accidents. It used the HIGHWAY and INTERLINE computer programs to determine this estimated number of people and their distances from accidents. HIGHWAY and INTERLINE used 1990 Census data for this analysis. In addition, the analysis escalated impacts to account for changes in population from 1990 to 2035 using Bureau of the Census projections. The analysis assumed that the region of influence extended 80 kilometers (50 miles) from an accident involving a release of radioactive material, and 800 meters (0.5 mile) on either side of the route for accidents with no release.

Accident Severity Categories and Conditional Probabilities

For accidents involving release of radioactive material, DIRS 152476-Sprung et al. (2000, pp. 7-73 to 7-76) organizes truck and rail accident scenarios according to estimated severity, likelihood of that severity, and releases that might result. Nineteen scenarios for legal-weight truck and 21 scenarios for

rail were postulated. Classification matrices were made for four generic casks and pressurized-water and boiling-water reactor commercial spent nuclear fuel types. Figures J-8a and J-8b show the classification matrices for the cask and fuel used in the analysis of impacts presented in this EIS: steel-depleted uranium-steel casks for truck shipments of pressurized-water reactor fuel and steel-lead-steel casks for rail shipments of pressurized-water reactor fuel. Use of data from DIRS 152476-Sprung et al. (2000, pp. 7-73 to 7-76) for other cask types and for boiling-water reactor spent nuclear fuel would lead to smaller impacts.

Figures J-8a and J-8b have been moved to Volume IV of this EIS.

Accident severity is a function of two variables. The first variable is the mechanical force that occurs in impacts. In the figures, mechanical force is represented by the impact velocity along the vertical axis of the matrix. The second variable is thermal energy, or the heat input to a cask engulfed by fire, also along the horizontal axis. Thermal energy is represented by the midpoint temperature of a cask's lead shield wall following heating, as in a fire.

Because all accident scenarios that would involve casks can be described in these terms, the severity of accidents can be analyzed independently of specific accident sequences. In other words, any sequence of events that results in an accident in which a cask is subjected to mechanical forces, within a certain range of values, and possibly fire is assigned to the accident severity category associated with the applicable ranges for the two parameters. This accident severity scheme enables analysis of a manageable number of accident situations while accounting for all reasonably foreseeable transportation accidents, including accidents with low probabilities but high consequences and those with high probabilities but low consequences. The scheme also encompasses by inference all scenarios that result in a particular outcome.

For the analysis of impacts, a conditional probability was assigned to each accident severity category. Figures J-8a and J-8b show the conditional probabilities developed in DIRS 152476-Sprung et al. (2000, pp. 7-73 to 7-76) for the accident severity matrix. These conditional probabilities were used in the analysis of impacts presented in this appendix. The conditional probabilities are the chances that accidents will involve the mechanical forces and the heat energy in the ranges that apply to the categories. For example, accidents that would fall into Cell 19 in the lower left corner of Figure J-8a, which represents the least severe accident in the matrix, would be likely to make up 99.993 percent of all accidents that would involve truck shipments of casks carrying spent nuclear fuel. The mechanical forces and heat in accidents in this category would not exceed the regulatory design standards for casks. Using the information in the figure, in an accident in this category the safety function of the cask would not be lost and the temperature of the cask would not change. These conditions are within the range of damage that would occur to casks subjected to the hypothetical accident conditions tests that Nuclear Regulatory Commission regulations require a cask to survive (10 CFR Part 71). Accidents in Cell 7 or Cell 12, for example, which would cause considerable damage to a cask, are very severe but very infrequent. Cell 7 accidents would occur an estimated 3 times in each 1 trillion truck accidents, and Cell 12 accidents would occur an estimated 2 times in each 100 trillion truck accidents.

The probabilities shown in each cell of Figures J-8a and J-8b are the conditional probabilities derived from event trees (for example, DIRS 152476-Sprung et al. 2000, p. 7-10) that are assigned to each severity category. These conditional probabilities are the chances that, if an accident occurs, that accident will involve the impact speed and the heat energy in the ranges that apply to the categories. The analysis of accident risks presented in this appendix used the frequency that would be likely for accidents in each of the severity categories. This frequency was determined by multiplying the category's conditional probability by the accident rates for each state's urban, suburban, and rural population zones and by the shipment distances in each of these zones, and then adding the results. The accident rates in the

population density zones in each state are distinct and correspond to traffic conditions, including average vehicle speed, traffic density, and other factors, including rural, suburban, or urban location.

Accident Releases

To assess radiological consequences, cask release fractions for each accident severity category for each chemically and physically distinct radioisotope were calculated (DIRS 152476-Sprung et al. 2000, Sections 7.3 and 7.4). The *release fraction* of each isotope is the fraction of that isotope in the cask that could be released from the cask in a given severity of accident. Release fractions vary according to spent nuclear fuel type and the physical/chemical properties of the radioisotopes. Almost all of the radionuclides in spent nuclear fuel are chemically stable and do not react chemically when released. All are physically stable and most are in solid form. Gaseous radionuclides, such as krypton-85, could be released if both the fuel cladding and cask containment boundary were compromised. Volatile radionuclides, like radiocesium iodide, could be released in part, and would also deposit on the inside of the cask, depending on the temperature of the cask.

DIRS 152476-Sprung et al. (2000, p. 7-71) developed release fractions for commercial spent nuclear fuel from both boiling-water and pressurized-water reactors. Figures J-8a and J-8b provide examples of these release fractions. The analysis estimated the amount of radioactive material released from a cask in an accident by multiplying the approximate release fraction by the number of fuel assemblies in a cask (see Table J-3) and the radionuclide activity of a spent nuclear fuel assembly (see Appendix A). To provide perspective, the release fraction for a category 6 accident involving a large rail cask carrying 60 assemblies of spent boiling-water reactor fuel could result in an estimated release of about 48 curies of cesium isotopes. For this analysis, the release fractions developed by DIRS 152476-Sprung et al. (2000, pp. 7-73 to 7-76) were used for commercial pressurized-water and boiling-water reactor fuel. In addition, the analysis used release fractions for spent nuclear fuel from training, research and isotope reactors built by General Atomics (commonly called *TRIGA* spent nuclear fuel), aluminum-based fuel, uranium-carbide fuel, and vitrified high-level radioactive waste.

Accidental Loss of Shielding

Under accident conditions, a reduction in the radiation shielding provided by the spent nuclear fuel cask could occur. An accident where shielding is lost or its effectiveness reduced is often referred to as a loss of shielding accident. Shielding could be lost in high-impact collisions, which could cause lead shielding in a cask to slump towards the point of impact, or in a long-duration, intense fire, which could cause lead shielding to melt and expand. As the lead shielding cooled and solidified, it could shrink and possibly leave voids. Puncture of the cask could result in loss of melted lead. Loss of shielding can occur only in casks that use lead as shielding; it cannot occur in casks that use steel or depleted uranium for shielding.

Using the data presented in Table 8.12 from DIRS 152476-Sprung et al. (2000, pp. 8-47 to 8-50), conditional probabilities, radiation dose rates, and an exposure factor for calculating collective dose were developed for 6 accident severity categories that represent a complete spectrum of loss of shielding accidents (see Table J-19) for 4 cask types. The exposure factors were calculated using RADTRAN 5 assuming that a population from 30 to 800 meters (98 to 2,600 feet) was exposed for 12 hours. Unit risk factors were calculated by multiplying the exposure factor by the accident conditional probability. Category 1 represents accidents where there was no loss of shielding and resulting radiation dose rate and exposure factor are for an undamaged cask. This is the only category applicable to steel or depleted uranium casks. Categories 2 through 6 represent accidents that involve various impact speeds and temperatures. Table J-20 shows the relationship of the 6 accident severity categories for loss of shielding presented here to the 21 rail accident cases and 19 truck accident cases discussed in DIRS 152476-Sprung et al. (2000, pp. 7-73 through 7-76).

Table J-19. Loss-of-shielding conditional probabilities, radiation dose rates, and exposure factors for four cask types and six accident severity categories.^a

Cask type	Conditional probability	Radiation dose rate (rem per hour) ^b	Exposure factor (person-rem per person/km ²) ^c
Steel-lead-steel rail			
Category 1	0.9999	1.4×10^{-2}	3.9×10^{-5}
Category 2	6.4×10^{-6}	8.2	7.2×10^{-3}
Category 3	4.9×10^{-5}	2.4	2.0×10^{-3}
Category 4	4.5×10^{-7}	1.3×10^1	1.2×10^{-2}
Category 5	2.4×10^{-5}	2.9	2.4×10^{-3}
Category 6	5.2×10^{-9}	2.4×10^1	3.0×10^{-2}
Steel-lead-steel truck			
Category 1	0.9999	1.4×10^{-2}	3.9×10^{-5}
Category 2	4.5×10^{-7}	1.3×10^1	7.1×10^{-3}
Category 3	4.9×10^{-5}	2.4	8.5×10^{-4}
Category 4	6.4×10^{-6}	8.2	3.5×10^{-3}
Category 5	2.4×10^{-5}	2.9	1.0×10^{-3}
Category 6	5.2×10^{-9}	2.4×10^1	2.2×10^{-2}
Monolithic rail			
Category 1	1.0000	1.4×10^{-2}	3.9×10^{-5}
Category 2	0.0	1.4×10^{-2}	3.9×10^{-5}
Category 3	0.0	1.4×10^{-2}	3.9×10^{-5}
Category 4	0.0	1.4×10^{-2}	3.9×10^{-5}
Category 5	0.0	1.4×10^{-2}	3.9×10^{-5}
Category 6	0.0	1.4×10^{-2}	3.9×10^{-5}
Steel-depleted uranium-steel rail			
Category 1	1.0000	1.4×10^{-2}	3.9×10^{-5}
Category 2	0.0	1.4×10^{-2}	3.9×10^{-5}
Category 3	0.0	1.4×10^{-2}	3.9×10^{-5}
Category 4	0.0	1.4×10^{-2}	3.9×10^{-5}
Category 5	0.0	1.4×10^{-2}	3.9×10^{-5}
Category 6	0.0	1.4×10^{-2}	3.9×10^{-5}

a. Source: Calculated by RADTRAN 5.

b. Radiation dose rate at 1 meter from the cask.

c. km² = square kilometer; 1 square kilometer = 0.39 square miles or 247.1 acres.

Table J-20. Grouping of accident cases into accident categories.^a

Accident category	Rail accident cases	Truck accident cases
Category 1	21	19
Category 2	1, 7, 8, 9	2, 10, 11, 12
Category 3	20	18
Category 4	2, 10, 11, 12	1, 7, 8, 9
Category 5	4, 5, 6	4, 5, 6
Category 6	3, 13, 14, 15, 16, 17, 18, 19	3, 13, 14, 15, 16, 17

a. Source: Adapted from DIRS 152476-Sprung et al. (2000, Table 8.12).

The unit risk factor for a category was multiplied by the shipment distance, the number of shipments, the accident rate, and the population density to yield the radiation dose to the exposed population for the category. The radiation doses for all categories were summed to yield the overall radiation dose from all categories of loss of shielding accidents.

Atmospheric Conditions

For the analyses of accident risk and consequences, releases of radioactive materials from casks during and following severe accidents were assumed to be into the air where these materials would be carried by

wind. Because it is not possible to predict specific locations where transportation accidents would occur, average U.S. atmospheric conditions were used.

RADTRAN 5, which DOE used in the analysis, contains embedded tables giving the “footprint” of the dispersed plume in curves of constant concentration, called isopleths, for each of the six Pasquill stability classes (DIRS 155430-Neuhauser, Kanipe, and Weiner 2000, Chapter 4). These tables incorporate wind speed, downwind distance, area of the footprint, and dilution of the plume. Dispersion of releases from an accident are then modeled by combining these tables to represent national average weather conditions. The RADTRAN 5/database combination was then used in the analysis to calculate an accident *dose risk* incorporating the risk from inhaled and ingested radioactive material, and external radiation from radioactive material deposited on the ground and suspended in the air.

Table J-21 lists the frequency at which atmospheric stability and wind speed conditions occur in the contiguous United States. The data, which are averages for 177 meteorological data collection locations, were used in conjunction with the RADTRAN 5/database to calculate the population (collective) dose risk from any accident, as well as with the RISKIND computer program (DIRS 101483-Yuan et al. 1995, all). RISKIND was used to estimate the consequences of maximum reasonably foreseeable accidents and acts of sabotage.

Table J-21. Frequency of atmospheric and wind speed conditions – U.S. averages.^a

Atmospheric stability class	Wind speed condition						Total
	WS(1)	WS(2)	WS(3)	WS(4)	WS(5)	WS(6)	
A	0.00667	0.00444	0.00000	0.00000	0.00000	0.00000	0.01111
B	0.02655	0.02550	0.01559	0.00000	0.00000	0.00000	0.06764
C	0.01400	0.02931	0.05724	0.01146	0.00122	0.00028	0.11351
D	0.03329	0.07231	0.15108	0.16790	0.03686	0.01086	0.47230
E	0.00040	0.04989	0.06899	0.00146	0.00016	0.00003	0.12093
F	0.10771	0.08710	0.00110	0.00000	0.00000	0.00000	0.19591
G	0.01713	0.00146	0.00000	0.00000	0.00000	0.00000	0.01859
F+G	0.12485	0.08856	0.00110	0.00000	0.00000	0.00000	0.21451
<i>Totals</i>	<i>0.20576</i>	<i>0.27000</i>	<i>0.29401</i>	<i>0.18082</i>	<i>0.03825</i>	<i>0.01117</i>	<i>1.00000</i>
Wind speed (meters per second) ^b	0.89	2.46	4.47	6.93	9.61	12.52	

a. Source: DIRS 104800-CRWMS M&O (1999, p. 40).

b. To convert meters per second to miles per hour, multiply by 2.237.

In calculating estimated values for consequences, RISKIND used the atmospheric stability and wind speed data to analyze the dispersion of radioactive materials in the atmosphere that could follow releases in severe accidents. Using the results of the dispersion analysis, RISKIND calculated values for radiological consequences (population dose and dose to a maximally exposed individual). These results were placed in order from largest to smallest consequence. Following this order, the probabilities of the atmospheric conditions associated with each set of consequences were incorporated to provide a cumulative probability. This procedure was followed to identify the most severe accident consequences that would have a cumulative estimated annual frequency of occurrence of at least 1 in 10 million. The procedure was carried out separately for urban and rural accidents and for neutral and stable atmospheric conditions.

Exposure Pathways

Radiation doses from released radioactive material were calculated for an individual who is postulated to be near the scene of an accident and for populations within 80 kilometers (50 miles) of an accident location. Doses were determined for rural, suburban, and urban population groups. Dose calculations

considered a variety of exposure pathways, including inhalation and direct exposure (cloudshine and immersion in a plume of radioactive material) from a passing cloud of contaminants; ingestion from contaminated crops; direct exposure from radioactivity deposited on the ground (groundshine); and inhalation of radioactive particles resuspended by wind from the ground.

Emergency Response, Interdiction, Dose Mitigation, and Evacuation

The RADTRAN 5 computer program that DOE used to estimate radiological risks allows the user to include assumptions about the postaccident remediation of radioactive material contamination of land where people live. The analysis using the program assumed that, after an accident, contaminants would continue to contribute to population dose through three pathways—groundshine, inhalation of resuspended particulates, and, for accidents in rural areas, ingestion of foods produced on the contaminated lands. It also assumed that medical and other interdiction would not occur to reduce concentrations of radionuclides absorbed or deposited in human tissues as a result of accidents.

For a discussion of emergency response to transportation accidents, see Appendix M, Section M.5.

Similarly, the RISKIND (DIRS 101483-Yuan et al. 1995, all) computer program includes assumptions about response, interdiction, dose mitigation, and evacuation for calculating radiological consequences (dose to populations and maximally exposed individuals). In estimating consequences of maximum reasonably foreseeable accidents during the transportation of spent nuclear fuel and high-level radioactive waste to the repository, the analysis assumed the following:

- Populations would continue to live on contaminated land for 1 year.
- There would be no radiological dose to populations from ingestion of contaminated food. Food produced on land contaminated by a maximum reasonably foreseeable accident would be embargoed from consumption.
- Medical and other interdiction would not occur to reduce concentrations of radionuclides absorbed or deposited in human tissues as a result of an accident.

The analysis of a maximum foreseeable loss-of-shielding accident assumed that the vehicle would be stopped at the site of the accident for 12 hours.

Emergency management personnel (first responders) would be between 2 and 10 meters (6.6 and 33 feet) from the vehicle for about an hour to secure the vehicle and keep people away. For about half of this time, the emergency personnel would be exposed to that section of the cask where shielding had been lost.

The analysis of radiological risks to populations and estimates of consequences of maximum reasonably foreseeable accidents did not explicitly address local, difficult-to-evacuate populations such as those in prisons, hospitals, nursing homes, or schools. However, the analysis addressed the potential for accidents to occur in urban areas with high population densities and used the assumptions regarding interdiction, evacuation, and other intervention actions discussed above. These assumptions encompass the consequences and risks that could arise as a result of time to implement measures to mitigate the consequences for some population groups.

Health Risk Conversion Factors

The health risk conversion factors used to estimate expected latent cancer fatalities from radiological exposures are presented in International Commission on Radiological Protection Publication 60 (DIRS 101836-ICRP 1991, p. 22). These factors are 0.0005 latent cancer fatality per person-rem for members of the public and 0.0004 latent cancer fatality per person-rem for workers. For accidents in which

individuals would receive doses greater than 20 rem over a short period (high dose/high dose rate), the factors would be 0.0010 latent cancer fatality per rem for a member of the public and 0.0008 latent cancer fatality per rem for workers.

Assessment of Accident Risk

The RADTRAN 5 database (DIRS 155430-Neuhauser, Kanipe, and Weiner 2000, all) was used in calculating risks from transportation of spent nuclear fuel and high-level radioactive waste. The code calculated unit-risk factors (person-rem per person per square kilometer per curie) for the radionuclides of concern in the inventory being shipped (see Appendix A). The unit-risk factors from RADTRAN 5 were combined with conditional accident probabilities, state-specific accident rates, release fractions for each of the six accident severity categories, for each mode of transportation, cask, and spent nuclear fuel or high-level radioactive waste form. For each site traversed, results of this analysis were combined with urban, suburban, and rural distances and population densities, and with the number of shipments. Ingestion dose risks were calculated separately by combining conditional accident probabilities, state-specific accident rates, release fractions for each of the six accident severity collective categories, and rural distances and numbers of shipments for each state with the state-specific food transfer factors. The accident dose risks were estimated in terms of collective radiation dose to the population within 80 kilometers (50 miles).

The analysis first calculated unit risk factors for a shipment. This was done for the three types of population zones in each state and for each accident severity category. The unit risk factors were for one person per square kilometer per kilometer of route traveled. The unit risk factors were multiplied by the population densities (based on 1990 Census data) along the routes. These population densities are modeled as being within 800 meters (0.5 mile) of the routes. The accident dose risk calculation then assumed that the population density in the 800-meter band along the route is the same out to 80 kilometers (50 miles) from the route and multiplies the unit risk factor by this population density, yielding a dose risk in person-rem per kilometer of route for each transportation mode, for each type of impact, and for each state through which a shipment would pass. The resultant dose risks (person-rem per kilometer) for all the applicable accident severity categories were summed for each population zone for each state. Also, for the three types of population zone in a state, the lengths through areas of each type were summed for the route used in the analysis. This yielded route lengths for each population zone in each state. The sum of the route lengths and the sum of the dose risks per kilometer for each population zone were multiplied together. This was repeated for each population zone in each state through which a shipment would pass. The resulting impacts were then multiplied by a scaling factor that is the ratio of the population in a state based on the 1990 Census to projected population in 2035. The results were summed to provide estimates of the accident dose risk (in person-rem) for a shipment.

Estimating Consequences of Maximum Reasonably Foreseeable Accident Scenarios

In addition to analyzing the radiological and nonradiological risks that would result from the transportation of spent nuclear fuel and high-level radioactive waste to the repository, DOE assessed the consequences of maximum reasonably foreseeable accidents using the analysis from DIRS 152476-Sprung et al. (2000, pp. 7-30 to 7-70) for releases of material from a spent nuclear fuel cask during an accident. This analysis provided information about the magnitude of impacts that could result from the most severe accident that could reasonably be expected to occur, although it could be highly unlikely. DOE concluded that, as a practical matter, events with a probability less than 1×10^{-7} (1 chance in 10 million) per year rarely need to be examined (DIRS 104601-DOE 1993, p. 28). This would be equivalent to about once in the course of 15 billion legal-weight truck shipments. For perspective, an accident this severe in commercial truck transportation would occur about once in 50 years on U.S. highways. Thus, the analysis of maximum reasonably foreseeable accidents postulated to occur during the transportation of spent nuclear fuel and high-level radioactive waste evaluated only consequences for accidents with a probability greater than 1×10^{-7} per year. The consequences were determined for atmospheric conditions

that could prevail during accidents and for physical and biological pathways that would lead to exposure of members of the public and workers to radioactive materials and ionizing radiation. The analysis used the RISKIND code (DIRS 101483-Yuan et al. 1995, all) to estimate doses for individuals and populations. In addition to the accidents with a probability greater than 1×10^{-7} per year, the analysis estimated the consequences from all accident severity categories presented in DIRS 152476-Sprung et al. (2000, pp. 7-73 and 7-76) for a steel-depleted uranium-steel truck cask and a steel-lead-steel rail cask. The following list describes those severity categories:

Rail Accident Descriptions

- **Case 20:** Case 20 is a long-duration (many hours), high-temperature fire that would engulf a cask. Conditions reported in the Baltimore Sun Times for the Baltimore Tunnel Fire (DIRS 156753-Ettlin 2001, all; DIRS 156754-Rascovar 2001, all), which occurred in July 2001—a fire of 820°C (1,500°F) that burned for up to 5 days—would be similar to the conditions for a Case 20 accident.
- **Cases 19, 18, 17, and 16:** Case 19 is a high-speed (more than 120 miles per hour) impact into a hard object such as a train locomotive severe enough to cause failure of cask seals and puncture through the cask’s shield wall. The impact would be followed by a very long duration (many hours), high-temperature engulfing fire. Case 18, Case 17, and Case 16 are accidents that would also involve very long duration fires, failures of cask seals, and puncture of cask walls. However, these accidents would be progressively less severe in terms of impact speeds. The impact speeds range from 90 to 120 miles for Case 18, 60 to 90 miles per hour for Case 17, and 30 to 60 miles per hour for Case 16.
- **Cases 15, 12, 9, and 6:** Case 15 is a high-speed (more than 120 miles per hour) impact into a hard surface such as granite severe enough to cause failure of cask seals. The impact would be followed by a long duration (many hours), high-temperature engulfing fire. Case 12, Case 9, and Case 6 are also accidents that would involve long duration fires, and failures of cask seals. However, these accidents would be progressively less severe in terms of impact speeds ranging from 90 to 120 miles for Case 12, 60 to 90 miles per hour for Case 9, and 30 to 60 miles per hour for Case 6.
- **Cases 14, 11, 8, and 5:** Case 14 is a high-speed (more than 120 miles per hour) impact into a hard surface such as granite severe enough to cause failure of cask seals. The impact would be followed by a high-temperature engulfing fire that burned for hours. Case 11, Case 8, and Case 5 are also accidents that would involve fires that would burn for hours, and failures of cask seals. However, these accidents would be progressively less severe in terms of impact speeds ranging from 90 to 120 miles for Case 11, 60 to 90 miles per hour for Case 8, and 30 to 60 miles per hour for Case 5.
- **Cases 13, 10, 7, and 4:** Case 13 is a high-speed (more than 120 miles per hour) impact into a hard surface such as granite severe enough to cause failure of cask seals. The impact would be followed by an engulfing fire lasting more than ½ hour up to a few hours. Case 10, Case 7, and Case 4 are accidents that would involve long duration fires, and failures of cask seals. However, these accidents are progressively less severe in terms of impact speeds ranging from 90 to 120 miles for Case 10, 60 to 90 miles per hour for Case 7, and 30 to 60 miles per hour for Case 4. An accident involving the impact of a jet engine from a passenger aircraft on a rail cask would be no more severe than a Case 4 accident (DIRS 157210-BSC 2001, all).
- **Cases 3, 2, and 1:** Case 3 is a high-speed (more than 120 miles per hour) impact into a hard surface such as granite severe enough to cause failure of cask seals—no fire. Case 2 and Case 1 are accidents that would also not involve fire but would have progressively lower impact speeds - 90 to 120 miles for Case 2 and 60 to 90 miles per hour for Case 1.

Truck Accident Descriptions

- **Case 18:** Case 18 is a long-duration (many hours), high-temperature fire that would engulf a cask. Conditions reported in the Baltimore Sun Times for the Baltimore Tunnel Fire (DIRS 156753-Ettlin 2001, all; DIRS 156754-Rascovar 2001, all), which occurred in July 2001—a fire of 820°C (1,500°F) that burned for up to 5 days—would be similar to the conditions for a Case 18 accident.
- **Cases 17, 16, 15, and 14:** Case 17 is a high-speed (more than 120 miles per hour) impact into a hard object such as a train locomotive severe enough to cause failure of cask seals and puncture through the cask's shield wall. The impact would be followed by a very long duration (many hours), high-temperature engulfing fire. Case 16, Case 15, and LST 14 are accidents that would also involve very long duration fires, failures of cask seals, and puncture of cask walls. However, these accidents would be progressively less severe in terms of impact speeds. The impact speeds range from 90 to 120 miles for Case 16, 60 to 90 miles per hour for Case 15, and 30 to 60 miles per hour for Case 14.
- **Cases 13, 10, 7, and 4:** Case 13 is a high-speed (more than 120 miles per hour) impact into a hard surface such as granite severe enough to cause failure of cask seals. The impact would be followed by a long duration (many hours), high-temperature engulfing fire. Case 10, Case 7, and Case 4 are also accidents that would involve long duration fires, and failures of cask seals. However, these accidents would be progressively less severe in terms of impact speeds ranging from 90 to 120 miles for Case 10, 60 to 90 miles per hour for Case 7, and 30 to 60 miles per hour for Case 4.
- **Cases 12, 9, 6, and 3:** Case 12 is a high-speed (more than 120 miles per hour) impact into a hard surface such as granite severe enough to cause failure of cask seals. The impact would be followed by a high-temperature engulfing fire that burned for hours. Case 9, Case 6, and Case 3 are also accidents that would involve fires that would burn for hours, and failures of cask seals. However, these accidents would be progressively less severe in terms of impact speeds ranging from 90 to 120 miles for Case 9, 60 to 90 miles per hour for Case 6, and 30 to 60 miles per hour for Case 3.
- **Cases 11, 8, 5, and 2:** Case 11 is a high-speed (more than 120 miles per hour) impact into a hard surface such as granite severe enough to cause failure of cask seals. The impact would be followed by an engulfing fire lasting more than ½ hour up to a few hours. Case 8, Case 5, and Case 2 are accidents that would involve long duration fires, and failures of cask seals. However, these accidents are progressively less severe in terms of impact speeds ranging from 90 to 120 miles for Case 8, 60 to 90 miles per hour for Case 5, and 30 to 60 miles per hour for Case 2. An accident involving the impact of a jet engine from a passenger aircraft on a truck cask would be no more severe than any Case 11 accident (DIRS 157210-BSC 2001, all).
- **Case 1:** Case 1 is a high-speed (more than 120 miles per hour) impact into a hard surface such as granite severe enough to cause failure of cask seals—no fire.

The analysis assumed maximum reasonably foreseeable accident scenarios could occur anywhere, either in rural or urbanized areas. The probability of such an accident would depend on the amount of exposure to the transportation accident environment. In this case, exposure would be the product of the cumulative shipment distance and the applicable accident rates. However, because of large differences in exposure, principally because of the large differences in the distances traveled in the two types of population areas, a severe accident scenario that might be reasonably foreseeable in a rural area might not be reasonably foreseeable in an urbanized area. Thus, a reasonably foreseeable accident postulated to occur in a rural area (most travel would occur in rural areas), under meteorological conditions that would be exceeded (resulting in greater consequences) only 5 percent of the time, might not be reasonably foreseeable in an urbanized area where shipments would travel relatively few kilometers. Table J-22 lists the probabilities and consequences of severe rail cask accidents during national transportation based on the analysis of releases from spent fuel casks presented in DIRS 152476-Sprung et al. (2000, pp. 7-75 to 7-76) for urban

Table J-22. Frequency and consequence of rail accidents.^a

Rail cask					
Case	Expected frequency	Total exposure (person-rem)	Case	Expected frequency	Total exposure (person-rem)
Urban Area - Stability Class F			Rural Area - Stability Class F		
19	7.67×10^{-19}	254,377	19	4.71×10^{-18}	419
15	7.67×10^{-16}	254,377	15	4.71×10^{-15}	419
14	5.77×10^{-15}	242,817	14	3.54×10^{-14}	400
13	2.07×10^{-13}	230,214	13	1.27×10^{-12}	379
16	2.32×10^{-12}	220,788	16	1.43×10^{-11}	364
3	2.51×10^{-11}	219,698	3	1.54×10^{-10}	361
18	9.74×10^{-17}	173,447	18	5.99×10^{-16}	285
12	9.74×10^{-14}	173,447	12	5.99×10^{-13}	285
11	7.34×10^{-13}	171,358	11	4.51×10^{-12}	282
6	6.16×10^{-10}	159,807	6	3.78×10^{-9}	264
10	2.62×10^{-11}	149,279	10	1.61×10^{-10}	246
2	3.18×10^{-9}	149,266	2	1.95×10^{-8}	245
17	1.41×10^{-15}	112,468	17	8.63×10^{-15}	185
9	1.41×10^{-12}	81,049	9	8.63×10^{-12}	134
20	2.75×10^{-7}	9,893	20	1.69×10^{-6}	16.3
8	1.05×10^{-11}	3,416	8	6.47×10^{-11}	5.63
7	3.79×10^{-10}	3,060	7	2.33×10^{-9}	5.04
1	4.59×10^{-8}	2,933	1	2.82×10^{-7}	4.83
5	4.61×10^{-9}	1,745	5	2.83×10^{-8}	2.88
4	1.66×10^{-7}	1,346	4	1.02×10^{-6}	2.22

a. Source: DIRS 152476-Sprung et al. (2000, p. 7-75).

area and rural area population and stability class F weather conditions. Stability class D consequences were analyzed but, because the consequences are smaller than those of class F stability conditions, they are not presented. Similarly, Table J-23 lists the probabilities and consequences of severe truck accidents for stability class F conditions.

For the mostly rail scenario, legal-weight truck accidents would not be reasonably foreseeable. For rail accidents, the severity case, which is reasonably foreseeable and would have the greatest consequences, is Case 20 with an expected frequency of 2.8×10^{-7} and consequences of 9,900 person-rem.

For the mostly legal-weight truck scenario, in which only naval spent nuclear fuel would be shipped by rail, the likelihood would be less than 1×10^{-7} per year for the most severe rail accident to occur in an urbanized area. Thus, the highest severity rail accidents would only be reasonably foreseeable in rural areas under average (50-percent) meteorological conditions (probability greater than 1 in 10 million per year). For truck accidents in urban areas, the severity case, which is reasonably foreseeable and has the greatest consequences, is Case 18 with an expected frequency of 2.3×10^{-7} and consequences of 1,100 person-rem.

The analysis of maximum reasonably foreseeable accidents evaluated all the accidents for steel-depleted uranium-steel truck and steel-lead-steel rail casks from DIRS 152476-Sprung et al. (2000, pp. 7-73 and 7-76). However, only accidents from Tables J-22 and J-23 that have an expected frequency greater than 1×10^{-7} would be reasonably foreseeable.

Table J-24 summarizes the accidents with the greatest consequences that would be reasonably foreseeable. Although stability class D accidents are reasonably foreseeable, the consequences from stability class F accidents would be greater as listed in Table J-24.

Table J-23. Frequency and consequence of truck accidents.^a

Truck cask					
Case	Expected frequency	Total exposure (person-rem)	Case	Expected frequency	Total exposure (person-rem)
Urban Area - Stability Class F			Rural Area - Stability Class F		
14	2.8×10^{-12}	36,798	14	1.6×10^{-11}	60.7
15	1.3×10^{-16}	18,919	15	7.6×10^{-16}	31.1
4	2.8×10^{-9}	8,484	4	1.6×10^{-8}	14
7	1.3×10^{-13}	5,203	7	7.6×10^{-13}	8.57
12	9.8×10^{-16}	1,251	12	5.5×10^{-15}	2.07
9	7.7×10^{-14}	1,251	9	4.4×10^{-13}	2.07
11	6.0×10^{-12}	1,146	11	3.4×10^{-11}	1.88
8	4.7×10^{-10}	1,146	8	2.7×10^{-9}	1.88
1	6.2×10^{-10}	1,125	1	3.5×10^{-9}	1.85
18	2.3×10^{-7}	1,083	18	1.3×10^{-6}	1.79
6	3.7×10^{-12}	723	6	2.1×10^{-11}	1.19
5	2.0×10^{-8}	581	5	1.1×10^{-7}	0.92
3	1.1×10^{-8}	291	3	6.4×10^{-8}	0.48
2	2.5×10^{-6}	225	2	1.4×10^{-5}	0.37
17	0	N/A ^b	17	0	N/A ^b
16	0	N/A	16	0	N/A
13	0	N/A	13	0	N/A
10	0	N/A	10	0	N/A

a. Source: DIRS 152476-Sprung et al. (2000, p. 7-74).

b. N/A = not applicable, because probability is zero.

Table J-24. Consequences (person-rem) of maximum reasonably foreseeable accidents in national transportation.^a

Case	Urban (person-rem)	Rural (person-rem)	MEI (rem) ^b
Rail (Case 20)	9,893	16	29
Truck (Case 18)	1,083	2	3

a. All accidents are modeled in with stability class F conditions.

b. MEI = maximally exposed individual.

The analysis of consequences of maximum reasonably foreseeable accidents used data from the 1990 census escalated to 2035 to estimate the size of populations in urbanized areas that could receive exposures to radioactive materials. The analysis used estimated populations in successive 8-kilometer (5-mile)-wide annular rings around the centers of the 21 large urbanized areas (cities and metropolitan areas) in the continental United States (DIRS 104800-CRWMS M&O 1999, p. 22).

The average population for each ring was used to form a population distribution for use in the analysis. To be conservative in estimating consequences, the analysis assumed that accidents in urbanized areas would occur at the center of the population zone, where the population density would be greatest. This assumption resulted in conservative estimates of collective dose to exposed populations.

J.1.4.2.2 *Methods and Approach for Analysis of Nonradiological Impacts of Transportation Accidents*

Nonradiological accident risks are risks of traffic fatalities. Traffic fatality rates are reported by state and Federal transportation departments as fatalities per highway vehicle- or train-kilometer traveled. The fatalities are caused by physical trauma in accidents. For nonradiological accident risks estimated in this

EIS for legal-weight truck transportation, accident fatality risks were based on state-level fatality rates for Interstate Highways (DIRS 103455-Saricks and Tompkins 1999, all). Accident fatality risks for rail transportation were also calculated using state-specific rates (DIRS 103455-Saricks and Tompkins 1999, all). Section J.2.2 discusses methods and data used to analyze accidents for barge transportation.

For truck transportation, the rates in DIRS 103455-Saricks and Tompkins (1999, Table 4) are specifically for heavy combination trucks involved in interstate commerce. Heavy combination trucks are multi-axle tractor-trailer trucks having a tractor and one to three freight trailers connected to each other. This kind of truck with a single trailer would be used to ship spent nuclear fuel and high-level radioactive waste. Truck accident rates were determined for each state based on statistics compiled by the U.S. Department of Transportation Office of Motor Carriers for 1994 through 1996. The report presents accident involvement and fatality counts, estimated kilometers of travel by state, and the corresponding average accident involvement, fatality, and injury rates for the 3 years investigated. Fatalities include crew members and all others attributed to accidents. Although escort vehicles would not be heavy combination trucks, the fatality rate data used for truck shipments of loaded and empty spent fuel casks were also used to estimate fatalities from accidents that would involve escort vehicles.

Rail accident rates were computed and presented similarly to truck accident rates, but a railcar is the unit of haulage. The state-specific rail accident involvement and fatality rates are based on statistics compiled by the Federal Railroad Administration for 1994 through 1996. Rail accident rates include both mainline accidents and those occurring in railyards. The per-railcar rate in DIRS 103455-Saricks and Tompkins (1999, Table 6) was multiplied by 4.2, the average number of railcars involved in an accident.

The accident rates used to estimate traffic fatalities were computed using data for all interstate shipments, independent of the cargoes. Shippers and carriers of radioactive material generally have a higher-than-average awareness of transport risk and prepare cargoes and drivers accordingly (DIRS 101920-Saricks and Kvittek 1994, all). These effects were not given credit in the assessment.

J.1.4.2.3 Data Used To Estimate Incident Rates for Rail and Motor Carrier Accidents

In analyzing potential impacts of transporting spent nuclear fuel and high-level radioactive waste, DOE considered both incident-free transportation and transportation accidents. Potential incident-free transportation impacts would include those caused by exposing the public and workers to low levels of radiation and other hazards associated with the normal movement of spent nuclear fuel and high-level radioactive waste by truck, rail, or barge. Impacts from accidents would be those that could result from exposing the public and workers to radiation, as well as vehicle-related fatalities.

In its analysis of impacts from transportation accidents, DOE relied on data collected by the U.S. Department of Transportation and others (for example, the American Petroleum Institute) to develop estimates of accident likelihood and their ranges of severity (DIRS 101828-Fischer et al. 1987, pp. 7-25 and 7-26). Using these data, the analysis estimated that as many as 66 accidents could occur over 24 years in the course of shipping spent nuclear fuel to the repository by legal-weight trucks; 8 rail accidents that involved a railcar carrying a cask could occur if most shipments were by rail; and no accidents would be likely for the limited use of barges.

Furthermore, in using data collected by the U.S. Department of Transportation, the analysis considered the range of accidents, from slightly more than “fender benders” to high-speed crashes, that the DOE carrier would have to report in accordance with the requirements of U.S. Department of Transportation regulations. The accidents that could occur would be unlikely to be severe enough to affect the integrity of the shipping casks.

The following paragraphs discuss reporting and definitions for transportation accidents and the relationships of these to data used in analyzing transportation impacts in this EIS.

J.1.4.2.3.1 Transportation Accident Reporting and Definitions. In the United States, the reporting of transportation accidents and incidents involving trucks, railroads, and barges follows requirements specified in various Federal and state regulations.

Motor Carrier Accident Reporting and Definitions

Regulations generally require the reporting of motor carrier accidents (regardless of the cargo being carried) if there are injuries, fatalities, or property damage. These regulations have evolved through the years, mostly in response to increasing values of transportation equipment and commodities. For example, the Federal requirements in the following text box establish a functional threshold for damage to vehicles rather than a value-of-damage threshold, which was used until the 1980s. Nonetheless, many states continue to use value thresholds (for example, Ohio uses \$500) for vehicle damage when documenting reportable accidents.

Until March 4, 1993, Federal regulations (49 CFR Part 394) required motor carriers to submit accident reports to the Federal Highway Administration Motor Carrier Management Information System using the so-called “50-T” reporting format. The master file compiled from the data on these reports in the Federal Highway Administration Office of Motor Carriers was the basis of accident, fatality, and injury rates developed for the 1994 study of transportation accident rates (DIRS 101920-Saricks and Kvittek 1994, all).

The Final Rule (58 FR 6726; February 2, 1993) modified the carrier reporting requirement; rather than submitting reports, carriers now must maintain a register of accidents that meet the definition of an accident for 1 year after such an accident occurs. Carriers must make the contents of such a register available to Federal Highway Administration agents investigating specific accidents. They must also give “...all reasonable assistance in the investigation of any accident including providing a full, true, and correct answer to any question of inquiry” to determine if hazardous materials other than spilled fuel from the fuel tanks were released, and to furnish copies of all state-required accident reports (49 CFR 390.15). The reason for this rule change was the emergence of an automated State accident reporting system compiled from law enforcement accident reports that, pursuant to provisions of the Intermodal Surface Transportation Efficiency Act of 1991 (Public Law 102-240, 105 Stat. 1914), was established under the Motor Carrier Safety Assistance Program.

Under Section 408 of Title IV of the Motor Carrier Act of 1991 (Public Law 102-240, 105 Stat. 2140), a component of the Intermodal Surface Transportation Efficiency Act, the Secretary of Transportation is authorized to make grants to states to help them achieve uniform implementation of the police reporting system for truck and bus accidents recommended by the National Governors Association. Under this system, called SAFETYNET, accident data records generated by each state follow identical formatting and content instructions. They are entered in a Federally maintained SAFETYNET database on approximately a weekly basis. The SAFETYNET database, in turn, is compiled and managed as part of the Motor Carrier Management Information System.

Because DIRS 152476-Sprung et al. (2000, all) is the fundamental source for data that describes the severity of transportation accidents used in this EIS, the relative constancy of the definition of *accident* is important in establishing confidence in estimated impact results. Thus, although the transportation environment has changed over the 40 years of data collection, the constancy of the definition of *accident* tends to provide confidence that the distribution of severity for reported accidents has remained relatively the same. That is, low-consequence, fender-bender accidents are the most common, high-consequence, highly energetic accidents are rare, and the proportions of these have remained roughly the same.

**COMMERCIAL MOTOR VEHICLE ACCIDENT
(49 CFR 390.5)**

An occurrence involving a commercial motor vehicle operating on a public road in interstate or intrastate commerce that results in:

- A fatality
- Bodily injury to a person who, as a result of the injury, immediately receives medical treatment away from the scene of the accident
- One or more motor vehicles incurring disabling damage as a result of the accident, requiring the motor vehicle to be transported away from the scene by a tow truck or other motor vehicle

The term accident does not include:

- An occurrence involving only boarding and alighting from a stationary motor vehicle
- An occurrence involving only the loading or unloading of cargo
- An occurrence in the course of the operation of a passenger car or a multipurpose passenger vehicle by a motor carrier and is not transporting passengers for hire or hazardous materials of a type and quantity that require the motor vehicle to be marked or placarded in accordance with 49 CFR 177, Subpart 823

Changes in the transportation environment, such as changes in speed limits and safety technology, tend to change the accident rate (accidents per vehicle-kilometer of travel). Overall, however, given that the definition of *accident* does not change, such changes do not greatly affect the distribution of accident severities. For example, recent increases in speed limits from 105 to 121 kilometers (65 to 75 miles) per hour represent about a 25-percent increase in the maximum mechanical energy of vehicles. Other information aside, this increase could lead to the conclusion that the resulting distribution of accidents would show an increase for the most severe accidents in comparison to minor accidents. However, the speed limit increases do not represent a corresponding increase in actual traffic speeds, and would be unlikely to change the distribution of velocities and, thus, mechanical energies, of severe accidents from those reported in DIRS 152476-Sprung et al. (2000, all), which ranged to faster than 193 kilometers (120 miles) per hour.

Rail Carrier Accident Reporting and Definitions

As with regulations governing the reporting of motor carrier accidents, Federal Railroad Administration regulations generally require the reporting of accidents if there are injuries, fatalities, or property damage. These regulations have evolved through the years, mostly in response to increasing values of transportation equipment and commodities. For example, the Federal requirements in the following text box establish a value-based reporting threshold for damage to vehicles; the value has been indexed to inflation since 1975.

Rail carriers covered by these requirements must fulfill several bookkeeping tasks. The Federal Railroad Administration requires the submittal of a monthly status report, even if there were no reportable events during the period. This report must include accidents and incidents, and certain types of incidents require immediate telephone notification. Logs of reportable injuries and on-track incidents must be maintained by the railroads on which they occur, and a listing of such events must be posted and made available to employees and to the Federal Railroad Administration, along with required records and reports, on request. The data entries extracted from the reporting format are consolidated into an accident/incident database that separates reportable *accidents* from grade-crossing *incidents*. These are processed annually into event, fatality, and injury count tables in the Federal Railroad Administration's *Accident/Incident Bulletin* (DIRS 103455-Saricks and Tompkins 1999, all), which the Office of Safety publishes on the Internet (safetydata.fra.dot.gov/officeofsafety).

**RAILROAD ACCIDENT/INCIDENT
(49 CFR 225.11)**

- An impact between railroad on-track equipment and an automobile, bus, truck, motorcycle, bicycle, farm vehicle or pedestrian at a highway-rail grade crossing
- A collision, derailment, fire, explosion, act of God, or other event involving operation of railroad on-track equipment (standing or moving) that results in reportable damages greater than the current reporting threshold to railroad on-track equipment, signals, track, track structures, and roadbed
- An event arising from the operation of a railroad which results in:
 - Death to any person
 - Injury to any person that requires medical treatment
 - Injury to a railroad employee that results in:
 - A day away from work
 - Restricted work activity or job transfer
 - Loss of consciousness
 - Occupational illness

In contrast to the regulations for motor carriers discussed above, the Federal Railroad Administration regulations cited above call for the reporting of accidents and incidents. The Administration defines an *accident* as “an event involving on-track railroad equipment that results in damage to the railroad on-track equipment, signals, track, or track structure, and roadbed at or exceeding the dollar damage threshold” (49 CFR 225.11). Train *incidents* are defined as “events involving on-track railroad equipment [and non-train incidents arising from the operation of a railroad] that result in the reportable death and/or injury or illness of one or more persons, but do not result in damage at or beyond the damage threshold” (49 CFR 225.11). Because damage to casks containing spent nuclear fuel will necessarily involve severe accidents (hence, substantial damage), DIRS 152476-Sprung et al. (2000, all) used only train accidents to form the basis for developing the conditional probabilities of accident severities.

As with motor carrier operations, the constancy of the definition of a train accident is important in establishing confidence in the impact. For rail accidents the transportation environment has not changed dramatically over the years of data collection, and the definition of *accident* has remained essentially unchanged (with adjustments for inflation). The constancy of the definition provides confidence that the distribution of severity for reported accidents has remained relatively the same—low-consequence, limited-damage accidents are the most common and high-consequence, highly energetic accidents are rare, and their proportions have remained about the same. Changes in the rail transportation environment, as in safety and operations technology (for example, shelf-type couplers and tankcar head protection), have resulted in lower accident rates (per railcar-kilometer of travel) and, in some cases, less severe accidents. However, because the definition of *accident* has not changed appreciably, the changes that have occurred are not the kind that would greatly affect the relative proportions of minor and severe accidents.

Reporting and Definitions for Marine Casualties and Incidents

As with the regulations governing the reporting of motor carrier and rail accidents, U.S. law (46 U.S.C. 6101 to 6103) requires operators to report marine casualties and incidents if there are injuries, fatalities, or property damage. In addition, the law requires the reporting of significant harm to the environment.

**MARINE CASUALTY AND INCIDENT
(46 U.S.C. 6101 to 6103)**

Criteria have been established for the required reporting (by vessel operators and owners) of marine casualties and incidents involving all United States flag vessels occurring anywhere in the world and any foreign flag vessel operating on waters subject to the jurisdiction of the United States. An incident must be reported within five days if it results in:

- The death of an individual
- Serious injury to an individual
- “Material” loss of property (threshold not specified; previously was \$25,000)
- Material damage affecting the seaworthiness or efficiency of the vessel
- Significant harm to the environment

The states collect casualty data for incidents occurring in navigable waterways within their borders, and there is a uniform state marine casualty reporting system for transmitting these reports to Federal jurisdiction (the U.S. Coast Guard). Coast Guard Headquarters receives quarterly extracts of the Marine Safety Information System developed from these sources. This system is a network database into which Coast Guard investigators enter cases at each marine safety unit. The analysis uses a Relational Database Management System. The Coast Guard Office of Investigations and Analysis compiles and processes the casualty reports into the formats and partitioned data sets that comprise the Marine Safety Information System database, which includes maritime accidents, fatalities, injuries, and pollution spills dating to 1941 (however, the file is complete only from about 1991 to the present).

Hazardous Material Transportation Accident and Incident Reporting and Definitions

Radioactive material is a subset of the more general term *hazardous material*, which includes commodities such as gasoline and chemical products. The U.S. Department of Transportation Office of Hazardous Materials estimates that there are more than 800,000 hazardous materials shipments per day, of which about 7,700 shipments contain radioactive materials.

Hazardous materials transportation regulations (49 CFR 171) contain no distinction between an *accident* and an *incident*, and *incident* is the term used to describe situations that must be reported. Hazardous materials regulations (49 CFR 171.15) require the reporting of incidents if:

- A person is killed
- A person receives injuries requiring hospitalization
- The estimated property damage is greater than \$50,000
- An evacuation of the public occurs lasting one or more hours
- One or more major transportation arteries are closed or shutdown for one or more hours
- The operational flight pattern or routine of an aircraft is altered
- Fire, breakage, spillage, or suspected radioactive contamination occurs involving shipment of radioactive material
- Fire, breakage, spillage, or suspected contamination occurs involving shipment of infectious agents

- There has been a release of a marine pollutant in a quantity exceeding 450 liters (about 120 gallons) for liquids or 400 kilograms (about 880 pounds) for solids
- There is a situation that, in the judgement of the carrier, should be reported to the U.S. Department of Transportation even though it does not meet the above criteria

These criteria apply to loading, unloading, and temporary storage, as well as to transportation. The criteria involving infectious agents or aircraft are unlikely to be used for spent nuclear fuel or high-level radioactive waste shipments. Based on these criteria, reportable motor vehicle and rail transportation situations are far more exclusionary than hazardous material situations.

Carriers (not law enforcement officials) are required to report hazardous materials incidents to the U.S. Department of Transportation. These reports are compiled in the Hazardous Materials Incident Report database. In addition, U.S. Nuclear Regulatory Commission regulations (10 CFR 20.2201, 20.2202, 20.2203) require the reporting of a loss of radioactive materials, exposure to radiation, or release of radioactive materials.

Sandia National Laboratories maintains the Radioactive Materials Incident Report database, which contains incident reports from the Hazardous Materials Incident Report database that involve radioactive material. In addition, the Radioactive Materials Incident Report database contains data from the U.S. Nuclear Regulatory Commission, state radiation control offices, the DOE Unusual Occurrence Report database, and media coverage of radioactive materials transportation incidents. DIRS 101802-DOE (1995, Volume 1, Appendix I, pp. I-117) and DIRS 102172-McClure and Fagan (1998, all) discuss historic incidents involving spent nuclear fuel that are reported in the Radioactive Materials Incident Report database as well as incidents that took place prior to the existence of this database. The database characterizes incidents in three categories: transportation accidents, handling accidents, and reported incidents. However, the definitions of these categories are not consistent with the definitions used in other U.S. Department of Transportation databases. For example, from 1971 through 1998, the Radioactive Materials Incident Report database lists one transportation accident involving a loaded rail shipment of spent nuclear fuel. However, based on current Federal Railroad Administration reporting requirements, this occurrence probably would be listed as a grade-crossing incident, not an accident. For this reason and because of the small number of occurrences in the database involving spent nuclear fuel, the EIS analysis did not use the Radioactive Materials Incident Report database to estimate transportation accident rates.

J.1.4.2.3.2 Accident Rates for Transportation by Heavy-Combination Truck, Railcar, and Barge in the United States. DIRS 103455-Saricks and Tompkins (1999, all) developed estimates of accident rates for heavy-combination trucks, railcars, and barges based on data available for 1994 through 1996. The estimates provide an update for accident rates published in 1994 (DIRS 101920-Saricks and Kvitek 1994, all) that reflected rates from almost a decade earlier.

Rates for Accidents in Interstate Commerce for Heavy-Combination Trucks

DIRS 103455-Saricks and Tompkins (1999, all) developed basic descriptive statistics for state-specific rates of accidents involving interstate-registered combination trucks for 1994, 1995, and 1996. The accident rate over all road types for 1994 was 2.98×10^{-7} accident per truck-kilometer (DIRS 103455-Saricks and Tompkins 1999, Table 3a); for 1995 it was 2.97×10^{-7} accident per truck-kilometer (DIRS 103455-Saricks and Tompkins 1999, Table 3b); and for 1996 it was 3.46×10^{-7} accident per truck-kilometer (DIRS 103455-Saricks and Tompkins 1999, Table 3c). The composite mean from 1994 through 1996 was 3.21×10^{-7} accident per truck-kilometer.

During the 24 years of the Proposed Action, the *mostly legal-weight truck* national transportation scenario would involve about 53,000 truck shipments of spent nuclear fuel and high-level radioactive waste.

Based on the data in DIRS 103455-Saricks and Tompkins (1999, Table 4), the transportation analysis estimated that those shipments could involve as many as 66 accidents. During the same period, the *mostly rail* scenario would involve about 1,100 truck shipments, and the analysis estimated that as many as one truck accident could occur during these shipments. More than 99.99 percent of these accidents would not generate forces capable of causing functional damage to the casks, and would have no radiological consequences. A small fraction of the accidents could generate forces capable of damaging the cask.

Rates for Freight Railcar Accidents

Results for accident rates for freight railcar shipments from DIRS 103455-Saricks and Tompkins (1999, all), show that domestic rail freight accidents, fatalities, and injuries on Class 1 and 2 railroads have remained stable or declined slightly since the late 1980s. Based on data from 1994 through 1996, these rates are 5.39×10^{-8} , 8.64×10^{-8} , and 1.05×10^{-8} per railcar-kilometer, respectively (DIRS 103455-Saricks and Tompkins 1999, Table 6). This conclusion is based on applying denominators that do *not* include train and car kilometers for intermodal shipments (containers and trailers-on-flatcar) not loaded by the carriers themselves. Thus, the actual denominators are probably higher and the rates consequently lower, by about 20 percent.

During the 24 years of the Proposed Action, the *mostly rail* national transportation scenario would involve as many as 10,000 rail shipments of spent nuclear fuel and high-level radioactive waste. Based on the data in DIRS 103455-Saricks and Tompkins (1999, Table 6), the analysis estimated that these shipments could involve eight accidents. More than 99.99 percent of these accidents would not generate forces capable of causing functional damage to the cask; these accidents would have no radiological consequences. A small fraction of the accidents could generate forces capable of damaging the cask. For the *mostly legal-weight truck* scenario, rail accidents would be unlikely during the 300 railcar shipments of naval spent nuclear fuel.

Rates for Barge Accidents

Waterway results show a general improvement over mid-1980s rates. The respective rates for 450-metric-ton (500-ton) shipments for waters internal to the coast (rivers, lakes, canals, etc.) for accident and incident involvements and fatalities were 1.68×10^{-6} and 8.76×10^{-9} per shipment-kilometer, respectively (DIRS 103455-Saricks and Tompkins 1999, Table 8b). Rates for lake shipping were lower— 2.58×10^{-7} and 0 per shipment-kilometer, for accidents and incidents and for fatalities, respectively. Coastal casualty involvement rates have risen in comparison to the data recorded about 10 years ago, and are comparable to rates for internal waters— 5.29×10^{-7} and 8.76×10^{-9} per shipment-kilometer (DIRS 103455-Saricks and Tompkins 1999, Table 9b).

During the 24 years of the Proposed Action, the *mostly rail* national transportation scenario could involve the use of barges to ship spent nuclear fuel from 17 commercial sites. Based on the data in DIRS 103455-Saricks and Tompkins (1999, all), the analysis estimated that less than one accident could occur during such shipments. A barge accident severe enough to cause measurable damage to a shipping cask would be highly unlikely.

Rates for Safe Secure Trailer Accidents

DOE uses safe secure trailers to transport hazardous cargoes in the continental United States. The criteria used for reporting accidents involving these trailers are damage in excess of \$500, a fire, a fatality, or damage sufficient for the trailer to be towed. From 1975 through 1998, 14 accidents involved safe secure trailers over about 54 million kilometers (about 34 million miles) of travel, which yields a rate of 2.6×10^{-7} accident per kilometer (4.2×10^{-7} per mile). This rate is comparable to the rate estimated by DIRS 103455-Saricks and Tompkins (1999, Table 4) for heavy combination trucks, 3.2×10^{-7} accident per kilometer (5.1×10^{-7} per mile).

J.1.4.2.3.3 Accident Data Provided by the States of Nevada, California, South Carolina, Illinois, and Nebraska. In May 1998, DOE requested the 48 contiguous states to provide truck and rail transportation accident data for use in this EIS. Five states responded – Nevada, California, Illinois, Nebraska, and South Carolina (DIRS 104728-Denison 1998, all; DIRS 103709-Caltrans 1997, all; DIRS 104801-Wort 1998, all; DIRS 104783-Kohles 1998, all; DIRS 103725-SCDPS 1997, all). No states provided rail information.

- **Nevada.** Nevada provided a highway accident rate of 1.1×10^{-6} accident per kilometer (1.8×10^{-6} per mile) for interstate carriers over all road types. This is higher than the accident rate estimated by DIRS 103455-Saricks and Tompkins (1999, Table 4); 2.5×10^{-7} accident per kilometer (3.9×10^{-7} per mile) for heavy trucks over all road types in Nevada from 1994 to 1996.

The definition of *accident* used in DIRS 103455-Saricks and Tompkins (1999, p. 4) is the Federal definition (fatality, injury, or tow-away); in Nevada the accident criteria are fatality, injury, or \$750 property damage. Based on national data from the U.S. Department of Transportation Office of Motor Carrier Information Analysis (DIRS 103721-FHWA 1997, p. 2; DIRS 102231-FHWA 1998, pp. 1 and 2), using the Federal definition would reduce the accident rate from 1.1×10^{-6} to about 4.1×10^{-7} accident per kilometer (1.8×10^{-6} to 6.7×10^{-7} per mile). The radiological accident risk in Nevada for the mostly legal-weight truck scenario would increase over 24 years from 0.0002 latent cancer fatality to about 0.0005 latent cancer fatality (a likelihood of 5 in 10,000 of one latent cancer fatality) if the accident rate reported by DIRS 103455-Saricks and Tompkins (1999, p. 33) for Nevada were replaced by the rate of 4.1×10^{-7} per kilometer. Thus, the impacts of the rate for accidents involving large trucks on Nevada highways reported by Nevada (DIRS 104728-Denison 1998, all) would be comparable to the impacts derived using the rate estimated by DIRS 103455-Saricks and Tompkins (1999, p. 33).

- **California.** California responded with highway accident rates that included all vehicles (cars, buses, and trucks). The accident rate for Interstate highways was 4.2×10^{-7} accident per kilometer (6.8×10^{-7} per mile) for all vehicles in 1996. This rate is higher than the accident rate estimated by DIRS 103455-Saricks and Tompkins (1999, Table 4), 1.6×10^{-7} accident per kilometer (2.6×10^{-7} per mile) for heavy trucks on California interstate highways from 1994 to 1996.

The definition of *accident* in DIRS 103455-Saricks and Tompkins (1999, p. 4) is the Federal definition (fatality, injury, or tow-away); in California the accident criteria are fatality, injury, or \$500 property damage. Based on national data from DIRS 103721-FHWA (1997, p. 2) and DIRS 102231-FHWA (1998, pp. 1 and 2), using the Federal definition would reduce the accident rate from 4.2×10^{-7} to about 1.6×10^{-7} accident per kilometer (6.8×10^{-7} to 2.6×10^{-7} per mile). In addition, the rate provided by California was for all vehicles. Based on national data from the U.S. Department of Transportation Bureau of Transportation Statistics, using the accident rate for large trucks would reduce the all-vehicle accident rate from 1.6×10^{-7} to about 1.3×10^{-7} accident per kilometer (2.6×10^{-7} to 2.1×10^{-7} per mile) for large trucks. This rate is slightly less than the rate estimated by DIRS 103455-Saricks and Tompkins (1999, Table 4), 1.6×10^{-7} accident per kilometer.

- **Illinois.** Illinois provided highway data for semi-trucks from 1991 through 1995 over all road types. Over this period, the accident rate was 1.8×10^{-6} accident per kilometer (2.9×10^{-6} per mile). From 1994 through 1996, DIRS 103455-Saricks and Tompkins (1999, all) estimated an accident rate of 3.0×10^{-7} accident per kilometer (4.8×10^{-7} per mile) for heavy trucks over all road types in Illinois.

The definition of *accident* used in DIRS 103455-Saricks and Tompkins (1999, p. 4) is the Federal definition (fatality, injury, or tow-away); in Illinois the accident criteria are fatality, injury, or \$500 property damage. Based on national data from the U.S. Department of Transportation Office of Motor Carrier Information Analysis (DIRS 103721-FHWA 1997, p. 2; DIRS 102231-FHWA 1998,

pp. 1 and 2), using the Federal definition would reduce the accident rate from 1.8×10^{-6} to about 6.7×10^{-7} accident per kilometer (2.9×10^{-6} to 1.1×10^{-6} per mile). This rate is comparable to the rate estimated by DIRS 103455-Saricks and Tompkins (1999, all).

- **Nebraska.** Nebraska provided a highway accident rate of 2.4×10^{-7} accident per kilometer (3.8×10^{-7} per mile) for 1997. Nebraska did not specify if the rate was for interstate highways, but it is for interstate truck carriers. This rate is slightly less than the accident rate estimated by DIRS 103455-Saricks and Tompkins (1999, all) for Nebraska interstates, 3.2×10^{-7} accident per kilometer (5.1×10^{-7} per mile) for heavy trucks from 1994 through 1996.
- **South Carolina.** South Carolina responded with highway accident rates that included all types of tractor/trailers (for example, mobile homes, semi-trailers, utility trailers, farm trailers, trailers with boats, camper trailers, towed motor homes, petroleum tankers, lowboy trailers, auto carrier trailers, flatbed trailers, and twin trailers). The rate was 8.3×10^{-7} accident per kilometer (1.3×10^{-6} per mile), for all road types. [This is higher than the accident rate estimated by DIRS 103455-Saricks and Tompkins (1999, all), 4.7×10^{-7} accident per kilometer (7.6×10^{-7} per mile) for heavy trucks on all road types in South Carolina from 1994 through 1996].

The definition of *accident* in DIRS 103455-Saricks and Tompkins (1999, p. 4) is the Federal definition (fatality, injury, or tow-away); in South Carolina the accident criteria are fatality, injury, or \$1,000 property damage. Based on national data from the U.S. Department of Transportation Office of Motor Carrier Information Analysis (DIRS 103721-FHWA 1997, p. 2; DIRS 102231-FHWA 1998, pp. 1 and 2), using the Federal definition of an accident would reduce the accident rate from 8.3×10^{-7} to about 3.1×10^{-7} accident per kilometer (1.3×10^{-6} to 5.0×10^{-7} per mile), which is slightly less than the rate estimated by DIRS 103455-Saricks and Tompkins (1999, all), 4.7×10^{-7} accident per kilometer (7.6×10^{-7} per mile). In addition, the accident rate estimated by DIRS 103455-Saricks and Tompkins (1999, all) was based on Motor Carrier Management Information System vehicle configuration codes 4 through 8 (truck/trailer, bobtail, tractor/semi-trailer, tractor/double, and tractor/triple), while the rate obtained from South Carolina included all truck/trailer combinations. Including all of the combinations tends to increase accident rates; for example, light trucks have higher accident rates than heavy trucks (DIRS 148081-BTS 1999, Table 3-22).

DOE evaluated the effect of using the data provided by the five states on radiological accident risk for the mostly legal-weight truck national transportation scenario. If the data used in the analysis for the five states (DIRS 103455-Saricks and Tompkins 1999, Table 4) were replaced by the data provided by the states with the adjustments discussed, the change in the resulting estimate of radiological accident risk would be small, increasing from 0.067 to 0.071 latent cancer fatality. Using the unadjusted data provided by those states would result in an increase in accident risk from 0.067 to 0.093 latent cancer fatality.

J.1.4.2.4 Transportation Accidents Involving Nonradioactive Hazardous Materials

The analysis of impacts of transportation accidents involving the transport of nonradioactive hazardous materials to and from Yucca Mountain used information presented in two U.S. Department of Transportation reports (DIRS 103718-DOT 1998, Table 1; DIRS 103708-BTS 1996, p. 43) on the annual number of hazardous materials shipments in the United States and the number of deaths caused by hazardous cargoes in 1995. In total, there are about 300 million annual shipments of hazardous materials; only a small fraction involve radioactive materials. In 1995, 6 fatalities occurred because of hazardous cargoes. These data suggest a rate of 2 fatalities per 100 million shipments of hazardous materials. DOE anticipates about 40,000 shipments of nonradioactive hazardous materials (including diesel fuel and laboratory and industrial chemicals) to and from the Yucca Mountain site during construction, operation and monitoring, and closure of the repository. Assuming that the rate for fatalities applies to the

transportation of nonradioactive hazardous materials to and from Yucca Mountain, DOE does not expect fatalities from 40,000 shipments of these materials.

J.1.4.2.5 Cost of Cleanup and Ecological Restoration Following a Transportation Accident

Cost of Cleanup. According to the Nuclear Regulatory Commission report *Reexamination of Spent Fuel Shipment Risk Estimates* (DIRS 152476-Sprung et al. 2000, pp. 7-73 to 7-76), in more than 99.99 percent of accidents radioactive material would not be released from the cask. After initial safety precautions had been taken, the cask would be recovered and removed from the accident scene. Because no radioactive material would be released, based on reported experience with two previous accidents (DIRS 156110-FEMA 2000, Appendix G, Case 4 and Case 5), the economic costs of these accidents would be minimal.

For the 0.01 percent of accidents severe enough to cause a release of radioactive material from a cask, a number of interrelated factors would affect costs of cleaning up resulting radioactive contamination after the accident. Included are: the severity of the accident and the initial level of contamination; the weather at the time and following; the location and size of the affected land area and how the land is used; the standard established for the allowable level of residual contamination following cleanup and the decontamination method used; and the technical requirements for and location for disposal of contaminated materials.

Because it would be necessary to specify each of the factors to estimate clean up costs, any estimate for a single accident would be highly uncertain and speculative. Nonetheless, to provide a gauge of the costs that could be incurred DOE examined past studies of costs of cleanup following hypothetical accidents that would involve uncontrolled releases of radioactive materials.

A study of the impacts of transporting radioactive materials conducted by the Nuclear Regulatory Commission in 1977 estimated that costs could range from about \$1 million to \$100 million for a transportation accident that involved a 600-curie release of a long-lived radionuclide (DIRS 101892-NRC 1977, Table 5-11). These estimates would be about 3 times higher if escalated for inflation from 1977 to the present. In 1980 DIRS 155054-Finley et al. (1980, Table 6-9) estimated that costs could range from about \$90 million to \$2 billion for a severe spent nuclear fuel transportation accident in an urban area. DIRS 154814-Sandquist et al. (1985, Table 3-7) estimated that costs could range from about \$200,000 to \$620 million. In this study, Sandquist estimated that contamination would affect between 0.063 to 4.3 square kilometers (16 to 1,100 acres). A study by DIRS 152083-Chanin and Murfin (1996, Chapter 6) estimated the costs of cleanup following a transportation accident in which plutonium would be dispersed. This study developed cost estimates for cleaning up and remediating farmland, urban areas, rangeland, and forests. The estimates ranged from \$38 million to \$400 million per square kilometer that would need to be cleaned up. The study also evaluated the costs of expedited cleanups in urban areas for light, moderate, and heavy contamination levels. These estimates ranged from \$89 million to \$400 million per square kilometer.

The National Aeronautics and Space Administration studied potential accidents for the Cassini mission, which used a plutonium powered electricity generator. The Agency estimated that costs of cleaning up radioactive material contamination on land following potential launch and reentry accidents. The estimate for the cost following a launch accident ranged from \$7 million to \$70 million (DIRS 155551-NASA 1995, Chapter 4) with an estimated contaminated land area of about 1.4 square kilometers (350 acres). The Agency assumed cleanup costs would be \$5 million per square kilometer if removal and disposal of contaminated soil were not required and \$50 million per square kilometer if those activities were required. For a reentry accident that would occur over land, the study estimated that the contaminated land area could range from about 1,500 to 5,700 square kilometers (370,000 to 1.4 million

acres) (DIRS 155551-NASA 1995, Chapter 4) with cleanup costs possibly exceeding a total of \$10 billion. In a more recent study of potential consequences of accidents that could involve the Cassini mission, NASA estimated that costs could range from \$7.5 million to \$1 billion (DIRS 155550-NASA 1997, Chapter 4). The contaminated land area associated with these costs ranged from 1.5 to 20 square kilometers (370 to 4,900 acres). As in the 1995 study, these estimates were based on cleanup costs in the range of \$5 million to \$50 million per square kilometer.

Using only the estimates provided by these studies, the costs of cleanup following a severe transportation accident involving spent nuclear fuel where radioactive material was released could be in the range from \$300,000 (after adjusting for inflation from 1985 to the present) to \$10 billion. Among the reasons for this wide range are different assumptions made regarding the factors that must be considered: 1) the severity of the assumed accident and resulting contamination levels, 2) accident location and use of affected land areas, 3) meteorological conditions, 4) cleanup levels and decontamination methods, and 5) disposal of contaminated materials. However, the extreme high estimates of costs are based on assumptions that all factors combine in the most disadvantageous way to create a “worst case.” Such worst cases are not reasonably foreseeable. Conversely, estimates as low as \$300,000 may also not be realistic for all of the direct and indirect costs of cleaning up following an accident severe enough to cause a release of radioactive materials.

To gauge the range of costs that it could expect for severe accidents in transporting spent nuclear fuel to a Yucca Mountain repository, DOE considered the spectrum of accidents that are reasonably foreseeable (see Section J.1.4.2.1) and the amount of radioactive material that could be released in each such accident and compared this to the estimates of releases used by the various studies discussed above. Based on 2 million curies of radioactive material in a rail casks loaded with spent nuclear fuel, about 13 curies (mostly cesium) would be released in a maximum reasonably foreseeable accident. This is about 100 times less than used by Sandquist in his study (1,630 curies) and 50 times less than the release used in the estimates provided by the Nuclear Regulatory Commission in 1977 (600 curies). The estimated frequency for an accident this severe to occur is about 3 times in 10 million years. Based on the prior studies (where estimated releases exceeded those estimated in this appendix for a maximum reasonably foreseeable accident) and the amount of radioactive material that could be released in a maximum reasonably foreseeable accident, the Department believes that the cost of cleaning up following such an accident could be a few million dollars. Nonetheless, as stated above, the Department also believes that estimates of such costs contain great uncertainty and are speculative; they could be less or 10 times greater depending on the contributing factors.

For perspective, the current insured limit of responsibility for an accident involving releases of radioactive materials to the environment is \$9.43 billion (see Appendix M). The annual cost of transporting spent nuclear fuel and high-level radioactive waste to Yucca Mountain would be about \$200 million.

Ecological Restoration. Following a severe transportation accident, it might be necessary to restore the ecology of an area after the area was remediated. DIRS 152083-Chanin and Murfin (1996, all) present a review of the scope of ecological restoration that can be accomplished and the requirements that would apply in the event of an accident where environmental damage resulting from cleaning up radioactive material contamination would in turn result in a need for environmental restoration. The restoration that would be necessary following an accident cannot be predicted. It would depend on the environmental factors involved—1) the levels of contamination from the accident, 2) cleanup levels and decontamination methods used, and 3) location and ecology of the affected land areas—and the restoration goal that was used. DIRS 152083-Chanin and Murfin (1996, Chapter 6) observe

“[a] long-standing definition of the preferred goal of site restoration is to establish an ecological community as similar as possible to that which existed before an accident. Alternative goals are to

establish a similar, but not identical, community; to establish an entirely different but valued community; or, if none of the foregoing is feasible, to establish some less-valued community.”

The costs discussed above include costs for environmental restoration.

DIRS 152083-Chanin and Murfin (1996, all) provide the following assessments of environmental restoration that could be accomplished following clean up of contamination from an accident.

- Unassisted restoration of desert land is difficult, but assisted restoration can be very successful.
- Grasslands may be restored naturally provided only limited soil has been removed. Assisted restoration of prairies is also successful.
- Total restoration of forests may not be possible if the area is too large for natural reseeding; an alternative use may have to be found for forestland.
- Restoration of farmland is relatively simple.
- Restoration of urban land to building sites is simple.
- Restoration to parkland is possible, but more costly.

J.2 Evaluation of Rail and Intermodal Transportation

DOE could use several modes of transportation to ship spent nuclear fuel from the 72 commercial and 5 DOE sites. Legal-weight trucks could transport spent nuclear fuel and high-level radioactive waste in truck casks that would weigh approximately 22,500 kilograms (25 tons) when loaded. For sites served by railroads, railcars could be used to ship rail casks directly to the Yucca Mountain site, if a branch rail line was built in Nevada, or to an intermodal transfer station in Nevada if heavy-haul trucks were used. Rail casks would weigh as much as 136,000 kilograms (150 tons).

For sites that have the capability to load rail casks but are not served by a railroad, DOE could use heavy-haul trucks or, for sites on navigable waterways, barges to transport casks to nearby railheads.

For rail shipments, DOE could request the railroads to provide dedicated trains to transport casks from the sites to a destination in Nevada or could deliver railcars with loaded casks to the railroads as general freight for delivery in Nevada.

In addition, DOE evaluated the potential for including two other scenarios: (1) a different mostly rail scenario in which railcars would transport legal-weight truck casks and (2) a large-scale barge scenario.

J.2.1 LEGAL-WEIGHT TRUCK CASKS ON RAILCARS SCENARIO

DOE assessed the sensitivity of transportation impacts to assumptions related to transportation scenarios. The analysis evaluated a variation of the mostly rail scenario in which shipments would be made using casks much smaller than rail casks—legal-weight truck casks—shipped to Nevada on railcars then transported on legal-weight trucks from a rail siding to Yucca Mountain. Under this scenario, because all shipments (except shipments of naval spent nuclear fuel) would use legal-weight truck casks, the number of railcar shipments would be about 53,000 over the 24 years of the Proposed Action. This would be the same as the number of legal-weight truck plus naval spent nuclear fuel shipments in the mostly legal-weight truck scenario.

DOE estimated impacts of this variation of the mostly rail transportation scenario by scaling from the impacts estimated for the mostly rail scenario. The analysis used the ratio of the number of railcars that would be shipped to the number of railcar shipments estimated for the mostly rail scenario and assumed each shipment would include an escort car and five railcars carrying legal-weight truck casks. The estimated number of public incident-free latent cancer fatalities would be approximately 4, and the estimated number of traffic fatalities would be 8. The total of these estimates, 12, is about 1.5 times the DOE revised estimate of a total of 7 fatalities (2.5 latent cancer fatalities plus 4.5 traffic fatalities) for the legal-weight truck scenario.

DOE determined that while this scenario would be feasible, it would not be practical. The number of shipping casks and railcar shipments would be greater by a factor of 5 than for the mostly rail scenario and the additional cost to the Program would be more than \$1 billion. In addition, the truck-casks-on-railcars scenario would lead to the highest estimates of occupational health and public health and safety impacts, most coming from rail-traffic related facilities.

J.2.2 LARGE-SCALE BARGE SCENARIO

In response to public comments on the 1986 Environmental Assessment for the Yucca Mountain Site, Research and Development Area, Nevada (DIRS 104731-DOE 1986, p. C.2-40), DOE described barge transportation as a feasible alternative that could play a secondary or supplementary role in the transportation of radioactive wastes to a repository. In the Final Environmental Impact Statement on Management of Commercially Generated Radioactive Waste (DIRS 104832-DOE 1980, Volume A, pp. 4.64 and 4.65), DOE concluded that barge transport is an alternative when both the nuclear powerplant and the encapsulation or storage facility are on navigable waterways. That EIS observed that barge transport suggests high payloads and low tariffs, but cost gains in these two areas could be offset by the longer estimated transit times for barge shipments. The EIS also observed that casks for barge shipment of spent nuclear fuel probably would be similar, if not identical, to those used for rail transport.

The most likely way in which DOE would use barge transportation to make shipments to a repository would be to complete a leg of the trip that also involved two land legs. Even though many generator sites are adjacent to or near navigable waterways, shipping casks cannot be loaded directly onto barges in all cases. It would be necessary to use heavy-haul trucks or railcars to transport the casks from the generator site's cask loading facilities to a barge slip or dock. The casks would then either be rolled onto the barge using the land vehicle and a loading ramp and secured to the barge deck or hoisted from the land vehicle to the barge and secured. At the destination end of the barge leg of the trip, the cask would either be rolled off the barge using a ramp and a heavy-haul truck or hoisted from the barge deck onto a railcar or heavy-haul truck. The cask probably would then be transported from the destination port to Nevada by rail and not by heavy-haul truck. Thus, if casks were rolled off barges to heavy-haul trucks, they would need to be transferred to railcars. The maximum use of barge transportation would require transport through the Panama Canal for shipments from generator sites in the middle and eastern part of the United States. Such use could result in 70 percent fewer land travel kilometers than the mostly rail or mostly legal-weight truck scenario.

Analyses in the 1986 Environmental Assessment (DIRS 104731-DOE 1986, p. A-69) showed that the use of barge transportation would generally increase occupational exposure for normal shipment operations and could increase exposure of the public because of intermodal transfers. From the analyses, reactor-specific results suggest that under several circumstances the barge mode could reduce risk. The analyses concluded that the consequences of accidents from barges would be of the same magnitude as those for other modes.

Because, as discussed above, DOE could use barge transportation only in conjunction with land modes, DOE did not evaluate barge as an alternative major modal scenario as it did for the mostly rail and mostly

legal-weight truck modal scenarios. Rather, for the 17 commercial generator sites not served by railroads but situated near or adjacent to navigable waterways, DOE evaluated and compared the potential use of barges and heavy-haul trucks to transport casks containing spent nuclear fuel from these sites to nearby railheads. The analysis assumed barges or heavy-haul trucks would be offloaded at the railheads and the casks would be transferred to railcars for shipment to Nevada.

DOE eliminated the large-scale barge scenario from further consideration in the EIS because it would be overly complex, requiring greater logistical complexity than either rail or legal-weight truck transportation; a much greater number of large rail casks than rail transport; much greater cost than either rail or legal-weight truck transportation; long transport distances potentially requiring the transit of the Panama Canal outside U.S. territorial waters; transport on intercoastal and coastal waterways of coastal states and on major rivers through and bordering states; extended transportation times; intermodal transfer operations at ports; and land transport from a western port to Yucca Mountain. If in the future DOE concluded that barge transportation was reasonable and proposed to make use of it, the Department would conduct additional National Environmental Policy Act evaluations to assess potential impacts of the greater use.

J.2.3 EFFECTS OF USING DEDICATED TRAINS OR GENERAL FREIGHT SERVICE

The Association of American Railroads recommends that only special (dedicated) trains move spent nuclear fuel and certain other forms of radioactive materials (DIRS 103718-DOT 1998, p. 2-6). In developing its recommendation, the Association concluded that the use of special trains would provide operational (for railroads and shippers) and safety advantages over shipments that used general freight service. Notwithstanding this recommendation, the U.S. Department of Transportation study (DIRS 103718-DOT 1998, all) compared dedicated and regular freight service using factors that measure impacts to overall public safety. The results of this study indicated that dedicated trains could provide advantages over regular trains for incident-free transportation but could be less advantageous for accident risks. However, available information does not indicate a clear advantage for the use of either dedicated trains or general freight service. Thus, DOE has not determined the commercial arrangements it would request from railroads for shipment of spent nuclear fuel and high-level radioactive waste. Table J-25 compares the dedicated and general freight modes. These comparisons are based on the findings of the U.S. Department of Transportation study and the Association of American Railroads.

J.2.4 IMPACTS OF THE SHIPMENT OF COMMERCIAL SPENT NUCLEAR FUEL BY BARGE AND HEAVY-HAUL TRUCK FROM 24 SITES NOT SERVED BY A RAILROAD

The mostly rail scenario includes 24 sites that do not have direct rail access. For those sites, heavy-haul trucks would be used to haul the spent nuclear fuel casks to the nearest railhead. As shown in Figure J-9 (a multipage figure), 17 of the 24 sites are on navigable waterways, so barge transport could be a feasible way to move spent nuclear fuel to the closest railhead with barge access. This section estimates the changes in impacts to the mostly rail scenario if barge transport replaced heavy-haul truck transport for these 17 sites.

J.2.4.1 Routes for Barges and Heavy-Haul Trucks

The distances from the 24 sites to railheads range from about 6 to 75 kilometers (4 to 47 miles). DOE used the HIGHWAY computer code to estimate routing for heavy-haul trucks (DIRS 104780-Johnson et al. 1993, all). The INTERLINE computer code (DIRS 104781-Johnson et al. 1993, all) was used to generate route-specific distances that would be traveled by barges. Table J-26 lists estimates for route lengths for barges and heavy-haul trucks. Table J-27 lists the number of shipments from each site.

Table J-25. Comparison of general freight and dedicated train service.

Attribute	General freight	Dedicated train
Overall accident rate for accidents that could damage shipping casks	Same as mainline railroad accident rates	Expected to be lower than general freight service because of operating restrictions and use of the most up-to-date railroad technology.
Grade crossing, trespasser, worker fatalities	Same as mainline railroad rates for fatalities	Uncertain. Greater number of trains could result in more fatalities in grade crossing accidents. Fewer stops in classification yards could reduce work related fatalities and trespasser fatalities.
Security	Security provided by escorts required by NRC ^a regulations	Security provided by escorts required by NRC regulations; fewer stops in classification yards than general freight service.
Incident-free dose to public	Low, but more stops in classification yards than dedicated trains. However, classification yards would tend to be remote from populated areas.	Lower than general freight service. Dedicated trains could be direct routed with fewer stops in classification yards for crew and equipment changes.
Radiological risks from accidents	Low, but greater than dedicated trains	Lower than general freight service because operating restrictions and equipment could contribute to lower accident rates and reduced likelihood of maximum severity accidents.
Occupational dose	Duration of travel influences dose to escorts	Shorter travel time would result in lower occupational dose to escorts.
Utilization of resources	Long cross-country transit times could result in least efficient use of expensive transportation cask resources; best use of railroad resources; least reliable delivery scheduling; most difficult to coordinate state notifications.	Direct through travel with on-time deliveries would result in most efficient use of cask resources; least efficient use of railroad resources. Railroad resource demands from other shippers could lead to schedule and throughput conflicts. Easiest to coordinate notification of state officials.

a. NRC = U.S. Nuclear Regulatory Commission.

J.2.4.2 Analysis of Incident-Free Impacts for Barge and Heavy-Haul Truck Transportation

J.2.4.2.1 Radiological Impacts of Incident-Free Transportation

This section compares radiological and nonradiological impacts to populations, workers, and maximally exposed individuals for the mostly rail case when casks from heavy-haul truck transport would be switched to barge for 17 of the 24 heavy haul truck sites. To make the comparison, the analysis retained any assumptions not affected by the mode change for the 17 sites. Thus:

- The seven sites that would ship by heavy-haul truck and do not have barge access would ship by heavy-haul truck in the barge case.
- The sites that would ship by legal-weight truck in the mostly rail case still ship by legal-weight truck for the barge analysis.
- For the rail segments of the routes that would use barge transport, separate INTERLINE runs determined the routes from the closest barge dock with rail access to each of the six end nodes in Nevada. While these routes are normally the same outside the origin state, no restrictions were imposed on INTERLINE requiring that the routes outside the origin state be the same.

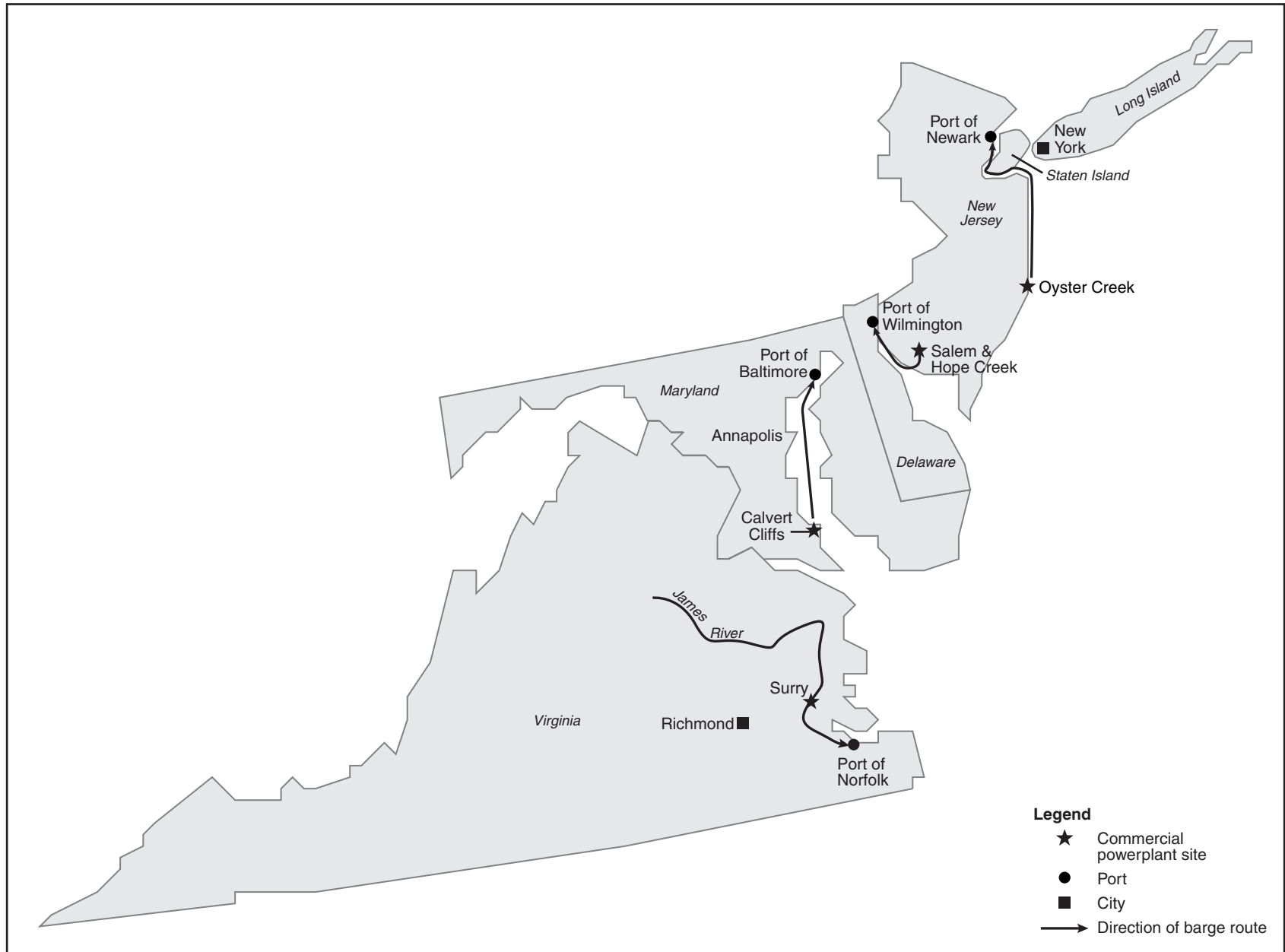

Figure J-9. Routes analyzed for barge transportation from sites to nearby railheads (page 1 of 4).

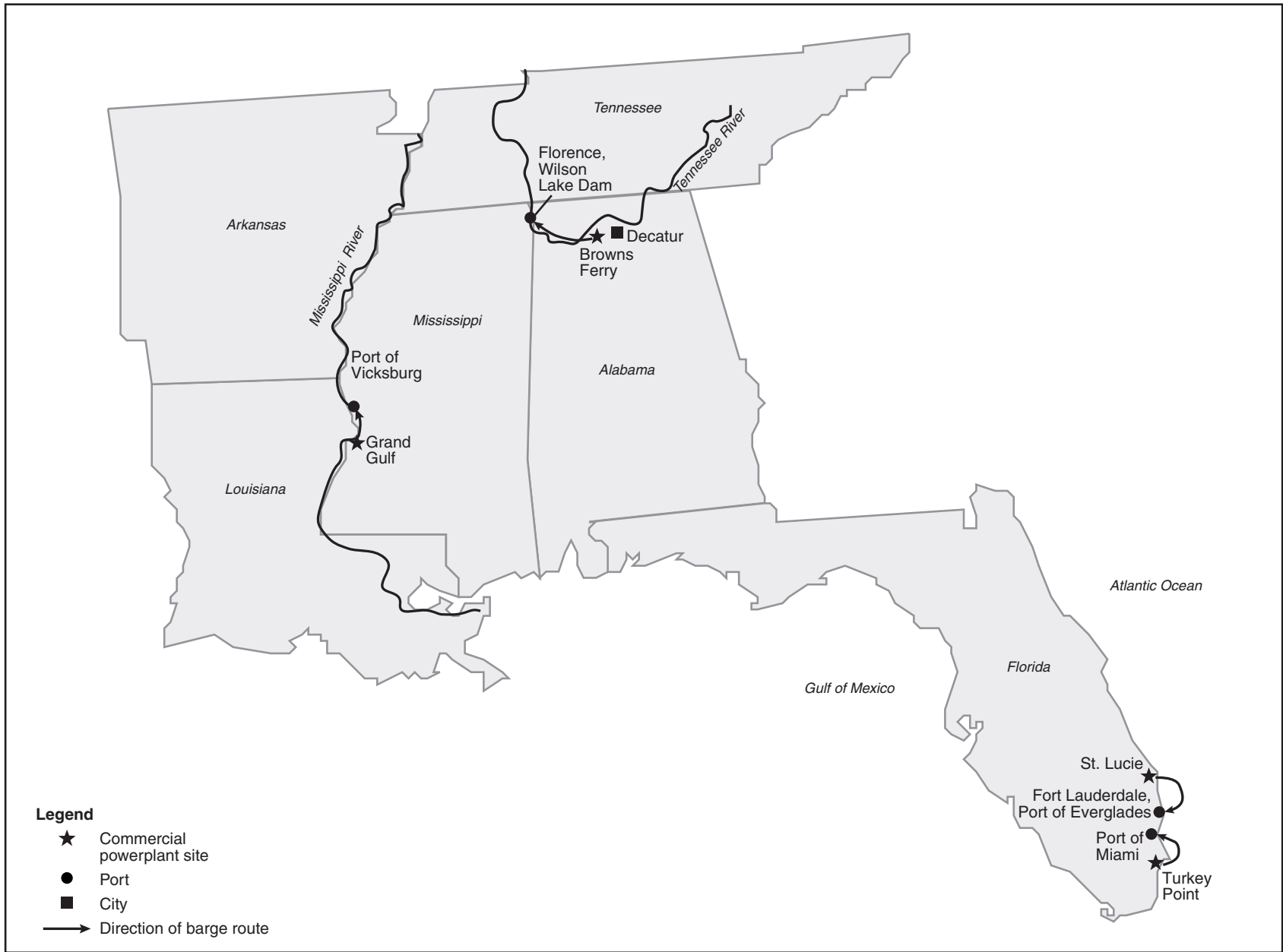

Figure J-9. Routes analyzed for barge transportation from sites to nearby railheads (page 2 of 4).



Figure J-9. Routes analyzed for barge transportation from sites to nearby railheads (page 3 of 4).

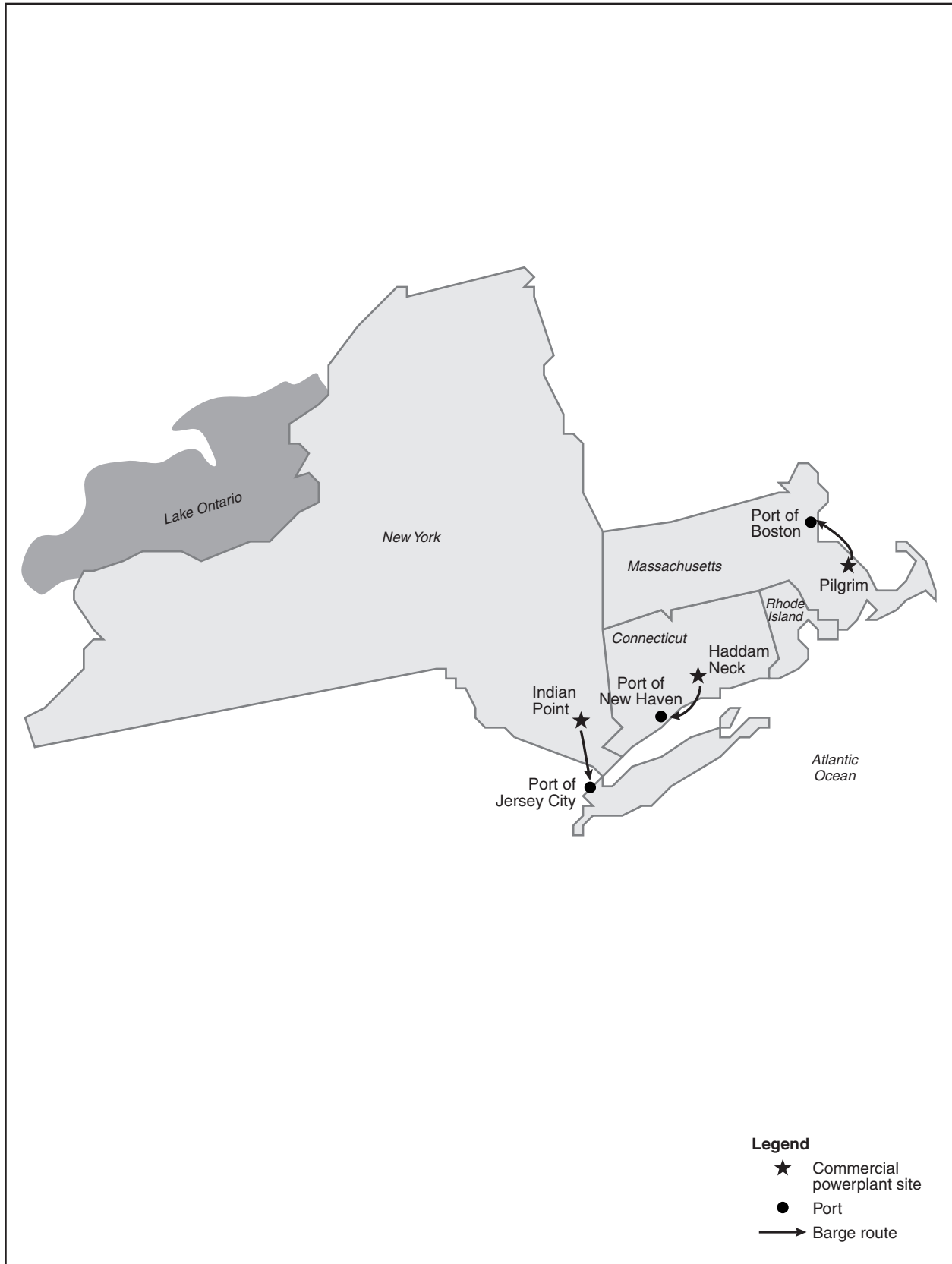

Figure J-9. Routes analyzed for barge transportation from sites to nearby railheads (page 4 of 4).

Table J-26. National transportation distances from commercial sites to Nevada ending rail nodes (kilometers).^{a,b}

Site (intermodal rail node) ^c	Rail transportation				Barge transportation			
	Total ^d	Rural	Suburban	Urban	Total ^d	Rural	Suburban	Urban
Browns Ferry NP ^e	3,279 - 3,656	2,985 - 3,306	260 - 300	34 - 49	57	51	5	0
Calvert Cliffs NP	4,028 - 4,404	3,270 - 3,592	610 - 650	148 - 162	99	98	2	0
Cooper NP	2,029 - 2,405	1,910 - 2,231	98 - 138	21 - 36	117	100	16	1
Diablo Canyon NP	582 - 1,453	375 - 1,006	112 - 311	94 - 136	143	143	0	0
Grand Gulf NP	3,298 - 3,665	2,859 - 3,333	270 - 373	28 - 67	51	51	0	0
Haddam Neck NP	4,339 - 4,716	3,316 - 3,637	842 - 882	182 - 197	99	89	10	0
Hope Creek NP	4,229 - 4,605	3,458 - 3,779	655 - 695	116 - 131	30	30	0	0
Indian Point NP	4,351 - 4,727	3,425 - 3,746	766 - 806	160 - 175	68	13	39	15
Kewaunee NP	2,864 - 3,241	2,506 - 2,827	291 - 331	68 - 82	177	171	1	5
Oyster Creek NP	4,337 - 4,714	3,420 - 3,741	765 - 806	152 - 167	130	77	36	17
Palisades NP	3,060 - 3,436	2,607 - 2,929	355 - 395	97 - 112	256	256	0	0
Pilgrim NP	4,393 - 4,769	3,338 - 3,659	858 - 899	196 - 211	74	41	33	0
Point Beach NP	2,864 - 3,241	2,506 - 2,827	291 - 331	68 - 82	169	163	1	5
Salem NP	4,229 - 4,605	3,458 - 3,779	655 - 695	116 - 131	34	34	0	0
St. Lucie NP	4,840 - 5,136	3,934 - 4,205	756 - 842	87 - 139	140	50	52	38
Surry NP	4,403 - 4,780	3,773 - 4,094	554 - 595	76 - 90	71	60	8	3
Turkey Point NP	4,882 - 5,178	3,937 - 4,208	765 - 851	117 - 169	54	53	0	1
Big Rock Point NP	3,258 - 3,595	2,766 - 3,059	399 - 431	93 - 105	-- ^f	--	--	--
HH - 20.0 kilometers								
Callaway NP	2,491 - 2,868	2,352 - 2,674	119 - 159	20 - 35	--	--	--	--
HH - 18.5 kilometers								
Fort Calhoun NP	1,997 - 2,373	1,905 - 2,227	81 - 122	10 - 25	--	--	--	--
HH - 6.0 kilometers								
Ginna NP	3,532 - 3,869	2,792 - 3,086	604 - 636	136 - 147	--	--	--	--
HH - 35.1 kilometers								
Oconee NP	3,999 - 4,375	3,470 - 3,792	475 - 515	54 - 68	--	--	--	--
HH - 17.5 kilometers								
Peach Bottom NP	4,110 - 4,486	3,383 - 3,704	616 - 656	111 - 126	--	--	--	--
HH - 58.9 kilometers								
Yankee Rowe NP	3,998 - 4,335	3,083 - 3,376	752 - 784	164 - 175	--	--	--	--
HH - 10.1 kilometers								

- a. To convert kilometers to miles, multiply by 0.62137.
- b. Distances estimated using INTERLINE computer program. Salem/Hope Creek treated as two sites.
- c. Intermodal rail nodes selected for purpose of analysis. Source: (DIRS 104800-CRWMS M&O 1999, all).
- d. Totals might differ from sums of rural, suburban, and urban distances due to method of calculation and rounding.
- e. NP = nuclear plant.
- f. -- = sites not located on a navigable waterway.

The analysis included radiological impacts of intermodal transfers at the interchange from heavy-haul trucks to railcars or barges to railcars. Workers would be exposed to radiation from casks during transfer operations. However, because the transfers would occur in terminals and berths remote from public access, public exposures would be small. Impacts of constructing intermodal transfer facilities were not included because intermodal transfers were assumed to take place at existing facilities.

The analysis assumed that heavy-haul trucks would travel at a lower speed than legal-weight trucks and that barge transport would be even slower. The assumed speed was 40 kilometers (25 miles) per hour and 8 kilometers (5 miles) per hour for heavy-haul truck and barge transport, respectively. These speeds were assumed to be independent of any population zone. Because travel distances to nearby railheads are short in relation to the distances traveled by rail, the expected impacts of heavy-haul truck and barge transportation would be much smaller than those of national rail shipments. The analysis of impacts for barge shipments assumed that the transport would employ commercial vessels operated by maritime

Table J-27. Barge shipments and ports.

Plant name	State	Number of shipments			Barge ports assumed for barge-to-rail intermodal transfer
		Proposed Action	Module 1	Module 2	
Browns Ferry 1	AL	122	247	248	Wilson Loading Dock
Browns Ferry 2	AL	0	0	1	Wilson Loading Dock
Browns Ferry 3	AL	51	120	121	Wilson Loading Dock
Diablo Canyon 1	CA	60	148	150	Port Huememe
Diablo Canyon 2	CA	61	160	162	Port Huememe
Haddam Neck	CT	40	40	42	Port of New Haven
St. Lucie 1	FL	12	13	16	Port Everglades
St. Lucie 2	FL	61	147	150	Port Everglades
Turkey Point 3	FL	52	85	87	Port of Miami
Turkey Point 4	FL	52	86	88	Port of Miami
Calvert Cliffs 1	MD	169	320	323	Port of Baltimore
Calvert Cliffs 2	MD	0	0	3	Port of Baltimore
Pilgrim	MA	24	18	19	Port of Boston
Palisades	MI	70	122	125	Port of Muskegon
Grand Gulf 1	MS	80	215	216	Port of Vicksburg
Cooper Station	NE	42	124	125	Port of Omaha
Hope Creek	NJ	67	105	106	Port of Wilmington
Oyster Creek 1	NJ	64	110	111	Port of Newark
Salem 1	NJ	59	101	103	Port of Wilmington
Salem 2	NJ	54	108	110	Port of Wilmington
Indian Point 1	NY	0	0	1	Port of Jersey City
Indian Point 2	NY	35	34	36	Port of Jersey City
Indian Point 3	NY	22	19	21	Port of Jersey City
Surry 1	VA	197	330	332	Port of Norfolk
Surry 2	VA	0	0	2	Port of Norfolk
Kewaunee	WI	64	110	111	Port of Milwaukee
Point Beach 1	WI	130	213	215	Port of Milwaukee
Point Beach 2	WI	0	0	2	Port of Milwaukee
Totals		1,575	2,952	3,004	

carriers on navigable waterways and that these shipments would follow direct routing from the sites to nearby railheads. For both modes, intermodal transfers would be necessary to transfer the casks to railcars.

The analysis estimated radiological impacts during transport for workers and the general population. For heavy-haul truck shipments, workers included vehicle drivers and escorts. For barge shipments, workers included five crew members on board during travel. In both the heavy-haul truck and barge cases, the workers would be far enough from the cask such that the major exposure would occur during periodic walkaround inspections. In both cases, consistent with the as-low-as-reasonably-achievable requirement guiding worker exposure, the analysis assumed that only one individual would perform these inspections. The general population for truck shipments included persons within 800 meters (about 2,600 feet) of the road (offlink), persons sharing the road (onlink), and persons at stops. The general population for barging included persons within a range of 200 to 1,000 meters (about 660 to 3,300 feet) of the route. Consistent with normal barge operations, the periodic walkaround inspections would occur while the barge was in motion and there was sufficient crew on board to eliminate the need for intermediate rest stops. Consistent with the RADTRAN 5 modeling, onlink exposures to members of the public during barging were assumed to be negligible. Incident-free unit risk factors were developed to calculate occupational and general population collective doses. Table J-28 lists the unit risk factors for heavy-haul truck and barge shipments. These factors reflect the effects of slower operating speeds for those vehicles in comparison to those for legal-weight trucks.

Table J-29 lists the incident-free impacts using the three shipment scenarios listed above. Impacts of intermodal transfers are included in the results. Occupational impacts would include the estimated radiological exposures of security escorts.

Table J-28. Risk factors for incident-free heavy-haul truck and barge transportation of spent nuclear fuel and high-level radioactive waste.

Mode	Exposure group	Incident-free risk factors (person-rem per kilometer) ^a		
		Rural	Suburban	Urban
Heavy-haul truck	<i>Occupational</i>			
	Onlink ^b	5.54×10^{-6}	5.54×10^{-6}	5.54×10^{-6}
	Stops ^b	1.45×10^{-5}	1.45×10^{-5}	1.45×10^{-5}
	<i>General population</i>			
	Offlink ^c	6.24×10^{-8}	6.24×10^{-8}	6.24×10^{-8}
	Onlink ^b	1.01×10^{-4}	7.94×10^{-5}	2.85×10^{-4}
	Stops ^b	3.96×10^{-9}	3.96×10^{-9}	3.96×10^{-9}
Barge	Overnight stop	2.62×10^{-3}		
	<i>Occupational^d</i>			
		2.11×10^{-6}	2.11×10^{-6}	2.11×10^{-6}
	<i>General population</i>			
	Offlink ^c	1.72×10^{-7}	1.72×10^{-7}	1.72×10^{-7}
	Onlink ^b	0.0	0.0	0.0
	Stops	0.0	0.0	0.0

- a. The unit dose factors are developed from the equations in DIRS 155430-Neuhauser, Kanipe, and Weiner (2000, all) in the same way as the unit dose factors in Section J.1.3.
- b. Onlink and stopped risk factors consider the exposure to the general population sharing the road and the crew transporting the cask. These factors must be multiplied by the number of shipments and the distance in kilometers in the zone for each segment of the route. The onlink vehicle density for rural transportation in Nevada was estimated using the annual average daily traffic on I-15 at the California-Nevada border (DIRS 103405-NDOT 1997, p. 4).
- c. Offlink general population included persons from 30 to 800 meters (about 100 to 2,600 feet) of the road or railway and from 200 and 1,000 meters (about 650 and 3,300 feet) for barge. This risk factor must be multiplied by the number of shipments, distance in kilometers in the zone, and the population density (individuals per square kilometer) in the zone for each segment of the route.
- d. Because heavy-haul vehicles cannot be in transit in Nevada for more than 12 hours, an overnight stop is modeled for routes that would require trips longer than 12 hours. This stop is not modeled for the short distances between reactor sites and railheads for indirect rail sites. When used, the factor is multiplied by the number of shipments.

Table J-29. Comparison of population doses and impacts from incident-free national transportation mostly rail heavy-haul truck scenario, mostly rail barge scenario, and mostly truck scenario.^{a,b}

Category	Mostly rail (heavy-haul truck) ^c	Mostly rail (barge from 17 of 24 heavy-haul sites) ^c	Mostly truck
<i>Involved worker</i>			
Collective dose (person-rem)	4,300	4,400	14,100
Estimated LCFs ^d	1.7	1.7	5.6
<i>Public</i>			
Collective dose (person-rem)	1,500	1,400	5,000
Estimated LCFs	0.8	0.7	2.5
<i>Maximally exposed individual</i>			
Dose (rem)	0.29	0.29	3.2
Estimated emissions fatalities	0.0001 ^e	0.0001 ^e	0.0016 ^f

- a. Impacts are totals for all shipments over 24 years.
- b. Includes impacts from intermodal transfer station (see Section 6.3.3.1).
- c. Nevada impacts for the mostly rail routes have been averaged to show the effects of using barges at the origin.
- d. LCF = latent cancer fatality.
- e. Resident near a rail stop.
- f. Person at a service station.

As indicated in Table J-29, the differences between the two mostly rail scenarios, heavy-haul truck and barge to nearby railheads, would be much smaller than the differences between the mostly rail scenarios and the mostly truck scenario. Considering only the mostly rail case options, heavy-haul and barge, the slower speed of the barge would tend to make barge exposures higher and the closest distance to resident population, 30 meters (100 feet) versus 200 meters (660 feet) for heavy-haul and barge, respectively, would tend to make barge exposures lower. Differences in the total exposed population or travel

distances between the heavy-haul truck and barge routes could result in differences in the collective dose. Table J-29 indicates that the collective dose to the general public would be about the same as the barge case. Because workers would be well away from the cask during transport, the collective dose to workers would depend totally on the number of inspections performed during transit. Table J-29 indicates that these differences would be small. Based on this table, the barge scenario would have approximately the same impacts as the heavy-haul truck scenario that DOE used as a basis for the mostly rail results in Section J.1.3 and J.1.4.

J.2.4.2.2 Nonradiological Impacts of Incident-Free Transportation (Vehicle Emissions)

Table J-30 compares the estimated number of fatalities from vehicle emissions from shipments, assuming the use of heavy-haul trucks or barges to ship to nearby railheads.

Table J-30. Estimated population health impacts from vehicle emissions during incident-free national transportation for mostly rail heavy-haul truck and barge scenarios and the mostly legal-weight truck scenario.^a

Category	Mostly rail	Mostly rail	Mostly truck
	(heavy-haul from 24 sites)	(heavy-haul truck from 7 sites and barge from 17)	
Estimated fatalities	0.63	0.62	0.93

a. Impacts are totals over 24 years, including impacts from an intermodal transfer station (see Chapter 6, Section 6.3.3.1).

J.2.4.3 Analysis of Impacts of Accidents for Barge and Heavy-Haul Truck Transportation

J.2.4.3.1 Radiological Impacts of Accidents

The analysis of risks from accidents during heavy-haul truck, rail, and legal-weight truck transport of spent nuclear fuel and high-level radioactive waste used the RADTRAN 5 computer code (DIRS 150898-Neuhauser and Kanipe 2000, all; DIRS 155430-Neuhauser, Kanipe, and Weiner 2000, all) in conjunction with an Access database and the analysis approach discussed in Section J.1.4.2. The analysis of risks due to barging used the same methodology with the exception of conditional probabilities. For barge shipments, the conditional accident probabilities and release fractions (Table J-31) for each cask response category were based on a review of other barge accident analyses.

The definitions of the accident severities listed in Table J-31 are based on the analyses reported in DIRS 152476-Sprung et al. (2000, pp. 7-75 to 7-76). DOE used the same accident severity category definitions as those used in the rail analysis described in Section J.1.4.2. If radioactive material was shipped by barge, both water and land contamination would be possible. DIRS 104784-Ostmeyer (1986, all) analyzed the potential importance of water pathway contamination for a spent nuclear fuel transportation accident risk using a “worst-case” water contamination scenario. The analysis showed that the impacts of the water contamination scenario would be about one-fiftieth of the impacts of a comparable accident on land. Therefore, the analysis assumed that deposition would occur over land, not water. DOE used population distributions developed from 1990 Census data to calculate route-specific collective doses. Table J-32 lists the total accident risk for mostly rail case heavy-haul truck scenario, the mostly rail case barge scenario, and the mostly truck scenario. Additional information is in Volume IV.

J.2.4.3.2 Nonradiological Accident Risks

As listed in Table J-32, the estimated total fatalities for the mostly rail heavy-haul truck scenario, the mostly rail barge scenario, and the mostly truck scenario would be 2.7, 2.7, and 4.5, respectively. There is essentially no difference between the two mostly rail scenarios. The only significant differences are between those scenarios, and the mostly truck case.

Table J-31. Release fractions and conditional probabilities for spent nuclear fuel transported by barge.

Severity category	Case	Conditional probability	Release fractions (pressurized-water reactor/boiling-water reactor)				
			Krypton	Cesium	Ruthenium	Particulates	Crud
1	21	0.994427	0.0	0.0	0.0	0.0	0.0
2	1, 4, 5, 7, 8	5.00×10^{-3}	$1.96 \times 10^{-1}/2.35 \times 10^{-2}$	$5.87 \times 10^{-9}/7.04 \times 10^{-10}$	$1.34 \times 10^{-7}/1.47 \times 10^{-8}$	$1.34 \times 10^{-7}/1.47 \times 10^{-8}$	$1.37 \times 10^{-3}/5.59 \times 10^{-4}$
3	20	5.00×10^{-6}	$8.39 \times 10^{-1}/8.39 \times 10^{-1}$	$1.68 \times 10^{-5}/1.68 \times 10^{-5}$	$2.52 \times 10^{-7}/2.52 \times 10^{-7}$	$2.52 \times 10^{-7}/2.52 \times 10^{-7}$	$9.44 \times 10^{-3}/9.44 \times 10^{-2}$
4	2, 3, 10	5.00×10^{-4}	$8.00 \times 10^{-1}/8.00 \times 10^{-1}$	$8.71 \times 10^{-6}/8.71 \times 10^{-6}$	$1.32 \times 10^{-5}/1.32 \times 10^{-5}$	$1.32 \times 10^{-5}/1.32 \times 10^{-5}$	$4.42 \times 10^{-3}/4.42 \times 10^{-2}$
5	6	0.0	$8.35 \times 10^{-1}/8.37 \times 10^{-1}$	$3.60 \times 10^{-5}/4.12 \times 10^{-5}$	$1.37 \times 10^{-5}/1.82 \times 10^{-5}$	$1.37 \times 10^{-5}/1.82 \times 10^{-5}$	$5.36 \times 10^{-3}/5.43 \times 10^{-3}$
6	9,11,12,13,14,15,16, 17,18,19	1.30×10^{-6}	$8.47 \times 10^{-1}/8.45 \times 10^{-1}$	$5.71 \times 10^{-5}/7.30 \times 10^{-5}$	$4.63 \times 10^{-5}/5.94 \times 10^{-5}$	$1.43 \times 10^{-5}/1.96 \times 10^{-5}$	$1.59 \times 10^{-2}/1.60 \times 10^{-2}$

Table J-32. Comparison of accident risks for the mostly rail heavy-haul truck and barge shipping scenarios.^a

Category	Mostly rail (heavy-haul option– 24 sites)	Mostly rail (barge option–17 of 24 heavy-haul sites)	Mostly truck
Population dose (person-rem)	0.89	1.5	0.5
Estimated LCFs ^b	0.00045	0.001	0.0002
Traffic fatalities ^c	2.7	2.7	4.5

a. Impacts are totals over 24 years.

b. LCF = latent cancer fatality.

c. Traffic fatality impacts for mostly rail scenarios are the average of the range of estimated traffic fatality impacts (2.3 to 3.1) for national transportation for the Proposed Action.

J.2.4.3.3 Maximum Reasonably Foreseeable Accidents

From a consequence standpoint, because DOE used the same accident severity bins for rail, heavy-haul truck, and barge transport, the consequences of a release would be the same if the accident occurred in a zone having the same population density. The population densities for barge and heavy-haul truck transport are similar to those for rail. Because the total shipping distance traveled by barge or heavy-haul truck would be a small fraction of the total distance traveled, the maximum reasonably foreseeable accident would be a rail accident. Only minor barge or heavy-haul truck transport accidents would meet the 1×10^{-7} criterion used to identify reasonably foreseeable accidents.

J.3 Nevada Transportation

With the exceptions of the possible construction of a branch rail line or upgrade of highways for use by heavy-haul trucks and the construction of an intermodal transfer station, the characteristics of the transportation of spent nuclear fuel and high-level radioactive waste in Nevada would be similar to those for transportation in other states across the nation. Unless the State of Nevada designated alternative or additional preferred routes as prescribed under regulations of the U.S. Department of Transportation (49 CFR 397.103), Interstate System Highways (I-15) would be the preferred routes used by legal-weight trucks carrying spent nuclear fuel and high-level radioactive waste. Unless alternative or non-Interstate System routes have been designated by states, Interstate System highways would also be the preferred routes used by legal-weight trucks in other states during transit to Nevada.

In Nevada as in other states, rail shipments would, for the most part, be transported on mainline tracks of major railroads. Operations over a branch rail line in Nevada would be similar to those on a mainline railroad, except the frequency of train travel would be much lower. Shipments in Nevada that used heavy-haul trucks would use Nevada highways in much the same way that other oversized, overweight trucks use the highways along with other commercial vehicle traffic.

Some State- and county-specific assumptions were used to analyze human health and safety impacts in Nevada. A major difference would be that much of the travel in the State would be in rural areas where population densities are much lower than those of many other states. Another difference would be for travel in an urban area in the state. The most populous urban area in Nevada is the Las Vegas metropolitan area, which is also a major resort area with a high percentage of nonresidents. The analysis also addressed the channeling of shipments from the commercial and DOE sites into the transportation arteries in the southern part of the State. Finally, the analysis addressed the commuter and commercial travel that would occur on highways in the southern part of the State as a consequence of the construction, operation and monitoring, and closure of the proposed repository.

This section presents information specific to Nevada that DOE used to estimate impacts for transportation activities that would take place in the State. It includes results for cumulative impacts that would occur in Nevada for transportation associated with Inventory Modules 1 and 2.

J.3.1 TRANSPORTATION MODES, ROUTES, AND NUMBER OF SHIPMENTS

J.3.1.1 Routes in Nevada for Legal-Weight Trucks

The analysis of impacts that would occur in Nevada used the characteristics of highways in Nevada that would be used for shipments of spent nuclear fuel and high-level radioactive waste by legal-weight trucks. Specifically, the base case for the analysis used routing for the Las Vegas Northern and Western Beltway to transport spent nuclear fuel and high-level radioactive waste. The distance and population density by county was obtained from Geographical Information System data for the State of Nevada using 1990 Census data. The population density data was escalated to 2035.

Figure J-10 shows the routes in Nevada that legal-weight trucks would use unless the State designated alternative or additional preferred routes. The figure shows estimates for the number of legal-weight truck shipments that would travel on each route segment for the mostly legal-weight truck and mostly rail transportation scenarios. The inset on Figure J-10 shows the Las Vegas Beltway and the routes DOE anticipates legal-weight trucks traveling to the repository would use.

J.3.1.2 Highway and Rail Routes in Nevada for Transporting Rail Casks

The rail and heavy-haul truck implementing alternatives for transportation in Nevada include five possible rail corridors and five possible routes for heavy-haul trucks; the corridors and routes for these implementing alternatives are shown in Figures J-11 and J-12. These figures also show the estimated number of rail shipments that would enter the State on mainline railroads. These numbers indicate shipments that would arrive from the direction of the bordering state for each of the implementing alternatives for the mostly rail transportation scenario.

Table J-33 lists the total length and cumulative distance in rural, suburban, and urban population zones and the population density in each population zone in the State of Nevada used to analyze impacts of the implementing alternatives. Table J-34 lists the cumulative distance in rural, suburban, and urban population zones and the population density in each population zone for existing commercial rail lines in Nevada. DOE based the estimated population that would live along each branch rail line on population densities in census blocks along the candidate rail corridors in Nevada. The populations are based on 1990 Census data escalated to 2035. For this analysis, the ending rail nodes in Nevada for commercial rail lines would be origins for the rail and heavy-haul truck alternatives listed in Table J-33. Table J-35 lists the total population that lives within 800 meters (0.5 mile) of rail lines in Nevada.

Nevada Heavy-Haul Truck Scenario

Tables J-36 through J-40 summarize the road upgrades for each of the five possible routes for heavy-haul trucks that DOE estimates would be needed before routine use of a route to ship casks containing spent nuclear fuel and high-level radioactive waste.

Nevada Rail Corridors

Under the mostly rail scenario, DOE could construct and operate a branch rail line in Nevada. Based on the studies listed below, DOE has narrowed its consideration for a new branch rail line to five potential rail corridors—Carlin, Caliente, Caliente-Chalk Mountain, Jean, and Valley Modified. DOE identified the five rail corridors through a process of screening potential rail alignments that it had studied in past years. Several studies evaluated rail transportation.

- The *Feasibility Study for Transportation Facilities to Nevada Test Site* study (DIRS 104777-Holmes & Narver 1962, all) determined the technical and economic feasibility of constructing and operating a railroad from Las Vegas to Mercury.

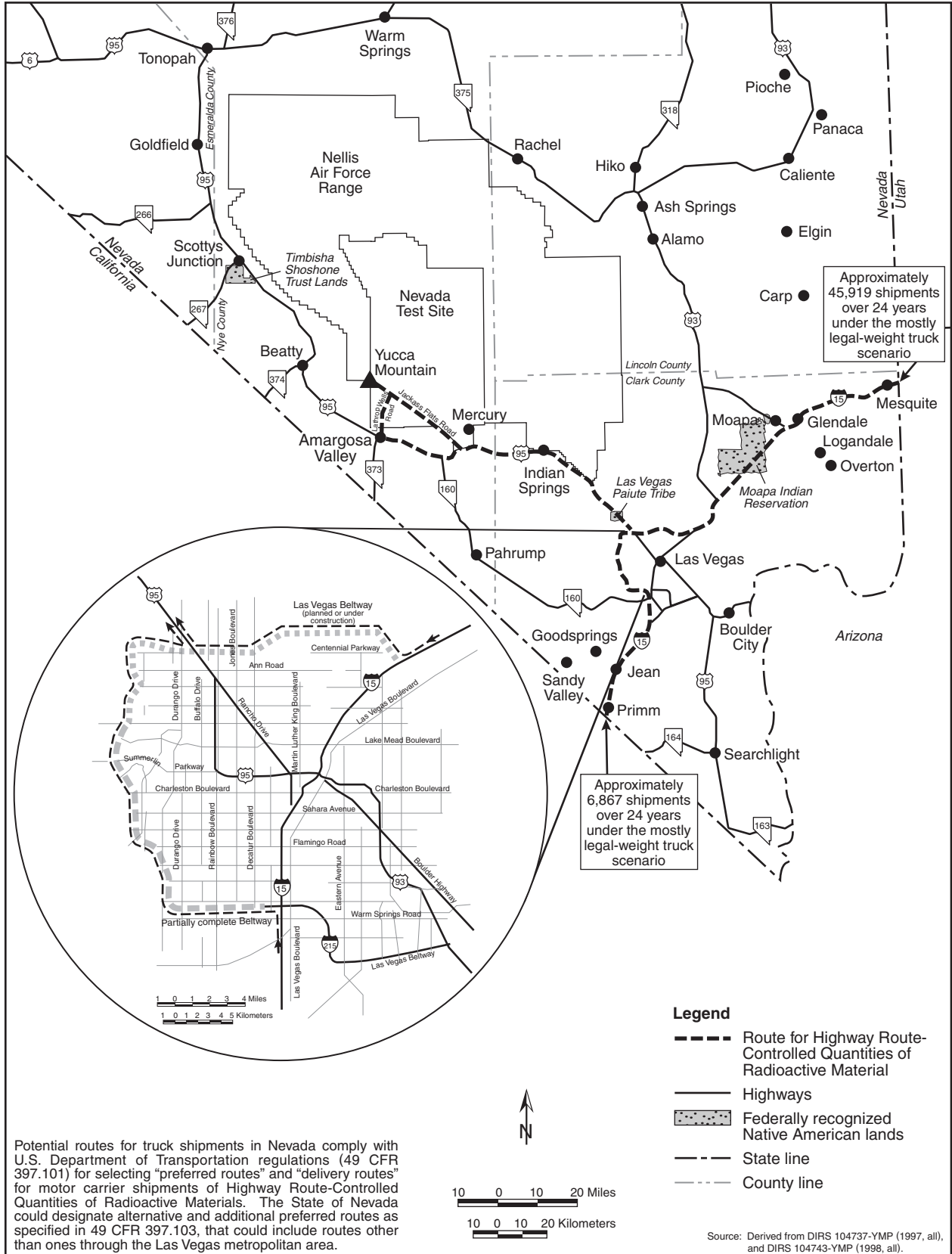

Potential routes for truck shipments in Nevada comply with U.S. Department of Transportation regulations (49 CFR 397.101) for selecting "preferred routes" and "delivery routes" for motor carrier shipments of Highway Route-Controlled Quantities of Radioactive Materials. The State of Nevada could designate alternative and additional preferred routes as specified in 49 CFR 397.103, that could include routes other than ones through the Las Vegas metropolitan area.

Source: Derived from DIRS 104737-YMP (1997, all), and DIRS 104743-YMP (1998, all).

Figure J-10. Potential Nevada routes for legal-weight trucks and estimated number of shipments.

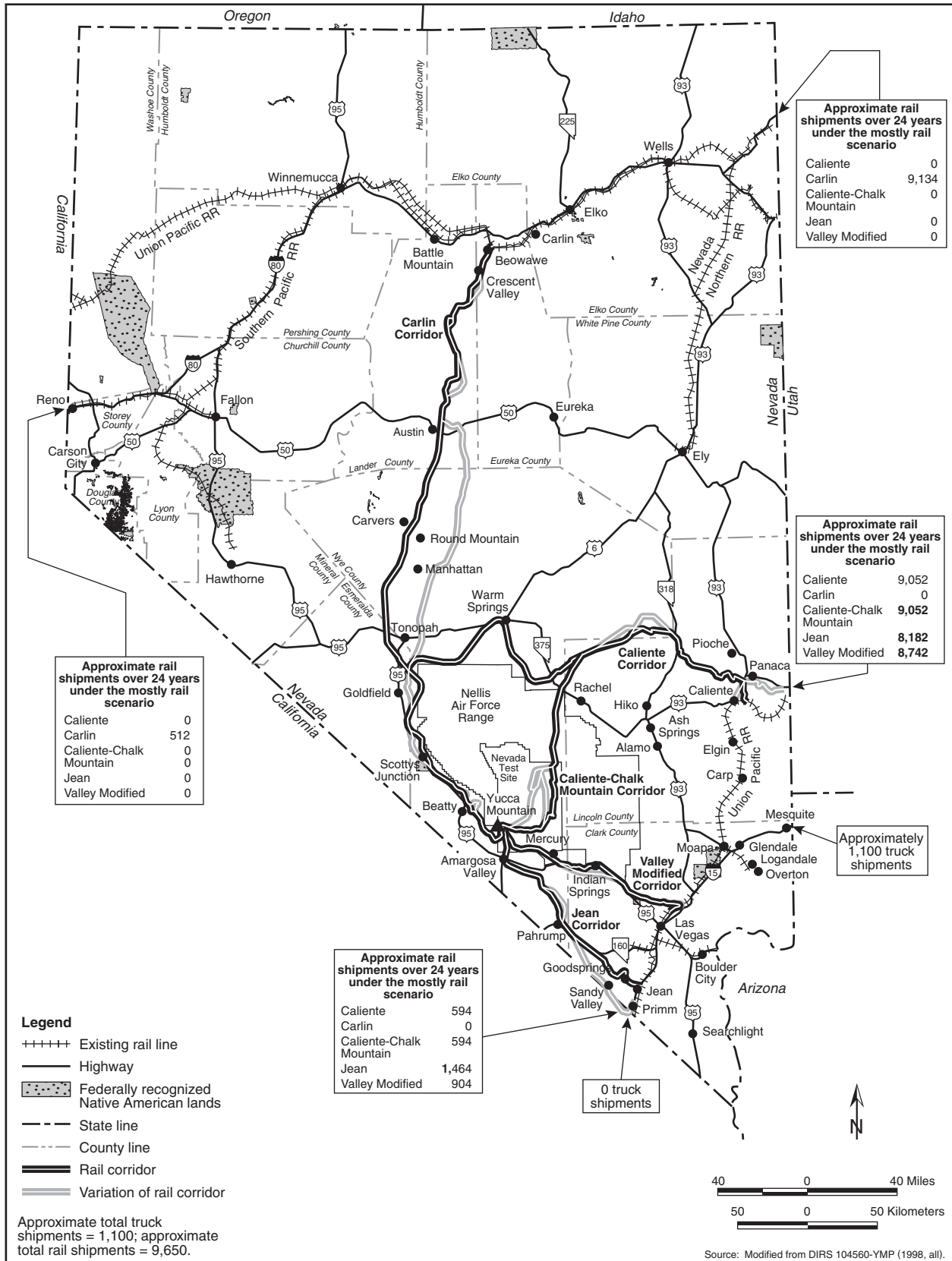

Figure J-11. Potential Nevada rail routes to Yucca Mountain and estimated number of shipments.

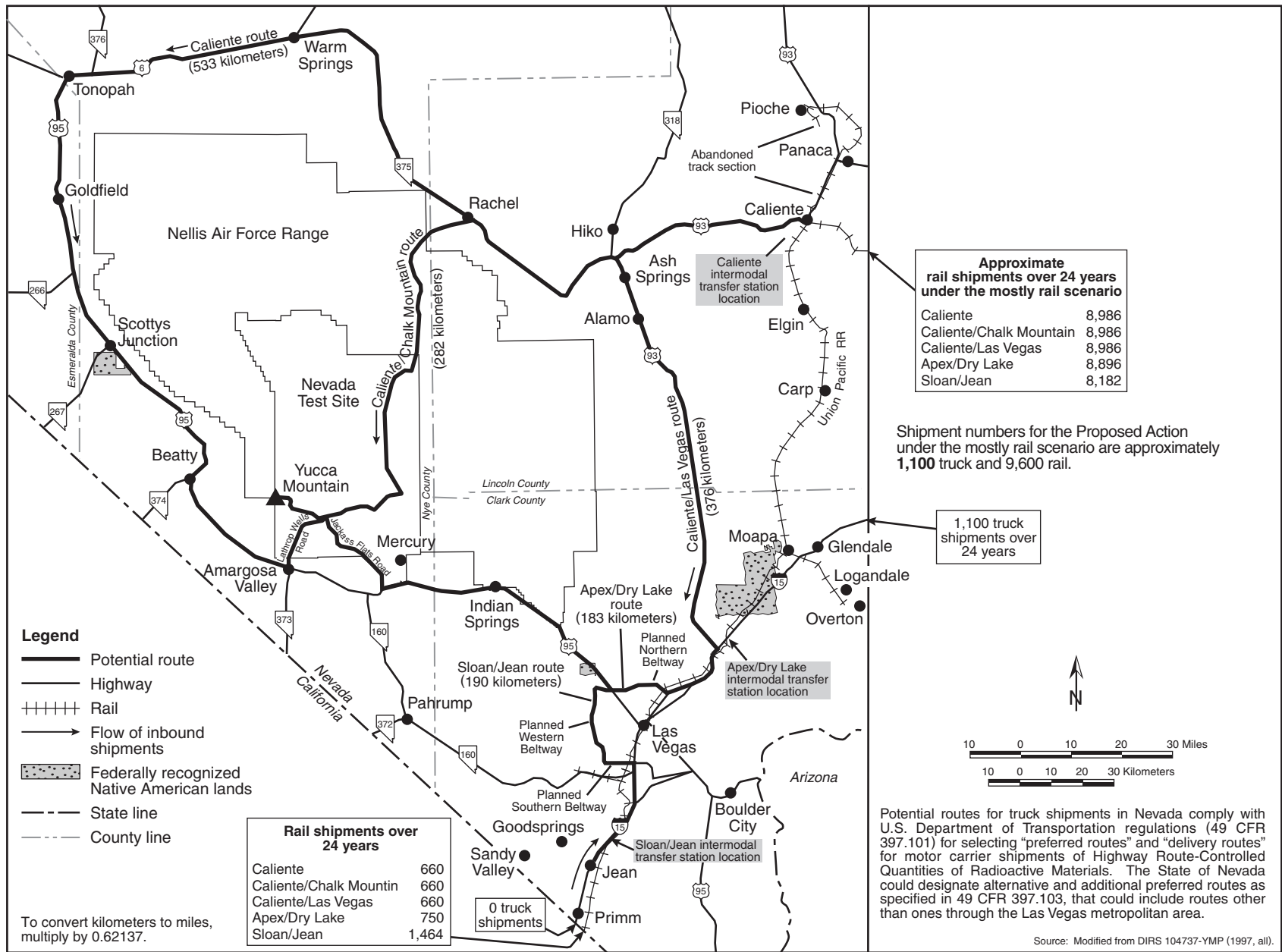

Figure J-12. Potential Nevada routes for heavy-haul trucks and estimated number of shipments.

Table J-33. Routing characteristics in Nevada for legal-weight truck, rail and heavy-haul truck implementing alternatives.

Route	County	Distance (kilometers) ^a				Population density (persons per square kilometer)		
		Urban	Suburban	Rural	Total	Urban	Suburban	Rural
<i>Legal-weight truck route in Nevada using the Las Vegas Beltway</i>								
Northern route	Clark	0.0	19.9	187.5	207.4	0.0	577	10.6
Northern route	Nye	0.0	0.0	64.7	64.7	0.0	0.0	0.0
Southern route	Clark	0.0	41.9	126.9	168.8	0.0	577	3.5
Southern route	Nye	0.0	0.0	64.7	64.7	0.0	0.0	0.0
<i>Rail alternatives</i>								
Caliente-Chalk Mountain	Lincoln	0.0	0.0	158.0	158.0	0.0	0.0	0.0
Caliente-Chalk Mountain	Nye	0.0	0.0	188.0	188.0	0.0	0.0	0.0
Caliente	Esmeralda	0.0	0.0	4.0	4.0	0.0	0.0	0.3
Caliente	Lincoln	0.0	0.0	148.5	148.5	0.0	0.0	0.0
Caliente	Nye	0.0	0.0	360.8	360.8	0.0	0.0	0.1
Carlin	Eureka	0.0	0.0	29.8	29.8	0.0	0.0	0.1
Carlin	Lander	0.0	0.0	158.7	158.7	0.0	0.0	0.0
Carlin	Esmeralda	0.0	0.0	41.0	41.0	0.0	0.0	0.4
Carlin	Nye	0.0	0.0	291.5	291.5	0.0	0.0	0.6
Jean	Clark	0.0	0.0	82.4	82.4	0.0	0.0	0.8
Jean	Nye	0.0	0.0	98.2	98.2	0.0	0.0	0.2
Apex	Clark	0.0	0.0	99.5	99.5	0.0	0.0	0.1
Apex	Nye	0.0	0.0	59.2	59.2	0.0	0.0	0.0
<i>Heavy-haul alternatives</i>								
Apex/Dry Lake	Clark	0.0	19.9	104.0	123.9	0.0	577	2.9
Apex/Dry Lake	Nye	0.0	0.0	59.4	59.4	0.0	0.0	0.001
Caliente	Esmeralda	0.0	0.0	71.6	71.6	0.0	0.0	2.0
Caliente	Lincoln	0.0	0.0	148.5	148.5	0.0	0.0	0.8
Caliente	Nye	0.0	4.7	308.5	313.2	0.0	261	0.7
Caliente/Las Vegas	Clark	0.0	19.9	147.3	167.2	0.0	577	2.1
Caliente/Las Vegas	Lincoln	0.0	0.0	149.7	149.7	0.0	0.0	0.8
Caliente/Las Vegas	Nye	0.0	0.0	59.4	59.4	0.0	0.0	0.001
Caliente/Chalk Mountain	Lincoln	0.0	0.0	146.9	146.9	0.0	0.0	0.9
Caliente/Chalk Mountain	Nye	0.0	0.0	135.3	135.3	0.0	0.0	0.0
Jean/Sloan	Clark	0.0	41.9	88.6	130.5	0.0	577	5.3
Jean/Sloan	Nye	0.0	0.0	59.4	59.4	0.0	0.0	0.0006

a. To convert kilometers to miles, multiply by 0.62137.

- The *Preliminary Rail Access Study* (DIRS 104792-YMP 1990, all) identified 13 and evaluated 10 rail corridor alignment options. This study recommended the Carlin, Caliente, and Jean Corridors for detailed evaluation.
- *The Nevada Railroad System: Physical, Operational, and Accident Characteristics* (DIRS 104735-YMP 1991, all) described the operational and physical characteristics of the current Nevada railroad system.
- The *High Speed Surface Transportation Between Las Vegas and the Nevada Test Site (NTS)* report (DIRS 104786-Cook 1994, all) explored the rationale for a potential high-speed rail corridor between Las Vegas and the Nevada Test Site to accommodate personnel.
- The *Nevada Potential Repository Preliminary Transportation Strategy, Study 1* (DIRS 104795-CRWMS M&O 1995, all), reevaluated 13 previously identified rail routes and evaluated a new route called the Valley Modified route. This study recommended four rail corridors for detailed evaluation—Caliente, Carlin, Jean, and Valley Modified.

Table J-34. Routing characteristics in Nevada for existing commercial rail lines.

End node	Route	County	Distance (kilometers) ^a				Population density (persons per square kilometer)		
			Urban	Suburban	Rural	Total	Urban	Suburban	Rural
Beowawe	NV existing rail via Utah	Eureka	0.0	0.0	31.5	31.5	0.0	0.0	0.1
Beowawe	NV existing rail via Utah	Elko	0.0	11.3	218.1	229.3	0.0	463.4	2.0
Beowawe	NV existing rail via Reno	Humboldt	0.0	6.4	103.8	110.2	0.0	431.4	5.5
Beowawe	NV existing rail via Reno	Pershing	0.0	3.2	117.8	121.0	0.0	377.0	2.6
Beowawe	NV existing rail via Reno	Lander	0.0	3.2	41.0	44.3	0.0	577.3	3.5
Beowawe	NV existing rail via Reno	Eureka	0.0	0.0	22.7	22.7	0.0	0.0	0.1
Beowawe	NV existing rail via Reno	Washoe	3.2	23.3	26.8	53.4	1,953.2	517.6	14.9
Beowawe	NV existing rail via Reno	Churchill	0.0	0.0	66.8	66.8	0.0	0.0	0.0
Beowawe	NV existing rail via Reno	Storey	0.0	2.4	18.0	20.4	0.0	199.9	8.7
Beowawe	NV existing rail via Reno	Lyon	0.0	3.2	14.7	18.0	0.0	586.9	12.9
Jean	NV existing rail Jean from south	Clark	0.0	0.0	41.7	41.7	0.0	0.0	1.0
Jean	NV existing rail Jean from north	Clark	3.2	17.7	110.0	130.9	1,879.6	750.6	0.8
Jean	NV existing rail Jean from north	Lincoln	0.0	1.6	167.8	169.4	0.0	294.3	0.8
Apex	NV existing rail Apex from north	Lincoln	0.0	1.6	167.8	169.4	0.0	294.3	0.8
Apex	NV existing rail Apex from north	Clark	0.0	0.0	50.8	50.8	0.0	0.0	2.0
Apex	NV existing rail Apex from south	Clark	3.2	17.7	100.9	121.8	1,879.6	750.6	1.4
Caliente	NV existing routing to Caliente from north	Lincoln	0.0	0.0	64.7	64.7	0.0	0.0	0.8
Caliente	NV existing routing to Caliente from south	Clark	3.2	17.7	151.7	172.6	1,879.6	750.6	1.6
Caliente	NV existing routing to Caliente from south	Lincoln	0.0	1.6	103.1	104.7	0.0	294.3	0.9
Eccles	NV existing routing to Eccles from north	Lincoln	0.0	0.0	56.3	56.3	0.0	0.0	0.0
Eccles	NV existing routing to Eccles from south	Clark	3.2	17.7	151.7	172.6	1,879.6	750.6	1.6
Eccles	NV existing routing to Eccles from south	Lincoln	0.0	1.6	111.4	113.1	0.0	294.3	1.3
Dry Lake	NV existing routing to Dry Lake from north	Lincoln	0.0	1.6	167.8	169.4	0.0	294.3	0.8
Dry Lake	NV existing routing to Dry Lake from north	Clark	0.0	0.0	50.8	50.8	0.0	0.0	2.0
Dry Lake	NV existing routing to Dry Lake from south	Clark	3.2	17.7	100.9	121.8	1,879.6	750.6	1.4

a. To convert kilometers to miles, multiply by 0.62157.

Table J-35. Populations in Nevada within 800 meters (0.5 mile) of routes.^{a,b}

Transportation scenario	Population 2035 projections
<i>Legal-weight truck routes^a</i>	190,000/300,000
<i>Rail routes Nevada border to branch rail line^b</i>	
Caliente (from the North – UT)	110
Caliente (from the South – CA)	115,000
Beowawe (from the east – UT)	21,000
Beowawe (from the west – CA)	98,000
Eccles (from the North – UT)	3
Eccles (from the south – CA)	115,000
Jean (from the North – UT)	114,000
Jean (from the South – CA)	250
Dry Lake (from the North – UT)	1,900
Dry Lake (from the South – CA)	113,000
<i>Branch rail lines</i>	
Caliente	140
Carlin	1,280
Caliente-Chalk Mountain	31
Jean	520
Valley Modified	75
<i>Heavy-haul routes</i>	
Caliente	11,000
Caliente/Chalk Mountain	740
Caliente/Las Vegas	187,000
Sloan/Jean	390,000
Apex/Dry Lake	186,000

- a. The estimated populations represent using the route from the north and from the south, respectively.
- b. The analysis assumed there would be an average of 800,000 visitors per day to Las Vegas.

Table J-36. Potential road upgrades for Caliente route.^a

Route	Upgrades
Intermodal transfer station to U.S. 93	Pave existing gravel road.
U.S. 93 to State Route 375	Asphalt overlay on existing pavement, truck lanes where grade is greater than 4 percent (minimum distance of 460 meters ^b per lane), turnout lanes every 32 kilometers ^c (distance of 305 meters per lane), widen road.
State Route 375 to U.S. 6	Remove existing pavement, increase road base and overlay to remove frost restrictions, truck lanes where grade is greater than 4 degrees (minimum distance of 460 meters per lane), turnout lanes every 32 kilometers (distance of 305 meters per lane), widen road.
U.S. 6 to U.S. 95	Same as State Route 375 to U.S. 6.
U.S. 95 to Lathrop Wells Road	Remove existing pavement on frost restricted portion, increase base and overlay to remove frost restrictions, turnout lanes every 8 kilometers (distance of 305 meters per lane), construct bypass around intersection at Beatty, bridge upgrade near Beatty.
Lathrop Wells Road to Yucca Mountain site	Asphalt overlay on existing roads.

- a. Source: DIRS 154448-CRWMS M&O (1998, all).
- b. To convert meters to feet, multiply by 3.2808.
- c. To convert kilometers to miles, multiply by 0.62137.

Table J-37. Potential road upgrades for Caliente/Chalk Mountain route.^a

Route	Upgrades
Intermodal transfer station to U.S. 93	Pave existing gravel road.
U.S. 93 to State Route 375	Asphalt overlay on existing pavement, truck lanes where grade is greater than 4 percent (minimum distance of 460 meters ^b per lane), turnout lanes every 32 kilometers ^c (distance of 305 meters per lane), widen road
State Route 375 to Rachel	Remove existing pavement, increase road base and overlay to remove frost restrictions, turnout lanes every 32 kilometers (distance of 305 meters per lane), widen road.
Rachel to Nellis Air Force Range ^d	Pave existing gravel road.
Nellis Air Force Range Roads	Rebuild existing road.
Nevada Test Site Roads	Asphalt overlay on existing roads.

- a. Source: DIRS 155436-CRWMS M&O (1997, all).
 b. To convert meters to feet, multiply by 3.2808.
 c. To convert kilometers to miles, multiply by 0.62137.
 d. Also known as the Nevada Test and Training Range.

Table J-38. Potential road upgrades for Caliente/Las Vegas route.^a

Route	Upgrades
Intermodal transfer station to U.S. 93	Pave existing gravel road.
U.S. 93 to Interstate 15	Asphalt overlay on existing pavement, truck lanes where grade is greater than 4 percent (minimum distance 460 meters ^b per lane), turnout lanes every 32 kilometers ^c (distance of 305 meters per lane), widen road, rebuild Interstate 15 interchange.
Interstate 15 to U.S. 95	Increase existing two-lane Las Vegas Beltway to four lanes, asphalt overlay on U.S. 95.
U.S. 95 to Mercury	Asphalt overlay on U.S. 95.
Mercury Exit to Yucca Mountain site	Asphalt overlay on Jackass Flats Road, rebuild road when required.

- a. Source: DIRS 154448-CRWMS M&O (1998, all).
 b. To convert meters to feet, multiply by 3.2808.
 c. To convert kilometers to miles, multiply by 0.62137.

Table J-39. Potential road upgrades for Apex/Dry Lake route.^a

Route	Upgrades
Intermodal transfer station to Interstate 15	Rebuild frontage road to U.S. 93. Rebuild U.S. 93/Interstate 15 interchange.
Interstate 15 to U.S. 95	Increase existing two-lane Las Vegas Beltway to four lanes.
U.S. 95 to Mercury Exit	Asphalt overlay on U.S. 95.
Mercury Exit to Yucca Mountain site	Asphalt overlay on Jackass Flats Road, rebuild road when required.

- a. Source: DIRS 154448-CRWMS M&O (1998, all).

Table J-40. Potential road upgrades for Sloan/Jean route.^a

Route	Upgrades
Intermodal transfer station to Interstate 15	Overlay and widen existing road to Interstate 15 interchange, rebuild Interstate 15 interchange.
Interstate 15 to U.S. 95	Increase existing two-lane Las Vegas Beltway to four lanes.
U.S. 95 to Mercury Exit	Asphalt overlay on U.S. 95.
Mercury Exit to Yucca Mountain site	Asphalt overlay on Jackass Flats Road, rebuild road when required.

- a. Source: DIRS 154448-CRWMS M&O (1998, all).

- The *Nevada Potential Repository Preliminary Transportation Strategy, Study 2* (DIRS 101214-CRWMS M&O 1996, all), further refined the analyses of potential rail corridor alignments presented in Study 1.

Public comments submitted to DOE during hearings on the scope of this environmental impact statement resulted in addition of a fifth corridor—Caliente-Chalk Mountain.

DOE has identified 0.4-kilometer (0.25-mile)-wide corridors along each route within which it would need to obtain a right-of-way to construct a rail line and an associated access road. A corridor defines the boundaries of the route by identifying an established “zone” for the location of the railroad. For this analysis, DOE identified a single alignment for each of the corridors. These single alignments are representative of the range of alignments that DOE has considered for the corridors from engineering design and construction viewpoints. The following paragraphs describe the alignments that have been identified for the corridors. Before siting a branch rail line, DOE would conduct engineering studies in each corridor to determine a specific alignment for the roadbed, track, and right-of-way for a branch rail line.

Caliente Corridor Implementing Alternative. The Caliente Corridor originates at an existing siding to the Union Pacific mainline railroad near Caliente, Nevada. The Caliente and Carlin Corridors converge near the northwest boundary of the Nellis Air Force Range (also known as the Nevada Test and Training Range). Past this point, they are identical. The Caliente Corridor is 513 kilometers (320 miles) long from the Union Pacific line connection to the Yucca Mountain site. Table J-41 lists possible alignment variations for this corridor.

Carlin Corridor Implementing Alternative. The Carlin Corridor originates at the Union Pacific main line railroad near Beowawe in north-central Nevada. The corridor is about 520 kilometers (331 miles) long from the tie-in point with the Union Pacific line to the Yucca Mountain site. Table J-42 lists possible variations in the alignment of this corridor.

Caliente-Chalk Mountain Corridor Implementing Alternative. The Caliente-Chalk Mountain Corridor is identical to the Caliente Corridor until it approaches the northern boundary of the Nellis Air Force Range (also known as the Nevada Test and Training Range). At this point the Caliente-Chalk Mountain Corridor turns south through the Nellis Air Force Range and the Nevada Test Site to the Yucca Mountain site. The corridor is 345 kilometers (214 miles) long from the tie-in point at the Union Pacific line to the Yucca Mountain site. Table J-43 lists possible alignment variations for this corridor.

Jean Corridor Implementing Alternative. The Jean Corridor originates at the existing Union Pacific mainline railroad near Jean, Nevada. The corridor is 181 kilometers (112 miles) long from the tie-in point at the Union Pacific line to the Yucca Mountain site. Table J-44 lists possible variations for this corridor.

Valley Modified Corridor Implementing Alternative. The Valley Modified Corridor originates at an existing rail siding off the Union Pacific mainline railroad northeast of Las Vegas. The corridor is about 159 kilometers (98 miles) long from the tie-in point with the Union Pacific line to the Yucca Mountain site. Table J-45 lists the possible variations in alignment for this corridor.

Land Use Conflicts Along Potential Rail Corridors in Nevada

Figures J-13 through J-20 show potential land-use conflicts along candidate rail corridors for construction of a branch rail line in Nevada.

Table J-41. Possible variations of the Caliente Corridor.^a

Variation	Description ^b
Eccles Option	Included in corridor description. Crosses private land and BLM lands. No ROWs crossed.
Caliente Option ^c	Connects with Union Pacific line at existing siding in Town of Caliente. Crosses approximately twice the amount of private lands than the primary alignment. Crosses 2 ROWs – 1 telephone and 1 road (U.S. 93).
Crestline Option ^c	Connects with Union Pacific line near east end of existing siding at Crestline. Crosses approximately twice the private land as the corridor. Crosses 2 ROWs – 1 telephone and 1 road.
White River Alternate ^c	Avoids potential conflict of the corridor with Weepah Spring Wilderness Study Area. Would cross approximately 0.012 square kilometer (3 acres) of private land.
Garden Valley Alternate ^c	Puts more distance between corridor and private lands in Garden Valley and Coal Valley. Crosses 2 road ROWs and 2 pipeline ROWs. Crosses approximately same amount of private land as corridor.
Mud Lake Alternate ^c	Travels farther from west edge of Mud Lake, which has known important archaeological sites. Mud Lake contains 4 possible route variations that are located on BLM lands.
Goldfield Alternate ^c	Avoids crossing Nellis Air Force Range boundary near Goldfield, avoiding potential land-use conflicts with Air Force. Crosses mostly BLM lands but also crosses approximately 0.75 square kilometer of private lands.
Bonnie Claire Alternate ^c	Avoids crossing Nellis Air Force Range boundary near Scottys Junction, avoiding potential land-use conflicts with Air Force. Crosses mostly BLM lands but also crosses approximately 0.43 square kilometer of private property. Crosses a BLM utility corridor, 3 road ROWs, 2 telephone ROWs, and 4 power ROWs. Crosses Timbisha Shoshone trust lands parcel.
Oasis Valley Alternate ^c	Enables flexibility in crossing environmentally sensitive Oasis Valley area. If DOE selected a route through this area, further studies would ensure small environmental impacts.
Beatty Wash Alternate ^c	Provides alternate corridor through Beatty Wash that is longer, but requires less severe earthwork than the corridor.

a. Source: DIRS 131242-CRWMS M&O (1997, all).

b. Abbreviations: BLM = Bureau of Land Management; ROW = right-of-way.

c. Common with Carlin Corridor.

Minority Populations Along Potential Transportation Routes in Nevada

Census Bureau information available to DOE and considered in this EIS includes geographical identification of census blocks containing minority populations within the environmental justice definition used by DOE (that is, a minority population is one in which the percent of the population of an area’s racial or ethnic minority is 44.8 percentage points or more of the total population).

There is no corresponding census block information for low-income populations. To provide the information on minority census blocks to decisionmakers and the public, DOE has prepared a set of maps (Figures J-21 through J-30) showing the location of minority census blocks near potential transportation corridors. The maps depict 6-kilometer bands on each side of each corridor.

Darkly shaded areas represent minority blocks in or near the 6-kilometer bands. Lightly shaded areas represent the balance of land within the 6-kilometer bands. Dotted areas of intermediate shading represent Native American lands. All lands shown on maps and not represented as minority block or Native American is land that does not have a minority population within the definition used in this EIS (see Chapter 3, Section 3.1.13.1) to consider environmental justice concerns.

Table J-42. Possible variations of the Carlin Corridor.^a

Variation	Description ^b
Crescent Valley Alternate	Diverges from the corridor near Cortez Mining Operation where it would cross a proposed pipeline ROW that would supply water to the Dean Ranch; travels through nonagricultural lands adjacent to alkali flats but would affect larger area of private land. Crosses 2 existing roads, one of which has an established ROW.
Wood Spring Canyon Alternate	Diverges from the corridor and use continuous 2-percent grade to descend from Dry Canyon Summit in Toiyabe range; is shorter than the corridor segment but would have steeper grade. Continues on BLM land.
Rye Patch Alternate	Travels through Rye Patch Canyon, which has springs, riparian areas, and game habitats; diverts from the corridor, maintaining distance of 420 meters ^c from Rye Patch Spring and at least 360 meters from riparian areas throughout Rye Patch Canyon, except at crossing of riparian area near south end of canyon; avoids game habitat (sage grouse strutting area). Passes through a BLM utility corridor, one road and one road ROW (U.S. 50).
Steiner Creek Alternate	Diverges from the corridor at north end of Rye Patch Canyon. Avoids crossing private lands, two known hawk-nesting areas, and important game habitat (sage grouse strutting area) in the corridor. Passes close to Steiner Creek WSA.
Smoky Valley Option	Travels through less populated valley than Monitor Valley Option. Crosses more ROWs than Monitor Valley Option. Passes through all BLM land until route enters NTS. Passes through a Desert Land Entry area.
Monitor Valley Option	Travels through less populated Monitor Valley (in comparison to Big Smoky Valley). Crosses the Monitor, Ralston, and Potts grazing allotments. Also passes through 2 areas with application to Desert Land Entry Program. Passes 2 road ROWs, 1 telephone, 1 pipeline, and 3 powerline ROWs.
Mud Lake Alternate ^d	Travels farther from west edge of Mud Lake, which has known important archaeological sites. Mud Lake contains 4 possible route variations that are located on BLM lands.
Goldfield Alternate ^d	Avoids crossing Nellis Air Force Range boundary near Goldfield, avoiding potential land-use conflicts with Air Force. Crosses mostly BLM lands but also crosses approximately 0.75 square kilometer ^e of private lands.
Bonnie Claire Alternate ^d	Avoids crossing Nellis Air Force Range boundary near Scottys Junction, avoiding potential land-use conflicts with Air Force. Crosses mostly BLM lands but also crosses approximately 0.43 square kilometer of private property. Crosses a BLM utility corridor, 3 road ROWs, 2 telephone ROWs, and 4 power ROWs. Crosses Timbisha Shoshone trust lands parcel.
Oasis Valley Alternate ^d	Enables flexibility in crossing environmentally sensitive Oasis Valley area. If DOE selected a route through this area, further studies would ensure small environmental impacts.
Beatty Wash Alternate ^d	Provides alternate corridor through Beatty Wash that is longer, but requires less severe earthwork than the corridor.

a. Source: DIRS 131242-CRWMS M&O (1997, all).

b. Abbreviations: BLM = Bureau of Land Management; NTS = Nevada Test Site; ROW = right-of-way; WSA = Wilderness Study Area.

c. To convert meters to feet, multiply by 3.2808.

d. Common with Caliente corridor.

e. To convert square kilometers to acres, multiply by 247.1.

Although the populations of most census blocks are small, the size of many blocks is large. The depiction of minority blocks does not show the location of any residences within blocks. Census bureau data did not include residential locations. No inference should be drawn from these maps as to the location of residences within depicted areas.

Table J-43. Possible variations of the Caliente-Chalk Mountain Corridor.

Variation	Description
Caliente Option	Same as Table J-41. Connects with Union Pacific Line at existing siding in Town of Caliente.
Eccles Option	Same as Table J-41.
Orange Blossom Option	Crosses Nevada Test Site land. Bypasses roads and facilities.
Crestline Option	Same as Table J-41. Connects with Union Pacific line near east end of existing siding at Caliente.
White River Alternate	Same as Table J-41. Avoids potential conflict with Weepah Springs Wilderness Study Area.
Garden Valley Alternate	Same as Table J-41. Puts more distance between rail corridor and private lands in Garden Valley and Coal Valley.
Mercury Highway Option	To provide flexibility in choosing path through Nevada Test Site, travels north through center of Nevada Test Site. Requires slightly less land [approximately 0.2 square kilometers (50 acres)] than corridor. Crosses Mercury Highway.
Topopah Option	To provide flexibility in choosing path through Nevada Test Site, travels north along western boundary of Nevada Test Site.
Mine Mountain Alternate	Provides flexibility in minimizing impacts to local archaeological sites.
Area 4 Alternate	Provides flexibility in choosing path through Nevada Test Site. Crosses Mercury Highway. Requires slightly less land.

a. Source: DIRS 155628-CRWMS M&O (1997, all).

J.3.1.3 Sensitivity of Analysis Results to Routing Assumptions

In addition to analyzing the impacts of using highway routes that would meet U.S. Department of Transportation requirements for transporting spent nuclear fuel, DOE evaluated how the estimated impacts would differ if legal-weight trucks used other routes in Nevada. Six other routes identified in a 1989 study by the Nevada Department of Transportation (DIRS 103072-Ardila-Coulson 1989, pp. 36 and 45) were selected for this analysis. The Nevada Department of Transportation study described the routes as follows:

Route A. Minimum distance and minimum accident rate.

South on U.S. 93A, south on U.S. 93, west on U.S. 6, south on Nevada 318, south on U.S. 93, south on I-15, west on Craig Road, north on U.S. 95

Route B. Minimum population density and minimum truck accident rate.

Both of these two routes use the U.S. 6 truck bypass in Ely.

Alternative route possibilities were identified between I-15 at Baker, California and I-40 at Needles, California to Mercury. These alternative routes depend upon the use of U.S. 95 in California, California 127 and the Nipton Road.

Route C. From Baker with California 127.

North on California 127, north on Nevada 373, south on U.S. 95

Route D. From Baker without California 127.

North on I-15, west on Nevada 160, south on U.S. 95

Route E. From Needles with U.S. 95, California 127, and the Nipton Road.

North on U.S. 95, west on Nevada 164, west on I-15, north on California 127, north on Nevada 373, south on U.S. 95

Route F. From Needles without California 127 and the Nipton Road.

West on I-40, east on I-15, west on Nevada 160, south on U.S. 95

Table J-44. Possible variations of the Jean Corridor.^a

Variation	Description ^b
North Pahrump Valley Alternate	Minimizes impacts to approximately 4 kilometers ^c of private land on northeast side of Pahrump. Abuts Toiyabe National Forest and a BLM corridor. Travels within a BLM utility corridor. Crosses approximately twice as much BLM lands as corridor and 0.0999 square kilometer ^d of private land compared to 3.5 square kilometers.
Wilson Pass Option	Crosses 2 pipeline ROWs, 3 road/highway ROWs, 2 powerline ROWs. Enter BLM utility corridor for approximately 46 kilometers. Passes within 1.6 kilometers of Toiyabe National Forest and close to 3 mines. Also passes through BLM Class II visual resource lands.
Stateline Pass Option	Provides option to crossing Spring Mountains at Wilson Pass; diverges from corridor in Pahrump Valley; parallels Nevada-California border, traveling along southwestern edge of Spring Mountains and crossing border twice. Bypasses private land crossed by primary alignment. Origination of option would conflict with the proposed Ivanpah Valley Airport. Crosses 2 pipeline ROWs, 2 road ROWs, 1 powerline, 1 telephone ROW, 1 withdrawal area (unexplained), a BLM utility corridor, and 1 community pit. Passes close to Stateline WSA. Crosses Black Butte and Roach Lake grazing allotments.

- a. Source: DIRS 131242-CRWMS M&O (1997, all).
- b. Abbreviations: BLM = Bureau of Land Management; ROW = right-of-way; WSA = Wilderness Study Area.
- c. To convert kilometers to miles, multiply by 0.62137.
- d. To convert square kilometers to acres, multiply by 247.1.

Table J-45. Possible variations of the Valley Modified Corridor.^a

Variation	Description ^b
Indian Hills Alternate	Avoids entrance to Nellis Air Force Range north of Town of Indian Springs by traveling south of town. U.S. Fish and Wildlife Service land. Crosses 1 road, 2 telephone, and 2 powerline ROWs. Passes almost entirely within BLM utility corridor. Passes through a land withdrawal area.
Sheep Mountain Alternate	Increases distance from private land in Las Vegas and proposed 30-square-kilometer ^c BLM land exchange with city. Crosses small parcels (approximately 0.18 square kilometer) of private land. Crosses 3 powerline ROWs. Passes through Nellis Small Arms Range, Nellis WSAs A, B, and C, the Desert National Wildlife Range, and the Quail Spring WSA.
Valley Connection	Locates transfer operations at Union Pacific Valley Yard rather than Dike siding. Overflights of Dike siding from Nellis Air Force Base could conflict with switching operations. Crosses slightly more private land.

- a. Source: DIRS 131242-CRWMS M&O (1997, all).
- b. Abbreviations: BLM = Bureau of Land Management; ROW = right-of-way; WSA = Wilderness Study Area.
- c. To convert square kilometers to acres, multiply by 247.1.

Table J-46 identifies the sensitivity cases evaluated based on the Nevada Department of Transportation routes. Tables J-47 and J-48 list the range of impacts in Nevada of using these different routes for the mostly legal-weight truck analysis scenario. The tables compare the impacts estimated for the highways identified in the Nevada study to those estimated for shipments that would follow routes allowed by current U.S. Department of Transportation regulations for Highway Route-Controlled Quantities of Radioactive Materials. Because the State of Nevada has not designated alternative or additional preferred routes for use by these shipments, as permitted under U.S. Department of Transportation regulations (49 CFR 397.103), DOE has assumed that shipments of spent nuclear fuel and high-level radioactive waste would enter Nevada on I-15 from either the northeast or southwest. The analysis assumed that shipments traveling on I-15 from the northeast would use the northern Las Vegas Beltway to connect to U.S. 95 and continue to the Nevada Test Site. Shipments from the southwest on I-15 would use the southern and western Las Vegas Beltway to connect to U.S. 95 and continue to the Nevada Test Site.

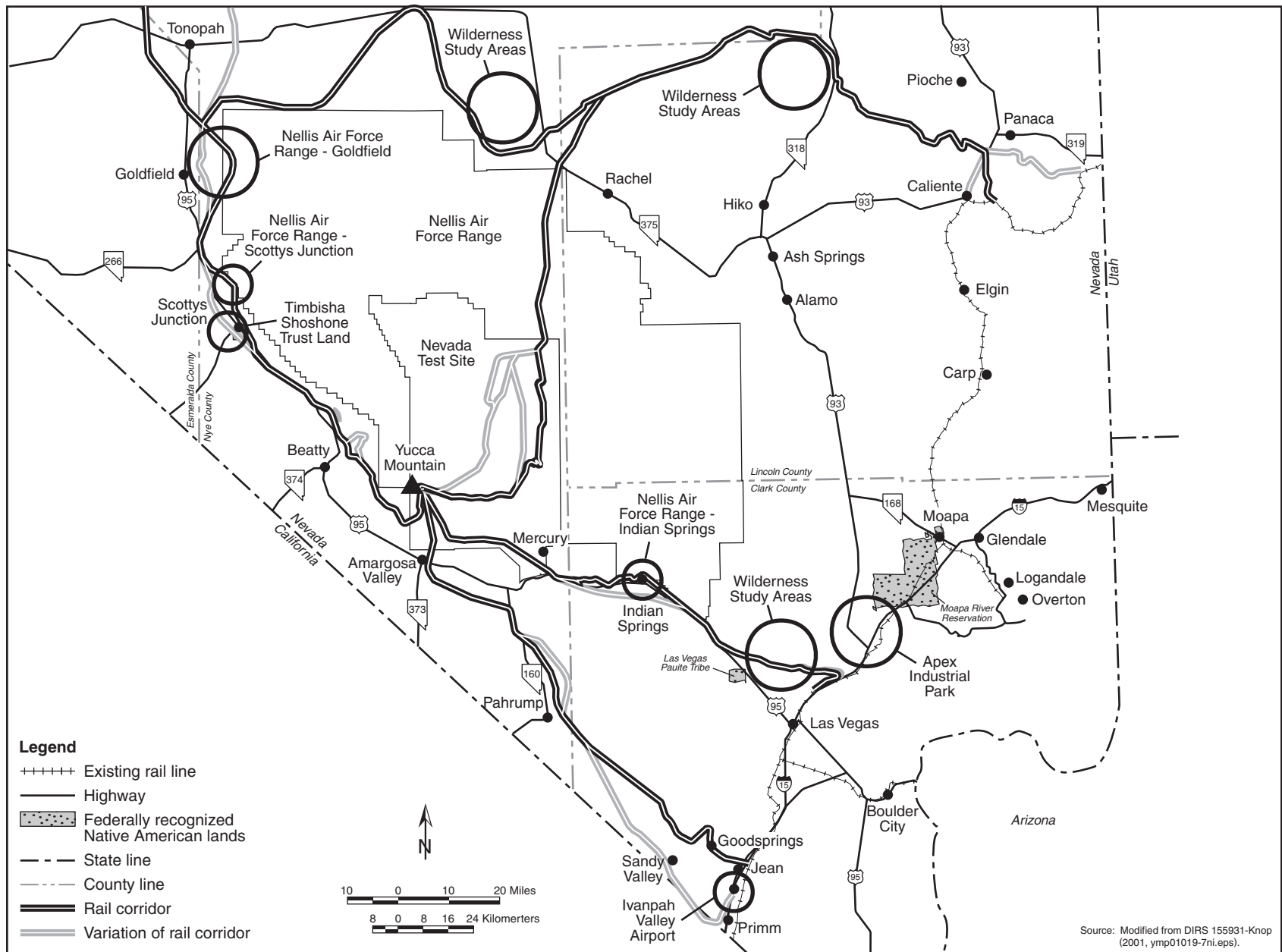

Figure J-13. Land-use conflicts along Nevada rail corridors, overview.

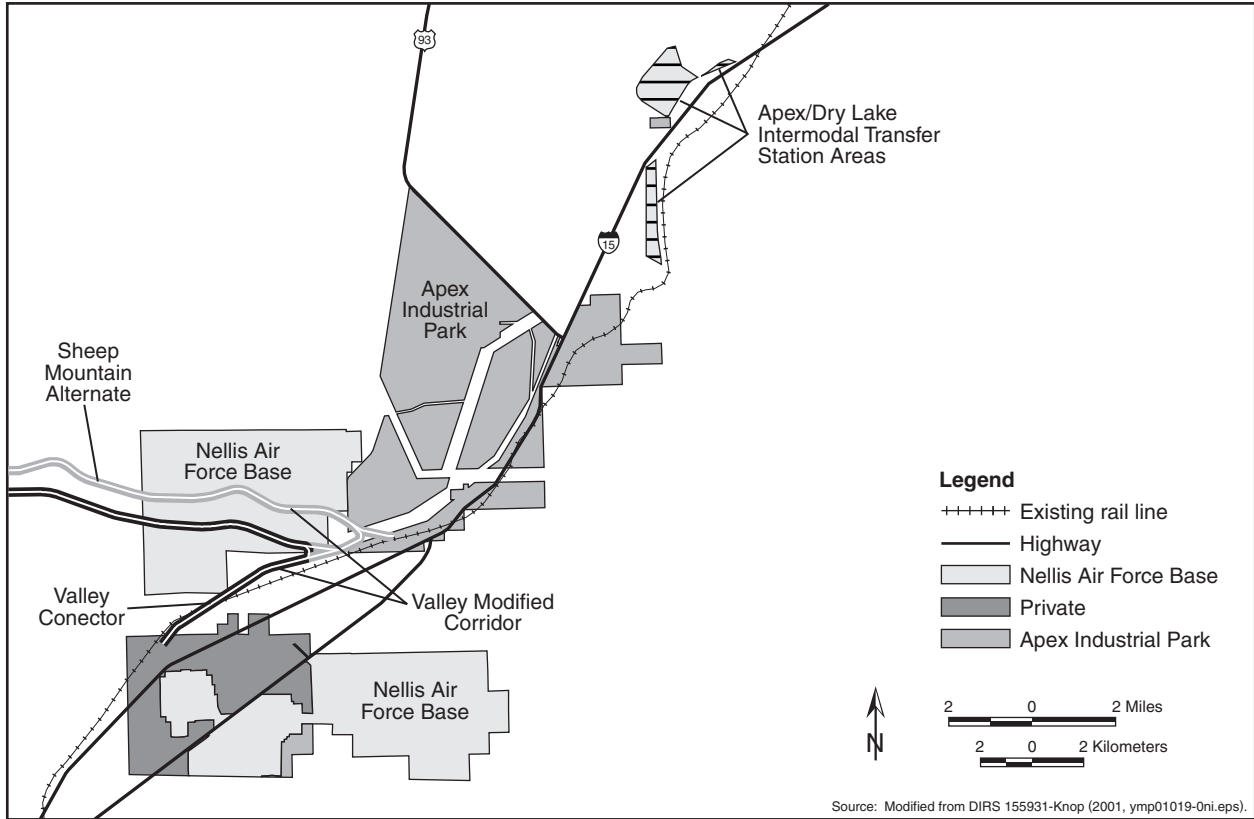

Figure J-14. Land-use conflicts along Nevada rail corridors, Apex Industrial Park.

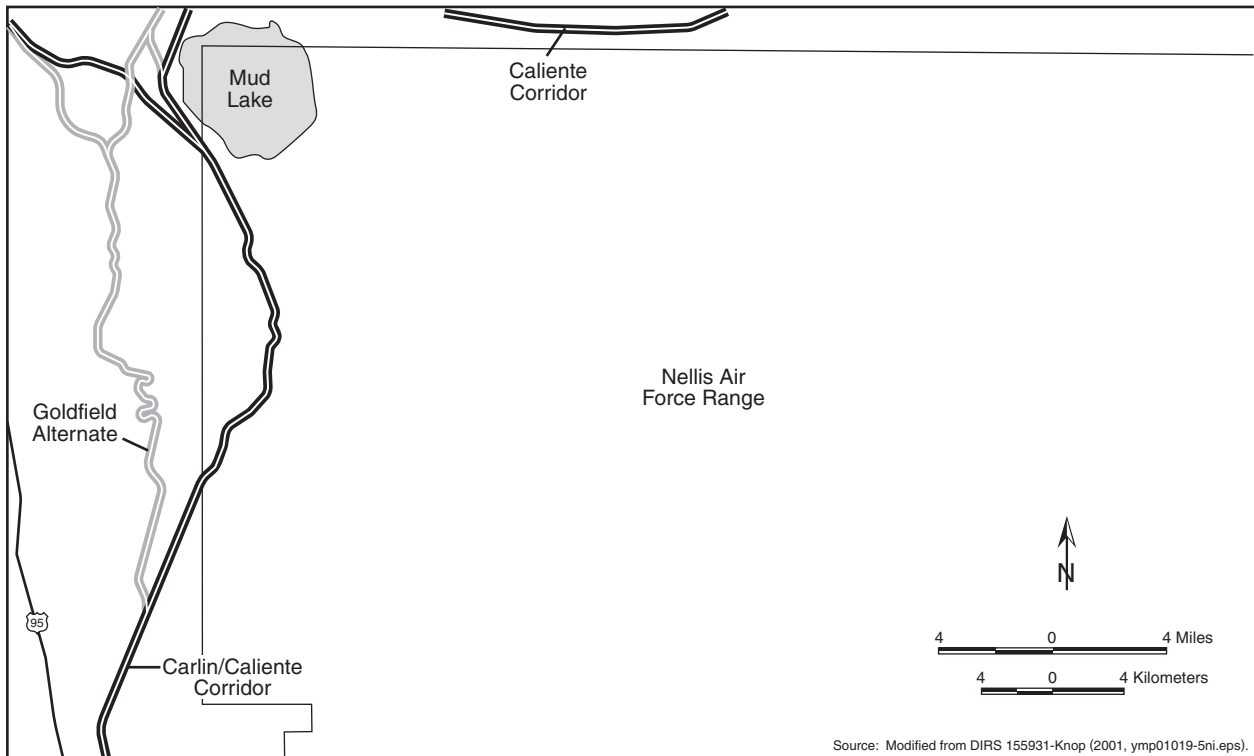

Figure J-15. Land-use conflicts along Nevada rail corridors, Nellis Air Force Range, Goldfield area.

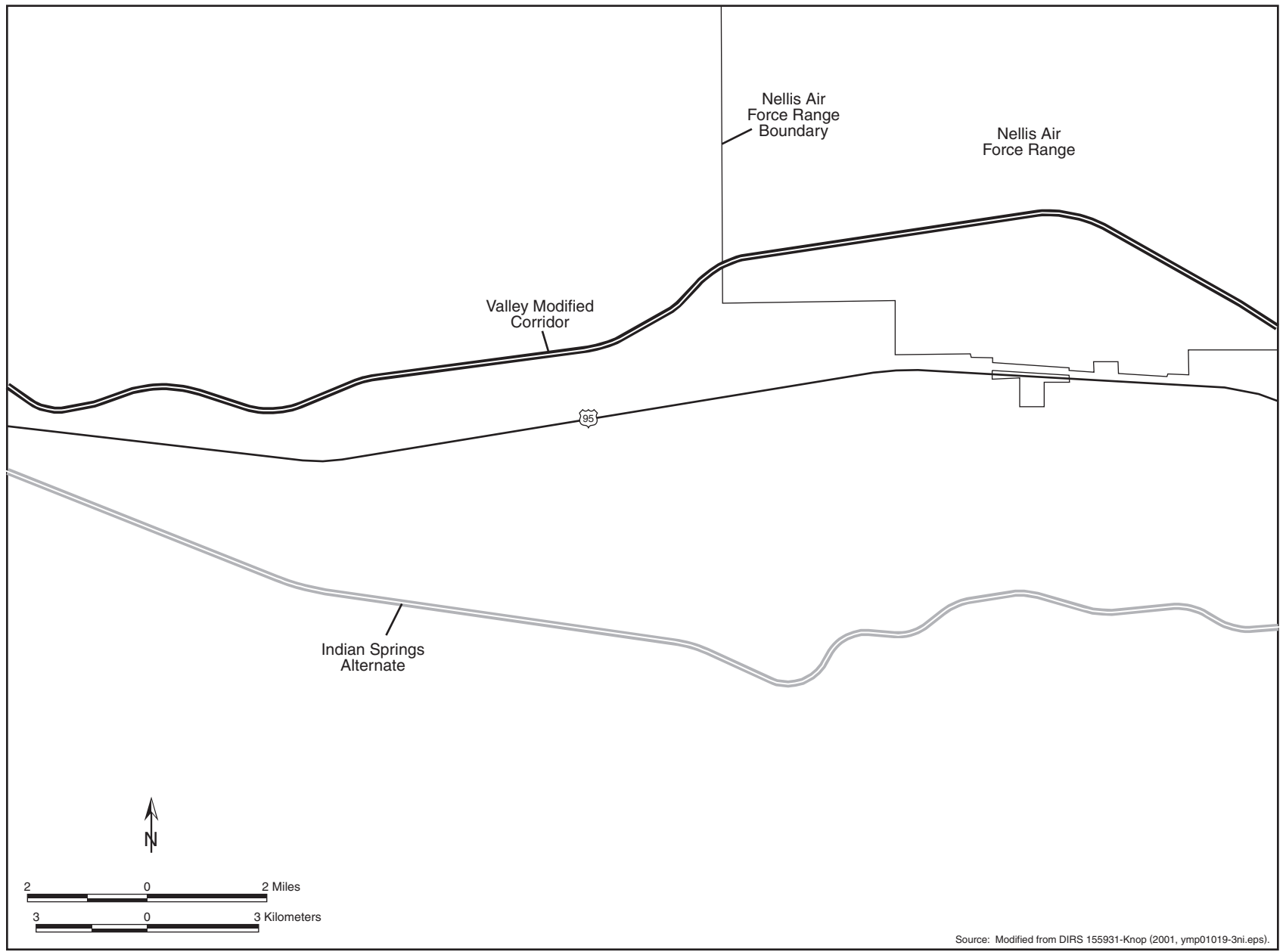

Figure J-16. Land-use conflicts along Nevada rail corridors, Nellis Air Force Range, Indian Springs area.

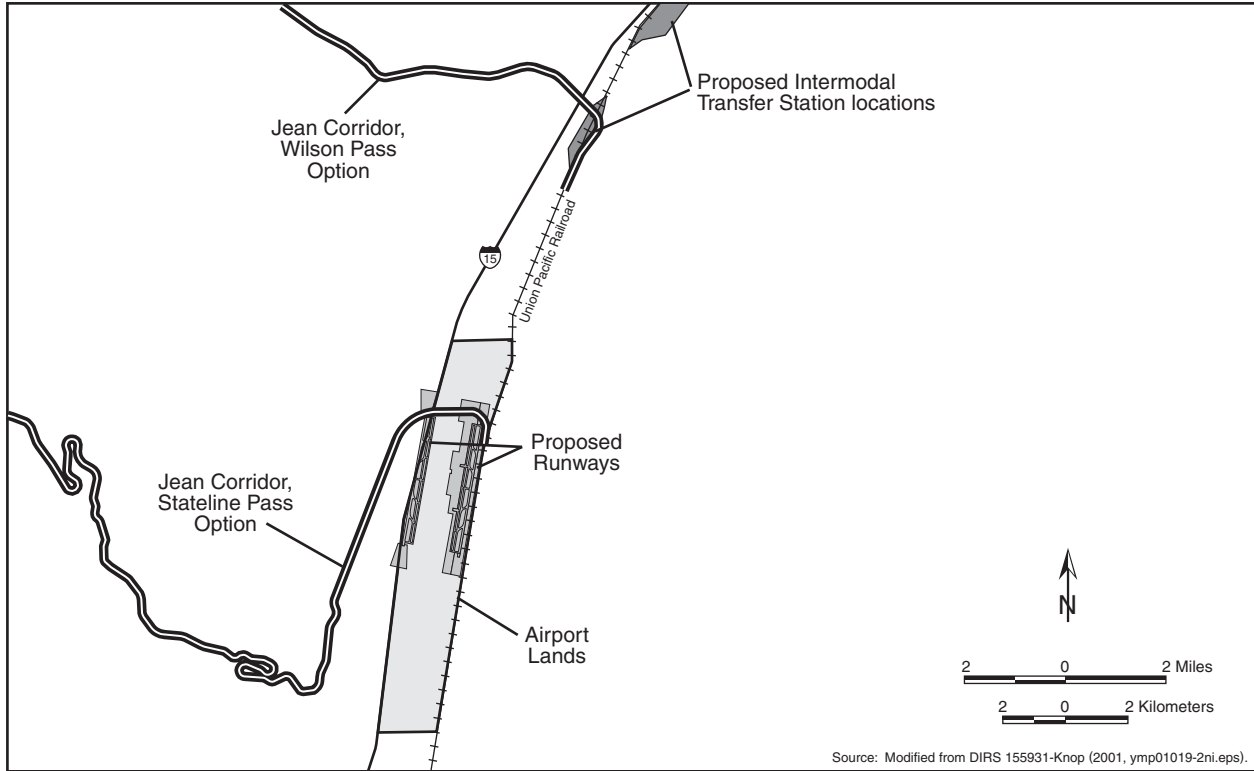

Figure J-17. Land-use conflicts along Nevada rail corridors, Ivanpah Valley Airport Public Lands Transfer Act.

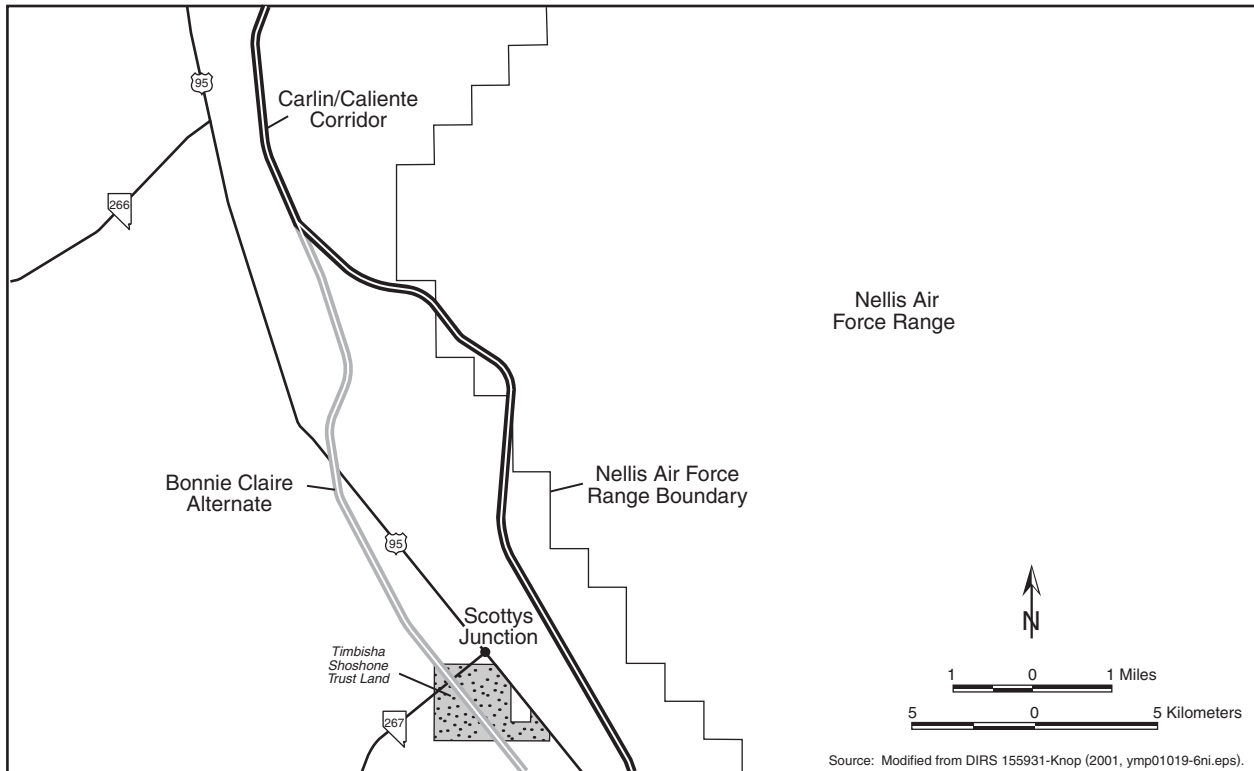
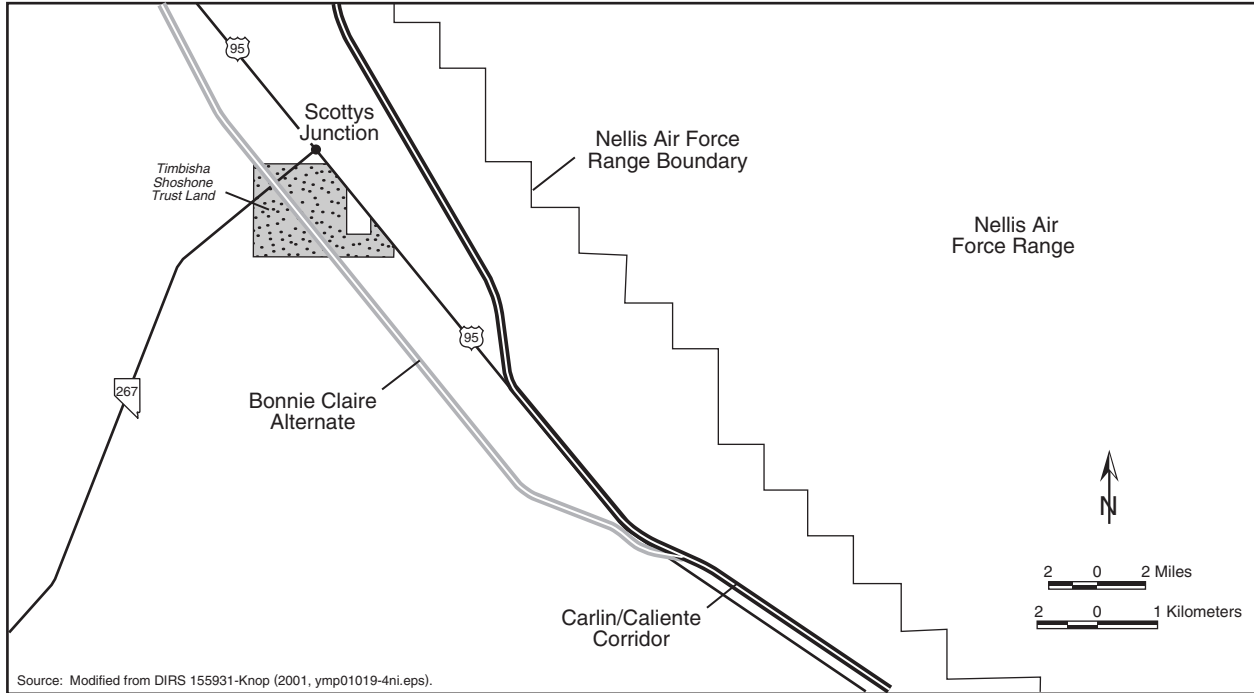
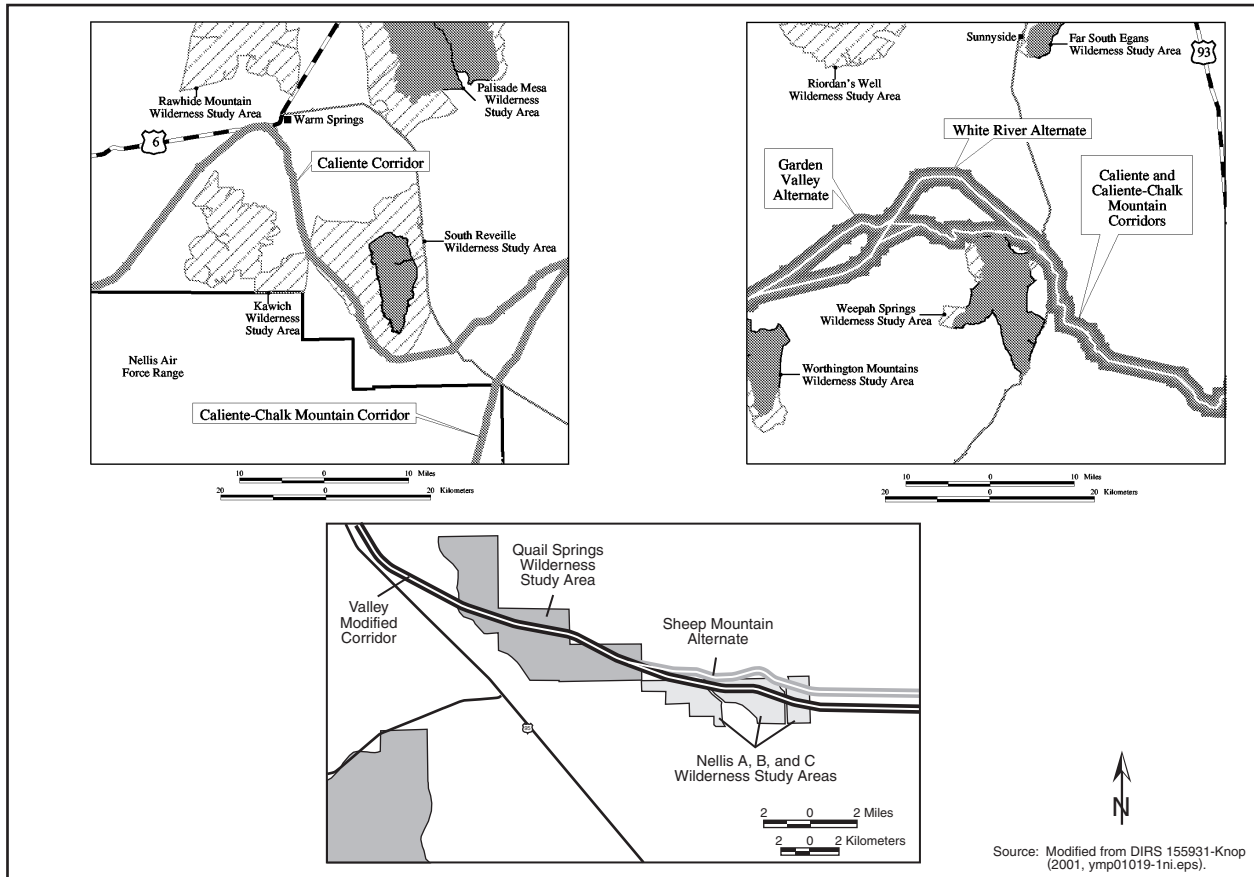

Figure J-18. Land-use conflicts along Nevada rail corridors, Nellis Air Force Range, Scottys Junction area.



Source: Modified from DIRS 155931-Knop (2001, ymp01019-4ni.eps).

Figure J-19. Land-use conflicts along Nevada rail corridors, Timbisha Shoshone Trust Lands.



Source: Modified from DIRS 155931-Knop (2001, ymp01019-1ni.eps).

Figure J-20. Land-use conflicts along Nevada rail corridors, Wilderness Study Areas.

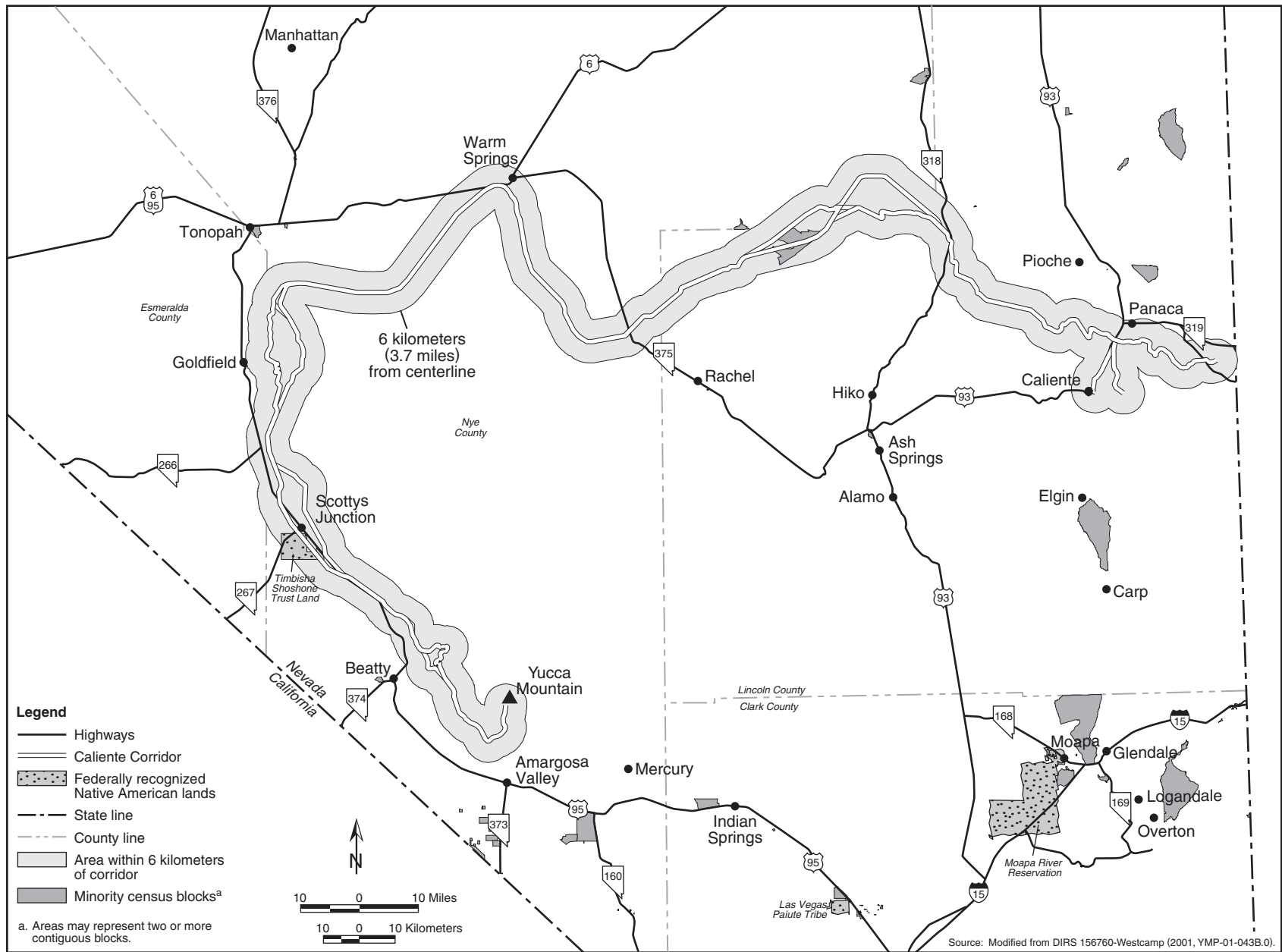

Figure J-21. Nevada minority census blocks in relation to the Caliente Corridor.

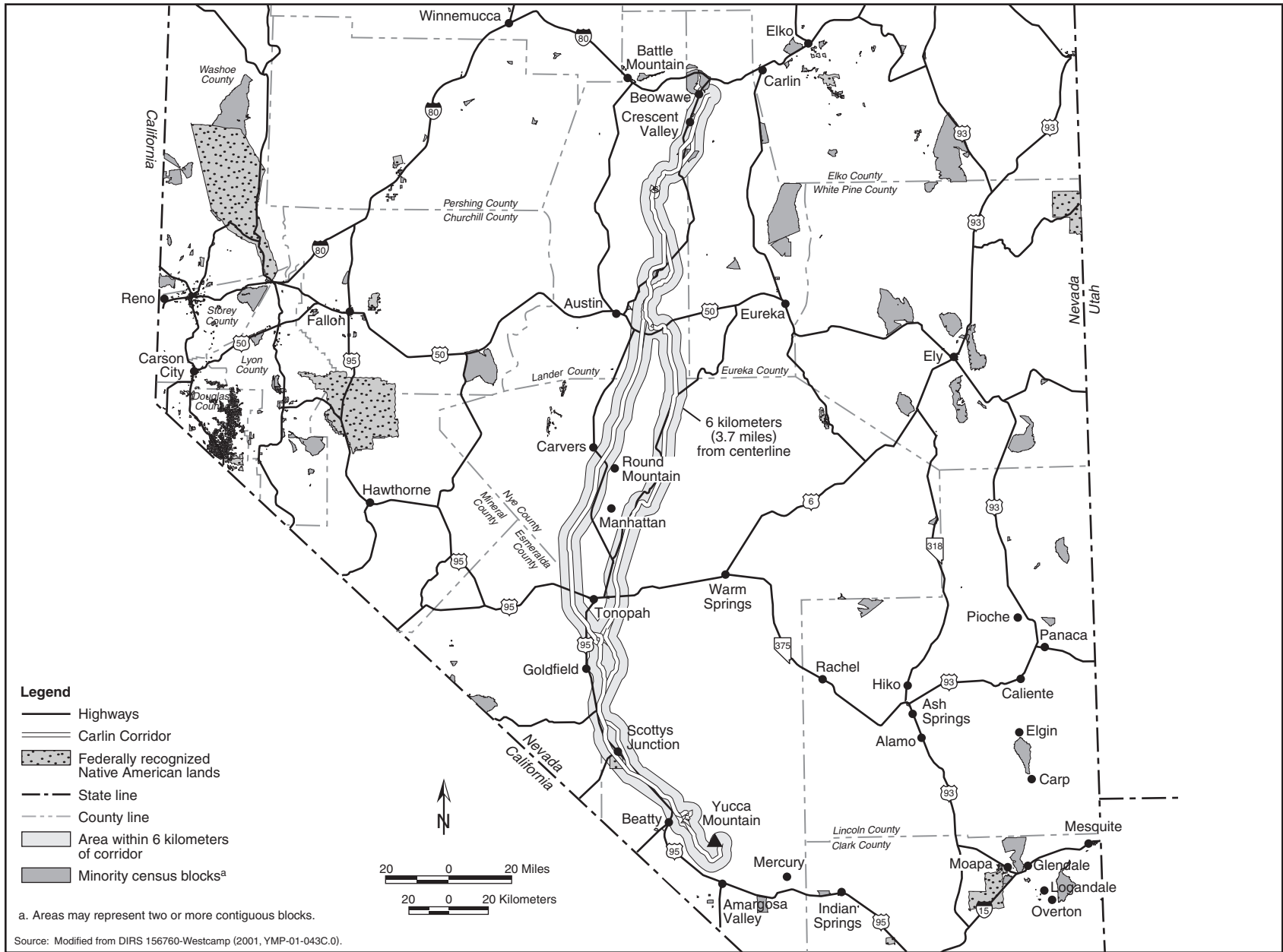

Figure J-22. Nevada minority census blocks in relation to the Carlin Corridor.

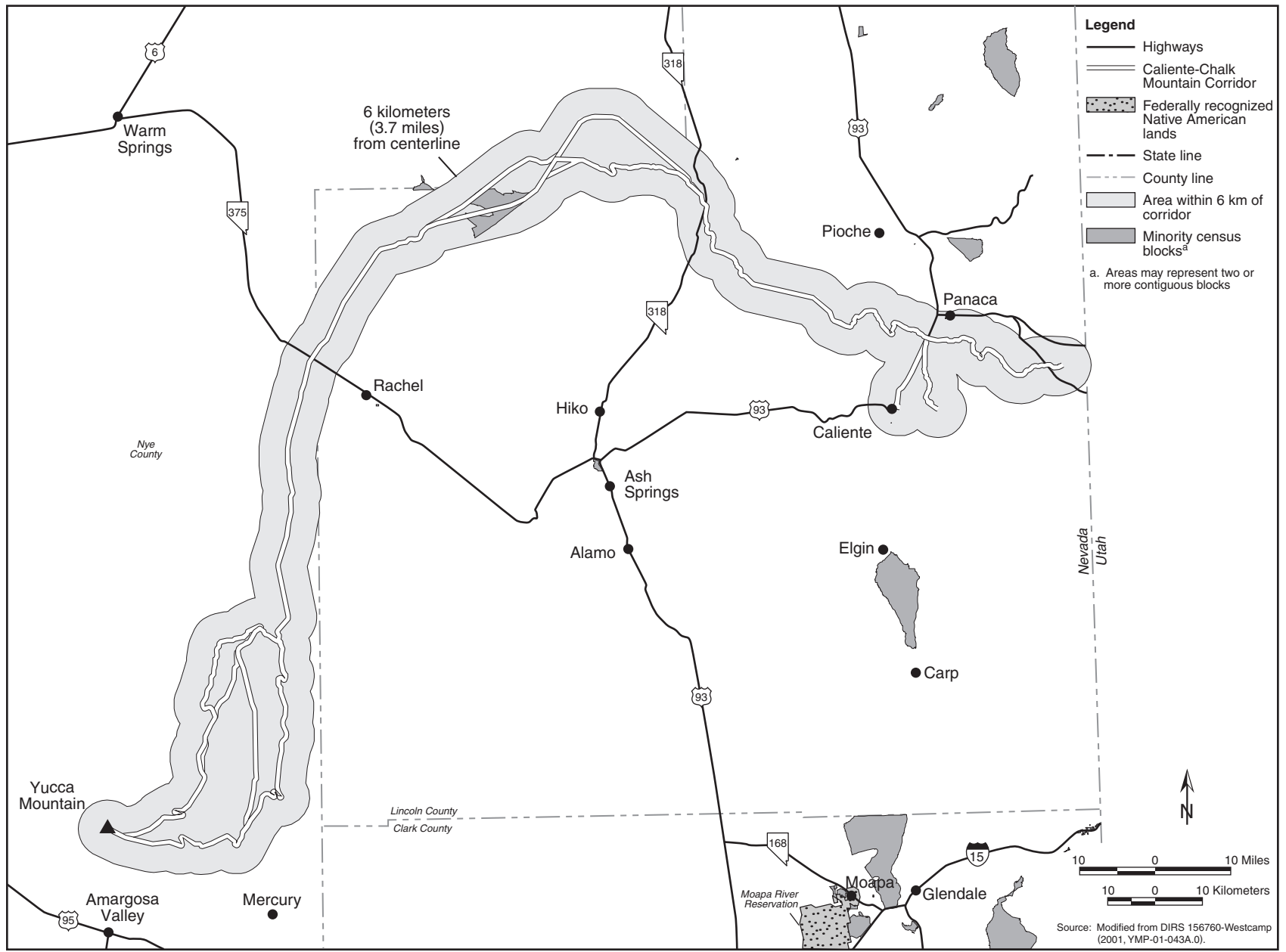

Figure J-23. Nevada minority census blocks in relation to the Caliente-Chalk Mountain Corridor.

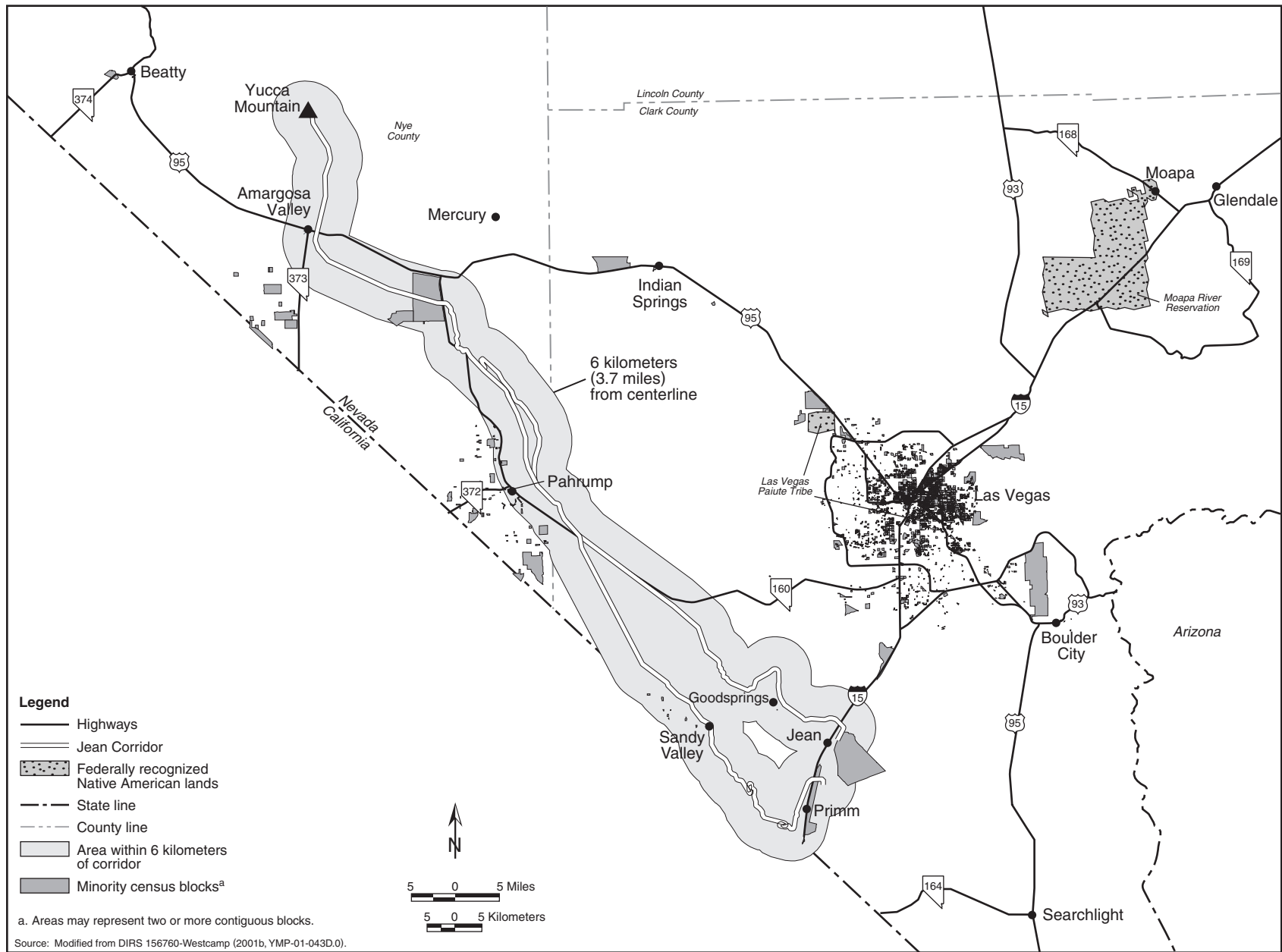

Figure J-24. Nevada minority census blocks in relation to the Jean Corridor.

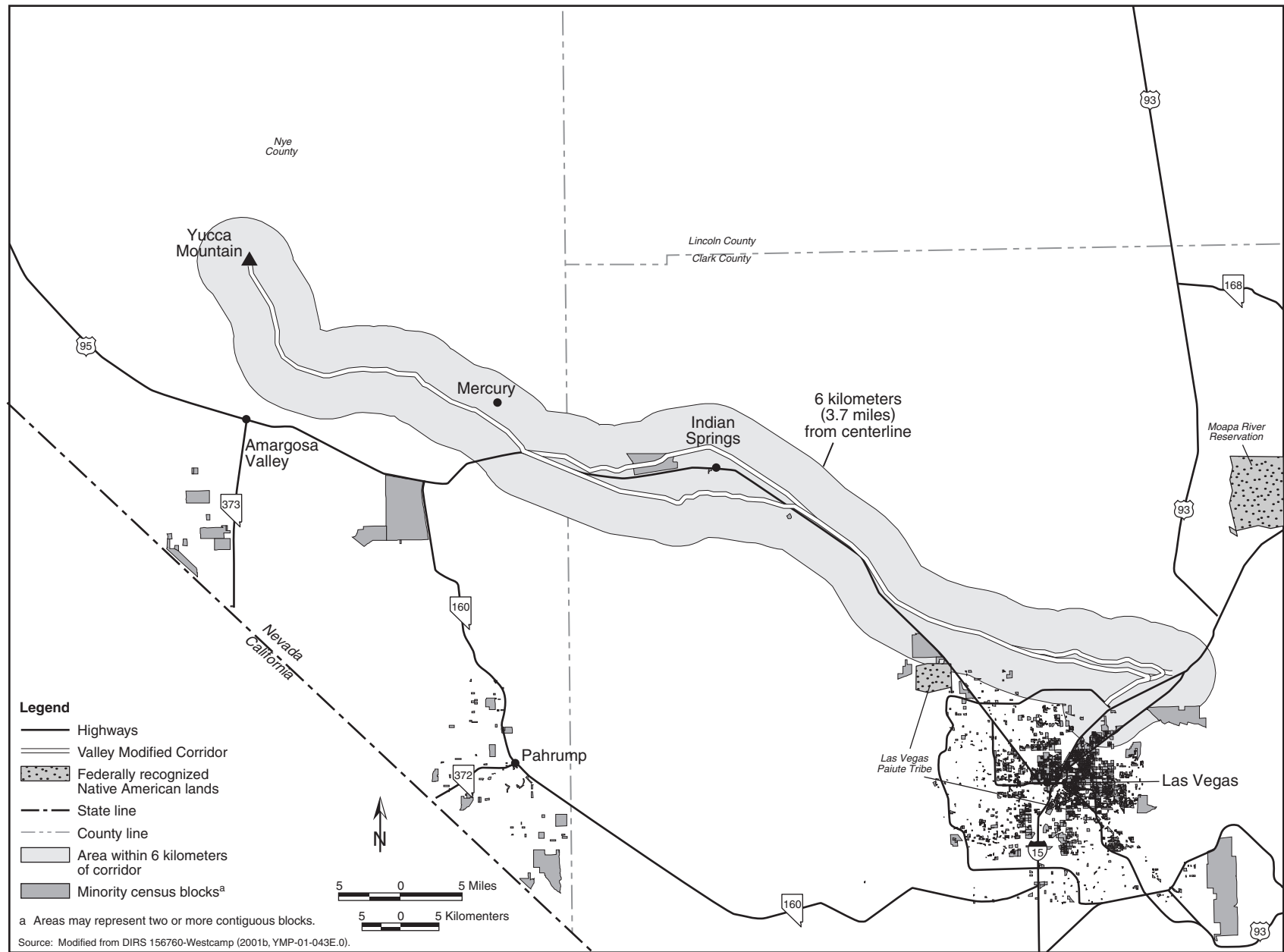

Figure J-25. Nevada minority census blocks in relation to the Valley Modified Corridor.

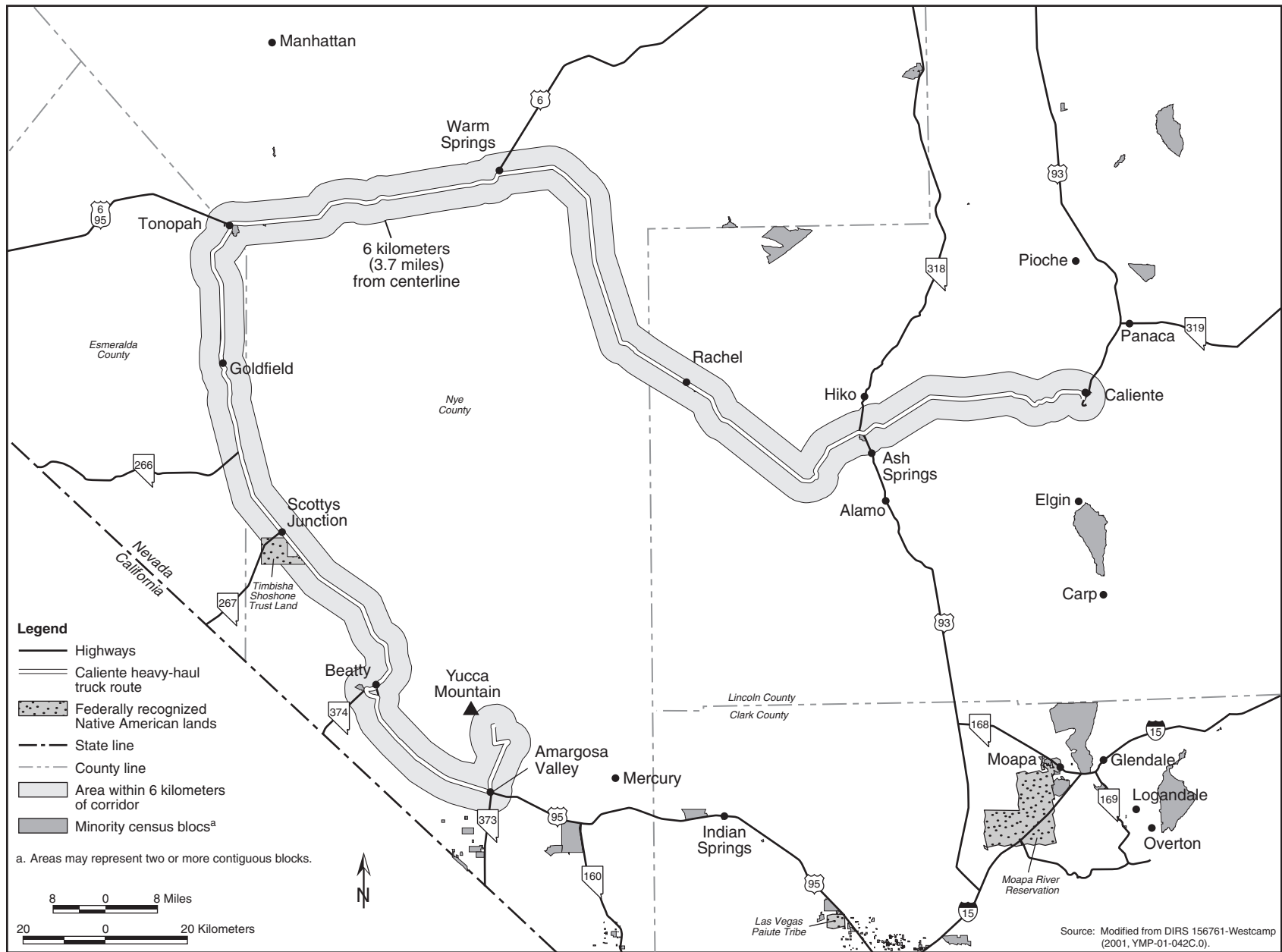

Figure J-26. Nevada minority census blocks in relation to the Caliente heavy-haul truck implementing alternative.

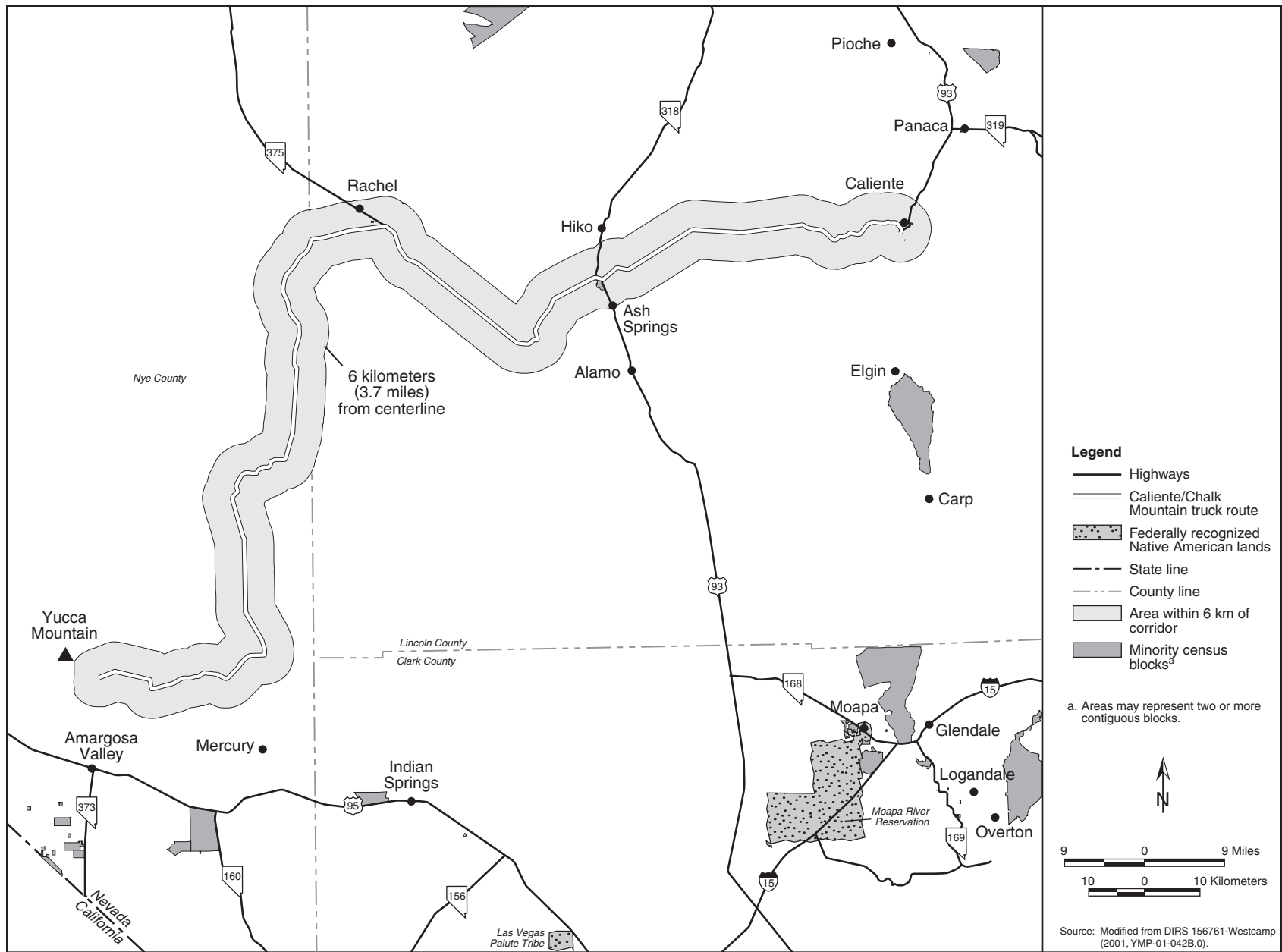

Figure J-27. Nevada minority census blocks in relation to the Caliente/Chalk Mountain route for heavy-haul trucks.

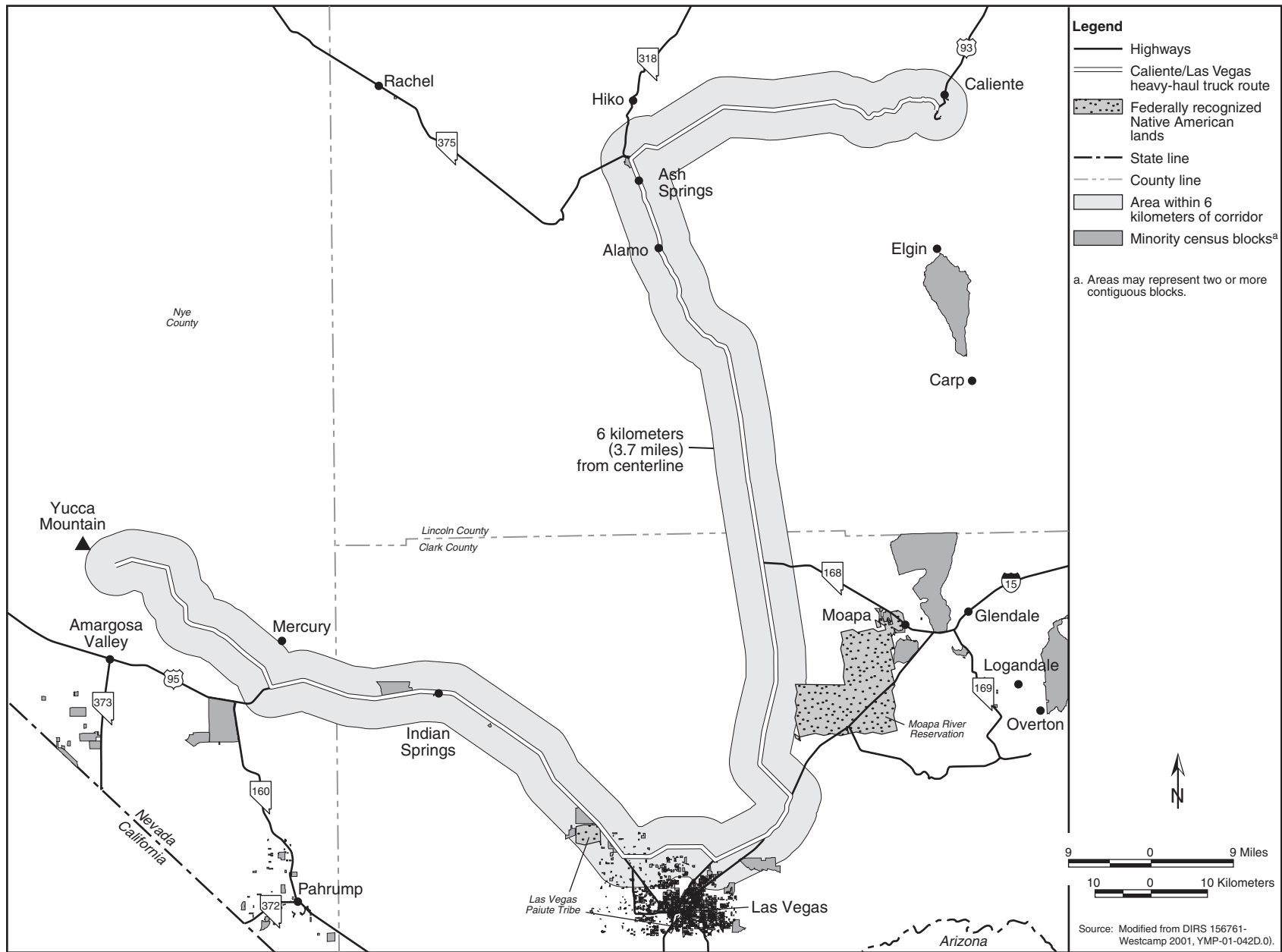

Figure J-28. Nevada minority census blocks in relation to the Caliente/Las Vegas route for heavy-haul trucks.

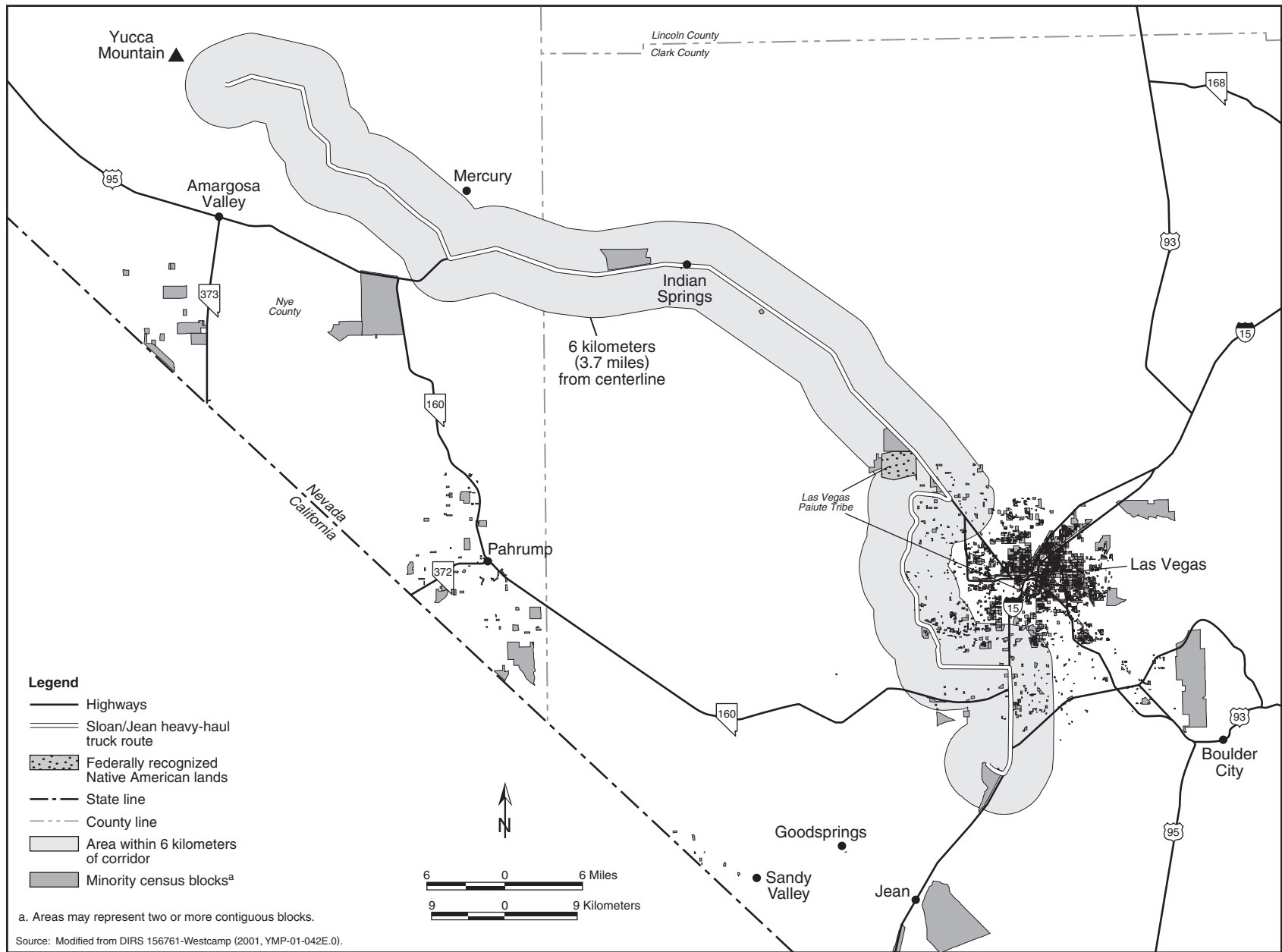

Figure J-29. Nevada minority census blocks in relation to the Sloan/Jean route for heavy-haul trucks.

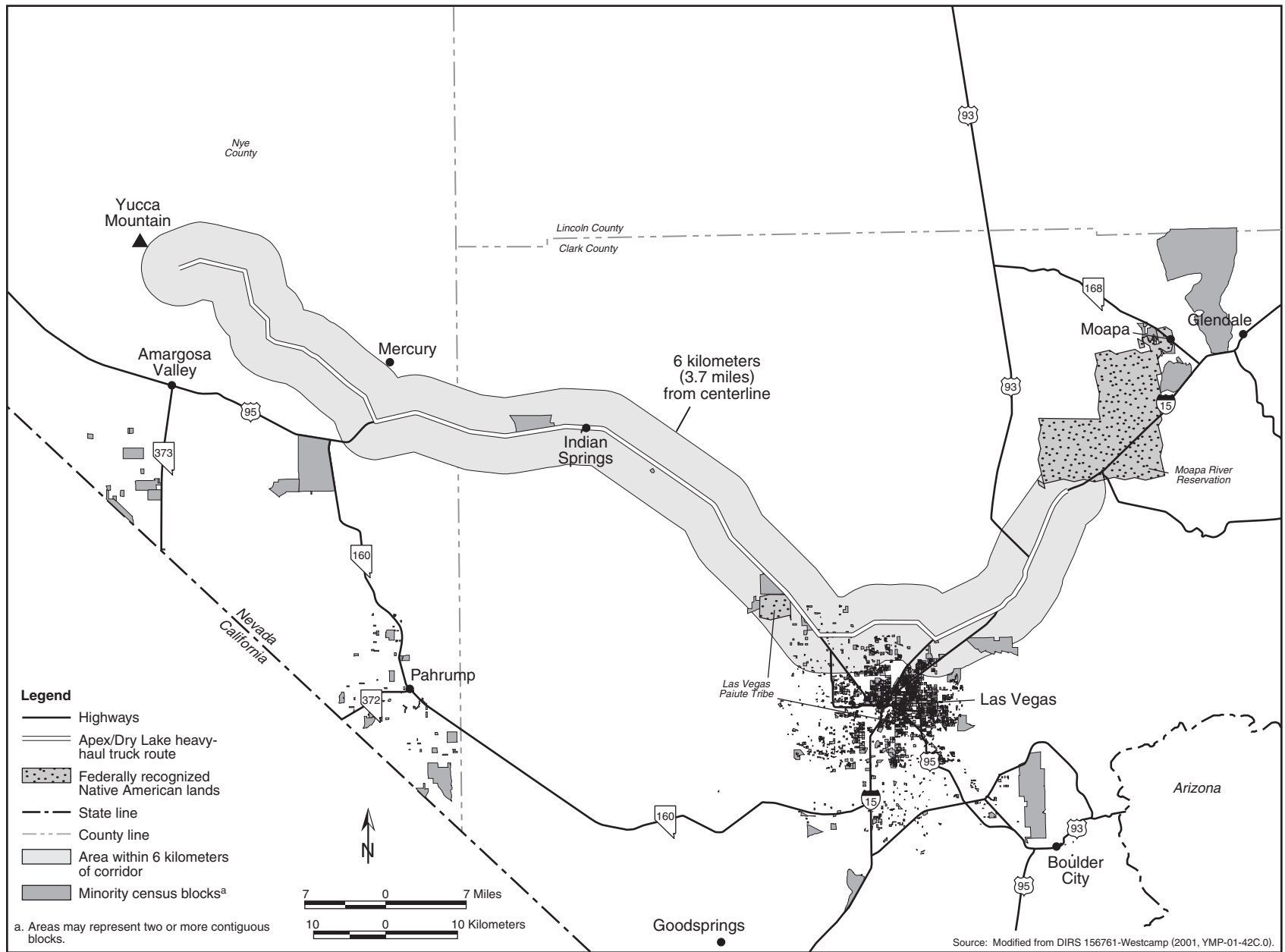

Figure J-30. Nevada minority census blocks in relation to the Apex/Dry Lake route for heavy-haul trucks.

Table J-46. Nevada routing sensitivity cases analyzed for a legal-weight truck.

Case	Description
Case 1	To Yucca Mountain via Barstow, California, using I-15 to Nevada 160 to Nevada 160 (Nevada D and F)
Case 2	To Yucca Mountain via Barstow using I-15 to California route 127 to Nevada 373 to US 95 (Nevada C)
Case 3	To Yucca Mountain via Needles using U.S. 95 to Nevada 164 to I-15 to California 127 to Nevada 373 and U.S. 95 (Nevada E)
Case 4	To Yucca Mountain via Needles using U.S. 95 to Nevada 164 to I-15 to Nevada 160 (variation of Nevada E)
Case 5	To Yucca Mountain via Wendover using U.S. 93 Alternate to U.S. 93 to U.S. 6 to U.S. 95 (Nevada B)
Case 6	To Yucca Mountain via Wendover using U.S. 93 Alternate to U.S. 93 to Nevada 318 to U.S. 93 to I-15 to the Las Vegas Beltway to U.S. 95 (Nevada A)
Case 7	To Yucca Mountain via Las Vegas using I-15 (for shipments entering Nevada at both the Arizona and California borders) to U.S. 95 (Spaghetti Bowl interchange)

J.3.2 ANALYSIS OF INCIDENT-FREE TRANSPORTATION IN NEVADA

The analysis of incident-free impacts to populations in Nevada addressed transportation through urban, suburban, and rural population zones. The population densities used in the analysis were determined using Geographic Information System methods, population data from the 1990 Census, and projected populations along the Las Vegas Beltway (DIRS 155112-Berger 2000, pp. 59 to 64). The analysis extrapolated impacts to account for population growth to 2035. The populations within the 800-meter (0.5-mile) regions of influence used to evaluate the impacts of incident-free transportation for legal-weight truck, heavy-haul truck, and rail shipments are listed in Table J-35. The table lists the estimated 2035 populations.

Average highway vehicle densities for Nevada were calculated from vehicle traffic counts on Interstate and primary U.S. highways in Nevada counties that would be used for transporting spent nuclear fuel and high-level radioactive waste (DIRS 156930-NDOT 2001, all). The analysis used the average speed of trains on a branch rail line in Nevada from (DIRS 101214-CRWMS M&O 1996, Volume 1, Section 4, Branch Line Operations Plan). Heavy-haul trucks in Nevada would be escorted. The analysis assumed that heavy-haul truck shipments would originate in Caliente, Nevada, and would stop overnight en route to the repository. Input parameters for analysis of incident-free transportation in Nevada that differ from, or are additional to, values used to analyze impacts outside the State, are listed in Table J-49. Parameters not listed in this table are the same as those listed in Tables J-15 and J-17. Unit risk factors for incident-free transportation in Nevada are listed in Table J-50.

Results for incident-free transportation of spent nuclear fuel and high-level radioactive waste for Inventory Modules 1 and 2 are presented in Section J.3.4.

J.3.3 ANALYSIS OF TRANSPORTATION ACCIDENT SCENARIOS IN NEVADA

Section J.1.4 discusses the methodology for estimating the risks of accidents that could occur during rail and truck transportation of spent nuclear fuel and high-level radioactive waste. Section J.3.5 describes the results of the accident risk analysis for Inventory Modules 1 and 2.

J.3.3.1 Intermodal Transfer Station Accident Methodology

Shipping casks would arrive at an intermodal transfer station in Nevada by rail, and a gantry crane would transfer them from the railcars to heavy-haul trucks for transportation to the repository. The casks, which would not be opened or altered in any way at the intermodal transfer station, would be certified by the Nuclear Regulatory Commission and would be designed for accident conditions specified in 10 CFR Part 71. Impact limiters, which would protect casks against collisions during transportation, would remain in place during transfer operations at the intermodal transfer station.

Table J-47. Comparison of national impacts from the sensitivity analyses.

Impact	Base case	Case 1	Case 2	Case 3	Case 4	Case 5	Case 6	Case 7
		Barstow via Nevada 160	Barstow via California 127	Needles via Nevada 160	Needles via U.S. 95	Wendover via U.S. 95	Wendover via Las Vegas Beltway	I-15 and U.S. 95 (Spaghetti Bowl)
Public incident-free dose (person-rem)	5,000	5,200	5,100	4,900	5,000	4,600	4,800	5,100
Occupational incident-free dose (person-rem)	14,000	15,000	15,000	14,000	14,000	15,000	15,000	14,000
Nonradioactive pollution health effects	0.93	0.93	0.93	0.89	0.88	0.79	0.81	1.1
Public incident-free risk of latent cancer fatality	2.5	2.6	2.6	2.4	2.5	2.3	2.4	2.6
Occupational incident-free risk of latent cancer fatality	5.6	6	5.8	5.6	5.7	5.9	5.9	5.6
Radiological accident risk (person-rem)	0.46	0.36	0.35	0.35	0.35	0.39	0.4	0.52
Radiological accident risk of latent cancer fatality	0.0002	0.0002	0.0002	0.0002	0.0002	0.0002	0.0002	0.0003
Traffic fatalities	4.5	4.5	4.2	4.3	4.2	4.9	5	4.5

Table J-48. Comparison of Nevada impacts from the sensitivity analyses.

Impact	Base case	Case 1	Case 2	Case 3	Case 4	Case 5	Case 6	Case 7
		Barstow via Nevada 160	Barstow via California 127	Needles via Nevada 160	Needles via U.S. 95	Wendover via U.S. 95	Wendover via Las Vegas Beltway	I-15 and U.S. 95 (Spaghetti Bowl)
Public incident-free dose (person-rem)	340	180	35	170	83	360	490	480
Occupational incident-free dose (person-rem)	1,900	1,800	1,200	1,800	1,400	3,400	3,500	1,900
Nonradioactive pollution health effects	0.09	0.01	<0.005	0.01	<0.005	0.03	0.04	0.21
Public incident-free risk of latent cancer fatality	0.17	0.09	0.02	0.08	0.04	0.18	0.24	0.24
Occupational incident-free risk of latent cancer fatality	0.75	0.72	0.47	0.7	0.54	1.4	1.4	0.74
Radiological accident risk (person-rem)	0.052	0.005	0.002	0.004	0.002	0.015	0.027	0.11
Radiological accident risk of latent cancer fatality	0.000026	0.000003	0.000001	0.000002	0.000001	0.000008	0.000013	0.000055
Traffic fatalities	0.5	0.4	0.1	0.4	0.2	1.3	1.3	0.5

Table J-49. Input parameters and parameter values used for incident-free Nevada truck and rail transportation different from national parameters.

Parameter	Legal-weight truck	Rail	Heavy-haul truck
<i>Speed (kilometers per hour)^a</i>			
Rural		50	
<i>One-way traffic count (vehicles per hour)</i>			
Rural	(b)		
Suburban	(b)		
Urban	(b)		
<i>Truck crew dose at walkaround inspections</i>			
Distance of crew from cargo (meters) ^c			30
<i>Truck escort dose at walkaround inspections</i>			
Distance of one inspector (meters)			1
Distance of 3 other escorts (meters)			60
<i>Guards at overnight stop^d</i>			
Distance of 4 guards from cargo (meters)			60
Time of overnight stop (hours)			12

- a. To convert kilometers to miles, multiply by 0.62137.
- b. County-specific average traffic counts (DIRS 156930-NDOT 2001, all)
- c. To convert meters to feet, multiply by 3.2808.
- d. Crew and escorts are far enough away from the cargo and shielded sufficiently that they receive no dose from the cargo during the overnight stop. Number of guards and length of overnight stop are assumptions for analysis purposes.

Table J-50. Per-shipment unit risk factors for incident-free transportation of spent nuclear fuel and high-level radioactive waste in Nevada.

Factor	Heavy-haul truck	Rail	Legal-weight truck
<i>Public</i>			
<i>Off-link [rem per (persons per square kilometers) per kilometer]</i>			
Rural	6.24×10^{-8}	5.01×10^{-8}	2.89×10^{-8}
Suburban	6.24×10^{-8}	6.24×10^{-8}	3.18×10^{-8}
Urban	6.24×10^{-8}	1.04×10^{-7}	3.18×10^{-8}
<i>On-link (person-rem per kilometer)^a</i>			
Rural	1.46×10^{-4}	2.00×10^{-7}	1.38×10^{-5}
Suburban	1.12×10^{-4}	1.55×10^{-6}	3.89×10^{-5}
Urban	5.40×10^{-4}	4.29×10^{-6}	1.87×10^{-4}
<i>Residents near rest/refueling stops (rem per (persons per square kilometer) per kilometer)</i>			
Rural	3.96×10^{-9}	1.24×10^{-7}	5.50×10^{-9}
Suburban	3.96×10^{-9}	1.24×10^{-7}	5.50×10^{-9}
Urban	3.96×10^{-9}	1.24×10^{-7}	5.50×10^{-9}
<i>Residents near classification stops [rem per (persons per square kilometer)]</i>			
Suburban	1.59×10^{-5}		
<i>Public near rest/refueling stops (person-rem per kilometer)</i>			
			7.86×10^{-6}
<i>Workers</i>			
Classification stop (person-rem)		8.07×10^{-3}	
In-transit stop (person-rem per kilometer)		1.45×10^{-5}	
<i>In moving vehicle (person-rem per kilometer)</i>			
Rural	5.54×10^{-6}		4.52×10^{-5}
Suburban	5.54×10^{-6}		4.76×10^{-5}
Urban	5.54×10^{-6}		4.76×10^{-5}
Crew, walkaround inspection (person-rem per kilometer)	6.27×10^{-7}		1.93×10^{-5}
Escort, walkaround inspection (person-rem per kilometer)	1.50×10^{-5}		
Guards at overnight stops (person-rem)	2.62×10^{-3}		

- a. Listed values for on-link unit risk factors are based on Clark County traffic counts. The analysis used country-specific counts for each country through which shipments would pass.

DOE performed an accident screening process to identify credible accidents that could occur at an intermodal transfer station with the potential for compromising the integrity of the casks and releasing radioactive material. The external events listed in Table J-51 were considered, along with an evaluation of their potential applicability.

As indicated from Table J-51, the only accident-initiating event identified from among the feasible external events was the aircraft crash. Such events would be credible only for casks being handled or on transport vehicles at an intermodal transfer station in the Las Vegas area (Apex/Dry Lake or Sloan/Jean).

For a station in the Las Vegas area, an aircraft crash would be from either commercial aircraft operations at McCarran airport or military operations from Nellis Air Force Base.

Among the internal events, the only potential accident identified was a drop of the cask during transfer operations. This accident would bound the other events considered, including drops from the railcar or truck (less fall height would be involved than during the transfer operations). Collisions, derailments, and other accidents involving the transport vehicles at the intermodal transfer station would not damage the casks due to the requirement that they be able to withstand high-speed impacts and the low velocities of the transport vehicles at the intermodal transfer station.

Accident Analysis

1. *Cask Drop Accident.* The only internal event retained after the screening process was a failure of the gantry crane (due to mechanical failure or human error) during the transfer of a shipping cask from a railcar to a heavy-haul truck. The maximum height between the shipping cask and the ground during the transfer operation would be less than 6 meters (19 feet) (DIRS 104849-CRWMS M&O 1997, all). The casks would be designed to withstand a 9-meter (30-foot) drop. Therefore, the cask would be unlikely to fail during the event, especially because the impact energy from the 6-meter drop would be only 65 percent of the minimum design requirement.
2. *Aircraft Crash Accident.* This section, including Tables J-52 and J-53, has been moved to Volume IV of this EIS.

J.3.4 IMPACTS IN NEVADA FROM INCIDENT-FREE TRANSPORTATION FOR INVENTORY MODULES 1 AND 2

This section presents the analysis of impacts to occupational and public health and safety in Nevada from incident-free transportation of spent nuclear fuel and high-level radioactive waste in Inventory Modules 1 and 2. The analysis assumed that the routes, population densities, and shipment characteristics (for example, radiation from shipping casks) for shipments under the Proposed Action and Inventory Modules 1 and 2 would be the same. The only difference was the projected number of shipments that would travel to the repository.

The following sections provide detailed information on the range of potential impacts to occupational and public safety and health from incident-free transportation of Modules 1 and 2 that result from legal-weight trucks and the 10 alternative transportation routes considered in Nevada. National impacts of incident-free transportation of Modules 1 and 2 incorporating Nevada impacts are discussed together with other cumulative impacts in Chapter 8.

J.3.4.1 Mostly Legal-Weight Truck Scenario

Tables J-54 and J-55 list estimated incident-free impacts in Nevada for the mostly legal-weight truck scenario for shipments of materials included in Inventory Modules 1 and 2.

Table J-51. Screening analysis of external events considered potential accident initiators at intermodal transfer station.

Event	Applicability
Aircraft crash	Retained for further evaluation
Avalanche	(a)
Coastal erosion	(a)
Dam failure	See flooding
Debris avalanching	(a)
Dissolution	(b)
Epeirogenic displacement (tilting of the earth's crust)	(c)
Erosion	(b)
Extreme wind	(c)
Extreme weather	(e)
Fire (range)	(b)
Flooding	(d)
Denudation (loss of land cover)	(b)
Fungus, bacteria, algae	(b)
Glacial erosion	(b)
High lake level	(b)
High tide	(a)
High river stage	See flooding
Hurricane	(a)
Inadvertent future intrusion	(b)
Industrial activity	Bounded by aircraft crash
Intentional future intrusion	(b)
Lightning	(c)
Loss of off/on site power	(c)
Low lake level	(b)
Meteorite impact	(e)
Military activity	Retained for further evaluation
Orogenic diastrophism (tectonic ground movement)	(e)
Pipeline accident	(b)
Rainstorm	See flooding
Sandstorm	(c)
Sedimentation	(b)
Seiche (sudden water-level change)	(a)
Seismic activity, uplifting	(c)
Seismic activity, earthquake	(c)
Seismic activity, surface fault	(c)
Seismic activity, subsurface fault	(c)
Static fracturing	(b)
Stream erosion	(b)
Subsidence	(c)
Tornado	(c)
Tsunami (tidal wave)	(a)
Undetected past intrusions	(b)
Undetected geologic features	(b)
Undetected geologic processes	(c)
Volcanic eruption	(e)
Volcanism, magmatic activity	(e)
Volcanism, ash flow	(c)
Volcanism, ash fall	(b)
Waves (aquatic)	(a)

- a. Conditions at proposed sites do not allow event.
- b. Not a potential accident initiator.
- c. Bounded by cask drop accident considered in the internal events analysis.
- d. Shipping cask designed for event.
- e. Not credible, see evaluation for repository.

Table J-54. Population doses and radiological impacts from incident-free Nevada transportation for mostly legal-weight truck scenario—Modules 1 and 2.^a

Category	Legal-weight truck shipments	Rail shipments of naval spent nuclear fuel ^b	Total ^c
Module 1			
<i>Involved worker</i>			
Collective dose (person-rem)	3,700	21	3,700
Estimated latent cancer fatalities	1.5	0.008	1.5
<i>Public</i>			
Collective dose (person-rem)	680	10	690
Estimated latent cancer fatalities	0.34	0.005	0.35
Module 2			
<i>Involved worker</i>			
Collective dose (person-rem)	3,800	23	3,900
Estimated latent cancer fatalities	1.5	0.009	1.5
<i>Public</i>			
Collective dose (person-rem)	700	13	710
Estimated latent cancer fatalities	0.35	0.007	0.36

a. Impacts are totals for shipments over 38 years.

b. Includes impacts at intermodal transfer stations.

c. Totals might differ from sums due to rounding.

Table J-55. Population health impacts from vehicle emissions during incident-free Nevada transportation for the mostly legal-weight truck scenario—Modules 1 and 2.^a

Vehicle emission-related fatalities	Legal-weight truck shipments	Rail shipments of naval spent nuclear fuel ^b	Total ^c
Module 1	0.17	0.0069	0.18
Module 2	0.18	0.0081	0.19

a. Impacts are totals for shipments over 38 years.

b. Includes heavy-haul truck shipments in Nevada.

c. Totals might differ from sums due to rounding.

J.3.4.2 Nevada Rail Implementing Alternatives

Table J-56 lists the range of estimated incident-free impacts in Nevada for the operation of a branch rail line to ship the materials included in Inventory Modules 1 and 2. It lists impacts that would result from operations for a branch line in each of the five possible rail corridors DOE is evaluating. These include the impacts of about 3,100 legal-weight truck shipments from commercial sites that could not use rail casks to ship spent nuclear fuel.

J.3.4.3 Nevada Heavy-Haul Truck Implementing Alternatives

Radiological Impacts

Intermodal Transfer Station Impacts. Involved worker exposures (the analysis assumed that the noninvolved workers would receive no radiation exposure and thus required no further analysis) would occur during both inbound (to the repository) and outbound (to the 77 sites) portions of the shipment campaign. DOE used the same involved worker level of effort it used in the analysis of intermodal transfer station worker industrial safety impacts to estimate collective involved worker radiological impacts (that is, 16 full-time equivalents per year). The collective worker radiation doses were adapted from a study (DIRS 104791-DOE 1992, all) of a spent nuclear fuel transportation system, which was also performed for the commercial sites. That study found that the collective worker doses that could be incurred during similar inbound and outbound transfer operations of a single loaded (with commercial

Table J-56. Radiological and nonradiological impacts from incident-free Nevada transportation for the rail implementing alternatives—Modules 1 and 2.^a

Category	Legal-weight truck shipments	Rail shipments	Total ^b
<i>Involved worker</i>			
Collective dose (person-rem)	110	1,300 - 1,900	1,400 - 2,000
Estimated latent cancer fatalities	0.04	0.52 - 0.76	0.56 - 0.8
<i>Public</i>			
Collective dose (person-rem)	19	106 - 640	130 - 659
Estimated latent cancer fatalities	0.01	0.05 - 0.32	0.07 - 0.33
<i>Estimated vehicle emission-related fatalities</i>	0.0046	0.012 - 0.38	0.016 - 0.38

- a. Impacts are totals for shipments over 38 years.
- b. Totals might differ from sums due to rounding.

spent nuclear fuel) and unloaded cask were approximately 0.027 and 0.00088 person-rem per cask, respectively, as listed in Table J-57.

Table J-57. Collective worker doses (person-rem) from transportation of a single cask.^{a,b}

Inbound	Inbound CD ^b	Outbound	Outbound CD
Receive transport vehicle and loaded cask. Monitor, inspect, unhook offsite drive unit, and attach onsite drive unit.	6.3×10^{-3}	Receive transport vehicle and empty cask. Monitor, inspect, unhook offsite drive unit, and attach onsite drive unit.	0.0
Move cask to parking area and wait for wash down station. Attach to carrier puller when ready.	1.4×10^{-3}	Move cask to parking area and wait for wash down station. Attach to carrier puller when ready.	5.4×10^{-4}
Move cask to receiving and handling area.	9.2×10^{-5}	Move cask to receiving and handling area.	8.0×10^{-6}
Remove cask from carrier and place on cask cart.	4.3×10^{-3}	Remove cask from carrier and place on cask cart.	2.2×10^{-4}
Connect onsite drive unit and move cask to inspection area; disconnect onsite drive unit.	7.0×10^{-4}	Connect onsite drive unit and move cask to inspection area; disconnect onsite drive unit.	3.3×10^{-5}
Hook up offsite drive unit, move to gatehouse, perform final monitoring and inspection of cask.	1.4×10^{-2}	Hook up offsite drive unit, move to gatehouse, perform final monitoring and inspection of cask.	8.3×10^{-5}
Notify appropriate organizations of the shipment's departure.	0.0	Notify appropriate organizations of the shipment's departure.	0.0
<i>Total</i>	2.7×10^{-2}	<i>Total</i>	8.8×10^{-4}

- a. Adapted from DIRS 104791-DOE (1992, Table 4.2).
- b. Values are rounded to two significant figures; therefore, totals might differ from sums of values.
- c. CD = collective dose (person-rem per cask).

The analysis used these inbound and outbound collective dose factors to calculate the involved worker impacts listed in Table J-58 for Module 1 and Module 2 inventories in the same manner it used for commercial power reactor spent nuclear fuel impacts. The number of inbound and outbound shipments for Module 1 and Module 2 inventories is from Section J.1.2. The worker impacts reflect two-way operations.

Incident-Free Transportation. Table J-59 lists the range of estimated incident-free impacts in Nevada for the use of heavy-haul trucks to ship the materials included in Inventory Modules 1 and 2. It lists impacts that would result from operations on each of the five possible highway routes in Nevada DOE is evaluating. These include impacts of about 3,100 legal-weight truck shipments from commercial sites under Modules 1 and 2 that could not ship spent nuclear fuel using rail casks while operational.

Table J-58. Doses and radiological health impacts to involved workers from intermodal transfer station operations – Modules 1 and 2.^{a,b}

Group	Module 1		Module 2	
	Dose (millirem)	Latent cancer fatality	Dose (millirem)	Latent cancer fatality
Maximally exposed individual worker	12	0.005 ^c	12	0.005
Involved worker population	500	0.20 ^d	520	0.21

- a. Includes estimated impacts from handling 300 shipments of Naval spent nuclear fuel that would be shipped by rail under the mostly legal-weight truck transportation scenario.
- b. Totals for 38 years of operations.
- c. The estimated probability of a latent cancer fatality in an exposed individual.
- d. The estimated number of latent cancer fatalities in an exposed involved worker population.

Table J-59. Radiological and nonradiological health impacts from incident-free transportation for the heavy-haul truck implementing alternatives – Modules 1 and 2.^a

Category	Legal-weight truck shipments	Rail and heavy-haul truck shipments ^b	Total ^c
<i>Involved worker</i>			
Collective dose (person-rem)	110	2,100 - 3,100	2,200 - 3,300
Estimated latent cancer fatalities	0.04	0.85 - 1.3	0.89 - 1.3
<i>Public</i>			
Collective dose (person-rem)	19	100 - 580	120 - 600
Estimated latent cancer fatalities	0.01	0.05 - 0.29	0.06 - 0.3
<i>Estimated vehicle emission-related fatalities</i>	0.0046	0.0096 - 0.35	0.014 - 0.35

- a. Impacts are totals for 38 years.
- b. Includes impacts to workers at an intermodal transfer station.
- c. Totals might differ from sums due to rounding.

J.3.5 IMPACTS IN NEVADA FROM TRANSPORTATION ACCIDENTS FOR INVENTORY MODULES 1 AND 2

The analysis assumed that the routes, population densities, and shipment characteristics (for example, assumed radioactive material contents of shipping casks) for the Proposed Action and Inventory Modules 1 and 2 would be the same. The only difference would be the projected number of shipments that would travel to the repository. As listed in Table J-1, Module 2 would include about 3 percent more shipments than Module 1.

J.3.5.1 Mostly Legal-Weight Truck Scenario

Radiological Impacts

The analysis estimated the radiological impacts of accidents in Nevada for the mostly legal-weight truck scenario for shipments of the materials included in Inventory Modules 1 and 2. The radiological health impacts associated with both Modules 1 and 2 would be 0.1 person-rem (see Table J-60). These impacts would occur over 38 years in a population of more than 1 million people who lived within 80 kilometers (50 miles) of the Nevada routes that DOE would use. This dose risk would lead to less than 1 chance in 1,000 of an additional cancer fatality in the exposed population. For comparison, in Nevada about 240,000 in a population of 1 million people would suffer fatal cancers from other causes (DIRS 153066-Murphy 2000, p. 83).

Traffic Fatalities

The analysis estimated traffic fatalities from accidents involving the transport of spent nuclear fuel and high-level radioactive waste by legal-weight trucks in Nevada for the mostly legal-weight truck scenario for shipments of the materials included in Inventory Modules 1 and 2. It estimated that there would be

Table J-60. Accident impacts for Modules 1 and 2 – Nevada transportation.^a

Transportation scenario	Dose risk (person-rem)	Latent cancer fatalities	Traffic fatalities
<i>Legal-weight truck</i>	0.1 ^b	0.0001	0.97
<i>Legal-weight truck for the mostly rail scenario</i>	0.003	0.000001	0.03
<i>Mostly rail (Nevada rail implementing alternatives)</i>			
Caliente	0.0012	0.000001	0.12
Carlin	0.0026	0.000001	0.16
Caliente-Chalk Mountain	0.0011	0.000001	0.08
Jean	0.01	0.000005	0.09
Valley Modified	0.0017	0.000001	0.08
<i>Mostly rail (Nevada heavy-haul implementing alternatives)</i>			
Caliente	0.015	0.000008	1.2
Caliente/Chalk Mountain	0.002	0.000001	0.62
Caliente/Las Vegas	0.092	0.00005	0.83
Apex/Dry Lake	0.091	0.00005	0.44
Sloan/Jean	0.2	0.0001	0.46

a. Impacts over 38 years.

b. Estimates of dose risk are for the transportation of the materials included in Module 2. Estimates of dose risk for transportation of the materials in Module 1 would be slightly (about 3 percent) lower.

0.97 fatality over 38 years for Module 1 or Module 2 (see Table J-60). The estimate of traffic fatalities includes the risk of fatalities from 300 shipments of naval spent nuclear fuel.

J.3.5.2 Nevada Rail Implementing Alternatives

Industrial Safety Impacts

Table J-61 lists the estimated industrial safety impacts in Nevada for the operation of a branch rail line to ship the materials included in Inventory Modules 1 and 2. The table lists impacts that would result from operations for a branch line in each of the five possible rail corridors in Nevada that DOE is evaluating.

Table J-61. Rail corridor operation worker physical trauma impacts (Modules 1 and 2).

Worker group and impact category	Corridor				
	Caliente	Carlin	Caliente-Chalk Mountain	Jean	Valley Modified
<i>Involved workers</i>					
TRC ^a	150	150	150	115	115
LWC ^b	82	82	82	63	63
Fatalities	0.41	0.41	0.41	0.31	0.31
<i>Noninvolved workers^c</i>					
TRC	9	9	9	7	7
LWC	3	3	3	2	2
Fatalities	0.01	0.01	0.01	0.01	0.01
<i>All workers (totals)^d</i>					
TRC	160	160	160	120	120
LWC	85	85	85	65	65
Fatalities	0.42	0.42	0.42	0.32	0.32
Traffic fatalities ^e	1.1	1.1	1.1	0.83	0.83

a. TRC = total recordable cases (injury and illness).

b. LWC = lost workday cases.

c. Noninvolved worker impacts are based on 25 percent of the involved worker level of effort.

d. Totals might differ from sums due to rounding.

e. Fatalities from accidents during commutes to and from jobs for involved and noninvolved workers.

The representative workplace loss incidence rate for each impact parameter (as compiled by the Bureau of Labor Statistics) was used as a multiplier to convert the operations crew level of effort to expected industrial safety losses. The involved worker full-time equivalent multiples that DOE would assign to operate each rail corridor each year was estimated to be 36 to 47 full-time equivalents, depending on the corridor for the period of operations [scaled from cost data in DIRS 101214-CRWMS M&O (1996, Appendix E)]. Noninvolved worker full-time equivalent multiples were unavailable, so DOE assumed that the noninvolved worker level of effort would be similar to that for the repository operations work force—about 25 percent of that for involved workers. The Bureau of Labor Statistics loss incidence rate for each total recordable case, lost workday, and fatality trauma category (for example, the number of total recordable cases per full-time equivalent) was multiplied by the involved and noninvolved worker full-time equivalent multiples to project the associated trauma incidence.

The Bureau of Labor Statistics involved worker total recordable case incidence rate, 145,700 total recordable cases in a workforce of 1,739,000 workers (0.084 total recordable case per full-time equivalent) reflects losses in the Trucking and Warehousing sector during the 1998 period of record. The same Bureau of Labor Statistics period of record and industry sector was used to select the involved worker lost workday case incidence rate [80,000 lost workday cases in a workforce of 1,739,000 workers (0.046 lost workday case per full-time equivalent)]. The involved worker fatality incidence rate, 23.4 fatalities in a workforce of 100,000 workers (0.00023 fatality per full-time equivalent) reflects losses in the Transportation and Material Moving Occupations sector during the 1998 period of record.

The noninvolved worker total recordable case incidence rate of 61,000 total recordable cases in a workforce of 3,170,300 workers (0.019 total recordable case per full-time equivalent) reflects losses in the Engineering and Management Services sector during the Bureau of Labor Statistics 1998 period of record. DOE used the same period of record and industry sector to select the noninvolved worker lost workday case incidence rate [22,400 lost workday cases in a workforce of 3,170,300 workers (0.071 lost workday case per full-time equivalent)]. The noninvolved worker fatality incidence rate, 1.6 fatalities in a workforce of 100,000 workers (0.00002 fatality per full-time equivalent) reflects losses in the Managerial and Professional Specialties sector during the 1998 period of record.

Table J-61 lists the results of these industrial safety calculations for the five candidate corridors under Inventory Modules 1 and 2. The table also lists estimates of the number of traffic fatalities that would occur in the course of commuting by workers to and from their construction and operations jobs. These estimates used national statistics for average commute distances [18.5 kilometers (11.5 miles) one-way (DIRS 102064-FHWA 1999, all)] and fatality rates for automobile traffic [1 per 100 million kilometers (1.5 per 100 million miles) (DIRS 148080-BTS 1998, all)].

Radiological Impacts of Accidents

The analysis estimated the radiological impacts of accident scenarios in Nevada for the Nevada rail implementing alternatives for shipments of the materials included in Inventory Modules 1 and 2. Table J-60 lists the radiological dose risk and associated risk of latent cancer fatalities. The risks include accident risks in Nevada from approximately 3,100 legal-weight truck shipments from commercial sites that could not ship spent nuclear fuel in rail casks while operational. The analysis assumed that those sites would upgrade their crane capacity after reactor shutdown to allow the use of rail casks. The risks would occur over 38 years.

Traffic Fatalities

Traffic fatalities from accidents involving transport of spent nuclear fuel and high-level radioactive waste by rail in Nevada were estimated for the Nevada rail implementing alternatives for shipments of materials included in Inventory Modules 1 and 2. Table J-60 lists the estimated number of fatalities that would occur over 38 years for a branch rail line along each of the five candidate rail corridors. These estimates

include accident risks in Nevada from about 3,100 legal-weight truck shipments from commercial generators that could not ship spent nuclear fuel in rail casks while operational.

J.3.5.3 Nevada Heavy-Haul Truck Implementing Alternatives

Industrial Safety Impacts

Tables J-62 and J-63 list the estimated industrial safety impacts in Nevada for operations of heavy-haul trucks (principally highway maintenance safety impacts) and operation of an intermodal transfer station that would transfer loaded and unloaded rail casks between rail cars and heavy-haul trucks for shipments of the materials included in Inventory Modules 1 and 2. Table J-62 lists the estimated industrial safety impacts in Nevada for the operation of a heavy-haul route to the Yucca Mountain site. Table J-63 lists impacts that would result from the operation of an intermodal transfer station for any of the five candidate routes DOE is evaluating that heavy-haul trucks could use in Nevada.

Table J-62. Industrial health impacts from heavy-haul truck route operations (Modules 1 and 2).

Worker group and impact category	Corridor				
	Caliente	Caliente/Chalk Mountain	Caliente/Las Vegas	Sloan/Jean	Apex/Dry Lake
<i>Involved workers</i>					
TRC ^a	350	350	320	190	190
LWC ^b	190	190	180	100	100
Fatalities	1.0	1.0	0.9	0.5	0.5
<i>Noninvolved workers^c</i>					
TRC	20	20	18	11	11
LWC	8	8	7	4	4
Fatalities	0.02	0.02	0.02	0.01	0.01
<i>All workers (totals)^d</i>					
TRC	370	370	340	200	200
LWC	200	200	180	110	110
Fatalities	0.99	0.99	0.99	0.53	0.53
Traffic fatalities ^e	2.6	2.3	2.6	1.4	1.4

- a. TRC = total recordable cases (injury and illness).
- b. LWC = lost workday cases.
- c. Noninvolved worker impacts are based on 25 percent of the involved worker level of effort.
- d. Totals might differ from sums due to rounding.
- e. Fatalities from accidents during commutes to and from jobs for involved and noninvolved workers.

Table J-63. Annual physical trauma impacts to workers from intermodal transfer station operations (Module 1 or 2).

Involved workers			Noninvolved workers ^a			All workers		
TRC ^b	LWC ^c	Fatalities	TRC	LWC	Fatalities	TRC	LWC	Fatalities
85	47	0.23	5	2	0.01	90	48	0.24

- a. The noninvolved worker impacts are based on 25 percent of the involved worker level of effort.
- b. TRC = total recordable cases of injury and illness.
- c. LWC = lost workday cases.

Radiological Impacts of Accidents

The analysis estimated the radiological impacts of accidents in Nevada for the Nevada heavy-haul truck implementing alternatives for shipments of the materials included in Inventory Modules 1 and 2.

Table J-60 lists the radiological dose risk and associated risk of latent cancer fatalities. The risks include accident risks in Nevada from approximately 3,100 legal-weight truck shipments from commercial

generating sites that could not ship spent nuclear fuel in rail casks while operational. The risk would occur over 38 years.

Traffic Fatalities

The analysis estimated traffic fatalities from accidents involving the transport of spent nuclear fuel and high-level radioactive waste (including the rail portion of transportation to and from an intermodal transfer station) in Nevada for the heavy-haul truck implementing alternatives for shipments of the materials included in Inventory Modules 1 and 2. Table J-60 lists the estimated number of fatalities that would occur over 38 years for a branch rail line and for each of the five candidate routes for heavy-haul trucks. The estimate for traffic fatalities includes accident risk in Nevada from about 3,100 legal-weight truck shipments from commercial generators that could not ship spent nuclear fuel in rail casks while operational.

J.3.6 IMPACTS FROM TRANSPORTATION OF OTHER MATERIALS

Other types of transportation activities associated with the Proposed Action would involve shipments of materials other than the spent nuclear fuel and high-level radioactive waste discussed in previous sections. These activities would include the transportation of people (commuter transportation). This section evaluates occupational and public health and safety and air quality impacts from the shipment of:

- Construction materials, consumables, and personnel for repository construction and operation, including repository components (disposal containers, emplacement pallets, drip shields, and solar panels).
- Waste including low-level waste, construction and demolition debris, sanitary and industrial solid waste, and hazardous waste
- Office and laboratory supplies, mail, and laboratory samples

The analysis included potential impacts of transporting these materials for the flexible design, in which the repository would be open for 76 years after emplacement, and for several lower-temperature operating scenarios that would leave the repository open and ventilated for 125 to 300 years, a surface facility that would provide storage during a cooling period, and the use of derated waste packages. The analysis assumed that material would be shipped across the United States to Nevada by rail, but that DOE would not build a rail line to the proposed repository, because the larger number of truck shipments would lead to higher impacts than those for rail shipments, as discussed above. In addition, because the construction schedule for a new rail line would coincide with the schedule for the construction of repository facilities, trucks would deliver materials for repository construction.

Rail service would benefit the delivery of the 11,300 disposal containers from manufacturers. Two 33,000-kilogram (about 73,000-pound) disposal containers and their 700-kilogram (about 1,500-pound) lids (DIRS 155347-CRWMS M&O 1999, all) would be delivered on a railcar—a total of 5,650 railcar deliveries over the 24-year period of the Proposed Action (8,400 railcar deliveries if DOE used 17,000 derated waste packages). These containers would be delivered to the repository along with shipments of spent nuclear fuel and high-level radioactive waste or separately on supply trains along with shipments of materials and equipment.

Disposal container components that would weigh as much as 34 metric tons (37.5 tons) would be transported to Nevada by rail and transferred to overweight trucks for shipment to the repository site. Overweight truck shipments would move the 11,300 (or 17,000 if derated) containers from a railhead to the site. The State of Nevada routinely provides permits to motor carriers for overweight, overdimension

loads if the gross vehicle weight does not exceed 58.5 metric tons (64.5 tons) (DIRS 155347-CRWMS M&O 1999, Request #046).

J.3.6.1 Transportation of Personnel and Materials to Repository

The following paragraphs describe impacts that would result from the transportation of construction materials, consumables, repository components, supplies, mail, laboratory samples, and personnel to the repository site during the construction, operation and monitoring, and closure phases of the Proposed Action.

Human Health and Safety

Most construction materials, construction equipment, and consumables would be transported to the Yucca Mountain site on legal-weight trucks. Heavy and overdimensional construction equipment would be delivered by trucks under permits issued by the Nevada Department of Transportation. The analysis assumed that repository components would be manufactured somewhere in the central United States, while other materials and consumables would originate in Nevada. DOE estimates that about 37,000 to 41,000 rail and truck shipments over 5 years would be necessary to transport materials, supplies, and equipment to the site during the construction phase, depending on the operating mode. Surface facilities for aging would require more construction materials.

In addition to construction materials, supplies, equipment, and repository components, trucks would deliver consumables to the repository site. These would include diesel fuel, cement, and other materials that would be consumed in daily operations.

Over the 24-year period of operation, the repository would receive between 6,600 and 10,000 shipments from across the United States, and between 47,000 and 62,000 shipments in Nevada of supplies, materials, equipment, repository components, and consumables, including cement and other materials for underground excavation. The analysis assumed that the Nevada shipments would originate in the Las Vegas metropolitan area. In addition, an estimated 53,000 shipments of office and laboratory supplies and equipment, mail, and laboratory samples would occur during the 24 years of operation. About 27 million to 41 million vehicle kilometers nationally (17 million to 25 million vehicle miles) of travel, and about 34 million to 40 million kilometers (21 million to 25 million miles) in Nevada would be involved. Impacts would include vehicle emissions, consumption of petroleum resources, increased truck traffic on regional highways, and fatalities from accidents. Similarly, there would be about 43 to 760 shipments nationally, and 190,000 to 720,000 shipments in Nevada during the 76-to-300-year monitoring period after emplacement operations and about 35,000 shipments, more than 99 percent in Nevada, during closure activities. Table J-64 summarizes these impacts.

Table J-64. Human health and safety impacts from national and Nevada shipments of material to the repository.

Phase	Kilometers ^a traveled (millions)	Traffic fatalities	Fuel consumption (millions of liters) ^b	Vehicle emissions- related fatalities
Construction (5 years)	8.9 - 10	0.15 - 0.21	2.9 - 10	0.019 - 0.022
Emplacement and development (24 years)	61 - 81	2.7 - 3.9	430 - 650	0.14 - 0.19
Monitoring (76 to 300 years)	47 - 170	0.8 - 3.0	13 - 65	0.10 - 0.36
Closure (10 to 17 years)	8.4 - 8.9	0.14 - 0.17	2.2 - 8.1	0.018 - 0.019
<i>Totals^c</i>	<i>130 - 270</i>	<i>3.8 - 7.2</i>	<i>450 - 720</i>	<i>0.27 - 0.59</i>

a. To convert kilometers to miles, multiply by 0.62137.

b. To convert liters to gallons, multiply by 0.26418.

c. Totals might not equal sums due to rounding.

During the construction phase, many employees would use their personal automobiles to travel to construction areas on the repository site and to highway or rail line construction sites. The estimated average annual level of direct employment during repository surface and subsurface construction would be between 1,500 and 1,600 workers, depending on the operating mode. Current Nevada Test Site employees can ride DOE-provided buses to and from work; similarly, buses probably would be available for repository construction workers. The use of buses and car pools would result in an average vehicle occupancy of 8.6 persons per vehicle. Table J-65 summarizes the anticipated number of traffic-accident-related injuries and fatalities and the estimated consumption of gasoline that would occur from this travel activity. The greatest impact of this traffic would be added congestion at the northwestern Las Vegas Beltway interchange with U.S. Highway 95. Current estimates call for traffic at this interchange during rush hours to be as high as 1,000 vehicles an hour (DIRS 103710-Clark County 1997, Table 3-12, p. 3-43). The additional traffic from repository construction, assuming that the peak traffic would be 3 times the average, would be an estimated 600 vehicles per hour and would add about 35 percent to traffic volume at peak rush hour and would contribute to congestion although congestion in this area would be generally low.

Table J-65. Health impacts and fuel consumption from transportation of construction and operations workers.

Phase	Kilometers ^a traveled (in millions)	Traffic fatalities	Fuel consumption (millions of liters) ^b	Vehicle emissions- related fatalities
Construction	51 - 56	0.51 - 0.56	8.5 - 8.7	0.067 - 0.074
Emplacement and development (24 years)	290 - 440	2.9 - 4.4	48 - 73	0.38 - 0.58
Monitoring (76 to 300 years)	87 - 280	0.87 - 2.8	14 - 45	0.11 - 0.36
Closure	48 - 62	0.48 - 0.62	8.0 - 10	0.063 - 0.082
<i>Totals^c</i>	<i>480 - 800</i>	<i>4.8 - 8.0</i>	<i>79 - 130</i>	<i>0.63 - 1.1</i>

a. To convert kilometers to miles, multiply by 0.62137.

b. To convert liters to gallons, multiply by 0.26418.

c. Totals might not equal sums due to rounding.

The average annual employment during emplacement and development operations would be between 1,700 and 2,600 workers. As mentioned above, DOE provides bus service from the Las Vegas area to and from the Nevada Test Site. Table J-65 summarizes the anticipated number of traffic-accident-related fatalities and the estimated consumption of gasoline that would occur from this travel activity. The greatest impact of this traffic would be increased congestion at the northwestern Las Vegas Beltway interchange with U.S. 95. As many as 600 to 850 vehicles an hour at peak rush hour would contribute to the congestion. Approximately 130 to 160 people would be employed annually during monitoring and about 460 to 600 would be employed annually during closure. The number of vehicles associated with these levels of employment, about 70 at most, would contribute negligibly to congestion.

Table J-66 lists the impacts associated with the delivery of fabricated disposal container components from a manufacturing site to the repository. A total of 11,300 containers (17,000 under the derated waste package scenario) would be delivered; if a rail line to Yucca Mountain was not available, the mode of transportation would be a combination of rail and overweight truck. The analysis assumes that the capacity of each railcar would be two containers and that the capacity of a truck would be one container, so there would be 5,650 railcar shipments to Nevada and 11,300 truck shipments to the Yucca Mountain site (8,400 rail shipments and 17,000 truck shipments if derated waste packages were used). The analysis estimated impacts for one national rail route representing a potential route from a manufacturing facility to a Nevada rail siding. The analysis estimated the impacts of transporting the containers from this siding over a single truck route—the Apex/Dry Lake route analyzed for the transportation of spent nuclear fuel and high-level radioactive waste by heavy-haul trucks. Although the actual mileage from a manufacturing facility could be shorter, DOE decided to select a distance that represents a conservative

Table J-66. Impacts of disposal container shipments for 24 years of the Proposed Action.^a

Type of shipment	Number of shipments	Vehicle emissions-related health effects	Traffic fatalities
Rail and truck	5,650 - 8,400 rail/ 11,300 - 17,000 truck	0.088 - 0.13	2.2 - 3.2

a. Impacts of transporting drip shields and emplacement pallets are included in results listed in Table J-64.

estimate [4,439 kilometers (2,758 miles)]. The impacts are split into two subcategories—health effects from vehicle emissions and fatalities from transportation accidents.

Air Quality

The exhaust from vehicles involved in the transport of personnel and materials to the repository would emit carbon monoxide, nitrogen dioxide, sulfur dioxide, and particulate matter (PM₁₀). Because carbon monoxide is the principal pollutant of interest for evaluating impacts caused by motor vehicle emissions, the analysis focused on it. Table J-67 indicates the basis for selecting carbon monoxide as the principal pollutant of concern.

Table J-67. Listed pollutants and pollutant of interest.

Listed pollutant	Gasoline emissions	Diesel emissions
Carbon monoxide	Total emissions into the basin are larger than for diesel	More per vehicle-mile, but total emissions are less
Sulfur dioxide	Very minor problem with modern gasoline	Emits slightly more than gasoline
Nitrogen oxides	Limit less restrictive than carbon monoxide limit	
Particulate matter	Dust, ^b asphalt, and combustion particles	
Ozone	Limit less restrictive than carbon monoxide limit ^c	
Lead	Not a problem with modern gasoline	Does not produce lead

a. Source: 40 CFR 93.153.

b. Of most concern from earthmoving rather than fuel emissions (see DIRS 155557-Clark County 2001, all).

c. Ozone is not an emission but a product of sunlight acting on hydrocarbons and nitrogen oxides.

The analysis assumed that most of the personnel who would commute to the repository would reside in the Las Vegas area and that most of the materials would travel to the repository from the Las Vegas area. To estimate maximum potential emissions to the Las Vegas Valley airshed, which is in nonattainment for carbon monoxide (DIRS 101826-FHWA 1996, pp. 3-53 and 3-54), the analysis assumed that all personnel and material would travel from the center of Las Vegas to the repository. Table J-68 lists the estimated annual amount of carbon monoxide that would be emitted to the valley airshed during the phases of the repository project and the percent of the corresponding threshold level. Although it can be a health hazard (see Table J-65), its emission rate in the Las Vegas basin would be below the standard.

Table J-68. Annual range of carbon monoxide emitted to Las Vegas Valley airshed from transport of personnel and material to repository (kilograms per year)^a for all modes of the Proposed Action.

Phase	Annual emission rate	Percent of GCR threshold level ^b
Construction	41,000 - 45,000	45 - 50
Emplacement and development	44,000 - 62,000	49 - 69
Operations and monitoring period	6,400 - 8,200	7 - 9
Closure	33,000 - 39,000	36 - 43

a. To convert kilograms to tons, multiply by 0.0011023.

b. GCR = General Conformity Rule; the emission threshold level for carbon monoxide in a nonattainment area is 91,000 kilograms (100 tons) per year (40 CFR 93.153).

As listed in Table J-68, the annual amount of carbon monoxide emitted to the nonattainment area would be below the threshold level during all phases of the Proposed Action. In the operation phase, the estimated annual amount of carbon monoxide emitted would be greatest (49 to 69 percent) to the threshold level. Relative to the vehicle emissions from the repository-bound high-level radioactive waste and spent nuclear fuel, the emissions from the transport of personnel and materials is substantially greater for all transportation implementing alternatives.

DOE conducted a conformity review using the guidance in DIRS 155566-DOE (2000, all) to estimate carbon monoxide emissions from the transportation of personnel, materials, and supplies through the Las Vegas air basin under each transportation implementing alternative. The transportation of personnel, materials, and supplies would be the main repository-related contributor of carbon monoxide to the nonattainment area. Compared to the total from all sources in the nonattainment area, the transportation of personnel, materials, and supplies to Yucca Mountain would add, at most, an additional 0.07 percent to the 2000 daily levels of carbon monoxide in the air basin (DIRS 156706-Clark County 2000, Appendix A, Table 1-3).

For areas that are in attainment, pollutant concentrations in the ambient air probably would increase due to the additional traffic but, given the relatively small amount of traffic that passes through these areas, the additional traffic would be unlikely to cause the ambient air quality standards to be exceeded.

Noise

Traffic-related noise on major transportation routes used by the workforce would likely increase. The analysis of impacts from traffic noise assumed that the workforce would come from Nye County (20 percent) and Clark County (80 percent). During the period of maximum employment in 2015, the analysis estimated a daily maximum of 576 vehicles would pass through the Gate 100 entrance at Mercury during rush hour [compared to a baseline of 232 vehicles per hour (DIRS 101811-DOE 1996, pp. 4-43 and 4-45)]. One-hour equivalent rush hour noise levels resulting from increased traffic would increase by 3.4 dBA at Indian Springs and 4.4 dBA at Mercury over background noise levels of 66.6 and 65.5 dBA, respectively. The increase could be perceptible to the community but, because of its short duration and existing highway noise, would be unlikely to result in an adverse public response.

J.3.6.2 Impacts of Transporting Wastes from the Repository

During repository construction and operations, DOE would ship waste and sample material from the repository. The waste would include hazardous, mixed, and low-level radioactive waste. Samples would include radioactive and nonradioactive hazardous materials shipped to laboratories for analysis. In addition, nonhazardous solid waste could be shipped from the repository site to the Nevada Test Site for disposal. However, as noted in Chapter 2, DOE proposes to include an industrial landfill on the repository site. Table J-69 summarizes the health impacts from wastes that DOE would ship from the repository.

Table J-69. Health impacts and fuel consumption from transportation of waste from the Yucca Mountain repository.

Phase	Kilometers ^a traveled (in millions)	Traffic fatalities	Fuel consumption (millions of liters) ^b	Vehicle emissions- related fatalities
Construction	0.37 - 0.39	0.0061 - 0.0066	0.086 - 0.092	0.00077 - 0.0082
Emplacement and development (24 years)	2.8 - 3.1	0.047 - 0.051	0.67 - 0.72	0.0040 - 0.0043
Monitoring (76 to 300 years)	1.8 - 6.2	0.031 - 0.10	0.44 - 1.5	0.0026 - 0.0088
Closure	0.67 - 0.88	0.011 - 0.020	0.16 - 0.24	0.0014 - 0.0025
Totals ^c	6.1 - 11	0.10 - 0.18	1.4 - 2.5	0.0093 - 0.016

- a. To convert kilometers to miles, multiply by 0.62137.
- b. To convert liters to gallons, multiply by 0.26418.
- c. Totals might not equal sums due to rounding.

Occupational and Public Health and Safety

The quantities of hazardous waste that DOE would ship to approved facilities off the Nevada Test Site would be relatively small and would present little risk to public health and safety. This waste could be shipped by rail (if DOE built a rail line to the repository site) or by legal-weight truck to permitted disposal facilities. The principal risks associated with shipments of these materials would be related to traffic accidents. These risks would include 0.01 fatality for the combined construction, operation and monitoring, and closure phases for hazardous wastes.

DOE probably would ship low-level radioactive waste by truck to existing disposal facilities on the Nevada Test Site. Although these shipments would not use public highways, DOE estimated their risks. As with shipments of hazardous waste, the principal risk in transporting low-level radioactive waste would be related to traffic accidents. Because traffic on the Nevada Test Site is regulated by the Nye County Sheriff's Department, DOE assumed that accident rates on the site are similar to those of secondary highways in Nevada. Low-level radioactive waste would not be present during the construction of the repository. Therefore, accidents involving such waste could occur only during the operation and monitoring and the closure phases, although most of this waste would be generated during the construction and operation and monitoring phases. DOE estimates between 0.0038 and 0.0053 traffic fatality from the transportation of low-level radioactive waste during the repository construction, operation and monitoring, and closure phases. Table J-69 lists the impacts of transporting wastes, including hazardous waste, sanitary waste, construction debris, and low-level radioactive waste.

Air Quality

The quantities of hazardous waste that DOE would ship to approved facilities off the Nevada Test Site would be relatively small. Vehicle emissions due to these shipments would present little risk to public health and safety.

Biological Resources and Soils

The transportation of people, materials, and wastes during the construction, operation and monitoring, and closure phases of the repository could involve between 610 and 1,100 million vehicle-kilometers (between 380 and 680 million vehicle-miles) of travel on highways in southern Nevada depending on the repository operating mode. This travel would use existing highways that pass through desert tortoise habitat. Individual desert tortoises probably would be killed. However, because populations of the species are low in the vicinity of the routes (DIRS 103160-Bury and Germano 1994, pp. 57 to 72), few would be lost. Thus, the loss of individual desert tortoises due to repository traffic would not be likely to be a threat to the conservation of this species. In accordance with requirements of Section 7 of the Endangered Species Act (16 U.S.C. 1531 *et seq.*), DOE would consult with the Fish and Wildlife Service and would comply with mitigation measures resulting from that consultation to limit losses of desert tortoises from repository traffic.

J.3.6.3 Impacts from Transporting Other Materials and People in Nevada for Inventory Modules 1 and 2

The analysis evaluated impacts to occupational and public health and safety in Nevada from the transport of materials, wastes, and workers (including repository-related commuter travel) for construction, operation and monitoring, and closure of the repository that would occur for the receipt and emplacement of materials in Inventory Modules 1 and 2. The analysis assumed that the routes and transportation characteristics (for example, accident rates) for transportation associated with the Proposed Action and Inventory Modules 1 and 2 would be the same. The only difference would be the projected number of trips for materials, wastes, and workers traveling to the repository.

Table J-70 lists estimated incident-free (vehicle emissions) impacts and traffic (accident) fatality impacts in Nevada for the transportation of materials, wastes, and workers (including repository-related commuter travel) for the construction, operation and monitoring, and closure of the repository that would occur for the receipt and emplacement of the materials in Inventory Modules 1 and 2. The range includes all lower-temperature repository operating mode scenarios.

Table J-70. Health impacts from transportation of materials, consumables, personnel, and waste for Modules 1 and 2.^a

Phase	Kilometers traveled (millions) ^b	Traffic fatalities	Emission-related health effects
Construction	61 - 67	0.67 - 0.74	0.086 - 0.096
Emplacement and Development	510 - 640	8.5 - 9.8	0.78 - 0.92
Operation and Monitoring	150 - 480	1.9 - 6.1	0.24 - 0.79
Closure	59 - 97	0.65 - 1.0	0.084 - 0.13
Totals	820 - 1,200	12 - 18	1.2 - 1.9

- a. Numbers are rounded.
- b. To convert kilometers to miles, multiply by 0.62137.
- c. Totals might not equal sums due to rounding.

Even with the increased transportation of the other materials included in Module 1 or 2, DOE expects that the transportation of materials, consumables, personnel, and waste to and from the repository would be minor contributors to all transportation on a local, state, and national level. Public and worker health impacts would be small from transportation accidents involving nonradioactive hazardous materials. On average, in the United States there is about 1 fatality caused by the hazardous material being transported for each 30 million shipments by all modes (DIRS 103717-DOT 1998, p. 1; DIRS 103720-DOT Undated, Exhibit 2b).

J.4 State-Specific Impacts and Route Maps

This section contains maps and tables that illustrate the estimated impacts to 45 states and the District of Columbia (Alaska and Hawaii are not included; estimated impacts in Montana, North Dakota, and Rhode Island would be zero). As discussed previously in this appendix, DOE used state- and route-specific data to estimate transportation impacts. At this time, about 10 years before shipments could begin, DOE has not determined the specific routes it would use to ship spent nuclear fuel and high-level radioactive waste to the proposed repository. Therefore, the transportation routes discussed in this section might not be the exact routes actually used for shipments to Yucca Mountain. Nevertheless, because the analysis is based primarily on the existing Interstate Highway System and rail rolling stock, the analysis presents a representative estimate of what the actual transportation impacts would likely be.

In addition, under the national mostly rail transportation scenario, potential impacts in each state vary according to the ending node in Nevada. There are six different points of transfer from national to Nevada transportation (Caliente, Dry Lake, Jean, Beowawe, Eccles, and Apex). The routes used in the national analysis depend on the transfer point through which the shipments would pass. Tables J-71 through J-92 list the transportation impacts for 47 of the states and the District of Columbia, and Figures J-31 through J-52 are maps of the routes analyzed for each region.

In Nevada, the impacts vary according to the rail or heavy-haul implementing alternative. Figure J-53 shows the potential routes in the State of Nevada, and Table J-93 lists the impacts in Nevada for each of the eight implementing alternatives.

Table J-71. Estimated transportation impacts for the States of Alabama and Georgia.

State and impact category	Mostly legal-weight truck	Mostly rail					
		Ending rail node in Nevada ^a					
		Caliente ^b	Dry Lake ^c	Jean ^d	Beowawe ^e	Eccles ^f	Apex ^g
ALABAMA							
<i>Shipments</i>							
Truck (originating/total)	1,755/1,755	0/0	0/0	0/0	0/0	0/0	0/0
Rail (originating/total)	0/0	283/2,413	283/2,413	283/2,413	283/2,413	283/2,413	283/2,413
<i>Radiological impacts</i>							
<i>Incident-free impacts</i>							
Population (person-rem/LCFs) ^h	5.0×10 ⁰ /2.5×10 ⁻³	3.7×10 ¹ /1.8×10 ⁻³	3.7×10 ¹ /1.8×10 ⁻³	4.9×10 ⁰ /2.4×10 ⁻³	3.7×10 ¹ /1.8×10 ⁻³	3.7×10 ¹ /1.8×10 ⁻³	3.7×10 ¹ /1.8×10 ⁻³
Workers (person-rem/LCFs)	4.2×10 ¹ /1.7×10 ⁻²	2.1×10 ¹ /8.2×10 ⁻³	2.1×10 ¹ /8.2×10 ⁻³	2.2×10 ¹ /8.8×10 ⁻³	2.1×10 ¹ /8.2×10 ⁻³	2.1×10 ¹ /8.2×10 ⁻³	2.1×10 ¹ /8.2×10 ⁻³
<i>Accident dose risk</i>							
Population (person-rem/LCFs)	4.6×10 ⁻⁴ /2.3×10 ⁻⁷	3.1×10 ⁻⁴ /1.5×10 ⁻⁷	3.1×10 ⁻⁴ /1.5×10 ⁻⁷	7.0×10 ⁻⁴ /3.5×10 ⁻⁷	3.1×10 ⁻⁴ /1.5×10 ⁻⁷	3.1×10 ⁻⁴ /1.5×10 ⁻⁷	3.1×10 ⁻⁴ /1.5×10 ⁻⁷
<i>Nonradiological impacts</i>							
Vehicle emissions (LCFs)	1.0×10 ⁻³	8.4×10 ⁻⁴	8.4×10 ⁻⁴	1.4×10 ⁻³	8.4×10 ⁻⁴	8.4×10 ⁻⁴	8.4×10 ⁻⁴
Fatalities	0.003	0.009	0.009	0.011	0.009	0.009	0.009
GEORGIA							
<i>Shipments</i>							
Truck (originating/total)	1,664/13,169	0/491	0/491	0/491	0/491	0/491	0/491
Rail (originating/total)	0/0	321/2,561	321/2,561	321/2,359	321/2,561	321/2,561	321/2,561
<i>Radiological impacts</i>							
<i>Incident-free impacts</i>							
Population (person-rem/LCFs) ^h	2.2×10 ² /1.1×10 ⁻¹	1.0×10 ² /5.0×10 ⁻²	1.0×10 ² /5.0×10 ⁻²	9.4×10 ¹ /4.7×10 ⁻²	1.0×10 ² /5.0×10 ⁻²	1.0×10 ² /5.0×10 ⁻²	1.0×10 ² /5.0×10 ⁻²
Workers (person-rem/LCFs)	4.0×10 ² /1.6×10 ⁻¹	1.2×10 ² /4.8×10 ⁻²	1.2×10 ² /4.8×10 ⁻²	1.1×10 ² /4.4×10 ⁻²	1.2×10 ² /4.8×10 ⁻²	1.2×10 ² /4.8×10 ⁻²	1.2×10 ² /4.8×10 ⁻²
<i>Accident dose risk</i>							
Population (person-rem/LCFs)	5.6×10 ⁻² /2.8×10 ⁻⁵	1.4×10 ⁻² /7.2×10 ⁻⁶	1.4×10 ⁻² /7.2×10 ⁻⁶	1.2×10 ⁻² /6.1×10 ⁻⁶	1.4×10 ⁻² /7.2×10 ⁻⁶	1.4×10 ⁻² /7.2×10 ⁻⁶	1.4×10 ⁻² /7.2×10 ⁻⁶
<i>Nonradiological impacts</i>							
Vehicle emissions (LCFs)	6.4×10 ⁻²	4.8×10 ⁻²	4.8×10 ⁻²	4.4×10 ⁻²	4.8×10 ⁻²	4.8×10 ⁻²	4.8×10 ⁻²
Fatalities	0.22	0.10	0.10	0.09	0.10	0.10	0.10

- a. Under the mostly rail scenario, rail shipments would arrive in Nevada at one of six existing rail nodes. Impacts would vary according to the node. From that node, DOE would use one of the rail or heavy-haul implementing alternatives to complete the transportation to Yucca Mountain (see Section J.1.2).
- b. For heavy-haul truck transportation, the Caliente junction is the location of the proposed Caliente intermodal transfer station for heavy-haul trucks near the town of Caliente in eastern Nevada. Rail shipments terminating at this junction would continue to Yucca Mountain on heavy-haul trucks on one of the Caliente, Caliente/Chalk Mountain, or Caliente/Las Vegas routes. For branch rail line transportation, railcars would transfer via the Caliente Option to the Caliente Corridor at the Caliente junction.
- c. For heavy-haul truck transportation, the Dry Lake junction is near the location of the proposed Apex/Dry Lake intermodal transfer station for heavy-haul trucks in southeast Nevada. Rail shipments terminating at this junction would continue to Yucca Mountain on heavy-haul trucks on the Apex/Dry Lake route.
- d. For heavy-haul truck transportation, the Jean junction is near the location of the proposed Sloan/Jean intermodal transfer station for heavy-haul trucks in southern Nevada. Rail shipments terminating at this junction would continue to Yucca Mountain on heavy-haul trucks on the Sloan/Jean route. For branch rail line transportation, railcars would transfer from the mainline railroad via the Wilson Pass or Stateline Pass Option of the Jean Corridor, near the Jean junction.
- e. For branch rail line transportation, railcars would transfer from the mainline railroad at the Beowawe junction in north-central Nevada to the Carlin Corridor.
- f. For branch rail line transportation, railcars would transfer from the mainline railroad at the Eccles junction east of Caliente, Nevada, via the Eccles Option or nearby via the Crestline Option of the Caliente or Caliente-Chalk Mountain Corridor. Impacts in states outside Nevada would be the same for the Eccles and Crestline Options of the Caliente and Caliente-Chalk Mountain Corridors.
- g. For branch rail line transportation, railcars would transfer from the mainline railroad at the Apex junction in southeast Nevada, possibly via the Valley Connection, to the Valley Modified Corridor.
- h. LCF = latent cancer fatality.

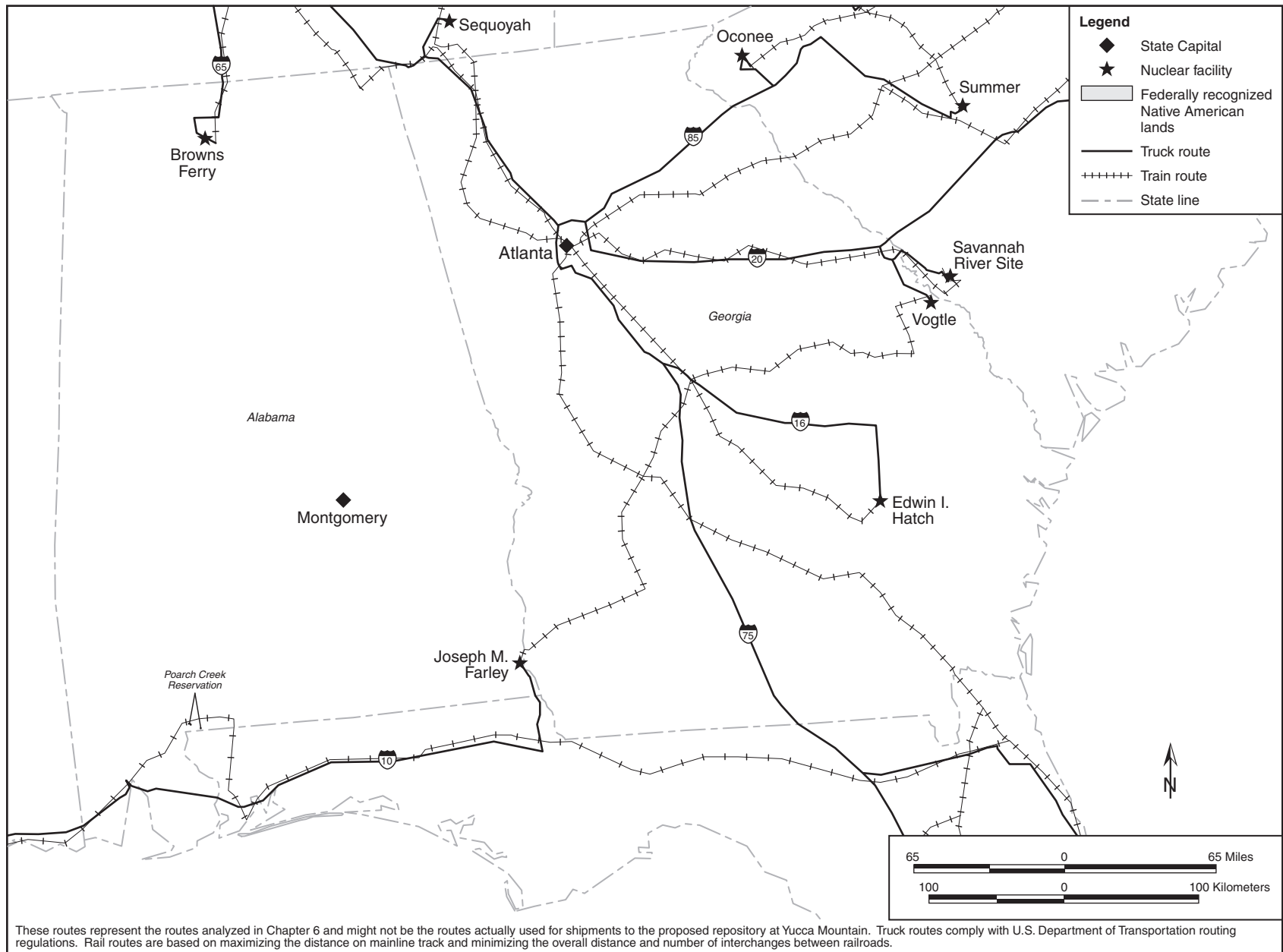

These routes represent the routes analyzed in Chapter 6 and might not be the routes actually used for shipments to the proposed repository at Yucca Mountain. Truck routes comply with U.S. Department of Transportation routing regulations. Rail routes are based on maximizing the distance on mainline track and minimizing the overall distance and number of interchanges between railroads.

Figure J-31. Highway and rail routes used to analyze transportation impacts - Alabama and Georgia.

Table J-72. Estimated transportation impacts for the State of Arkansas.

Impact category	Mostly legal-weight truck	Mostly rail					
		Ending rail node in Nevada ^a					
		Caliente ^b	Dry Lake ^c	Jean ^d	Beowawe ^e	Eccles ^f	Apex ^g
ARKANSAS							
<i>Shipments</i>							
Truck (originating/total)	794/794	0/0	0/0	0/0	0/0	0/0	0/0
Rail (originating/total)	0/0	121/201	121/201	121/121	121/258	121/201	121/201
<i>Radiological impacts</i>							
Incident-free impacts							
Population (person-rem/LCFs) ^h	2.3×10 ⁰ /1.1×10 ⁻³	1.1×10 ⁰ /5.4×10 ⁻⁴	1.1×10 ⁰ /5.4×10 ⁻⁴	9.5×10 ⁻¹ /4.8×10 ⁻⁴	1.2×10 ⁰ /5.8×10 ⁻⁴	1.1×10 ⁰ /5.4×10 ⁻⁴	1.1×10 ⁰ /5.4×10 ⁻⁴
Workers (person-rem/LCFs)	2.1×10 ⁰ /8.3×10 ⁻³	7.8×10 ⁰ /3.1×10 ⁻³	7.8×10 ⁰ /3.1×10 ⁻³	6.6×10 ⁰ /2.6×10 ⁻³	8.7×10 ⁰ /3.5×10 ⁻³	7.8×10 ⁰ /3.1×10 ⁻³	7.8×10 ⁰ /3.1×10 ⁻³
Accident dose risk							
Population (person-rem/LCFs)	4.6×10 ⁻⁵ /2.3×10 ⁻⁸	3.8×10 ⁻⁴ /1.9×10 ⁻⁷	3.8×10 ⁻⁴ /1.9×10 ⁻⁷	2.4×10 ⁻⁴ /1.2×10 ⁻⁷	4.7×10 ⁻⁴ /2.4×10 ⁻⁷	3.8×10 ⁻⁴ /1.9×10 ⁻⁷	3.8×10 ⁻⁴ /1.9×10 ⁻⁷
<i>Nonradiological impacts</i>							
Vehicle emissions (LCFs)	1.9×10 ⁻⁴	2.0×10 ⁻⁴	2.0×10 ⁻⁴	1.3×10 ⁻⁴	2.4×10 ⁻⁴	2.0×10 ⁻⁴	2.0×10 ⁻⁴
Fatalities	1.2×10 ⁻³	3.7×10 ⁻³	3.7×10 ⁻³	1.6×10 ⁻³	5.3×10 ⁻³	3.7×10 ⁻³	3.7×10 ⁻³

- a. Under the mostly rail scenario, rail shipments would arrive in Nevada at one of six existing rail nodes. Impacts would vary according to the node. From that node, DOE would use one of the rail or heavy-haul implementing alternatives to complete the transportation to Yucca Mountain (see Section J.1.2).
- b. For heavy-haul truck transportation, the Caliente junction is the location of the proposed Caliente intermodal transfer station for heavy-haul trucks near the town of Caliente in eastern Nevada. Rail shipments terminating at this junction would continue to Yucca Mountain on heavy-haul trucks on one of the Caliente, Caliente/Chalk Mountain, or Caliente/Las Vegas routes. For branch rail line transportation, railcars would transfer via the Caliente Option to the Caliente Corridor at the Caliente junction.
- c. For heavy-haul truck transportation, the Dry Lake junction is near the location of the proposed Apex/Dry Lake intermodal transfer station for heavy-haul trucks in southeast Nevada. Rail shipments terminating at this junction would continue to Yucca Mountain on heavy-haul trucks on the Apex/Dry Lake route.
- d. For heavy-haul truck transportation, the Jean junction is near the location of the proposed Sloan/Jean intermodal transfer station for heavy-haul trucks in southern Nevada. Rail shipments terminating at this junction would continue to Yucca Mountain on heavy-haul trucks on the Sloan/Jean route. For branch rail line transportation, railcars would transfer from the mainline railroad via the Wilson Pass or Stateline Pass Option of the Jean Corridor, near the Jean junction.
- e. For branch rail line transportation, railcars would transfer from the mainline railroad at the Beowawe junction in north-central Nevada to the Carlin Corridor.
- f. For branch rail line transportation, railcars would transfer from the mainline railroad at the Eccles junction east of Caliente, Nevada, via the Eccles Option or nearby via the Crestline Option of the Caliente or Caliente-Chalk Mountain Corridor. Impacts in states outside Nevada would be the same for the Eccles and Crestline Options of the Caliente and Caliente-Chalk Mountain Corridors.
- g. For branch rail line transportation, railcars would transfer from the mainline railroad at the Apex junction in southeast Nevada, possibly via the Valley Connection, to the Valley Modified Corridor.
- h. LCF = latent cancer fatality.

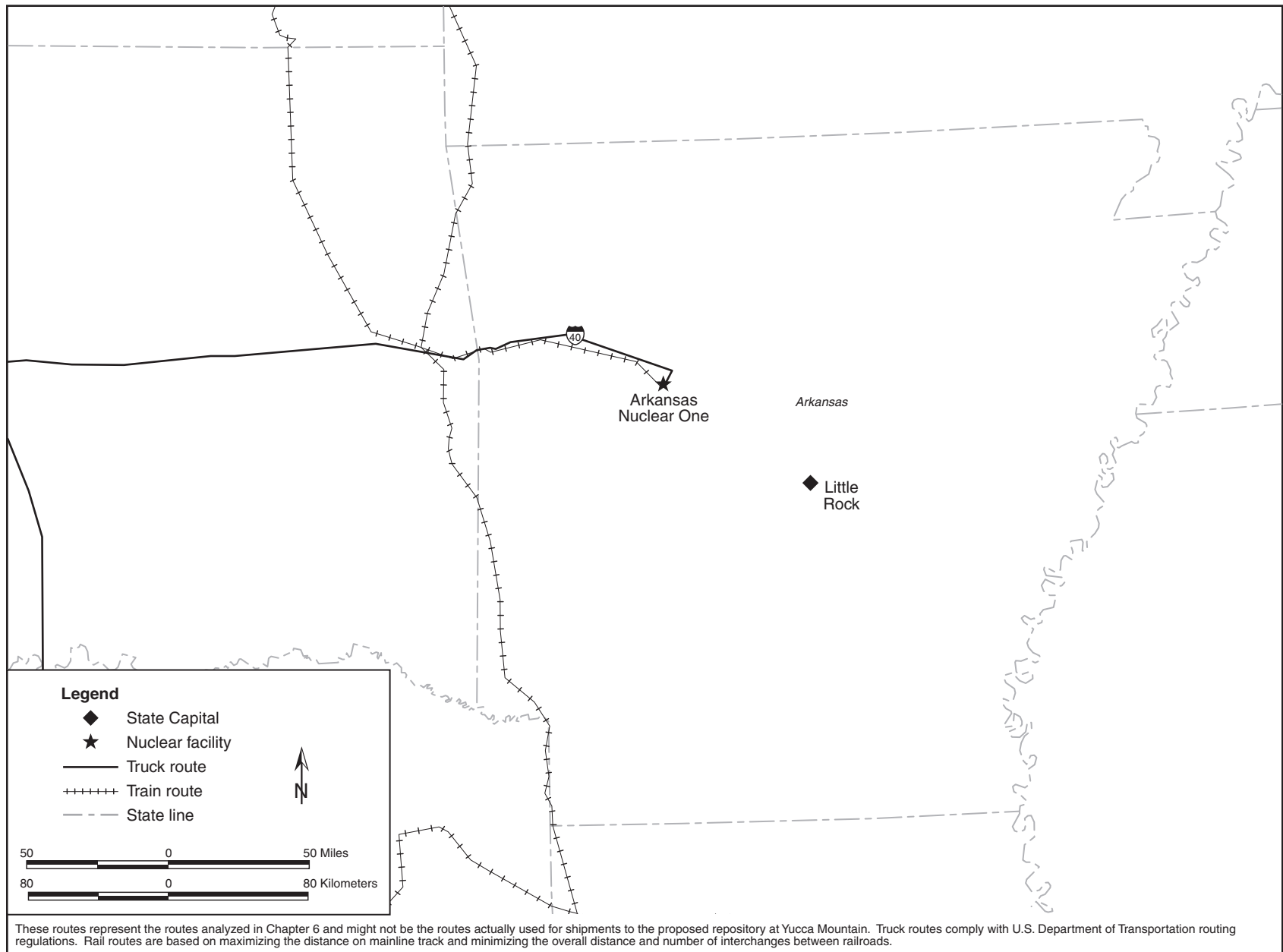

Figure J-32. Highway and rail routes used to analyze transportation impacts - Arkansas.

Table J-73. Estimated transportation impacts for the States of Arizona and New Mexico.

Impact category	Mostly legal-weight truck	Mostly rail					
		Ending rail node in Nevada ^a					
		Caliente ^b	Dry Lake ^c	Jean ^d	Beowawe ^e	Eccles ^f	Apex ^g
ARIZONA							
<i>Shipments</i>							
Truck (originating/total)	1,118/51,036	0/1,079	0/1,079	0/1,079	0/1,079	0/1,079	0/1,079
Rail (originating/total)	0/0	193/374	193/431	193/1,145	193/193	193/308	193/585
<i>Radiological impacts</i>							
<i>Incident-free impacts</i>							
Population (person-rem/LCFs) ^h	9.2×10 ¹ /4.6×10 ⁻²	5.5×10 ⁰ /2.7×10 ⁻³	6.1×10 ⁰ /3.1×10 ⁻³	1.3×10 ¹ /6.7×10 ⁻³	3.4×10 ⁰ /1.7×10 ⁻³	4.7×10 ⁰ /2.3×10 ⁻³	7.9×10 ⁰ /4.0×10 ⁻³
Workers (person-rem/LCFs)	3.2×10 ² /1.3×10 ⁻¹	2.3×10 ¹ /9.0×10 ⁻³	2.5×10 ¹ /1.0×10 ⁻²	5.5×10 ¹ /2.2×10 ⁻²	1.5×10 ¹ /6.0×10 ⁻³	2.0×10 ¹ /7.9×10 ⁻³	3.1×10 ¹ /1.3×10 ⁻²
<i>Accident dose risk</i>							
Population (person-rem/LCFs)	1.2×10 ⁻³ /6.1×10 ⁻⁷	3.6×10 ⁻⁴ /1.8×10 ⁻⁷	4.7×10 ⁻⁴ /2.3×10 ⁻⁷	1.7×10 ⁻³ /8.5×10 ⁻⁷	3.8×10 ⁻⁵ /1.9×10 ⁻⁸	2.3×10 ⁻⁴ /1.2×10 ⁻⁷	6.7×10 ⁻⁴ /3.4×10 ⁻⁷
<i>Nonradiological impacts</i>							
Vehicle emissions (LCFs)	6.2×10 ⁻³	1.2×10 ⁻³	1.5×10 ⁻³	5.1×10 ⁻³	1.1×10 ⁻⁴	7.8×10 ⁻⁴	2.4×10 ⁻³
Fatalities	8.9×10 ⁻²	7.8×10 ⁻³	9.4×10 ⁻³	2.9×10 ⁻²	2.8×10 ⁻³	6.0×10 ⁻³	1.4×10 ⁻²
NEW MEXICO							
<i>Shipments</i>							
Truck (originating/total)	0/3,999	0/0	0/0	0/0	0/0	0/0	0/0
Rail (originating/total)	0/0	0/181	0/238	0/952	0/154	0/115	0/392
<i>Radiological impacts</i>							
<i>Incident-free impacts</i>							
Population (person-rem/LCFs) ^h	5.5×10 ¹ /2.8×10 ⁻²	3.4×10 ⁻¹ /1.7×10 ⁻⁴	4.4×10 ⁻¹ /2.2×10 ⁻⁴	2.3×10 ⁰ /1.2×10 ⁻³	9.2×10 ⁻³ /4.6×10 ⁻⁶	2.1×10 ⁻¹ /1.1×10 ⁻⁴	7.3×10 ⁻¹ /3.6×10 ⁻⁴
Workers (person-rem/LCFs)	1.4×10 ² /5.8×10 ⁻²	3.1×10 ⁰ /1.2×10 ⁻³	4.0×10 ⁰ /1.6×10 ⁻³	2.3×10 ¹ /9.3×10 ⁻³	1.3×10 ¹ /5.2×10 ⁻⁴	1.9×10 ¹ /7.8×10 ⁻⁴	6.6×10 ⁰ /2.7×10 ⁻³
<i>Accident dose risk</i>							
Population (person-rem/LCFs)	1.6×10 ⁻³ /8.2×10 ⁻⁷	3.9×10 ⁻⁵ /2.0×10 ⁻⁸	5.3×10 ⁻⁵ /2.7×10 ⁻⁸	3.0×10 ⁻⁴ /1.5×10 ⁻⁷	1.2×10 ⁻⁶ /6.1×10 ⁻¹⁰	2.4×10 ⁻⁵ /1.2×10 ⁻⁸	7.9×10 ⁻⁵ /3.9×10 ⁻⁸
<i>Nonradiological impacts</i>							
Vehicle emissions (LCFs)	1.0×10 ⁻²	1.9×10 ⁻⁴	2.4×10 ⁻⁴	1.3×10 ⁻³	4.3×10 ⁻⁶	1.2×10 ⁻⁴	4.0×10 ⁻⁴
Fatalities	0.053	0.001	0.002	0.010	0.001	0.001	0.003

- a. Under the mostly rail scenario, rail shipments would arrive in Nevada at one of six existing rail nodes. Impacts would vary according to the node. From that node, DOE would use one of the rail or heavy-haul implementing alternatives to complete the transportation to Yucca Mountain (see Section J.1.2).
- b. For heavy-haul truck transportation, the Caliente junction is the location of the proposed Caliente intermodal transfer station for heavy-haul trucks near the town of Caliente in eastern Nevada. Rail shipments terminating at this junction would continue to Yucca Mountain on heavy-haul trucks on one of the Caliente, Caliente/Chalk Mountain, or Caliente/Las Vegas routes. For branch rail line transportation, railcars would transfer via the Caliente Option to the Caliente Corridor at the Caliente junction.
- c. For heavy-haul truck transportation, the Dry Lake junction is near the location of the proposed Apex/Dry Lake intermodal transfer station for heavy-haul trucks in southeast Nevada. Rail shipments terminating at this junction would continue to Yucca Mountain on heavy-haul trucks on the Apex/Dry Lake route.
- d. For heavy-haul truck transportation, the Jean junction is near the location of the proposed Sloan/Jean intermodal transfer station for heavy-haul trucks in southern Nevada. Rail shipments terminating at this junction would continue to Yucca Mountain on heavy-haul trucks on the Sloan/Jean route. For branch rail line transportation, railcars would transfer from the mainline railroad via the Wilson Pass or Stateline Pass Option of the Jean Corridor, near the Jean junction.
- e. For branch rail line transportation, railcars would transfer from the mainline railroad at the Beowawe junction in north-central Nevada to the Carlin Corridor.
- f. For branch rail line transportation, railcars would transfer from the mainline railroad at the Eccles junction east of Caliente, Nevada, via the Eccles Option or nearby via the Crestline Option of the Caliente or Caliente-Chalk Mountain Corridor. Impacts in states outside Nevada would be the same for the Eccles and Crestline Options of the Caliente and Caliente-Chalk Mountain Corridors.
- g. For branch rail line transportation, railcars would transfer from the mainline railroad at the Apex junction in southeast Nevada, possibly via the Valley Connection, to the Valley Modified Corridor.
- h. LCF = latent cancer fatality.

Table J-74. Estimated transportation impacts for the State of California.

Impact category	Mostly legal-weight truck	Mostly rail					
		Ending rail node in Nevada ^a					
		Caliente ^b	Dry Lake ^c	Jean ^d	Beowawe ^e	Eccles ^f	Apex ^g
CALIFORNIA							
<i>Shipments</i>							
Truck (originating/total)	1,750/6,867	0/0	0/0	0/0	0/0	0/0	0/0
Rail (originating/total)	0/0	286/660	286/750	286/1,464	286/512	286/594	286/904
<i>Radiological impacts</i>							
Incident-free impacts							
Population (person-rem/LCFs) ^h	1.3×10 ² /6.3×10 ⁻²	4.8×10 ¹ /2.4×10 ⁻²	5.3×10 ¹ /2.6×10 ⁻²	6.6×10 ¹ /3.3×10 ⁻²	6.9×10 ¹ /3.4×10 ⁻²	4.6×10 ¹ /2.3×10 ⁻²	5.7×10 ¹ /2.9×10 ⁻²
Workers (person-rem/LCFs)	2.7×10 ² /1.1×10 ⁻¹	4.5×10 ¹ /1.8×10 ⁻²	5.0×10 ¹ /2.0×10 ⁻²	7.7×10 ¹ /3.1×10 ⁻²	5.2×10 ¹ /2.1×10 ⁻²	4.2×10 ¹ /1.7×10 ⁻²	5.7×10 ¹ /2.3×10 ⁻²
Accident dose risk							
Population (person-rem/LCFs)	9.7×10 ⁻³ /4.9×10 ⁻⁶	2.2×10 ⁻² /1.1×10 ⁻⁵	2.5×10 ⁻² /1.3×10 ⁻⁵	3.2×10 ⁻² /1.6×10 ⁻⁵	3.4×10 ⁻² /1.7×10 ⁻⁵	2.1×10 ⁻² /1.1×10 ⁻⁵	2.7×10 ⁻² /1.3×10 ⁻⁵
<i>Nonradiological impacts</i>							
Vehicle emissions (LCFs)	4.3×10 ⁻²	2.1×10 ⁻²	2.3×10 ⁻²	3.0×10 ⁻²	3.1×10 ⁻²	2.0×10 ⁻²	2.5×10 ⁻²
Fatalities	0.052	0.061	0.073	0.131	0.073	0.055	0.087

- a. Under the mostly rail scenario, rail shipments would arrive in Nevada at one of six existing rail nodes. Impacts would vary according to the node. From that node, DOE would use one of the rail or heavy-haul implementing alternatives to complete the transportation to Yucca Mountain (see Section J.1.2).
- b. For heavy-haul truck transportation, the Caliente junction is the location of the proposed Caliente intermodal transfer station for heavy-haul trucks near the town of Caliente in eastern Nevada. Rail shipments terminating at this junction would continue to Yucca Mountain on heavy-haul trucks on one of the Caliente, Caliente/Chalk Mountain, or Caliente/Las Vegas routes. For branch rail line transportation, railcars would transfer via the Caliente Option to the Caliente Corridor at the Caliente junction.
- c. For heavy-haul truck transportation, the Dry Lake junction is near the location of the proposed Apex/Dry Lake intermodal transfer station for heavy-haul trucks in southeast Nevada. Rail shipments terminating at this junction would continue to Yucca Mountain on heavy-haul trucks on the Apex/Dry Lake route.
- d. For heavy-haul truck transportation, the Jean junction is near the location of the proposed Sloan/Jean intermodal transfer station for heavy-haul trucks in southern Nevada. Rail shipments terminating at this junction would continue to Yucca Mountain on heavy-haul trucks on the Sloan/Jean route. For branch rail line transportation, railcars would transfer from the mainline railroad via the Wilson Pass or Stateline Pass Option of the Jean Corridor, near the Jean junction.
- e. For branch rail line transportation, railcars would transfer from the mainline railroad at the Beowawe junction in north-central Nevada to the Carlin Corridor.
- f. For branch rail line transportation, railcars would transfer from the mainline railroad at the Eccles junction east of Caliente, Nevada, via the Eccles Option or nearby via the Crestline Option of the Caliente or Caliente-Chalk Mountain Corridor. Impacts in states outside Nevada would be the same for the Eccles and Crestline Options of the Caliente and Caliente-Chalk Mountain Corridors.
- g. For branch rail line transportation, railcars would transfer from the mainline railroad at the Apex junction in southeast Nevada, possibly via the Valley Connection, to the Valley Modified Corridor.
- h. LCF = latent cancer fatality.

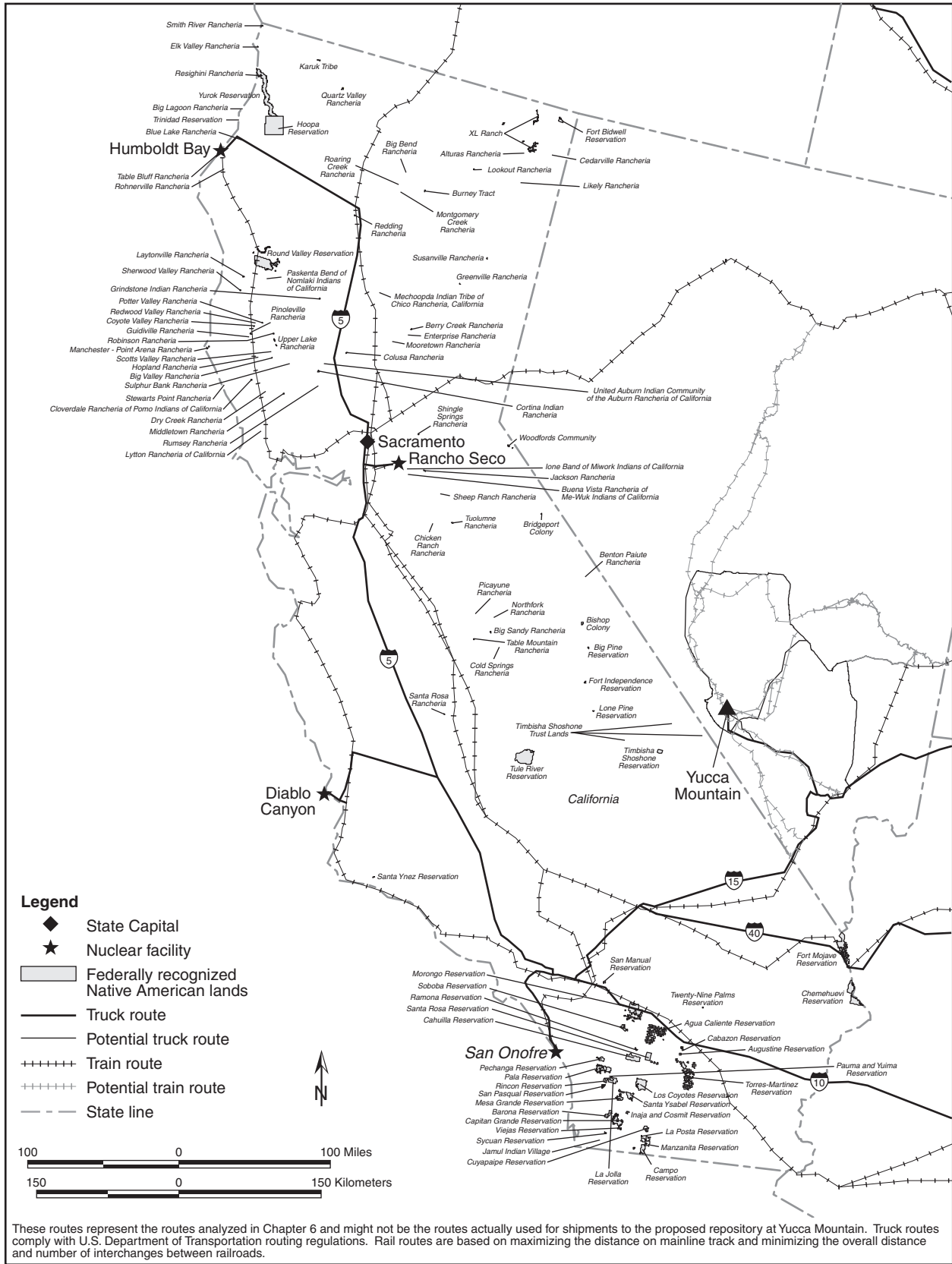

Figure J-34. Highway and rail routes used to analyze transportation impacts - California.

Table J-75. Estimated transportation impacts for the States of Colorado, Kansas, and Nebraska (page 1 of 2).

Impact category	Mostly legal-weight truck	Mostly rail					
		Ending rail node in Nevada ^a					
		Caliente ^b	Dry Lake ^c	Jean ^d	Beowawe ^e	Eccles ^f	Apex ^g
COLORADO							
<i>Shipments</i>							
Truck (originating/total)	312/708	0/0	0/0	0/0	0/0	0/0	0/0
Rail (originating/total)	0/0	36/7,904	36/7,847	36/7,133	36/8,085	36/7,970	36/7,693
<i>Radiological impacts</i>							
Incident-free impacts							
Population (person-rem/LCFs) ^h	4.4×10 ⁰ /2.2×10 ⁻³	1.6×10 ¹ /8.2×10 ⁻³	1.4×10 ¹ /7.1×10 ⁻³	3.2×10 ⁰ /1.6×10 ⁻³	2.0×10 ¹ /1.0×10 ⁻²	1.9×10 ¹ /9.4×10 ⁻³	8.5×10 ⁰ /4.3×10 ⁻³
Workers (person-rem/LCFs)	1.8×10 ¹ /7.4×10 ⁻³	4.0×10 ¹ /1.6×10 ⁻²	3.7×10 ¹ /1.5×10 ⁻²	1.2×10 ¹ /4.9×10 ⁻³	4.7×10 ¹ /1.9×10 ⁻²	4.5×10 ¹ /1.8×10 ⁻²	2.7×10 ¹ /1.1×10 ⁻²
Accident dose risk							
Population (person-rem/LCFs)	3.4×10 ⁻⁴ /1.7×10 ⁻⁷	5.2×10 ⁻³ /2.6×10 ⁻⁶	4.4×10 ⁻³ /2.2×10 ⁻⁶	7.9×10 ⁻⁴ /3.9×10 ⁻⁷	6.6×10 ⁻³ /3.3×10 ⁻⁶	6.1×10 ⁻³ /3.1×10 ⁻⁶	3.0×10 ⁻³ /1.5×10 ⁻⁶
<i>Nonradiological impacts</i>							
Vehicle emissions (LCFs)	4.9×10 ⁻⁴	8.0×10 ⁻³	6.9×10 ⁻³	1.4×10 ⁻³	9.9×10 ⁻³	9.2×10 ⁻³	4.0×10 ⁻³
Fatalities	0.005	0.024	0.021	0.007	0.028	0.026	0.015
KANSAS							
<i>Shipments</i>							
Truck (originating/total)	396/396	0/0	0/0	0/0	0/0	0/0	0/0
Rail (originating/total)	0/0	63/4,253	63/4,253	63/4,249	63/4,310	63/4,253	63/4,253
<i>Radiological impacts</i>							
Incident-free impacts							
Population (person-rem/LCFs) ^h	6.0×10 ⁰ /3.0×10 ⁻³	1.7×10 ¹ /8.4×10 ⁻³	1.7×10 ¹ /8.4×10 ⁻³	1.8×10 ¹ /9.2×10 ⁻³	1.7×10 ¹ /8.5×10 ⁻³	1.7×10 ¹ /8.4×10 ⁻³	1.7×10 ¹ /8.4×10 ⁻³
Workers (person-rem/LCFs)	2.6×10 ¹ /1.0×10 ⁻²	8.3×10 ¹ /3.3×10 ⁻²	8.3×10 ¹ /3.3×10 ⁻²	8.6×10 ¹ /3.5×10 ⁻²	8.4×10 ¹ /3.4×10 ⁻²	8.3×10 ¹ /3.3×10 ⁻²	8.3×10 ¹ /3.3×10 ⁻²
Accident dose risk							
Population (person-rem/LCFs)	2.4×10 ⁻⁴ /1.2×10 ⁻⁷	7.9×10 ⁻³ /3.9×10 ⁻⁶	7.9×10 ⁻³ /3.9×10 ⁻⁶	8.7×10 ⁻³ /4.3×10 ⁻⁶	8.0×10 ⁻³ /4.0×10 ⁻⁶	7.9×10 ⁻³ /3.9×10 ⁻⁶	7.9×10 ⁻³ /3.9×10 ⁻⁶
<i>Nonradiological impacts</i>							
Vehicle emissions (LCFs)	4.6×10 ⁻⁴	8.5×10 ⁻³	8.5×10 ⁻³	9.3×10 ⁻³	8.6×10 ⁻³	8.5×10 ⁻³	8.5×10 ⁻³
Fatalities	0.003	0.049	0.049	0.051	0.050	0.049	0.049
NEBRASKA							
<i>Shipments</i>							
Truck (originating/total)	532/40,799	0/1,079	0/1,079	0/1,079	0/1,079	0/1,079	0/1,079
Rail (originating/total)	0/0	103/7,657	103/7,657	103/7,097	103/7,714	103/7,657	103/7,657
<i>Radiological impacts</i>							
Incident-free impacts							
Population (person-rem/LCFs) ^h	6.4×10 ² /3.2×10 ⁻¹	6.2×10 ¹ /3.1×10 ⁻²	6.2×10 ¹ /3.1×10 ⁻²	5.9×10 ¹ /2.9×10 ⁻²	6.3×10 ¹ /3.1×10 ⁻²	6.2×10 ¹ /3.1×10 ⁻²	6.2×10 ¹ /3.1×10 ⁻²
Workers (person-rem/LCFs)	2.0×10 ³ /7.8×10 ⁻¹	3.9×10 ² /1.6×10 ⁻¹	3.9×10 ² /1.6×10 ⁻¹	3.7×10 ² /1.5×10 ⁻¹	4.0×10 ² /1.6×10 ⁻¹	3.9×10 ² /1.6×10 ⁻¹	3.9×10 ² /1.6×10 ⁻¹
Accident dose risk							
Population (person-rem/LCFs)	3.0×10 ⁻² /1.5×10 ⁻⁵	3.9×10 ⁻² /2.0×10 ⁻⁵	3.9×10 ⁻² /2.0×10 ⁻⁵	3.6×10 ⁻² /1.8×10 ⁻⁵	4.0×10 ⁻² /2.0×10 ⁻⁵	3.9×10 ⁻² /2.0×10 ⁻⁵	3.9×10 ⁻² /2.0×10 ⁻⁵
<i>Nonradiological impacts</i>							
Vehicle emissions (LCFs)	5.7×10 ⁻²	2.4×10 ⁻²	2.4×10 ⁻²	2.3×10 ⁻²	2.4×10 ⁻²	2.4×10 ⁻²	2.4×10 ⁻²
Fatalities	0.83	0.18	0.18	0.17	0.18	0.18	0.18

- a. Under the mostly rail scenario, rail shipments would arrive in Nevada at one of six existing rail nodes. Impacts would vary according to the node. From that node, DOE would use one of the rail or heavy-haul implementing alternatives to complete the transportation to Yucca Mountain (see Section J.1.2).
- b. For heavy-haul truck transportation, the Caliente junction is the location of the proposed Caliente intermodal transfer station for heavy-haul trucks near the town of Caliente in eastern Nevada. Rail shipments terminating at this junction would continue to Yucca Mountain on heavy-haul trucks on one of the Caliente, Caliente/Chalk Mountain, or Caliente/Las Vegas routes. For branch rail line transportation, railcars would transfer via the Caliente Option to the Caliente Corridor at the Caliente junction.

Table J-75. Estimated transportation impacts for the States of Colorado, Kansas, and Nebraska (page 2 of 2).

- c. For heavy-haul truck transportation, the Dry Lake junction is near the location of the proposed Apex/Dry Lake intermodal transfer station for heavy-haul trucks in southeast Nevada. Rail shipments terminating at this junction would continue to Yucca Mountain on heavy-haul trucks on the Apex/Dry Lake route.
- d. For heavy-haul truck transportation, the Jean junction is near the location of the proposed Sloan/Jean intermodal transfer station for heavy-haul trucks in southern Nevada. Rail shipments terminating at this junction would continue to Yucca Mountain on heavy-haul trucks on the Sloan/Jean route. For branch rail line transportation, railcars would transfer from the mainline railroad via the Wilson Pass or Stateline Pass Option of the Jean Corridor, near the Jean junction.
- e. For branch rail line transportation, railcars would transfer from the mainline railroad at the Beowawe junction in north-central Nevada to the Carlin Corridor.
- f. For branch rail line transportation, railcars would transfer from the mainline railroad at the Eccles junction east of Caliente, Nevada, via the Eccles Option or nearby via the Crestline Option of the Caliente or Caliente-Chalk Mountain Corridor. Impacts in states outside Nevada would be the same for the Eccles and Crestline Options of the Caliente and Caliente-Chalk Mountain Corridors.
- g. For branch rail line transportation, railcars would transfer from the mainline railroad at the Apex junction in southeast Nevada, possibly via the Valley Connection, to the Valley Modified Corridor.
- h. LCF = latent cancer fatality.

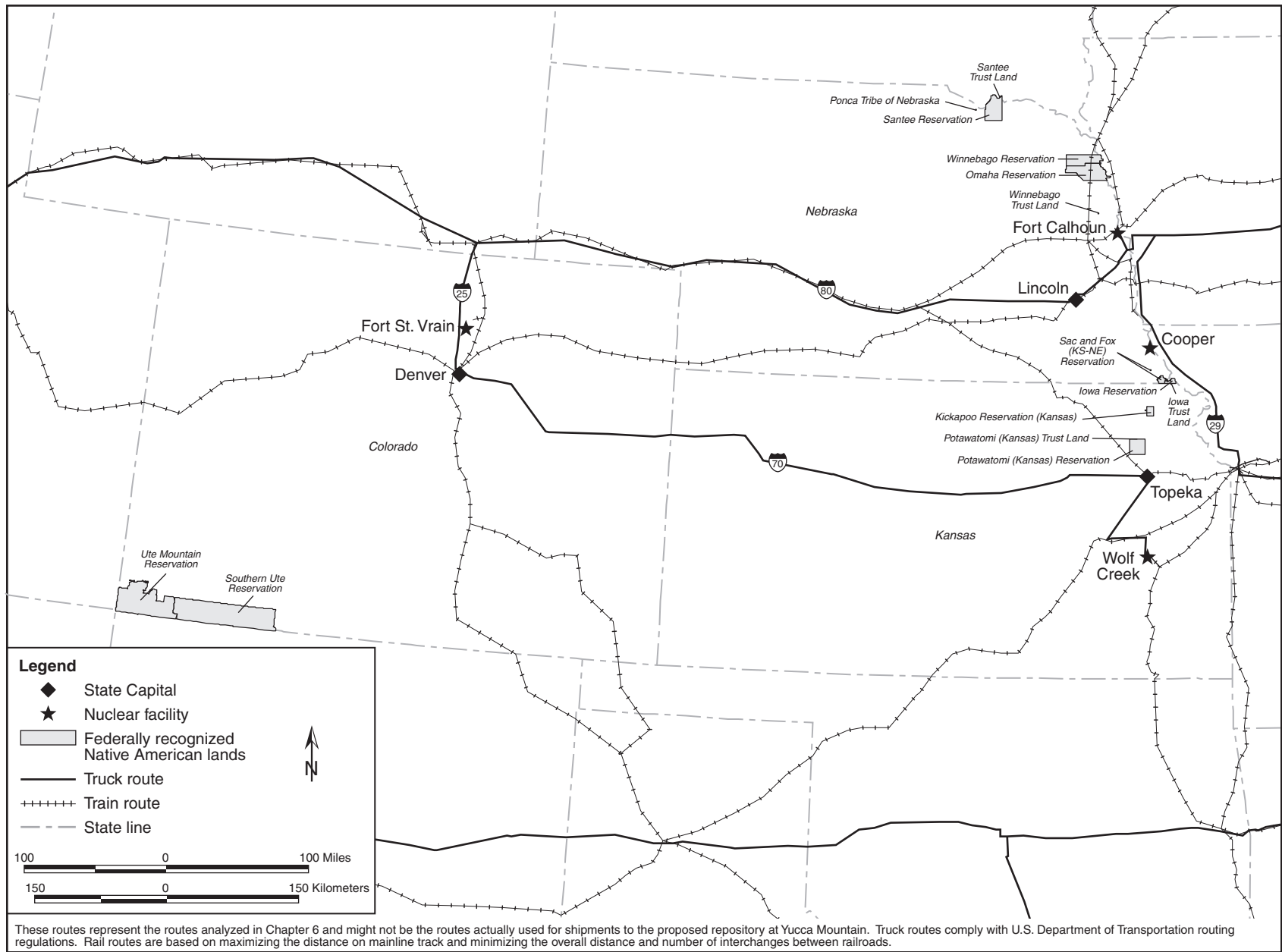

Figure J-35. Highway and rail routes used to analyze transportation impacts - Colorado, Kansas, and Nebraska.

Table J-76. Estimated transportation impacts for the States of Connecticut, Rhode Island, and New York (page 1 of 2).

Impact category	Mostly legal-weight truck	Mostly rail					
		Ending rail node in Nevada ^a					
		Caliente ^b	Dry Lake ^c	Jean ^d	Beowawe ^e	Eccles ^f	Apex ^g
CONNECTICUT							
<i>Shipments</i>							
Truck (originating/total)	1,247/1,247	0/0	0/0	0/0	0/0	0/0	0/0
Rail (originating/total)	0/0	295/295	295/295	295/295	295/295	295/295	295/295
<i>Radiological impacts</i>							
Incident-free impacts							
Population (person-rem/LCFs) ^h	1.5×10 ¹ /7.5×10 ⁻³	9.1×10 ⁰ /4.6×10 ⁻³	9.1×10 ⁰ /4.6×10 ⁻³	9.1×10 ⁰ /4.6×10 ⁻³	9.1×10 ⁰ /4.6×10 ⁻³	9.1×10 ⁰ /4.6×10 ⁻³	9.1×10 ⁰ /4.6×10 ⁻³
Workers (person-rem/LCFs)	3.4×10 ¹ /1.4×10 ⁻²	1.7×10 ¹ /7.0×10 ⁻³	1.7×10 ¹ /7.0×10 ⁻³	1.7×10 ¹ /7.0×10 ⁻³	1.7×10 ¹ /7.0×10 ⁻³	1.7×10 ¹ /7.0×10 ⁻³	1.7×10 ¹ /7.0×10 ⁻³
Accident dose risk							
Population (person-rem/LCFs)	8.2×10 ⁻³ /4.1×10 ⁻⁶	1.6×10 ⁻¹ /8.2×10 ⁻⁵	1.6×10 ⁻¹ /8.2×10 ⁻⁵	1.6×10 ⁻¹ /8.2×10 ⁻⁵	1.6×10 ⁻¹ /8.2×10 ⁻⁵	1.6×10 ⁻¹ /8.2×10 ⁻⁵	1.6×10 ⁻¹ /8.2×10 ⁻⁵
<i>Nonradiological impacts</i>							
Vehicle emissions (LCFs)	6.5×10 ⁻³	3.4×10 ⁻³	3.4×10 ⁻³	3.4×10 ⁻³	3.4×10 ⁻³	3.4×10 ⁻³	3.4×10 ⁻³
Fatalities	0.005	0.135	0.135	0.135	0.135	0.135	0.135
RHODE ISLAND							
<i>Shipments</i>							
Truck (originating/total)	0/0	0/0	0/0	0/0	0/0	0/0	0/0
Rail (originating/total)	0/0	0/0	0/0	0/0	0/0	0/0	0/0
<i>Radiological impacts</i>							
Incident-free impacts							
Population (person-rem/LCFs) ^h	0/0	0/0	0/0	0/0	0/0	0/0	0/0
Workers (person-rem/LCFs)	0/0	0/0	0/0	0/0	0/0	0/0	0/0
Accident dose risk							
Population (person-rem/LCFs)	0/0	0/0	0/0	0/0	0/0	0/0	0/0
<i>Nonradiological impacts</i>							
Vehicle emissions (LCFs)	0/0	0/0	0/0	0/0	0/0	0/0	0/0
Fatalities	0/0	0/0	0/0	0/0	0/0	0/0	0/0
NEW YORK							
<i>Shipments</i>							
Truck (originating/total)	2,571/5,287	426/580	426/580	426/580	426/580	426/580	426/580
Rail (originating/total)	0/0	350/861	350/861	350/861	350/861	350/861	350/861
<i>Radiological impacts</i>							
Incident-free impacts							
Population (person-rem/LCFs) ^h	6.3×10 ¹ /3.2×10 ⁻²	3.1×10 ¹ /1.6×10 ⁻²	3.1×10 ¹ /1.6×10 ⁻²	3.1×10 ¹ /1.6×10 ⁻²	3.1×10 ¹ /1.6×10 ⁻²	3.1×10 ¹ /1.6×10 ⁻²	3.1×10 ¹ /1.6×10 ⁻²
Workers (person-rem/LCFs)	1.6×10 ² /6.2×10 ⁻²	6.7×10 ¹ /2.7×10 ⁻²	6.7×10 ¹ /2.7×10 ⁻²	6.7×10 ¹ /2.7×10 ⁻²	6.7×10 ¹ /2.7×10 ⁻²	6.7×10 ¹ /2.7×10 ⁻²	6.7×10 ¹ /2.7×10 ⁻²
Accident dose risk							
Population (person-rem/LCFs)	7.0×10 ⁻³ /3.5×10 ⁻⁶	4.9×10 ⁻² /2.4×10 ⁻⁵	4.9×10 ⁻² /2.4×10 ⁻⁵	4.9×10 ⁻² /2.4×10 ⁻⁵	4.9×10 ⁻² /2.4×10 ⁻⁵	4.9×10 ⁻² /2.4×10 ⁻⁵	4.9×10 ⁻² /2.4×10 ⁻⁵
<i>Nonradiological impacts</i>							
Vehicle emissions (LCFs)	1.4×10 ⁻²	1.3×10 ⁻²	1.3×10 ⁻²	1.3×10 ⁻²	1.3×10 ⁻²	1.3×10 ⁻²	1.3×10 ⁻²
Fatalities	0.042	0.122	0.122	0.122	0.122	0.122	0.122

- Under the mostly rail scenario, rail shipments would arrive in Nevada at one of six existing rail nodes. Impacts would vary according to the node. From that node, DOE would use one of the rail or heavy-haul implementing alternatives to complete the transportation to Yucca Mountain (see Section J.1.2).
- For heavy-haul truck transportation, the Caliente junction is the location of the proposed Caliente intermodal transfer station for heavy-haul trucks near the town of Caliente in eastern Nevada. Rail shipments terminating at this junction would continue to Yucca Mountain on heavy-haul trucks on one of the Caliente, Caliente/Chalk Mountain, or Caliente/Las Vegas routes. For branch rail line transportation, railcars would transfer via the Caliente Option to the Caliente Corridor at the Caliente junction.

Table J-76. Estimated transportation impacts for the States of Connecticut, Rhode Island, and New York (page 2 of 2).

- c. For heavy-haul truck transportation, the Dry Lake junction is near the location of the proposed Apex/Dry Lake intermodal transfer station for heavy-haul trucks in southeast Nevada. Rail shipments terminating at this junction would continue to Yucca Mountain on heavy-haul trucks on the Apex/Dry Lake route.
- d. For heavy-haul truck transportation, the Jean junction is near the location of the proposed Sloan/Jean intermodal transfer station for heavy-haul trucks in southern Nevada. Rail shipments terminating at this junction would continue to Yucca Mountain on heavy-haul trucks on the Sloan/Jean route. For branch rail line transportation, railcars would transfer from the mainline railroad via the Wilson Pass or Stateline Pass Option of the Jean Corridor, near the Jean junction.
- e. For branch rail line transportation, railcars would transfer from the mainline railroad at the Beowawe junction in north-central Nevada to the Carlin Corridor.
- f. For branch rail line transportation, railcars would transfer from the mainline railroad at the Eccles junction east of Caliente, Nevada, via the Eccles Option or nearby via the Crestline Option of the Caliente or Caliente-Chalk Mountain Corridor. Impacts in states outside Nevada would be the same for the Eccles and Crestline Options of the Caliente and Caliente-Chalk Mountain Corridors.
- g. For branch rail line transportation, railcars would transfer from the mainline railroad at the Apex junction in southeast Nevada, possibly via the Valley Connection, to the Valley Modified Corridor.
- h. LCF = latent cancer fatality.

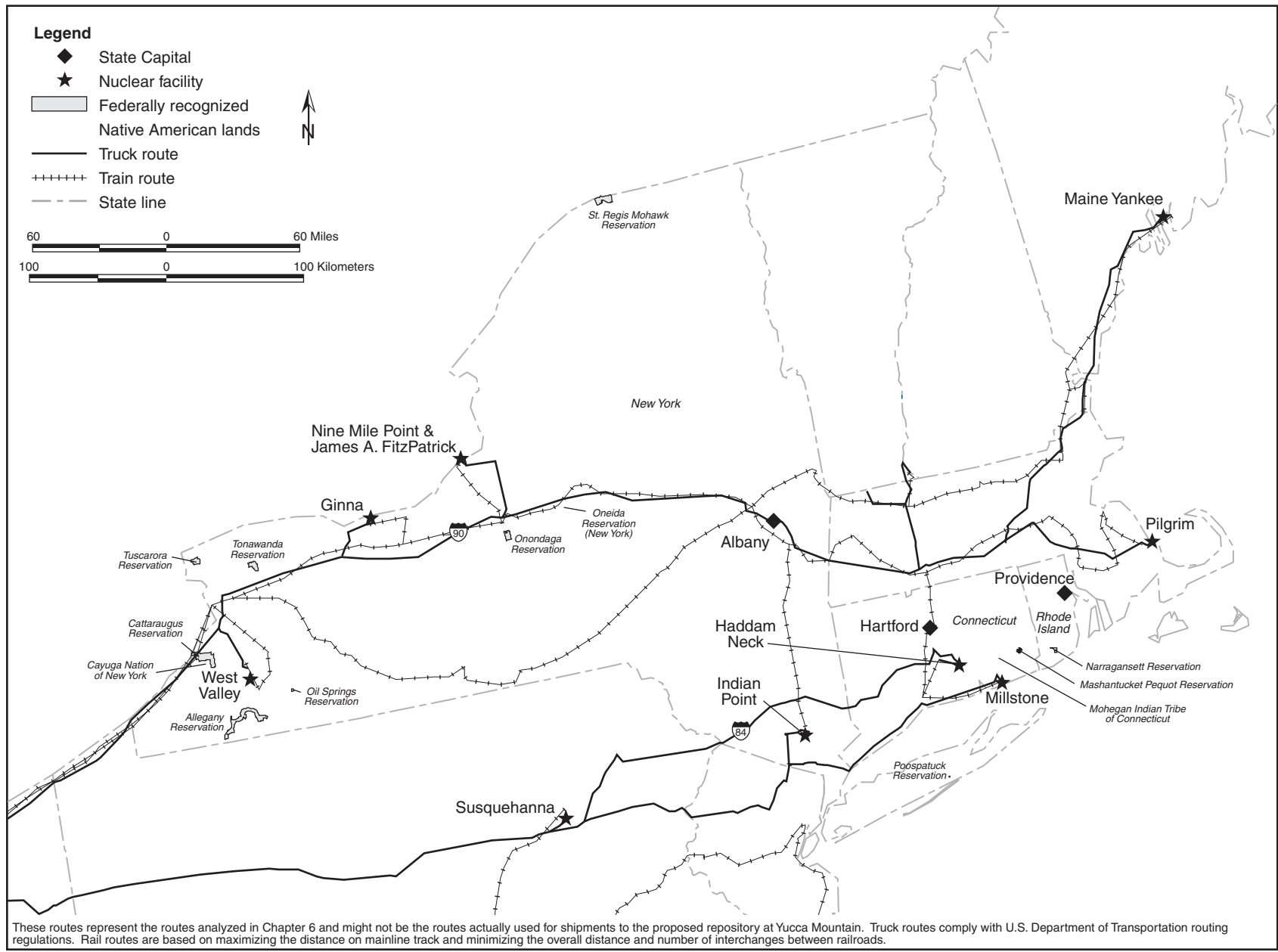

These routes represent the routes analyzed in Chapter 6 and might not be the routes actually used for shipments to the proposed repository at Yucca Mountain. Truck routes comply with U.S. Department of Transportation routing regulations. Rail routes are based on maximizing the distance on mainline track and minimizing the overall distance and number of interchanges between railroads.

Figure J-36. Highway and rail routes used to analyze transportation impacts - Connecticut, Rhode Island, and New York.

Table J-77. Estimated transportation impacts for the States of Delaware, Maryland, Virginia, West Virginia, and the District of Columbia (page 1 of 3).

Impact category	Mostly legal-weight truck	Mostly rail					
		Ending rail node in Nevada ^a					
		Caliente ^b	Dry Lake ^c	Jean ^d	Beowawe ^e	Eccles ^f	Apex ^g
DELAWARE							
<i>Shipments</i>							
Truck (originating/total)	0/1,077	0/0	0/0	0/0	0/0	0/0	0/0
Rail (originating/total)	0/0	0/0	0/0	0/0	0/0	0/0	0/0
<i>Radiological impacts</i>							
<i>Incident-free impacts</i>							
Population (person-rem/LCFs) ^h	1.6×10 ⁰ /8.2×10 ⁻⁴	0.0×10 ⁰ /0.0×10 ⁰	0.0×10 ⁰ /0.0×10 ⁰	0.0×10 ⁰ /0.0×10 ⁰	0.0×10 ⁰ /0.0×10 ⁰	0.0×10 ⁰ /0.0×10 ⁰	0.0×10 ⁰ /0.0×10 ⁰
Workers (person-rem/LCFs)	1.7×10 ⁰ /6.9×10 ⁻⁴	0.0×10 ⁰ /0.0×10 ⁰	0.0×10 ⁰ /0.0×10 ⁰	0.0×10 ⁰ /0.0×10 ⁰	0.0×10 ⁰ /0.0×10 ⁰	0.0×10 ⁰ /0.0×10 ⁰	0.0×10 ⁰ /0.0×10 ⁰
<i>Accident dose risk</i>							
Population (person-rem/LCFs)	5.2×10 ⁻⁴ /2.6×10 ⁻⁷	0.0×10 ⁰ /0.0×10 ⁰	0.0×10 ⁰ /0.0×10 ⁰	0.0×10 ⁰ /0.0×10 ⁰	0.0×10 ⁰ /0.0×10 ⁰	0.0×10 ⁰ /0.0×10 ⁰	0.0×10 ⁰ /0.0×10 ⁰
<i>Nonradiological impacts</i>							
Vehicle emissions (LCFs)	6.4×10 ⁻⁴	0.0×10 ⁰	0.0×10 ⁰	0.0×10 ⁰	0.0×10 ⁰	0.0×10 ⁰	0.0×10 ⁰
Fatalities	3.1×10 ⁻⁴	0.0×10 ⁰	0.0×10 ⁰	0.0×10 ⁰	0.0×10 ⁰	0.0×10 ⁰	0.0×10 ⁰
MARYLAND							
<i>Shipments</i>							
Truck (originating/total)	867/1,944	0/0	0/0	0/0	0/0	0/0	0/0
Rail (originating/total)	0/0	169/312	169/312	169/312	169/312	169/312	169/312
<i>Radiological impacts</i>							
<i>Incident-free impacts</i>							
Population (person-rem/LCFs) ^h	2.5×10 ¹ /1.3×10 ⁻²	1.0×10 ¹ /5.0×10 ⁻³	1.0×10 ¹ /5.0×10 ⁻³	1.0×10 ¹ /5.0×10 ⁻³	1.0×10 ¹ /5.0×10 ⁻³	1.0×10 ¹ /5.0×10 ⁻³	1.0×10 ¹ /5.0×10 ⁻³
Workers (person-rem/LCFs)	4.8×10 ¹ /1.9×10 ⁻²	1.3×10 ¹ /5.1×10 ⁻²	1.3×10 ¹ /5.1×10 ⁻²	1.3×10 ¹ /5.1×10 ⁻²	1.3×10 ¹ /5.1×10 ⁻²	1.3×10 ¹ /5.1×10 ⁻²	1.3×10 ¹ /5.1×10 ⁻²
<i>Accident dose risk</i>							
Population (person-rem/LCFs)	6.6×10 ⁻³ /3.3×10 ⁻⁶	3.2×10 ⁻³ /1.6×10 ⁻⁶	3.2×10 ⁻³ /1.6×10 ⁻⁶	3.2×10 ⁻³ /1.6×10 ⁻⁶	3.2×10 ⁻³ /1.6×10 ⁻⁶	3.2×10 ⁻³ /1.6×10 ⁻⁶	3.2×10 ⁻³ /1.6×10 ⁻⁶
<i>Nonradiological impacts</i>							
Vehicle emissions (LCFs)	8.4×10 ⁻³	3.8×10 ⁻³	3.8×10 ⁻³	3.8×10 ⁻³	3.8×10 ⁻³	3.8×10 ⁻³	3.8×10 ⁻³
Fatalities	0.007	0.007	0.007	0.007	0.007	0.007	0.007

Table J-77. Estimated transportation impacts for the States of Delaware, Maryland, Virginia, West Virginia, and the District of Columbia (page 2 of 3).

Impact category	Mostly legal-weight truck	Mostly rail					
		Ending rail node in Nevada ^a					
		Caliente ^b	Dry Lake ^c	Jean ^d	Beowawe ^e	Eccles ^f	Apex ^g
VIRGINIA							
<i>Shipments</i>							
Truck (originating/total)	1,538/3,409	0/0	0/0	0/0	0/0	0/0	0/0
Rail (originating/total)	0/0	340/340	340/340	340/340	340/340	340/340	340/340
<i>Radiological impacts</i>							
<i>Incident-free impacts</i>							
Population (person-rem/LCFs) ^h	2.2×10 ¹ /1.1×10 ⁻²	9.6×10 ⁰ /4.8×10 ⁻³	9.6×10 ⁰ /4.8×10 ⁻³	9.6×10 ⁰ /4.8×10 ⁻³	9.6×10 ⁰ /4.8×10 ⁻³	9.6×10 ⁰ /4.8×10 ⁻³	9.6×10 ⁰ /4.8×10 ⁻³
Workers (person-rem/LCFs)	8.2×10 ¹ /3.3×10 ⁻²	2.6×10 ¹ /1.0×10 ⁻²	2.6×10 ¹ /1.0×10 ⁻²	2.6×10 ¹ /1.0×10 ⁻²	2.6×10 ¹ /1.0×10 ⁻²	2.6×10 ¹ /1.0×10 ⁻²	2.6×10 ¹ /1.0×10 ⁻²
<i>Accident dose risk</i>							
Population (person-rem/LCFs)	2.1×10 ⁻³ /1.1×10 ⁻⁶	2.1×10 ⁻³ /1.0×10 ⁻⁶	2.1×10 ⁻³ /1.0×10 ⁻⁶	2.1×10 ⁻³ /1.0×10 ⁻⁶	2.1×10 ⁻³ /1.0×10 ⁻⁶	2.1×10 ⁻³ /1.0×10 ⁻⁶	2.1×10 ⁻³ /1.0×10 ⁻⁶
<i>Nonradiological impacts</i>							
Vehicle emissions (LCFs)	3.4×10 ⁻³	2.8×10 ⁻³	2.8×10 ⁻³	2.8×10 ⁻³	2.8×10 ⁻³	2.8×10 ⁻³	2.8×10 ⁻³
Fatalities	0.027	0.011	0.011	0.011	0.011	0.011	0.011
WEST VIRGINIA							
<i>Shipments</i>							
Truck (originating/total)	0/3,409	0/0	0/0	0/0	0/0	0/0	0/0
Rail (originating/total)	0/0	0/509	0/509	0/509	0/509	0/509	0/509
<i>Radiological impacts</i>							
<i>Incident-free impacts</i>							
Population (person-rem/LCFs) ^h	3.4×10 ¹ /1.7×10 ⁻²	1.6×10 ⁰ /8.1×10 ⁻⁴	1.6×10 ⁰ /8.1×10 ⁻⁴	1.6×10 ⁰ /8.1×10 ⁻⁴	1.6×10 ⁰ /8.1×10 ⁻⁴	1.6×10 ⁰ /8.1×10 ⁻⁴	1.6×10 ⁰ /8.1×10 ⁻⁴
Workers (person-rem/LCFs)	6.2×10 ¹ /2.5×10 ⁻²	6.6×10 ⁰ /2.6×10 ⁻³	6.6×10 ⁰ /2.6×10 ⁻³	6.6×10 ⁰ /2.6×10 ⁻³	6.6×10 ⁰ /2.6×10 ⁻³	6.6×10 ⁰ /2.6×10 ⁻³	6.6×10 ⁰ /2.6×10 ⁻³
<i>Accident dose risk</i>							
Population (person-rem/LCFs)	1.8×10 ⁻³ /9.2×10 ⁻⁷	3.9×10 ⁻⁴ /2.0×10 ⁻⁷	3.9×10 ⁻⁴ /2.0×10 ⁻⁷	3.9×10 ⁻⁴ /2.0×10 ⁻⁷	3.9×10 ⁻⁴ /2.0×10 ⁻⁷	3.9×10 ⁻⁴ /2.0×10 ⁻⁷	3.9×10 ⁻⁴ /2.0×10 ⁻⁷
<i>Nonradiological impacts</i>							
Vehicle emissions (LCFs)	6.9×10 ⁻³	8.5×10 ⁻⁴	8.5×10 ⁻⁴	8.5×10 ⁻⁴	8.5×10 ⁻⁴	8.5×10 ⁻⁴	8.5×10 ⁻⁴
Fatalities	0.032	0.004	0.004	0.004	0.004	0.004	0.004

Table J-77. Estimated transportation impacts for the States of Delaware, Maryland, Virginia, West Virginia, and the District of Columbia (page 3 of 3).

Impact category	Mostly legal-weight truck	Mostly rail					
		Ending rail node in Nevada ^a					
		Caliente ^b	Dry Lake ^c	Jean ^d	Beowawe ^e	Eccles ^f	Apex ^g
DISTRICT OF COLUMBIA							
<i>Shipments</i>							
Truck (originating/total)	0/0	0/0	0/0	0/0	0/0	0/0	0/0
Rail (originating/total)	0/0	0/312	0/312	0/312	0/312	0/312	0/312
<i>Radiological impacts</i>							
<i>Incident-free impacts</i>							
Population (person-rem/LCFs) ^h	0.0×10 ⁰ /0.0×10 ⁰	2.7×10 ⁰ /1.3×10 ⁻³	2.7×10 ⁰ /1.3×10 ⁻³	2.7×10 ⁰ /1.3×10 ⁻³	2.7×10 ⁰ /1.3×10 ⁻³	2.7×10 ⁰ /1.3×10 ⁻³	2.7×10 ⁰ /1.3×10 ⁻³
Workers (person-rem/LCFs)	0.0×10 ⁰ /0.0×10 ⁰	5.9×10 ⁻¹ /2.4×10 ⁻⁴	5.9×10 ⁻¹ /2.4×10 ⁻⁴	5.9×10 ⁻¹ /2.4×10 ⁻⁴	5.9×10 ⁻¹ /2.4×10 ⁻⁴	5.9×10 ⁻¹ /2.4×10 ⁻⁴	5.9×10 ⁻¹ /2.4×10 ⁻⁴
<i>Accident dose risk</i>							
Population (person-rem/LCFs)	0.0×10 ⁰ /0.0×10 ⁰	5.0×10 ⁻² /2.5×10 ⁻⁵	5.0×10 ⁻² /2.5×10 ⁻⁵	5.0×10 ⁻² /2.5×10 ⁻⁵	5.0×10 ⁻² /2.5×10 ⁻⁵	5.0×10 ⁻² /2.5×10 ⁻⁵	5.0×10 ⁻² /2.5×10 ⁻⁵
<i>Nonradiological impacts</i>							
Vehicle emissions (LCFs)	0.0×10 ⁰	1.2×10 ⁻³	1.2×10 ⁻³	1.2×10 ⁻³	1.2×10 ⁻³	1.2×10 ⁻³	1.2×10 ⁻³
Fatalities	0.0×10 ⁰	4.8×10 ⁻³	4.8×10 ⁻³	4.8×10 ⁻³	4.8×10 ⁻³	4.8×10 ⁻³	4.8×10 ⁻³

- a. Under the mostly rail scenario, rail shipments would arrive in Nevada at one of six existing rail nodes. Impacts would vary according to the node. From that node, DOE would use one of the rail or heavy-haul implementing alternatives to complete the transportation to Yucca Mountain (see Section J.1.2).
- b. For heavy-haul truck transportation, the Caliente junction is the location of the proposed Caliente intermodal transfer station for heavy-haul trucks near the town of Caliente in eastern Nevada. Rail shipments terminating at this junction would continue to Yucca Mountain on heavy-haul trucks on one of the Caliente, Caliente/Chalk Mountain, or Caliente/Las Vegas routes. For branch rail line transportation, railcars would transfer via the Caliente Option to the Caliente Corridor at the Caliente junction.
- c. For heavy-haul truck transportation, the Dry Lake junction is near the location of the proposed Apex/Dry Lake intermodal transfer station for heavy-haul trucks in southeast Nevada. Rail shipments terminating at this junction would continue to Yucca Mountain on heavy-haul trucks on the Apex/Dry Lake route.
- d. For heavy-haul truck transportation, the Jean junction is near the location of the proposed Sloan/Jean intermodal transfer station for heavy-haul trucks in southern Nevada. Rail shipments terminating at this junction would continue to Yucca Mountain on heavy-haul trucks on the Sloan/Jean route. For branch rail line transportation, railcars would transfer from the mainline railroad via the Wilson Pass or Stateline Pass Option of the Jean Corridor, near the Jean junction.
- e. For branch rail line transportation, railcars would transfer from the mainline railroad at the Beowawe junction in north-central Nevada to the Carlin Corridor.
- f. For branch rail line transportation, railcars would transfer from the mainline railroad at the Eccles junction east of Caliente, Nevada, via the Eccles Option or nearby via the Crestline Option of the Caliente or Caliente-Chalk Mountain Corridor. Impacts in states outside Nevada would be the same for the Eccles and Crestline Options of the Caliente and Caliente-Chalk Mountain Corridors.
- g. For branch rail line transportation, railcars would transfer from the mainline railroad at the Apex junction in southeast Nevada, possibly via the Valley Connection, to the Valley Modified Corridor.
- h. LCF = latent cancer fatality.

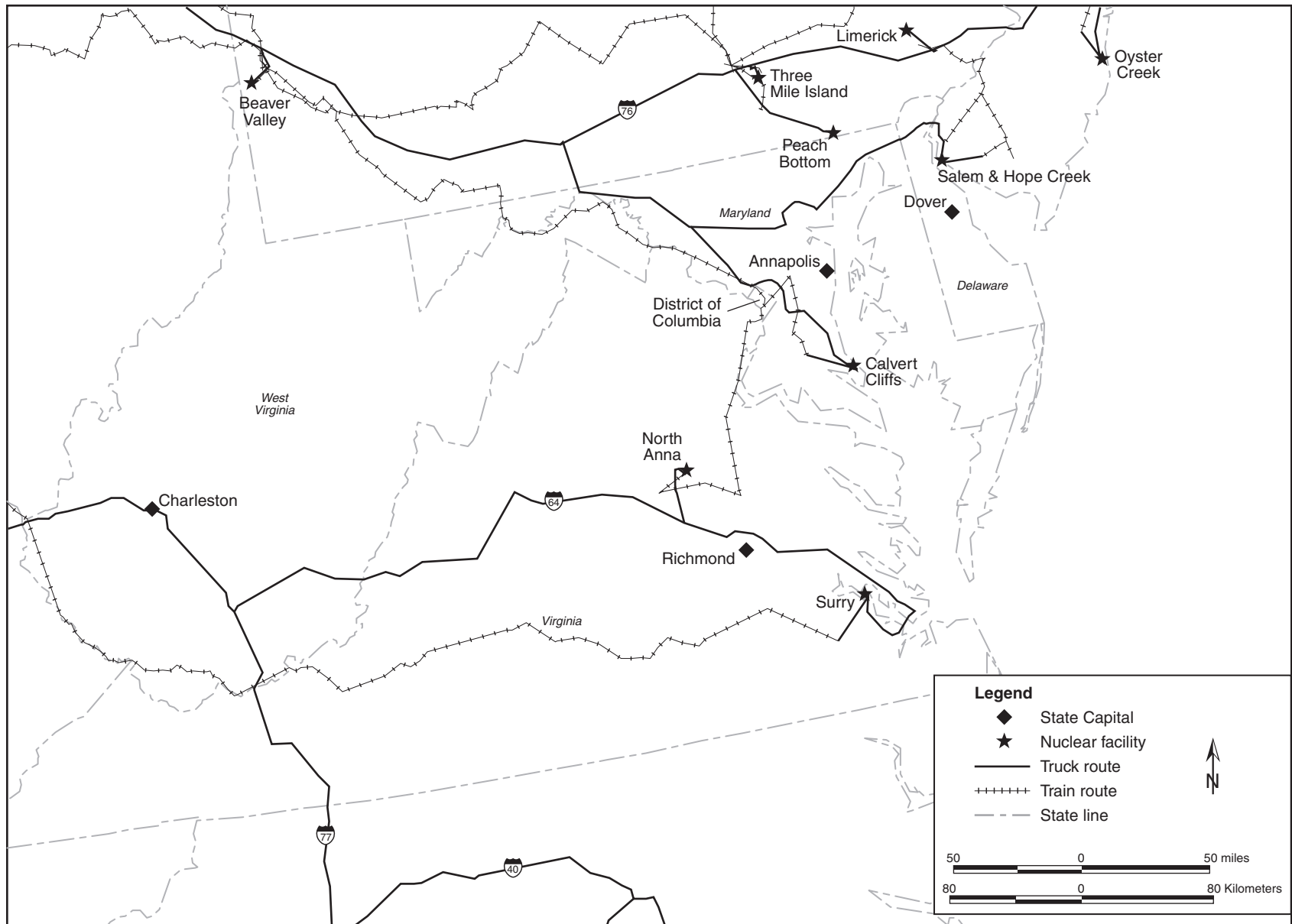

These routes represent the routes analyzed in Chapter 6 and might not be the routes actually used for shipments to the proposed repository at Yucca Mountain. Truck routes comply with U.S. Department of Transportation routing regulations. Rail routes are based on maximizing the distance on mainline track and minimizing the overall distance and number of interchanges between railroads.

Figure J-37. Highway and rail routes used to analyze transportation impacts - Delaware, Maryland, Virginia, West Virginia, and the District of Columbia.

Table J-78. Estimated transportation impacts for the State of Florida.

Impact category	Mostly legal-weight truck	Mostly rail					
		Ending rail node in Nevada ^a					
		Caliente ^b	Dry Lake ^c	Jean ^d	Beowawe ^e	Eccles ^f	Apex ^g
FLORIDA							
<i>Shipments</i>							
Truck (originating/total)	1,666/2,359	491/491	491/491	491/491	491/491	491/491	491/491
Rail (originating/total)	0/0	202/202	202/202	202/202	202/202	202/202	202/202
<i>Radiological impacts</i>							
Incident-free impacts							
Population (person-rem/LCFs) ^h	4.5×10 ¹ /2.2×10 ⁻²	2.3×10 ¹ /1.2×10 ⁻²	2.3×10 ¹ /1.2×10 ⁻²	2.8×10 ¹ /1.4×10 ⁻²	2.3×10 ¹ /1.2×10 ⁻²	2.3×10 ¹ /1.2×10 ⁻²	2.3×10 ¹ /1.2×10 ⁻²
Workers (person-rem/LCFs)	1.1×10 ² /4.3×10 ⁻²	4.2×10 ¹ /1.7×10 ⁻²	4.2×10 ¹ /1.7×10 ⁻²	5.0×10 ¹ /2.0×10 ⁻²	4.2×10 ¹ /1.7×10 ⁻²	4.2×10 ¹ /1.7×10 ⁻²	4.2×10 ¹ /1.7×10 ⁻²
Accident dose risk							
Population (person-rem/LCFs)	1.5×10 ⁻³ /7.4×10 ⁻⁷	7.4×10 ⁻³ /3.7×10 ⁻⁶	7.4×10 ⁻³ /3.7×10 ⁻⁶	9.9×10 ⁻³ /5.0×10 ⁻⁶	7.4×10 ⁻³ /3.7×10 ⁻⁶	7.4×10 ⁻³ /3.7×10 ⁻⁶	7.4×10 ⁻³ /3.7×10 ⁻⁶
<i>Nonradiological impacts</i>							
Vehicle emissions (LCFs)	1.4×10 ⁻²	8.2×10 ⁻³	8.2×10 ⁻³	1.1×10 ⁻²	8.2×10 ⁻³	8.2×10 ⁻³	8.2×10 ⁻³
Fatalities	0.019	0.025	0.025	0.047	0.025	0.025	0.025

- a. Under the mostly rail scenario, rail shipments would arrive in Nevada at one of six existing rail nodes. Impacts would vary according to the node. From that node, DOE would use one of the rail or heavy-haul implementing alternatives to complete the transportation to Yucca Mountain (see Section J.1.2).
- b. For heavy-haul truck transportation, the Caliente junction is the location of the proposed Caliente intermodal transfer station for heavy-haul trucks near the town of Caliente in eastern Nevada. Rail shipments terminating at this junction would continue to Yucca Mountain on heavy-haul trucks on one of the Caliente, Caliente/Chalk Mountain, or Caliente/Las Vegas routes. For branch rail line transportation, railcars would transfer via the Caliente Option to the Caliente Corridor at the Caliente junction.
- c. For heavy-haul truck transportation, the Dry Lake junction is near the location of the proposed Apex/Dry Lake intermodal transfer station for heavy-haul trucks in southeast Nevada. Rail shipments terminating at this junction would continue to Yucca Mountain on heavy-haul trucks on the Apex/Dry Lake route.
- d. For heavy-haul truck transportation, the Jean junction is near the location of the proposed Sloan/Jean intermodal transfer station for heavy-haul trucks in southern Nevada. Rail shipments terminating at this junction would continue to Yucca Mountain on heavy-haul trucks on the Sloan/Jean route. For branch rail line transportation, railcars would transfer from the mainline railroad via the Wilson Pass or Stateline Pass Option of the Jean Corridor, near the Jean junction.
- e. For branch rail line transportation, railcars would transfer from the mainline railroad at the Beowawe junction in north-central Nevada to the Carlin Corridor.
- f. For branch rail line transportation, railcars would transfer from the mainline railroad at the Eccles junction east of Caliente, Nevada, via the Eccles Option or nearby via the Crestline Option of the Caliente or Caliente-Chalk Mountain Corridor. Impacts in states outside Nevada would be the same for the Eccles and Crestline Options of the Caliente and Caliente-Chalk Mountain Corridors.
- g. For branch rail line transportation, railcars would transfer from the mainline railroad at the Apex junction in southeast Nevada, possibly via the Valley Connection, to the Valley Modified Corridor.
- h. LCF = latent cancer fatality.

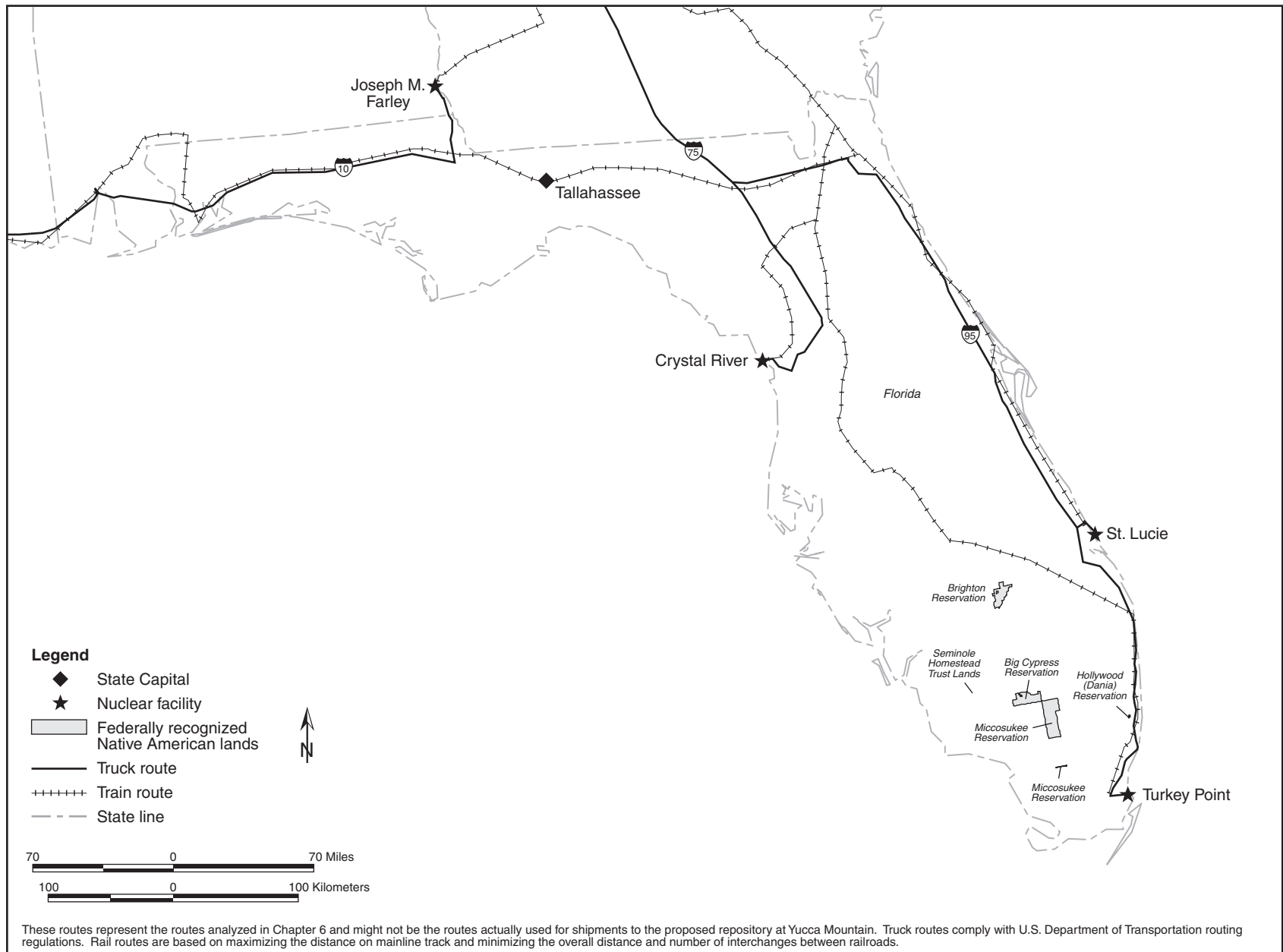

Figure J-38. Highway and rail routes used to analyze transportation impacts - Florida.

Table J-79. Estimated transportation impacts for the State of Iowa.

Impact category	Mostly legal-weight truck	Mostly rail					
		Ending rail node in Nevada ^a					
		Caliente ^b	Dry Lake ^c	Jean ^d	Beowawe ^e	Eccles ^f	Apex ^g
IOWA							
<i>Shipments</i>							
Truck (originating/total)	324/40,539	0/1,079	0/1,079	0/1,079	0/1,079	0/1,079	0/1,079
Rail (originating/total)	0/0	57/3,301	57/3,301	57/3,301	57/3,301	57/3,301	57/3,301
<i>Radiological impacts</i>							
<i>Incident-free impacts</i>							
Population (person-rem/LCFs) ^h	2.7×10 ² /1.4×10 ⁻¹	6.2×10 ¹ /3.1×10 ⁻²	6.2×10 ¹ /3.1×10 ⁻²	6.0×10 ¹ /3.0×10 ⁻²	6.2×10 ¹ /3.1×10 ⁻²	6.2×10 ¹ /3.1×10 ⁻²	6.2×10 ¹ /3.1×10 ⁻²
Workers (person-rem/LCFs)	8.7×10 ² /3.5×10 ⁻¹	1.4×10 ² /5.7×10 ⁻²	1.4×10 ² /5.7×10 ⁻²	1.3×10 ² /5.4×10 ⁻²	1.4×10 ² /5.7×10 ⁻²	1.4×10 ² /5.7×10 ⁻²	1.4×10 ² /5.7×10 ⁻²
<i>Accident dose risk</i>							
Population (person-rem/LCFs)	4.2×10 ⁻³ /2.1×10 ⁻⁶	5.8×10 ⁻² /2.9×10 ⁻⁵	5.8×10 ⁻² /2.9×10 ⁻⁵	5.4×10 ⁻² /2.7×10 ⁻⁵	5.8×10 ⁻² /2.9×10 ⁻⁵	5.8×10 ⁻² /2.9×10 ⁻⁵	5.8×10 ⁻² /2.9×10 ⁻⁵
<i>Nonradiological impacts</i>							
Vehicle emissions (LCFs)	1.4×10 ⁻²	2.7×10 ⁻²	2.7×10 ⁻²	2.6×10 ⁻²	2.7×10 ⁻²	2.7×10 ⁻²	2.7×10 ⁻²
Fatalities	0.25	0.09	0.09	0.09	0.09	0.09	0.09

- a. Under the mostly rail scenario, rail shipments would arrive in Nevada at one of six existing rail nodes. Impacts would vary according to the node. From that node, DOE would use one of the rail or heavy-haul implementing alternatives to complete the transportation to Yucca Mountain (see Section J.1.2).
- b. For heavy-haul truck transportation, the Caliente junction is the location of the proposed Caliente intermodal transfer station for heavy-haul trucks near the town of Caliente in eastern Nevada. Rail shipments terminating at this junction would continue to Yucca Mountain on heavy-haul trucks on one of the Caliente, Caliente/Chalk Mountain, or Caliente/Las Vegas routes. For branch rail line transportation, railcars would transfer via the Caliente Option to the Caliente Corridor at the Caliente junction.
- c. For heavy-haul truck transportation, the Dry Lake junction is near the location of the proposed Apex/Dry Lake intermodal transfer station for heavy-haul trucks in southeast Nevada. Rail shipments terminating at this junction would continue to Yucca Mountain on heavy-haul trucks on the Apex/Dry Lake route.
- d. For heavy-haul truck transportation, the Jean junction is near the location of the proposed Sloan/Jean intermodal transfer station for heavy-haul trucks in southern Nevada. Rail shipments terminating at this junction would continue to Yucca Mountain on heavy-haul trucks on the Sloan/Jean route. For branch rail line transportation, railcars would transfer from the mainline railroad via the Wilson Pass or Stateline Pass Option of the Jean Corridor, near the Jean junction.
- e. For branch rail line transportation, railcars would transfer from the mainline railroad at the Beowawe junction in north-central Nevada to the Carlin Corridor.
- f. For branch rail line transportation, railcars would transfer from the mainline railroad at the Eccles junction east of Caliente, Nevada, via the Eccles Option or nearby via the Crestline Option of the Caliente or Caliente-Chalk Mountain Corridor. Impacts in states outside Nevada would be the same for the Eccles and Crestline Options of the Caliente and Caliente-Chalk Mountain Corridors.
- g. For branch rail line transportation, railcars would transfer from the mainline railroad at the Apex junction in southeast Nevada, possibly via the Valley Connection, to the Valley Modified Corridor.
- h. LCF = latent cancer fatality.

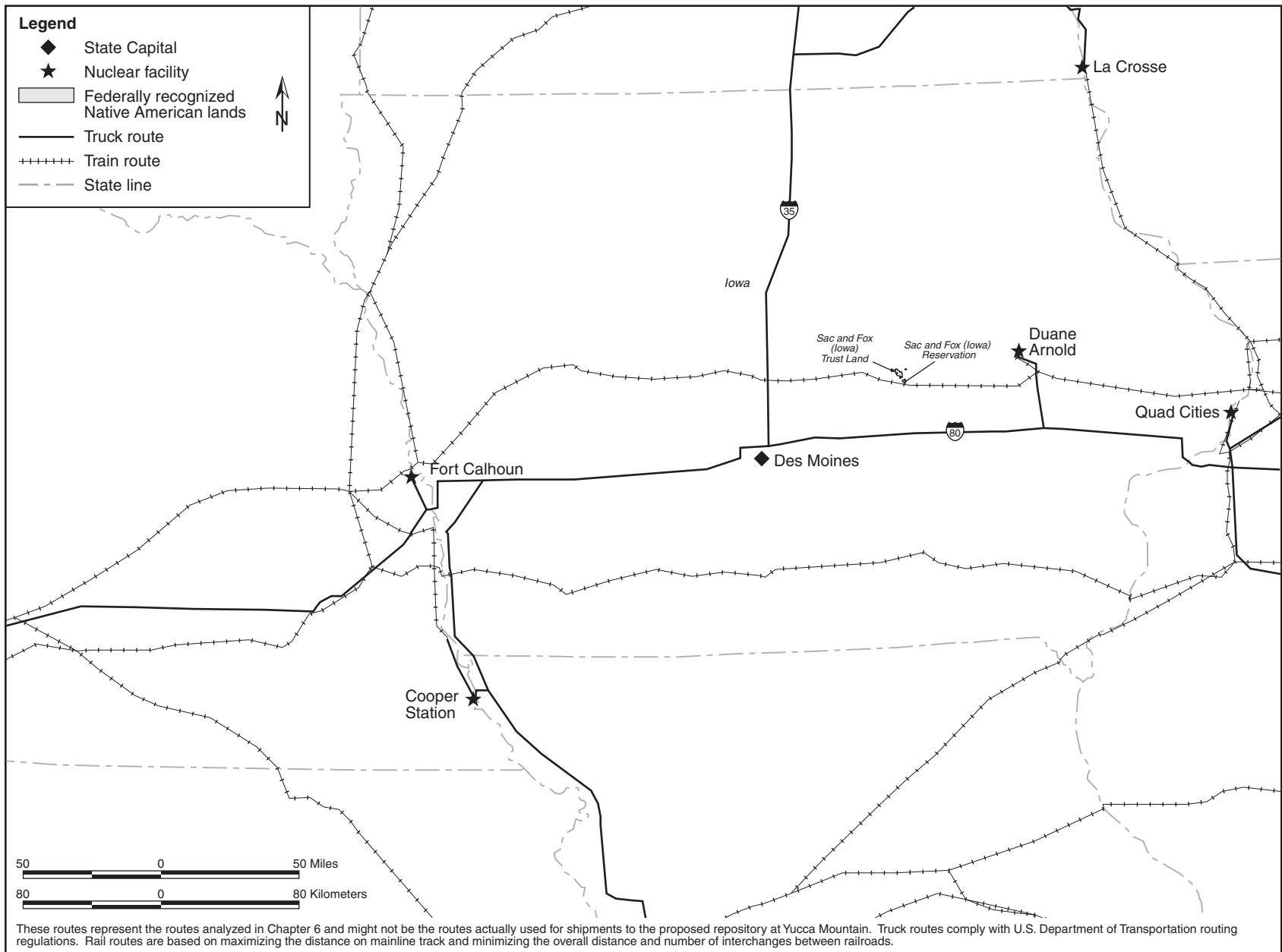

Figure J-39. Highway and rail routes used to analyze transportation impacts - Iowa.

Table J-80. Estimated transportation impacts for the States of Idaho, Oregon, and Washington (page 1 of 2).

Impact category	Mostly legal-weight truck	Mostly rail					
		Ending rail node in Nevada ^a					
		Caliente ^b	Dry Lake ^c	Jean ^d	Beowawe ^e	Eccles ^f	Apex ^g
IDAHO							
<i>Shipments</i>							
Truck (originating/total)	1,088/4,412	0/0	0/0	0/0	0/0	0/0	0/0
Rail (originating/total)	300/300	433/1,082	433/1,049	433/1,049	433/1,049	433/1,082	433/1,049
<i>Radiological impacts</i>							
Incident-free impacts							
Population (person-rem/LCFs) ^h	4.2×10 ¹ /2.1×10 ⁻²	1.4×10 ¹ /7.0×10 ⁻³	1.4×10 ¹ /7.0×10 ⁻³	4.8×10 ¹ /2.4×10 ⁻²	1.4×10 ¹ /7.0×10 ⁻³	1.4×10 ¹ /7.0×10 ⁻³	1.4×10 ¹ /7.0×10 ⁻³
Workers (person-rem/LCFs)	1.4×10 ² /5.5×10 ⁻²	4.7×10 ¹ /1.9×10 ⁻²	4.7×10 ¹ /1.9×10 ⁻²	1.7×10 ² /6.8×10 ⁻²	4.7×10 ¹ /1.9×10 ⁻²	4.7×10 ¹ /1.9×10 ⁻²	4.7×10 ¹ /1.9×10 ⁻²
Accident dose risk							
Population (person-rem/LCFs)	1.7×10 ⁻³ /8.7×10 ⁻⁷	7.9×10 ⁻⁴ /4.0×10 ⁻⁷	7.9×10 ⁻⁴ /4.0×10 ⁻⁷	2.4×10 ⁻³ /1.2×10 ⁻⁶	7.9×10 ⁻⁴ /4.0×10 ⁻⁷	7.9×10 ⁻⁴ /4.0×10 ⁻⁷	7.9×10 ⁻⁴ /4.0×10 ⁻⁷
<i>Nonradiological impacts</i>							
Vehicle emissions (LCFs)	5.2×10 ⁻³	4.2×10 ⁻³	4.2×10 ⁻³	8.0×10 ⁻³	4.2×10 ⁻³	4.2×10 ⁻³	4.2×10 ⁻³
Fatalities	0.018	0.039	0.039	0.048	0.039	0.039	0.039
OREGON							
<i>Shipments</i>							
Truck (originating/total)	195/3,324	0/0	0/0	0/0	0/0	0/0	0/0
Rail (originating/total)	0/0	33/649	33/649	33/649	33/649	33/649	33/649
<i>Radiological impacts</i>							
Incident-free impacts							
Population (person-rem/LCFs) ^h	2.3×10 ¹ /1.2×10 ⁻²	3.7×10 ⁰ /1.8×10 ⁻³	4.4×10 ⁰ /2.2×10 ⁻³	4.4×10 ⁰ /2.2×10 ⁻³	4.4×10 ⁰ /2.2×10 ⁻³	3.7×10 ⁰ /1.8×10 ⁻³	4.4×10 ⁰ /2.2×10 ⁻³
Workers (person-rem/LCFs)	7.9×10 ¹ /3.2×10 ⁻²	1.8×10 ¹ /7.3×10 ⁻³	1.8×10 ¹ /7.2×10 ⁻³	1.8×10 ¹ /7.2×10 ⁻³	1.8×10 ¹ /7.2×10 ⁻³	1.8×10 ¹ /7.3×10 ⁻³	1.8×10 ¹ /7.2×10 ⁻³
Accident dose risk							
Population (person-rem/LCFs)	4.4×10 ⁻⁴ /2.2×10 ⁻⁷	1.7×10 ⁻³ /8.5×10 ⁻⁷	2.5×10 ⁻³ /1.2×10 ⁻⁶	2.5×10 ⁻³ /1.2×10 ⁻⁶	2.5×10 ⁻³ /1.2×10 ⁻⁶	1.7×10 ⁻³ /8.5×10 ⁻⁷	2.5×10 ⁻³ /1.2×10 ⁻⁶
<i>Nonradiological impacts</i>							
Vehicle emissions (LCFs)	1.5×10 ⁻³	1.7×10 ⁻³	2.1×10 ⁻³	2.1×10 ⁻³	2.1×10 ⁻³	1.7×10 ⁻³	2.1×10 ⁻³
Fatalities	0.048	0.023	0.022	0.022	0.022	0.023	0.022

Table J-80. Estimated transportation impacts for the States of Idaho, Oregon, and Washington (page 2 of 2).

Impact category	Mostly legal-weight truck	Mostly rail					
		Ending rail node in Nevada ^a					
		Caliente ^b	Dry Lake ^c	Jean ^d	Beowawe ^e	Eccles ^d	Apex ^e
WASHINGTON							
<i>Shipments</i>							
Truck (originating/total)	3,129/3,324	0/0	0/0	0/0	0/0	0/0	0/0
Rail (originating/total)	0/0	616/616	616/616	616/616	616/616	616/616	616/616
<i>Radiological impacts</i>							
<i>Incident-free impacts</i>							
Population (person-rem/LCFs) ^b	9.7×10 ⁰ /4.9×10 ⁻³	1.1×10 ¹ /5.7×10 ⁻³	1.1×10 ¹ /5.7×10 ⁻³	1.1×10 ¹ /5.7×10 ⁻³	1.1×10 ¹ /5.7×10 ⁻³	1.1×10 ¹ /5.7×10 ⁻³	1.1×10 ¹ /5.7×10 ⁻³
Workers (person-rem/LCFs)	7.6×10 ¹ /3.0×10 ⁻²	3.2×10 ¹ /1.3×10 ⁻²	3.2×10 ¹ /1.3×10 ⁻²	3.2×10 ¹ /1.3×10 ⁻²	3.2×10 ¹ /1.3×10 ⁻²	3.2×10 ¹ /1.3×10 ⁻²	3.2×10 ¹ /1.3×10 ⁻²
<i>Accident dose risk</i>							
Population (person-rem/LCFs)	8.8×10 ⁻⁴ /4.4×10 ⁻⁷	6.7×10 ⁻⁴ /3.4×10 ⁻⁷	6.7×10 ⁻⁴ /3.4×10 ⁻⁷	6.7×10 ⁻⁴ /3.4×10 ⁻⁷	6.7×10 ⁻⁴ /3.4×10 ⁻⁷	6.7×10 ⁻⁴ /3.4×10 ⁻⁷	6.7×10 ⁻⁴ /3.4×10 ⁻⁷
<i>Nonradiological impacts</i>							
Vehicle emissions (LCFs)	2.7×10 ⁻³	2.2×10 ⁻³	2.2×10 ⁻³	2.2×10 ⁻³	2.2×10 ⁻³	2.2×10 ⁻³	2.2×10 ⁻³
Fatalities	0.001	0.005	0.005	0.005	0.005	0.005	0.005

- a. Under the mostly rail scenario, rail shipments would arrive in Nevada at one of six existing rail nodes. Impacts would vary according to the node. From that node, DOE would use one of the rail or heavy-haul implementing alternatives to complete the transportation to Yucca Mountain (see Section J.1.2).
- b. For heavy-haul truck transportation, the Caliente junction is the location of the proposed Caliente intermodal transfer station for heavy-haul trucks near the town of Caliente in eastern Nevada. Rail shipments terminating at this junction would continue to Yucca Mountain on heavy-haul trucks on one of the Caliente, Caliente/Chalk Mountain, or Caliente/Las Vegas routes. For branch rail line transportation, railcars would transfer via the Caliente Option to the Caliente Corridor at the Caliente junction.
- c. For heavy-haul truck transportation, the Dry Lake junction is near the location of the proposed Apex/Dry Lake intermodal transfer station for heavy-haul trucks in southeast Nevada. Rail shipments terminating at this junction would continue to Yucca Mountain on heavy-haul trucks on the Apex/Dry Lake route.
- d. For heavy-haul truck transportation, the Jean junction is near the location of the proposed Sloan/Jean intermodal transfer station for heavy-haul trucks in southern Nevada. Rail shipments terminating at this junction would continue to Yucca Mountain on heavy-haul trucks on the Sloan/Jean route. For branch rail line transportation, railcars would transfer from the mainline railroad via the Wilson Pass or Stateline Pass Option of the Jean Corridor, near the Jean junction.
- e. For branch rail line transportation, railcars would transfer from the mainline railroad at the Beowawe junction in north-central Nevada to the Carlin Corridor.
- f. For branch rail line transportation, railcars would transfer from the mainline railroad at the Eccles junction east of Caliente, Nevada, via the Eccles Option or nearby via the Crestline Option of the Caliente or Caliente-Chalk Mountain Corridor. Impacts in states outside Nevada would be the same for the Eccles and Crestline Options of the Caliente and Caliente-Chalk Mountain Corridors.
- g. For branch rail line transportation, railcars would transfer from the mainline railroad at the Apex junction in southeast Nevada, possibly via the Valley Connection, to the Valley Modified Corridor.
- h. LCF = latent cancer fatality.

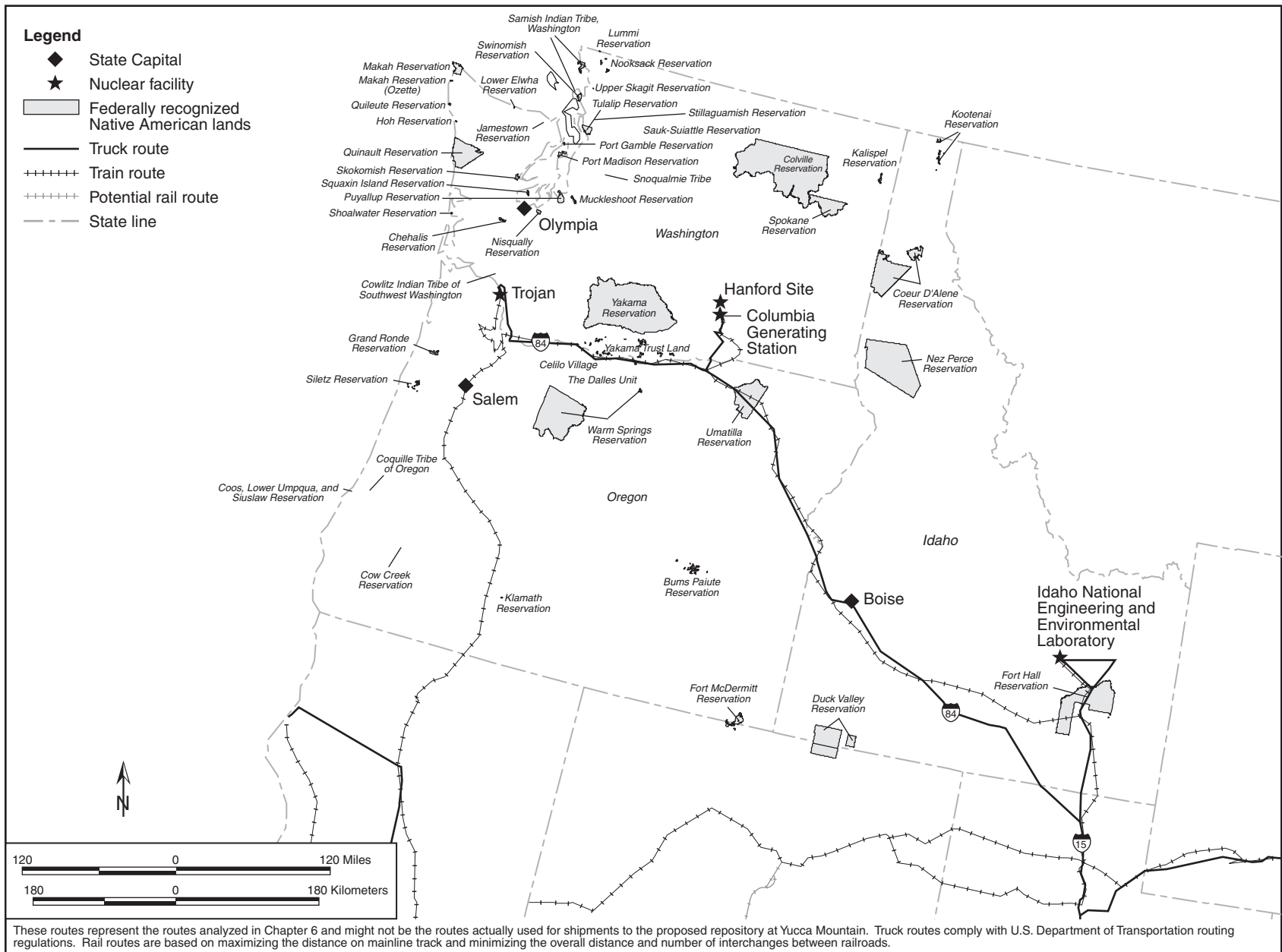

These routes represent the routes analyzed in Chapter 6 and might not be the routes actually used for shipments to the proposed repository at Yucca Mountain. Truck routes comply with U.S. Department of Transportation routing regulations. Rail routes are based on maximizing the distance on mainline track and minimizing the overall distance and number of interchanges between railroads.

Figure J-40. Highway and rail routes used to analyze transportation impacts - Idaho, Oregon, and Washington.

Table J-81. Estimated transportation impacts for the States of Indiana, Michigan, and Ohio (page 1 of 2).

Impact category	Mostly legal-weight truck	Mostly rail					
		Ending rail node in Nevada ^a					
		Caliente ^b	Dry Lake ^c	Jean ^d	Beowawe ^e	Eccles ^d	Apex ^e
INDIANA							
<i>Shipments</i>							
Truck (originating/total)	0/17,258	0/580	0/580	0/580	0/580	0/580	0/580
Rail (originating/total)	0/0	0/5,980	0/5,980	0/5,778	0/5,980	0/5,980	0/5,980
<i>Radiological impacts</i>							
<i>Incident-free impacts</i>							
Population (person-rem/LCFs) ^b	1.2×10 ² /6.0×10 ⁻²	5.5×10 ¹ /2.7×10 ⁻²	5.5×10 ¹ /2.7×10 ⁻²	5.4×10 ¹ /2.7×10 ⁻²	5.5×10 ¹ /2.7×10 ⁻²	5.5×10 ¹ /2.7×10 ⁻²	5.5×10 ¹ /2.7×10 ⁻²
Workers (person-rem/LCFs)	2.5×10 ² /9.9×10 ⁻²	8.1×10 ¹ /3.2×10 ⁻²	8.1×10 ¹ /3.2×10 ⁻²	7.9×10 ¹ /3.2×10 ⁻²	8.1×10 ¹ /3.2×10 ⁻²	8.1×10 ¹ /3.2×10 ⁻²	8.1×10 ¹ /3.2×10 ⁻²
<i>Accident dose risk</i>							
Population (person-rem/LCFs)	8.8×10 ⁻³ /4.4×10 ⁻⁶	2.4×10 ⁻² /1.2×10 ⁻⁵	2.4×10 ⁻² /1.2×10 ⁻⁵	2.3×10 ⁻² /1.2×10 ⁻⁵	2.4×10 ⁻² /1.2×10 ⁻⁵	2.4×10 ⁻² /1.2×10 ⁻⁵	2.4×10 ⁻² /1.2×10 ⁻⁵
<i>Nonradiological impacts</i>							
Vehicle emissions (LCFs)	2.5×10 ⁻²	2.6×10 ⁻²	2.6×10 ⁻²	2.6×10 ⁻²	2.6×10 ⁻²	2.6×10 ⁻²	2.6×10 ⁻²
Fatalities	0.05	0.12	0.12	0.12	0.12	0.12	0.12
MICHIGAN							
<i>Shipments</i>							
Truck (originating/total)	1,728/1,728	0/0	0/0	0/0	0/0	0/0	0/0
Rail (originating/total)	0/0	287/287	287/287	287/287	287/287	287/287	287/287
<i>Radiological impacts</i>							
<i>Incident-free impacts</i>							
Population (person-rem/LCFs) ^b	8.7×10 ⁰ /4.3×10 ⁻³	4.7×10 ⁰ /2.4×10 ⁻³	4.7×10 ⁰ /2.4×10 ⁻³	4.7×10 ⁰ /2.4×10 ⁻³	4.7×10 ⁰ /2.4×10 ⁻³	4.7×10 ⁰ /2.4×10 ⁻³	4.7×10 ⁰ /2.4×10 ⁻³
Workers (person-rem/LCFs)	4.9×10 ¹ /2.0×10 ⁻²	1.7×10 ¹ /6.7×10 ⁻³	1.7×10 ¹ /6.7×10 ⁻³	1.7×10 ¹ /6.7×10 ⁻³	1.7×10 ¹ /6.7×10 ⁻³	1.7×10 ¹ /6.7×10 ⁻³	1.7×10 ¹ /6.7×10 ⁻³
<i>Accident dose risk</i>							
Population (person-rem/LCFs)	6.0×10 ⁻⁴ /3.0×10 ⁻⁷	4.9×10 ⁻³ /2.4×10 ⁻⁶	4.9×10 ⁻³ /2.4×10 ⁻⁶	4.9×10 ⁻³ /2.4×10 ⁻⁶	4.9×10 ⁻³ /2.4×10 ⁻⁶	4.9×10 ⁻³ /2.4×10 ⁻⁶	4.9×10 ⁻³ /2.4×10 ⁻⁶
<i>Nonradiological impacts</i>							
Vehicle emissions (LCFs)	1.4×10 ⁻³	1.6×10 ⁻³	1.6×10 ⁻³	1.6×10 ⁻³	1.6×10 ⁻³	1.6×10 ⁻³	1.6×10 ⁻³
Fatalities	0.006	0.010	0.010	0.010	0.010	0.010	0.010
OHIO							
<i>Shipments</i>							
Truck (originating/total)	636/12,121	0/580	0/580	0/580	0/580	0/580	0/580
Rail (originating/total)	0/0	106/2,381	106/2,381	106/2,381	106/2,381	106/2,381	106/2,381
<i>Radiological impacts</i>							
<i>Incident-free impacts</i>							
Population (person-rem/LCFs) ^b	1.6×10 ² /7.9×10 ⁻²	8.5×10 ¹ /4.3×10 ⁻²	8.5×10 ¹ /4.3×10 ⁻²	8.5×10 ¹ /4.3×10 ⁻²	8.5×10 ¹ /4.3×10 ⁻²	8.5×10 ¹ /4.3×10 ⁻²	8.5×10 ¹ /4.3×10 ⁻²
Workers (person-rem/LCFs)	3.2×10 ² /1.3×10 ⁻¹	9.1×10 ¹ /3.6×10 ⁻²	9.1×10 ¹ /3.6×10 ⁻²	9.1×10 ¹ /3.6×10 ⁻²	9.1×10 ¹ /3.6×10 ⁻²	9.1×10 ¹ /3.6×10 ⁻²	9.1×10 ¹ /3.6×10 ⁻²
<i>Accident dose risk</i>							
Population (person-rem/LCFs)	7.7×10 ⁻³ /3.8×10 ⁻⁶	2.6×10 ⁻² /1.3×10 ⁻⁵	2.6×10 ⁻² /1.3×10 ⁻⁵	2.6×10 ⁻² /1.3×10 ⁻⁵	2.6×10 ⁻² /1.3×10 ⁻⁵	2.6×10 ⁻² /1.3×10 ⁻⁵	2.6×10 ⁻² /1.3×10 ⁻⁵
<i>Nonradiological impacts</i>							
Vehicle emissions (LCFs)	3.1×10 ⁻²	3.9×10 ⁻²	3.9×10 ⁻²	3.9×10 ⁻²	3.9×10 ⁻²	3.9×10 ⁻²	3.9×10 ⁻²
Fatalities	0.04	0.08	0.08	0.08	0.08	0.08	0.08

- Under the mostly rail scenario, rail shipments would arrive in Nevada at one of six existing rail nodes. Impacts would vary according to the node. From that node, DOE would use one of the rail or heavy-haul implementing alternatives to complete the transportation to Yucca Mountain (see Section J.1.2).
- For heavy-haul truck transportation, the Caliente junction is the location of the proposed Caliente intermodal transfer station for heavy-haul trucks near the town of Caliente in eastern Nevada. Rail shipments terminating at this junction would continue to Yucca Mountain on heavy-haul trucks on one of the Caliente, Caliente/Chalk Mountain, or Caliente/Las Vegas routes. For branch rail line transportation, railcars would transfer via the Caliente Option to the Caliente Corridor at the Caliente junction.
- For heavy-haul truck transportation, the Dry Lake junction is near the location of the proposed Apex/Dry Lake intermodal transfer station for heavy-haul trucks in southeast Nevada. Rail shipments terminating at this junction would continue to Yucca Mountain on heavy-haul trucks on the Apex/Dry Lake route.

Table J-81. Estimated transportation impacts for the States of Indiana, Michigan, and Ohio (page 2 of 2).

- d. For heavy-haul truck transportation, the Jean junction is near the location of the proposed Sloan/Jean intermodal transfer station for heavy-haul trucks in southern Nevada. Rail shipments terminating at this junction would continue to Yucca Mountain on heavy-haul trucks on the Sloan/Jean route. For branch rail line transportation, railcars would transfer from the mainline railroad via the Wilson Pass or Stateline Pass Option of the Jean Corridor, near the Jean junction.
- e. For branch rail line transportation, railcars would transfer from the mainline railroad at the Beowawe junction in north-central Nevada to the Carlin Corridor.
- f. For branch rail line transportation, railcars would transfer from the mainline railroad at the Eccles junction east of Caliente, Nevada, via the Eccles Option or nearby via the Crestline Option of the Caliente or Caliente-Chalk Mountain Corridor. Impacts in states outside Nevada would be the same for the Eccles and Crestline Options of the Caliente and Caliente-Chalk Mountain Corridors.
- g. For branch rail line transportation, railcars would transfer from the mainline railroad at the Apex junction in southeast Nevada, possibly via the Valley Connection, to the Valley Modified Corridor.
- h. LCF = latent cancer fatality.

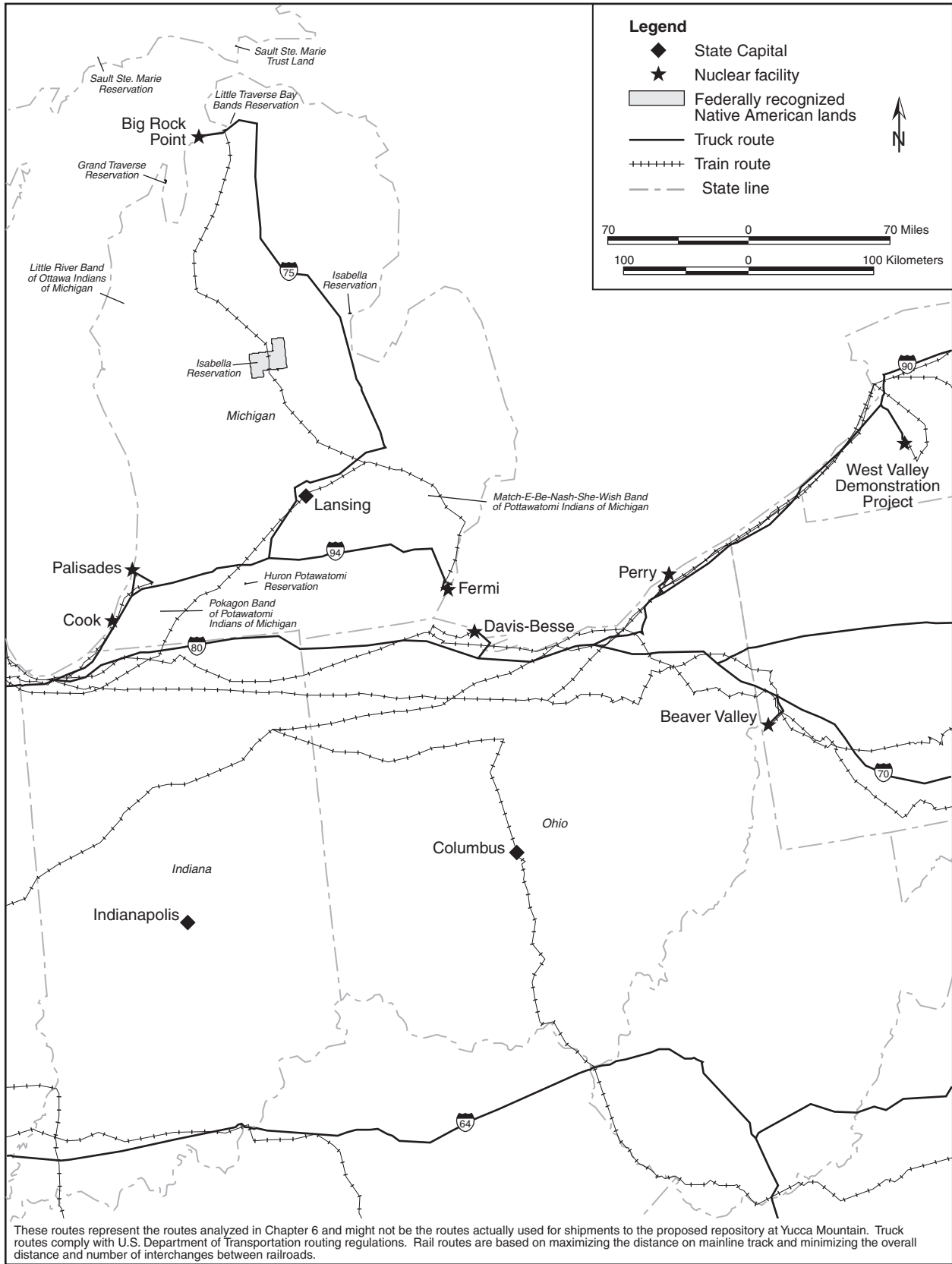

Figure J-41. Highway and rail routes used to analyze transportation impacts - Indiana, Michigan, and Ohio.

Table J-82. Estimated transportation impacts for the State of Illinois.

Impact category	Mostly legal-weight truck	Mostly rail					
		Ending rail node in Nevada ^a					
		Caliente ^b	Dry Lake ^c	Jean ^d	Beowawe ^e	Eccles ^f	Apex ^g
ILLINOIS							
<i>Shipments</i>							
Truck (originating/total)	5,306/38,549	0/1,071	0/1,071	0/1,071	0/1,071	0/1,071	0/1,071
Rail (originating/total)	0/0	861/7,027	861/7,027	861/6,825	861/7,027	861/7,027	861/7,027
<i>Radiological impacts</i>							
<i>Incident-free impacts</i>							
Population (person-rem/LCFs) ^h	2.8×10 ² /1.4×10 ⁻¹	1.8×10 ² /8.9×10 ⁻²	1.8×10 ² /8.9×10 ⁻²	1.8×10 ² /7.4×10 ⁻²	1.8×10 ² /8.9×10 ⁻²	1.8×10 ² /8.9×10 ⁻²	1.8×10 ² /8.9×10 ⁻²
Workers (person-rem/LCFs)	7.6×10 ² /3.1×10 ⁻¹	1.9×10 ² /7.5×10 ⁻²	1.9×10 ² /7.5×10 ⁻²	1.8×10 ² /7.4×10 ⁻²	1.9×10 ² /7.5×10 ⁻²	1.9×10 ² /7.5×10 ⁻²	1.9×10 ² /7.5×10 ⁻²
<i>Accident dose risk</i>							
Population (person-rem/LCFs)	1.6×10 ⁻² /8.1×10 ⁻⁶	1.6×10 ⁻¹ /7.9×10 ⁻⁵	1.6×10 ⁻¹ /7.9×10 ⁻⁵	1.5×10 ⁻¹ /7.7×10 ⁻⁵	1.6×10 ⁻¹ /7.9×10 ⁻⁵	1.6×10 ⁻¹ /7.9×10 ⁻⁵	1.6×10 ⁻¹ /7.9×10 ⁻⁵
<i>Nonradiological impacts</i>							
Vehicle emissions (LCFs)	4.5×10 ⁻²	8.0×10 ⁻²	8.0×10 ⁻²	7.9×10 ⁻²	8.0×10 ⁻²	8.0×10 ⁻²	8.0×10 ⁻²
Fatalities	0.17	0.19	0.19	0.18	0.19	0.19	0.19

- a. Under the mostly rail scenario, rail shipments would arrive in Nevada at one of six existing rail nodes. Impacts would vary according to the node. From that node, DOE would use one of the rail or heavy-haul implementing alternatives to complete the transportation to Yucca Mountain (see Section J.1.2).
- b. For heavy-haul truck transportation, the Caliente junction is the location of the proposed Caliente intermodal transfer station for heavy-haul trucks near the town of Caliente in eastern Nevada. Rail shipments terminating at this junction would continue to Yucca Mountain on heavy-haul trucks on one of the Caliente, Caliente/Chalk Mountain, or Caliente/Las Vegas routes. For branch rail line transportation, railcars would transfer via the Caliente Option to the Caliente Corridor at the Caliente junction.
- c. For heavy-haul truck transportation, the Dry Lake junction is near the location of the proposed Apex/Dry Lake intermodal transfer station for heavy-haul trucks in southeast Nevada. Rail shipments terminating at this junction would continue to Yucca Mountain on heavy-haul trucks on the Apex/Dry Lake route.
- d. For heavy-haul truck transportation, the Jean junction is near the location of the proposed Sloan/Jean intermodal transfer station for heavy-haul trucks in southern Nevada. Rail shipments terminating at this junction would continue to Yucca Mountain on heavy-haul trucks on the Sloan/Jean route. For branch rail line transportation, railcars would transfer from the mainline railroad via the Wilson Pass or Stateline Pass Option of the Jean Corridor, near the Jean junction.
- e. For branch rail line transportation, railcars would transfer from the mainline railroad at the Beowawe junction in north-central Nevada to the Carlin Corridor.
- f. For branch rail line transportation, railcars would transfer from the mainline railroad at the Eccles junction east of Caliente, Nevada, via the Eccles Option or nearby via the Crestline Option of the Caliente or Caliente-Chalk Mountain Corridor. Impacts in states outside Nevada would be the same for the Eccles and Crestline Options of the Caliente and Caliente-Chalk Mountain Corridors.
- g. For branch rail line transportation, railcars would transfer from the mainline railroad at the Apex junction in southeast Nevada, possibly via the Valley Connection, to the Valley Modified Corridor.
- h. LCF = latent cancer fatality.

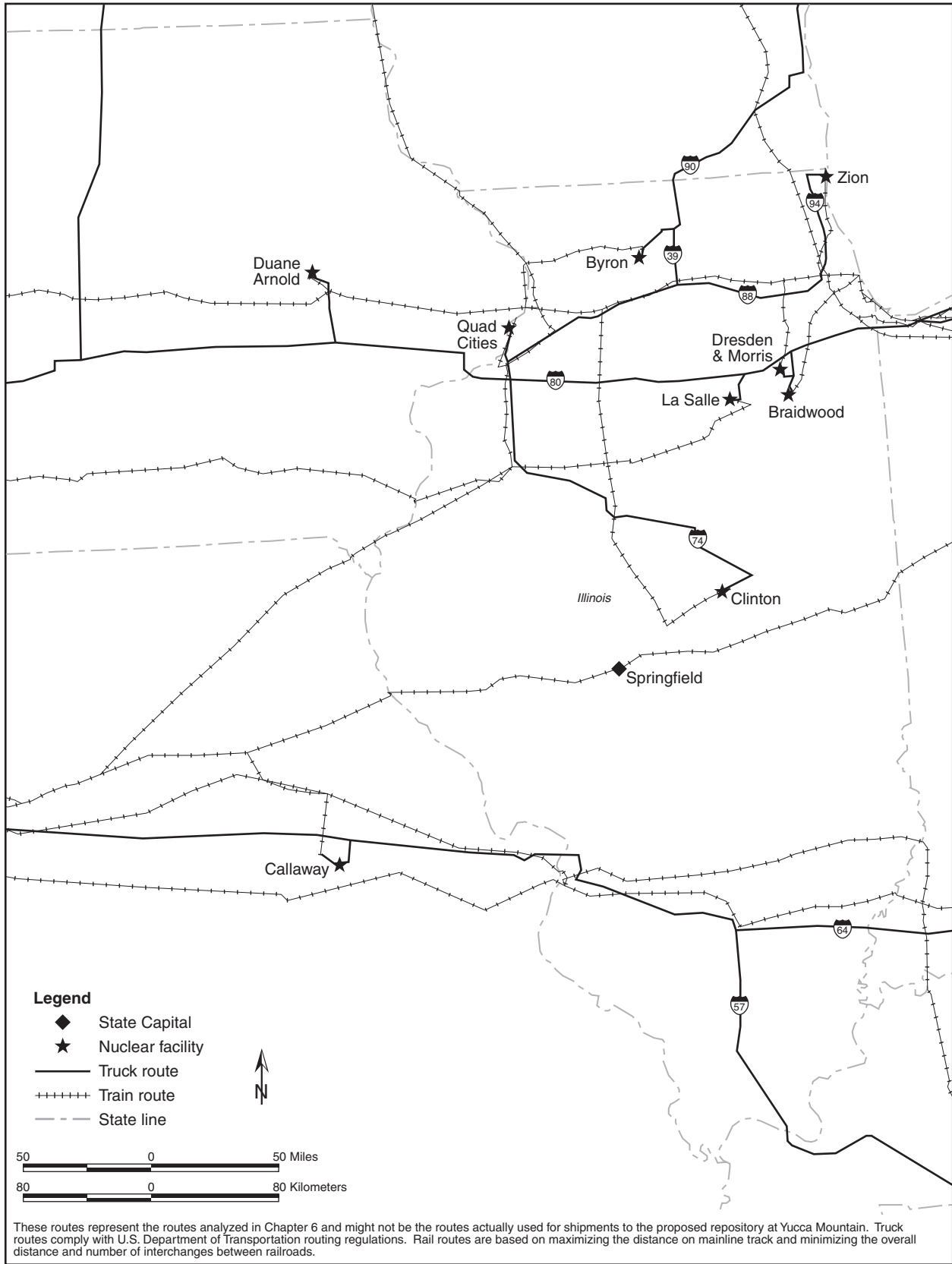

Figure J-42. Highway and rail routes used to analyze transportation impacts - Illinois.

Table J-83. Estimated transportation impacts for the States of Kentucky and Tennessee.

Impact category	Mostly legal-weight truck	Mostly rail					
		Ending rail node in Nevada ^a					
		Caliente ^b	Dry Lake ^c	Jean ^d	Beowawe ^e	Eccles ^f	Apex ^g
KENTUCKY							
<i>Shipments</i>							
Truck (originating/total)	0/18,435	0/491	0/491	0/491	0/491	0/491	0/491
Rail (originating/total)	0/0	0/3,312	0/3,312	0/3,110	0/3,312	0/3,312	0/3,312
<i>Radiological impacts</i>							
<i>Incident-free impacts</i>							
Population (person-rem/LCFs) ^h	8.3×10 ¹ /4.2×10 ⁻²	2.0×10 ¹ /1.0×10 ⁻²	2.0×10 ¹ /1.0×10 ⁻²	1.9×10 ¹ /9.6×10 ⁻³	2.0×10 ¹ /1.0×10 ⁻²	2.0×10 ¹ /1.0×10 ⁻²	2.0×10 ¹ /1.0×10 ⁻²
Workers (person-rem/LCFs)	2.2×10 ² /8.7×10 ⁻²	4.9×10 ¹ /1.9×10 ⁻²	4.9×10 ¹ /1.9×10 ⁻²	4.7×10 ¹ /1.9×10 ⁻²	4.9×10 ¹ /1.9×10 ⁻²	4.9×10 ¹ /1.9×10 ⁻²	4.9×10 ¹ /1.9×10 ⁻²
<i>Accident dose risk</i>							
Population (person-rem/LCFs)	5.2×10 ⁻³ /2.6×10 ⁻⁶	4.2×10 ⁻³ /2.1×10 ⁻⁶	4.2×10 ⁻³ /2.1×10 ⁻⁶	3.9×10 ⁻³ /2.0×10 ⁻⁶	4.2×10 ⁻³ /2.1×10 ⁻⁶	4.2×10 ⁻³ /2.1×10 ⁻⁶	3.9×10 ⁻³ /2.0×10 ⁻⁶
<i>Nonradiological impacts</i>							
Vehicle emissions (LCFs)	1.1×10 ⁻²	9.7×10 ⁻³	9.7×10 ⁻³	9.3×10 ⁻³	9.7×10 ⁻³	9.7×10 ⁻³	9.7×10 ⁻³
Fatalities	0.086	0.041	0.041	0.039	0.041	0.041	0.041
TENNESSEE							
<i>Shipments</i>							
Truck (originating/total)	802/15,026	0/491	0/491	0/491	0/491	0/491	0/491
Rail (originating/total)	0/0	121/3,312	121/3,312	121/3,110	121/3,312	121/3,312	121/3,312
<i>Radiological impacts</i>							
<i>Incident-free impacts</i>							
Population (person-rem/LCFs) ^h	1.4×10 ² /6.9×10 ⁻²	5.5×10 ¹ /2.7×10 ⁻²	5.5×10 ¹ /2.7×10 ⁻²	5.1×10 ¹ /2.5×10 ⁻²	5.5×10 ¹ /2.7×10 ⁻²	5.5×10 ¹ /2.7×10 ⁻²	5.5×10 ¹ /2.7×10 ⁻²
Workers (person-rem/LCFs)	3.1×10 ² /1.2×10 ⁻¹	8.2×10 ¹ /3.3×10 ⁻²	8.2×10 ¹ /3.3×10 ⁻²	7.7×10 ¹ /3.1×10 ⁻²	8.2×10 ¹ /3.3×10 ⁻²	8.2×10 ¹ /3.3×10 ⁻²	8.2×10 ¹ /3.3×10 ⁻²
<i>Accident dose risk</i>							
Population (person-rem/LCFs)	4.7×10 ⁻³ /2.4×10 ⁻⁶	1.1×10 ⁻² /5.5×10 ⁻⁶	1.1×10 ⁻² /5.5×10 ⁻⁶	9.0×10 ⁻³ /4.5×10 ⁻⁶	1.1×10 ⁻² /5.5×10 ⁻⁶	1.1×10 ⁻² /5.5×10 ⁻⁶	1.1×10 ⁻² /5.5×10 ⁻⁶
<i>Nonradiological impacts</i>							
Vehicle emissions (LCFs)	2.8×10 ⁻²	2.7×10 ⁻²	2.7×10 ⁻²	2.5×10 ⁻²	2.7×10 ⁻²	2.7×10 ⁻²	2.7×10 ⁻²
Fatalities	0.09	0.07	0.07	0.07	0.07	0.07	0.07

- a. Under the mostly rail scenario, rail shipments would arrive in Nevada at one of six existing rail nodes. Impacts would vary according to the node. From that node, DOE would use one of the rail or heavy-haul implementing alternatives to complete the transportation to Yucca Mountain (see Section J.1.2).
- b. For heavy-haul truck transportation, the Caliente junction is the location of the proposed Caliente intermodal transfer station for heavy-haul trucks near the town of Caliente in eastern Nevada. Rail shipments terminating at this junction would continue to Yucca Mountain on heavy-haul trucks on one of the Caliente, Caliente/Chalk Mountain, or Caliente/Las Vegas routes. For branch rail line transportation, railcars would transfer via the Caliente Option to the Caliente Corridor at the Caliente junction.
- c. For heavy-haul truck transportation, the Dry Lake junction is near the location of the proposed Apex/Dry Lake intermodal transfer station for heavy-haul trucks in southeast Nevada. Rail shipments terminating at this junction would continue to Yucca Mountain on heavy-haul trucks on the Apex/Dry Lake route.
- d. For heavy-haul truck transportation, the Jean junction is near the location of the proposed Sloan/Jean intermodal transfer station for heavy-haul trucks in southern Nevada. Rail shipments terminating at this junction would continue to Yucca Mountain on heavy-haul trucks on the Sloan/Jean route. For branch rail line transportation, railcars would transfer from the mainline railroad via the Wilson Pass or Stateline Pass Option of the Jean Corridor, near the Jean junction.
- e. For branch rail line transportation, railcars would transfer from the mainline railroad at the Beowawe junction in north-central Nevada to the Carlin Corridor.
- f. For branch rail line transportation, railcars would transfer from the mainline railroad at the Eccles junction east of Caliente, Nevada, via the Eccles Option or nearby via the Crestline Option of the Caliente or Caliente-Chalk Mountain Corridor. Impacts in states outside Nevada would be the same for the Eccles and Crestline Options of the Caliente and Caliente-Chalk Mountain Corridors.
- g. For branch rail line transportation, railcars would transfer from the mainline railroad at the Apex junction in southeast Nevada, possibly via the Valley Connection, to the Valley Modified Corridor.
- h. LCF = latent cancer fatality.

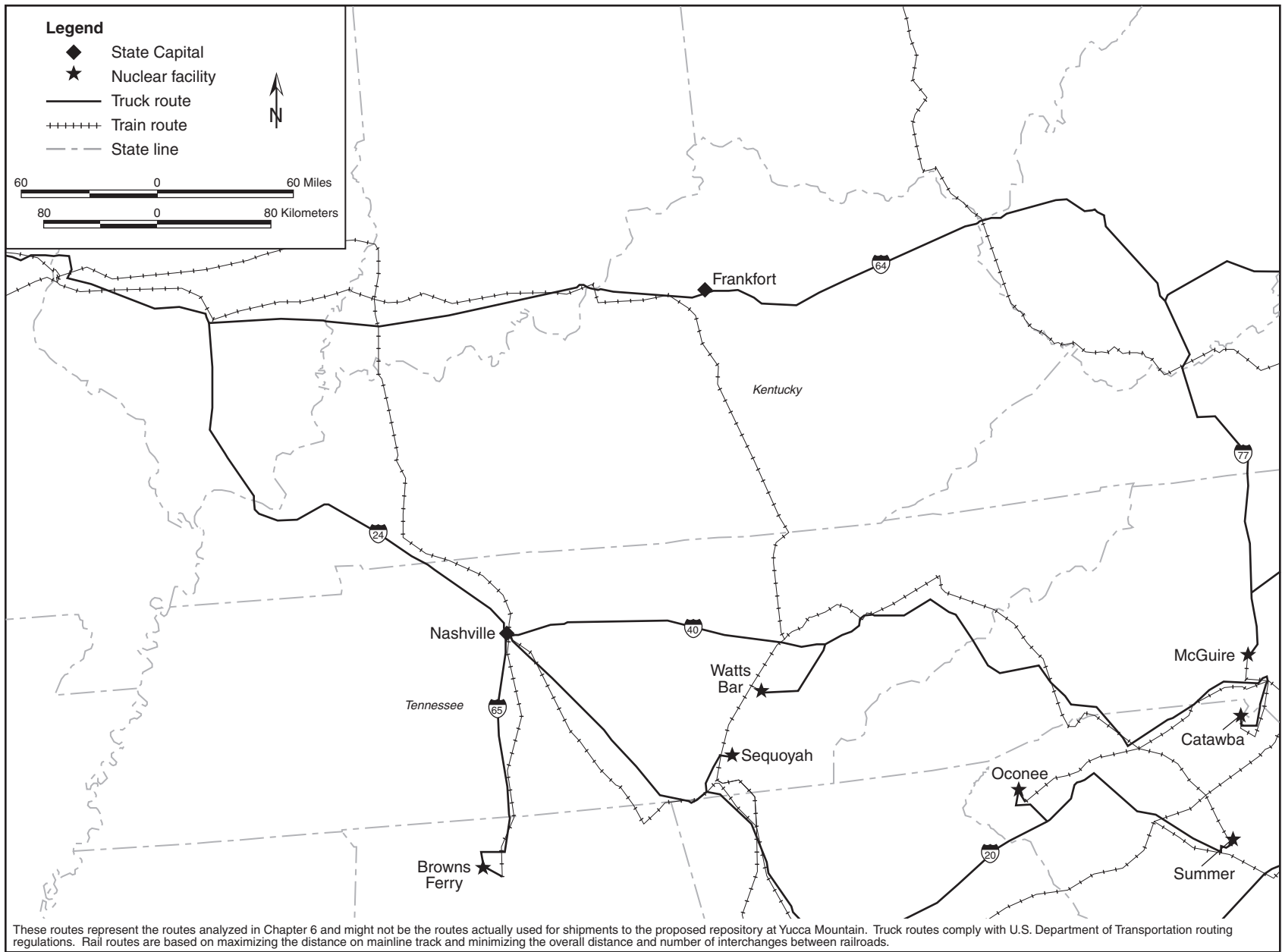

Figure J-43. Highway and rail routes used to analyze transportation impacts - Kentucky and Tennessee.

Table J-84. Estimated transportation impacts for the States of Louisiana and Mississippi.

Impact category	Mostly legal-weight truck	Mostly rail					
		Ending rail node in Nevada ^a					
		Caliente ^b	Dry Lake ^c	Jean ^d	Beowawe ^e	Eccles ^d	Apex ^e
LOUISIANA							
<i>Shipments</i>							
Truck (originating/total)	727/2,012	0/0	0/0	0/0	0/0	0/0	0/0
Rail (originating/total)	0/0	123/203	123/203	123/405	123/203	123/203	123/203
<i>Radiological impacts</i>							
<i>Incident-free impacts</i>							
Population (person-rem/LCFs) ^h	2.6×10 ⁰ /1.3×10 ⁻²	2.9×10 ⁰ /1.5×10 ⁻³	2.6×10 ⁰ /1.3×10 ⁻³	7.5×10 ⁰ /3.8×10 ⁻³	3.0×10 ⁰ /1.5×10 ⁻³	2.9×10 ⁰ /1.5×10 ⁻³	2.6×10 ⁰ /1.3×10 ⁻³
Workers (person-rem/LCFs)	7.7×10 ¹ /3.1×10 ⁻²	1.1×10 ¹ /4.3×10 ⁻³	1.0×10 ¹ /4.1×10 ⁻³	1.7×10 ¹ /6.7×10 ⁻³	1.1×10 ¹ /4.4×10 ⁻³	1.1×10 ¹ /4.3×10 ⁻³	1.0×10 ¹ /4.1×10 ⁻³
<i>Accident dose risk</i>							
Population (person-rem/LCFs)	1.3×10 ⁻³ /6.6×10 ⁻⁷	2.9×10 ⁻³ /1.5×10 ⁻⁶	2.5×10 ⁻³ /1.3×10 ⁻⁶	9.3×10 ⁻³ /4.6×10 ⁻⁶	3.0×10 ⁻³ /1.5×10 ⁻⁶	2.9×10 ⁻³ /1.5×10 ⁻⁶	2.5×10 ⁻³ /1.3×10 ⁻⁶
<i>Nonradiological impacts</i>							
Vehicle emissions (LCFs)	3.91×10 ⁻³	1.06×10 ⁻³	8.98×10 ⁻⁴	3.31×10 ⁻³	1.08×10 ⁻³	1.06×10 ⁻³	8.98×10 ⁻⁴
Fatalities	0.018	0.018	0.016	0.037	0.018	0.018	0.016
MISSISSIPPI							
<i>Shipments</i>							
Truck (originating/total)	592/1,285	0/0	0/0	0/0	0/0	0/0	0/0
Rail (originating/total)	0/0	80/80	80/80	80/282	80/80	80/80	80/80
<i>Radiological impacts</i>							
<i>Incident-free impacts</i>							
Population (person-rem/LCFs) ^h	2.8×10 ⁰ /1.4×10 ⁻³	6.2×10 ⁻¹ /3.1×10 ⁻⁴	6.2×10 ⁻¹ /3.1×10 ⁻⁴	2.7×10 ⁰ /1.3×10 ⁻³	6.2×10 ⁻¹ /3.1×10 ⁻⁴	6.2×10 ⁻¹ /3.1×10 ⁻⁴	6.2×10 ⁻¹ /3.1×10 ⁻⁴
Workers (person-rem/LCFs)	1.8×10 ¹ /7.3×10 ⁻³	4.3×10 ⁰ /1.7×10 ⁻³	4.3×10 ⁰ /1.7×10 ⁻³	6.1×10 ¹ /2.4×10 ⁻³	4.3×10 ⁰ /1.7×10 ⁻³	4.3×10 ⁰ /1.7×10 ⁻³	4.3×10 ⁰ /1.7×10 ⁻³
<i>Accident dose risk</i>							
Population (person-rem/LCFs)	2.3×10 ⁻⁵ /1.1×10 ⁻⁸	1.1×10 ⁻⁵ /5.7×10 ⁻⁹	1.1×10 ⁻⁵ /5.7×10 ⁻⁹	3.3×10 ⁻³ /1.7×10 ⁻⁶	1.1×10 ⁻⁵ /5.7×10 ⁻⁹	1.1×10 ⁻⁵ /5.7×10 ⁻⁹	1.1×10 ⁻⁵ /5.7×10 ⁻⁹
<i>Nonradiological impacts</i>							
Vehicle emissions (LCFs)	2.7×10 ⁻⁴	8.5×10 ⁻⁶	8.5×10 ⁻⁶	1.1×10 ⁻³	8.5×10 ⁻⁶	8.5×10 ⁻⁶	8.5×10 ⁻⁶
Fatalities	5.9×10 ⁻⁴	3.7×10 ⁻⁴	3.7×10 ⁻⁴	4.3×10 ⁻³	3.7×10 ⁻⁴	3.7×10 ⁻⁴	3.7×10 ⁻⁴

- a. Under the mostly rail scenario, rail shipments would arrive in Nevada at one of six existing rail nodes. Impacts would vary according to the node. From that node, DOE would use one of the rail or heavy-haul implementing alternatives to complete the transportation to Yucca Mountain (see Section J.1.2).
- b. For heavy-haul truck transportation, the Caliente junction is the location of the proposed Caliente intermodal transfer station for heavy-haul trucks near the town of Caliente in eastern Nevada. Rail shipments terminating at this junction would continue to Yucca Mountain on heavy-haul trucks on one of the Caliente, Caliente/Chalk Mountain, or Caliente/Las Vegas routes. For branch rail line transportation, railcars would transfer via the Caliente Option to the Caliente Corridor at the Caliente junction.
- c. For heavy-haul truck transportation, the Dry Lake junction is near the location of the proposed Apex/Dry Lake intermodal transfer station for heavy-haul trucks in southeast Nevada. Rail shipments terminating at this junction would continue to Yucca Mountain on heavy-haul trucks on the Apex/Dry Lake route.
- d. For heavy-haul truck transportation, the Jean junction is near the location of the proposed Sloan/Jean intermodal transfer station for heavy-haul trucks in southern Nevada. Rail shipments terminating at this junction would continue to Yucca Mountain on heavy-haul trucks on the Sloan/Jean route. For branch rail line transportation, railcars would transfer from the mainline railroad via the Wilson Pass or Stateline Pass Option of the Jean Corridor, near the Jean junction.
- e. For branch rail line transportation, railcars would transfer from the mainline railroad at the Beowawe junction in north-central Nevada to the Carlin Corridor.
- f. For branch rail line transportation, railcars would transfer from the mainline railroad at the Eccles junction east of Caliente, Nevada, via the Eccles Option or nearby via the Crestline Option of the Caliente or Caliente-Chalk Mountain Corridor. Impacts in states outside Nevada would be the same for the Eccles and Crestline Options of the Caliente and Caliente-Chalk Mountain Corridors.
- g. For branch rail line transportation, railcars would transfer from the mainline railroad at the Apex junction in southeast Nevada, possibly via the Valley Connection, to the Valley Modified Corridor.
- h. LCF = latent cancer fatality.

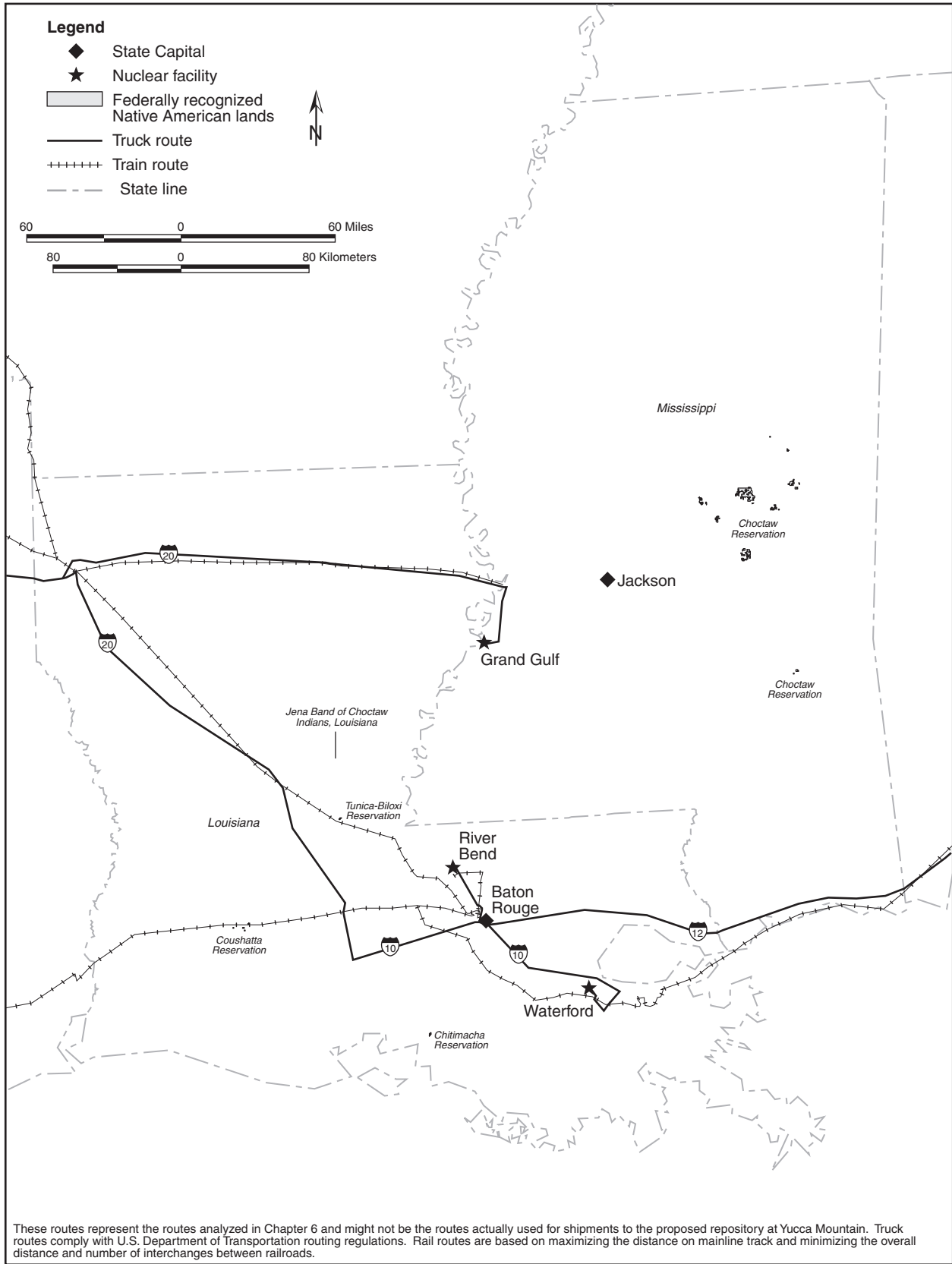

Figure J-44. Highway and rail routes used to analyze transportation impacts - Louisiana and Mississippi.

Table J-85. Estimated transportation impacts for the States of Maine, Massachusetts, New Hampshire, and Vermont (page 1 of 2).

Impact category	Mostly legal-weight truck	Mostly rail					
		Ending rail node in Nevada ^a					
		Caliente ^b	Dry Lake ^c	Jean ^d	Beowawe ^e	Eccles ^f	Apex ^g
MAINE							
<i>Shipments</i>							
Truck (originating/total)	356/356	0/0	0/0	0/0	0/0	0/0	0/0
Rail (originating/total)	0/0	55/55	55/55	55/55	55/55	55/55	55/55
<i>Radiological impacts</i>							
Incident-free impacts							
Population (person-rem/LCFs) ^h	1.9×10 ⁰ /9.5×10 ⁻⁴	5.2×10 ⁻¹ /2.6×10 ⁻⁴	5.2×10 ⁻¹ /2.6×10 ⁻⁴	5.2×10 ⁻¹ /2.6×10 ⁻⁴	5.2×10 ⁻¹ /2.6×10 ⁻⁴	5.2×10 ⁻¹ /2.6×10 ⁻⁴	5.2×10 ⁻¹ /2.6×10 ⁻⁴
Workers (person-rem/LCFs)	9.9×10 ⁰ /4.0×10 ⁻³	3.2×10 ⁰ /1.3×10 ⁻³	3.2×10 ⁰ /1.3×10 ⁻³	3.2×10 ⁰ /1.3×10 ⁻³	3.2×10 ⁰ /1.3×10 ⁻³	3.2×10 ⁰ /1.3×10 ⁻³	3.2×10 ⁰ /1.3×10 ⁻³
Accident dose risk							
Population (person-rem/LCFs)	2.2×10 ⁻⁴ /1.1×10 ⁻⁷	1.1×10 ⁻³ /5.6×10 ⁻⁷	1.1×10 ⁻³ /5.6×10 ⁻⁷	1.1×10 ⁻³ /5.6×10 ⁻⁷	1.1×10 ⁻³ /5.6×10 ⁻⁷	1.1×10 ⁻³ /5.6×10 ⁻⁷	1.1×10 ⁻³ /5.6×10 ⁻⁷
<i>Nonradiological impacts</i>							
Vehicle emissions (LCFs)	2.9×10 ⁻⁴	1.7×10 ⁻⁴	1.7×10 ⁻⁴	1.7×10 ⁻⁴	1.7×10 ⁻⁴	1.7×10 ⁻⁴	1.7×10 ⁻⁴
Fatalities	9.7×10 ⁻⁴	2.9×10 ⁻³	2.9×10 ⁻³	2.9×10 ⁻³	2.9×10 ⁻³	2.9×10 ⁻³	2.9×10 ⁻³
MASSACHUSETTS							
<i>Shipments</i>							
Truck (originating/total)	456/1,469	154/154	154/154	154/154	154/154	154/154	154/154
Rail (originating/total)	0/0	39/511	39/511	39/511	39/511	39/511	39/511
<i>Radiological impacts</i>							
Incident-free impacts							
Population (person-rem/LCFs) ^h	1.5×10 ¹ /7.3×10 ⁻³	7.9×10 ⁰ /4.0×10 ⁻³	7.9×10 ⁰ /4.0×10 ⁻³	7.9×10 ⁰ /4.0×10 ⁻³	7.9×10 ⁰ /4.0×10 ⁻³	7.9×10 ⁰ /4.0×10 ⁻³	7.9×10 ⁰ /4.0×10 ⁻³
Workers (person-rem/LCFs)	3.0×10 ¹ /1.2×10 ⁻²	1.3×10 ¹ /1.5×10 ⁻³	1.3×10 ¹ /1.5×10 ⁻³	1.3×10 ¹ /1.5×10 ⁻³	1.3×10 ¹ /1.5×10 ⁻³	1.3×10 ¹ /1.5×10 ⁻³	1.3×10 ¹ /1.5×10 ⁻³
Accident dose risk							
Population (person-rem/LCFs)	4.8×10 ⁻⁴ /2.4×10 ⁻⁷	1.5×10 ⁻² /7.3×10 ⁻⁶	1.5×10 ⁻² /7.3×10 ⁻⁶	1.5×10 ⁻² /7.3×10 ⁻⁶	1.5×10 ⁻² /7.3×10 ⁻⁶	1.5×10 ⁻² /7.3×10 ⁻⁶	1.5×10 ⁻² /7.3×10 ⁻⁶
<i>Nonradiological impacts</i>							
Vehicle emissions (LCFs)	3.7×10 ⁻³	3.3×10 ⁻³	3.3×10 ⁻³	3.3×10 ⁻³	3.3×10 ⁻³	3.3×10 ⁻³	3.3×10 ⁻³
Fatalities	0.001	0.068	0.068	0.068	0.068	0.068	0.068
NEW HAMPSHIRE							
<i>Shipments</i>							
Truck (originating/total)	277/633	0/0	0/0	0/0	0/0	0/0	0/0
Rail (originating/total)	0/0	49/104	49/104	49/104	49/104	49/104	49/104
<i>Radiological impacts</i>							
Incident-free impacts							
Population (person-rem/LCFs) ^h	4.9×10 ⁻¹ /2.5×10 ⁻⁴	4.4×10 ⁻¹ /2.2×10 ⁻⁴	4.4×10 ⁻¹ /2.2×10 ⁻⁴	4.4×10 ⁻¹ /2.2×10 ⁻⁴	4.4×10 ⁻¹ /2.2×10 ⁻⁴	4.4×10 ⁻¹ /2.2×10 ⁻⁴	4.4×10 ⁻¹ /2.2×10 ⁻⁴
Workers (person-rem/LCFs)	5.7×10 ⁰ /2.3×10 ⁻³	2.7×10 ⁰ /1.1×10 ⁻³	2.7×10 ⁰ /1.1×10 ⁻³	2.7×10 ⁰ /1.1×10 ⁻³	2.7×10 ⁰ /1.1×10 ⁻³	2.7×10 ⁰ /1.1×10 ⁻³	2.7×10 ⁰ /1.1×10 ⁻³
Accident dose risk							
Population (person-rem/LCFs)	4.2×10 ⁻⁵ /2.1×10 ⁻⁸	8.5×10 ⁻⁴ /4.3×10 ⁻⁷	8.5×10 ⁻⁴ /4.3×10 ⁻⁷	8.5×10 ⁻⁴ /4.3×10 ⁻⁷	8.5×10 ⁻⁴ /4.3×10 ⁻⁷	8.5×10 ⁻⁴ /4.3×10 ⁻⁷	8.5×10 ⁻⁴ /4.3×10 ⁻⁷
<i>Nonradiological impacts</i>							
Vehicle emissions (LCFs)	8.9×10 ⁻⁵	1.4×10 ⁻⁴	1.4×10 ⁻⁴	1.4×10 ⁻⁴	1.4×10 ⁻⁴	1.4×10 ⁻⁴	1.4×10 ⁻⁴
Fatalities	1.2×10 ⁻⁴	1.0×10 ⁻³	1.0×10 ⁻³	1.0×10 ⁻³	1.0×10 ⁻³	1.0×10 ⁻³	1.0×10 ⁻³

Table J-85. Estimated transportation impacts for the States of Maine, Massachusetts, New Hampshire, and Vermont (page 2 of 2).

Impact category	Mostly legal-weight truck	Mostly rail					
		Ending rail node in Nevada ^a					
		Caliente ^b	Dry Lake ^c	Jean ^d	Beowawe ^e	Eccles ^f	Apex ^g
VERMONT							
<i>Shipments</i>							
Truck (originating/total)	380/380	0/0	0/0	0/0	0/0	0/0	0/0
Rail (originating/total)	0/0	73/192	73/192	73/192	73/192	73/192	73/192
<i>Radiological impacts</i>							
<i>Incident-free impacts</i>							
Population (person-rem/LCFs) ^h	4.1×10 ⁻¹ /2.1×10 ⁻⁴	1.6×10 ⁻¹ /7.8×10 ⁻⁵	1.6×10 ⁻¹ /7.8×10 ⁻⁵	1.6×10 ⁻¹ /7.8×10 ⁻⁵	1.6×10 ⁻¹ /7.8×10 ⁻⁵	1.6×10 ⁻¹ /7.8×10 ⁻⁵	1.6×10 ⁻¹ /7.8×10 ⁻⁵
Workers (person-rem/LCFs)	7.5×10 ⁰ /3.0×10 ⁻³	3.6×10 ⁰ /1.4×10 ⁻³	3.6×10 ⁰ /1.4×10 ⁻³	3.6×10 ⁰ /1.4×10 ⁻³	3.6×10 ⁰ /1.4×10 ⁻³	3.6×10 ⁰ /1.4×10 ⁻³	3.6×10 ⁰ /1.4×10 ⁻³
<i>Accident dose risk</i>							
Population (person-rem/LCFs)	2.4×10 ⁻⁵ /1.2×10 ⁻⁸	7.0×10 ⁻⁵ /3.5×10 ⁻⁸	7.0×10 ⁻⁵ /3.5×10 ⁻⁸	7.0×10 ⁻⁵ /3.5×10 ⁻⁸	7.0×10 ⁻⁵ /3.5×10 ⁻⁸	7.0×10 ⁻⁵ /3.5×10 ⁻⁸	7.0×10 ⁻⁵ /3.5×10 ⁻⁸
<i>Nonradiological impacts</i>							
Vehicle emissions (LCFs)	8.9×10 ⁻⁵	1.6×10 ⁻⁵	1.6×10 ⁻⁵	1.6×10 ⁻⁵	1.6×10 ⁻⁵	1.6×10 ⁻⁵	1.6×10 ⁻⁵
Fatalities	1.1×10 ⁻⁴	1.5×10 ⁻⁴	1.5×10 ⁻⁴	1.5×10 ⁻⁴	1.5×10 ⁻⁴	1.5×10 ⁻⁴	1.5×10 ⁻⁴

- a. Under the mostly rail scenario, rail shipments would arrive in Nevada at one of six existing rail nodes. Impacts would vary according to the node. From that node, DOE would use one of the rail or heavy-haul implementing alternatives to complete the transportation to Yucca Mountain (see Section J.1.2).
- b. For heavy-haul truck transportation, the Caliente junction is the location of the proposed Caliente intermodal transfer station for heavy-haul trucks near the town of Caliente in eastern Nevada. Rail shipments terminating at this junction would continue to Yucca Mountain on heavy-haul trucks on one of the Caliente, Caliente/Chalk Mountain, or Caliente/Las Vegas routes. For branch rail line transportation, railcars would transfer via the Caliente Option to the Caliente Corridor at the Caliente junction.
- c. For heavy-haul truck transportation, the Dry Lake junction is near the location of the proposed Apex/Dry Lake intermodal transfer station for heavy-haul trucks in southeast Nevada. Rail shipments terminating at this junction would continue to Yucca Mountain on heavy-haul trucks on the Apex/Dry Lake route.
- d. For heavy-haul truck transportation, the Jean junction is near the location of the proposed Sloan/Jean intermodal transfer station for heavy-haul trucks in southern Nevada. Rail shipments terminating at this junction would continue to Yucca Mountain on heavy-haul trucks on the Sloan/Jean route. For branch rail line transportation, railcars would transfer from the mainline railroad via the Wilson Pass or Stateline Pass Option of the Jean Corridor, near the Jean junction.
- e. For branch rail line transportation, railcars would transfer from the mainline railroad at the Beowawe junction in north-central Nevada to the Carlin Corridor.
- f. For branch rail line transportation, railcars would transfer from the mainline railroad at the Eccles junction east of Caliente, Nevada, via the Eccles Option or nearby via the Crestline Option of the Caliente or Caliente-Chalk Mountain Corridor. Impacts in states outside Nevada would be the same for the Eccles and Crestline Options of the Caliente and Caliente-Chalk Mountain Corridors.
- g. For branch rail line transportation, railcars would transfer from the mainline railroad at the Apex junction in southeast Nevada, possibly via the Valley Connection, to the Valley Modified Corridor.
- h. LCF = latent cancer fatality.

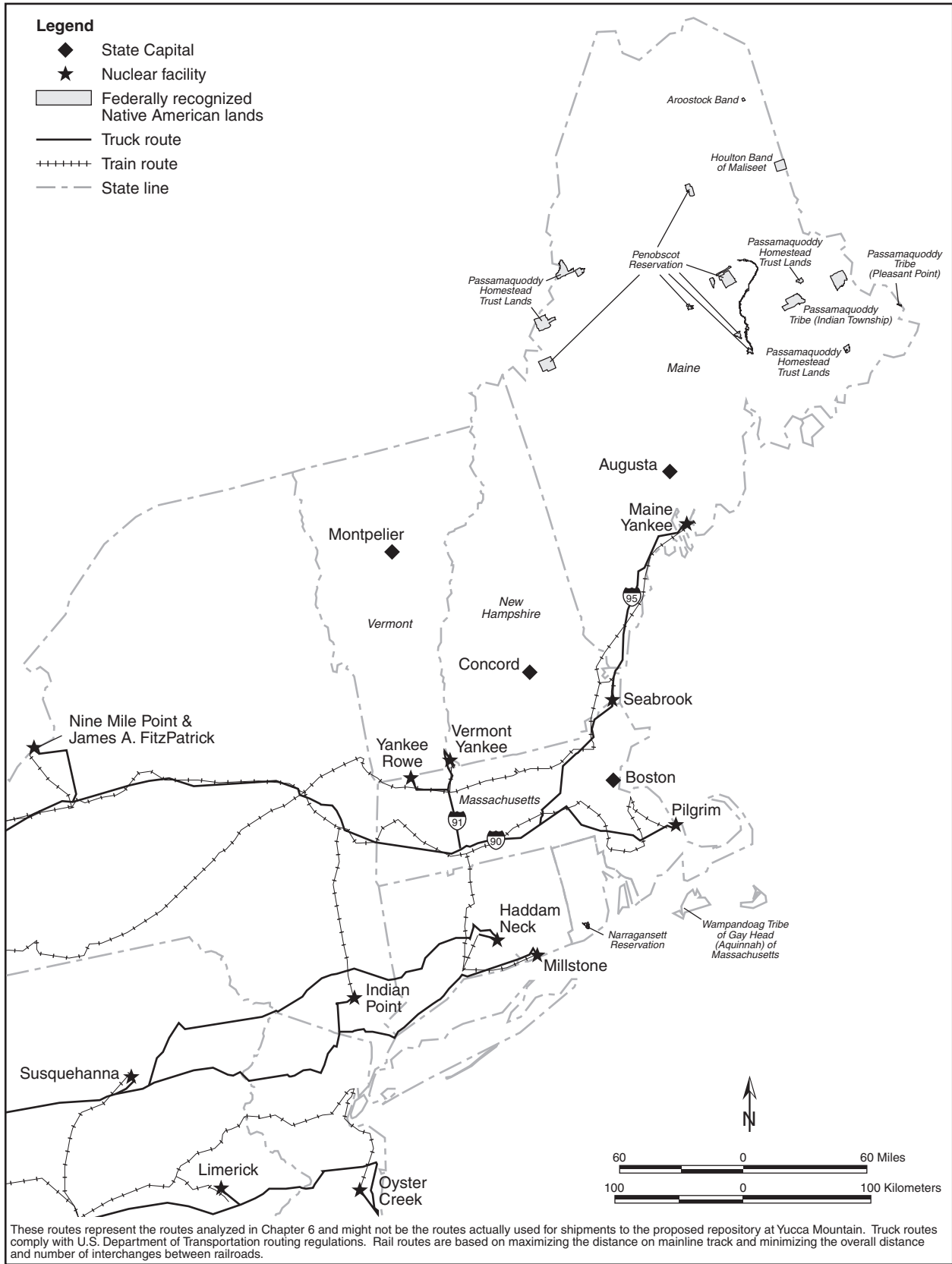

Figure J-45. Highway and rail routes used to analyze transportation impacts - Maine, Massachusetts, New Hampshire, and Vermont.

Table J-86. Estimated transportation impacts for the States of Minnesota and Wisconsin (page 1 of 2).

Impact category	Mostly legal-weight truck	Mostly rail					
		Ending rail node in Nevada					
		Caliente ^b	Dry Lake ^c	Jean ^d	Beowawe ^e	Eccles ^f	Apex ^g
MINNESOTA							
<i>Shipments</i>							
Truck (originating/total)	922/959	8/8	8/8	8/8	8/8	8/8	8/8
Rail (originating/total)	0/0	135/135	135/135	135/135	135/135	135/135	135/135
<i>Radiological impacts</i>							
<i>Incident-free impacts</i>							
Population (person-rem/LCFs) ^h	7.0×10 ⁰ /3.5×10 ⁻³	3.1×10 ⁰ /1.5×10 ⁻³	3.1×10 ⁰ /1.5×10 ⁻³	3.1×10 ⁰ /1.5×10 ⁻³	3.1×10 ⁰ /1.5×10 ⁻³	3.1×10 ⁰ /1.5×10 ⁻³	3.1×10 ⁰ /1.5×10 ⁻³
Workers (person-rem/LCFs)	3.1×10 ¹ /1.2×10 ⁻²	9.9×10 ⁰ /4.0×10 ⁻³	9.9×10 ⁰ /4.0×10 ⁻³	9.9×10 ⁰ /4.0×10 ⁻³	9.9×10 ⁰ /4.0×10 ⁻³	9.9×10 ⁰ /4.0×10 ⁻³	9.9×10 ⁰ /4.0×10 ⁻³
<i>Accident dose risk</i>							
Population (person-rem/LCFs)	4.1×10 ⁻⁴ /2.1×10 ⁻⁷	2.2×10 ⁻³ /1.1×10 ⁻⁶	2.2×10 ⁻³ /1.1×10 ⁻⁶	2.2×10 ⁻³ /1.1×10 ⁻⁶	2.2×10 ⁻³ /1.1×10 ⁻⁶	2.2×10 ⁻³ /1.1×10 ⁻⁶	2.2×10 ⁻³ /1.1×10 ⁻⁶
<i>Nonradiological impacts</i>							
Vehicle emissions (LCFs)	1.5×10 ⁻³	1.1×10 ⁻³	1.1×10 ⁻³	1.1×10 ⁻³	1.1×10 ⁻³	1.1×10 ⁻³	1.1×10 ⁻³
Fatalities	1.4×10 ⁻³	3.3×10 ⁻³	3.3×10 ⁻³	3.3×10 ⁻³	3.3×10 ⁻³	3.3×10 ⁻³	3.3×10 ⁻³
WISCONSIN							
<i>Shipments</i>							
Truck (originating/total)	996/996	0/0	0/0	0/0	0/0	0/0	0/0
Rail (originating/total)	0/0	186/186	186/186	186/186	186/186	186/186	186/186
<i>Radiological impacts</i>							
<i>Incident-free impacts</i>							
Population (person-rem/LCFs) ^h	1.1×10 ¹ /5.7×10 ⁻³	4.5×10 ⁰ /2.2×10 ⁻³	4.5×10 ⁰ /2.2×10 ⁻³	4.5×10 ⁰ /2.2×10 ⁻³	4.5×10 ⁰ /2.2×10 ⁻³	4.5×10 ⁰ /2.2×10 ⁻³	4.5×10 ⁰ /2.2×10 ⁻³
Workers (person-rem/LCFs)	3.7×10 ¹ /1.5×10 ⁻²	1.3×10 ¹ /5.3×10 ⁻³	1.3×10 ¹ /5.3×10 ⁻³	1.3×10 ¹ /5.3×10 ⁻³	1.3×10 ¹ /5.3×10 ⁻³	1.3×10 ¹ /5.3×10 ⁻³	1.3×10 ¹ /5.3×10 ⁻³
<i>Accident dose risk</i>							
Population (person-rem/LCFs)	2.3×10 ⁻³ /1.1×10 ⁻⁶	4.2×10 ⁻³ /2.1×10 ⁻⁶	4.2×10 ⁻³ /2.1×10 ⁻⁶	4.2×10 ⁻³ /2.1×10 ⁻⁶	4.2×10 ⁻³ /2.1×10 ⁻⁶	4.2×10 ⁻³ /2.1×10 ⁻⁶	4.2×10 ⁻³ /2.1×10 ⁻⁶
<i>Nonradiological impacts</i>							
Vehicle emissions (LCFs)	3.4×10 ⁻³	1.5×10 ⁻³	1.5×10 ⁻³	1.5×10 ⁻³	1.5×10 ⁻³	1.5×10 ⁻³	1.5×10 ⁻³
Fatalities	0.005	0.006	0.006	0.006	0.006	0.006	0.006

- a. Under the mostly rail scenario, rail shipments would arrive in Nevada at one of six existing rail nodes. Impacts would vary according to the node. From that node, DOE would use one of the rail or heavy-haul implementing alternatives to complete the transportation to Yucca Mountain (see Section J.1.2).
- b. For heavy-haul truck transportation, the Caliente junction is the location of the proposed Caliente intermodal transfer station for heavy-haul trucks near the town of Caliente in eastern Nevada. Rail shipments terminating at this junction would continue to Yucca Mountain on heavy-haul trucks on one of the Caliente, Caliente/Chalk Mountain, or Caliente/Las Vegas routes. For branch rail line transportation, railcars would transfer via the Caliente Option to the Caliente Corridor at the Caliente junction.
- c. For heavy-haul truck transportation, the Dry Lake junction is near the location of the proposed Apex/Dry Lake intermodal transfer station for heavy-haul trucks in southeast Nevada. Rail shipments terminating at this junction would continue to Yucca Mountain on heavy-haul trucks on the Apex/Dry Lake route.
- d. For heavy-haul truck transportation, the Jean junction is near the location of the proposed Sloan/Jean intermodal transfer station for heavy-haul trucks in southern Nevada. Rail shipments terminating at this junction would continue to Yucca Mountain on heavy-haul trucks on the Sloan/Jean route. For branch rail line transportation, railcars would transfer from the mainline railroad via the Wilson Pass or Stateline Pass Option of the Jean Corridor, near the Jean junction.
- e. For branch rail line transportation, railcars would transfer from the mainline railroad at the Beowawe junction in north-central Nevada to the Carlin Corridor.
- f. For branch rail line transportation, railcars would transfer from the mainline railroad at the Eccles junction east of Caliente, Nevada, via the Eccles Option or nearby via the Crestline Option of the Caliente or Caliente-Chalk Mountain Corridor. Impacts in states outside Nevada would be the same for the Eccles and Crestline Options of the Caliente and Caliente-Chalk Mountain Corridors.
- g. For branch rail line transportation, railcars would transfer from the mainline railroad at the Apex junction in southeast Nevada, possibly via the Valley Connection, to the Valley Modified Corridor.
- h. LCF = latent cancer fatality.

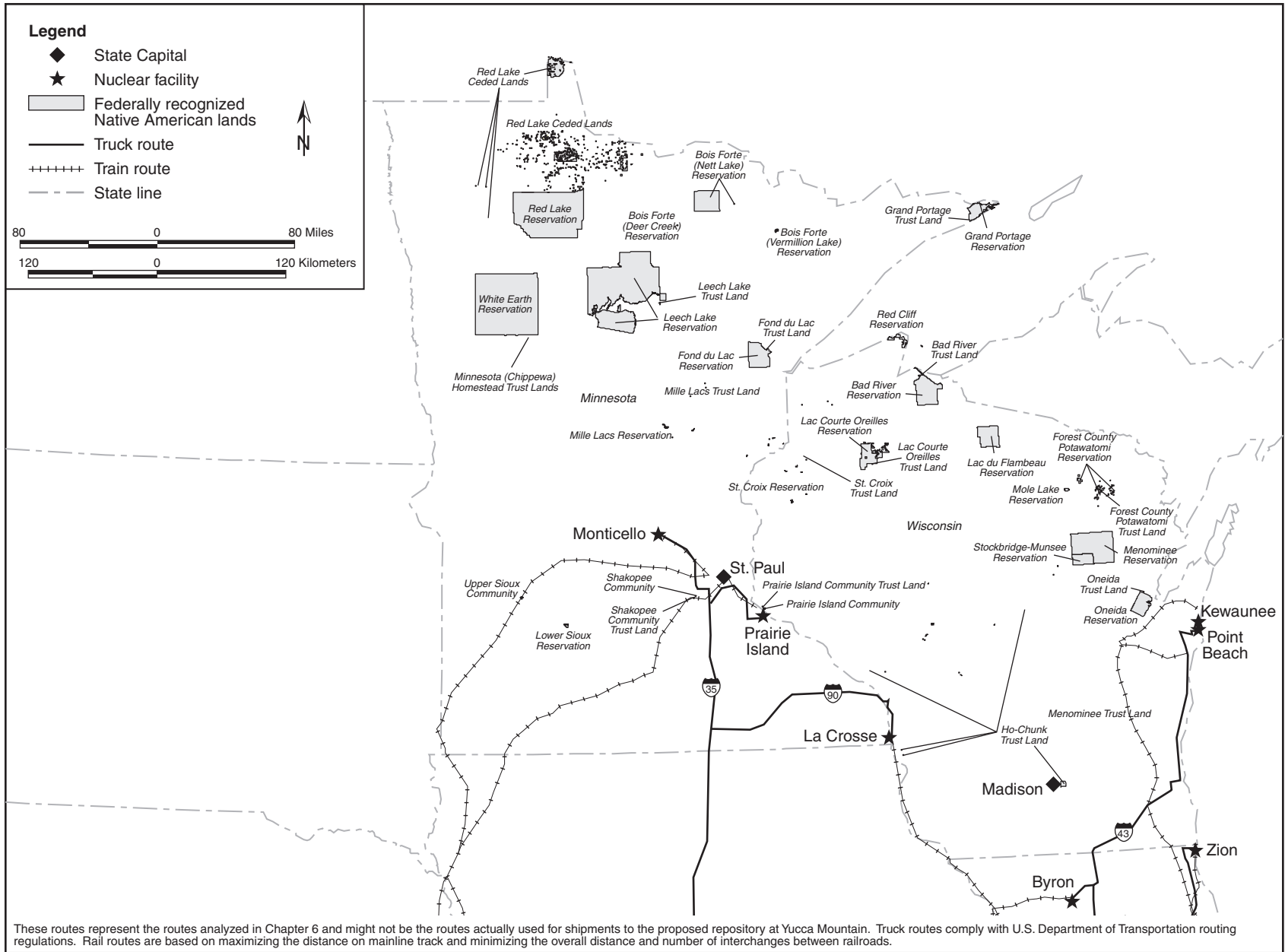

Figure J-46. Highway and rail routes used to analyze transportation impacts - Minnesota and Wisconsin.

Table J-87. Estimated transportation impacts for the State of Missouri.

Impact category	Mostly legal-weight truck	Mostly rail					
		Ending rail node in Nevada ^a					
		Caliente ^b	Dry Lake ^c	Jean ^d	Beowawe ^e	Eccles ^f	Apex ^g
MISSOURI							
<i>Shipments</i>							
Truck (originating/total)	435/19,142	0/491	0/491	0/491	0/491	0/491	0/491
Rail (originating/total)	0/0	71/4,069	71/4,069	71/4,065	71/4,126	71/4,069	71/4,069
<i>Radiological impacts</i>							
<i>Incident-free impacts</i>							
Population (person-rem/LCFs) ^h	$3.5 \times 10^2 / 1.7 \times 10^{-1}$	$8.2 \times 10^1 / 4.1 \times 10^{-2}$	$8.2 \times 10^1 / 4.1 \times 10^{-2}$	$7.8 \times 10^1 / 3.9 \times 10^{-2}$	$8.3 \times 10^1 / 4.2 \times 10^{-2}$	$8.2 \times 10^1 / 4.1 \times 10^{-2}$	$8.2 \times 10^1 / 4.1 \times 10^{-2}$
Workers (person-rem/LCFs)	$7.5 \times 10^2 / 3.0 \times 10^{-1}$	$1.4 \times 10^2 / 5.5 \times 10^{-2}$	$1.4 \times 10^2 / 5.5 \times 10^{-2}$	$1.4 \times 10^2 / 5.5 \times 10^{-2}$	$1.4 \times 10^2 / 5.6 \times 10^{-2}$	$1.4 \times 10^2 / 5.5 \times 10^{-2}$	$1.4 \times 10^2 / 5.5 \times 10^{-2}$
<i>Accident dose risk</i>							
Population (person-rem/LCFs)	$4.8 \times 10^{-2} / 2.4 \times 10^{-5}$	$1.8 \times 10^{-2} / 8.8 \times 10^{-6}$	$1.8 \times 10^{-2} / 8.8 \times 10^{-6}$	$1.6 \times 10^{-2} / 7.9 \times 10^{-6}$	$1.8 \times 10^{-2} / 8.9 \times 10^{-6}$	$1.8 \times 10^{-2} / 8.8 \times 10^{-6}$	$1.8 \times 10^{-2} / 8.8 \times 10^{-6}$
<i>Nonradiological impacts</i>							
Vehicle emissions (LCFs)	7.5×10^{-2}	3.8×10^{-2}	3.8×10^{-2}	3.6×10^{-2}	3.8×10^{-2}	3.8×10^{-2}	3.8×10^{-2}
Fatalities	0.28	0.086	0.086	0.085	0.086	0.086	0.086

- a. Under the mostly rail scenario, rail shipments would arrive in Nevada at one of six existing rail nodes. Impacts would vary according to the node. From that node, DOE would use one of the rail or heavy-haul implementing alternatives to complete the transportation to Yucca Mountain (see Section J.1.2).
- b. For heavy-haul truck transportation, the Caliente junction is the location of the proposed Caliente intermodal transfer station for heavy-haul trucks near the town of Caliente in eastern Nevada. Rail shipments terminating at this junction would continue to Yucca Mountain on heavy-haul trucks on one of the Caliente, Caliente/Chalk Mountain, or Caliente/Las Vegas routes. For branch rail line transportation, railcars would transfer via the Caliente Option to the Caliente Corridor at the Caliente junction.
- c. For heavy-haul truck transportation, the Dry Lake junction is near the location of the proposed Apex/Dry Lake intermodal transfer station for heavy-haul trucks in southeast Nevada. Rail shipments terminating at this junction would continue to Yucca Mountain on heavy-haul trucks on the Apex/Dry Lake route.
- d. For heavy-haul truck transportation, the Jean junction is near the location of the proposed Sloan/Jean intermodal transfer station for heavy-haul trucks in southern Nevada. Rail shipments terminating at this junction would continue to Yucca Mountain on heavy-haul trucks on the Sloan/Jean route. For branch rail line transportation, railcars would transfer from the mainline railroad via the Wilson Pass or Stateline Pass Option of the Jean Corridor, near the Jean junction.
- e. For branch rail line transportation, railcars would transfer from the mainline railroad at the Beowawe junction in north-central Nevada to the Carlin Corridor.
- f. For branch rail line transportation, railcars would transfer from the mainline railroad at the Eccles junction east of Caliente, Nevada, via the Eccles Option or nearby via the Crestline Option of the Caliente or Caliente-Chalk Mountain Corridor. Impacts in states outside Nevada would be the same for the Eccles and Crestline Options of the Caliente and Caliente-Chalk Mountain Corridors.
- g. For branch rail line transportation, railcars would transfer from the mainline railroad at the Apex junction in southeast Nevada, possibly via the Valley Connection, to the Valley Modified Corridor.
- h. LCF = latent cancer fatality.

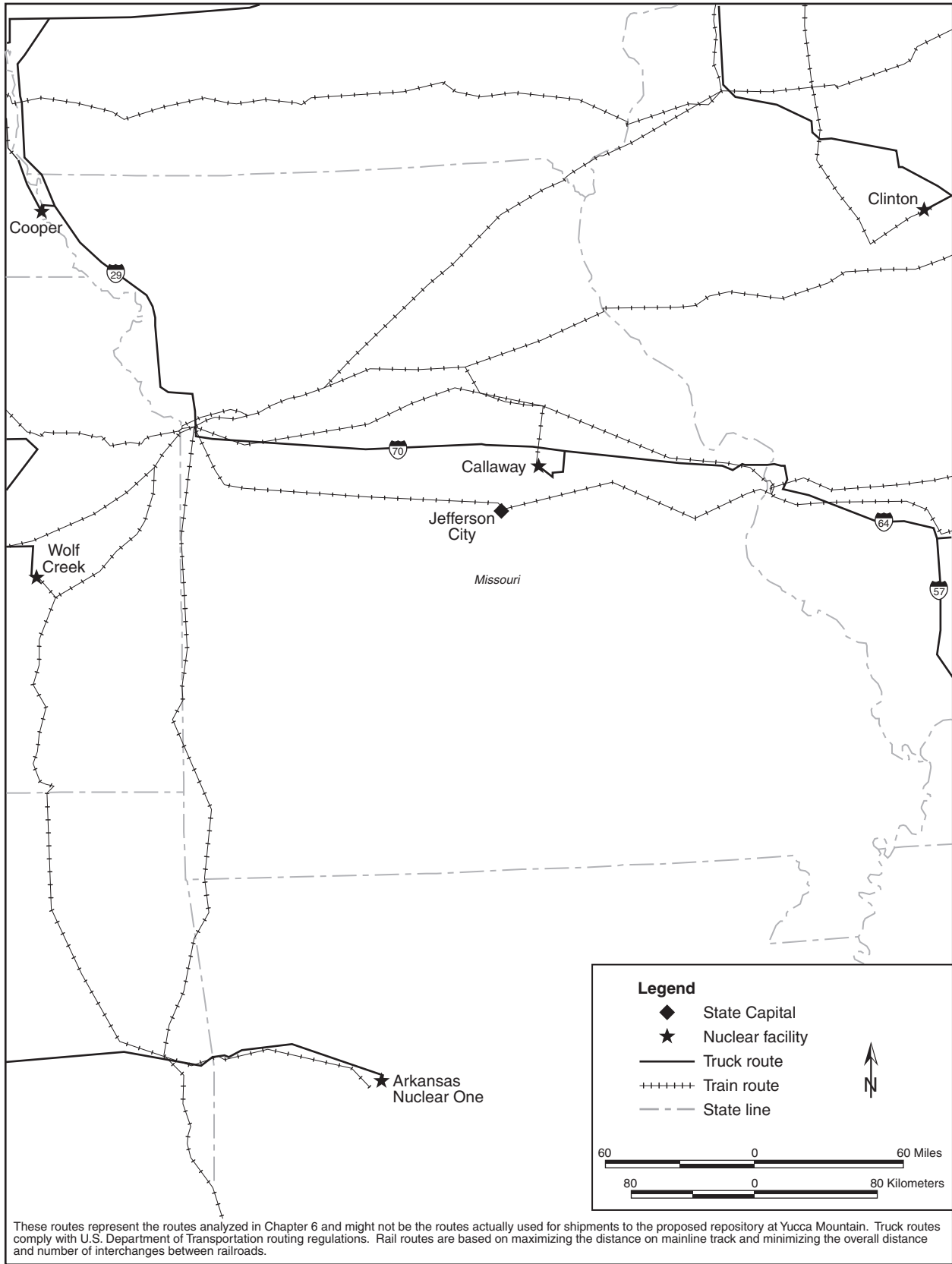

Figure J-47. Highway and rail routes used to analyze transportation impacts - Missouri.

Table J-88. Estimated transportation impacts for the States of Montana, North Dakota, and South Dakota (page 1 of 2).

Impact category	Mostly legal-weight truck	Mostly rail					
		Ending rail node in Nevada ^a					
		Caliente ^b	Dry Lake ^c	Jean ^d	Beowawe ^e	Eccles ^f	Apex ^g
MONTANA							
<i>Shipments</i>							
Truck (originating/total)	0/0	0/0	0/0	0/0	0/0	0/0	0/0
Rail (originating/total)	0/0	0/0	0/0	0/0	0/0	0/0	0/0
<i>Radiological impacts</i>							
Incident-free impacts							
Population (person-rem/LCFs) ^b	0/0	0/0	0/0	0/0	0/0	0/0	0/0
Workers (person-rem/LCFs)	0/0	0/0	0/0	0/0	0/0	0/0	0/0
Accident dose risk							
Population (person-rem/LCFs)	0	0	0	0	0	0	0
<i>Nonradiological impacts</i>							
Vehicle emissions (LCFs)	0	0	0	0	0	0	0
Fatalities	0	0	0	0	0	0	0
NORTH DAKOTA							
<i>Shipments</i>							
Truck (originating/total)	0/0	0/0	0/0	0/0	0/0	0/0	0/0
Rail (originating/total)	0/0	0/0	0/0	0/0	0/0	0/0	0/0
<i>Radiological impacts</i>							
Incident-free impacts							
Population (person-rem/LCFs) ^h	0/0	0/0	0/0	0/0	0/0	0/0	0/0
Workers (person-rem/LCFs)	0/0	0/0	0/0	0/0	0/0	0/0	0/0
Accident dose risk							
Population (person-rem/LCFs)	0	0	0	0	0	0	0
<i>Nonradiological impacts</i>							
Vehicle emissions (LCFs)	0	0	0	0	0	0	0
Fatalities	0	0	0	0	0	0	0
SOUTH DAKOTA							
<i>Shipments</i>							
Truck (originating/total)	0/0	0/0	0/0	0/0	0/0	0/0	0/0
Rail (originating/total)	0/0	0/32	0/32	0/32	0/32	0/32	0/32
<i>Radiological impacts</i>							
Incident-free impacts							
Population (person-rem/LCFs) ^h	0.0×10 ⁰ /0.0×10 ⁰	1.8×10 ⁻³ /9.0×10 ⁻⁷	1.8×10 ⁻³ /9.0×10 ⁻⁷	1.8×10 ⁻³ /9.0×10 ⁻⁷	1.8×10 ⁻³ /9.0×10 ⁻⁷	1.8×10 ⁻³ /9.0×10 ⁻⁷	1.8×10 ⁻³ /9.0×10 ⁻⁷
Workers (person-rem/LCFs)	0.0×10 ⁰ /0.0×10 ⁰	4.0×10 ⁻² /1.6×10 ⁻⁵	4.0×10 ⁻² /2.0×10 ⁻⁵	4.0×10 ⁻² /1.6×10 ⁻⁵	4.0×10 ⁻² /1.6×10 ⁻⁵	4.0×10 ⁻² /1.6×10 ⁻⁵	4.0×10 ⁻² /1.6×10 ⁻⁵
Accident dose risk							
Population (person-rem/LCFs)	0.0×10 ⁰ /0.0×10 ⁰	7.3×10 ⁻⁶ /3.7×10 ⁻⁹	7.3×10 ⁻⁶ /3.7×10 ⁻⁹	7.3×10 ⁻⁶ /3.7×10 ⁻⁹	7.3×10 ⁻⁶ /3.7×10 ⁻⁹	7.3×10 ⁻⁶ /3.7×10 ⁻⁹	7.3×10 ⁻⁶ /3.7×10 ⁻⁹
<i>Nonradiological impacts</i>							
Vehicle emissions (LCFs)	0.00×10 ⁰	1.04×10 ⁻⁶	1.04×10 ⁻⁶	1.04×10 ⁻⁶	1.04×10 ⁻⁶	1.04×10 ⁻⁶	1.04×10 ⁻⁶
Fatalities	0.0×10 ⁰	2.1×10 ⁻⁵	2.1×10 ⁻⁵	2.1×10 ⁻⁵	2.1×10 ⁻⁵	2.1×10 ⁻⁵	2.1×10 ⁻⁵

- Under the mostly rail scenario, rail shipments would arrive in Nevada at one of six existing rail nodes. Impacts would vary according to the node. From that node, DOE would use one of the rail or heavy-haul implementing alternatives to complete the transportation to Yucca Mountain (see Section J.1.2).
- For heavy-haul truck transportation, the Caliente junction is the location of the proposed Caliente intermodal transfer station for heavy-haul trucks near the town of Caliente in eastern Nevada. Rail shipments terminating at this junction would continue to Yucca Mountain on heavy-haul trucks on one of the Caliente, Caliente/Chalk Mountain, or Caliente/Las Vegas routes. For branch rail line transportation, railcars would transfer via the Caliente Option to the Caliente Corridor at the Caliente junction.

Table J-88. Estimated transportation impacts for the States of Montana, North Dakota, and South Dakota (page 2 of 2).

- c. For heavy-haul truck transportation, the Dry Lake junction is near the location of the proposed Apex/Dry Lake intermodal transfer station for heavy-haul trucks in southeast Nevada. Rail shipments terminating at this junction would continue to Yucca Mountain on heavy-haul trucks on the Apex/Dry Lake route.
- d. For heavy-haul truck transportation, the Jean junction is near the location of the proposed Sloan/Jean intermodal transfer station for heavy-haul trucks in southern Nevada. Rail shipments terminating at this junction would continue to Yucca Mountain on heavy-haul trucks on the Sloan/Jean route. For branch rail line transportation, railcars would transfer from the mainline railroad via the Wilson Pass or Stateline Pass Option of the Jean Corridor, near the Jean junction.
- e. For branch rail line transportation, railcars would transfer from the mainline railroad at the Beowawe junction in north-central Nevada to the Carlin Corridor.
- f. For branch rail line transportation, railcars would transfer from the mainline railroad at the Eccles junction east of Caliente, Nevada, via the Eccles Option or nearby via the Crestline Option of the Caliente or Caliente-Chalk Mountain Corridor. Impacts in states outside Nevada would be the same for the Eccles and Crestline Options of the Caliente and Caliente-Chalk Mountain Corridors.
- g. For branch rail line transportation, railcars would transfer from the mainline railroad at the Apex junction in southeast Nevada, possibly via the Valley Connection, to the Valley Modified Corridor.
- h. LCF = latent cancer fatality.

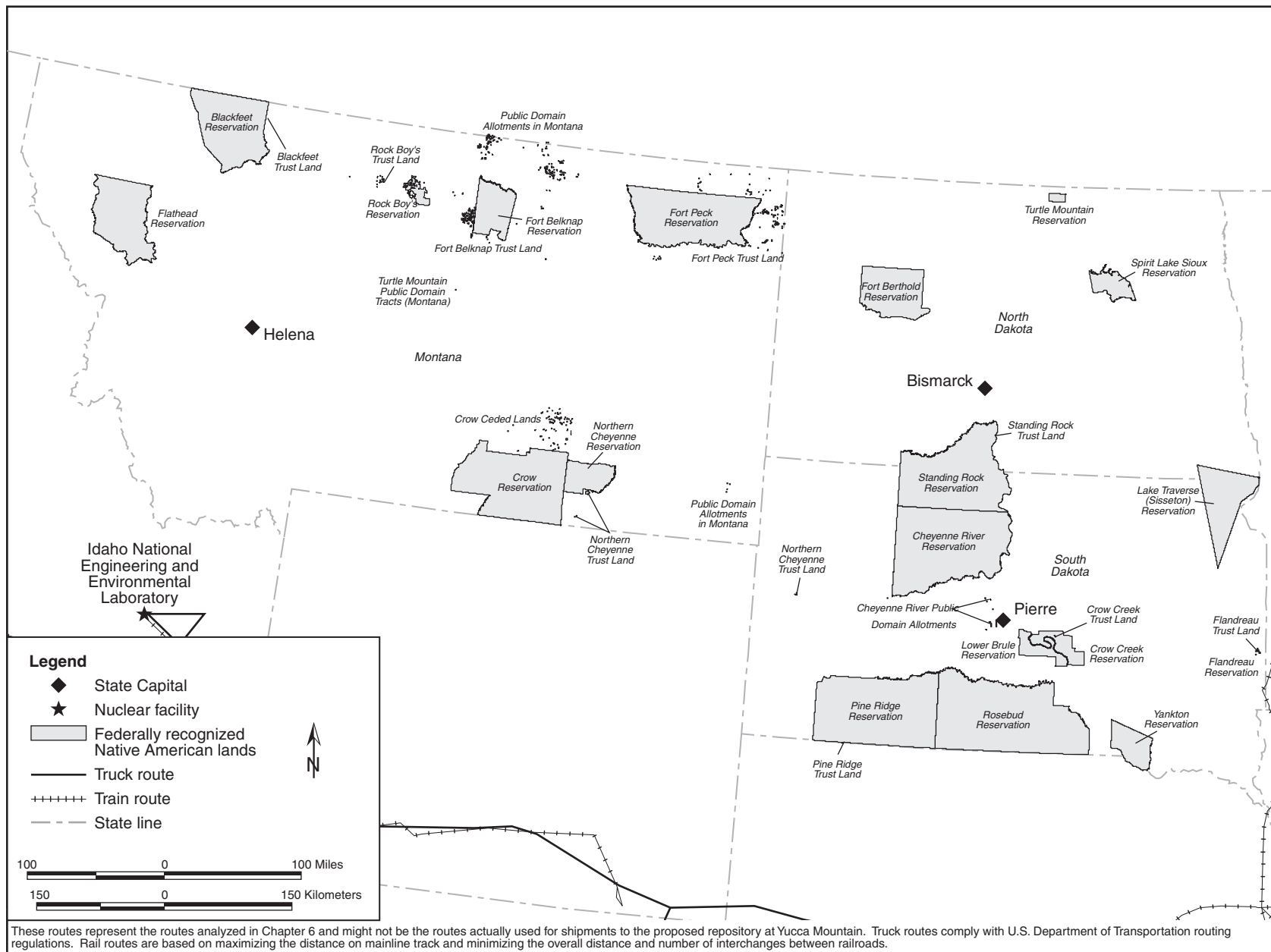

Figure J-48. Highway and rail routes used to analyze transportation impacts - Montana, North Dakota, and South Dakota.

Table J-89. Estimated transportation impacts for the States of New Jersey and Pennsylvania.

Impact category	Mostly legal-weight truck	Mostly rail					
		Ending rail node in Nevada ^a					
		Caliente ^b	Dry Lake ^c	Jean ^d	Beowawe ^e	Eccles ^f	Apex ^g
NEW JERSEY							
<i>Shipments</i>							
Truck (originating/total)	1,528/3,245	0/335	0/335	0/335	0/335	0/335	0/335
Rail (originating/total)	0/0	244/244	244/244	244/244	244/244	244/244	244/244
<i>Radiological impacts</i>							
<i>Incident-free impacts</i>							
Population (person-rem/LCFs) ^h	1.2×10 ¹ /6.1×10 ⁻³	1.0×10 ¹ /5.1×10 ⁻³	1.0×10 ¹ /5.1×10 ⁻³	1.0×10 ¹ /5.1×10 ⁻³	1.0×10 ¹ /5.1×10 ⁻³	1.0×10 ¹ /5.1×10 ⁻³	1.0×10 ¹ /5.1×10 ⁻³
Workers (person-rem/LCFs)	4.6×10 ¹ /1.8×10 ⁻²	1.7×10 ¹ /6.9×10 ⁻³	1.7×10 ¹ /6.9×10 ⁻³	1.7×10 ¹ /6.9×10 ⁻³	1.7×10 ¹ /6.9×10 ⁻³	1.7×10 ¹ /6.9×10 ⁻³	1.7×10 ¹ /6.9×10 ⁻³
<i>Accident dose risk</i>							
Population (person-rem/LCFs)	2.9×10 ⁻³ /1.5×10 ⁻⁶	1.3×10 ⁻² /6.7×10 ⁻⁶	1.3×10 ⁻² /6.7×10 ⁻⁶	1.3×10 ⁻² /6.7×10 ⁻⁶	1.3×10 ⁻² /6.7×10 ⁻⁶	1.3×10 ⁻² /6.7×10 ⁻⁶	1.3×10 ⁻² /6.7×10 ⁻⁶
<i>Nonradiological impacts</i>							
Vehicle emissions (LCFs)	3.3×10 ⁻³	3.4×10 ⁻³	3.4×10 ⁻³	3.4×10 ⁻³	3.4×10 ⁻³	3.4×10 ⁻³	3.4×10 ⁻³
Fatalities	0.007	0.022	0.022	0.022	0.022	0.022	0.022
PENNSYLVANIA							
<i>Shipments</i>							
Truck (originating/total)	3,803/11,485	0/580	0/580	0/580	0/580	0/580	0/580
Rail (originating/total)	0/0	661/2,078	661/2,078	661/2,078	661/2,078	661/2,078	661/2,078
<i>Radiological impacts</i>							
<i>Incident-free impacts</i>							
Population (person-rem/LCFs) ^h	1.0×10 ² /5.1×10 ⁻²	6.9×10 ¹ /3.4×10 ⁻²	6.9×10 ¹ /3.4×10 ⁻²	6.9×10 ¹ /3.4×10 ⁻²	6.9×10 ¹ /3.4×10 ⁻²	6.9×10 ¹ /3.4×10 ⁻²	6.9×10 ¹ /3.4×10 ⁻²
Workers (person-rem/LCFs)	3.1×10 ² /1.2×10 ⁻¹	9.4×10 ¹ /3.8×10 ⁻²	9.4×10 ¹ /3.8×10 ⁻²	9.4×10 ¹ /3.8×10 ⁻²	9.4×10 ¹ /3.8×10 ⁻²	9.4×10 ¹ /3.8×10 ⁻²	9.4×10 ¹ /3.8×10 ⁻²
<i>Accident dose risk</i>							
Population (person-rem/LCFs)	1.0×10 ⁻² /5.1×10 ⁻⁶	5.5×10 ⁻² /2.7×10 ⁻⁵	5.5×10 ⁻² /2.7×10 ⁻⁵	5.5×10 ⁻² /2.7×10 ⁻⁵	5.5×10 ⁻² /2.7×10 ⁻⁵	5.5×10 ⁻² /2.7×10 ⁻⁵	5.5×10 ⁻² /2.7×10 ⁻⁵
<i>Nonradiological impacts</i>							
Vehicle emissions (LCFs)	1.3×10 ⁻²	2.9×10 ⁻²	2.9×10 ⁻²	2.9×10 ⁻²	2.9×10 ⁻²	2.9×10 ⁻²	2.9×10 ⁻²
Fatalities	0.099	0.066	0.066	0.066	0.066	0.066	0.066

- a. Under the mostly rail scenario, rail shipments would arrive in Nevada at one of six existing rail nodes. Impacts would vary according to the node. From that node, DOE would use one of the rail or heavy-haul implementing alternatives to complete the transportation to Yucca Mountain (see Section J.1.2).
- b. For heavy-haul truck transportation, the Caliente junction is the location of the proposed Caliente intermodal transfer station for heavy-haul trucks near the town of Caliente in eastern Nevada. Rail shipments terminating at this junction would continue to Yucca Mountain on heavy-haul trucks on one of the Caliente, Caliente/Chalk Mountain, or Caliente/Las Vegas routes. For branch rail line transportation, railcars would transfer via the Caliente Option to the Caliente Corridor at the Caliente junction.
- c. For heavy-haul truck transportation, the Dry Lake junction is near the location of the proposed Apex/Dry Lake intermodal transfer station for heavy-haul trucks in southeast Nevada. Rail shipments terminating at this junction would continue to Yucca Mountain on heavy-haul trucks on the Apex/Dry Lake route.
- d. For heavy-haul truck transportation, the Jean junction is near the location of the proposed Sloan/Jean intermodal transfer station for heavy-haul trucks in southern Nevada. Rail shipments terminating at this junction would continue to Yucca Mountain on heavy-haul trucks on the Sloan/Jean route. For branch rail line transportation, railcars would transfer from the mainline railroad via the Wilson Pass or Stateline Pass Option of the Jean Corridor, near the Jean junction.
- e. For branch rail line transportation, railcars would transfer from the mainline railroad at the Beowawe junction in north-central Nevada to the Carlin Corridor.
- f. For branch rail line transportation, railcars would transfer from the mainline railroad at the Eccles junction east of Caliente, Nevada, via the Eccles Option or nearby via the Crestline Option of the Caliente or Caliente-Chalk Mountain Corridor. Impacts in states outside Nevada would be the same for the Eccles and Crestline Options of the Caliente and Caliente-Chalk Mountain Corridors.
- g. For branch rail line transportation, railcars would transfer from the mainline railroad at the Apex junction in southeast Nevada, possibly via the Valley Connection, to the Valley Modified Corridor.
- h. LCF = latent cancer fatality.

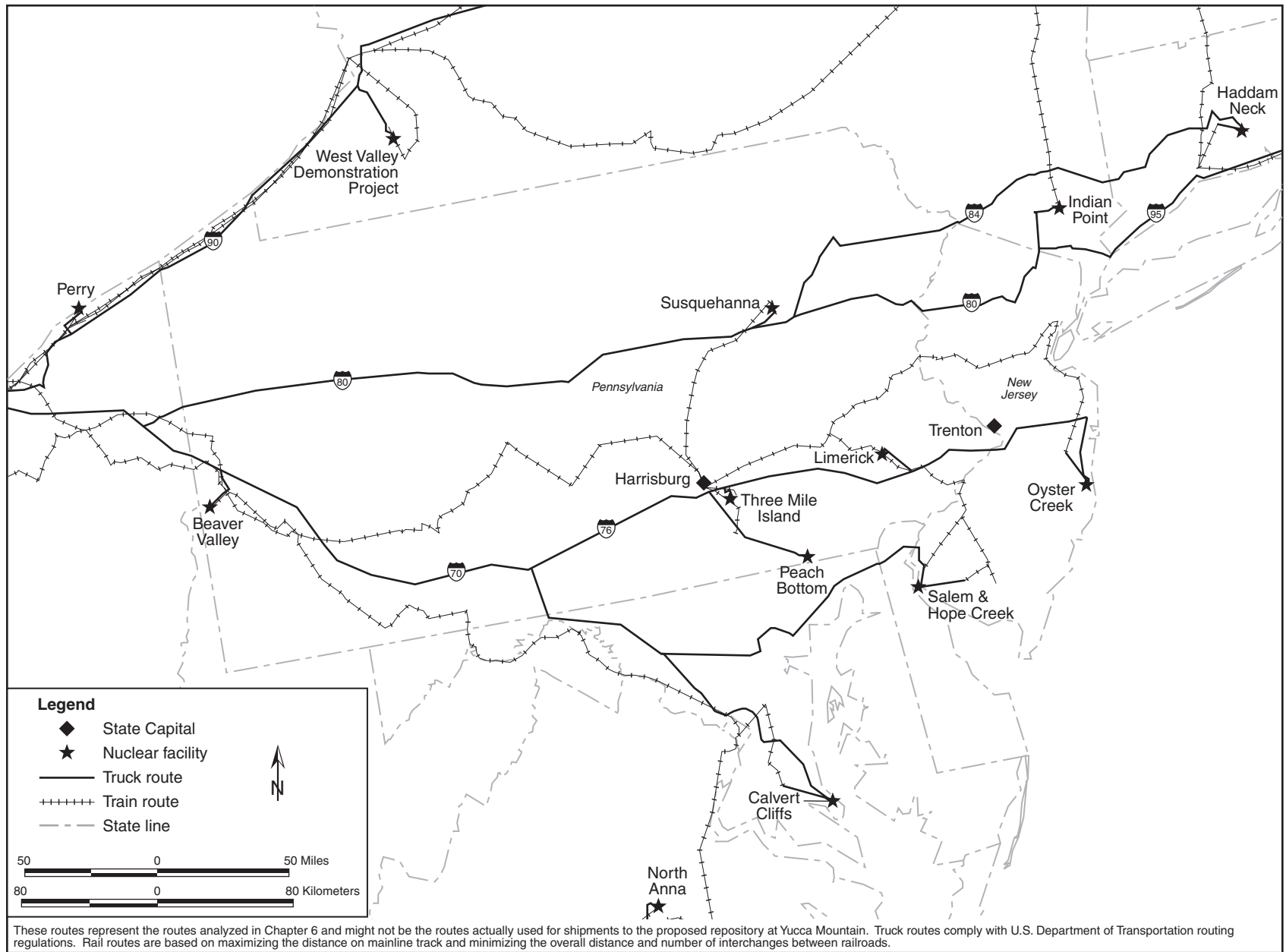
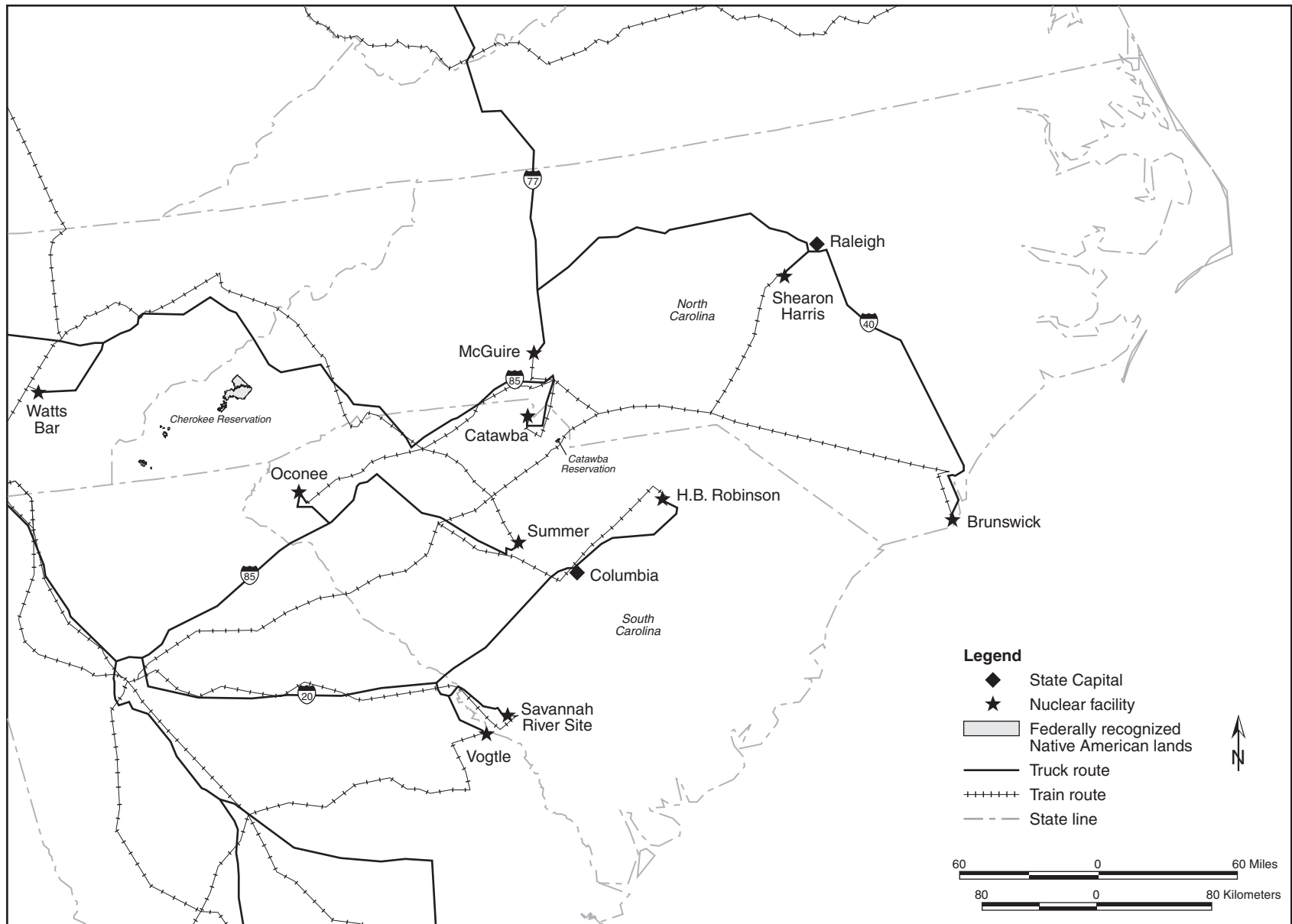

Figure J-49. Highway and rail routes used to analyze transportation impacts - New Jersey and Pennsylvania.

Table J-90. Estimated transportation impacts for the States of North Carolina and South Carolina.

Impact category	Mostly legal-weight truck	Mostly rail					
		Ending rail node in Nevada ^a					
		Caliente ^b	Dry Lake ^c	Jean ^d	Beowawe ^e	Eccles ^f	Apex ^g
NORTH CAROLINA							
<i>Shipments</i>							
Truck (originating/total)	1,871/2,508	0/0	0/0	0/0	0/0	0/0	0/0
Rail (originating/total)	0/0	486/943	486/943	486/943	486/943	486/943	486/943
<i>Radiological impacts</i>							
<i>Incident-free impacts</i>							
Population (person-rem/LCFs) ^h	2.7×10 ¹ /1.4×10 ⁻²	1.1×10 ¹ /5.7×10 ⁻³	1.1×10 ¹ /5.7×10 ⁻³	1.1×10 ¹ /5.7×10 ⁻³	1.1×10 ¹ /5.7×10 ⁻³	1.1×10 ¹ /5.7×10 ⁻³	1.1×10 ¹ /5.7×10 ⁻³
Workers (person-rem/LCFs)	8.4×10 ¹ /3.4×10 ⁻²	3.4×10 ¹ /1.4×10 ⁻²	3.4×10 ¹ /1.4×10 ⁻²	3.4×10 ¹ /1.4×10 ⁻²	3.4×10 ¹ /1.4×10 ⁻²	3.4×10 ¹ /1.4×10 ⁻²	3.4×10 ¹ /1.4×10 ⁻²
<i>Accident dose risk</i>							
Population (person-rem/LCFs)	3.5×10 ⁻³ /1.7×10 ⁻⁶	4.2×10 ⁻³ /2.1×10 ⁻⁶	4.2×10 ⁻³ /2.1×10 ⁻⁶	4.2×10 ⁻³ /2.1×10 ⁻⁶	4.2×10 ⁻³ /2.1×10 ⁻⁶	4.2×10 ⁻³ /2.1×10 ⁻⁶	4.2×10 ⁻³ /2.1×10 ⁻⁶
<i>Nonradiological impacts</i>							
Vehicle emissions (LCFs)	6.3×10 ⁻³	4.1×10 ⁻³	4.1×10 ⁻³	4.1×10 ⁻³	4.1×10 ⁻³	4.1×10 ⁻³	4.1×10 ⁻³
Fatalities	0.023	0.052	0.052	0.052	0.052	0.052	0.052
SOUTH CAROLINA							
<i>Shipments</i>							
Truck (originating/total)	9,832/9,832	0/0	0/0	0/0	0/0	0/0	0/0
Rail (originating/total)	0/0	1,899/2,385	1,899/2,385	1,899/2,385	1,899/2,385	1,899/2,385	1,899/2,385
<i>Radiological impacts</i>							
<i>Incident-free impacts</i>							
Population (person-rem/LCFs) ^h	1.3×10 ¹ /6.5×10 ⁻³	1.8×10 ¹ /8.9×10 ⁻³	1.8×10 ¹ /8.9×10 ⁻³	1.8×10 ¹ /8.9×10 ⁻³	1.8×10 ¹ /8.9×10 ⁻³	1.8×10 ¹ /8.9×10 ⁻³	1.8×10 ¹ /8.9×10 ⁻³
Workers (person-rem/LCFs)	2.1×10 ² /8.4×10 ⁻²	1.1×10 ² /4.3×10 ⁻²	1.1×10 ² /4.3×10 ⁻²	1.1×10 ² /4.3×10 ⁻²	1.1×10 ² /4.3×10 ⁻²	1.1×10 ² /4.3×10 ⁻²	1.1×10 ² /4.3×10 ⁻²
<i>Accident dose risk</i>							
Population (person-rem/LCFs)	1.1×10 ⁻³ /5.4×10 ⁻⁷	4.6×10 ⁻³ /2.3×10 ⁻⁶	4.6×10 ⁻³ /2.3×10 ⁻⁶	4.6×10 ⁻³ /2.3×10 ⁻⁶	4.6×10 ⁻³ /2.3×10 ⁻⁶	4.6×10 ⁻³ /2.3×10 ⁻⁶	4.6×10 ⁻³ /2.3×10 ⁻⁶
<i>Nonradiological impacts</i>							
Vehicle emissions (LCFs)	1.4×10 ⁻³	4.3×10 ⁻³	4.3×10 ⁻³	4.3×10 ⁻³	4.3×10 ⁻³	4.3×10 ⁻³	4.3×10 ⁻³
Fatalities	0.03	0.08	0.08	0.08	0.08	0.08	0.08

- a. Under the mostly rail scenario, rail shipments would arrive in Nevada at one of six existing rail nodes. Impacts would vary according to the node. From that node, DOE would use one of the rail or heavy-haul implementing alternatives to complete the transportation to Yucca Mountain (see Section J.1.2).
- b. For heavy-haul truck transportation, the Caliente junction is the location of the proposed Caliente intermodal transfer station for heavy-haul trucks near the town of Caliente in eastern Nevada. Rail shipments terminating at this junction would continue to Yucca Mountain on heavy-haul trucks on one of the Caliente, Caliente/Chalk Mountain, or Caliente/Las Vegas routes. For branch rail line transportation, railcars would transfer via the Caliente Option to the Caliente Corridor at the Caliente junction.
- c. For heavy-haul truck transportation, the Dry Lake junction is near the location of the proposed Apex/Dry Lake intermodal transfer station for heavy-haul trucks in southeast Nevada. Rail shipments terminating at this junction would continue to Yucca Mountain on heavy-haul trucks on the Apex/Dry Lake route.
- d. For heavy-haul truck transportation, the Jean junction is near the location of the proposed Sloan/Jean intermodal transfer station for heavy-haul trucks in southern Nevada. Rail shipments terminating at this junction would continue to Yucca Mountain on heavy-haul trucks on the Sloan/Jean route. For branch rail line transportation, railcars would transfer from the mainline railroad via the Wilson Pass or Stateline Pass Option of the Jean Corridor, near the Jean junction.
- e. For branch rail line transportation, railcars would transfer from the mainline railroad at the Beowawe junction in north-central Nevada to the Carlin Corridor.
- f. For branch rail line transportation, railcars would transfer from the mainline railroad at the Eccles junction east of Caliente, Nevada, via the Eccles Option or nearby via the Crestline Option of the Caliente or Caliente-Chalk Mountain Corridor. Impacts in states outside Nevada would be the same for the Eccles and Crestline Options of the Caliente and Caliente-Chalk Mountain Corridors.
- g. For branch rail line transportation, railcars would transfer from the mainline railroad at the Apex junction in southeast Nevada, possibly via the Valley Connection, to the Valley Modified Corridor.
- h. LCF = latent cancer fatality.



These routes represent the routes analyzed in Chapter 6 and might not be the routes actually used for shipments to the proposed repository at Yucca Mountain. Truck routes comply with U.S. Department of Transportation routing regulations. Rail routes are based on maximizing the distance on mainline track and minimizing the overall distance and number of interchanges between railroads.

Figure J-50. Highway and rail routes used to analyze transportation impacts - North Carolina and South Carolina.

Table J-91. Estimated transportation impacts for the States of Oklahoma and Texas.

Impact category	Mostly legal-weight truck	Mostly rail					
		Ending rail node in Nevada ^a					
		Caliente ^b	Dry Lake ^c	Jean ^d	Beowawe ^e	Eccles ^f	Apex ^g
OKLAHOMA							
<i>Shipments</i>							
Truck (originating/total)	0/3,471	0/0	0/0	0/0	0/0	0/0	0/0
Rail (originating/total)	0/0	0/412	0/355	0/399	0/439	0/478	0/201
<i>Radiological impacts</i>							
<i>Incident-free impacts</i>							
Population (person-rem/LCFs) ^h	4.1×10 ¹ /2.0×10 ⁻²	4.1×10 ¹ /2.0×10 ⁻⁴	4.1×10 ¹ /2.0×10 ⁻⁴	3.3×10 ¹ /1.6×10 ⁻⁴	5.2×10 ¹ /2.6×10 ⁻⁴	4.0×10 ¹ /2.0×10 ⁻⁴	4.0×10 ¹ /2.0×10 ⁻⁴
Workers (person-rem/LCFs)	1.1×10 ² /4.2×10 ⁻²	3.9×10 ⁰ /1.5×10 ⁻³	3.6×10 ⁰ /1.4×10 ⁻³	5.3×10 ⁰ /2.1×10 ⁻³	4.5×10 ⁰ /1.8×10 ⁻³	3.0×10 ⁰ /1.7×10 ⁻³	3.0×10 ⁰ /1.2×10 ⁻³
<i>Accident dose risk</i>							
Population (person-rem/LCFs)	2.6×10 ⁻³ /1.3×10 ⁻⁶	3.4×10 ⁻⁴ /1.7×10 ⁻⁷	3.4×10 ⁻⁴ /1.7×10 ⁻⁷	3.1×10 ⁻⁴ /1.6×10 ⁻⁷	4.2×10 ⁻⁴ /2.1×10 ⁻⁷	3.5×10 ⁻⁴ /1.7×10 ⁻⁷	3.3×10 ⁻⁴ /1.6×10 ⁻⁷
<i>Nonradiological impacts</i>							
Vehicle emissions (LCFs)	6.4×10 ⁻³	2.3×10 ⁻⁴	2.3×10 ⁻⁴	1.8×10 ⁻⁴	2.9×10 ⁻⁴	2.3×10 ⁻⁴	2.3×10 ⁻⁴
Fatalities	0.043	0.005	0.005	0.007	0.006	0.006	0.004
TEXAS							
<i>Shipments</i>							
Truck (originating/total)	1,193/3,999	0/0	0/0	0/0	0/0	0/0	0/0
Rail (originating/total)	0/0	269/472	269/472	269/952	269/472	269/472	269/472
<i>Radiological impacts</i>							
<i>Incident-free impacts</i>							
Population (person-rem/LCFs) ^h	7.9×10 ¹ /4.0×10 ⁻²	1.8×10 ¹ /9.1×10 ⁻³	1.9×10 ¹ /9.3×10 ⁻³	4.1×10 ¹ /2.0×10 ⁻²	1.9×10 ¹ /9.6×10 ⁻³	1.8×10 ¹ /9.0×10 ⁻³	2.1×10 ¹ /1.0×10 ⁻²
Workers (person-rem/LCFs)	1.9×10 ² /7.6×10 ⁻²	4.4×10 ¹ /1.8×10 ⁻²	4.5×10 ¹ /1.8×10 ⁻²	8.2×10 ¹ /3.3×10 ⁻²	3.9×10 ¹ /1.5×10 ⁻²	4.3×10 ¹ /1.7×10 ⁻²	4.8×10 ¹ /1.9×10 ⁻²
<i>Accident dose risk</i>							
Population (person-rem/LCFs)	1.7×10 ⁻² /8.6×10 ⁻⁶	7.0×10 ⁻³ /3.5×10 ⁻⁶	7.3×10 ⁻³ /3.7×10 ⁻⁶	2.0×10 ⁻² /9.9×10 ⁻⁶	7.2×10 ⁻³ /3.6×10 ⁻⁶	7.1×10 ⁻³ /3.5×10 ⁻⁶	8.1×10 ⁻³ /4.0×10 ⁻⁶
<i>Nonradiological impacts</i>							
Vehicle emissions (LCFs)	1.96×10 ⁻²	7.47×10 ⁻³	7.77×10 ⁻³	1.87×10 ⁻²	8.10×10 ⁻³	7.60×10 ⁻³	8.84×10 ⁻³
Fatalities	0.07	0.05	0.05	0.14	0.04	0.05	0.05

- a. Under the mostly rail scenario, rail shipments would arrive in Nevada at one of six existing rail nodes. Impacts would vary according to the node. From that node, DOE would use one of the rail or heavy-haul implementing alternatives to complete the transportation to Yucca Mountain (see Section J.1.2).
- b. For heavy-haul truck transportation, the Caliente junction is the location of the proposed Caliente intermodal transfer station for heavy-haul trucks near the town of Caliente in eastern Nevada. Rail shipments terminating at this junction would continue to Yucca Mountain on heavy-haul trucks on one of the Caliente, Caliente/Chalk Mountain, or Caliente/Las Vegas routes. For branch rail line transportation, railcars would transfer via the Caliente Option to the Caliente Corridor at the Caliente junction.
- c. For heavy-haul truck transportation, the Dry Lake junction is near the location of the proposed Apex/Dry Lake intermodal transfer station for heavy-haul trucks in southeast Nevada. Rail shipments terminating at this junction would continue to Yucca Mountain on heavy-haul trucks on the Apex/Dry Lake route.
- d. For heavy-haul truck transportation, the Jean junction is near the location of the proposed Sloan/Jean intermodal transfer station for heavy-haul trucks in southern Nevada. Rail shipments terminating at this junction would continue to Yucca Mountain on heavy-haul trucks on the Sloan/Jean route. For branch rail line transportation, railcars would transfer from the mainline railroad via the Wilson Pass or Stateline Pass Option of the Jean Corridor, near the Jean junction.
- e. For branch rail line transportation, railcars would transfer from the mainline railroad at the Beowawe junction in north-central Nevada to the Carlin Corridor.
- f. For branch rail line transportation, railcars would transfer from the mainline railroad at the Eccles junction east of Caliente, Nevada, via the Eccles Option or nearby via the Crestline Option of the Caliente or Caliente-Chalk Mountain Corridor. Impacts in states outside Nevada would be the same for the Eccles and Crestline Options of the Caliente and Caliente-Chalk Mountain Corridors.
- g. For branch rail line transportation, railcars would transfer from the mainline railroad at the Apex junction in southeast Nevada, possibly via the Valley Connection, to the Valley Modified Corridor.
- h. LCF = latent cancer fatality.

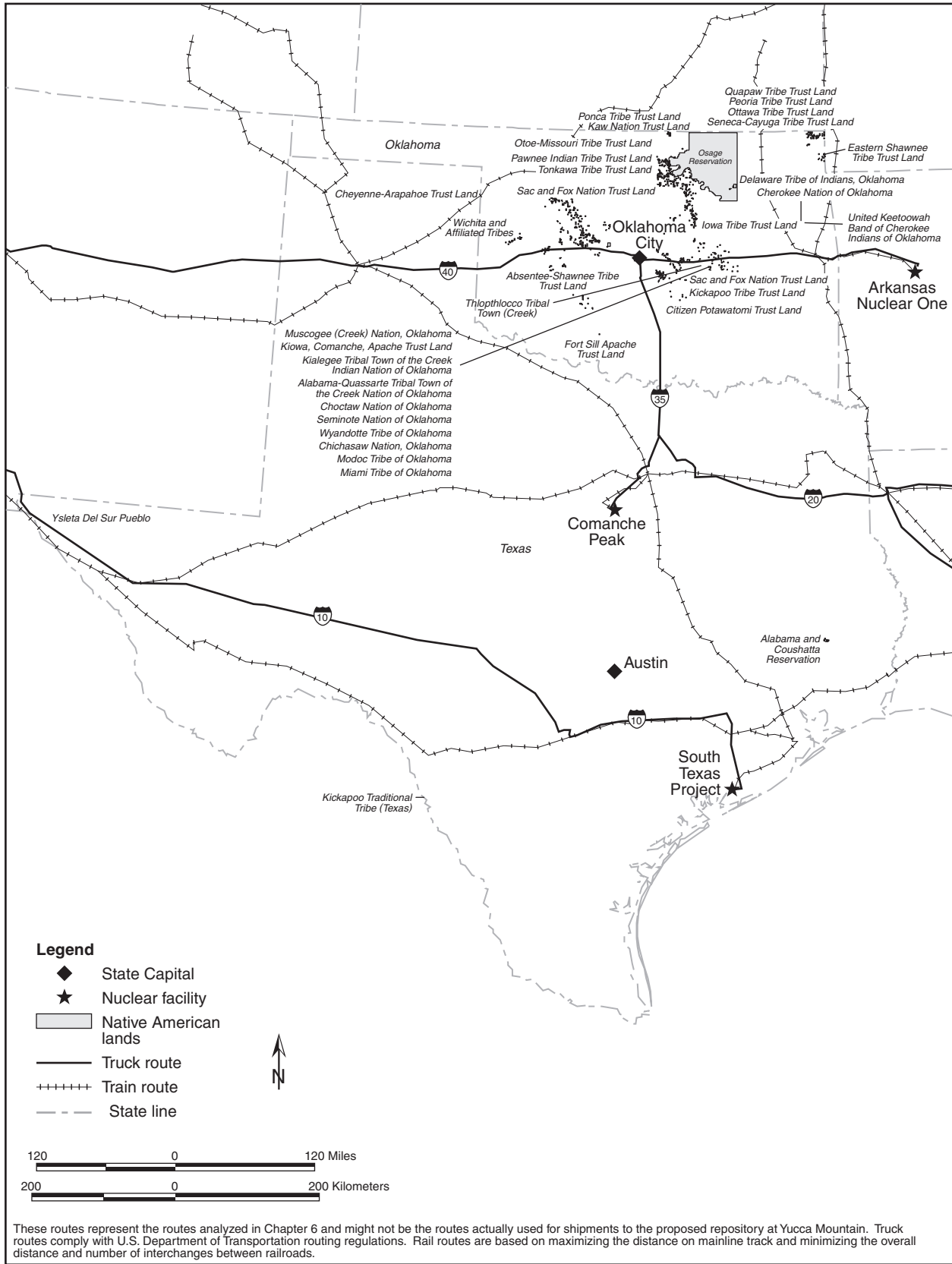

Figure J-51. Highway and rail routes used to analyze transportation impacts - Oklahoma and Texas.

Table J-92. Estimated transportation impacts for the States of Utah and Wyoming.

Impact category	Mostly legal-weight truck	Mostly rail					
		Ending rail node in Nevada ^a					
		Caliente ^b	Dry Lake ^c	Jean ^d	Beowawe ^e	Eccles ^f	Apex ^g
UTAH							
<i>Shipments</i>							
Truck (originating/total)	0/45,919	0/1,079	0/1,079	0/1,079	0/1,079	0/1,079	0/1,079
Rail (originating/total)	0/300	0/8,986	0/8,896	0/8,182	0/9,134	0/9,052	0/8,742
<i>Radiological impacts</i>							
Incident-free impacts							
Population (person-rem/LCFs) ^h	9.6×10 ² /4.8×10 ⁻¹	1.8×10 ² /8.8×10 ⁻²	1.8×10 ² /8.8×10 ⁻²	1.1×10 ³ /5.6×10 ⁻¹	1.8×10 ² /8.8×10 ⁻²	1.8×10 ² /8.8×10 ⁻²	1.7×10 ² /8.6×10 ⁻²
Workers (person-rem/LCFs)	1.9×10 ³ /7.4×10 ⁻¹	3.6×10 ² /1.4×10 ⁻¹	3.6×10 ² /1.4×10 ⁻¹	2.2×10 ³ /8.8×10 ⁻¹	3.6×10 ² /1.4×10 ⁻¹	3.6×10 ² /1.4×10 ⁻¹	3.6×10 ² /1.4×10 ⁻¹
Accident dose risk							
Population (person-rem/LCFs)	1.0×10 ¹ /5.2×10 ⁻⁵	7.2×10 ⁻² /3.6×10 ⁻⁵	7.2×10 ⁻² /3.6×10 ⁻⁵	1.8×10 ⁻¹ /8.8×10 ⁻⁵	7.2×10 ⁻² /3.6×10 ⁻⁵	7.2×10 ⁻² /3.6×10 ⁻⁵	7.2×10 ⁻² /3.6×10 ⁻⁵
<i>Nonradiological impacts</i>							
Vehicle emissions (LCFs)	2.8×10 ⁻¹	8.7×10 ⁻²	8.7×10 ⁻²	3.6×10 ⁻¹	8.7×10 ⁻²	8.7×10 ⁻²	8.4×10 ⁻²
Fatalities	0.71	0.58	0.58	1.25	0.58	0.58	0.57
WYOMING							
<i>Shipments</i>							
Truck (originating/total)	0/41,507	0/1,079	0/1,079	0/1,079	0/1,079	0/1,079	0/1,079
Rail (originating/total)	0/0	0/7,347	0/7,347	0/7,065	0/7,440	0/7,347	0/7,347
<i>Radiological impacts</i>							
Incident-free impacts							
Population (person-rem/LCFs) ^h	5.4×10 ² /2.7×10 ⁻¹	4.4×10 ¹ /2.2×10 ⁻²	4.4×10 ¹ /2.2×10 ⁻²	4.3×10 ¹ /2.1×10 ⁻²	4.4×10 ¹ /2.2×10 ⁻²	4.4×10 ¹ /2.2×10 ⁻²	4.4×10 ¹ /2.2×10 ⁻²
Workers (person-rem/LCFs)	1.7×10 ³ /6.9×10 ⁻¹	3.8×10 ² /1.5×10 ⁻¹	3.8×10 ² /1.5×10 ⁻¹	3.7×10 ² /1.5×10 ⁻¹	3.8×10 ² /1.5×10 ⁻¹	3.8×10 ² /1.5×10 ⁻¹	3.8×10 ² /1.5×10 ⁻¹
Accident dose risk							
Population (person-rem/LCFs)	3.9×10 ⁻² /1.9×10 ⁻⁵	7.1×10 ⁻³ /3.6×10 ⁻⁶	7.1×10 ⁻³ /3.6×10 ⁻⁶	6.8×10 ⁻³ /3.4×10 ⁻⁶	7.2×10 ⁻³ /3.6×10 ⁻⁶	7.1×10 ⁻³ /3.6×10 ⁻⁶	7.1×10 ⁻³ /3.6×10 ⁻⁶
<i>Nonradiological impacts</i>							
Vehicle emissions (LCFs)	38.7×10 ⁻³	15.9×10 ⁻³	15.9×10 ⁻³	15.4×10 ⁻³	16.1×10 ⁻³	15.9×10 ⁻³	15.9×10 ⁻³
Fatalities	0.58	0.06	0.06	0.06	0.06	0.06	0.06

- a. Under the mostly rail scenario, rail shipments would arrive in Nevada at one of six existing rail nodes. Impacts would vary according to the node. From that node, DOE would use one of the rail or heavy-haul implementing alternatives to complete the transportation to Yucca Mountain (see Section J.1.2).
- b. For heavy-haul truck transportation, the Caliente junction is the location of the proposed Caliente intermodal transfer station for heavy-haul trucks near the town of Caliente in eastern Nevada. Rail shipments terminating at this junction would continue to Yucca Mountain on heavy-haul trucks on one of the Caliente, Caliente/Chalk Mountain, or Caliente/Las Vegas routes. For branch rail line transportation, railcars would transfer via the Caliente Option to the Caliente Corridor at the Caliente junction.
- c. For heavy-haul truck transportation, the Dry Lake junction is near the location of the proposed Apex/Dry Lake intermodal transfer station for heavy-haul trucks in southeast Nevada. Rail shipments terminating at this junction would continue to Yucca Mountain on heavy-haul trucks on the Apex/Dry Lake route.
- d. For heavy-haul truck transportation, the Jean junction is near the location of the proposed Sloan/Jean intermodal transfer station for heavy-haul trucks in southern Nevada. Rail shipments terminating at this junction would continue to Yucca Mountain on heavy-haul trucks on the Sloan/Jean route. For branch rail line transportation, railcars would transfer from the mainline railroad via the Wilson Pass or Stateline Pass Option of the Jean Corridor, near the Jean junction.
- e. For branch rail line transportation, railcars would transfer from the mainline railroad at the Beowawe junction in north-central Nevada to the Carlin Corridor.
- f. For branch rail line transportation, railcars would transfer from the mainline railroad at the Eccles junction east of Caliente, Nevada, via the Eccles Option or nearby via the Crestline Option of the Caliente or Caliente-Chalk Mountain Corridor. Impacts in states outside Nevada would be the same for the Eccles and Crestline Options of the Caliente and Caliente-Chalk Mountain Corridors.
- g. For branch rail line transportation, railcars would transfer from the mainline railroad at the Apex junction in southeast Nevada, possibly via the Valley Connection, to the Valley Modified Corridor.
- h. LCF = latent cancer fatality.

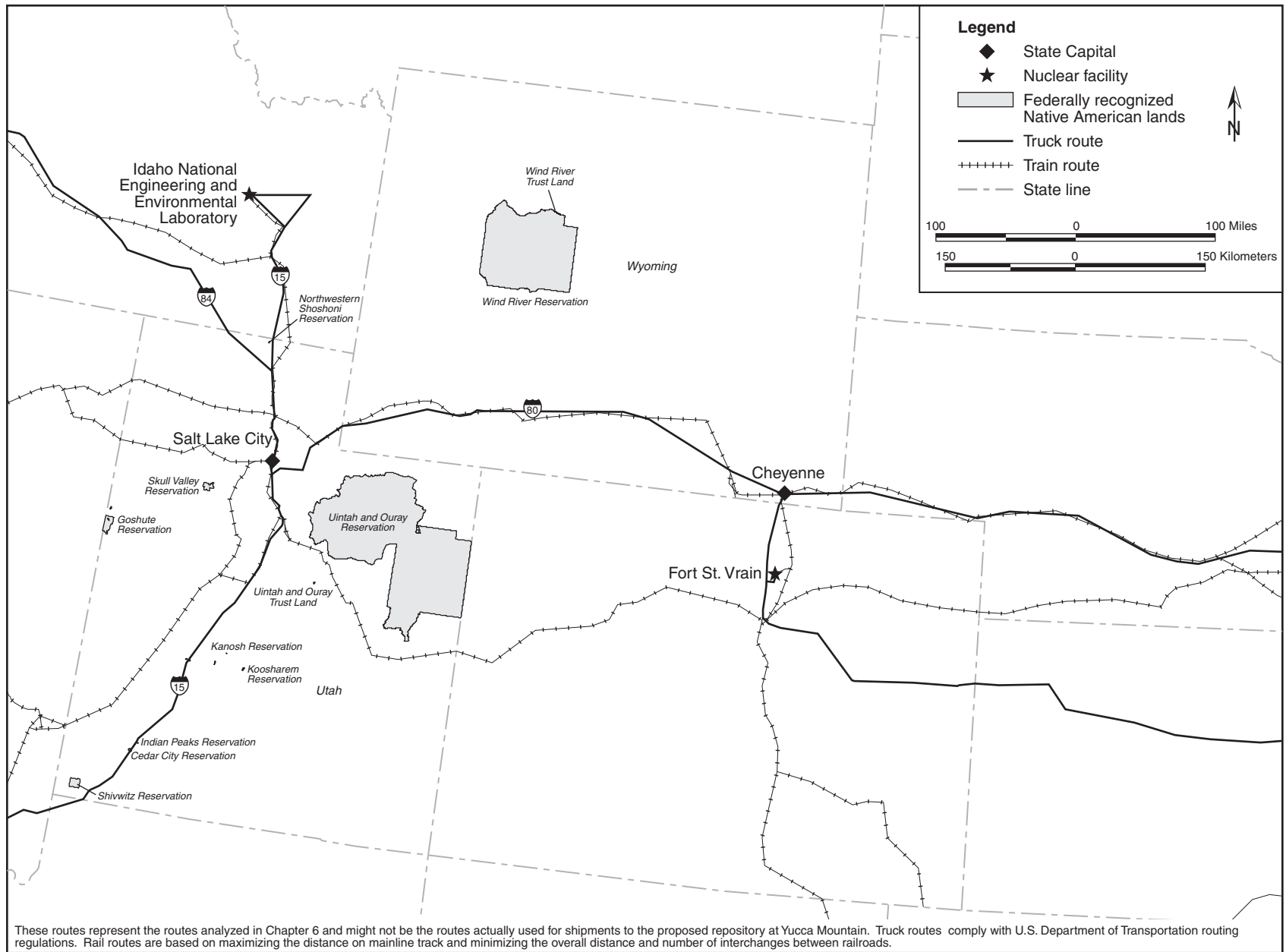

Figure J-52. Highway and rail routes used to analyze transportation impacts - Utah and Wyoming.

Table J-93. Estimated transportation impacts for the State of Nevada.

Impact category	Mostly legal-weight truck	Mostly rail									
		Rail implementing alternatives					Heavy-haul implementing alternatives				
		Caliente	Carlin	Caliente-Chalk Mountain	Jean	Valley Modified	Caliente	Caliente/Chalk Mountain	Caliente/Las Vegas	Sloan/Jean	Apex/Dry Lake
NEVADA											
<i>Shipments</i>											
Truck (originating/total)	0/52,786	0/1,079	0/1,079	0/1,079	0/1,079	0/1,079	0/1,079	0/1,079	0/1,079	0/1,079	0/1,079
Rail (originating/total)	0/300	0/9,646	0/9,646	0/9,646	0/9,646	0/9,646	0/9,646	0/9,646	0/9,646	0/9,646	0/9,646
<i>Radiological impacts</i>											
<i>Incident-free impacts</i>											
Population (person-rem/LCFs) ^a	3.5 × 10 ² / 1.8 × 10 ⁻¹	1.9 × 10 ¹ / 9.4 × 10 ⁻³	3.8 × 10 ¹ / 1.9 × 10 ⁻²	1.8 × 10 ¹ /9.1 × 10 ⁻³	1.6 × 10 ² / 7.8 × 10 ⁻²	2.6 × 10 ¹ / 1.3 × 10 ⁻²	7.9 × 10 ¹ / 3.9 × 10 ⁻²	6.3 × 10 ¹ /3.2 × 10 ⁻²	2.2 × 10 ² / 1.1 × 10 ⁻¹	3.3 × 10 ² / 1.7 × 10 ⁻¹	1.6 × 10 ² / 7.8 × 10 ⁻²
Workers (person-rem/LCFs)	1.9 × 10 ³ / 7.5 × 10 ⁻¹	8.3 × 10 ² / 3.3 × 10 ⁻¹	9.6 × 10 ² / 3.8 × 10 ⁻¹	7.3 × 10 ² /2.9 × 10 ⁻¹	7.4 × 10 ² / 3.0 × 10 ⁻¹	7.0 × 10 ² / 2.8 × 10 ⁻¹	1.4 × 10 ³ / 5.5 × 10 ⁻¹	9.8 × 10 ² /3.9 × 10 ⁻¹	1.1 × 10 ³ / 4.5 × 10 ⁻¹	9.3 × 10 ² / 3.7 × 10 ⁻¹	8.9 × 10 ² / 3.5 × 10 ⁻¹
Accident dose risk Population (person-rem/LCFs)	5.3 × 10 ⁻² / 2.6 × 10 ⁻⁵	1.7 × 10 ⁻³ / 8.6 × 10 ⁻⁷	2.6 × 10 ⁻³ / 1.3 × 10 ⁻⁶	1.7 × 10 ⁻³ /8.5 × 10 ⁻⁷	7.1 × 10 ⁻³ / 3.6 × 10 ⁻⁶	2.1 × 10 ⁻³ / 1.0 × 10 ⁻⁶	1.0 × 10 ⁻² / 5.1 × 10 ⁻⁶	2.0 × 10 ⁻³ /1.0 × 10 ⁻⁶	5.6 × 10 ⁻² / 2.8 × 10 ⁻⁵	1.2 × 10 ⁻¹ / 6.0 × 10 ⁻⁵	5.6 × 10 ⁻² / 2.8 × 10 ⁻⁵
<i>Nonradiological impacts</i>											
Vehicle emissions (LCFs)	9.3 × 10 ⁻²	7.1 × 10 ⁻³	1.8 × 10 ⁻²	7.7 × 10 ⁻³	7.7 × 10 ⁻²	1.1 × 10 ⁻²	1.6 × 10 ⁻²	7.9 × 10 ⁻³	6.4 × 10 ⁻²	1.9 × 10 ⁻¹	6.6 × 10 ⁻²
Fatalities	0.49	0.07	0.09	0.05	0.06	0.05	0.60	0.33	0.43	0.25	0.23

- a. Includes impacts of an intermodal transfer station.
- b. LCF = latent cancer fatality.

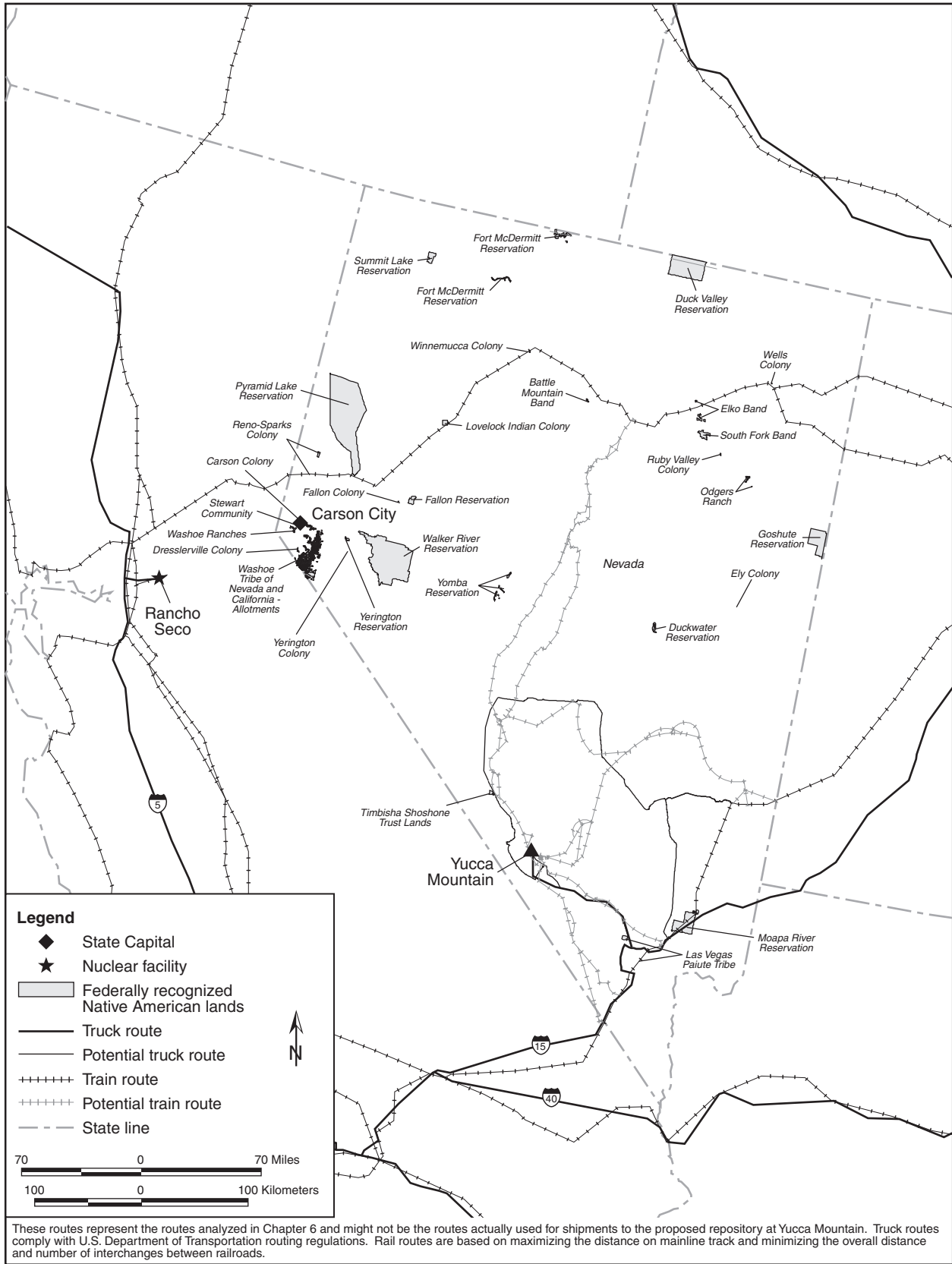

Figure J-53. Highway and rail routes used to analyze transportation impacts - Nevada.

REFERENCES

Note: In an effort to ensure consistency among Yucca Mountain Site Characterization Project documents, DOE has altered the format of the references and some of the citations in the text in this Final EIS from those in the Draft EIS. The following list contains notes where applicable for references cited differently in the Draft EIS.

- 103072 Ardila-Coulson 1989 Ardila-Coulson, M.V. 1989. *The Statewide Radioactive Materials Transportation Plan*. Phase II. Reno, Nevada: University of Nevada, Reno. TIC: 222209.
- 104597 Battelle 1998 Battelle Pacific Northwest Division 1998. *Analytical Approach for Estimating Releases of Spent Nuclear Fuel and High-Level Waste for the Yucca Mountain Environmental Impact Statement No-Action Alternative*. Las Vegas, Nevada: Jason Technologies. ACC: MOL.19990513.0039.
- 155112 Berger 2000 The Louis Berger Group, Inc. 2000. *Assessment of the Hazards of Transporting Spent Nuclear Fuel and High Level Radioactive Waste to the Proposed Yucca Mountain Repository using the Proposed Northern Las Vegas Beltway*. Las Vegas, Nevada: The Louis Berger Group. TIC: 250165.
- 104725 Best 1998 Best, R. 1998. "Contact Report - Meeting with McCarran Airport Officials re: Flight Track Data." Memo from R. Best (Jason Technologies) to W. Dixon and K. Skipper (CRWMS M&O), April 17, 1998, JYM-99-018. ACC: MOL.19990511.0373.
- 151198 Biwer and Butler 1999 Biwer, B.M. and Butler, J.P. 1999. "Vehicle Emission Unit Risk Factors for Transportation Risk Assessments." *Risk Analysis*, 19, (6), 1157-1171. [Norwell, Massachusetts: Kluwer Academic Publishers]. TIC: 248506.
- 102060 Biwer et al. 1997 Biwer, B.M.; Arnish, J.J.; Kamboj, S.; and Chen, S.Y. 1997. *RISKIND Verification and Benchmark Comparisons*. ANL/EAD/TM-74. Argonne, Illinois: Argonne National Laboratory. TIC: 243692.
- 148091 BLS 1998 BLS (Bureau of Labor Statistics) 1998. "Safety of Health Statistics, Table 1. Incidence Rates of Nonfatal Occupational Injuries and Illnesses by Selected Industries and Case Types, 1997." Washington, D.C.: U.S. Department of Commerce. Accessed December 18, 1998. TIC: 243569. <http://stats.bls.gov/news.release/osh/t01.htm>
- 156755 BLS 2001 BLS (Bureau of Labor Statistics) 2001. *Fatal Workplace Injuries in 1998 and 1999: A Collection of Data and Analysis*. Report 954. Washington, DC: U.S. Department of Labor. TIC: 251280.
- 157210 BSC 2001 BSC (Bechtel SAIC Company, LLC) 2001. *Consequence of an Aircraft Crash into a Transportation Cask*. Las Vegas, Nevada: Bechtel SAIC Company.

- 103708 BTS 1996 BTS (Bureau of Transportation Statistics) 1996. *Freight Transportation in Nevada, Selected Data from Federal Sources*. Washington, D.C.: U.S. Department of Transportation. TIC: 244068.
- 148080 BTS 1998 BTS (Bureau of Transportation Statistics) 1998. "Automobile Profile - 1960, 1970, 1980, 1990, 1994." National Transportation Statistics 1998 (NTS), Appendix A. Modal Profiles. Washington, D.C.: U.S. Department of Transportation. Accessed October 9, 1998. TIC: 244071. <http://www.bts.gov/btsprod/nts/apxa/auto98.html>
- 148081 BTS 1999 BTS (Bureau of Transportation Statistics) 1999. "National Transportation Statistics 1998 (NTS)." Washington, D.C.: U.S. Department of Transportation. Accessed March 29, 1999. TIC: 243149. <http://www.bts.gov/btsprod/nts/index.html>
- 103156 Bureau of the Census 1997 Bureau of the Census 1997. *Statistical Abstract of the United States 1997*. 117th Edition. Washington, D.C.: U.S. Department of Commerce, Bureau of the Census. TIC: 8657.
- 103160 Bury and Germano 1994 Bury, R.B. and Germano, D.J., eds. 1994. *Biology of North American Turtles. Fish and Wildlife Research Report 13*. Washington, D.C.: U.S. Department of the Interior. TIC: 225209.
- 103709 Caltrans 1997 Caltrans (California Department of Transportation) 1997. *State Highway Inventory Data on California State Highway Route Segments*. Sacramento, California: Caltrans Publications Unit. TIC: 241860.
- 104727 Cerocke 1998 Cerocke, C. 1998. Truck Percents. Facsimile from C. Cerocke (Nevada Department of Transportation) to R. Best (Jason Technologies), July 8, 1998. ACC: MOL.19990511.0291.
- 152083 Chanin and Murfin 1996 Chanin, D.I. and Murfin, W.B. 1996. Site Restoration: *Estimation of Attributable Costs From Plutonium-Dispersion Accidents*. SAND96-0957. Albuquerque, New Mexico: Sandia National Laboratories. TIC: 248778.
- 103710 Clark County 1997 Clark County 1997. *Environmental Study for the Northern and Western Las Vegas Beltway Transportation Facilities and Right-of-Way Footprint*. Las Vegas, Nevada: Clark County Department of Public Works. TIC: 244001.
- 156706 Clark County 2000 Clark County 2000. *Carbon Monoxide State Implementation Plan Las Vegas Valley Nonattainment Area*. Las Vegas, NV: Department of Comprehensive Planning, Clark County Board of Commissioners.
- 155557 Clark County 2001 Clark County 2001. "Particulate Matter (PM₁₀) State Implementation Plan." [Las Vegas, Nevada]: Clark County. Accessed April 10, 2001. ACC: MOL.20010802.0201. http://www.co.clark.nv.us/compplan/Environ/Aqteam/Pm10/pm10_Chpt1.htm

- 104786 Cook 1994 Cook, G.N. 1994. Raytheon Services Nevada Study on High-Speed Rail Transportation Between Las Vegas and the Nevada Test Site (NTS). Letter from G.N. Cook (DOE/YMSCO) to R.R. Loux (State of Nevada), October 31, 1994, with enclosure. ACC: MOL.19950721.0006; MOL.19950721.0007. In the Draft EIS, this reference was cited as Raytheon 1994 in Appendix J.
- 103177 CP&L 1989 CP&L (Carolina Power and Light Company) 1989. *Brunswick Steam Electric Plant Independent Spent Fuel Storage Installation Safety Analysis Report*. Raleigh, North Carolina: Carolina Power and Light Company. TIC: 3933.
- 104794 CRWMS M&O 1994 CRWMS M&O (Civilian Radioactive Waste Management System Management and Operating Contractor) 1994. *Health and Safety Impacts Analysis for the Multi-Purpose Canister System and Alternatives*. A00000000-01717-0200-00006 REV 02. Vienna, Virginia: CRWMS M&O. ACC: MOV.19950217.0043. In the Draft EIS, this reference was cited as TRW 1994 in Appendix J.
- 104795 CRWMS M&O 1995 CRWMS M&O (Civilian Radioactive Waste Management System Management and Operating Contractor) 1995. *Nevada Potential Repository Preliminary Transportation Strategy Study 1*. B00000000-01717-4600-00023 REV 01. Las Vegas, Nevada: CRWMS M&O. ACC: MOL.19960729.0195. In the Draft EIS, this reference was cited as TRW 1995 in Appendix J.
- 101214 CRWMS M&O 1996 CRWMS M&O (Civilian Radioactive Waste Management System Management and Operating Contractor) 1996. *Nevada Potential Repository Preliminary Transportation Strategy Study 2*. B00000000-01717-4600-00050 REV 01. Two volumes. Las Vegas, Nevada: CRWMS M&O. ACC: MOL.19960724.0199; MOL.19960724.0200. In the Draft EIS, this reference was cited as TRW 1996 in Appendix J.
- 100265 CRWMS M&O 1997 CRWMS M&O (Civilian Radioactive Waste Management System Management and Operating Contractor) 1997. *Waste Quantity, Mix and Throughput Study Report*. B00000000-01717-5705-00059 REV 01. Las Vegas, Nevada: CRWMS M&O. ACC: MOL.19971210.0628. In the Draft EIS, this reference was cited as TRW 1997 in Appendix J.
- 131242 CRWMS M&O 1997 CRWMS M&O (Civilian Radioactive Waste Management System Management and Operating Contractor) 1997. *Rail Alignments Analysis*. BCBI00000-01717-0200-00002 REV 00. Las Vegas, Nevada: CRWMS M&O. ACC: MOL.19971212.0486. In the Draft EIS, this reference was cited as TRW 1999b in Appendix J.
- 104849 CRWMS M&O 1997 CRWMS M&O (Civilian Radioactive Waste Management System Management and Operating Contractor) 1997. *Intermodal Transfer Station Preliminary Design*. BCBI00000-01717-0200-00007 REV 00. Las Vegas, Nevada: CRWMS M&O. ACC: MOL.19980303.0029. In the Draft EIS, this reference was cited as TRW 1999b in Appendix J.

- 155436 CRWMS M&O 1997 CRWMS M&O (Civilian Radioactive Waste Management System Management and Operating Contractor) 1997. *Nevada Potential Repository Preliminary Assessment of the Caliente-Chalk Mountain Heavy-Haul Truck Route*. B00000000-01717-4600-00084 REV 00. Predecisional Working Draft. Las Vegas, Nevada: CRWMS M&O. ACC: MOL.19970507.0140.
- 155628 CRWMS M&O 1997 CRWMS M&O (Civilian Radioactive Waste Management System Management and Operating Contractor) 1997. *Fifth Corridor Boundary Evaluation*. BCBI00000-01717-0200-0001 REV 00. Las Vegas, Nevada: CRWMS M&O. ACC: MOL.19981207.0253. In the Draft EIS, this reference was cited as TRW 1999b in Appendix J.
- 154448 CRWMS M&O 1998 CRWMS M&O (Civilian Radioactive Waste Management System Management and Operating Contractor) 1998. *Road Upgrades for Heavy Haul Truck Routes*. BCBI00000-01717-0200-00008 REV 00. Las Vegas, Nevada: CRWMS M&O. ACC: MOL.19981207.0254. In the Draft EIS, this reference was cited as TRW 1999b in Appendix J.
- 155644 CRWMS M&O 1999 CRWMS M&O (Civilian Radioactive Waste Management System Management and Operating Contractor) 1999. *User Manual for the CRWMS Analysis and Logistics Visually Interactive Model Version 2.0*. 10074-UM-2.0-00, Rev. 00 Vienna, Virginia: CRWMS M&O. ACC: MOV.19990322.0001.
- 104800 CRWMS M&O 1999 CRWMS M&O (Civilian Radioactive Waste Management System Management and Operating Contractor) 1999. *Environmental Baseline File for National Transportation*. B00000000-01717-5705-00116 REV 01. Las Vegas, Nevada: CRWMS M&O. ACC: MOL.19990608.0033. In the Draft EIS, this reference was cited as TRW 1999a in Appendix J.
- 155347 CRWMS M&O 1999 CRWMS M&O (Civilian Radioactive Waste Management System Management and Operating Contractor) 1999. *Nevada Transportation Engineering File, Data Needs Request Log*. [Las Vegas, Nevada: CRWMS M&O]. ACC: MOL.19990324.0278. In the Draft EIS, this reference was cited as TRW 1999b in Appendix J.
- 157206 CRWMS M&O 2000 CRWMS M&O (Civilian Radioactive Waste Management System Management and Operating Contractor) 2000. *Truck and Rail Shipments of Commercial Spent Nuclear Fuel for the Final EIS*. Input Transmittal 00135.T. Las Vegas, Nevada: CRWMS M&O. ACC: MOL.20000516.0014.
- 156422 CVSA 2001 CVSA (Commercial Vehicle Safety Alliance) 2001. *Appendix A North American Uniform Standard Out-of-Service Criteria*. Bethesda, Maryland: Commercial Vehicle Safety Alliance.
- 104728 Denison 1998 Denison, D.L. 1998. Crash Rate for the State of Nevada for Interstate Truck Carriers. Letter from D.L. Denison (Nevada Highway Patrol) to K.J. Skipper (DOE/YMSCO), May 20, 1998. ACC: MOL.19990630.0369.

- 104832 DOE 1980 DOE (U.S. Department of Energy) 1980. *Final Environmental Impact Statement Management of Commercially Generated Radioactive Waste*. DOE/EIS-0046F. Three volumes. Washington, D.C.: U.S. Department of Energy, Office of Nuclear Waste Management. ACC: HQZ.19870302.0183; HQZ.19870302.0184; HQZ.19870302.0185.
- 104731 DOE 1986 DOE (U.S. Department of Energy) 1986. *Environmental Assessment for a Monitored Retrievable Storage Facility*. Volume II of *Monitored Retrievable Storage Submission to Congress*. DOE/RW-0035/1. Washington, D.C.: U.S. Department of Energy, Office of Civilian Radioactive Waste Management. ACC: HQO.19950815.0019.
- 104791 DOE 1992 DOE (U.S. Department of Energy) 1992. "Analysis of a System Containing a Monitored Retrievable Storage Facility." Addendum I of *Analysis of Radiation Doses from Operation of Postulated Commercial Spent Fuel Transportation Systems*. DOE-CH/TPO-001. Chicago, Illinois: U.S. Department of Energy. ACC: HQX.19920604.0012. In the Draft EIS, this reference was cited as Smith, Daling, and Faletti 1992 in Appendix J.
- 104601 DOE 1993 DOE (U.S. Department of Energy) 1993. *Recommendations for the Preparation of Environmental Assessments and Environmental Impact Statements*. Washington, D.C.: U.S. Department of Energy, Office of NEPA Oversight. ACC: HQX.19930623.0005.
- 104382 DOE 1995 DOE (U.S. Department of Energy) 1995. *Acceptance Priority Ranking & Annual Capacity Report*. DOE/RW-0457. Washington, D.C.: U.S. Department of Energy, Office of Civilian Radioactive Waste Management. ACC: MOV.19960910.0021.
- 101802 DOE 1995 DOE (U.S. Department of Energy) 1995. *Department of Energy Programmatic Spent Nuclear Fuel Management and Idaho National Engineering Laboratory Environmental Restoration and Waste Management Programs Final Environmental Impact Statement*. DOE/EIS-0203-F. Idaho Falls, Idaho: U.S. Department of Energy, Idaho Operations Office. TIC: 216020.
- 101810 DOE 1996 DOE (U.S. Department of Energy) 1996. *DOE Standard, Accident Analysis for Aircraft Crash into Hazardous Facilities*. DOE-STD-3014-96. Washington, D.C.: U.S. Department of Energy. TIC: 231519.
- 101811 DOE 1996 DOE (U.S. Department of Energy) 1996. *Final Environmental Impact Statement for the Nevada Test Site and Off-Site Locations in the State of Nevada*. DOE/EIS-0243. Las Vegas, Nevada: U.S. Department of Energy, Nevada Operations Office. TIC: 239895.
- 101812 DOE 1996 DOE (U.S. Department of Energy) 1996. *Final Environmental Impact Statement on a Proposed Nuclear Weapons Nonproliferation Policy Concerning Foreign Research Reactor Spent Nuclear Fuel*. DOE/EIS-0218F. Washington, D.C.: U.S. Department of Energy. TIC: 223998.

- 101814 DOE 1997 DOE (U.S. Department of Energy) 1997. *Waste Isolation Pilot Plant Disposal Phase, Final Supplemental Environmental Impact Statement*. Three volumes. DOE/EIS-0026-S-2. Carlsbad, New Mexico: U.S. Department of Energy. TIC: 238195.
- 101816 DOE 1997 DOE (U.S. Department of Energy) 1997. *Final Waste Management Programmatic Environmental Impact Statement for Managing Treatment, Storage, and Disposal of Radioactive and Hazardous Waste*. DOE/EIS-0200-F. Washington, D.C.: U.S. Department of Energy. TIC: 232988.
- 104741 DOE 1998 DOE (U.S. Department of Energy) 1998. *Office of Civilian Radioactive Waste Management; Safe Routine Transportation and Emergency Response Training; Technical Assistance and Funding - Notice of Revised Proposed Policy and Procedures*. Washington, D.C.: U.S. Department of Energy. ACC: HQO.19980603.0023.
- 101779 DOE 1998 DOE (U.S. Department of Energy) 1998. *Viability Assessment of a Repository at Yucca Mountain*. DOE/RW-0508. Overview and five volumes. Washington, D.C.: U.S. Department of Energy, Office of Civilian Radioactive Waste Management. ACC: MOL.19981007.0027; MOL.19981007.0028; MOL.19981007.0029; MOL.19981007.0030; MOL.19981007.0031; MOL.19981007.0032.
- 156764 DOE 1999 DOE (U.S. Department of Energy) 1999. *DOE Standard - Radiological Control*. DOE-STD-1098-99. Washington, DC: U.S. Department of Energy.
- 155779 DOE 1999 DOE (U.S. Department of Energy) 1999. *Intermodal and Highway Transportation of Low-level Radioactive Waste to the Nevada Test Site*. DOE/NV-544-VOL I. Las Vegas, Nevada: U.S. Department of Energy. ACC: MOL.20011009.0006.
- 155566 DOE 2000 DOE (U.S. Department of Energy) 2000. *Clean Air Act General Conformity Requirements and the National Environmental Policy Act Process*. Washington, D.C.: U.S. Department of Energy, Environment, Safety and Health Office of NEPA Policy and Assistance. ACC: MOL.20010802.0219.
- 103718 DOT 1998 DOT (U.S. Department of Transportation) 1998. *Final Report, Identification of Factors for Selecting Modes and Routes for Shipping High-Level Radioactive Waste and Spent Nuclear Fuel*. Washington, D.C.: U.S. Department of Transportation. TIC: 243882.
- 103717 DOT 1998 DOT (U.S. Department of Transportation) 1998. *Hazardous Materials Shipments*. Washington, D.C.: U.S. Department of Transportation. TIC: 243499.
- 103720 DOT Undated DOT (U.S. Department of Transportation) Undated. *Biennial Report on Hazardous Materials Transportation Calendar Years 1992-1993*. Washington, D.C.: U.S. Department of Transportation. TIC: 243847.

- 155780 EPA 1993 EPA (U.S. Environmental Protection Agency) 1993. *Motor Vehicle-Related Air Toxics Study*. EPA 420-R-93-005. Ann Arbor, Michigan: U.S. Environmental Protection Agency.
- 155786 EPA 1997 EPA (U.S. Environmental Protection Agency) 1997. "Chapter 13.2.1, Paved Roads." AP42, Fifth Edition, Volume I, Supplements A through G, U.S. EPA Clearinghouse for Inventories and Emission Factors. Washington, D.C.: U.S. Environmental Protection Agency. Accessed August 2, 2001. ACC: MOL.20011009.0009. <http://www.epa.gov/ttn/chief/index.html>
- 156753 Ettlin 2001 Ettlin, D.M. 2001. "Burning Cars in Rail Tunnel Resist Control; Crews Use Manhole to Approach Blaze with Cooling Water 'Like Walking into an Oven' 5 of 60 Cars Removed." Baltimore, Maryland: The Baltimore Sun. Accessed October 30, 2001. [http://www.sunspot.net/tunnel fire/sunspot_net - archive2.htm](http://www.sunspot.net/tunnel%20fire/sunspot_net%20-%20archive2.htm)
- 156110 FEMA 2000 FEMA (Federal Emergency Management Agency) 2000. *Guidance for Developing State, Tribal, and Local Radiological Emergency Response Planning and Preparedness for Transportation Accidents*. FEMA REP-5, Rev .02 Washington, D.C.: Federal Emergency Management Agency. Submit to RPC
- 101826 FHWA 1996 FHWA (Federal Highway Administration) 1996. *Northern & Western Las Vegas Beltway, Clark County, Nevada: Tier I Final Environmental Impact Statement and Corridor Location Study*. FHWA-NV-EIS-95-01-F. Carson City, Nevada: U.S. Department of Transportation. TIC: 242309.
- 103721 FHWA 1997 FHWA (Federal Highway Administration) 1997. *Truck Crash Profile: The National Picture 1996*. Washington, D.C.: Federal Highway Administration. TIC: 244136.
- 102231 FHWA 1998 FHWA (Federal Highway Administration) 1998. *Large Truck Crash Profile: The 1997 National Picture*. Washington, D.C.: Federal Highway Administration. TIC: 243788.
- 102064 FHWA 1999 FHWA (Federal Highway Administration) 1999. "Technical Appendix, Our Nation's Travel: 1995 NPTS Early Results Report." Oak Ridge, Tennessee: U.S. Department of Transportation. Accessed April 5, 1999. TIC: 244043. <http://www-cta.ornl.gov/npts/1995/Doc/index.shtml>. In the Draft EIS, this reference was cited as ORNL 1999 in Appendix J.
- 155054 Finley et al. 1980 Finley, N.C.; Aldrich, D.C.; Daniel, S.L.; Ericson, D.M.; Henning-Sachs, C.; Kaestner, P.C.; Ortiz, N.R.; Sheldon, D.D.; and Taylor, J.M. 1980. *Transportation of Radionuclides in Urban Environs: Draft Environmental Assessment*. NUREG/CR-0743. Washington, D.C.: U.S. Nuclear Regulatory Commission. TIC: 221621.

- 101828 Fischer et al. 1987 Fischer, L.E.; Chou, C.K.; Gerhard, M.A.; Kimura, C.Y.; Martin, R.W.; Mensing, R.W.; Mount, M.E.; and Witte, M.C. 1987. *Shipping Container Response to Severe Highway and Railway Accident Conditions*. NUREG/CR-4829. Two volumes. Washington, D.C.: U.S. Nuclear Regulatory Commission. ACC: NNA.19900827.0230; NNA.19900827.0231.
- 101831 General Atomics 1993 General Atomics 1993. *GA-4 Legal Weight Truck From-Reactor Spent Fuel Shipping Cask, Final Design Report*. 910353/0. San Diego, California: General Atomics. ACC: NNA.19940513.0215.
- 152084 Griego, Smith, and Neuhauser 1996 Griego, N.R.; Smith, J.D.; and Neuhauser, K.S. 1996. *Investigation of Radtran Stop Model Input Parameters for Truck Stops*. [SAND96-0714C]. Albuquerque, New Mexico: Sandia National Laboratories. TIC: 240366.
- 104777 Holmes & Narver 1962 Holmes & Narver 1962. *Feasibility Study for Transportation Facilities to Nevada Test Site*. [Orange, California]: Holmes & Narver. ACC: MOL.19950509.0039.
- 101836 ICRP 1991 ICRP (International Commission on Radiological Protection) 1991. "1990 Recommendations of the International Commission on Radiological Protection." Volume 21, No. 1-3 of *Annals of the ICRP*. ICRP Publication 60. New York, New York: Pergamon Press. TIC: 235864.
- 101837 JAI 1996 JAI 1996. *Shipping and Storage Cask Data for Commercial Spent Nuclear Fuel*. JAI-421. Fairfax, Virginia: JAI Corporation. TIC: 232956.
- 104778 Jensen 1998 Jensen 1998. "Radionuclide Data for DOE SNF Decayed to the Year 2030." E-mail from C. Jensen (INEEL) to S. Ross, J. Rivers, J.H. Boyd (INEEL), DFF (INEEL), R. McCormack (RL), and K. Skipper, February 27, 1998, with attachment. ACC: MOL.19990526.0028.
- 104780 Johnson et al. 1993 Johnson, P.E.; Joy, D.S.; Clarke, D.B.; and Jacobi, J.M. 1993. *HIGHWAY 3.1—An Enhanced Highway Routing Model: Program Description, Methodology, and Revised User's Manual*. ORNL/TM-12124. D00000000-02268-2003-20012 REV 1. Oak Ridge, Tennessee: Oak Ridge National Laboratory. ACC: MOV.19960711.0024.
- 104781 Johnson et al. 1993 Johnson, P.E.; Joy, D.S.; Clarke, D.B.; and Jacobi, J.M. 1993. *INTERLINE 5.0—An Expanded Railroad Routing Model: Program Description, Methodology, and Revised User's Manual*. ORNL/TM-12090. D00000000-02268-2002-20015 REV 1. Oak Ridge, Tennessee: Oak Ridge National Laboratory. ACC: MOV.19960711.0014.
- 104782 Kelderhouse 1999 Kelderhouse, S. 1999. "LWT, HH and Rail Transportation Graphics." E-mail from S. Kelderhouse to R. Best (CRWMS M&O), April 27, 1999, with attachment. ACC: MOL.19990526.0027.

- 155931 Knop 2001 Knop, M. 2001. "Transportation Issue.Eps Files." E-mail from M. Knop (BSC) to L. Hall (Jason Technologies), August 2, 2001. ACC: MOL.20011009.0057.
- 104783 Kohles 1998 Kohles, D.S. 1998. Accident Rate for the State of Nebraska for Interstate Truck Carriers was 2.36E-7 Accidents per Truck-Km for the Year 1997. Letter from D.S. Kohles (State of Nebraska) to J. Booth and R. Smith (DOE/YMSCO), July 17, 1998. ACC: MOL.19990610.0296.
- 148083 Luedke 1997 Luedke, D.D. 1997. "Requested Air Traffic Activity Information for Nellis AFB, NV." Memorandum from D. Luedke (USAF) to L. Devine (HQ ACC/CEVP), November 10, 1997. TIC: 244064.
- 101845 Maheras and Phippen 1995 Maheras, S.J. and Phippen, H.K. 1995. *Validation of the Transportation Computer Codes HIGHWAY, INTERLINE, RADTRAN 4, and RISKIND*. DOE/ID-10511. [Idaho Falls], Idaho: U.S. Department of Energy, Idaho Operations Office. TIC: 222831.
- 102172 McClure and Fagan 1998 McClure, J.D. and Fagan, H.F. 1998. *Transportation Accidents/ Incidents Involving Radioactive Materials (1971-1977)*. Albuquerque, New Mexico: Sandia National Laboratories. TIC: 243740.
- 156757 Morissette 2001 Morissette, R. 2001. Commercial Engine Shaft Info E-mail from R. Morissette (BSC) to P. Davis (Jason Technologies), October 23, 2001. ACC: MOL.20011029.0021.
- 153066 Murphy 2000 Murphy, S.L. 2000. Deaths: Final Data for 1998. *National Vital Statistics Reports*. Vol. 48, No. 11. Hyattsville, Maryland: National Center for Health Statistics. TIC: 249111.
- 155551 NASA 1995 NASA (National Aeronautics and Space Administration) 1995. *Final Environmental Impact Statement for the Cassini Mission*. Washington, D.C.: National Aeronautics and Space Administration. ACC: MOL.20010802.0223.
- 155550 NASA 1997 NASA (National Aeronautics and Space Administration) 1997. *Final Supplemental Environmental Impact Statement for the Cassini Mission*. Washington, D.C.: National Aeronautics and Space Administration. ACC: MOL.20010802.0218.
- 103405 NDOT 1997 NDOT (Nevada Department of Transportation) 1997. *The Annual Traffic Report*. Carson City, Nevada: Nevada Department of Transportation. TIC: 242973.
- 156930 NDOT 2001 NDOT (Nevada Department of Transportation) 2001.
- 150898 Neuhauser and Kanipe 2000 Neuhauser, K.S. and Kanipe, F.L. 2000. *RADTRAN 5, User Guide*. SAND2000-1257. Albuquerque, New Mexico: Sandia National Laboratories. TIC: 249356.

- | | | |
|--------|---------------------------------------|---|
| 155430 | Neuhauser, Kanipe,
and Weiner 2000 | Neuhauser, K.S.; Kanipe, F.L.; and Weiner, R.F. 2000. <i>RADTRAN 5, Technical Manual</i> . SAND2000-1256. Albuquerque, New Mexico: Sandia National Laboratories. TIC: 249356. |
| 101892 | NRC 1977 | NRC (U.S. Nuclear Regulatory Commission) 1977. <i>Final Environmental Impact Statement on the Transportation of Radioactive Materials by Air and Other Modes</i> . NUREG-0170. Two volumes. Washington, D.C.: U.S. Nuclear Regulatory Commission. TIC: 221616. |
| 104784 | Ostmeyer 1986 | Ostmeyer, R.M. 1986. <i>A Revised Rail-Stop Exposure Model for Incident-Free Transport of Nuclear Waste</i> . SAND85-2149. Albuquerque, New Mexico: Sandia National Laboratories. ACC: HQZ.19870615.6381. |
| 103449 | PGE 1996 | PGE (Portland General Electric) 1996. <i>Trojan Independent Spent Fuel Storage Installation, Safety Analysis Report</i> . PGE-1069. Portland, Oregon: Portland General Electric. TIC: 243815. |
| 155825 | Poston 2001 | Poston, T. M. 2001. Screening and Reconnaissance-Level Methods Used to Assess Potential Noise and Ground Vibration Impacts Associated with the Construction and Operation of a Waste Repository at Yucca Mountain, Nevada. Richland, Washington: Battelle Pacific Northwest Division. ACC: MOL.20011009.0019. |
| 156754 | Rascovar 2001 | Rascovar, B. 2001. "Region Needs Rail Lines." Baltimore, Maryland: The Baltimore Sun.
http://www.sunspot.net/tunnelfire/sunspot_net - archive9.htm |
| 154814 | Sandquist et al. 1985 | Sandquist, G.M.; Rogers, V.C.; Sutherland, A.A.; and Merrell, G.B. 1985. <i>Exposures and Health Effects from Spent Fuel Transportation</i> . RAE-8339/12-1. Salt Lake City, Utah: Rogers and Associates Engineering. TIC: 200593. |
| 101920 | Saricks and
Kvitek 1994 | Saricks, C.L. and Kvitek, T. 1994. <i>Longitudinal Review of State-Level Accident Statistics for Carriers of Interstate Freight</i> . ANL/ESD/TM-68. Argonne, Illinois: Argonne National Laboratory. TIC: 236747. |
| 103455 | Saricks and
Tompkins 1999 | Saricks, C.L. and Tompkins, M.M. 1999. <i>State-Level Accident Rates of Surface Freight Transportation: A Reexamination</i> . ANL/ESD/TM-150. Argonne, Illinois: Argonne National Laboratory. TIC: 243751. |
| 103725 | SCDPS 1997 | SCDPS (South Carolina Department of Public Safety) 1997. <i>1996 South Carolina Traffic Collision Fact Book</i> . Columbia, South Carolina: South Carolina Department of Public Safety. TIC: 243552. |
| 101747 | Schneider et al. 1987 | Schneider, K.J.; Ross, W.A.; Smith, R.I.; Daling, P.M.; Grinde, R.B.; Hostick, C.J.; Peterson, R.W.; Stiles, D.L.; Weakley, S.A.; and Young, J.R. 1987. <i>Analysis of Radiation Doses from Operation of Postulated Commercial Spent Fuel Transportation Systems</i> . DOE-CH/TPO-001. Chicago, Illinois: U.S. Department of Energy Chicago Operations Office. TIC: 208877. |

- 152476 Sprung et al. 2000 Sprung, J.L.; Ammerman, D.J.; Breivik, N.L.; Dukart, R.J.; Kanipe, F.L.; Koski, J.A.; Mills, G.S.; Neuhauser, K.S.; Radloff, H.D.; Weiner, R.F.; and Yoshimura, H.R. 2000. *Reexamination of Spent Fuel Shipment Risk Estimates*. NUREG/CR-6672. Two volumes. Washington, D.C.: U.S. Nuclear Regulatory Commission. ACC: MOL.2001010.0217.
- 153967 Steinman and Kearfott 2000 Steinman, R.L. and Kearfott, K.J. 2000. "A Comparison of the RADTRAN 5 and RISKIND 1.11 Incident-Free Dose Models." *Waste Management 2000. HLW, LLW, Mixed Wastes and Environmental Restoration — Working Towards a Cleaner Environment, Proceedings of the Symposium on Waste Management, Tucson, Arizona, February 27 - March 2, 2000*. Tucson, Arizona: WM Symposia. TIC: 249684.
- 103472 USAF 1999 USAF (U.S. Air Force) 1999. *Renewal of the Nellis Air Force Range Land Withdrawal: Legislative Environmental Impact Statement*. Washington, D.C.: U.S. Department of the Air Force. TIC: 243264.
- 156760 Westcamp 2001 Westcamp, M. 2001. Potential Rail Files Email from M. Westcamp (BSC) to L. Hall (Jason Technologies) dated November 3, 2001.
- 156761 Westcamp 2001 Westcamp, M. 2001. Heavy Haul Email from M. Westcamp (BSC) to L. Hall (Jason Technologies) dated November 3, 2001.
- 104801 Wort 1998 Wort, L.F. 1998. "Request for Crash Statistics Interstate Motor Carriers." Letter from L.F. Wort (Illinois DOT) to K.J. Skipper (DOE/YMSCO), June 2, 1998, with enclosure. ACC: MOL.19990511.0390.
- 104737 YMP 1997 YMP (Yucca Mountain Site Characterization Project) 1997. *Location of Alternative Heavy-Haul Routes and Future Las Vegas Beltway*. YMP-97-262.0. Las Vegas, Nevada: Yucca Mountain Site Characterization Office. ACC: MOL.19990610.0306.
- 104743 YMP 1998 YMP (Yucca Mountain Site Characterization Project) 1998. *Nevada Routes for Legal-Weight Truck Shipments of SNF and HLW to Yucca Mountain*. YMP/97-310.3. Las Vegas, Nevada: Yucca Mountain Site Characterization Office. ACC: MOL.19990526.0033.
- 104560 YMP 1998 YMP (Yucca Mountain Site Characterization Project) 1998. *Potential Rail Alignments*. YMP/98-104.0. Las Vegas, Nevada: Yucca Mountain Site Characterization Office. ACC: MOL.19990526.0034.
- 104792 YMP 1990 YMP (Yucca Mountain Site Characterization Project) 1990. *Preliminary Rail Access Study*. YMP/89-16. Las Vegas, Nevada: Yucca Mountain Site Characterization Office. ACC: MOL.19980817.0094.
- 104735 YMP 1991 YMP (Yucca Mountain Site Characterization Project) 1991. *The Nevada Railroad System: Physical, Operational and Accident Characteristics*. YMP 91-19. Las Vegas, Nevada: Yucca Mountain Site Characterization Office. ACC: NNA.19920608.0151.

101483 Yuan et al. 1995

Yuan, Y.C.; Chen, S.Y.; Biwer, B.M.; and LePoire, D.J. 1995. *RISKIND –A Computer Program for Calculating Radiological Consequences and Health Risks from Transportation of Spent Nuclear Fuel*. ANL/EAD-1. Argonne, Illinois: Argonne National Laboratory. TIC: 241380.