



5

Environmental Consequences of Long-Term Repository Performance

TABLE OF CONTENTS

<u>Section</u>	<u>Page</u>
5. Environmental Consequences of Long-Term Repository Performance	5-1
5.1 Inventory for Performance Calculations	5-3
5.1.1 Inventory of Radioactive Materials	5-3
5.1.2 Inventory of Chemically Toxic Material	5-7
5.2 System Overview	5-7
5.2.1 Components of the Natural System	5-8
5.2.2 Components of the Waste Package and Drip Shield	5-9
5.2.3 Visualization of the Repository System for Analysis of Long-Term Performance	5-9
5.2.4 Uncertainty	5-11
5.2.4.1 Uncertainty Associated with Societal Changes, Climate, and Other Long-Term Phenomena	5-12
5.2.4.2 Uncertainty Associated with Currently Unavailable Data	5-12
5.2.4.3 Uncertainty Associated with Models and Model Parameters	5-13
5.2.4.3.1 Variability Versus Uncertainty	5-13
5.2.4.3.2 Weighting of Alternative Conceptual Models	5-14
5.2.4.3.3 Uncertainty and the Proposed Action	5-15
5.2.4.3.4 Uncertainty and Sensitivity	5-15
5.2.4.3.5 Uncertainty Analysis for the TSPA-Site Recommendation	5-16
5.2.4.3.6 Key Parameters and Uncertainty	5-18
5.3 Locations for Impact Estimates	5-20
5.4 Waterborne Radiological Consequences	5-22
5.4.1 Extension of Groundwater Impacts to Other Distances	5-23
5.4.2 Waterborne Radiological Results	5-23
5.4.2.1 Waterborne Radiological Results for the Higher-Temperature Repository Operating Mode	5-23
5.4.2.2 Waterborne Radiological Results for the Lower-Temperature Repository Operating Mode	5-27
5.4.2.3 Alternative Dosimetry Methods	5-31
5.5 Atmospheric Radiological Consequences	5-31
5.5.1 Source Term	5-31
5.5.2 Atmospheric Consequences to the Local Population	5-31
5.5.3 Atmospheric Consequences to an Individual	5-32
5.6 Consequences from Chemically Toxic Materials	5-32
5.7 Consequences from Disruptive Events	5-34
5.7.1 Human Intrusion Scenario	5-34
5.7.2 Igneous Activity Scenario	5-35
5.7.2.1 Volcanic Eruption Events	5-35
5.7.2.2 Groundwater Transport of Radionuclides Following Igneous Intrusion Event	5-36
5.7.2.3 Results for Igneous Activity Scenario	5-36

<u>Section</u>	<u>Page</u>
5.8 Nuclear Criticality	5-38
5.8.1 Probability of Internal Criticality for Commercial Spent Nuclear Fuel	5-38
5.8.2 Probability of Internal Criticality for Codisposed DOE Spent Nuclear Fuel and High-level Radioactive Waste	5-39
5.8.3 Probability of Criticality for the Immobilized Plutonium Waste Form	5-39
5.8.4 Probability of External Criticality	5-39
5.8.5 Effect of a Steady-state Criticality on Radionuclide Inventory	5-40
5.8.6 Transient Criticality Consequences	5-40
5.8.7 Autocatalytic Criticality	5-40
5.8.8 Disruptive Natural Events Influencing Criticality	5-40
5.9 Consequences to Biological Resources and Soils	5-41
5.10 Summary	5-43
References	5-45

LIST OF TABLES

<u>Table</u>	<u>Page</u>
5-1 Changes to the TSPA model since publication of the Draft EIS	5-4
5-2 Abstracted inventory of radionuclides passing the screening analysis in each idealized waste package	5-6
5-3 Cross-reference to key assumptions and associated attributes in the TSPA model	5-11
5-4 Analysis of unquantified uncertainties and resulting TSPA model modifications	5-17
5-5 Top-ranking uncertainty importance parameters	5-19
5-6 Impacts for an individual from groundwater releases of radionuclides during 10,000 years after repository closure for the higher-temperature repository operating mode	5-24
5-7 Population impacts from groundwater releases of radionuclides during 10,000 years after repository closure for the higher-temperature repository operating mode	5-25
5-8 Impacts for an individual from groundwater releases of radionuclides during 1 million years after repository closure for the higher-temperature repository operating mode	5-26
5-9 Comparison of nominal scenario long-term consequences at the RMEI location to groundwater protection standards during 10,000 years following repository closure for the higher-temperature repository operating mode	5-27
5-10 Impacts for an individual from groundwater releases of radionuclides during 10,000 years after repository closure for the lower-temperature repository operating mode	5-28
5-11 Population impacts from groundwater releases of radionuclides during 10,000 years after repository closure for the lower-temperature repository operating mode	5-28
5-12 Impacts for an individual from groundwater releases of radionuclides during 1 million years after repository closure for the lower-temperature repository operating mode	5-29
5-13 Comparison of nominal scenario long-term consequences at the RMEI location to groundwater protection standards during 10,000 years following repository closure for the lower-temperature repository operating mode	5-30
5-14 Consequences from waterborne chemically toxic materials release during 10,000 years after repository closure estimated using a bounding calculation	5-33
5-15 Predicted temperature changes of near-surface soils under the high thermal load scenario	5-41

<u>Table</u>		<u>Page</u>
5-16	Individual impacts from groundwater releases of radionuclides during 10,000 years after repository closure for the Proposed Action	5-43
5-17	Population impacts from groundwater releases of radionuclides during 10,000 years after repository closure for the Proposed Action	5-43

LIST OF FIGURES

<u>Figure</u>		<u>Page</u>
5-1	Relationship between the published TSPA models and models used for both the Draft EIS and this Final EIS	5-3
5-2	Components of the natural system	5-8
5-3	Map of the saturated groundwater flow system	5-21
5-4	Mean and 95th-percentile annual individual dose at the RMEI location during 1 million years after repository closure for the nominal scenario under the higher-temperature repository operating mode	5-26
5-5	Mean and 95th-percentile annual individual dose at the RMEI location during 1 million years after repository closure for the nominal scenario under the lower-temperature repository operating mode	5-30
5-6	Mean and 95th-percentile annual individual dose at the RMEI location resulting from human intrusion 30,000 years after repository closure under the higher-temperature repository operating mode	5-35
5-7	Mean annual individual dose at the RMEI location resulting from igneous disruptions under the higher-temperature repository operating mode, with the mean dose history at this location for the higher-temperature operating mode nominal scenario	5-38

5. ENVIRONMENTAL CONSEQUENCES OF LONG-TERM REPOSITORY PERFORMANCE

This chapter describes potential human health impacts from radioactive and nonradioactive materials released to the environment during the first 10,000 years after closure of a repository at Yucca Mountain. The impact calculations assumed that the population in the Yucca Mountain region would remain constant at the number of people projected to live in the region in 2035, as discussed in Chapter 3, Section 3.1.7.1. This chapter also estimates the peak radiation dose during the first 1 million years after closure. Closure of a repository would include the following events, which are analyzed in Chapter 4:

- Sealing of the underground emplacement drifts
- Backfilling and sealing of other underground openings
- Removal of the surface facilities
- Creation of institutional controls, including land records and surface monuments, to identify the location of the repository and discourage human intrusion

In addition, this chapter discusses estimates of potential biological impacts from radiological and chemical groundwater contamination and potential environmental impacts of such contamination and potential biological impacts from the long-term production of heat due to decay of the radioactive materials that would be disposed of in a repository at Yucca Mountain; and potential environmental justice impacts. Other than human impacts, these would be the only potential long-term impacts. There would be no repository activities; no changes in land use, employment of workers, water use or water quality other than from the transport of radionuclides; and no use of energy or other resources, or generation or handling of waste after closure of a repository. Therefore, analysis of impacts to land use, noise, socioeconomic, cultural resources, surface-water resources, aesthetics, utilities, or services after closure is not required. As part of closure activities, the U.S. Department of Energy (DOE, or the Department) would return the land to its original contour and erect appropriate monuments marking the repository, which would result in some minor impacts on aesthetics depending on the exact design of the monuments (currently undetermined). Impacts from closure are discussed in Chapter 4. After the completion of closure, risk of sabotage or intruder access would be highly unlikely. Chapter 4 (Section 4.1.8.3) discusses the potential for sabotage prior to closure. Section 5.7.1 discusses potential impacts from an intruder after closure.

DOE performed the analysis of potential impacts after repository closure for two operating modes—higher-temperature and lower-temperature. For analysis purposes, the same fundamental repository design was used in both modes, but the heat output per unit area of the repository was varied by changing waste package spacing and other operational parameters (see Section 2.1.1.2 in Chapter 2 for details).

The analysis for this EIS considered the following three transport pathways through which spent nuclear fuel, high-level radioactive waste, and hazardous or *carcinogenic* chemicals could reach human populations and cause health consequences:

- Groundwater
- Surface water
- Atmosphere

The principal *exposure pathway*, groundwater, would result from rainwater migrating down through the unsaturated zone into the repository, dissolving some of the material in the repository, and carrying

contaminants from the dissolved material downward through the unsaturated zone and on through the groundwater system to locations where human exposure could occur. A surface-water pathway could occur if groundwater reached the surface at a discharge location, so the analysis for this Final EIS considered surface-water consequences along with groundwater consequences. An airborne pathway could result because spent nuclear fuel contains some radionuclides in gaseous form. For example, carbon-14 could migrate to the surface in the form of carbon dioxide gas and mix in the atmosphere.

The analysis for this EIS estimated potential human health impacts from the groundwater transport pathway at three locations in the Yucca Mountain groundwater hydrology region of influence:

- Water wells at the *reasonably maximally exposed individual* (RMEI) location [For this EIS, DOE determined that the RMEI location would be at the southern-most point of the controlled area, as specified in 40 CFR Part 197 (36 degrees, 40 minutes, 13.6661 seconds north latitude). Groundwater modeling indicates that the point at which the predominant groundwater flow crosses the boundary would be about 18 kilometers (11 miles) downgradient from the potential repository. This EIS refers to this location as the “RMEI location.”]
- 30 kilometers (19 miles) downgradient from the potential repository.
- The nearest surface-water discharge point, which is about 60 kilometers (37 miles) downgradient from the potential repository.

These consequences are presented in terms of radiological dose and the probability of a resulting latent cancer fatality. A latent cancer fatality is a death resulting from cancer caused by exposure to ionizing radiation or other carcinogens.

DOE assessed the processes by which waste could be released from a repository at Yucca Mountain and transported to the environment. The analysis used computer programs developed to assess the release and movement of radionuclides and hazardous materials in the environment. Some of the programs analyzed the behavior of engineered components such as the waste package, while others analyzed natural processes such as the movement of groundwater. The programs are based on the best available geologic, topographic, and hydrologic data and current knowledge of the behavior of the materials proposed for the system. The analysis used data from the Yucca Mountain site characterization activities, material tests, and expert opinions as input parameters to estimate human health consequences. Many parameters used in the analysis cannot be exactly measured or known; only a range of values can be known. The analysis accounted for this type of uncertainty; thus, the results are ranges of potential health consequences.

WASTE PACKAGE

A *waste package* consists of the waste form and any containers (disposal container, barriers, and other canisters), spacing structure or baskets, shielding integral to the container, packing in the container, and other absorbent materials immediately surrounding an individual disposal container, placed inside the container, or attached to its outer surface. The waste package begins its existence when the outer lid welds are complete and accepted and the welded unit is ready for emplacement in the repository.

The analysis for this Final EIS considered human health impacts during the first 10,000 years after repository closure and the peak dose during the first 1 million years after repository closure. Estimates of potential human health impacts from the *nominal scenario* (undisturbed by volcanic activity or human intrusion) included the effects of such expected processes as corrosion of waste packages, dissolution of waste forms, flow through the saturated and unsaturated zone, seismic events, and changing climate. Additional analyses examined the effects of exploratory drilling, criticality, and volcanic events.

A number of changes have occurred since the issuance of the Draft EIS. Several changes have been made to the repository and waste package designs and many changes have been made to the models used to analyze long-term repository performance. Key design changes important to the long-term performance include changes to the waste package design, changes to how thermal loading of the repository is implemented, and addition of titanium drip shields over the waste packages. Chapter 2, Section 2.1.2; Chapter 4, Section 4.1; Section 5.2; and Appendix I, Section I.2, and the supporting documents referenced therein contain more details on the design changes. In addition, many improvements have been made to the analysis models. These improvements have enhanced the sensitivity of the models to more processes and effects and have refined treatment of uncertainties in some areas. Table 5-1 summarizes the changes. The changes identified in the column titled “S&ER Reference” were addressed in the Supplement to the Draft EIS. The other changes identified in Table 5-1 are addressed in this Final EIS. Further details can also be found in the references cited in Table 5-1 and in Appendix I, Section I.2. The relationship between published Total System Performance Assessment (TSPA) models and both the Draft EIS and this Final EIS are provided in Figure 5-1.

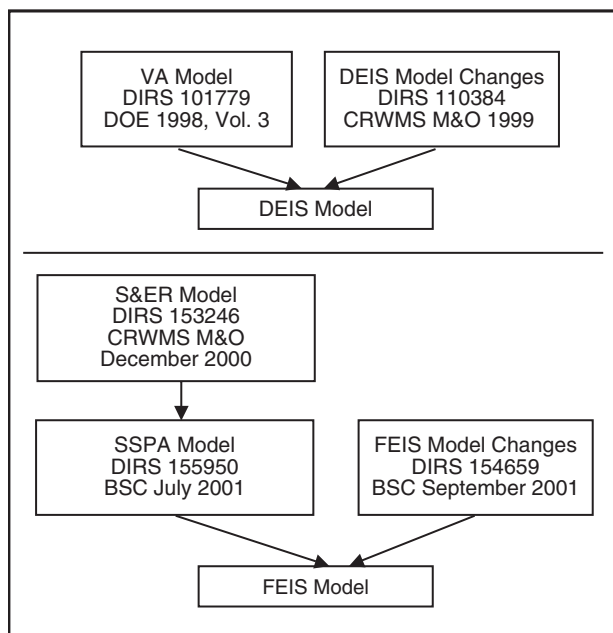

Figure 5-1. Relationship between the published TSPA models and models used for both the Draft EIS and this Final EIS.

5.1 Inventory for Performance Calculations

DOE proposes to dispose of approximately 11,000 to 17,000 waste packages containing as much as 70,000 MTHM of spent nuclear fuel and high-level radioactive waste in a repository at Yucca Mountain. There are several different types of disposal containers for commercial spent nuclear fuel and different container designs for DOE spent nuclear fuel and high-level radioactive waste. The exact number of waste packages would depend on various options in the proposed design. This long-term consequence analysis identified the inventory by the source category of waste material to be disposed of (commercial spent nuclear fuel, DOE spent nuclear fuel, weapons-usable plutonium, and high-level radioactive waste). For purposes of modeling, the inventory for each of the categories was averaged into an appropriate number of packages, each with identical contents. The average of the modeled inventories resulted in a total of nearly 12,000 idealized waste packages (slightly higher than the actual number of waste packages that would be emplaced) in two basic types.

Note that while the simulations were based on the nearly 12,000 packages, there would be no difference in the result if the smaller packages had been used (17,000 package case). This is because the use of smaller packages is merely a way of implementing the lower-temperature operating mode and would contain the same proposed inventory.

5.1.1 INVENTORY OF RADIOACTIVE MATERIALS

There are more than 200 radionuclides in the waste inventory (see Appendix A). The analysis for this Final EIS used a reduced number of radionuclides (26; see Appendix I, Section I.3).

Table 5-1. Changes to the TSPA model since publication of the Draft EIS (page 1 of 2).

Submodel	Change	Estimated effect	S&ER reference ^a	SSPA reference ^b	Model for this Final EIS ^c
Inventory	New inventory abstraction	Neutral	4.2.6.4.1		5.2
	U.S. Navy spent nuclear fuel modeled as commercial spent nuclear fuel rather than as DOE-owned spent nuclear fuel	Neutral			
Unsaturated zone flow	Updated climate model	Neutral	4.2.1.1.1		5.2
	Added interaction of moisture in fractures and rock matrix	Possible reduction in dose	4.2.1.1.4		
	Added perched water models	Neutral	4.2.1.3.1.2		
	Flow through unsaturated zone and, therefore, seepage varies with time	More climate sensitivity, possible increase in dose	4.2.1.3.6		
	Flow-focusing within heterogeneous permeability field; episodic seepage	Possible increase in dose		4.3.1, 4.3.2, 4.3.5	
	Multiscale thermal-hydrologic model, including effects of rock dryout	Possible increase in dose		5.3.1	
	Thermal property sets	Neutral		5.3.1	
	Thermal effects on seepage	Possible increase in dose		4.3.5	
Waste package and drip shield degradation	Coupling between thermal, hydrologic, and chemical effects	Possible increase in dose	4.2.2.1.2		5.2
	Changes to model new package design and addition of drip shield model	Decrease in dose up to 10,000 years	4.2.4.3		
	Improved early package failure model	Decrease in dose up to 10,000 years		7.3.2	
	Experimental corrosion data replacing expert judgment	Decrease in dose up to 10,000 years, increase in peak dose after 10,000 years	4.2.4.3.2		
Waste form degradation	General corrosion rate independent of temperature	Increase in dose			5.2
	Updated cladding degradation model to include mechanical failures and localized corrosion	Increase in dose	4.2.6.3.3		
	Add comprehensive model of colloid formation effects on radionuclide mobilization	Increase in dose	4.2.6.3.8		
	Increased number of radionuclides modeled from 9 to 21	Increase in dose	4.4.1.4		
	Neptunium solubility model incorporating secondary phases	Decrease in dose after 10,000 years	4.2.6.3.7		
Engineered barrier system transport	New comprehensive model for transport of radionuclides from colloid effects	Increase in dose	4.2.7.4.2		5.2
Unsaturated zone transport	New comprehensive model for transport of radionuclides from colloid effects	Increase in dose	4.2.8.4.3		
	Model updated to include radiation connections in the thermal-hydrologic submodel for the lower-temperature operating mode	Neutral			
	Effect of drift shadow zone-advection/ diffusion splitting	Decrease in dose		11.3.1	

Table 5-1. Changes to the TSPA model since publication of the Draft EIS (page 2 of 2).

Submodel	Change	Estimated effect	S&ER reference ^a	SSPA reference ^b	Model for this Final EIS ^c
Saturated zone flow and transport	Colloid-facilitated transport in two modes: as an irreversible attachment of radionuclides to colloids, originating from waste, and as an equilibrium attachment of radionuclides to colloids	Increase in dose	4.2.9.4		
	Three-dimensional transport model	Neutral	4.2.9.4		
	Plume capture method for well concentrations (total radionuclides dissolved in water usage)	Possible decrease in dose	4.2.9.4		
	Change in length of saturated zone from 20 kilometers (12 miles) downgradient from the potential repository for MEI ^d in Draft EIS to RMEI ^e location determined by DOE to be approximately 18 kilometers, or 11 miles, downgradient from the potential repository	Possible increase in dose			5.2
Biosphere	Change in basis for biosphere dose conversion factors from MEI in the Draft EIS to the average member of the critical group defined in draft 10 CFR Part 63	Neutral	4.2.10.1		
	Change in basis for biosphere dose conversion factors from the average member of the critical group (10 CFR Part 63) in the S&ER and SSPA to the RMEI defined in EPA regulation 40 CFR Part 197	Slight decrease			5.2
	Consideration of groundwater protection standards	New impact measure	4.4.2		
	Change in water volume used for evaluation of groundwater protection standards from sampled model dilution volume to the representative volume (3,000 acre-feet per year) defined in EPA regulation 40 CFR Part 197	Decrease in new impact measure			5.2

- a. Section numbers in the *Yucca Mountain Science and Engineering Report: Technical Information Supporting Site Recommendation Consideration* (DIRS 153849-DOE 2001, all).
- b. Section numbers in the *SSPA-Supplemental Science and Performance Analysis* (DIRS 155950-BSC 2001, all).
- c. Section numbers in DIRS 157307-BSC (2001, Enclosure 1).
- d. MEI = maximally exposed individual.
- e. RMEI = reasonably maximally exposed individual.

The number of radionuclides to be analyzed was determined by a screening analysis. The screening analysis identified those radionuclides that would collectively contribute at least 95 percent of the dose to a person living in the vicinity of Yucca Mountain. The list of radionuclides resulting from the screening process forms the basis for the analyses discussed in this chapter. Appendix I, Section I.3, contains more details of this screening analysis.

The total inventory was abstracted into two types of idealized waste packages: a codisposal package with high-level radioactive waste in a glass matrix and DOE spent nuclear fuel, and a commercial spent nuclear fuel package. Table 5-2 lists the abstracted inventory for the idealized waste packages. For

IDEALIZED WASTE PACKAGES

The number of waste packages used in the performance assessment simulations do not exactly match the number of actual waste packages projected for the Proposed Action.

The TSPA model uses two types of *idealized waste packages* (commercial spent nuclear fuel package and codisposal package), representing the averaged inventory of all the actual waste packages used for a particular waste category.

While the number of idealized waste packages varies from the number of actual waste packages, the total radionuclide inventory represented by all of the idealized waste packages collectively is representative of the total inventory, for the radionuclides analyzed, given in Appendix A of this EIS for the purposes of analysis of long-term performance. The abstracted inventory is designed to be representative for purposes of analysis of long-term performance and cannot necessarily be used for any other analysis, nor can it be directly compared to any other abstracted inventory used for other analyses in this EIS.

Table 5-2. Abstracted inventory (grams) of radionuclides passing the screening analysis in each idealized waste package.^{a,b}

Nuclide	Commercial spent nuclear fuel	Codisposal waste packages ^d	
	waste packages ^c	DOE spent nuclear fuel	High-level radioactive waste
Actinium-227	0.00000309	0.000113	0.000467
Americium-241	10,900	117	65.7
Americium-243	1,290	1.49	0.399
Carbon-14	1.37	0.0496	0.00643
Cesium-137	5,340	112	451
Iodine-129	1,800	25.1	48
Neptunium-237	4,740	47.9	72.3
Protactinium-231	0.00987	0.325	0.796
Lead-210	0	0.000000014	0.000000114
Plutonium-238	1,510	6.33	93.3
Plutonium-239	43,800	2,300	3,890
Plutonium-240	20,900	489	381
Plutonium-242	5,410	11.1	7.77
Radium-226	0	0.00000187	0.0000167
Radium-228	0	0.00000698	0.00000319
Strontium-90	2,240	55.4	288
Technetium-99	7,680	115	729
Thorium-229	0	0.0266	0.00408
Thorium-230	0.184	0.0106	0.00782
Thorium-232	0	14,900	7,310
Uranium-232	0.0101	0.147	0.000823
Uranium-233	0.07	214	11.1
Uranium-234	1,830	57.2	47.2
Uranium-235	62,800	8,310	1,700
Uranium-236	39,200	853	39.8
Uranium-238	7,920,000	509,000	261,000

a. Source: DIRS 154841-BSC (2001, Table 36, p. 38).

b. The idealized waste packages in the simulation (model) are based on the inventory abstraction in Appendix I, Section I.3. While the total inventory is represented by the material in the idealized waste packages, the actual number of waste packages emplaced in the potential repository would be different.

c. There are 7,860 idealized commercial spent nuclear fuel waste packages.

d. There are 3,910 idealized codisposal waste packages.

analysis purposes, naval spent nuclear fuel is conservatively modeled as commercial spent nuclear fuel (DIRS 152059-BSC 2001, all; DIRS 153849-DOE 2001, Section 4.2.6.3.9, p. 4-257).

5.1.2 INVENTORY OF CHEMICALLY TOXIC MATERIAL

DOE is not proposing to dispose of chemically toxic waste in the potential repository. However, the degradation of engineered materials that would be used in repository construction and engineered barrier systems would result in corrosion products that contain chemically toxic materials.

A screening analysis reported in Appendix I (Section I.6.1) showed that the only chemical materials of concern for the 10,000-year analysis period were those released as the external wall of the waste package and the waste package support pallet materials corroded. The chemicals of concern would be chromium, nickel, molybdenum, and vanadium. The exposed surface areas that would corrode include Alloy-22 surfaces (drip shield rails, outer layer of waste packages, and portions of the emplacement pallets) and stainless steel 316NG surfaces (portions of the emplacement pallets).

The total quantities of materials would be 86,000,000 kilograms (190,000,000 pounds) of Alloy-22 (DIRS 150558-CRWMS M&O 2000, p. 6-6) containing 22.5 percent chromium, 14.5 percent molybdenum, 57.2 percent nickel, 0.35 percent vanadium (DIRS 104328-ASTM 1998, all) and 140,000,000 kilograms (310,000,000 pounds) of stainless steel, (DIRS 150558-CRWMS M&O 2000, p. 6-6) which is 17 percent chromium, 12 percent nickel and 2.5 percent molybdenum. A large percentage of the stainless steel would be inside the waste package (as an inner sleeve) and, therefore, much of this material would not be exposed until the Alloy-22 had corroded away.

5.2 System Overview

Radioactive materials in the repository would be placed at least 200 meters (660 feet) beneath the surface (DIRS 154554-BSC 2001, pp. 28-29). In physical form, the emplaced materials would be almost entirely in the form of solids with a very small fraction of the total radioactive inventory in the form of trapped gases (see Section 5.5). With the exception of a small amount of radioactive gas in the fuel rods, the primary means for the radioactive and chemically toxic materials to contact the *biosphere* would be along groundwater pathways. The materials could pose a threat to humans if the following sequence of events occurred:

- The waste packages and their contents were exposed to water
- Radionuclides or chemically toxic materials in the package materials or wastes became dissolved or mobilized in the water
- The radionuclides or chemically toxic materials were transported in water to an aquifer, and the water carrying radionuclides or chemically toxic materials was withdrawn from the aquifer through a well or at a surface-water discharge point and used directly by humans for drinking or in the human food chain (such as through irrigation or watering livestock).

Thus, the access to, and flow of, contaminated water are the most important considerations in determining potential health hazards.

5.2.1 COMPONENTS OF THE NATURAL SYSTEM

Figure 5-2 is a simplified schematic of a repository at Yucca Mountain. It shows the principal features of the natural system that could affect the long-term performance of the repository. Yucca Mountain is in a semiarid desert environment where the current average annual precipitation over the unsaturated zone flow and transport model area is 170 millimeters (7 inches), varying by specific location (DIRS 153849-DOE 2001, p. 4-38). The water table is an average of about 600 meters (2,000 feet) below the surface of the mountain. The proposed repository would be in unsaturated rock approximately midway between the desert environment and the water table.

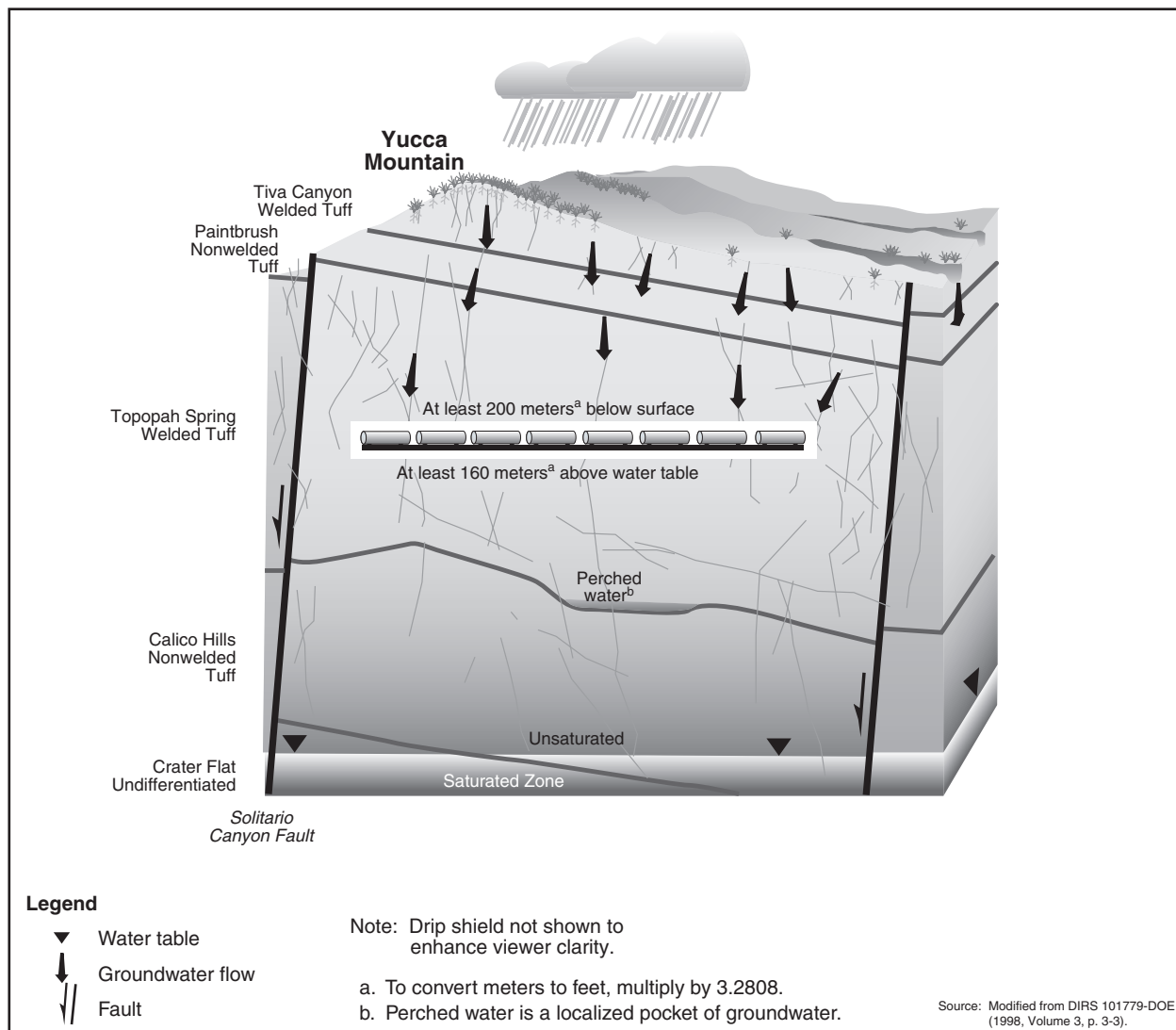

Figure 5-2. Components of the natural system.

The water table is the boundary between the unsaturated zone above and the saturated zone below. In the subsurface region above the water table, the rock contains water but the water does not fill all the open spaces in the rock. Because the open spaces are only partially filled, this region is called the unsaturated zone. Water in the unsaturated zone tends to move generally downward in response to capillary action and gravity. In contrast, water fills all the open spaces in the rock below the water table, so this region is called the saturated zone. Water in the saturated zone tends to flow laterally from higher to lower

pressures. Both zones contain several different rock types, as shown in Figure 5-2. The layers of major rock types in the unsaturated zone at the Yucca Mountain site are the Tiva Canyon welded, Paintbrush nonwelded, Topopah Spring welded, Calico Hills nonwelded, and Crater Flat undifferentiated tuffs. Figure 5-2 shows two of the faults at the proposed site—the Ghost Dance fault that occurs within the repository block and the Solitario Canyon Fault that forms the western boundary of the repository block. Faults are slip zones where rock units have become displaced either vertically, laterally, or diagonally, resulting in the rock layers being discontinuous. These slip zones tend to form a thin plane in which there is more open space that acts as a channel for water. Some faults tend to fill with broken rock formed as they slip, so they take on a very different flow property from that of the surrounding rock. The proposed repository would be in the Topopah Spring welded tuff in the unsaturated zone, at least 200 meters (660 feet) below the surface and at least 160 meters (530 feet) above the water table (DIRS 154554-BSC 2001, pp. 28-29).

HYDROGEOLOGIC TERMS

Saturated zone: The area below the water table where all spaces (fractures and rock pores) are completely filled with water.

Unsaturated zone: The area between the surface and the water table where only some of the spaces (fractures and rock pores) are filled with water.

Matrix: The solid, but porous, portion of the rock.

When it rains in the Yucca Mountain vicinity, most of the water runs off and a very limited amount infiltrates the rock on the surface of the mountain. Some of the water that remains on the surface or infiltrates the rock evaporates back into the atmosphere (directly or through plant uptake and evapotranspiration). The very small amount of water that infiltrates the rock and does not evaporate percolates down through the mountain to the saturated zone (DIRS 155950-BSC 2001, Section 3.3.2.1, p. 3-17). Water that flowed through the unsaturated zone into the proposed repository could dissolve some of the waste material, if there was a breach in the package containment, and could carry it through the groundwater system to the accessible environment, where exposure to humans could occur.

5.2.2 COMPONENTS OF THE WASTE PACKAGE AND DRIP SHIELD

The waste package would consist of two concentric cylindrical containers sealed with welded lids in which DOE would place the waste forms. The inner cylinder would be stainless steel (316NG). The outer cylinder would be a corrosion-resistant nickel-based alloy (Alloy-22). Alloy-22 would protect the underlying structural material (stainless steel) from corrosion, while the structural material would support the thinner, corrosion-resistant material. The current design calls for emplacement of a titanium drip shield over the waste packages just prior to repository closure. With the drip shield in place, the Alloy-22 outer cylinder would be the second corrosion barrier protecting the waste from contact with water. The use of two distinctly different corrosion-resistant materials would reduce the probability that a single environmental condition could cause the failure of both materials. Before the double-walled waste package was sealed, helium would be added as a fill gas. The helium would prevent corrosion of the waste form and help transfer heat from the waste form itself to the inner wall of the waste package. Moving heat away from the waste form would be one important means of controlling waste form temperatures. This would help preserve the integrity of the metal cladding on the fuel rods, thus extending the life of an already-existing barrier that protects the waste from water.

5.2.3 VISUALIZATION OF THE REPOSITORY SYSTEM FOR ANALYSIS OF LONG-TERM PERFORMANCE

In general, the repository system was modeled as a series of processes linked together, one after the other, spatially from top to bottom in the mountain. From a computer-modeling standpoint, it is important to

break the system into smaller portions that relate to the way information is collected. In reality, an operating repository system would be completely interconnected, and virtually no process would be independent of other processes. However, the complexity of such a system demands some idealization of the system for an analysis to be performed.

The first step in the visualization of the system is the development of a listing of all the possible features, events, and processes that could apply to the behavior of the system. An example of a *feature* is the existence of a fault, an example of an *event* is a seismic event (earthquake), and an example of a *process* is the gradual degradation of the waste package wall by general corrosion. The list is then screened using various types of analyses to determine what features, events, and processes should be included in the modeling. The chosen features, events, and processes are then assembled into scenarios, which are descriptions of how features, events, and processes link together to result in a certain outcome (see Appendix I, Section I.2.1, for further detail).

The elements of the TSPA model are organized into the following categories, which are generally related to various parts of the system:

- Unsaturated zone flow
- Engineered barrier system environments
- Waste package and drip shield degradation
- Waste form degradation
- Engineered barrier transport
- Unsaturated zone transport
- Saturated zone flow and transport
- Biosphere

The individual models associated with these elements are discussed in Appendix I, Sections I.2.2 through I.2.9.

In addition, the following special scenarios are also discussed in Appendix I, Sections I.2.10 through I.2.13:

- Volcanism
- Human intrusion
- Nuclear criticality
- Atmospheric radiological transport

During the development of the TSPA model, DOE often had to make assumptions. The main reason for assumptions was to account for situations where there was limited data. With additional data, it may be possible to present a more “realistic” representation, usually as a statistical distribution. If data are limited, it is necessary to make assumptions and use associated conservative data values. The Nuclear Regulatory Commission and Environmental Protection Agency rulemaking processes acknowledged that uncertainty about physical processes acting over the large space and time scales of interest will remain, even after many years of site characterization. The long-term analysis does not seek an exact prediction but rather seeks to establish a representative projection. The list of assumptions is too large to include here. Table 5-3 is an index to a series of tables that describe in detail the assumptions in the model and associated key attributes. The detailed information is in the Total System Performance Assessment-Site Recommendation document (DIRS 153246-CRWMS M&O 2000, pp. F-2 to F-9).

Table 5-3. Cross-reference to key assumptions and associated attributes in the TSPA model.^a

Category	TSPA-Site Recommendation table ^b
Unsaturated zone flow and transport	F-1
Near-field environment	F-2
Engineered barrier system—chemical environment and radionuclide transport	F-3
Drip shield/waste package	F-4
Inventory component	F-5
In-package chemistry component	F-6
Commercial spent nuclear fuel degradation component	F-7
Defense spent nuclear fuel degradation component	F-8
High-level radioactive waste degradation component	F-9
Dissolved concentration component	F-10
Colloidal concentration component	F-11
Saturated zone flow and transport	F-12
Biosphere	F-13
Disruptive events	F-14

a. Some assumptions were modified in the *Supplemental Science and Performance Analyses* (DIRS 155950-BSC 2001, all). See Table 1-1 of that document for a summary of areas where assumptions were modified or revised.

b. See DIRS 153246-CRWMS M&O (2000, pp. F-2 to F-9).

5.2.4 UNCERTAINTY

As with any impact estimate, there is a level of uncertainty associated with the forecast, especially when estimating impacts over thousands of years. Uncertainty can be defined as the measure of confidence in the forecast related to determining how a system will operate or respond. The amount of uncertainty associated with an impact estimate is a reflection of several factors, including the following four factors:

- An understanding of the components of a system (such as human and societal, hydrogeologic, or engineered) and how those components interact. The greater the number of components, the more complex the system, the lesser the capability to measure or understand how the system or components produce a greater potential for uncertainty. Similarly, fewer studies or more assumptions produce greater potential for uncertainty.
- The time scale over which estimates are made. Longer time scales for forecasts produce greater potential for uncertainty.
- The available computation and modeling tools. More general computation tools or more assumptions produce greater potential for uncertainty.
- The stability and uniformity (or variability) of the components and system being evaluated. Less stability and uniformity (that is, greater variability) produces a greater potential for uncertainty.

DOE recognizes that uncertainties exist from the onset of an analysis; however, forecasts are valuable in the decisionmaking process because they provide insight based on the best information and scientific judgments available. The following section discusses uncertainties in the context of possible effects on the impact estimates reported in this chapter. The discussion is divided to address:

- Uncertainty associated with societal changes and climate
- Uncertainty associated with currently unavailable data
- Uncertainty associated with models and model parameters

5.2.4.1 Uncertainty Associated with Societal Changes, Climate, and Other Long-Term Phenomena

General guidance on predicting the evolution of society has been provided by the National Academy of Sciences. In its report, *Technical Bases for Yucca Mountain Standards* (DIRS 100018-National Research Council 1995, all), the Committee on Technical Bases for Yucca Mountain Standards concluded that there is no scientific basis for predicting future human behavior. The study recommends policy decisions that specify the use of default (or reference) scenarios to incorporate future human behaviors in compliance assessment calculations. The analysis in this chapter generally follows the recommended approach, using as defaults societal conditions as they exist today and the assumption that populations would remain at their present locations. These assumptions, while appropriate for estimating impacts for comparison with other proposed actions, are not realistic because it is likely that populations will move and change in size. Therefore, DOE has chosen to project population size for 2035 (see Chapter 3, Section 3.1.7.1). If populations were to move closer to or increase in size in the Yucca Mountain groundwater region of influence, the radiation dose and resultant impacts could increase. DOE does not have the means to predict such changes quantitatively with great accuracy; therefore, the analysis does not attempt to quantify the resultant effects on overall impacts. In addition, the analysis does not address the potential benefits from future human activities including improved technology for removing radioactive materials from drinking water or the environment or medical advances such as cures for cancer.

Estimates of future climatic conditions are based on what is known about the past, with consideration given to climate impacts caused by human activities. Calcite in Devils Hole, a fissure in the ground approximately 40 kilometers (25 miles) southeast of Yucca Mountain, provides the best-dated record of climate changes over the past 500,000 years. The record shows continual variation, often with very rapid jumps, between cold glacial climates (for the Great Basin, these are called pluvial periods) and warm interglacial climates similar to the present. Fluctuations average 100,000 years in length (DIRS 153038-CRWMS M&O 2000, Section 6.4.1). The past climate cycles were idealized into a regular cycle of pulses, which were repeated throughout the period of the forecast. This method inherently assumes that the future will repeat the past. However, while current understanding of the causes of climate change allows some confidence in this approach, a considerable amount of conservatism was built into the models to account for possible climate uncertainties. For example, a large range of water fluxes was used to reflect the wide rainfall variations that could occur over thousands and hundreds of thousands of years (DIRS 155950-BSC 2001, Section 3.3.2.6). The analysis assumed that the current climate is the driest it will ever be at Yucca Mountain.

5.2.4.2 Uncertainty Associated with Currently Unavailable Data

Some uncertainties for input parameters or models result from gaps in available data. Such gaps may be due to the status of research (with further data expected later) or conditions that limit gathering of data (such as the need to conduct tests over impractical long periods of time or the necessity to not overly disturb the emplacement site). Uncertainty associated with currently unavailable data is a subset of parameter and model uncertainty that is discussed further in Section 5.2.4.3.

As further discussed in Section 5.2.4.3, the use of parameter distributions and studies of alternative models can provide understanding of how the lack of data affects the range of the impact results. Furthermore, sensitivity studies (see Section 5.2.4.3.4) can also provide insight into the importance of particular parameters. The sensitivity studies sometimes identify data with a small contribution to the results, thereby mitigating concerns arising from their unavailability.

The fact that some data are currently unavailable does not necessarily preclude providing adequate assessment of long-term impacts. When the Draft EIS and the Supplement to the Draft EIS were prepared there was sufficient information to provide an adequate analysis of the long-term performance impacts.

However, additional data have been generated since the publication of those documents. These data have helped improve characterization of the range of impacts in this Final EIS over those reported in the Draft EIS. Some examples of the additional data and their uses are the following:

- Concentrations of chemical components in the rock such as chloride, bromide, and sulfate are being measured, and the results will aid in identifying fast paths for water flow. Ongoing analyses of the isotopic ages of fracture-lining minerals provide preferential information on the history of water movement. These studies show how and when water has moved through the unsaturated zone and reveal characteristics of the water, such as the chemical composition and temperature. This information has been factored into modeling of the unsaturated zone (DIRS 155950-BSC 2001, Section 3.3.2)
- The effects of heating on water seepage into emplacement drifts were investigated in a drift-scale thermal test and by laboratory experiments that support models for predicting the effects of coupled processes over much longer periods (DIRS 155950-BSC 2001, Section 3.3.3)
- Accelerated corrosion testing of Alloy-22 has allowed more definitive quantification of corrosion rates used in improvements in the waste package degradation model (DIRS 155950-BSC 2001, Section 7.2.2)

5.2.4.3 Uncertainty Associated with Models and Model Parameters

The long-term performance model used to assess the impacts from groundwater migration includes a large number of submodels and requires a large amount of input data. The model must account for important features of the system, likely events, and processes that would contribute to the release and migration of materials. Because of the long periods being simulated, the complexity and variability of a natural system, and several other factors, the performance modeling must deal with a large degree of uncertainty. This section discusses the nature of the uncertainties and how they were accounted for in this EIS and their implication to interpretation of impact results. The *Supplemental Science and Performance Analysis* (DIRS 155950-BSC 2001, all) contains further details concerning this subject.

5.2.4.3.1 Variability Versus Uncertainty

A variable feature, event, or process is one that changes over space or with time. Examples include the porosity of the rock mass, the temperature in the repository, and the geochemical environment in the repository drifts. If all information was available, such parameters would be best expressed as known mathematical functions of space and time. In contrast, uncertainty relates to a lack of knowledge regarding a feature, event, or process—one whose properties or future outcome cannot be predicted. Four types of uncertainty are typically considered: value uncertainty, *conceptual model* uncertainty, numerical model uncertainty, and uncertainty regarding future events. The treatment of a feature, event, or process as purely variable or purely uncertain can lead to different modeling results.

Uncertainty and variability are sometimes related. The exact nature of the variability in a natural system cannot be known because all parts of the system cannot be observed. For example, DOE cannot dig up all the rock in Yucca Mountain and determine that the positioning of the rock layers is exactly as suggested by core sample data. Therefore, there is uncertainty about the properties of the rock at specific locations in the mountain because properties change with distance and it is not known how much they change at any given location. If the variability can be appropriately quantified or measured, a model usually can be developed to include this variability. If the variability cannot be physically quantified or estimated, it should be treated as uncertainty (lack of knowledge). However, the ability to model some types of spatial variability can be limited not only by lack of data but also by the capacity of a computer to complete calculations (for example, if one simulation took weeks or months to complete). In these instances, variability must be simplified in such a way as to be conservative (that is, the simulation would overestimate the impact).

Two basic tools were used in the analysis to deal with uncertainty and variability: alternative conceptual models and probability theory. Alternative conceptual models were used to handle uncertainty in the understanding of a key physical-chemical process controlling system behavior. Probability theory was used to understand the impacts of uncertainty in specific model parameters (that is, would results change if the parameter value was different). In particular, uncertain processes often required different conceptual models. For example, different conceptual models of how water in fractures communicates with water in the smaller pores or the matrix of the rock in the unsaturated zone lead to different flow and transport models. Sometimes conceptual models are not mutually exclusive (for example, both matrix and fracture flow might occur), and sometimes they do not exhaustively cover all possibilities (apparently matrix and fracture flow do cover all possibilities). These examples indicate that the use of alternative conceptual models, while often necessary to characterize some types of uncertainty, is not always as exact as desired.

A process of weighting alternative conceptual models (as described below) was used in the long-term consequence analysis to account for uncertainties in conceptual models. The Monte Carlo sampling technique was used for handling uncertainty in specific model parameters and for alternative conceptual models that were weighted beforehand with specific probabilities. The method involves random sampling of ranges of likely values, or *distributions*, for all uncertain input parameters. Distributions describe the probability of a particular value in the range. A common type of distribution is the familiar “bell-shaped” curve, also known as the *normal distribution*. Parameters in the consequence analysis are described by many different types of distributions appropriate for how the values and their probabilities are understood. Numerous realizations of the repository system behavior were calculated, each based on one set of samples of all the inputs. Each total system realization had an associated probability so that there is some perspective on the likelihood of that set of circumstances occurring. The Monte Carlo method yields a range for any chosen performance measure (for example, peak annual individual dose in a given period at a given location) along with a probability for each value in the range. In other words, it gives an estimate of repository performance and determines the possible errors based on the estimate. In this chapter, the impact estimates are expressed as the mean of all the realizations and the 95th-percentile value (that is, the value for which 95 percent of the results were smaller).

CALCULATING THE MEAN AND 95TH-PERCENTILE RESULTS

DOE calculated a mean and 95th-percentile dose history by selecting the mean and 95th-percentile value at each time step in the simulation. Thus, the mean dose history consisted of the average of all 300 realizations of dose rate at each time step, and the 95th-percentile dose history consisted of the 95th-percentile at each time step. The EIS analysis determined the peak value from these dose histories, and the EIS discusses the “peak of the mean dose history” and the “peak of the 95th-percentile dose history.”

5.2.4.3.2 Weighting of Alternative Conceptual Models

In some cases, modeling alternatives form a continuum, and sampling from the continuum of assumptions fits naturally in the Monte Carlo framework of sampling from probability distributions. In other cases, the assumptions or models are discrete choices. In particular, some processes are so highly uncertain that there are not enough data to justify developing continuous probability distributions over the postulated ranges of behavior. In such cases, a high degree of sampling is unwarranted, and an analysis often models two or three cases that are assumed to encompass the likely behavior.

There were two possible approaches to incorporating discrete alternative models in the performance analysis: weighting all models into one comprehensive Monte Carlo simulation (lumping), or keeping the discrete models separate and performing multiple Monte Carlo simulations for each discrete model

(splitting). The main results in Section 5.4 were developed using the splitting approach because they were based on a limited range of uncertainty. Based on expert judgment (and to some extent the finite time and resources that could be applied to the analysis effort), the analysis used a best estimate of the more likely ranges of model behavior and parameter ranges. Some alternative models were not included in the analysis, and some parameter ranges of the included models were narrowed. Because of this narrowed range of models and parameters, the results are conditional, meaning that they depend on certain models and parameters being held constant or having their variance restricted. One such condition is the specific design of the repository and the waste packages in the design evaluated in this EIS. Another important condition is that the cladding on the spent nuclear fuel can be depended on as a barrier. Other conditional results were used to characterize the effect of certain assumptions. For example, splitting was done to consider such events as human intrusion (Section 5.7.1), igneous activity (Section 5.7.2), and criticality (Section 5.8). The consequences of these types of events are not part of results given in Section 5.4; rather they are reported as added impacts with certain probabilities of occurrence.

5.2.4.3.3 *Uncertainty and the Proposed Action*

The analysis for the Proposed Action encompassed many of the underlying uncertainties. It included some of all four types of uncertainty: value or parameter uncertainty, conceptual model uncertainty, numerical model uncertainty, and future-event uncertainty. Therefore, the results represent a “lumping” approach. Uncertainty not lumped into the modeling, which produced the central results in Section 5.4, was addressed discretely in alternative models, alternative features, and alternative events such as human intrusion. These alternatives were “split” from the nominal results, and their effects on performance are described separately.

5.2.4.3.4 *Uncertainty and Sensitivity*

In addition to accounting for the uncertainty, characteristics of the engineered and natural systems (such as the unsaturated and saturated zones of the groundwater system) that would have the most influence on repository performance also need to be understood. This information helps define uncertainty in the context of what would most influence the results. This concept is called sensitivity analysis. A number of methods are used to explain the results and quantify sensitivities. Total system performance is a function of sensitivity (if a parameter is varied, how much do the performance measures change) and uncertainty (how much variation of a parameter is reasonable). For example, the long-term performance results could be very sensitive to a certain parameter, but the value for the parameter is exactly known. In the uncertainty analysis techniques described below, that parameter would not be regarded as important. However, many parameters in the analyses do have an associated uncertainty and do become highly important to performance. On the other hand, the level of their ranking can depend on the width of the assigned uncertainty range.

Many of the important uncertain parameters were examined in alternative models. The alternative models either expand the range of the parameters beyond the expected range of uncertainty or change the weighting of the parameter distribution. For example, this type of analysis was performed for alternative models of seepage (DIRS 101779-DOE 1998, Volume 3, pp. 5-1 to 5-9) and cladding degradation (DIRS 101779-DOE 1998, Volume 3, pp. 5-32 to 5-35). An example of alternative model studies for volcanic hazards is discussed in DIRS 155950-BSC (2001, Section 14.3.1, p. 14-6).

System performance could be sensitive to repository design options, but models and parameters for these various options do not have an assigned uncertainty. Therefore, although they can be important, they do not show up as key parameters based on an uncertainty analysis. The determination of the parameters or components that are most important depends on the particular performance measure being used. This point was demonstrated in the 1993 TSPA (DIRS 100111-CRWMS M&O 1994, all; DIRS 100191-Wilson

et al. 1994, all) and the Total System Performance Assessment-1995 (DIRS 100198-CRWMS M&O 1995, all). For example, these two analyses showed that the important parameters would be different for 10,000-year peak doses than for 1-million-year peak doses.

There are several techniques for analyzing uncertainties, including the use of qualitative scatter plots where the results (for example, annual individual dose) are plotted against the input parameters and visually inspected for trends. In addition, performance measures can be plotted against various subsystem outputs or surrogate performance measures (for example, waste package lifetime) to determine if that subsystem or performance surrogate would be important to performance. There are several formal mathematical techniques for analyzing the sets of realizations from a Monte Carlo analysis to extract information about the effects of parameters. Such an analysis determined the principal factors affecting the performance of the repository design.

5.2.4.3.5 Uncertainty Analysis for the TSPA-Site Recommendation

The Science and Engineering Report (DIRS 153849-DOE 2001, all) provides the results of a comprehensive quantitative analysis of the possible future behavior of a Yucca Mountain repository. The analysis, documented in the *Total System Performance Assessment for the Site Recommendation* (DIRS 153246-CRWMS M&O 2000, all), combined the results of detailed conceptual and numerical models of each of the individual and coupled processes in a single *probabilistic* model that can be used to assess how a repository might perform over long periods. The TSPA-Site Recommendation was a next-generation analysis after the TSPA-Viability Assessment, which DOE used for analysis of long-term performance in the Draft EIS. The Site Recommendation analysis was the result of design changes to the proposed repository and advancement in knowledge from ongoing research activities.

Despite the extensive scientific studies described in the Science and Engineering Report, DOE has always recognized that uncertainties will remain in any assessment of the performance of a repository over thousands of years, as discussed in that report (DIRS 153849-DOE 2001, Sections 1.5, 4.1, and 4.4). These uncertainties are attributable to a variety of causes, ranging from uncertainty regarding the fundamental processes that could affect radionuclide migration to uncertainty related to the design and operation of the repository. For this reason, one part of the DOE approach to dealing with uncertainty relies on multiple lines of evidence that can contribute to the understanding of the performance of the potential repository. Another part of the DOE approach is a commitment to continued testing, monitoring, and analysis beyond the possible recommendation of the site.

The TSPA-Site Recommendation model incorporated a number of uncertainties. These were uncertainties for which a realistic distribution of parameters is not identified, but rather a very conservative bounding value or bounding range was chosen. Additional studies have investigated effects of unquantified uncertainties and sensitivities in the TSPA model by better quantification of uncertainties and the affected processes. This research is documented in the Supplemental Science and Performance Analysis (DIRS 155950-BSC 2001, all). (See Appendix I, Section I.2 for more detailed discussion of the evolution of the TSPA model and application to this EIS.) A summary of areas in which the Supplemental Science and Performance Analysis model benefited from these additional uncertainty studies is provided below. The Supplemental Science and Performance Analysis (DIRS 155950-BSC 2001, all) contains full details of the studies.

Unquantified Uncertainty Analysis

Part of the work described in the Supplemental Science and Performance Analysis (DIRS 155950-BSC 2001, all) included analysis of unquantified uncertainties. Table 5-4 summarizes the elements of the model that DOE studied and indicates whether or not revised model elements were included in the Supplemental Science and Performance Analysis model. The Supplemental Science and Performance Analysis model, with additional modifications, was used for the long-term performance analysis for this

Table 5-4. Analysis of unquantified uncertainties and resulting TSPA model modifications^a
(page 1 of 2).

Process model (section of S&ER ^b)	Topic of unquantified uncertainty analysis	Section of SSPA ^c Volume 1	In Supplemental TSPA ^d model	
Seepage into emplacement drifts (4.2.1)	Flow- focusing in heterogeneous permeability field; episodic seepage	4.3.1, 4.3.2, 4.3.5	Yes	
	Effects on rock bolts and drift degradation on seepage	4.3.3, 4.3.4		
Coupled effects on seepage (4.2.2)	Thermal effects on seepage	4.3.5	Yes	
	Thermal-hydrologic-chemical effects on seepage	4.3.6		
Water diversion performance of engineered barrier system (4.2.3)	Multiscale thermal-hydrologic model, including effects of rock dryout	5.3.1	Yes	
	Thermal property sets	5.3.1	Yes	
	Effect of in-drift convection on temperature, humidity, invert saturations, and evaporation rates	5.3.2		
In-drift moisture distribution (4.2.5)	Composition of liquid and gas entering drift	6.3.1	Yes	
	Evolution of in-drift chemical environment	6.3.3	Yes	
	Environment on surface of drip shields and waste packages	5.3.2, 7.3.1		
	Condensation under drip shields	8.3.2		
	Evaporation of seepage	8.3.1, 5.3.2	Yes	
Drip shield degradation and performance (4.2.4)	Effect of breached drip shields or waste package on seepage	8.3.3	Yes	
	Waste package release flow geometry (flow- through, bathtub)	8.3.4		
Waste package degradation and performance (4.2.4)	Local chemical environment on surface of drip shields (including magnesium, lead) and potential for initiating localized corrosion	7.3.1		
	Local chemical environment on surface of waste packages (including magnesium, lead) and potential for initiating localized corrosion	7.3.1		
	Aging and phase stability effects on Alloy-22	7.3.2	Yes	
	Uncertainty in weld stress state following mitigation	7.3.3	Yes	
	Weld defects	7.3.3	Yes	
	Early failure due to improper heat treatment	7.3.6	Yes	
	General corrosion rate of Alloy-22: temperature dependency ^e	7.3.5	Yes	
	General corrosion rate of Alloy-22: uncertainty/ variability partition	7.3.5	Yes	
	Long- term stability of passive films on Alloy-22	7.3.4		
	Stress threshold for initiation of stress corrosion cracking	7.3.3	Yes	
	Distribution of crack growth exponent repassivation slope	7.3.7	Yes	
	Effect of HLW ^f glass degradation rate and steel degradation rate on in-package chemistry	9.3.1	Yes	
	Cladding degradation and performance (4.2.6)	Effect of initial perforations, creep rupture, stress corrosion cracking, localized corrosion, seismic failure, rock overburden failure, and unzipping velocity on cladding degradation	9.3.3	Yes
		HLW glass degradation rates	9.3.1	
	Defense HLW degradation and performance (4.2.6)	HLW glass degradation rates	9.3.1	
Dissolved radionuclide concentrations (4.2.6)	Solubility of neptunium, thorium, plutonium, and technetium	9.3.2	Yes	
Colloid-associated radionuclide concentrations (4.2.6)	Colloid mass concentrations	9.3.4		
Engineered barrier system (invert) degradation and transport (4.2.6, 4.2.7)	Diffusion inside waste package	10.3.1	Yes	
	Transport pathway from inside waste package to invert	10.3.2		
	Sorption inside waste package	10.3.4	Yes	
	Sorption in invert	10.3.4	Yes	
	Diffusion through invert	10.3.3	Yes	
	Colloid stability in invert	10.3.5		
Unsaturated zone radionuclide transport (advective pathways; retardation; dispersion; dilution) (4.2.8)	Microbial transport of colloids	10.3.6		
	Effect of drift shadow zone-advection/diffusion splitting	11.3.1	Yes	
	Effect of drift shadow zone – concentration boundary condition on engineered barrier system release rates	11.3.1		
Saturated zone radionuclide flow and transport (4.2.9)	Effect of matrix diffusion	11.3.2, 11.3.3		
	Groundwater specific discharge	12.3.1		
	Effective diffusion coefficient in volcanic tuffs	12.3.2		
	Flowing interval (fracture) porosity	12.3.2		
	Effective porosity in alluvium	12.3.2		
	Correlation of effective diffusion coefficient with matrix porosity	12.3.2		
	Bulk density of alluvium	12.3.2	Yes	
	Retardation for radionuclides irreversibly sorbed on colloids in alluvium	12.3.2		
	Sorption coefficient in alluvium for iodine, technetium	12.3.2	Yes	
	Sorption coefficient in alluvium for neptunium, uranium	12.3.2		
Sorption coefficient for neptunium in volcanic tuffs	12.3.2			
Effective longitudinal dispersivity	12.3.2			

Table 5-4. Analysis of unquantified uncertainties and resulting TSPA model modifications.^a
(page 2 of 2).

Process model (section of S&ER ^b)	Topic of unquantified uncertainty analysis	Section of SSPA ^c Volume 1	In Supplemental TSPA ^d model
Biosphere (4.2.10) ^e	Individual of interest	13.3.1	
	Comparison of dose assessment methods	13.3.2	
	Radionuclide removal from soil by leaching	13.3.3	
	Uncertainties not captured by GENII-S model	13.3.4	
	Influence of climate change on groundwater usage and biosphere dose	13.3.5,	
	conversion factors	13.3.7	

- a. Adapted from DIRS 155950-BSC (2001, Table 1-1, pp. 1T-1 to 1T-6).
- b. S&ER - Science and Engineering Report (DIRS 153849 - DOE 2001, all).
- c. SSPA - Supplemental Science and Performance Analysis (DIRS 155950-BSC 2001, all).
- d. TSPA -Total System Performance Assessment.
- e. The temperature dependent corrosion model was not used for this EIS (see Appendix I, Section I.4); the model used for this EIS yields a more conservative result.
- f. HLW = high-level radioactive waste.
- g. DOE used revised biosphere dose conversion factors for this EIS to conform to the Environmental Protection Agency standard, 40 CFR Part 197.

Final EIS (see Appendix I, Sections I.2 and I.4). The first column of Table 5-4 lists the major process models and a reference to the appropriate section in the Science and Engineering Report (DIRS 153849-DOE 2001, all). The second column lists the individual model elements analyzed in the unquantified uncertainties report. The third column lists sections of Volume 1 of the Supplemental Science and Performance Analysis report (DIRS 155950-BSC 2001, all) that contain additional details on the analysis. The analyses included sensitivity studies or other analysis methods to determine how significant the uncertainty might be. If warranted and possible, changes were made to the Supplemental Science and Performance Analysis model to better characterize the uncertainties; this is noted in the fourth column.

5.2.4.3.6 Key Parameters and Uncertainty

DOE performed an analysis to determine which parameters contributed most to the uncertainties in the long-term performance results for the nominal scenario reported in Section 5.4. Such important parameters will be the greatest contributors to variations in calculated impacts because of the high sensitivity of the results to the parameter or high uncertainty in the parameter. In any case, the range of values in the distribution for these parameters exerts the strongest influence on the uncertainty of the results.

Two types of analysis were used: stepwise linear rank regression and classification tree [in which parameters were classified in terms of the separation of outcomes into “high”-dose (top 10th-percentile) and “low”-dose (bottom 10th-percentile) categories] (DIRS 155934-Mishra 2001, all; DIRS 155936-Mon 2001, all).

Regression Analysis

Regression analysis is a tool for quantifying the strength of input-output relationships in the TSPA model. To this end, a stepwise linear rank regression model is fitted between individual dose at a given time (or some other performance measure) and all randomly sampled input variables. Parameters are ranked on the basis of how much their exclusion would degrade the explanatory power of the regression model. The importance ranking measure used for this purpose is the uncertainty importance factor, which is defined as the loss in explanatory power divided by the coefficient of determination of the regression model. The uncertainty importance factor quantifies the proportion of the total spread (variance) in total dose explained by the regression model that can be attributed to the variable of interest.

Classification Tree Analysis

Classification tree analysis, a subset of classification and regression tree analysis, is a method for determining variables or interactions of variables that drive output into particular categories. Classification and regression tree analyses can be used to generate decision rules that determine whether a particular realization would produce “high” or “low” dose depending on the values of the most important variables. Unlike regression analysis, which is based on the total range of model outcomes, classification tree analysis focuses on extreme values of model results and tries to relate them to specific ranges of values for the important variables.

Results

For different time frames in the analysis, different parameters emerge as important to the overall variability of the results (DIRS 155934-Mishra 2001, all and DIRS 155936-Mon 2001, all). Table 5-5 lists the results of the analysis.

Table 5-5. Top-ranking uncertainty importance parameters.^a

Time after closure	Two most important parameters
125,000 years	General humid air corrosion rate of Alloy-22 outer lid General humid air corrosion rate of Alloy-22 inner lid
250,000 years	General humid air corrosion rate of Alloy-22 outer lid General humid air corrosion rate of Alloy-22 inner lid
500,000 years	Episodic factor General humid air corrosion rate of Alloy-22 outer lid
1,000,000 years	Episodic factor Infiltration scenario

a. Sources: DIRS 155934-Mishra (2001, all) and DIRS 155936-Mon (2001, all).

A description of the important parameters identified in Table 5-5 follows:

- **General Humid Air Corrosion Rates of Alloy-22, Inner and Outer Lids** – When the drip shields are intact and no water is dripping on the waste package, the corrosion rate of Alloy-22 is governed by the humid air corrosion rates of the inner lid and the outer lid. The waste package closure end has three lids: an innermost stainless-steel lid, an inner Alloy-22 lid, and an outer Alloy-22 lid. These two corrosion rate parameters govern how the respective Alloy-22 lids degrade when not exposed to dripping water.
- **Episodic Factor** – The conceptual model governing episodic infiltration represents fractures comprised of randomly distributed “pinch-point” and “storage” apertures. Pinch-point apertures act as capillary barriers to the infiltration of water, which accumulates in a volume above the pinch-point dictated by the storage aperture. The water continues to accumulate in the storage aperture until the hydraulic head above the pinch-point aperture exceeds the associated capillary rise height. Once this threshold is reached, the water begins to flow downward under the force of gravity at a rate dictated by the permeability of the aperture. Water continues to flow through the aperture until the accumulated water is completely drained. This behavior leads to an episodic infiltration of water through fractured rock that occurs randomly in space and time. The distribution of a factor that is randomly sampled governs this episodic flow in the numerical model.
- **Infiltration Scenario** – For each of the six *climate states* (see Appendix I, Section I.2.2) there are three possible infiltration rates (low, medium, and high). The particular climate state and infiltration rate is the infiltration scenario. Therefore, this variable is a function of the infiltration rate.

The parameters in Table 5-5 that most affect the total uncertainty in the TSPA model are factors that would govern the degradation of the waste package for the first 250,000 years following repository

closure. After 250,000 years, most waste packages would have failed and other factors become important. Even at 500,000 years after repository closure, waste package degradation is still important. At later times the important parameters would be related to factors that influenced the flow of water in the drifts, especially infiltration and episodic flow.

5.3 Locations for Impact Estimates

Yucca Mountain is in the transition area between the Mojave Desert and the Great Basin. This is a semiarid region with linear mountain ranges and intervening valleys, with rainfall averaging between about 100 and 250 millimeters (4 and 10 inches) a year, sparse vegetation, and a small population. Although there is low infiltration of water through the mountain and no people currently live in the land withdrawal area, radioactive and chemically toxic materials released from the repository could affect persons living closer to the proposed repository in the distant future. This section describes the regions where possible human health impacts could occur.

Figure 5-3 is a map with arrows showing the general direction of groundwater movement from Yucca Mountain. Shading indicates major areas of groundwater discharge through a combination of springs and evapotranspiration by plants. The general path of water that infiltrates through Yucca Mountain is south toward Amargosa Valley, into and through the area around Death Valley Junction in the lower Amargosa Desert. Natural discharge of groundwater from beneath Yucca Mountain probably occurs farther south at Franklin Lake Playa (DIRS 100376-Czarnecki 1990, pp. 1 to 12), and spring discharge in Death Valley is a possibility (DIRS 100131-D'Agnes et al. 1997, pp. 64 and 69).

Although groundwater from the Yucca Mountain vicinity flows under and to the west of Ash Meadows in the volcanic tuff or alluvial aquifers, the surface discharge areas at Ash Meadows and Devils Hole (see map in Figure 5-3 for locations) are fed from the carbonate aquifer. While these two aquifers are connected at some locations, the carbonate aquifer has a hydraulic head that is higher than that of the volcanic or alluvial aquifers. Because of this pressure difference, water from the volcanic aquifer does not flow into the carbonate aquifer; rather, the reverse occurs. Therefore, contamination from Yucca Mountain is not likely to mix with the carbonate waters and discharge to the surface at Ash Meadows or Devils Hole (DIRS 104983-CRWMS M&O 1999, all) under current conditions. This pressure difference could change under future climate conditions.

Because, under expected conditions, there would be no contamination of this discharge water, there would be no human health impacts. Furthermore, there would be no consequences to the endangered Ash Meadows Amargosa pupfish (*Cyprinodon nevadensis mionectes*) or Devils Hole pupfish (*Cyprinodon diabolis*) at those locations.

Figure 3-25 in Chapter 3 shows the projected population of 76,000 residents within 80 kilometers (50 miles) of Yucca Mountain in 2035. This map provides the information used to estimate population doses from radionuclides released to the atmosphere from the repository. The atmospheric analysis in Section 5.5 used the 80-kilometer (50-mile) population distribution described in Section 3.1.8.

In the Draft EIS, impacts were evaluated at 5-kilometer (3-mile), 20-kilometer (12-mile), and 30-kilometer (19-mile) distances from the repository as well as at the groundwater discharge point. The EPA regulation, 40 CFR 197.12, establishes a controlled area around the repository that must not extend farther south than 36 degrees, 40 minutes, 13.6661 north latitude, in the predominant direction of groundwater flow. For this EIS, DOE assumed the controlled area boundary to be the farthest point south. The predominant groundwater flow crosses this boundary approximately 18 kilometers (11 miles) from the repository. Therefore, the 5-kilometer (3-mile) distance would be inside the controlled area, would no longer be part of the accessible environment, and DOE did not evaluate impacts at this distance.

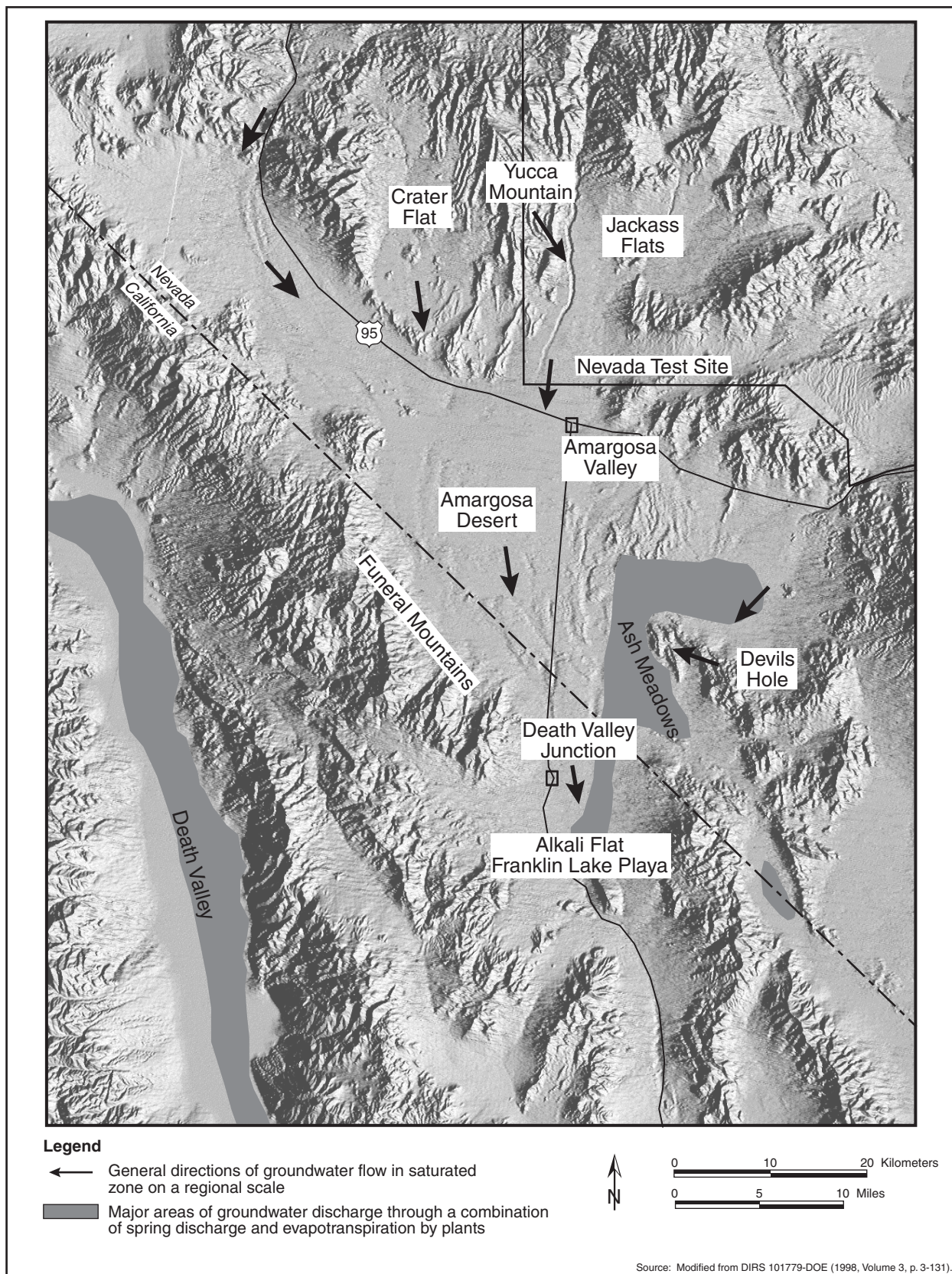

Figure 5-3. Map of the saturated groundwater flow system.

5.4 Waterborne Radiological Consequences

The following sections report the annual committed effective dose equivalent, expressed in millirem, to individuals living at three locations south of Yucca Mountain. These individuals are assumed to use contaminated groundwater and have lifestyle characteristics of the RMEI defined in 40 CFR 197.21. The RMEI is exposed to the high end of the range of potential dose distribution for the exposed population, called “reasonable maximum exposure” conditions. RMEI is a hypothetical person who meets the following criteria:

- a) Lives at the location above where the highest concentration of radionuclides in the groundwater contamination plume crosses the boundary of the controlled area. The surface of the controlled area is defined as (40 CFR Part 197) the area, identified by passive institutional controls, that encompasses no more than 300 square kilometers. It must not extend farther south than 36° 40' 13.661" north latitude, in the predominant direction of groundwater flow, and no more than five kilometers from the repository footprint in any other direction
- b) Has a diet and living style representative of the people who now reside in the Town of Amargosa Valley, Nevada. DOE must use projections based on surveys of the people residing in the Town of Amargosa Valley, Nevada, to determine their current diets and living styles and use the mean values of these factors in the assessments conducted for 40 CFR 197.20 and 197.25
- c) Drinks 2 liters of water per day from wells drilled into the ground at the location specified in a).

POPULATION DOSE AND FUTURE POPULATION SIZE

Population dose is a summation of the doses received by individuals in an exposed population (unit of measure is *person-rem*). The population dose depends on the number of people at different locations. If the number of people increases in the future, the population dose estimate would also increase.

While the RMEI is a regulatory definition for a specific location, impacts to individuals at two additional locations were evaluated using the lifestyle characteristics of the RMEI.

The analysis converted the annual committed effective dose equivalent, referred to as the annual individual dose, to the probability of contracting a fatal cancer (referred to as a latent cancer fatality) due to exposure to radioactive materials in the water. In addition, the analysis calculated population doses in person-rem for two different periods: for the 70-year lifetime at the time of the peak dose during the first 10,000 years after repository closure, and integrated over the first 10,000 years after repository closure. The analysis also converted the population dose to the expected number of latent cancer fatalities in the population. DOE based the analysis on the radionuclide inventories discussed in Section 5.1. However, the analysis included the entire carbon-14 inventory of the commercial spent nuclear fuel as a solid in the groundwater release models. Actually, 2 percent of the carbon-14 exists as a gas in the fuel (see Section 5.5). Thus, the groundwater models slightly overestimate (by 2 percent) the potential impacts from carbon-14.

The analysis studied potential consequences to individuals at three impact locations arising from waste mobilization and waterborne transport. A set of 300 model simulations were run using the GoldSim model (DIRS 155182-BSC 2001, all) for the RMEI location [about 18 kilometers (11 miles) from Yucca Mountain]. Each simulation used separate sets of sampled uncertainty parameters and generated an annual individual-dose profile for the 1 million years following repository closure. This set of simulations for the RMEI location, and some additional groundwater simulations (DIRS 154659-BSC 2001, Enclosure 3) provided the basis for calculating doses at 30 kilometers (19 miles) from the repository and at the discharge location near Franklin Lake Playa.

5.4.1 EXTENSION OF GROUNDWATER IMPACTS TO OTHER DISTANCES

The TSPA model estimates potential groundwater impacts for the RMEI location. This EIS provides groundwater impacts for two other important downgradient locations. These locations are 30 kilometers (19 miles), where most of the current population in the groundwater flow path is located, and 60 kilometers (37 miles), where the aquifer discharges to the surface (this location is also known as Franklin Lake Playa). The TSPA model used for the groundwater impacts at 18 kilometers (11 miles) is specifically designed for the RMEI location and is not directly usable to obtain reasonable estimates at farther distances. This is because conservative assumptions were embodied in the model, and the saturated zone transport model was designed primarily for the volcanic aquifer with characteristically very low mixing of waste in groundwater. Groundwater flow beyond the RMEI location occurs primarily in an alluvial medium with characteristically higher mixing, so plume concentrations would be reduced and a smaller quantity of radionuclides would be carried into the water usage wells.

Appendix I, Section I.4.5, details the development of distance scale factors using a three-dimensional analytical advection and dispersion transport model. Scaling factors were developed based on two criteria: attenuation of the peak concentrations in the plume and general increase in the cross-sectional area of the plume (that is, reduction of the average plume concentration). Two sets of factors were developed based on a large source size (characteristic of the repository footprint) and a small source size [10 meters by 10 meters (33 feet by 33 feet)]. The scaling factors were used to estimate *peak of the mean* and peak of the 95th-percentile annual individual doses and the groundwater concentrations at the two additional distances reported in Sections 5.4.2.1 and 5.4.2.2.

For the 10,000-year period of the nominal scenario, the dose would be attributable to the failure of a few waste packages. In this case, scaling factors based on a small size source were used. For the 1-million-year period, the release would be attributable to general releases over the whole repository area, so large source size scale factors were used. The factors based on the cross-section of the plume were chosen for the estimates. This was appropriate because the effect of water usage by the communities would be to cause significant mixing, and the more characteristic parameter would be the plume average concentration. Appendix I, Section I.4.5, includes scale factors for both approaches for comparison.

5.4.2 WATERBORNE RADIOLOGICAL RESULTS

This section discusses waterborne radiological consequences in relation to a higher-temperature repository operating mode and a lower-temperature operating mode. The individual and population dose calculations in this section were performed in a probabilistic manner using a volume of water necessary to operate 15 to 25 farms, representing a range of groundwater volumes from 1.1 million cubic meters to 4.2 million cubic meters (890 acre-feet to 3,400 acre-feet) with an average water demand of approximately 2.5 million cubic meters (2,000 acre-feet) per year. The final Nuclear Regulatory Commission regulations regarding a Yucca Mountain Repository state that the RMEI calculations should use an average water demand of 3,000 acre-feet [10 CFR 63.312(c)]. The 3.7-million-cubic-meter (3,000 acre-foot) water demand as specified by the Commission would result in dose estimates about two-thirds of the values in this section (DIRS 156743-Williams 2001, Section 6.3, pp. 12 and 13). The groundwater protection calculations in this section use 3,000 acre-feet water demand as called for in 40 CFR 197.31.

5.4.2.1 Waterborne Radiological Results for the Higher-Temperature Repository Operating Mode

The performance analysis indicated that for the first 10,000 years there would be very limited releases, attributable to early waste package failures due to waste package manufacturing defects, with very small radiological consequences (see Table 5-6). For the first 10,000 years after repository closure, the mean

Table 5-6. Impacts for an individual from groundwater releases of radionuclides during 10,000 years after repository closure for the higher-temperature repository operating mode.

Individual	Mean			95th-percentile		
	Peak annual individual dose (millirem)	Time of peak (years)	Probability of an LCF ^a	Peak annual individual dose (millirem)	Time of peak (years)	Probability of an LCF ^a
At RMEI location ^b	0.00002 ^c	4,900	6×10^{-10}	0.0001 ^d	4,900	4×10^{-9}
At 30 kilometers ^e	~0 ^f	NC ^g	~0	~0 ^f	NC	~0
At discharge location ^h	~0 ^f	NC	~0	~0 ^f	NC	~0

- a. LCF = latent cancer fatality; incremental lifetime (70 years) risk of contracting a fatal cancer for individuals, assuming a risk of 0.0005 latent cancer per rem for members of the public (DIRS 101856-NCRP 1993, p. 31).
- b. The RMEI location is approximately 18 kilometers (11 miles) downgradient from the repository. The maximum allowable peak of the mean annual individual dose for 10,000 years at this distance is 15 millirem.
- c. Based on 300 simulations of total system performance, each using random samples of uncertain parameters.
- d. Represents a value for which 285 out of the 300 simulations yielded a smaller value.
- e. 30 kilometers = 19 miles.
- f. Values would be lower than the small values computed for the RMEI location.
- g. NC = not calculated (peak time would be greater than time given for the RMEI location).
- h. 60 kilometers (37 miles) at Franklin Lake Playa.

WHY ARE THE MEAN IMPACTS SOMETIMES HIGHER THAN THE 95TH-PERCENTILE IMPACTS?

The *mean* impact is the arithmetic average of the 300 impact results from simulations of total-system performance. The mean is not the same as the 50th-percentile value (the 50th-percentile value is called the *median*) if the distribution is *skewed*.

The performance results reported in this EIS come from highly skewed distributions. In this context, *skewed* indicates that there are a few impact estimates that are much larger than the rest of the impacts. When a large value is added to a group of small values, the large value dominates the calculation of the mean. The simulations reported in this EIS have mean impacts that are occasionally above the 90th-percentile and occasionally above the 95th percentile.

peak would be 0.00002 millirem and the 95th-percentile peak would be 0.0001 millirem. The peaks would be even smaller at greater distances. This result was lower than the Environmental Protection Agency standard, which allows up to a 15-millirem annual committed effective dose equivalent during the first 10,000 years. In the remainder of this chapter, the “annual committed effective dose equivalent” is referred to as the “annual individual dose.”

Table 5-7 lists the population consequences associated with the peak annual individual dose listed in Table 5-6. The population size was based on the projected population numbers for 2035 in Figure 3-25 in Chapter 3 of this EIS. For these calculations, the analysis assumed that no contaminated groundwater would reach populations in any regions to the north of Yucca Mountain. Therefore, populations in the sectors north of the due east and due west sectors in Figure 3-25 were not considered to be exposed.

- 47 people would be exposed at the RMEI location [includes sectors from 12 to 28 kilometers (7 to 17 miles)]
- 4,200 people would be exposed at about 30 kilometers (19 miles) downgradient from the potential repository [includes sectors from 28 to 44 kilometers (17 to 27 miles)]

Table 5-7. Population impacts from groundwater releases of radionuclides during 10,000 years after repository closure for the higher-temperature repository operating mode.

Impact	Mean		95th-percentile	
	Population dose (person-rem)	Population LCF ^a	Population dose (person-rem)	Population LCF ^c
Peak 70-year lifetime	0.006	0.000003	0.04	0.00002
Integrated over 10,000 years	0.5	0.0002	0.6	0.0003

a. LCF = latent cancer fatality; expected number of cancer fatalities for populations, assuming a risk of 0.0005 latent cancer per rem for members of the public (DIRS 101856-NCRP 1993, p. 31).

- 69,500 people would be exposed at the discharge location about 60 kilometers (37 miles) downgradient from the potential repository [includes sectors from 44 to 80 kilometers (27 to 50 miles)]

Thus, approximately 74,000 people would be exposed to contaminated groundwater. This stylized population dose analysis assumed that people would continue to live in the locations being used at present. This assumption is consistent with the recommendation made by the National Academy of Sciences (DIRS 100018-National Research Council 1995, all) because it is impossible to make accurate predictions of lifestyles and residence locations far into the future.

The values in Table 5-7 include a scaling factor for water use. The performance assessment transport model calculated the annual individual dose assuming the radionuclides dissolved in water that flowed through the unsaturated zone of Yucca Mountain would mix in an average of 2.4 million cubic meters (1,940 acre feet) (DIRS 155950-BSC 2001, p. 13-42) per year in the saturated zone aquifer. This compares to an annual water use in the Amargosa Valley of about 17.1 million cubic meters (13,900 acre-feet) (DIRS 155950-BSC 2001, p. 13-42). The analysis diluted the concentration of the nuclides in the 2.4 million cubic meters of water throughout the 17.1 million cubic meters of water before calculating the population dose.

The small consequences listed in Tables 5-6 and 5-7 would result from the durability of the waste packages; most of which would remain intact significantly longer than 10,000 years. The outer layer of the waste package would be subject to a very low average corrosion rate, but there is a high degree of uncertainty in the value of that average corrosion rate. Model simulations incorporated a small number of waste package failures within 10,000 years due to manufacturing defects; the dose results in Tables 5-6 and 5-7 during this period would result directly from these early failures.

The radionuclides that would contribute the most to individual dose in 10,000 years would be technetium-99, carbon-14 dissolved in groundwater, and iodine-129. For example, the mean consequence at 18 kilometers (11 miles) has technetium-99 contributing 77 percent of the total annual individual dose rate, carbon-14 contributing 16 percent, and iodine-129 contributing 7 percent. While the atmospheric analysis in this EIS assumed that 2 percent of the carbon-14 migrated as gas in the form of carbon dioxide (see Section 5.5 for more details), the groundwater modeling for this waterborne radiological consequences analysis conservatively assumed that all of the carbon-14 migrated in the groundwater.

Table 5-8 lists impacts for the post-10,000-year period. The table lists the mean and 95th-percentile peak annual individual dose and the times of the associated peaks at three locations. The mean and 95th-percentile annual individual doses during 1 million years following repository closure are shown in Figure 5-4. The multiple peaks occurring 200,000 years or more after repository closure are driven by transitions between climate states.

Table 5-8. Impacts for an individual from groundwater releases of radionuclides during 1 million years after repository closure for the higher-temperature repository operating mode.

Individual	Mean		95th-percentile	
	Peak annual individual dose (millirem)	Time of peak (years)	Peak annual individual dose (millirem)	Time of peak (years)
At RMEI location ^a	150 ^b	480,000	620 ^c	410,000
At 30 kilometers ^d	100 ^e	NC ^f	420 ^e	NC
At discharge location ^g	59 ^e	NC	240 ^e	NC

- a. The RMEI location is approximately 18 kilometers (11 miles) downgradient from the repository.
- b. Based on 300 simulations of total system performance, each using random samples of uncertain parameters.
- c. Represents a value for which 285 out of the 300 simulations yielded a smaller value.
- d. 30 kilometers = 19 miles.
- e. Estimated using scale factors as described in Section 5.4.1.
- f. NC = not calculated (peak time would be greater than time given for the RMEI location).
- g. 60 kilometers (37 miles) at Franklin Lake Playa.

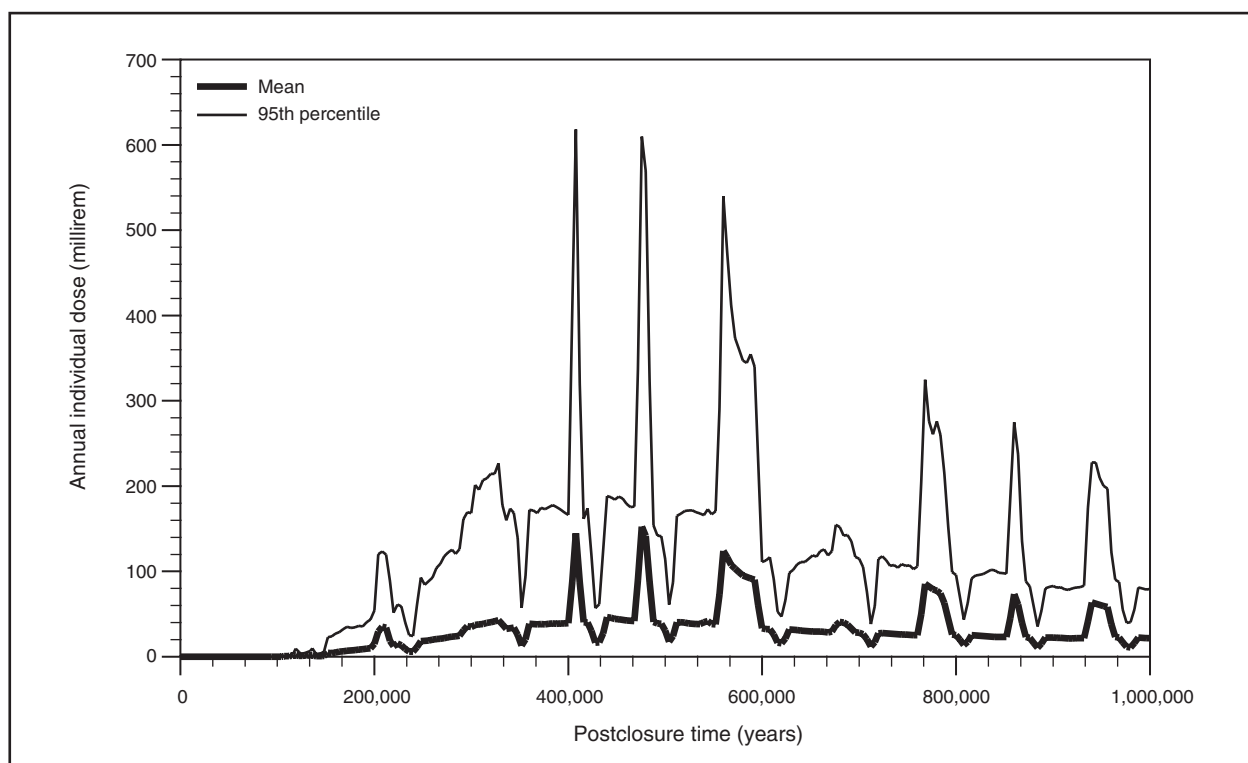

Figure 5-4. Mean and 95th-percentile (based on 300 simulations of total system performance, each using random samples of uncertain parameters) annual individual dose at the RMEI location during 1 million years after repository closure for the nominal scenario under the higher-temperature repository operating mode.

The simulations were ended after 1 million years largely because further radioactive decay would continue to decrease the annual individual dose even for very long-lived radionuclides. The peak annual individual dose usually coincided with the occurrence of a wetter climate period.

The radionuclides that would contribute the most to the peak annual individual dose in 1 million years would be neptunium-237 and plutonium-242. The mean peak annual individual dose at the RMEI location would have neptunium-237 contributing 61 percent of the total annual individual dose,

plutonium-242 contributing 13 percent, actinium-227 contributing 5 percent, thorium-229 and uranium-234 each contributing 3 percent, and uranium-233, lead-210, and radium-226 each contributing 2 percent. The plutonium isotopes contributing to dose would be due to colloidal transport of plutonium, not transport of plutonium as a dissolved element in groundwater.

With respect to the groundwater protection standards in 40 CFR 197.30, both the mean and 95th-percentile estimated levels during the 10,000-year regulatory period would be hundreds of thousands of times less than the regulatory limits (see Table 5-9).

Table 5-9. Comparison of nominal scenario long-term consequences at the RMEI location^a to groundwater protection standards during 10,000 years following repository closure for the higher-temperature repository operating mode.

Radionuclide or type of radiation emitted	EPA limit ^b	Mean peak ^c	95 th -percentile peak ^d
Combined radium-226 and radium-228 ^e (picocuries per liter)	5	1.0 (1×10^{-11}) ^f	1.0 (2×10^{-11}) ^f
Gross alpha activity (including radium-226 but excluding radon and uranium) ^e (picocuries per liter)	15	0.4 (2×10^{-8}) ^f	0.4 (1×10^{-8}) ^f
Combined beta- and photon-emitting radionuclides, ^g millirem per year to the whole body or any organ, ^h based on drinking 2 liters ⁱ of water per day from the representative volume	4	2×10^{-5}	1×10^{-4}

- a. The RMEI location is approximately 18 kilometers (11 miles) downgradient from the repository.
- b. Environmental Protection Agency limits at 40 CFR 197.30.
- c. Based on 300 simulations of total system performance, each using random samples of uncertain parameters.
- d. Represents a value for which 285 out of the 300 simulations yielded a smaller value.
- e. Includes natural background radiation.
- f. Value in parentheses is the incremental increase over background radiation that would be attributable to the potential repository.
- g. Does not include natural background radiation.
- h. This represents a bounding (overestimate) of the maximum dose to any organ because the different radionuclides would affect different organs preferentially.
- i. 2 liters = 0.53 gallon.

5.4.2.2 Waterborne Radiological Results for the Lower-Temperature Repository Operating Mode

DOE conducted performance studies for the lower-temperature repository operating mode. This section discusses groundwater impacts for the lower-temperature operating mode. The performance analysis indicated that for the first 10,000 years there would be very limited releases, attributable to early waste package failures due to waste package manufacturing defects, with very small radiological consequences (see Table 5-10). For the first 10,000 years after repository closure, the mean peak would be 0.00001 millirem and the 95th-percentile peak would be 0.0001 millirem. The peaks would be even smaller at greater distances. This result was compared to the EPA standard, which allows up to a 15-millirem annual individual dose during the first 10,000 years.

Table 5-11 lists the population consequences associated with the peak annual individual dose listed in Table 5-10. The population size was based on the population numbers projected for the year 2035 in Figure 3-25 in Chapter 3 of this EIS. For these calculations, the analysis assumed that no contaminated groundwater would reach populations in any regions to the north of Yucca Mountain. Therefore, populations in the sectors north of the due east and due west sectors in Figure 3-25 were not considered to be exposed.

Table 5-10. Impacts for an individual from groundwater releases of radionuclides during 10,000 years after repository closure for the lower-temperature repository operating mode.

Individual	Mean			95th-percentile		
	Peak annual individual dose (millirem)	Time of peak (years)	Probability of an LCF ^a	Peak annual individual dose (millirem)	Time of peak (years)	Probability of an LCF ^a
At RMEI location ^b	0.00001 ^c	3,400	4×10^{-10}	0.0001 ^d	5,000	3×10^{-9}
At 30 kilometers ^e	~0 ^f	NC ^g	~0	~0 ^f	NC	~0
At discharge location ^h	~0 ^f	NC	~0	~0 ^f	NC	~0

- a. LCF = latent cancer fatality; incremental lifetime (70 years) risk of contracting a fatal cancer for individuals, assuming a risk of 0.0005 latent cancer per rem for members of the public (DIRS 101856-NCRP 1993, p. 31).
- b. The RMEI location is approximately 18 kilometers (11 miles) downgradient from the repository. The maximum allowable peak of the mean annual individual dose for 10,000 years at this location is 15 millirem.
- c. Based on 300 simulations of total system performance, each using random samples of uncertain parameters.
- d. Represents a value for which 285 out of the 300 simulations yielded a smaller value.
- e. 30 kilometers = 19 miles.
- f. Values would be lower than the small values computed for the RMEI location.
- g. NC = not calculated (peak time would be greater than time given for the RMEI location).
- h. 60 kilometers (37 miles) at Franklin Lake Playa.

Table 5-11. Population impacts from groundwater releases of radionuclides during 10,000 years after repository closure for the lower-temperature repository operating mode.

Impact	Mean		95th-percentile	
	Population dose (person-rem)	Population LCF ^a	Population dose (person-rem)	Population LCF ^c
Peak 70-year lifetime	0.004	0.000002	0.03	0.00002
Integrated over 10,000 years	0.3	0.0002	0.4	0.0002

- a. LCF = latent cancer fatality; expected number of cancer fatalities for populations, assuming a risk of 0.0005 latent cancer per rem for members of the public (DIRS 101856-NCRP 1993, p. 31).

- 47 people would be exposed at the RMEI location (includes sectors from 12 to 28 kilometers)
- 4,200 people would be exposed at about 30 kilometers (19 miles) downgradient from the potential repository (includes sectors from 28 to 44 kilometers)
- 69,500 people would be exposed at the discharge location about 60 kilometers (37 miles) downgradient from the potential repository (includes sectors from 44 to 80 kilometers)

Thus, approximately 74,000 people would be exposed to contaminated groundwater. This stylized population dose analysis assumed that people would continue to live in the locations being used at present. This assumption is consistent with the recommendation made by the National Academy of Sciences (DIRS 100018-National Research Council 1995, all) because it is impossible to make accurate predictions of lifestyles and residence locations far into the future.

The values in Table 5-11 include a scaling factor for water use. The performance assessment transport model calculated the annual individual dose assuming the radionuclides dissolved in water that flowed through the unsaturated zone of Yucca Mountain would mix in an average of 2.4 million cubic meters (1,940 acre-feet) (DIRS 155950-BSC 2001, p. 13-42) per year in the saturated zone aquifer. This compares to an annual water use in the Amargosa Valley of about 17.1 million cubic meters (13,900 acre-feet) (DIRS 155950-BSC 2001, p. 13-42). The analysis diluted the concentration of the nuclides in the 2.4 million cubic meters of water throughout the 17.1 million cubic meters of water before calculating the population dose.

The small consequences listed in Tables 5-10 and 5-11 would result from the durability of the waste packages; most of which would remain intact significantly longer than 10,000 years. The outer layer of the waste package would be subject to a very low average corrosion rate, but there is a high degree of uncertainty in the value of that average corrosion rate. Model simulations incorporated a small number of waste package failures within 10,000 years due to manufacturing defects; the dose results in Table 5-10 and 5-11 during this period would result directly from these early failures.

The radionuclides that would contribute the most to individual dose in 10,000 years would be technetium-99, carbon-14 dissolved in groundwater, and iodine-129. For example, the mean consequence at 18 kilometers (11 miles) has technetium-99 contributing 63 percent of the total individual dose rate, carbon-14 contributing 25 percent, and iodine-129 contributing 10 percent. While the atmospheric analysis in this EIS assumed that 2 percent of the carbon-14 migrated as gas in the form of carbon dioxide (see Section 5.5 for more details), the groundwater modeling for this waterborne radiological consequences analysis conservatively assumed that all of the carbon-14 migrated in the groundwater.

Table 5-12 lists impacts for the post-10,000-year period as peak annual doses. The table lists the mean and 95th-percentile peak annual individual dose and the times of the associated peaks at three locations. The mean and 95th-percentile annual individual doses during 1 million years following repository closure are shown in Figure 5-5. The multiple peaks occurring 200,000 years or more after repository closure are driven by transitions between climate states.

Table 5-12. Impacts for an individual from groundwater releases of radionuclides during 1 million years after repository closure for the lower-temperature repository operating mode.

Individual	Mean		95th-percentile	
	Peak annual individual dose (millirem)	Time of peak (years)	Peak annual individual dose (millirem)	Time of peak (years)
At RMEI location ^a	120 ^b	480,000	510 ^c	410,000
At 30 kilometers ^d	83 ^e	NC ^f	350 ^e	NC
At discharge location ^g	48 ^e	NC	240 ^e	NC

- a. The RMEI location is approximately 18 kilometers (11 miles) downgradient from the repository.
- b. Based on 300 simulations of total system performance, each using random samples of uncertain parameters.
- c. Represents a value for which 285 out of the 300 simulations yielded a smaller value.
- d. 30 kilometers = 19 miles.
- e. Estimated using scale factors as described in Section 5.4.1.
- f. NC = not calculated (peak time would be greater than time given for the RMEI location).
- g. 60 kilometers (37 miles) at Franklin Lake Playa.

The simulations were ended after 1 million years largely because further radioactive decay would continue to decrease annual individual dose even for very long-lived radionuclides. The peak annual individual dose usually coincided with the occurrence of a wetter climate period.

The radionuclides that would contribute the most to the peak annual individual dose in 1 million years would be neptunium-237 and plutonium-242. The mean peak dose at 18 kilometers (11 miles) would have neptunium-237 contributing 63 percent of the total individual dose rate, plutonium-242 contributing 12 percent, actinium-227 contributing 5 percent, thorium-229 and uranium-234 each contributing 3 percent, and uranium-233, lead-210, and radium-226 each contributing 2 percent. The plutonium isotopes contributing to dose would be due to colloidal transport of plutonium, not transport of plutonium as a dissolved element in groundwater.

With respect to the groundwater protection standards in 40 CFR 197.30, both the mean and 95th-percentile estimated levels during the 10,000-year regulatory period would be hundreds of thousands of times less than the regulatory limits (see Table 5-13).

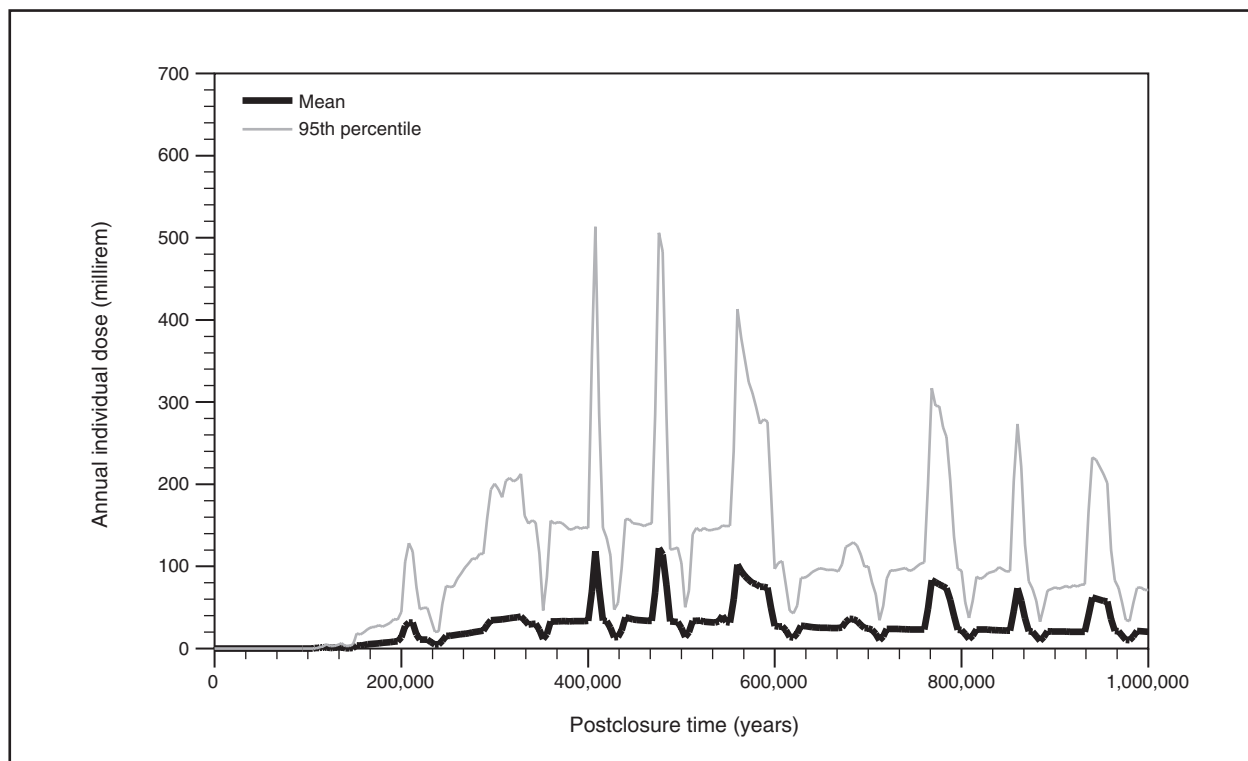

Figure 5-5. Mean and 95th-percentile (based on 300 simulations of total system performance, each using random samples of uncertain parameters) annual individual dose at the RMEI location during 1 million years after repository closure for the nominal scenario under the lower-temperature repository operating mode.

Table 5-13. Comparison of nominal scenario long-term consequences at the RMEI location^a to groundwater protection standards during 10,000 years following repository closure for the lower-temperature repository operating mode.

Radionuclide or type of radiation emitted	EPA limit ^b	Mean peak ^c	95 th -percentile peak ^d
Combined radium-226 and radium-228 ^e (picocuries per year)	5	1 (2×10^{-12}) ^f	1 (1×10^{-11}) ^f
Gross alpha activity (including radium-226 but excluding radon and uranium) ^e (picocuries per year)	15	0.4 (3×10^{-8}) ^f	0.4 (2×10^{-8}) ^f
Combined beta- and photon-emitting radionuclides, ^g millirem per year to the whole body or any organ, ^h based on drinking 2 liters ⁱ of water per day from the representative volume	4	1×10^{-5}	7×10^{-5}

- a. The RMEI location is approximately 18 kilometers (11 miles) downgradient from the repository.
- b. Environmental Protection Agency limits set forth in 40 CFR 197.30.
- c. Based on 300 simulations of total system performance, each using random samples of uncertain parameters.
- d. Represents a value for which 285 out of the 300 simulations yielded a smaller value.
- e. Includes natural background radiation.
- f. Value in parentheses is the incremental increase over background radiation that would be attributable to the potential repository.
- g. Does not include natural background radiation.
- h. This represents a bounding (overestimate) of the maximum dose to any organ because the different radionuclides would affect different organs preferentially.
- i. 2 liters = 0.53 gallon.

5.4.2.3 Alternative Dosimetry Methods

The long-term postclosure groundwater impacts are estimated using ICRP-30 (DIRS 110386-ICRP 1979, all; DIRS 110351-ICRP 1980, all; DIRS 110352-ICRP 1981, all) domestic methods. It has been suggested by an international peer review that the more recent ICRP-72 methods (DIRS 152446-ICRP 1996, all), as are used internationally for such estimates, would be more appropriate. Sensitivity studies indicate the peak dose estimates would be about a factor of 4 lower if the ICRP-72 analytical methods were applied (DIRS 157151-BSC 2001, Appendix L. pp. L-31 to L-33).

5.5 Atmospheric Radiological Consequences

After DOE closed the repository, there would be limited potential for releases to the atmosphere because the waste would be isolated far below the ground surface. Still, the rock is porous and does allow gas to flow, so the analysis must consider possible airborne releases. The only radionuclide in the analysis after screening with a potential for gas transport is carbon-14 in the form of carbon dioxide. Iodine-129 can exist in a gas phase, but DOE expects it would dissolve in the groundwater rather than migrate as a gas. The solubility of iodine-129 is a great deal higher than that of carbon dioxide, and the water is already saturated in carbon dioxide because of interaction with carbonate rocks. After the carbon-14 escaped as carbon dioxide from the waste package, it would flow through the rock. About 2 percent of the carbon-14 in commercial spent nuclear fuel is in a gas phase in the space (or gap) between the fuel and the cladding around the fuel (DIRS 103446-Oversby 1987, p. 92). The atmospheric model used a gas-phase inventory of 0.122 curie of carbon-14 per waste package of commercial spent nuclear fuel at the time of emplacement. The atmospheric model estimated human health impacts for the population in the 80-kilometer (50-mile) region surrounding the repository.

In addition, DOE considered the possible impacts from the release of radon from the repository. Radon is a decay product of uranium and would be generated for as long as any uranium remained in the repository. Based on gas flow studies, DOE believes that radon would decay before it reached the ground surface. Appendix I, Section I.7.3, contains a more detailed screening discussion.

5.5.1 SOURCE TERM

The calculation of regional doses used an estimate of the annual release rate of carbon-14. The analysis based the carbon-14 release rate on the estimated time line of waste package container failures for the higher-temperature repository operating mode nominal scenario. If the same analysis were performed using waste package failures for the lower-temperature operating mode, the results would be nearly the same with slightly lower impacts. The expected number of commercial spent nuclear fuel waste package failures as a function of time was used to estimate the carbon-14 release rates after repository closure. The amount of material released from each package as a function of time was reduced to account for radioactive decay. As for the waterborne releases described in Section 5.4.1, credit was taken for the intact zirconium alloy cladding (on approximately 99 percent by volume of the spent nuclear fuel at emplacement) delaying the release of gas-phase carbon-14 (DIRS 153849-DOE 2001, p. 3-7). The remaining 1 percent by volume of the spent nuclear fuel either would have stainless-steel cladding (which degrades much more quickly than zirconium alloy) or would already have failed in the reactor. Thus, gas-phase releases from this fuel would have occurred before it was shipped to the repository. The maximum annual-release rate would occur about 1,700 years after repository closure, and the estimated maximum release rate would be 3.3 microcuries per year of carbon-14.

5.5.2 ATMOSPHERIC CONSEQUENCES TO THE LOCAL POPULATION

DOE used the *GENII* program (DIRS 100953-Napier et al. 1988, all) to model the atmospheric transport and human uptake of the released carbon-14 for the 80-kilometer (50-mile) population dose calculation.

Doses to the regional population around Yucca Mountain from carbon-14 releases were estimated using the population distribution shown in Chapter 3, Figure 3-25, which indicates that 76,000 people would live in the region surrounding Yucca Mountain in 2035. The computation also used current (1993 to 1996) annual average meteorology (see Appendix I, Table I-33). GENII calculated a dose factor of 4.6×10^{-9} person-rem per microcurie per year of release. For a 3.3-microcurie-per-year release, this corresponds to a maximum 80-kilometer annual population dose of 1.5×10^{-8} person-rem. This dose corresponds to 7.5×10^{-12} latent cancer fatality in the regional population of 76,000 persons during each year at the maximum carbon-14 release rate. This annual population radiological dose corresponds to a 70-year lifetime radiological population dose of 1.1×10^{-6} person-rem, which corresponds to 5.3×10^{-10} latent cancer fatality during the 70-year period of the maximum release.

5.5.3 ATMOSPHERIC CONSEQUENCES TO AN INDIVIDUAL

For a constant-sized population living only at the locations in the population distribution shown in Chapter 3, Figure 3-25, a maximally exposed individual for airborne releases would reside 24 kilometers (15 miles) south of the repository. The location for maximum dose is dependent on wind speed and wind direction, and is only considered for those locations where people currently reside (it was not a predetermined location). An individual radiological dose factor of 5.6×10^{-14} rem per microcurie per year of release was calculated using the GENII code for this location. For a 3.3-microcurie-per-year maximum release rate, the individual maximum radiological dose rate would be 1.8×10^{-13} rem per year, corresponding to a 9.2×10^{-17} probability of a latent cancer fatality. The 70-year lifetime dose would be 1.3×10^{-11} rem, representing a 6.4×10^{-15} probability of a latent cancer fatality.

5.6 Consequences from Chemically Toxic Materials

A number of nonradioactive materials that DOE would place in the repository will degrade over time into materials that are hazardous to human health at high concentrations in water. This section examines the consequences to individuals in the Amargosa Desert from releases of these nonradioactive materials.

Appendix I, Section I.3 discusses the inventory of chemically toxic materials that would be emplaced in the repository under the Proposed Action by element. Based on this inventory, a screening analysis (described in Appendix I, Section I.6.1) identified which of the chemically toxic materials could pose a potential risk to human health. Chromium, molybdenum, nickel, and vanadium were identified as posing such a potential risk, and these elements were further evaluated in a bounding consequence analysis, as described in Appendix I, Section I.6.2. This analysis makes the conservative assumption that all chromium dissolves in hexavalent form.

It should also be noted that all of the chromium, molybdenum, nickel, and vanadium considered are elements contained in the metals used to package the waste and support the packages. None of the materials inside the waste packages were considered because, except for about three packages, all packages would last for more than 50,000 years.

Table 5-14 summarizes the results of the bounding analysis. In some cases a Maximum Contaminant Level or Maximum Contaminant Level Goal was available for comparison to the calculated concentration. In other cases, only an Oral Reference Dose was available. The Oral Reference Dose can be compared to the intake that would result for a 70-kilogram (154-pound) person drinking 2 liters (0.53 gallon) of water per day.

The bounding consequence analysis estimated that the maximum peak concentration of chromium in groundwater used at exposure locations would be 0.01 milligram per liter. There are two measures for comparing human health effects for chromium. When the Environmental Protection Agency established its Maximum Contaminant Level Goals, it considered safe levels of contaminants in drinking water and

Table 5-14. Consequences from waterborne chemically toxic materials release during 10,000 years after repository closure estimated using a bounding calculation.

Material	Concentration in well water (milligram per liter)	Maximum Contaminant Level Goal ^a (milligram per liter)	Intake rate for a 70-kilogram person (milligram per kilogram per day)	Oral Reference Dose (milligram per kilogram per day)
Chromium (VI)	0.01	0.1	0.0004	0.005 ^b
Molybdenum	0.009	NA ^c	0.0003	0.005 ^d
Nickel	0.04	NA	0.001	0.02 ^e
Vanadium	0.0002	NA	0.000006	0.007 ^f

- a. 40 CFR 141.51.
- b. DIRS 148224-EPA (1999, all).
- c. NA = not available.
- d. DIRS 148228-EPA (1999, all).
- e. DIRS 148229-EPA (1999, all).
- f. DIRS 103705-EPA (1997, all).

the ability to achieve these levels with the best available technology. The Maximum Contaminant Level Goal for chromium is 0.1 milligram per liter (40 CFR 141.51). The bounding concentration is well below the Maximum Contaminant Level Goal for chromium (about one-tenth of this limit). The other measure for comparison is the reference dose factor for chromium, which is an intake of 0.0004 milligram of chromium per kilogram of body mass per day (DIRS 148224-EPA 1999, all). The reference dose factor represents a level of intake that has no adverse effect on humans. It can be converted to a threshold concentration level for drinking water. The conversion yields essentially the same concentration for the reference dose factor as the Maximum Contaminant Level Goal. At present, the bounding estimate of groundwater concentration of hexavalent chromium cannot be expressed in terms of human health effects (for example, latent cancer fatalities). The carcinogenicity of hexavalent chromium by the oral route of exposure has not been determined because of a lack of sufficient epidemiological or toxicological data (DIRS 148224-EPA 1999, all; DIRS 101825-EPA 1998, p. 48).

The estimated bounding concentration of molybdenum in groundwater used at exposure locations would be 0.009 milligram per liter. There is no Maximum Contaminant Level Goal for molybdenum but intake can be compared to the Oral Reference Dose. The intake rate from drinking 2 liters (0.53 gallon) per day of contaminated water by a 70-kilogram (154-pound) person would be 0.0003 milligram per kilogram per day. This is well below the Oral Reference Dose of 0.005 milligram per kilogram per day (DIRS 148228-EPA 1999, all).

The estimated bounding concentration of nickel in groundwater used at exposure locations would be 0.04 milligram per liter. There is no Maximum Contaminant Level Goal available for nickel but intake can be compared against the Oral Reference Dose. The intake rate from drinking 2 liters (0.53 gallon) per day of contaminated water by a 70-kilogram (154-pound) person would be 0.001 milligram per kilogram per day. This is well below the Oral Reference Dose of 0.02 milligram per kilogram per day.

The estimated bounding concentration of vanadium in groundwater used at exposure locations would be 0.0002 milligram per liter. There is no Maximum Contaminant Level Goal available for vanadium, but intake can be compared to the Oral Reference Dose. The intake rate from drinking 2 liters (0.53 gallon) per day of contaminated water by a 70-kilogram (154-pound) person would be 0.000006 milligram per kilogram per day. This is well below the Oral Reference Dose of 0.007 milligram per kilogram per day.

Because the estimated bounding concentrations of chromium, molybdenum, nickel and vanadium in well water would be below the Maximum Contaminant Level Goal or yield intakes well below the Oral Reference Dose, there is no further need to refine the calculation to account for physical processes that would limit mobilization of those materials or delay and dilute them during transport in the geosphere.

5.7 Consequences from Disruptive Events

The postclosure performance estimates discussed in Sections 5.4, 5.5, and 5.6 include the possible effects of changing climate and seismic events but do not address other events that could physically disturb the repository. In general, disruptive events have identifiable starting and ending times, in contrast to continuous processes such as corrosion. The disruptive events examined in this section are an *inadvertent intrusion* into the repository by a drilling crew and basaltic igneous (volcanic) activity.

5.7.1 HUMAN INTRUSION SCENARIO

DOE examined the consequences of a human intrusion scenario involving inadvertent drilling.

The human intrusion scenario analyzed in this EIS is consistent with the requirements of 40 CFR Part 197. The stylized human intrusion scenario is summarized as follows:

- The human intrusion would occur 30,000 years after permanent repository closure when there was enough degradation in waste packages that the driller might not detect the penetration.
- The intrusion would result in a single, nearly vertical borehole that penetrated a waste package and extended down to the saturated zone.
- Current practices for resource exploration would be used to establish properties (e.g., borehole diameter, drilling fluid composition).
- The borehole would not be adequately sealed and would permit infiltrating water and natural degradation processes to modify the borehole gradually.
- Only releases through the borehole to the saturated zone were considered; hazards to the drillers or to the public from material brought to the surface by the assumed intrusion were not included.

The human intrusion results were calculated probabilistically, analogous to the nominal scenario calculations for waterborne radioactive material releases. The calculations were carried out for the higher-temperature repository operating mode. For this stylized intrusion scenario, there would be no difference for the lower-temperature operating mode because exactly one waste package is intersected for both operating modes and its inventory is moved to the saturated zone where further transport does not depend on repository operating mode. Figure 5-6 shows the mean and 95th-percentile annual individual dose for 1 million years resulting from a human intrusion 30,000 years after repository closure for the set of 300 simulations. The values in Figure 5-6 represent the dose from a single waste package, and are not combined with releases for other waste packages that would fail due to other processes. The peak of the mean annual individual dose from human intrusion would be 0.002 millirem, occurring a short time after 100,000 years after repository closure. These results indicate that the repository would be sufficiently robust and resilient to limit releases caused by human intrusion to values well below the 15-millirem annual individual dose standard.

The analysis did not combine the results of the disruptive igneous event scenario with the results of the human intrusion scenario. However, combined results can be approximated by adding the results of the human intrusion analysis to that of the disruptive igneous event scenario, which would result in a total combined maximum dose. Based on the results presented in this section and Section 5.7.2, the highest mean annual individual dose that would result from an intrusion would be less than one-tenth of the radiological dose from a disruptive igneous event.

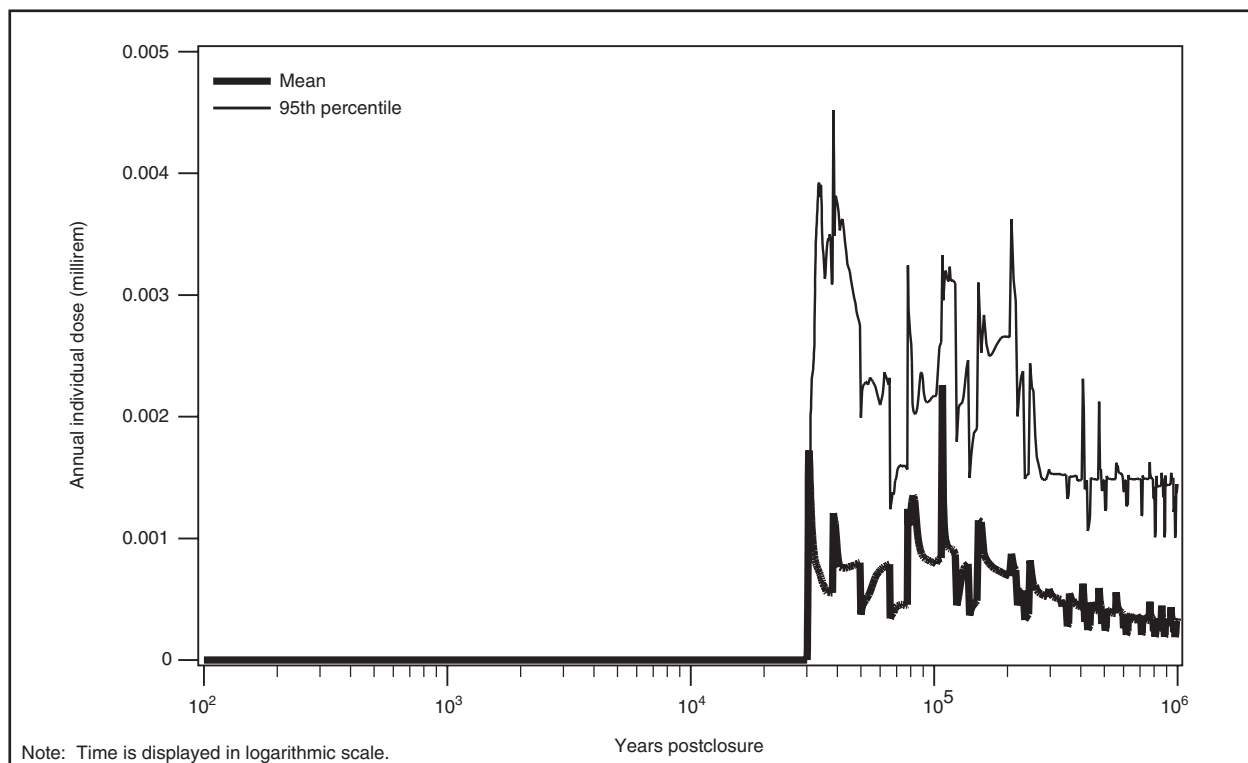

Figure 5-6. Mean and 95th-percentile annual individual dose at the RMEI location resulting from human intrusion 30,000 years after repository closure under the higher-temperature repository operating mode.

A sensitivity study where the human intrusion occurs at 100 years after repository closure has also been conducted (DIRS 157307-BSC 2001, Enclosure 1).

5.7.2 IGNEOUS ACTIVITY SCENARIO

The analysis of igneous activity utilized a model for volcanic eruptions that would intersect drifts and bring waste to the surface, and a model for igneous intrusions that would damage waste packages, thereby exposing radionuclides to groundwater for transport.

5.7.2.1 Volcanic Eruption Events

The conceptualization of a volcanic eruption at Yucca Mountain envisioned an igneous dike that would rise through the Earth's crust and intersect one or more repository drifts. An eruptive conduit could form somewhere along the dike as it neared the land surface, feeding a volcano at the surface. Waste packages in the direct path of the conduit would be destroyed, and the waste in those packages would subsequently be entrained in the eruption. Volcanic ash would be contaminated, erupted, and transported by wind. Ash would settle out of the plume as it was transported downwind, resulting in an ash layer on the land surface. Members of the public would then receive a radiation dose from exposure pathways associated with the contaminated ash layer.

Model development included the selection of conservative assumptions about the event, selection of input parameter distributions characterizing important physical properties of the system, and use of a computational model to calculate entrainment of waste in the erupting ash. Each intrusive event (a swarm of one or more dikes) was assumed to generate one or more volcanoes somewhere along its length, but eruptions would not need to occur within the repository footprint. Approximately 77 percent of intrusive events that intersected the repository would be associated with one or more surface eruptions within the

repository footprint. The number of eruptive conduits (volcanoes) is independent of the number of dikes in a swarm. Characteristics of the eruption such as eruptive power, style (violent versus normal), velocity, duration, column height, and total volume of erupted material, are included in the analysis.

5.7.2.2 Groundwater Transport of Radionuclides Following Igneous Intrusion Event

The conceptualization of radionuclide release and transport away from waste packages damaged by an igneous intrusion that intersected the repository is similar to the nominal model for radionuclide release and transport (discussed in Section 5.4), but was modified to include the intrusion. The igneous intrusion groundwater transport model includes a set of input parameters to define a modified source term for use in the nominal scenario flow and transport model. There are three main components to the model: the behavior of the waste packages and other engineered barrier system elements damaged because of their proximity to an igneous intrusion; groundwater flow and radionuclide transport away from the waste packages; and calculation of the number of waste packages damaged as a result of the igneous intrusion.

The analysis assumed that waste packages close to the point of intrusion would be so damaged that they would provide no further protection for the waste. Actual conditions would be uncertain, and damage probably would range from moderate to extensive. Nominal models for radionuclide mobilization and transport were used even though conditions would change in the drift following intrusion. All waste in the most severely damaged packages would be immediately available for transport in the unsaturated zone, depending on solubility limits and the availability of water, which was determined using the seepage model for nominal performance. The thermal, chemical, and mechanical effects of the intrusion on the drift environment were neglected. No credit was taken for water diversion by the remnants of the drip shield or waste package, and cladding was assumed to be fully degraded. Actual thermal, chemical, hydrological, and mechanical conditions in the drift following igneous intrusion are unknown, although conservatively assuming that the engineered barriers would have completely failed is sufficient to compensate for the uncertainty associated with conditions in the drift.

5.7.2.3 Results for Igneous Activity Scenario

The approach taken to calculate doses resulting from the igneous activity scenario is consistent with the probabilistic methodology described in Nuclear Regulatory Commission guidance (DIRS 103760-NRC 1998, all; DIRS 119693-Reamer 1999; all). Scenario consequences are multiplied (“weighted”) by the probability of occurrence of the scenario to yield an appropriate estimate of the overall risk posed by low-probability events. The probability of igneous activity is extremely low (the mean annual probability is 1.6×10^{-8}), and the probability of more than one igneous disruption occurring during the next 100,000 years is far below the level of concern. Therefore, the analysis considered only a single igneous eruption within the repository during the next 100,000 years, occurring with a mean 100,000-year probability of 1.6×10^{-3} . The year in which that eruption could occur is uncertain; therefore, the igneous eruption scenario was evaluated as if it were many different eruptive scenarios, each occurring in a different 25-year time interval, and each occurring with a probability 25 times that of the annual probability. The average dose resulting from igneous disruption was determined by calculating doses resulting from igneous events in each 25-year period, multiplying by the probability (mean 25-year probability of 4.0×10^{-7}), and adding the doses from each *disruptive event*. For computational efficiency, igneous intrusions that would not result in a surface eruption were simulated using a simpler approach in which the time of intrusion was sampled randomly from the 100,000-year period, and the probability associated with each simulation is the full 100,000-year probability of 1.6×10^{-3} . Probability-weighted doses from both eruptive and intrusive events were added together to give the total dose from igneous disruption.

The average doses from igneous activity calculated in this manner incorporate uncertainties regarding the time at which the igneous event could occur, and account for the reality that, as time passed, the likelihood would increase that igneous disruptions could have already occurred. For example, a person

living downwind from Yucca Mountain 10,000 years after repository closure would have a mean probability of 1.6×10^{-4} of receiving a radiation dose from soil contaminated by an igneous event sometime in the past. The probability-weighted average dose emphasizes the overall risk to a person living downwind from Yucca Mountain, in terms of both the likelihood and consequences of the igneous activity scenario.

Figure 5-7 shows the mean probability-weighted dose histories representing possible doses to an individual for the higher-temperature repository operating mode. The figure also shows the nominal scenario for comparison. The igneous activity scenario is only simulated to 100,000 years because the nominal scenario impacts dominate after that time. These summary curves are based on 5,000 individual dose histories calculated using different sets of uncertain input parameters in the model. For approximately the first 20,000 years, the dose history is a smooth curve that is dominated by the effects of volcanic eruption. The probability-weighted mean annual individual dose during this period would reach a peak of approximately 0.1 millirem about 300 years after repository closure, and then decline because of radioactive decay of the relatively shorter-lived radionuclides that contributed to doses from the ash fall exposure pathway. The major contributors to the eruptive dose would be americium-241, plutonium-238, plutonium-239, and plutonium-240. Strontium-90 would be a significant contributor at extremely early times, but would drop off rapidly because of radioactive decay (*half-life* of 29.1 years). Inhalation of resuspended particles in the ash layer would be the primary exposure pathway during this period, and the smooth decline of the mean dose curve from approximately 300 to 2,000 years would result from decay of americium-241 (*half-life* of 432 years). From approximately 20,000 years after closure, the mean igneous dose would be dominated by groundwater releases from packages damaged by igneous intrusions that did not erupt to the surface. The irregular shape of the curve from this point forward is in part a result of the groundwater transport processes, and in part reflects the occurrence of intrusive events at random times, rather than the prescribed intervals used for extrusive simulations. The intrusive event could occur at any time, and the first appearance of groundwater doses in the mean curve at approximately 20,000 years reflects retardation during transport, rather than the absence of intrusions at earlier times. Results for the lower-temperature operating mode would be essentially identical to those for the higher-temperature mode because the probability of an igneous intrusion interacting with waste packages is reduced for the wider waste package spacing. However, the overall probability of an igneous intrusion intersecting the potential repository would increase because of a larger repository emplacement area.

The dose history for the igneous activity scenario in Figure 5-7 is presented as a probability-weighted annual dose resulting from events occurring at uncertain times throughout the period of simulation. This approach to calculating and displaying the probability-weighted annual doses is consistent with the approach specified by 40 CFR Part 197 and is required for determination of the overall expected annual dose. However, displays of the probability-weighted annual dose do not allow direct interpretation of the conditional annual dose, which is the annual dose an individual would receive if a volcanic event occurred at a specified time. For conditional analyses, the probability of the event is set equal to one, and the time of the event is specified. Conditional results do not provide a meaningful estimate of the overall risk associated with igneous activity at Yucca Mountain, but they provide insights into the magnitude of possible consequences for specific sets of assumptions. A sensitivity calculation was performed to provide results for this conditional case (DIRS 154659-BSC 2001, pp. 3-47 to 3-48). Conditional mean annual dose histories were calculated for eruptive events at 100, 500, 1,000, and 5,000 years. The conditional mean dose in the first year after an eruptive event at 100 years after repository closure is approximately 13 rem. The conditional dose in the first year after an eruption decreases to approximately one-half this level for an eruption 500 years after closure, and is approximately 10 percent of this value for an eruption 5,000 years after closure. This calculation was made with a previous TSPA model (DIRS 153246-CRWMS M&O 2000, all) that has some differences from the model used elsewhere in this EIS for long-term performance (DIRS 157307-BSC 2001, Enclosure 1). The differences that affect the analysis described above are that dose factors were revised to conform to 40 CFR Part 197 and the

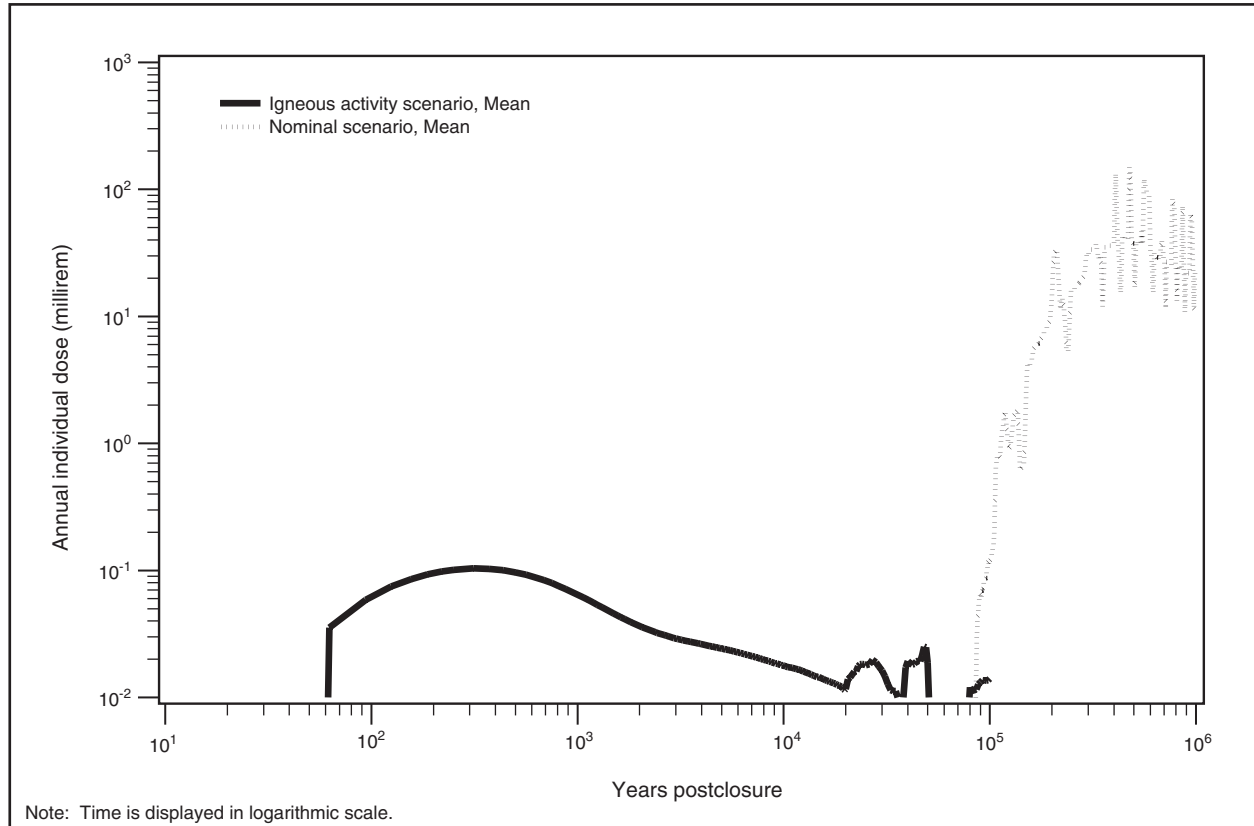

Figure 5-7. Mean (based on 5,000 simulations of total system performance, each using random samples of uncertain parameters) annual individual dose at the RMEI location resulting from igneous disruptions under the higher-temperature repository operating mode, with the mean dose history at this location for the higher-temperature operating mode nominal scenario.

distance analyzed is 20 kilometers rather than 18 kilometers from the repository. These changes would be expected to increase the dose values at 100 years and 500 years by a factor of between 2 and 3. The results at the later times would increase by about 20 percent.

5.8 Nuclear Criticality

This section examines the probability of isolated nuclear criticality events in waste packages and in surrounding rock. A short tutorial on the physics of nuclear criticality and the associated conditions that can cause such an event is provided in the Science and Engineering Report (DIRS 153849-DOE 2001, pp. 4-406 to 4-409). The tutorial provided in the Science and Engineering Report identifies the required conditions for nuclear criticality at the proposed repository. One of the required conditions for nuclear criticality is the presence of a moderator such as liquid water. Liquid water could only be introduced into the waste package if the waste package failed. The following information is excerpted from the Yucca Mountain Science and Engineering Report (DIRS 153849-DOE 2001, pp. 4-412 to 4-416).

5.8.1 PROBABILITY OF INTERNAL CRITICALITY FOR COMMERCIAL SPENT NUCLEAR FUEL

Actually, there is a very low probability that any liquid water would enter a specific package; thus, the probability estimated here is very conservative. Each package would contain a neutron absorber that would have the important function of capturing neutrons and helping to prevent a criticality. The

conditions of waste package failure and entrance of liquid water are required for internal criticality. The probability of these conditions occurring would be very small. The probability of the loss of neutron absorber would increase with time after 10,000 years. As the internal components of a waste package degraded, the assemblies in the package would collapse reducing the spacing between the fuel rods. This would reduce the probability of criticality because of the reduced volume between fuel rods available for the moderator to fill. Another factor tending to reduce the probability of criticality with time would be the eventual breach of the bottom of the waste package, which would drain most of the water in the waste package that acted as a moderator. The potential for criticality of commercial spent nuclear fuel would be maximized when the internal basket was fully degraded, but with the assemblies remaining intact and no breach of the bottom of the waste package. Under these circumstances, the calculated probability of a critical event within the total inventory of the 21-PWR Absorber Plate waste packages would be less than 2×10^{-7} in 10,000 years (after closure of the repository). The 21-PWR Absorber Plate waste package was chosen for criticality calculations because it is the design for fuel with the highest reactivity and thus would be expected to have the highest probability of criticality.

5.8.2 PROBABILITY OF INTERNAL CRITICALITY FOR CODISPOSED DOE SPENT NUCLEAR FUEL AND HIGH-LEVEL RADIOACTIVE WASTE

Actually, there is a very low probability that any liquid water would enter a specific package; thus, the probability estimated here is very conservative. Evaluations have been performed of the criticality potential of waste packages that would contain high-level radioactive waste glass and certain types of codisposed DOE spent nuclear fuel. The probability of criticality for these fuel types would generally be less than the small value of 2×10^{-7} for commercial spent nuclear fuel. The primary reasons are the lower fissile loading per waste package and the greater flexibility to install neutron absorber due to smaller fuel mass per waste package.

5.8.3 PROBABILITY OF CRITICALITY FOR THE IMMOBILIZED PLUTONIUM WASTE FORM

Actually, there is a very low probability that any liquid water would enter a specific package; thus, the probability estimated here is very conservative. The design of the immobilized plutonium waste form makes criticality virtually impossible. The degradation rate of the ceramic waste form would be so slow that, in the unlikely event that the waste package was breached and filled by a continuous dripping of water, it would be nearly 50,000 years after emplacement before enough of this waste form had degraded to permit any significant separation of the uranium and plutonium from the gadolinium and hafnium neutron absorbers. Even after degradation of the waste form, the gadolinium and hafnium are generally less soluble than the fissile material, so they would not be transported out of the waste package while the fissile material remains. Even if extremely unlikely chemistry conditions occurred that would make the gadolinium sufficiently soluble to be removed before the fissile material, enough of the completely insoluble hafnium would remain to prevent criticality.

5.8.4 PROBABILITY OF EXTERNAL CRITICALITY

Calculation of the probability of external criticality starts with the assumption that the waste package fails and liquid water has entered the waste package. Actually, there is a very low probability that any liquid water would enter a specific package; thus, the probability estimated here is very conservative. The probability of an external criticality event in either the repository or the rock beneath it is less than 4×10^{-12} in 10,000 years following repository closure. This low probability is primarily a result of the following Yucca Mountain characteristics: (1) limited dripping water to transport enough fissile material out of the waste package and into a geometry favorable for criticality; (2) a limited number of regions in the rock below the drifts to allow for fissile material accumulation in a geometry favorable for criticality; (3) a low concentration of fissile material in the water exiting out of a breached waste package due to low

waste form solubility; and (4) lack of a chemical means to accumulate fissile materials and lack of a reducing environment to encourage precipitation.

5.8.5 EFFECT OF A STEADY-STATE CRITICALITY ON RADIONUCLIDE INVENTORY

If a steady-state criticality was to occur, it would be very unlikely to have a power level greater than 5 kilowatts. The power level would be limited because higher power, and thus higher temperatures, would evaporate the water that served as a moderator. An extremely conservative assumption would be that the criticality could endure for 10,000 years, which is the average period of a climate cycle that might have a high enough rainfall or drip rate to sustain the required level of water moderation against evaporation. For a typical commercial spent nuclear fuel waste package, a steady-state criticality would result in an increase of the inventory of certain radionuclides in that waste package. For the very conservative duration of 10,000 years, this increase would be less than 30 percent for the radionuclides in that package. The incremental impact of steady-state criticality events on the total inventory for the repository has been evaluated and is expected to be insignificant.

5.8.6 TRANSIENT CRITICALITY CONSEQUENCES

In the unlikely event that a transient criticality were to occur, a rapid initiating event could produce a peak power level of up to 10 megawatts for less than 60 seconds. After this brief period, rapid boiling of the water moderator would shut down the criticality. The short duration would limit the increase in radionuclide inventory to a factor of 100,000 smaller than that generated by the 10,000-year steady-state criticality. Other consequences of a transient criticality would be a peak temperature of 233°C (451°F) and a peak overpressure of 20 atmospheres. Both conditions would last 10 seconds or less and would not be expected to cause enough damage to the waste package or change its environment enough to have a significant impact on repository performance.

5.8.7 AUTOCATALYTIC CRITICALITY

When a criticality begins, there are several mechanisms that tend to shut it down. For example, the rapid evolution of heat and pressure can expand the fissile material, reducing its density and destroying the critical mass configuration. Evolution of steam can remove water moderator or decrease its effective density. In the case of autocatalytic criticality, there is such a high concentration of fissile material that there is an excess of critical mass and high rates of fission are achieved before any of the shutdown mechanisms occur. The result can be a “runaway” chain reaction, usually resulting in a steam explosion, or in the case of a nuclear bomb, a nuclear explosion. Contrary to popular belief, achieving such a configuration is extremely difficult and requires some very deliberate engineering. An autocatalytic criticality is not credible for the potential repository. Autocatalytic criticality is not possible at all for low-enriched waste forms, nor is it possible for the waste form inside the waste package. Even for highly enriched waste forms, or those containing nearly pure plutonium-239, achieving a critical mass outside a waste package would require the entire fissile content of the waste package to be spread uniformly in a nearly spherical shape, or it would require the extremely unlikely commingling of large amounts of transported fissile material from at least two waste packages containing highly enriched waste forms. Because the igneous rock at Yucca Mountain is unlikely to contain deposits that can efficiently accumulate fissile material, the probability of creating such a critical mass from a single or multiple waste packages containing highly enriched waste forms is so low as to be not credible.

5.8.8 DISRUPTIVE NATURAL EVENTS INFLUENCING CRITICALITY

The potential impact of disruptive natural events, such as seismic activity or igneous intrusion, on the risk of criticality in the repository has been studied. Seismic events could produce a rapid change in the configurations of waste forms and waste packages, potentially creating a critical configuration.

The potential adverse criticality considerations of igneous intrusion into the repository include: (1) the possibility of immediate waste package breach, (2) the separation of a significant fraction of the fissile material from the neutron absorber by magma transport, and (3) the accumulation of a critical mass of fissile material from, or within, the transporting magma. The potential for criticality following igneous intrusion has been evaluated for commercial spent nuclear fuel under extremely conservative assumptions, and no sufficiently probable mechanism for accumulating a critical mass has been identified.

5.9 Consequences to Biological Resources and Soils

DOE has considered whether the proposed repository would affect biological resources in the Yucca Mountain vicinity after closure through heating of the ground surface and through radiation exposure as the result of waste migration through groundwater to discharge points. No additional analyses for biological resources and soil have been performed for the design and operating mode changes made after the Draft EIS was published. The temperatures for the higher-temperature operating mode now being considered are bounded by the temperatures analyzed for the high-thermal load scenario in the Draft EIS and presented in this section.

After closure, heat from the radioactive decay of the waste could cause temperatures in the rock near the waste packages to rise above the boiling point of water at this altitude [96°C (205°F)] (DIRS 101779-DOE 1998, Volume 3, p. 3-36). The period the subsurface temperature could remain above the boiling point would vary from a few hundred years to a few thousand years, depending on the operating mode. Conduction and the flow of heated air and water through the rock (advection) would carry the heat from the waste packages through the rock to the surface and to the aquifer.

Although the atmosphere would remove excess heat when it reached the ground surface, the temperature of near-surface soils probably would increase slightly. Predicted increases in surface soil temperatures range from approximately 10°C (18°F) at the bedrock-soil interface (DIRS 100627-Bodvarsson and Bandurraga 1996, p. 510) to 6°C (10.8°F) for dry soil at a depth of 2 meters (6.6 feet) (Table 5-15). To address soil heterogeneity (differences in depth and water content), a recent study (DIRS 103618-CRWMS M&O 1999, all) modeled soil temperature increases at various depths under wet (saturated) and dry (no water at all) soil conditions for the high thermal load. They predicted that temperatures of near-surface soils would be unlikely to rise more than a few degrees (Table 5-14) but would increase with depth from the surface. Surface soil temperatures would start to increase approximately 200 years after repository closure and would peak more than 1,000 years after repository closure. Later, the temperature would gradually decline and would approximate prerepository conditions after 10,000 years (DIRS 103618-CRWMS M&O 1999, Figure 30 and p. 41).

Table 5-15. Predicted temperature changes of near-surface soils under the high thermal load scenario.^{a,b}

Soil depth (meters) ^c	Predicted temperature increase ^a	
	Dry soil	Wet soil
0.5	1.5°C (2.7°F)	0.2°C (0.36°F)
1.0	3.0°C (5.4°F)	0.4°C (0.72°F)
2.0	6.0°C (10.8°F)	0.8°C (1.4°F)

- a. Source: DIRS 103618-CRWMS M&O (1999, p. 38).
- b. The high thermal load scenario was described and analyzed in the Draft EIS; this is not to be confused with the higher-temperature operating mode discussed in this Final EIS, which has a lower design heat loading.
- c. To convert meters to inches, multiply by 39.37.

The maximum change in temperature would occur directly above the repository, affecting approximately 5 square kilometers (1,250 acres) under the higher-temperature operating mode. The effects of repository heat on the surface soil temperatures would gradually decline with distance from the repository (DIRS 103618-CRWMS M&O 1999, p. 43). Although not modeled, the increase in surface soil temperature would be lower under the lower-temperature operating mode, and the area that could be affected would

be larger [as much as 6.2 square kilometers (1,550 acres) above the repository for the lower-temperature operating mode].

There is considerable uncertainty in the estimates of soil temperature increases due to uncertainties in the thermal properties of the soil at Yucca Mountain, particularly thermal conductivity (the amount of heat that can be conducted through a unit of soil per unit time) (DIRS 103618-CRWMS M&O 1999, p. 50). The predicted temperature increase for dry soil provides a conservative estimate of the temperature increase that could occur because even partially saturated soil has a much greater thermal conductivity than dry soil. Soil moisture content recorded at a depth of 15 centimeters (6 inches) was as low as 3 percent on some study sites during some months, but the soil was never completely dry (DIRS 105031-CRWMS M&O 1999, p. 14).

A depth of 1 meter (3.3 feet) is within the root zone for many desert shrubs. A temperature increase of 3°C (5.4°F) could affect root growth and other soil parameters such as the growth of microbes or nutrient availability. Studies at Yucca Mountain (DIRS 105031-CRWMS M&O 1999, pp. 11 to 46) show that due to natural variations some plant species experienced a spatial range in soil temperatures of 4°C (7.2°F) at a depth of 0.45 meter (18 inches), which is comparable to the 0.5-meter (20-inch) depth used by DIRS 103618-CRWMS M&O (1999, pp. 37-41). Impacts to biological resources probably would consist of an increase of heat-tolerant species over the repository and a decrease of less tolerant species. In general, areas affected by repository heating could experience a loss of shrub species and an increase in annual species. A gradual (over 1,000 years) temperature increase of the magnitude predicted (DIRS 103618-CRWMS M&O 1999, all) probably would have less effect on the plant community than a more rapid change.

The predicted increase in temperature would extend as far as 500 meters (1,600 feet) beyond the edge of the repository, with the greatest increase in temperature occurring in soils directly above the repository. A shift in the plant species composition, if any, would be limited to the area within 500 meters of the repository footprint [that is, as much as 8 square kilometers (2,000 acres)].

A shift in the plant community probably would lead to localized changes in the animal community that depends on it for food and shelter. Specific plant and animal species and community changes cannot be predicted with certainty because changes in climate or seasonal episodic events (droughts, high rainfall) can substantially change species responses to single factors. However, the variation in surface soil temperatures at Yucca Mountain that are caused by elevation, slope, aspect, and other natural attributes suggest that soil temperature increases of the magnitude predicted (DIRS 103618-CRWMS M&O 1999, pp. 44 to 48) are probably within the adaptive range of some plant species now at Yucca Mountain (DIRS 105031-CRWMS M&O 1999, pp. 11 to 46).

Some reptiles, including the desert tortoise, exhibit temperature-dependent sex determination (DIRS 103463-Spotila et al. 1994, all). Nest temperatures have a direct effect on sex determination, with low temperatures resulting in predominately male hatchlings and high temperatures resulting in predominately females. Although existing experimental data do not adequately represent the large fluctuations in nest temperatures in natural settings, an increase in soil temperature due to repository operations could influence the sex ratio and other aspects of the life history of the desert tortoise population residing over the repository footprint. However, depth to the top eggs of 23 nests at Yucca Mountain during 1994 averaged 11 centimeters (4.3 inches). Predicted temperature increases of clutches at that depth based on modeling results (DIRS 103618-CRWMS M&O 1999, pp. 37 to 42) would be less than 0.5°C (0.9°F). Given the ranges of critical temperatures reported by DIRS 103463-Spotila et al. (1994, all), an increase of this magnitude would be unlikely to cause adverse effects.

Changes in plant nutrient uptake, growth, and species composition, as a result of increases in soil temperature over long periods of time, could influence vegetation community dynamics and possibly alter

desert tortoise habitat structure in areas immediately above the repository. However, little is known about the effects that minor alterations in habitat would have on desert tortoise population dynamics.

As discussed in Sections 5.4 and 5.6, in the distant future water at certain discharge points would be likely to carry concentrations of radionuclides and chemically toxic substances. DOE did not quantify impacts to biological resources from irrigation water extracted at the RMEI location, from irrigation water extracted at 30 kilometers (19 miles) downgradient from the potential repository, or for the evaporation of water at Franklin Lake Playa (where there is no surface water at present). The estimated doses to humans exposed to this water would be very small. Expected dose rates to plants and animals would be much less than 100 millirad per day. The International Atomic Energy Agency concluded that chronic dose rates less than 100 millirad per day are unlikely to cause measurable detrimental effects in populations of the more radiosensitive species in terrestrial ecosystems (DIRS 103277-IAEA 1992, p. 53).

The desert tortoise is the only threatened or endangered species in the analyzed repository land withdrawal area (DIRS 104593-CRWMS M&O 1999, p. 3-14). Desert tortoises are rare or absent on or around playas (DIRS 101914-Rautenstrauch and O'Farrell 1998, pp. 407 to 411; DIRS 103160-Bury and Germano 1994, pp. 64 and 65); therefore, DOE anticipates no impacts to this species from contaminated water resources at Franklin Lake Playa in the future.

Impacts to surface soils would be possible. Changes in the plant community as a result of the presence of the repository could lead to an increase in the amount of rainfall runoff and, therefore, an increase in the erosion of surface soils, thereby increasing the sediment load in ephemeral surface water in the immediate Yucca Mountain vicinity.

5.10 Summary

Potential long-term impacts to human health from a repository at Yucca Mountain would be dominated by impacts from radioactive materials in the waterborne pathway under the Proposed Action. Although future disruptive events (human intrusion, volcanic activity, seismic activity) would change radiation exposure rates, the effect of these on the reported impacts for the nominal scenario would be small.

Tables 5-6 and 5-10 list individual doses from groundwater releases of radionuclides during 10,000 years after repository closure. The mean annual individual doses at the RMEI location are summarized in Table 5-16. The mean annual individual doses in Table 5-16 are much less than the limit of 15 millirem in 40 CFR Part 197.

Table 5-16. Individual impacts from groundwater releases of radionuclides during 10,000 years after repository closure for the Proposed Action.^a

Operating mode	Peak mean annual individual dose at the RMEI location (millirem) ^b	Peak mean annual probability of an LCF ^c
Higher-temperature	0.00002	6×10^{-10}
Lower-temperature	0.00001	4×10^{-10}

- a. Values based on the mean peak-dose rates from 300 simulations of total system performance using random samples of uncertain parameters.
- b. The RMEI location is approximately 18 kilometers (11 miles) downgradient from the potential repository.
- c. LCF = latent cancer fatality.

Tables 5-7 and 5-11 list estimated lifetime and 10,000-year integrated radiation dose impacts for members of the affected population from the groundwater release pathway during the first 10,000 years after

repository closure. Table 5-17 summarizes the health effects for the affected population of 74,000 persons based on a 10,000-year integrated basis.

The average mortality rate for cancer deaths per 100,000 persons in Nevada is 202 (DIRS 153066-Murphy 2000, p. 83). Using the Nevada cancer death rate, about 154 cancer fatalities would normally occur each year in the population affected by groundwater potentially contaminated by a repository at Yucca Mountain (74,000 persons). All of the values in Table 5-17 are much smaller than 1, meaning that it is most likely than no person would die due to groundwater contamination by radiological material in the 10,000-year period after repository closure. This comparison clearly indicates that human health impacts associated with effects on groundwater from the Proposed Action would be very small for the affected population. Using the Nevada cancer death rate, about 140 cancer fatalities would normally occur each year in the population within an 80-kilometer radius of Yucca Mountain (assuming a population of about 76,000 persons). All of the values in Table 5-17 are much smaller than 1.0, meaning that it is most likely that no person would die due to groundwater contamination by radiological material in the 10,000-year period after repository closure. This comparison clearly indicates that human health impacts associated with the Proposed Action would be very small for the population in general.

Table 5-17. Population impacts from groundwater releases of radionuclides during 10,000 years after repository closure for the Proposed Action.^a

Operating mode	Peak annual LCFs ^b	10,000-year integrated LCFs
Higher-temperature	0.000003	0.0002
Lower-temperature	0.000002	0.0002

a. Values based on the mean peak-dose rates from 300 simulations of total system performance using random samples of uncertain parameters.
 b. LCFs = latent cancer fatalities.

The analysis indicates (as listed in Table 5-17 and the peak dose values) that there is no significant difference in impacts due to the operating mode, even though the impacts for the higher-temperature mode appear to be slightly larger than those impacts for the lower-temperature mode. One reason for the similarity in annual individual dose between the operating modes is that most waste packages would still be intact beyond the time at which the repository temperature would be elevated much above ambient rock temperatures (DIRS 155950-BSC 2001, p. 7-85). Thus, most radionuclides would not be released until long after the thermal effects had subsided and, therefore, the operating modes would not have a large effect on the peak doses.

The EPA has set annual dose limits of 15 millirem to an individual for human intrusion and igneous disruption events (40 CFR Part 197). As shown in Figure 5-7, the peak of the mean annual dose rate from a human intrusion 30,000 years after repository closure would be 0.002 millirem. The probability weighted mean annual dose to an individual for the igneous intrusion scenario would have a peak of 0.1 millirem. Both of these results are well below the regulatory limits.

The peak mean annual individual doses at the RMEI location in the first 1 million years after repository closure would be 150 millirem for the higher-temperature operating mode and 120 millirem for the lower-temperature operating mode. These doses do not specifically include the effects of disruptive events. The effects of disruptive events would be very small compared to the 1-million-year peak annual dose. These effects are evaluated separately and reported in Section 5.7.

As listed in Table 5-14, human impacts from chemically toxic materials would be unlikely because water concentrations would be below Maximum Contaminant Level Goals (40 CFR 191.51) or Oral Reference Doses (chromium, DIRS 148224-EPA 1999, all; molybdenum, DIRS 148228-EPA 1999, all; nickel, DIRS 148229-EPA 1999, all; and vanadium, DIRS 103705-EPA 1997, all). Estimated concentrations of radionuclides in groundwater (see Table 5-9) would be hundreds of thousands of times less than regulatory limits (40 CFR 197.30). Atmospheric release of carbon-14 would yield an estimated 80-kilometer (50-mile) population impact of 5.3×10^{-10} latent cancer fatality during the 70-year period of

maximum release, much lower than the groundwater-borne population impacts. Finally, as discussed in Section 5.9, there are no anticipated adverse impacts to biological resources from either repository heating effects or the migration of radioactive materials.

REFERENCES

Note: In an effort to ensure consistency among Yucca Mountain Project documents, DOE has altered the format of the references and some of the citations in the text in this Final EIS from those in the Draft EIS. The following list contains notes where applicable for references cited differently in the Draft EIS.

- 104328 ASTM 1998 ASTM (American Society for Testing and Materials). 1998. *Standard Specification for Low-Carbon Nickel-Molybdenum-Chromium, Low-Carbon Nickel-Chromium-Molybdenum, Low-Carbon Nickel-Chromium-Molybdenum-Copper and Low-Carbon Nickel-Chromium-Molybdenum-Tungsten Alloy Plate, Sheet, and Strip*. B 575-97. West Conshohocken, Pennsylvania: American Society for Testing and Materials. TIC: 241816.
- 100627 Bodvarsson and Bandurraga 1996 Bodvarsson, G.S. and Bandurraga, T.M., eds. 1996. *Development and Calibration of the Three-Dimensional Site-Scale Unsaturated Zone Model of Yucca Mountain, Nevada*. Berkeley, California: Lawrence Berkeley National Laboratory. ACC: MOL.19970211.0176.
- 152059 BSC 2001 BSC (Bechtel SAIC Company) 2001. *Performance Assessment of U.S. Department of Energy Spent Fuels in Support of Site Recommendation*. CAL-WIS-PA-000002 REV 00. Las Vegas, Nevada: Bechtel SAIC Company. ACC: MOL.20010627.0026.
- 154554 BSC 2001 BSC (Bechtel SAIC Company) 2001. *Lower-Temperature Subsurface Layout and Ventilation Concepts*. ANL-WER-MD-000002 REV 00. Las Vegas, Nevada: Bechtel SAIC Company. ACC: MOL.20010718.0225.
- 154659 BSC 2001 BSC (Bechtel SAIC Company) 2001. *FY01 Supplemental Science and Performance Analyses, Volume 2: Performance Analyses*. TDR-MGR-PA-000001 REV 00. Las Vegas, Nevada: Bechtel SAIC Company. ACC: MOL.20010724.0110.
- 154841 BSC 2001 BSC (Bechtel SAIC Company) 2001. *Inventory Abstraction*. ANL-WIS-MD-000006 REV 00 ICN 02. Las Vegas, Nevada: Bechtel SAIC Company. ACC: MOL.20010416.0088.
- 155182 BSC 2001 BSC (Bechtel SAIC Company) 2001. *Software Code: GoldSim*. V7.17.200. 10344-7.17.200-00.
- 155950 BSC 2001 BSC (Bechtel SAIC Company) 2001. *FY 01 Supplemental Science and Performance Analyses, Volume 1: Scientific Bases and Analyses*. TDR-MGR-MD-000007 REV 00 ICN 01. Las Vegas, Nevada: Bechtel SAIC Company. ACC: MOL.20010801.0404; MOL.20010712.0062; MOL.20010815.0001.

- 157151 BSC 2001 BSC (Bechtel SAIC Company) 2001. *Technical Update Impact Letter Report*. MIS-MGR-RL-000001 Rev 00 ICN 02. Las Vegas, Nevada: Bechtel SAIC Company. ACC: MOL.20011211.0311.
- 157307 BSC 2001 BSC (Bechtel SAIC Company) 2001. *Total System Performance Assessment-Analyses for Disposal of Commercial and DOE Waste Inventories at Yucca Mountain-Impact Final Environmental Impact Statement and Site Suitability Evaluation*. REV 00 ICN 02. Las Vegas, Nevada: Bechtel SAIC Company. ACC: MOL.20011213.0056.
- 103160 Bury and Germano 1994 Bury, R.B. and Germano, D.J., eds. 1994. *Biology of North American Tortoises*. Fish and Wildlife Research Report 13. Washington, D.C.: U.S. Department of the Interior. TIC: 225209.
- 100111 CRWMS M&O 1994 CRWMS M&O (Civilian Radioactive Waste Management System Management & Operating Contractor) 1994. *Total System Performance Assessment - 1993: An Evaluation of the Potential Yucca Mountain Repository*. B00000000-01717-2200-00099 REV 01. Las Vegas, Nevada: CRWMS M&O. ACC: NNA.19940406.0158. In the Draft EIS, this reference was cited as Andrews, Dale & McNeish 1994.
- 100198 CRWMS M&O 1995 CRWMS M&O (Civilian Radioactive Waste Management System Management & Operating Contractor) 1995. *Total System Performance Assessment - 1995: An Evaluation of the Potential Yucca Mountain Repository*. B00000000-01717-2200-00136 REV 01. Las Vegas, Nevada: CRWMS M&O. ACC: MOL.19960724.0188. In the Draft EIS, this reference was cited as TRW 1995b.
- 103618 CRWMS M&O 1999 CRWMS M&O (Civilian Radioactive Waste Management System Management & Operating Contractor) 1999. *Impact of Radioactive Waste Heat on Soil Temperatures*. BA0000000-01717-5700-00030 REV 0. Las Vegas, Nevada: CRWMS M&O. ACC: MOL.19990309.0403. In the Draft EIS, this reference was cited as TRW 1999r.
- 104593 CRWMS M&O 1999 CRWMS M&O (Civilian Radioactive Waste Management System Management & Operating Contractor) 1999. *Environmental Baseline File for Biological Resources*. B00000000-01717-5700-00009 REV 00. Las Vegas, Nevada: CRWMS M&O. ACC: MOL.19990302.0181; MOL.19990330.0560. In the Draft EIS, this reference was cited as TRW 1999k.
- 104983 CRWMS M&O 1999 CRWMS M&O (Civilian Radioactive Waste Management System Management & Operating Contractor) 1999. *Geology/Hydrology Environmental Baseline File*. B00000000-01717-5700-00027 REV 01 DCN 1. Las Vegas, Nevada: CRWMS M&O. ACC: MOL.19990609.0156. In the Draft EIS, this reference was cited as TRW 1999h.

- 105031 CRWMS M&O 1999 CRWMS M&O (Civilian Radioactive Waste Management System Management & Operating Contractor) 1999. *Final Report: Plant and Soil Related Processes Along a Natural Thermal Gradient at Yucca Mountain, Nevada*. B00000000-01717-5705-00109 REV 00. Las Vegas, Nevada: CRWMS M&O. ACC: MOL.19990513.0037. In the Draft EIS, this reference was cited as TRW 1999s.
- 110384 CRWMS M&O 1999 CRWMS M&O (Civilian Radioactive Waste Management System Management & Operating Contractor) 1999. *EIS Performance-Assessment Analyses for Disposal of Commercial and DOE Waste Inventories at Yucca Mountain*. B00000000-01717-5705-00128 REV 00. Las Vegas, Nevada: CRWMS M&O. ACC: MOL.19990615.0207.
- 150558 CRWMS M&O 2000 CRWMS M&O (Civilian Radioactive Waste Management System Management & Operating Contractor) 2000. *Update to the EIS Engineering File for the Waste Package in Support of the Final EIS*. TDR-EBS-MD-000010 REV 00 ICN 01. Las Vegas, Nevada: CRWMS M&O. ACC: MOL.20000317.0446.
- 153038 CRWMS M&O 2000 CRWMS M&O (Civilian Radioactive Waste Management System Management & Operating Contractor) 2000. *Documentation of Million-Year TSPA*. Input Transmittal 00393.T. Las Vegas, Nevada: CRWMS M&O. ACC: MOL.20001110.0057; MOL.20001120.0173.
- 153246 CRWMS M&O 2000 CRWMS M&O (Civilian Radioactive Waste Management System Management & Operating Contractor) 2000. *Total System Performance Assessment for the Site Recommendation*. TDR-WIS-PA-000001 REV 00 ICN 01. Las Vegas, Nevada: CRWMS M&O. ACC: MOL.20001220.0045.
- 100376 Czarnecki 1990 Czarnecki, J.B. 1990. *Geohydrology and Evapotranspiration at Franklin Lake Playa, Inyo County, California*. Open-File Report 90-356. Denver, Colorado: U.S. Geological Survey. ACC: NNA.19901015.0195.
- 100131 D'Agnese et al. 1997 D'Agnese, F.A.; Faunt, C.C.; Turner, A.K.; and Hill, M.C. 1997. *Hydrogeologic Evaluation and Numerical Simulation of the Death Valley Regional Ground-Water Flow System, Nevada and California*. Water-Resources Investigations Report 96-4300. Denver, Colorado: U.S. Geological Survey. ACC: MOL.19980306.0253.
- 101779 DOE 1998 DOE (U.S. Department of Energy) 1998. *Viability Assessment of a Repository at Yucca Mountain*. DOE/RW-0508. Overview and five volumes. Washington, D.C.: U.S. Department of Energy, Office of Civilian Radioactive Waste Management. ACC: MOL.19981007.0027; MOL.19981007.0028; MOL.19981007.0029; MOL.19981007.0030; MOL.19981007.0031; MOL.19981007.0032. In the Draft EIS, this reference was cited as DOE 1998a.
- 153849 DOE 2001 DOE (U.S. Department of Energy) 2001. *Yucca Mountain Science and Engineering Report*. DOE/RW-0539. [Washington, D.C.]: U.S. Department of Energy, Office of Civilian Radioactive Waste Management. ACC: MOL.20010524.0272.

- 103705 EPA 1997 EPA (U.S. Environmental Protection Agency) 1997. *Health Effects Assessment, Summary Tables, FY-1997 Update*. EPA 540/R-97-036. Washington, D.C.: U.S. Environmental Protection Agency. TIC: 243784. In the Draft EIS, this reference was cited as International Consultants 1997.
- 101825 EPA 1998 EPA (U.S. Environmental Protection Agency) 1998. *Toxicological Review of Hexavalent Chromium [Chromium(VI)]*. CAS No. 18540-29-9. Washington, D.C.: U.S. Environmental Protection Agency. TIC: 243147.
- 148224 EPA 1999 EPA (U.S. Environmental Protection Agency) 1999. "Chromium(VI); CASRN 18540-29-9." IRIS (Integrated Risk Information System). Washington, D.C.: U.S. Environmental Protection Agency. Accessed June 10, 1999. TIC: 244103. <http://www.epa.gov/iris/subst/0144.htm>
- 148228 EPA 1999 EPA (U.S. Environmental Protection Agency) 1999. "Molybdenum; CASRN 7439-98-7." IRIS (Integrated Risk Information System). Washington, D.C.: U.S. Environmental Protection Agency. Accessed June 10, 1999. TIC: 244105. <http://www.epa.gov/iris/subst/0425.htm>
- 148229 EPA 1999 EPA (U.S. Environmental Protection Agency) 1999. "Nickel, Soluble Salts; CASRN Various." IRIS (Integrated Risk Information System). Washington, D.C.: U.S. Environmental Protection Agency. Accessed June 10, 1999. TIC: 244108. <http://www.epa.gov/iris/subst/0421.htm>
- 103277 IAEA 1992 IAEA (International Atomic Energy Agency) 1992. *Effects of Ionizing Radiation on Plants and Animals at Levels Implied by Current Radiation Protection Standards*. Technical Reports Series No. 332. Vienna, Austria: International Atomic Energy Agency. TIC: 243768.
- 110386 ICRP 1979 ICRP (International Commission on Radiological Protection) 1979. *Limits for Intakes of Radionuclides by Workers*. Volume 2, No. 3/4 of *Annals of the ICRP*. Sowby, F.D., ed. ICRP Publication 30 Part 1. New York, New York: Pergamon Press. TIC: 4939.
- 110351 ICRP 1980 ICRP (International Commission on Radiological Protection) 1980. *Limits for Intakes of Radionuclides by Workers*. Volume 4, No. 3/4 of *Annals of the ICRP*. Sowby, F.D., ed. ICRP Publication 30 Part 2. Reprinted 1990. Elmsford, New York: Pergamon Press. TIC: 4941.
- 110352 ICRP 1981 ICRP (International Commission on Radiological Protection) 1981. *Limits for Intakes of Radionuclides by Workers*. Volume 6, No. 2/3 of *Annals of the ICRP*. Sowby, F.D., ed. ICRP Publication 30 Part 3, Including Addendum to Parts 1 and 2. New York, New York: Pergamon Press. TIC: 4943.

- 152446 ICRP 1996 ICRP (International Commission on Radiological Protection) 1996. *Age-Dependent Doses to Members of the Public from Intake of Radionuclides: Part 5 Compilation of Ingestion and Inhalation Dose Coefficients*. Volume 26, No. 1 of Annals of the ICRP. Smith, H., ed. ICRP Publication 72. New York, New York: Pergamon Press. TIC: 235870.
- 155934 Mishra 2001 Mishra, S. 2001. "Importance Analysis." E-mail from S. Mishra (BSC) to D. Lester (Jason Technologies), August 23, 2001. ACC: MOL.20011009.0062.
- 155936 Mon 2001 Mon, K. 2001. "Importance Analysis." Electronic correspondence log from K. Mon (BSC) to S. Mishra (BSC), August 24, 2001. ACC: MOL.20011009.0060.
- 153066 Murphy 2000 Murphy, S.L. 2000. *Deaths: Final Data for 1998. National Vital Statistics Reports*. Vol. 48, No. 11. Hyattsville, Maryland: National Center for Health Statistics. TIC: 249111.
- 100953 Napier et al. 1988 Napier, B.A.; Peloquin, R.A.; Strenge, D.L.; and Ramsdell, J.V. 1988. *Conceptual Representation*. Volume 1 of *GENII - The Hanford Environmental Radiation Dosimetry Software System*. PNL-6584. Richland, Washington: Pacific Northwest Laboratory. TIC: 206898. In the Draft EIS, this reference was cited as Napier et al. 1997.
- 100018 National Research Council 1995 National Research Council 1995. *Technical Bases for Yucca Mountain Standards*. Washington, D.C.: National Academy Press. TIC: 217588.
- 101856 NCRP 1993 NCRP (National Council on Radiation Protection and Measurements) 1993. *Limitation of Exposure to Ionizing Radiation*. NCRP Report No. 116. Bethesda, Maryland: National Council on Radiation Protection and Measurements. TIC: 207090.
- 103760 NRC 1998 NRC (U.S. Nuclear Regulatory Commission) 1998. *Issue Resolution Status Report Key Technical Issue: Total System Performance Assessment and Integration*. Rev. 1. Washington, D.C.: U.S. Nuclear Regulatory Commission. ACC: MOL.19990105.0083.
- 103446 Oversby 1987 Oversby, V.M. 1987. "Spent Fuel as a Waste Form – Data Needs to Allow Long Term Performance Assessment under Repository Disposal Conditions." *Scientific Basis for Nuclear Waste Management X, Symposium held December 1-4, 1986, Boston, Massachusetts*. Bates, J.K. and Seefeldt, W.B., eds. 84, 87-101. Pittsburgh, Pennsylvania: Materials Research Society. TIC: 203663.
- 101914 Rautenstrauch and O'Farrell 1998 Rautenstrauch, K.R. and O'Farrell, T.P. 1998. "Relative Abundance of Desert Tortoises on the Nevada Test Site." *Southwestern Naturalist*, 43, (3), 407-411. Lubbock, Texas: Southwestern Association of Naturalists. TIC: 242257.

- 119693 Reamer 1999 Reamer, C.W. 1999. "Issue Resolution Status Report (Key Technical Issue: Igneous Activity, Revision 2)." Letter from C.W. Reamer (NRC) to Dr. S. Brocoum (DOE/YMSCO), July 16, 1999, with enclosure. ACC: MOL.19990810.0639.
- 103463 Spotila et al. 1994 Spotila, J.R.; Zimmerman, L.C.; Binckley, C.A.; Grumbles, J.S.; Rostal, D.C.; List, A., Jr.; Beyer, E.C.; Phillips, K.M.; and Kemp, S.J. 1994. "Effects of Incubation Conditions on Sex Determination, Hatching Success, and Growth of Hatchling Desert Tortoises, *Gopherus Agassizii*." *Herpetological Monographs*, (8), 103-116. [Champaign, Illinois]: The Herpetologists League. TIC: 242868.
- 156743 Williams 2001 Williams, N.H. 2001. "Contract No. DE-AC08-01RW12101—Total System Performance Assessment Sensitivity Analyses for Final Nuclear Regulatory Commission Regulations, Rev 00 ICN 01." Letter from N.H. Williams (BSC) to S.J. Brocoum (DOE/YMSCO), December 11, 2001, RWA:cs-1204010669, with enclosure. ACC: MOL.20011213.0057.
- 100191 Wilson et al. 1994 Wilson, M.L.; Gauthier, J.H.; Barnard, R.W.; Barr, G.E.; Dockery, H.A.; Dunn, E.; Eaton, R.R.; Guerin, D.C.; Lu, N.; Martinez, M.J.; Nilson, R.; Rautman, C.A.; Robey, T.H.; Ross, B.; Ryder, E.E.; Schenker, A.R.; Shannon, S.A.; Skinner, L.H.; Halsey, W.G.; Gansemer, J.D.; Lewis, L.C.; Lamont, A.D.; Triay, I.R.; Meijer, A.; and Morris, D.E. 1994. *Total-System Performance Assessment for Yucca Mountain – SNL Second Iteration (TSPA-1993)*. SAND93-2675. Executive Summary and two volumes. Albuquerque, New Mexico: Sandia National Laboratories. ACC: NNA.19940112.0123.