

**Fire Dynamics Tools (FDT^s)
Quantitative Fire Hazard
Analysis Methods for the
U.S. Nuclear Regulatory
Commission Fire Protection
Inspection Program**

Draft Report for Comment

Appendices

**U.S. Nuclear Regulatory Commission
Office of Nuclear Reactor Regulation
Washington, DC 20555-0001**



AVAILABILITY OF REFERENCE MATERIALS IN NRC PUBLICATIONS

NRC Reference Material

As of November 1999, you may electronically access NUREG-series publications and other NRC records at NRC's Public Electronic Reading Room at <http://www.nrc.gov/reading-rm.html>.

Publicly released records include, to name a few, NUREG-series publications; *Federal Register* notices; applicant, licensee, and vendor documents and correspondence; NRC correspondence and internal memoranda; bulletins and information notices; inspection and investigative reports; licensee event reports; and Commission papers and their attachments.

NRC publications in the NUREG series, NRC regulations, and *Title 10, Energy*, in the Code of *Federal Regulations* may also be purchased from one of these two sources.

1. The Superintendent of Documents
U.S. Government Printing Office
Mail Stop SSOP
Washington, DC 20402-0001
Internet: bookstore.gpo.gov
Telephone: 202-512-1800
Fax: 202-512-2250
2. The National Technical Information Service
Springfield, VA 22161-0002
www.ntis.gov
1-800-553-6847 or, locally, 703-605-6000

A single copy of each NRC draft report for comment is available free, to the extent of supply, upon written request as follows:

Address: Office of the Chief Information Officer,
Reproduction and Distribution
Services Section
U.S. Nuclear Regulatory Commission
Washington, DC 20555-0001

E-mail: DISTRIBUTION@nrc.gov
Facsimile: 301-415-2289

Some publications in the NUREG series that are posted at NRC's Web site address <http://www.nrc.gov/reading-rm/doc-collections/nuregs> are updated periodically and may differ from the last printed version. Although references to material found on a Web site bear the date the material was accessed, the material available on the date cited may subsequently be removed from the site.

Non-NRC Reference Material

Documents available from public and special technical libraries include all open literature items, such as books, journal articles, and transactions, *Federal Register* notices, Federal and State legislation, and congressional reports. Such documents as theses, dissertations, foreign reports and translations, and non-NRC conference proceedings may be purchased from their sponsoring organization.

Copies of industry codes and standards used in a substantive manner in the NRC regulatory process are maintained at—

The NRC Technical Library
Two White Flint North
11545 Rockville Pike
Rockville, MD 20852-2738

These standards are available in the library for reference use by the public. Codes and standards are usually copyrighted and may be purchased from the originating organization or, if they are American National Standards, from—

American National Standards Institute
11 West 42nd Street
New York, NY 10036-8002
www.ansi.org
212-642-4900

Legally binding regulatory requirements are stated only in laws; NRC regulations; licenses, including technical specifications; or orders, not in NUREG-series publications. The views expressed in contractor-prepared publications in this series are not necessarily those of the NRC.

The NUREG series comprises (1) technical and administrative reports and books prepared by the staff (NUREG-XXXX) or agency contractors (NUREG/CR-XXXX), (2) proceedings of conferences (NUREG/CP-XXXX), (3) reports resulting from international agreements (NUREG/IA-XXXX), (4) brochures (NUREG/BR-XXXX), and (5) compilations of legal decisions and orders of the Commission and Atomic and Safety Licensing Boards and of Directors' decisions under Section 2.206 of NRC's regulations (NUREG-0750).

**Fire Dynamics Tools (FDT^s)
Quantitative Fire Hazard
Analysis Methods for the
U.S. Nuclear Regulatory
Commission Fire Protection
Inspection Program**

Appendices

Draft Report for Comment

Manuscript Completed: June 2003

Date Published: June 2003

Prepared by
N. Iqbal, M.H. Salley

N. Iqbal, NRC Project Manager

Prepared for
Division of Systems Safety and Analysis
Office of Nuclear Reactor Regulation
U.S. Nuclear Regulatory Commission
Washington, DC 20555-0001



ABSTRACT

The U.S. Nuclear Regulatory Commission (NRC), Office of Nuclear Reactor Regulation (NRR), Division of Systems Safety and Analysis (DSSA), Plant Systems Branch (SPLB), Fire Protection Engineering and Special Projects Section has developed quantitative methods, known as "Fire Dynamics Tools (FDT)", to assist regional fire protection inspectors in performing fire hazard analysis (FHA). These methods have been implemented in spreadsheets and taught at the NRC's quarterly regional inspector workshops. FDT were developed using state-of-the-art fire dynamics equations and correlations that were pre-programmed and locked into Microsoft Excel® spreadsheets. These FDT will enable the inspector to perform quick, easy, first-order calculations for the potential fire scenarios using today's state-of-the-art principles of fire dynamics. Each FDT spreadsheet also contains a list of the physical and thermal properties of the materials commonly encountered in NPPs. This NUREG addresses the technical bases for FDT, which were derived from the principles developed primarily in the Society of Fire Protection Engineers (SFPE) *Handbook of Fire Protection Engineering*, National Fire Protection Association (NFPA) *Fire Protection Handbook*, and other fire science literature. The subject matter of this NUREG covers many aspects of fire dynamics and contains descriptions of the most important fire processes. A significant number of examples, reference tables, illustrations, and conceptual drawings are presented in this NUREG to expand the inspector's appreciation in visualizing and retaining the material and understanding calculation methods.

Key Words: Fire dynamics, Hazard analysis, Inspection, Significance determination process

Table of Contents

| | Page |
|--|------------|
| Abstract..... | iii |
| Appendix A. Nuclear Power Plant Electrical Cable Fundamentals..... | A-1 |
| A.1 Introduction..... | A-1 |
| A.2 Electrical Cable Construction..... | A-2 |
| A.3 Description of Cables..... | A-3 |
| A.4 Cable Materials..... | A-6 |
| A.4.1 Thermoplastic Materials..... | A-6 |
| A.4.2 Thermoset Materials..... | A-6 |
| A.5 References..... | A-10 |
| A.6 Additional Readings..... | A-10 |
| Appendix B. Fundamentals of Fire Protection..... | B-1 |
| B.1 T-Squared (t^2) Fire Power Law Heat Release Rate..... | B-1 |
| B.2 Elements of Hydraulic and Electrical Systems..... | B-15 |
| B.3 Classes of Fires..... | B-17 |
| B.4 Classification of Hazards..... | B-19 |
| B.5 Classes of Fires and Extinguishing Agents..... | B-21 |
| B.6 Classification of Flammable and Combustible Liquids..... | B-23 |
| B.7 Classification of Flammable Gases..... | B-31 |
| B.8 Flammability Hazards of Gases..... | B-33 |
| B.9 Combustion Properties of Pure Metals in Solid Form..... | B-37 |
| B.10 Extinguishing Agents for Metal Fires..... | B-39 |
| B.11 Occupancy Classification and Use Groups..... | B-41 |
| B.12 Building Limitations and Types of Construction..... | B-45 |
| B.13 Deep-Seated Fires in Class A Solid Materials..... | B-49 |
| B.14 Special Hazard Gaseous Fire Extinguishing Agents..... | B-53 |
| B.15 Dry Chemical Extinguishing Agents..... | B-69 |
| B.16 Fire Protection Using Foam..... | B-73 |
| B.17 Harmful Properties of Toxic Gases Found in Fires..... | B-81 |
| B.18 Effects of Decomposition Products of Halogenated Fire Extinguishing Agents..... | B-87 |
| B.19 An Introduction to Computer Fire Models..... | B-93 |
| Appendix C. Sources of Fire..... | C-1 |
| C.1 Heat Sources..... | C-1 |
| C.2 Incident Heat..... | C-3 |
| C.3 Target Fuel..... | C-5 |
| C.4 Flame/Heat Growth..... | C-7 |
| C.5 Fire Resistance..... | C-9 |
| C.6 Fire Resistance/Endurance Ratings..... | C-13 |
| C.7 Fire Test Standards..... | C-21 |

Table of Contents (Continued)

| | |
|---|------|
| Appendix D. NRC Documents Related to Fire Protection..... | D-1 |
| D.1 <i>Code of Federal Regulations</i> Related to Nuclear Regulatory Commission Fire Protection..... | D-1 |
| D.2 Branch Technical Positions Related to Fire Protection..... | D-3 |
| D.3 NRC Regulatory Guides Related to Fire Protection..... | D-5 |
| D.4 NRC Generic Communications Related to Fire Protection..... | D-7 |
| D.4.1 NRC Administrative Letters Related to Fire Protection..... | D-7 |
| D.4.2 NRC Bulletins Related to Fire Protection..... | D-9 |
| D.4.3 NRC Circulars Related to Fire Protection..... | D-11 |
| D.4.4 NRC Generic Letters Related to Fire Protection..... | D-13 |
| D.4.5 NRC Information Notices Related to Fire Protection..... | D-17 |
| D.4.6 NRC Regulatory Issue Summaries Related to Fire Protection..... | D-25 |
| D.5 Commission (SECY) Papers Related to Fire Protection..... | D-27 |
| D.6 NRC Preliminary Notifications of Fire Incidents..... | D-31 |
| D.7 NRC Miscellaneous Documents Related to Fire Protection..... | D-37 |
| D.8 NRR Staff Presentations and Publications Related to Fire Protection..... | D-41 |
| D.9 NRC Technical Reports in the NUREG Series Related to Nuclear Power Plant Fire Protection Engineering Research and Development (R&D)..... | D-43 |
| D.10 Safety Evaluation Reports Related to License Renewal for Operating Nuclear Power Plants..... | D-59 |
| D.11 National Fire Protection Association (NFPA) Codes and Standards for Nuclear Facilities..... | D-61 |
| Appendix E. Current National Fire Protection Association (NFPA) Codes and Standards..... | E-1 |
| Appendix F. Glossary of Terms..... | F-1 |
| Appendix G. Abbreviations Used in Fire Protection Engineering..... | G-1 |
| Appendix H. Selected U.S. Commercial Nuclear Power Plant Fire Incidents..... | H-1 |
| H.1 Introduction..... | H-1 |
| San Onofre Nuclear Generating Station, Unit 1, February 7 and March 12, 1968..... | H-7 |
| Browns Ferry Nuclear Power Plant, Unit 1, March 22, 1975..... | H-9 |
| North Anna Power Station, Unit 2, July 3, 1981..... | H-11 |
| Rancho Seco, March 19, 1984..... | H-12 |
| Waterford Steam Electric Station, Unit 3, June 26, 1985..... | H-12 |
| Fort St. Vrain Nuclear Generating Station, October 2, 1987..... | H-13 |
| Oconee Nuclear Station, Unit 1, January 3, 1989..... | H-14 |
| H.B. Robinson Steam Electric Plant, Unit 2, January 7, 1989..... | H-15 |
| Calvert Cliffs Nuclear Power Plant, Unit 2, March 1, 1989..... | H-16 |
| Shearon Harris Nuclear Power Plant, October 9, 1989..... | H-17 |
| Salem Generating Station Unit 2, November 9, 1991..... | H-18 |

Table of Contents (Continued)

| | |
|--|------|
| Waterford Steam Electric Station Unit 3, June 10, 1995..... | H-20 |
| Palo Verde Nuclear Generating Station Unit 2, April 4, 1996..... | H-22 |
| San Onofre Nuclear Generating Station, Unit 3, February 3, 2001..... | H-23 |
| Point Beach Nuclear Plant, Unit 1, April 24, 2001..... | H-26 |
| Prairie Island Nuclear Generating Plant, Unit 1, August 3, 2001..... | H-27 |
| Fort Calhoun Station, Unit 1, December 19, 2001..... | H-29 |
| | |
| Appendix I. Mathematics Review and System of Units..... | I-1 |
| | |
| I.1 Mathematics Review..... | I-1 |
| I.1.1 Units of Measurement..... | I-1 |
| I.1.2 Math Functions..... | I-6 |
| I.1.3 Solving Equations..... | I-7 |
| I.1.4 Caution with ΔT Conversions..... | I-10 |
| I.1.5 Miscellaneous Information..... | I-10 |
| I.1.6 References..... | I-11 |
| I.2 Notation Conventions..... | I-13 |
| I.2.1 References..... | I-13 |
| I.3 System of Units..... | I-15 |
| I.3.1 Length, Area, and Volume..... | I-15 |
| I.3.2 Mass and Density..... | I-15 |
| I.3.3 Time Units..... | I-15 |
| I.3.4 Force and Pressure Units..... | I-16 |
| I.3.5 Energy Units..... | I-16 |
| I.3.6 Power Units..... | I-16 |
| I.3.7 Temperature Units..... | I-16 |
| I.3.8 References..... | I-17 |
| I.4 Physical Constants for General Use..... | I-19 |
| I.4.1 References..... | I-19 |
| | |
| Appendix J. Practice Problems and Solutions..... | J-1 |

List of Figures

| | | |
|--------|--|------|
| A-1 | Basic Electrical Cable Construction - Common Single and Multi-conductor Cable Arrangements..... | A-4 |
| A-2 | Thermoplastic Insulated Cable Construction..... | A-7 |
| A-3 | Thermoset Insulated Cable Construction..... | A-9 |
| B.1-1 | Fire Growth of t^2 Fitted to Data..... | B-3 |
| B.1-2 | t^2 Fire Growth Curves..... | B-6 |
| B.1-3 | Comparison of t^2 Heat Release Rate with Full-Scale Free Burn Heat Release Rate..... | B-7 |
| B.1-4 | Relation of t^2 Heat Release Rate to Some Fire Tests..... | B-8 |
| B.1-5 | Comparison of t^2 Heat Release Rate with Full-Scale Furniture Heat Release Rate..... | B-9 |
| B.1-6 | Three-Sided Work Station Heat Release Rate Curve Compared With t^2 Curves..... | B-11 |
| B.1-7 | Heat Release Curve for Idle Pallets Compared with t^2 Curves..... | B-12 |
| B.1-8 | Heat Release Rate for Stacked Boxes Fires Compared with t^2 Curves..... | B-13 |
| B.14-1 | Indication of Deep-Seated Fire and Reignition of Cables, Test # 60, IEEE-383 Qualified Cables, Horizontal Trays, 4 Minutes Halon Soak Acceptor Tray Center Temperature..... | B-56 |
| B.14-2 | Soaking Time vs. Halon 1301 Concentration for Deep-Seated and Surface Fires..... | B-58 |

List of Tables

| | | |
|--------|--|------|
| A-1 | Designation of Electrical Rated Voltages..... | A-3 |
| B.1-1 | Summary of t^2 Fire Parameters..... | B-2 |
| B.1-2 | Maximum Heat Release Rates of Warehouse Materials (NFPA 72, 1999 Edition, Appendix B)..... | B-4 |
| B.2-1 | Elements of Hydraulic and Electrical Systems (NFPA 921, 2002 Edition)..... | B-15 |
| B.5-1 | Fire Classes with Extinguishing Agents..... | B-22 |
| B.6-1 | Flammable Liquid Classifications Based on the NFPA 30, "Flammable and Combustible Liquids Code," 2000 Edition..... | B-23 |
| B.6-2 | Combustible Liquid Classifications Based on the NFPA 30, "Flammable and Combustible Liquids Code," 2000 Edition..... | B-24 |
| B.6-3 | Flammable and Combustible Liquid Flash Points..... | B-25 |
| B.6-4 | NFPA 30 Maximum Allowable Size of Containers and Portable Tanks..... | B-26 |
| B.6-5 | Hazardous Material Classification..... | B-28 |
| B.9-1 | Melting, Boiling, and Ignition Temperatures of Pure Metals in Solid Form NFPA Fire Protection Handbook, 18 th Edition..... | B-38 |
| B.10-1 | Extinguishing Agents for Metal Fires..... | B-39 |
| B.12-1 | The Construction Classifications of the Model Codes and NFPA 220..... | B-47 |
| B.12-2 | Model Codes Standardization Council Recommended Types of Construction..... | B-47 |
| B.14-1 | Halons Commonly Used for Fire Protection..... | B-54 |
| B.15-1 | Dry Chemical Agents..... | B-69 |
| B.17-1 | Toxicity Data..... | B-84 |
| B.18-1 | Approximate Lethal Concentrations (ALC) for Predominant Halon 1301 and Halon 1211 Decomposition Products..... | B-88 |
| B.18-2 | Concentration of Hazardous Gases due to Decomposition of Halon 1301 in Industrial Baghouse Fire Situation..... | B-88 |
| B.18-3 | Halon 1301 Decomposition Produced by an n-Heptane Fire..... | B-90 |
| B.18-4 | Selected Properties of Halon 1301, 1211, and 2402..... | B-91 |
| B.19-1 | Computer Fire Models..... | B-99 |
| C.1-1 | Common Engineering Terms Related to Heat Sources..... | C-2 |
| C.2-1 | Incident Heat | C-3 |
| C.3-1 | Target Fuel..... | C-5 |
| C.4-1 | Flame/Heat Growth..... | C-7 |
| C.5-1 | Common Engineering Terms Related to Fire Severity..... | C-10 |
| C.5-2 | Common Engineering Terms Related to Fire Performance..... | C-11 |
| C.6-1 | Fire-Resistance Test Standards for Building Materials..... | C-17 |
| C.6-2 | Fire-Resistance Test Standards for Aerosol and Liquid Paints..... | C-18 |
| C.6-3 | Fire-Resistance Test Standards for Plastics..... | C-19 |
| H.1-1 | Summary of Selected U.S. Commercial Nuclear Power Plant Fire Incidents..... | H-2 |
| I.1-1 | Basic Units..... | I-1 |
| I.1-2 | Derived Units..... | I-2 |
| I.1-3 | SI Prefixes..... | I-3 |
| I.1-4 | Scientific Notations, Prefixes..... | I-3 |
| I.1-5 | Selected Unit Conversions..... | I-4 |
| I.4-1 | Values of Constants for General Use..... | I-19 |

APPENDIX A. NUCLEAR POWER PLANT ELECTRICAL CABLE FUNDAMENTALS

A.1 Introduction

The function of a electrical cable is to provide a medium for transmitting electrical energy (power control or signals) between two points in a common electrical circuit, while simultaneously maintaining the electrical isolation of the transmission path from other elements of the same circuit and from other co-located circuits. Cable failure, therefore, implies loss of continuity in the energy transmission path or diversion of a sufficient fraction of the available electrical energy to an unintended circuit destination such that proper function of the circuit is no longer assured. A typical boiling water reactor (BWR) requires approximately 97 km (60 miles) of power cable, 80.5 km (50 miles) of control cable and 402 km (250 miles) of instrument cable. A pressurized water reactor (PWR) may require far more, as illustrated by the containment building of Waterford Steam Electric Generating Station, Unit 3 which required nearly 1,609 km (1,000 miles) of cable (NUREG/CR-6384). The majority of fire dynamics, fire risk evaluations will focus on electrical cables because of their thermal fragility. It is therefore necessary to have a fundamental understanding of electrical cables.

Fire can cause cable failures in several ways. Experience from actual fire events has shown that different modes of fire-induced failures in electrical cables can in turn, produce a variety of circuit faults, leading to a range of circuit faulting behaviors. The risk implications of a given circuit fault depend upon the associated component function.

This appendix describes the types of cables commonly encountered in nuclear power plant (NPP) applications and the modes of cable failure that might be observed. It also discusses the potential impact of various cable failure modes on power, control, and instrumentation circuits. In addition, this appendix identifies the factors that can influence the potential for each of the identified cable failure modes that may result from a fire. Because of the large quantity of cable in a typical NPP and the fact that much of the cable material (e.g., polymer insulation and outer jacket) is combustible, cables frequently comprise a significant fraction of the total combustible load in many areas of a NPP.

The fire at Browns Ferry Nuclear Power Plant (BFNP) Unit 1, provides the classic example of how loss of function and spurious signals can occur as a result of a cable fire (NRC Bulletin BL-75-04). As such, it represents one of the most serious events ever experienced at a U.S. commercial NPP. In that fire, which was initiated by a candle flame igniting polyurethane foam in an improperly sealed penetration, temperatures as high as 816 °C (1,500 °F) caused damage to more than 1,600 cables routed in 117 conduits and 26 cable trays. Of these, a large number were safety-related. The number of damaged safety-related cable can be categorized by Unit as: 482 from Unit 1, 22 from Unit 2, and 114 common to both units. As a result, the reactor lost control power to a significant amount of emergency core cooling system (ECCS) equipment. In fact, at one point in the event, all power to Unit 1 ECCS motors and valves was lost. Furthermore, fire-induced short circuits caused many instrument, alarm, and indicating circuits to provide false and conflicting indications of equipment operation, thereby impeding operators' ability to control reactor safety functions. For example, one panel indicated that all ECCS pumps were operating, while another panel indicated that there was no need for this operation. The fire was contained to a relatively small interior area of the plant [the cable spreading room (CRS) and Unit 1 reactor building] and

the conditional core damage probability, for the event has been estimated to be about 0.4 (NUREG/CR-2497, "Precursors to Potential Severe Core Damage Accidents: 1969–1979, A Status Report," Volume 1 and 2).

The most intense part of the fire, which involved burning stacks of horizontal cable trays, covered an area roughly 3.3 m (10.9 ft) by 2.5 m (8.2 ft) in dimension. Due to reluctance to use water, fire suppression was considerably delayed; and the fire burnt some 7 hours after it started.

A.2 Electrical Cable Construction

Cables come in a wide variety of configurations. The primary configuration features that define a given cable are the size of the individual conductors [expressed using the American Wire Gauge (AWG)], the number of conductors, shielding and/or armoring features, and the insulation/jacket materials used.

Of the materials available for use as cable insulation and jacketing, the broadest categories are thermoplastic and thermoset. Thermoplastic materials melt when heated and solidify when cooled. Thermoset materials do not melt, but do begin to smolder and burn if sufficiently heated. In general, thermoset materials are more robust, with failure temperatures of approximately 350 °C (662 °F) or higher. Thermoplastic materials typically have much lower 218°C (425 °F) failure temperatures, where failure is typically associated with melting of the material.

Cables typically consist of one or more metallic conductors, insulation, filler, shielding, sheaths, and jacket. Each metallic conductor (generally copper or aluminum) is electrically isolated by being encased in a layer of insulation. The insulation, which is often considered the single most important component of the cable is typically made from a dielectric material (e.g., plastic, rubber, polymeric, silicone-based, or rubber-based material of some type). The term "sheath" commonly refers to an aluminum or steel jacket, rather than rubber or plastic (e.g., armored sheathed cable). Some cables may also include one or more shields consisting of metallic tape, composition tape, or a metallic braid. The shield is wrapped around the insulated conductors under the jacket or sheath. Single or multiple insulated conductors with their associated shields and sheaths are grouped together within a single integral protective jacket. The jacket serves a strictly utilitarian purpose (physical protection) and has no electrical function.

Cable jackets are typically constructed of rubber or plastic materials. The purpose of the jacket is to provide the insulated conductor(s) with physical or environmental protection, and/or increased flame retardancy. Cable jackets designed for increased flame retardancy slow the flame spread across the jacket and reduce the fuel contribution from the cable once ignited. Nevertheless, having increased flame retardancy does not ensure functionally.

Insulation plays an essential roll in a cable's overall performance at normal and elevated temperatures. The function of insulation is to electrically separate each conductor from the others conductors and from the ground plane. In some cases, cable jackets and cable insulation are constructed of the same materials.

The number of insulated conductors within a cable are commonly identified as follows:

- Single-conductor cable (1/C)

- Multi-conductor cable e.g., 2 conductors (2/C), 7 conductors (7/C)
- Triplex-conductor (triple-conductor) cable (3/C)

Cables are also identified by their rated power voltage as shown in Table A-1 (Salley, 2000).

| Table A-1. Designation of Electrical Rated Voltages | |
|--|----------------------|
| Designation | Voltage |
| Low | Up to 600 V |
| Medium | 601 to 15,000 V |
| High* | 15,001 V and greater |
| *High voltage cables are typically not found inside the NPP. They may be used as a cable bus in trenches, or in the switchyards. | |

A.3 Description of Cables

NPP use three functional type of cables. The function are, power, control, and instrumentation. Virtually every system in an NPP depends on the continued operation of one or more electrical cables. Power cables may be single-conductor, multi-conductor, or triplex. Control and instrumentation cables are generally of a multi-conductor design.

As the name implies, a single-conductor cable is a single insulated metal conductor that typically has an integral over-jacket. A triplex cable is a grouping of three signal-conductors that are manufactured together and are often twisted around a centrally located uninsulated core wire, which may be connected to the circuit ground. Basic electrical construction and configurations are illustrated in Figure A-1.

Multi-conductor cables are more varied and may come with virtually any number of conductors limited only by practical considerations such as overall physical diameter and handling ability. The most common configurations encountered in a NPPs are 2/C, 3/C, 7/C, and 12-conductor configurations. The 3/C, 7/C, and 12-conductor configurations are popular with manufacturers because they result in an overall cable product that maintains an essentially round outer profile. Another common configuration, particularly for instrument cables involves some number of twisted/shielded pairs within a protective jacket. In this case, the shield refers to a conductive wrap, such as a metal foil, wrapped around, conductor pairs. This is common in sensitive instrument circuits where stray electromagnetic or radio-frequency interference (EMI/RFI) may be a concern. These cables are also commonly used in communication systems.

The size of a cable is generally expressed as the number of conductors and the AWG of the individual conductors. Hence, a 3/C 12 AWG cable is a 3-conductor 12-gauge cable. Power cables typically range from relatively small 12 AWG cables (equivalent to cables used in residential applications for household power circuits) through very large cables in which the conductor diameter can approach or even exceed 2.54 cm (1 inch) (note that a higher gauge number indicates a smaller conductor.) For power cables, the size selection is generally based on the ampacity (current-carrying capacity) required in a specific application.

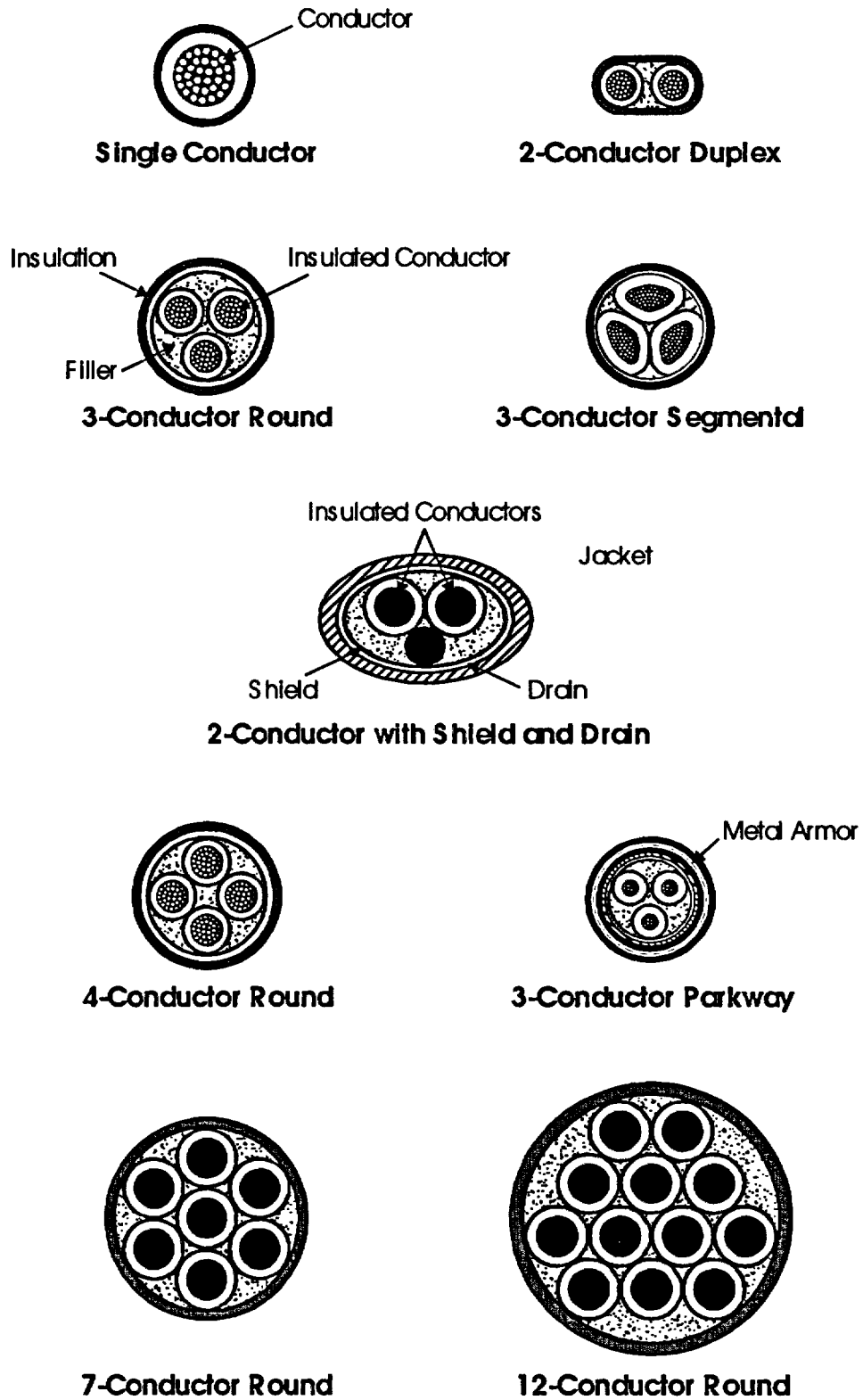

Figure A-1 Basic Electrical Cable Construction in Common Single- and Multi-Conductor Arrangements

Control cables are generally of a smaller gauge, commonly range from 16 AWG through 10 AWG with exceptions on the upper end of the size range. Instrumentation cables are generally of 16 AWG or smaller.

Voltage levels will also vary with the application. Instrument circuits generally use low voltages (50 volts or less). Control circuits are commonly in the 120–250-volt range, Power circuits encountered within an NPP generally range from 120 to 4,160 volts with offsite power circuits ranging to 15 kV or higher.

Cables are generally routed through the plant in horizontally raceways (generally trays or conduits) with vertical runs as required between different elevations in the plant. The cables are generally segregated by type (power, control, and instrumentation) but cables of various voltages and functions can be found together in some plants (generally older plants). High-voltage power cables are typically routed by themselves and may use maintained spacing address to ampacity concerns. Under maintained spacing, cables are not stacked and each cable is individually strapped to the electrical raceway. Gaps between cables ensure that they do not come into physical contact with each other. For most cables, random placement within the tray is common (that is, the cables are simply laid into the tray in a more or less random manner).

Fire exposure of an electrical cable can cause a loss of insulation resistance, loss of insulation physical integrity (i.e., melting of the insulation), and electrical breakdown or short-circuiting. Fire-induced damage to a cable can result in one of the following electrical conductor failure modes (LaChance et al., 2000):

- An open circuit result in a loss of electrical continuity of an individual conductor (i.e., the conductor is broken and the signal or power does not reach its destination).
- A short to Ground is experienced when an individual conductor comes into electrical contact with a grounded conducting medium (such as a cable tray, conduit, or a grounded conductor) resulting in a low-resistance path that diverts current from a circuit. The fault may be accompanied by a surge of excess current to ground (particularly in higher voltage circuits) that is often damaging to the conductor.
- A hot short is characterized by electrical faults that involve an energized conductor contacting another conductor of either the same cable (a conductor-to-conductor hot short) or an adjacent cable (a cable-to-cable hot short). A hot short has the potential to energize the affected conductor or to complete an undesirable circuit path.

It is important to note that a cable may have any number of conductors as discussed above and it is possible for more than one conductor failure mode to be active at a given time. For example, one set of 3-conductors may be shorted together (conductor-to-conductor hot short) while a fourth conductor shorts to ground.

Both shorts to ground and hot shorts may be manifested in the form of a low-impedance fault (often referred to as a bolted or dead-short) or as a high-impedance fault between the conductors. These two modes of shorting are distinguished on the basis of the following considerations:

- A high-impedance fault may allow power to pass from one conductor to another (or to ground) even between circuits with dissimilar voltages, while a low-impedance short

between circuits of dissimilar voltage or between a circuit and ground often trips circuit protection features (fuses or breakers) in one or both circuits.

- A single low-impedance short in a power circuit typically trips the lowest level of upstream circuit protection, while multiple high-impedance faults may trip a higher-level circuit protection feature (if circuit protection coordination is not provided), leading to loss of a higher-level electrical bus.
- A high-impedance faults in an instrumentation circuit may lead to a biased indication that might not be detected by operators, while low-impedance shorts typically result in a more easily detectable situation (e.g., complete loss of indication or an indication at the extreme high or low scale).

A.4 Cable Materials

For fire risk analysis, cable insulation and jacket materials can be separated into two broad categories:

A.4.1 Thermoplastic Materials

Thermoplastic materials are defined as high molecular weight polymers that are not cross-linked and are generally characterized by the distinct melting point of the insulation material. Thermoplastic materials can be repeatedly softened by heating and hardened by cooling within a temperature band that is a physical property of the material. This property is a function of the loose molecular bonding of the material. Some thermoplastic materials have a low melting point, which can be a disadvantage in that melting insulation can lead to conductor failures (e.g., conductor-to-conductor shorts and conductor to ground shorts) at relatively low temperatures. Some thermoplastic insulations are also problematic in that they produce dripping, flaming fires after ignition.

Thermoplastic insulation is generally easy to manufacture and economical to use. Common thermoplastic insulations include cellular; low and high polyethylene (PE); polyvinyl chloride (PVC); polyurethane; polypropylene (PPE); nylon; chlorinated polyethylene (CPE); tetrafluoroethylene (TFE), Teflon, and fluorinated polymers such as DuPont's TFE copolymers with ethylene (known as Tefzel[®]), DuPont's PFA (perfluoroalkoxy branched polymers), Allied Chemical's Halar (ethylene copolymer with chlorotrifluoroethylene), and Dynamit Nobel's Dyflor (polyvinylidene fluoride). Figure A-2 shows typical thermoplastic (PVC) insulated cable construction.

In general, cables that do not pass IEEE 383 rating (i.e., non-IEEE qualified) are thermoplastic.

A.4.2 Thermosetting Materials

The molecular consist of chains that are tied together with covalent bonds in a network (cross-linked). Thermoset insulations are generally characterized as softening, but not melting, during higher-than-normal temperature exposures. While they soften, they tend to maintain the mechanical properties of the insulator. As a result, thermoset insulations generally exhibit better low-and-high temperature properties, thermal aging resistance, and overload resistance than

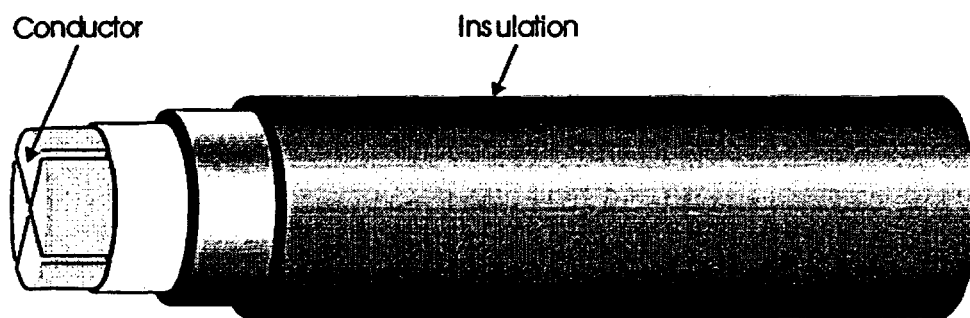

Single-core, Sectoral Aluminum Conductor, PVC Insulated Cable

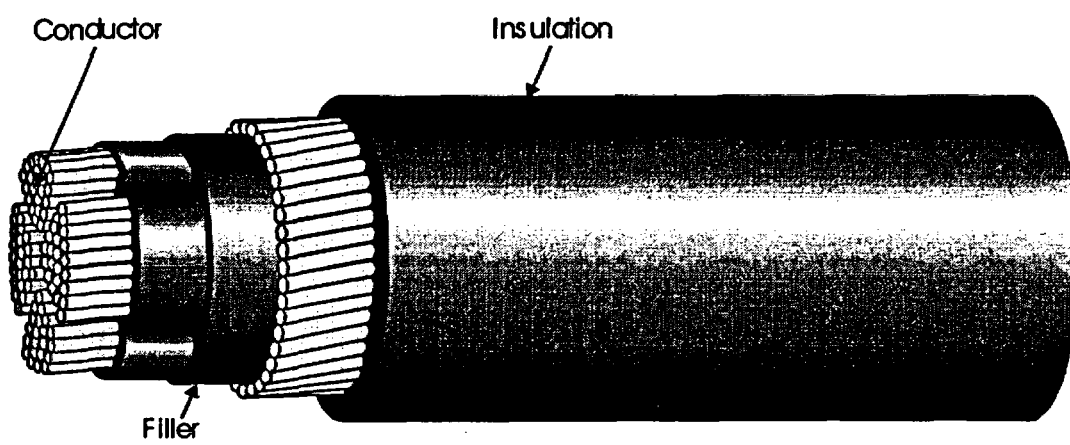

Four-core, Copper Conductor, PVC Insulated Cable

Figure A-2 Thermoplastic Insulated Cable Construction

thermoplastic insulations. Thermoset materials are vulcanized by heat (or other methods) during their fabrication process. As such, the materials are substantially infusible and insoluble. The molecular structure is tightly interlocked (in contrast to thermoplastic insulations). Common thermosetting insulations include ethylene propylene rubber (EPR); cross-linked polyethylene (XLPE); DuPont's Hypalon (chlorosulphonated polyethylene); nitrile or rubber butadiene nitrite (NBR); styrene butadiene rubber (SBR); polybutadiene,;neoprene; and silicone rubber.

In general, cables that do pass IEEE 383 rating (i.e., IEEE 383 qualified) are thermoset cables.

In summary, thermoplastic materials are high molecular weight polymers that are not cross-linked, while the polymer chain of thermoset materials are cross-linked in covalent bonded networks. When thermoset resins are heated during manufacture, from ambient to upward of 232 °C (450 °F), they under go an irreversible chemical reaction, referred to as "curing" or "polymerization," to make the final cross-linked thermoplastic product. While thermoplastic materials can be reshaped by heating and cooling within the proper temperature ranges for the materials, thermoset materials cannot be reshaped once they have been cross-linked. Figure A-3 shows typical thermoset (XLPE) insulated cable construction.

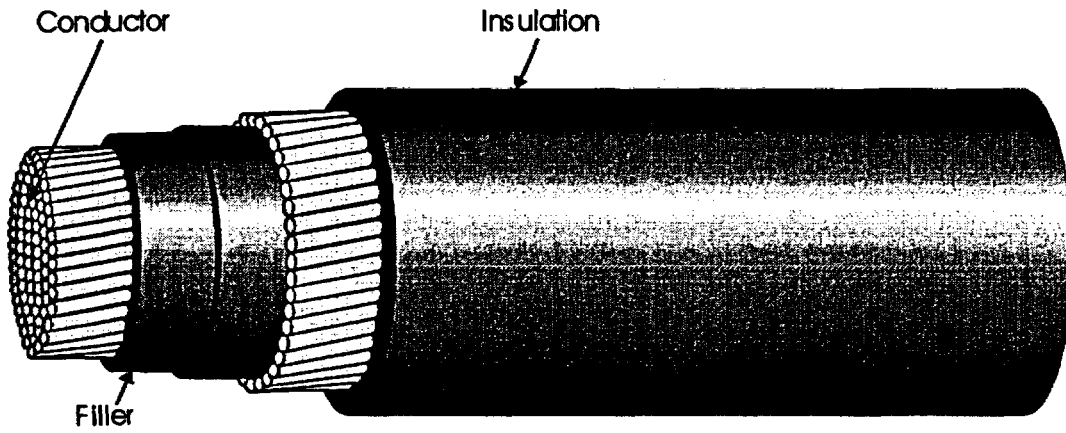

**Single-core, XLPE Insulated Cable with Standard Conductor,
Taped Bedding and Aluminum Wire Armor**

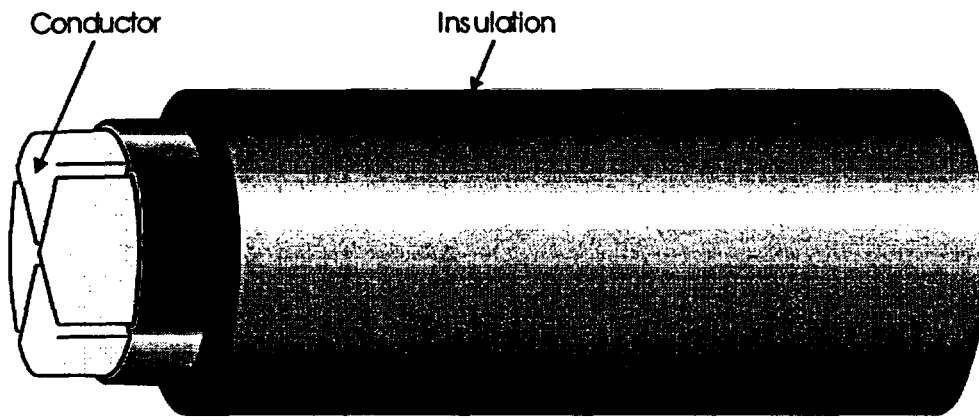

Four-core Unarmored, XLPE Insulated Cable with Solid Aluminum Conductor

Figure A-3 Thermoset Insulated Cable Construction

A.5 References

LaChance, J., S.P. Nowlen, F. Wyant, and V. Dandini, "Circuit Analysis-Failure Mode and Likelihood Analysis," A Letter Report to USNRC, Sandia National Laboratory, Albuquerque, New Mexico, ADAMS Accession # ML010450362, May 8, 2000.

BL-75-04, "Cable Fire at Browns Ferry Nuclear Power Station," U.S. Nuclear Regulatory Commission, Washington, DC, March 24, 1975.

Salley, M.H., "An Examination of the Methods and Data Used to Determine Functionality of Electrical Cables When Exposed to Evaluated Temperatures as a Result of a Fire in a Nuclear Power Plant," Master of Science Thesis, Department of Fire Protection Engineering, University of Maryland, College Park, Maryland, 2000.

U.S. Nuclear Regulatory Commission (U.S.) (NRC), NUREG/CR-6384, "Literature Review of Environmental Qualification of Safety Related Electric Cables," Volume 1. NRC Washington, DC, April 1996.

U.S. Nuclear Regulatory Commission (U.S.) (NRC), NUREG/CR-2497, "Precursors to Potential Severe Core Damage Accidents: 1969-1979, A Status Report," Volume 1 and 2. NRC Washington, DC.

A.6 Additional Reading

Grayson, S.J., P.V. Hess, U. Vercellotti, H. Breulet, and A. Green, "Fire Performance of Electric Cables - New Test Methods and Measurements Techniques," Interscience Communications Limited. United Kingdom, 2000.

Zalosh, R.G., *Industrial Fire Protection Engineering*, Chapter 9, "Electrical Cables and Equipment," John Wiley & Sons, New Jersey, 2003.

APPENDIX B. FUNDAMENTALS OF FIRE PROTECTION

This appendix reviews some selected fundamentals and most relevant characteristics of fire chemistry and physics (temperature, combustion products, smoke, toxicity, and fire extinguishing agents, etc.). Those inspectors who have never been exposed to fire protection will benefit from studying these fundamentals.

B.1 T-Squared (t^2) Fire Power Law Heat Release Rate

B.1.1 Introduction

The primary mechanism driving the growth of a fire is the flame spreading across a fuel item or between multiple fuel items. This growing fire will continue until one or more of the following conditions exists:

- Flashover occurs and all combustible materials are involved simultaneously.
- The fire cannot spread further due to lack of combustible materials.
- The fire uses all available oxygen for combustion.
- The fire is extinguished by intervention.

B.1.2 t^2 Heat Release Rate

Fire development varies depending on the combustion characteristics of the fuel(s) involved, the physical configuration of the fuel(s), the availability of combustion air, and the influences associated with the compartment. Once a stable flame is attained, most fires grow in an accelerating pattern, reach a steady state characterized by a maximum heat release rate (HRR), and then enter into a decay period as the availability of either fuel or combustion air becomes limited. Fire growth and development are limited by factors such as the quantity and arrangement of fuel, quantity of oxygen, and effect of manual and automatic suppression systems.

The primary parameter for describing fire growth is the HRR of the fire and how it changes with time. The fire growth rate depends on the ignition process; flame spread, which defines its perimeter; and the mass burning flux over the area involved. Once a combustible surface has ignited, the fire size increases as the flame spreads across the surface or as additional items in the room become involved. An important aspect is that the time required for the fire to grow is driven by the ignition source and combustible materials.

For most materials, a local ignition eventually involves the entire fuel item by flame-spreading processes. A typical sofa, for example, involves some combustion of horizontal, upward vertical, and downward vertical flame spread. For furniture and commodities, this complex fire growth process cannot be predicted by a simple formula. However, each item can have a characteristic growth time consistent with its composition and configuration. For example, a given item is ignited, it may achieve a heat release of 1 MW (1,000 kW) in 130 seconds, while another object might take 80 seconds. A complete mathematical description of this process is quite involved and relatively unpredictable given the range of ignition scenarios and the complexity of describing the burning item(s).

Nonetheless, testing has shown, that the overall HRR during the fire growth phase of many fires can often be characterized by simple-time dependent polynomial or exponential functions (Heskestad, 1997). The total heat release of fuel packages can be well approximated by the power law fire growth model for both single item burning and multiple items involved in a fire. Testing has also indicated that most growing fires can be expected to grow indefinitely until intervention by fire

fighters, and the fires have an early incubation period where fire does not conform to a power law approximation, as shown in Figure B.1-1. That figure illustrate that following an incubation period, the HRR of the fire grows continuously, proportional to the square of time.

The proposed model of the environment generated by fire in an enclosure is dependent on the assumption that the fire grows according to the following equation:

$$\dot{Q} = \alpha t^p \quad (B-1)$$

Where:

\dot{Q} = the heat release rate (HRR) of fire (kW)

α = a constant governing the speed of fire growth (kW/sec²)

t = the time (sec)

The proposed model of the environment generated by fire in an enclosure is dependent on the assumption that the fire grows according to the following equation:

$$\dot{Q} = \alpha t^2 \quad (B-2)$$

Where:

\dot{Q} = the rate of heat release of fire (kW)

α = a constant governing the speed of fire growth (kW/sec²)

t = the time (sec)

The growth rate approximately follows a relationship proportional to time squared for flaming and radially spreading fires, which are consequently called t-squared (t²) fires. Such fires are classed by the speed of growth, identified as ultra-fast, fast, medium, and slow. Where these classes are used, they are defined on the basis of the time required for the fire to grow to a heat release rate (HRR) of 1,000 kW (1 MW). Table B.1-1 summarizes the fire intensity constant (α) and the growth time (t_g) for each of these classes.

| Table B.1-1. Summary of t ² Fire Parameters | | |
|--|---|-------------------------------------|
| Class of Fire Growth | Intensity Constant α (kW/sec ²) | Growth Time t _g (sec) |
| Slow | 0.00293 | 600 |
| Medium | 0.01172 | 300 |
| Fast | 0.0469 | 150 |
| Ultra-Fast | 0.1876 | 75 |

**Figure B.1-1 Fire Growth of t^2 Fitted to Data (Heskestad, 1997)
(Waiting for copyright permission)**

Figure B.1-2 plots the t^2 fire growth rate curves that have been developed. The t^2 relationship has proven useful and has therefore been adopted into NFPA 72, "National Fire Alarm Code[®]," to categorize fires for siting of detectors as well as NFPA 92B "Guide for Smoke Management Systems in Mall, Atria, and Large Areas," for design of smoke control systems.

A t^2 fire can be viewed as one in which the HRR per unit area is constant over the entire ignited surface and the fire spreads as a circle with a steadily increasing radius. In such cases, the burning area increases in proportion to the square of the steadily increasing fire radius. Of course, fires that do not have such a conveniently regular fuel array and consistent burning rate might or might not actually produce a t^2 curve, but the t^2 approximation appears to be close enough for reasonable design decisions.

Figure B.1-3 provides the HRR results of various full-scale free burn tests performed at Factory Mutual Research Corporation (FMRC) (also reported by Nelson, 1987), superimposed on the t^2 HRR curves, using various standard test commodities for fuel arrays. Figure B.1-4 relates the classes of t^2 fire growth curves to a selection of actual fuel arrays. Figure B.1-5 plots the HRR curves for various upholstered furniture items. Figures B.1-3 to B.1-5 show that the actual fire growth curves for many common fuel arrays tend to be greater than the medium fire growth curve.

Table B.1-2 tabulates the maximum HRR for various warehouse materials. As shown, the majority of these materials exhibit fire growth rates in the fast or ultra-fast ranges. The preponderance of actual fire testing over 90's has shown that common fuel arrays exhibit fire growth rates that tend to exceed the medium t^2 fire growth rate.

| Table B.1-2. Maximum Heat Release Rates of Warehouse Materials (NFPA 72, 1999 Edition, Appendix B) | | | |
|---|----------------------|---|----------------------------|
| Warehouse Material (See Notes 1 and 2) | Growth Time (sec) | Heat Release Rate (\dot{Q}) (Btu/sec-ft ²) (See Note 3) | Fire Growth Classification |
| Wood pallets, stacked, 1½ ft high (6%–12% moisture) | 150–310 | 110 | Fast-Medium |
| Wood pallets, stacked, 5 ft high (6%–12% moisture) | 90–190 | 330 | Fast |
| Wood pallets, stacked, 10 ft high (6%–12% moisture) | 80–110 | 600 | Fast |
| Wood pallets, stacked, 16 ft high (6%–12% moisture) | 75–105 | 900 | Fast |
| Mail bags, filled and stored 5 ft high | 190 | 35 | Medium |
| Cartons, compartmented and stacked 15 ft high | 60 | 200 | Fast |
| Paper, vertical rolls, stacked 20 ft high | 15–28 | - | (See Note 4) |

**Table B.1-2. Maximum Heat Release Rates of Warehouse Materials
(NFPA 72, 1999 Edition, Appendix B) (continued)**

| Warehouse Material (See Notes 1 and 2) | Growth Time (sec) | Heat Release Rate (\dot{Q}) (Btu/sec-ft ²) (See Note 3) | Fire Growth Classification |
|--|----------------------|---|----------------------------|
| Cotton (also PE, PE/cot, acrylic/nylon/PE), garments in 12 ft high racks | 20-42 | - | (See Note 4) |
| Cartons on pallets, rack storage, 15 ft-30 ft high | 40-280 | - | Fast-Medium |
| Paper products, densely packed in cartons, rack storage, 20 ft high | 470 | - | Slow |
| PE letter trays, filled and stacked 5 ft high on cart | 190 | 750 | Medium |
| PE trash barrels in cartons, stacked 15 ft high | 55 | 250 | Fast |
| FRP shower stalls in cartons, stacked 15 ft high | 85 | 110 | Fast |
| PE bottles, packed in item 6 | 85 | 550 | Fast |
| PE bottles in cartons, stacked 15 ft high | 75 | 170 | Fast |
| PE pallets, stacked 3 ft high | 130 | - | Fast |
| PE pallets, stacked 6 ft-8 ft high | 30-55 | - | Fast |
| Methyl alcohol | - | 65 | - |
| Gasoline | - | 200 | - |
| Kerosene | - | 200 | - |
| Diesel oil | - | 180 | - |

Notes:

(1) For SI units, 1 ft = 0.305 m.

(2) FRP = fiberglass-reinforced polyester; PE = polyethylene; PS = polystyrene; PP = polypropylene; PU = polyurethane; PVC = polyvinyl chloride.

(3) The HRR per unit floor area are for fully involved combustibles, assuming 100-percent combustion efficiency. The growth times shown are those required to exceed 1,000 Btu/sec HRR for developing fires, assuming 100-percent combustion efficiency.

(4) Fire growth rate exceeds design data.

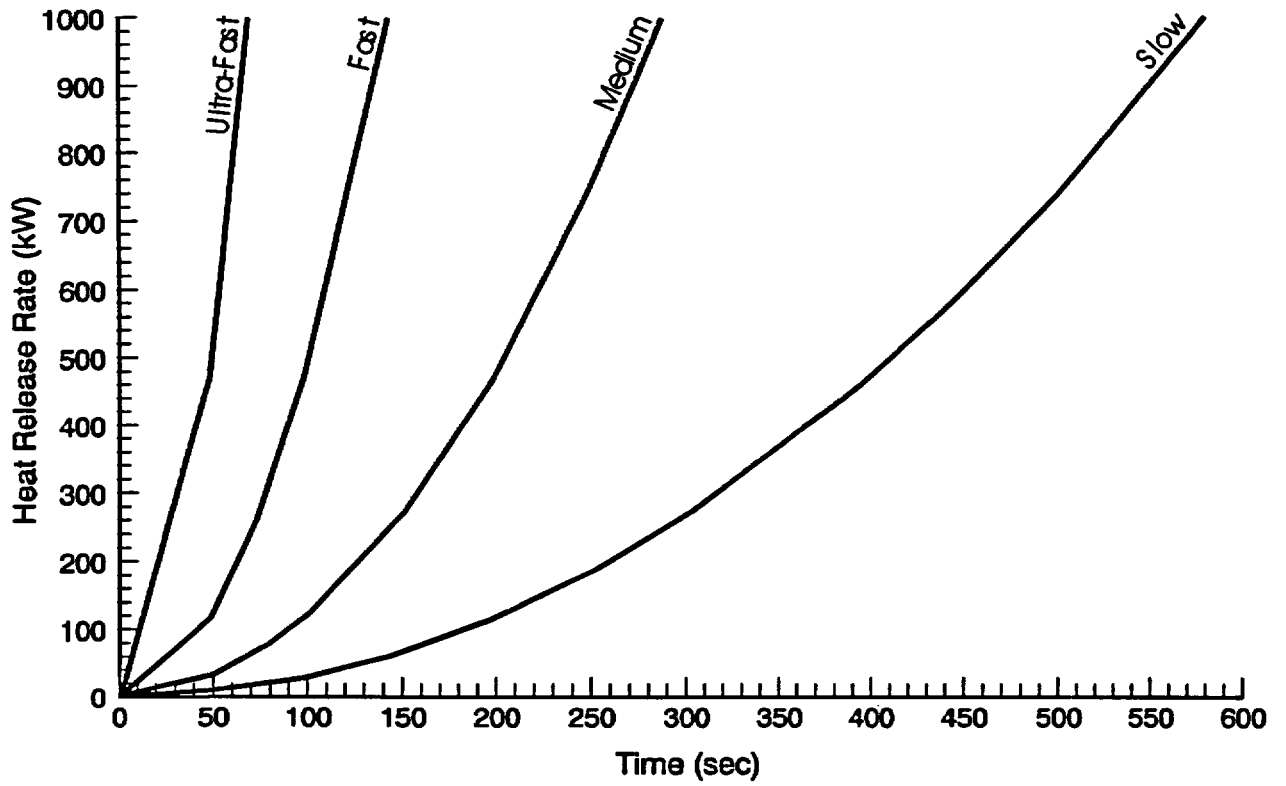

Figure B.1-2 Growth Rate Curves for t^2 Fire (NFPA, 72 and NFPA, 92B)

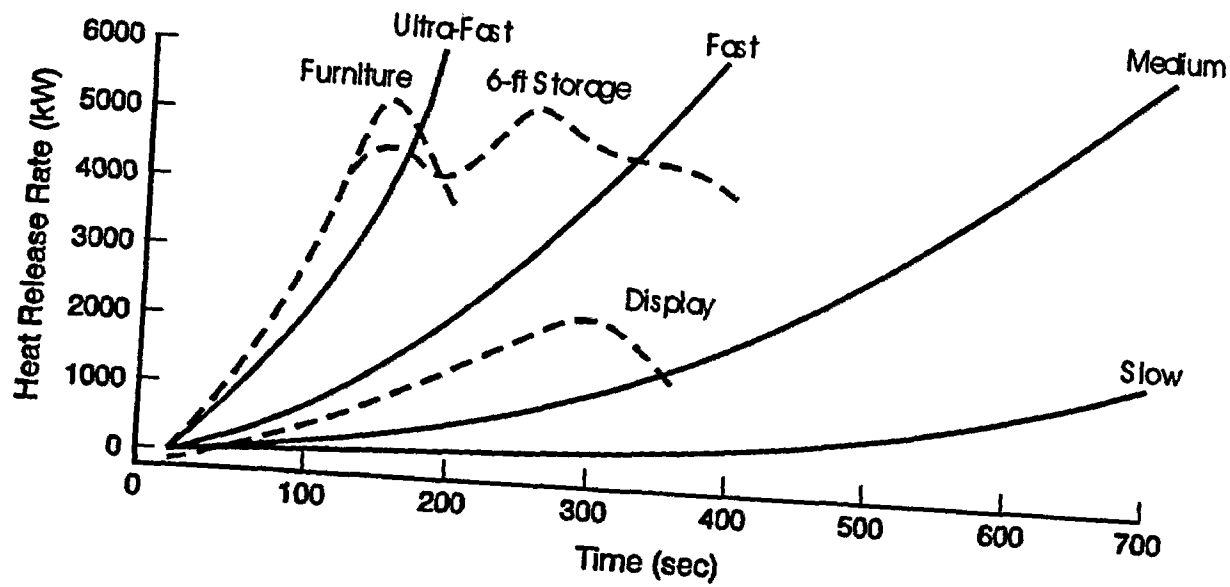

Figure B.1-3 Comparison of t^2 Heat Release Rate with Full-Scale Free-Burn Heat Release Rate (Nelson, 1987)

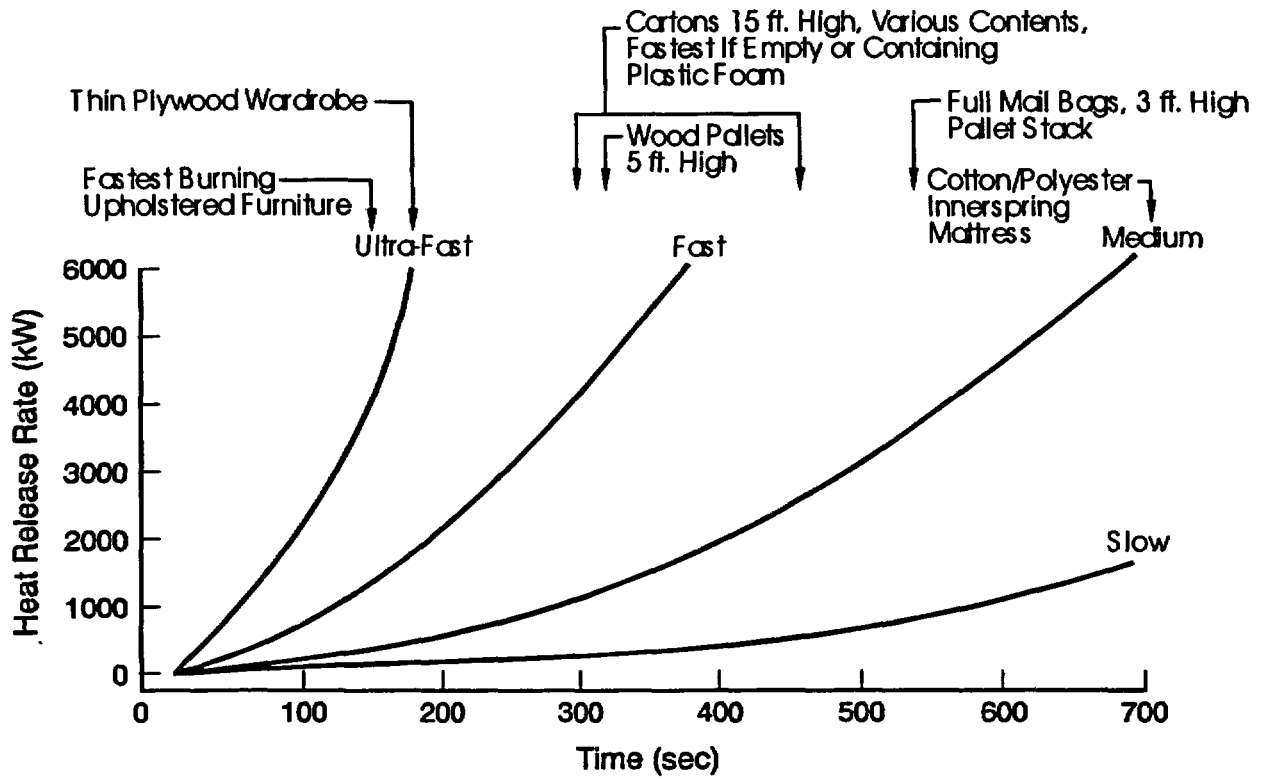

Figure B.1-4 Relation of t^2 Heat Release Rate to Some Fire Tests (Nelson, 1987)

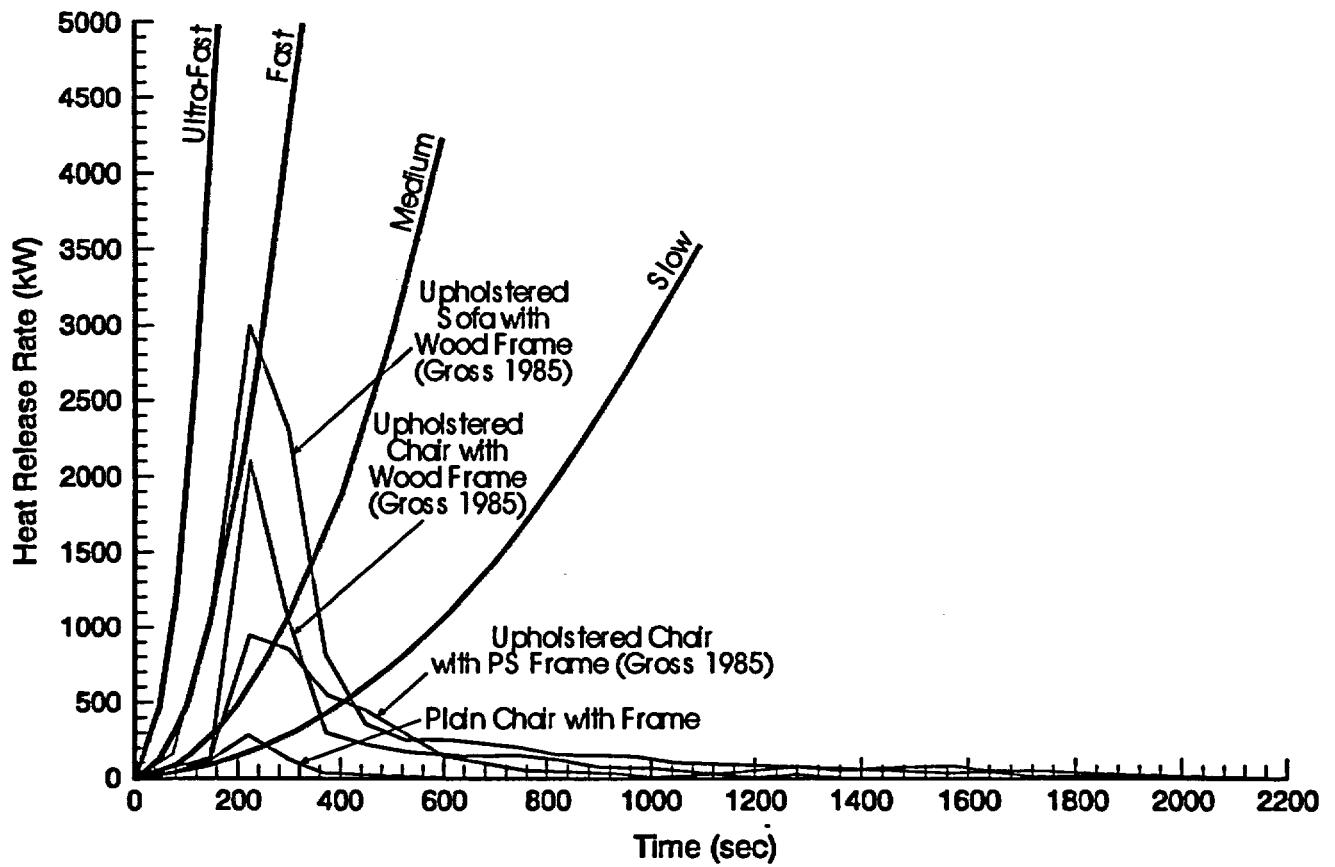

Figure B.1-5 Comparison of t^2 Heat Release Rates with Full-Scale Furniture Heat Release Rate

Madrzykowski (1996), compared HRR data for office work stations with standard t^2 HRR fire curves. Figure B.1-6 shows the HRR time history of the fire growth of a three-sided office work station compared to t^2 fire curves. Notice how the fire begins as a slow-medium growth rate fire, and then the slope increases to be representative of a fast-ultra-fast fire. As shown in Figure B.1-6, one can use the t^2 fire growth model to determine the HRR of similar fuel packages.

Figure B.1-7 shows the relationship between t^2 fire curves and six 1.2-m (4-ft) high stacks of mixed wooden pallets (8 to 9 pallets per stack) arranged in two rows of three stacks, with the three stacks in each row forming an unbroken line with 100-mm between the front and back rows. Figure B.1-7 shows that both tests exhibited there was an incubation period of about 120 seconds following which the fire growth rate was approximately parallel to the t^2 fast fire growth curve.

Figure B.1-8 shows the relationship between t^2 fire curves and six 1.2-m (4-ft) high stacks of cardboard boxes arranged in two rows of three stacks, with no gaps between the stacks. The boxes were ignited by setting light to a ball of crumpled newspaper pushed 100 mm under the front of the central stack in the front row of the array. Figure B.1-8 shows that both tests exhibited a long incubation period, as the ball of newspaper proved to be slow burning. However, the fire did break into the boxes immediately above the ignition source, and the flames eventually burst from the front of those boxes and then rapidly up the front of the central (ignition) stack. Thereafter the fire growth rate was similar to the ultra-fast t^2 fire curve.

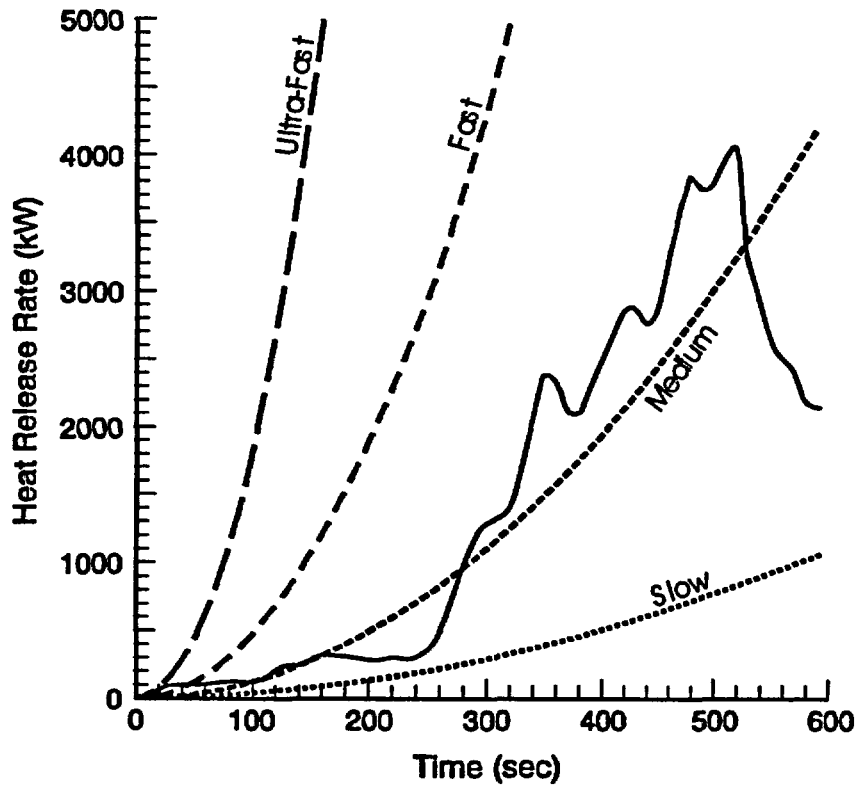

Figure B.1-6 Three-Sided Work Station Heat Release Rate Curve Compared with t^2 Curves (Madrzykowski, 1996)

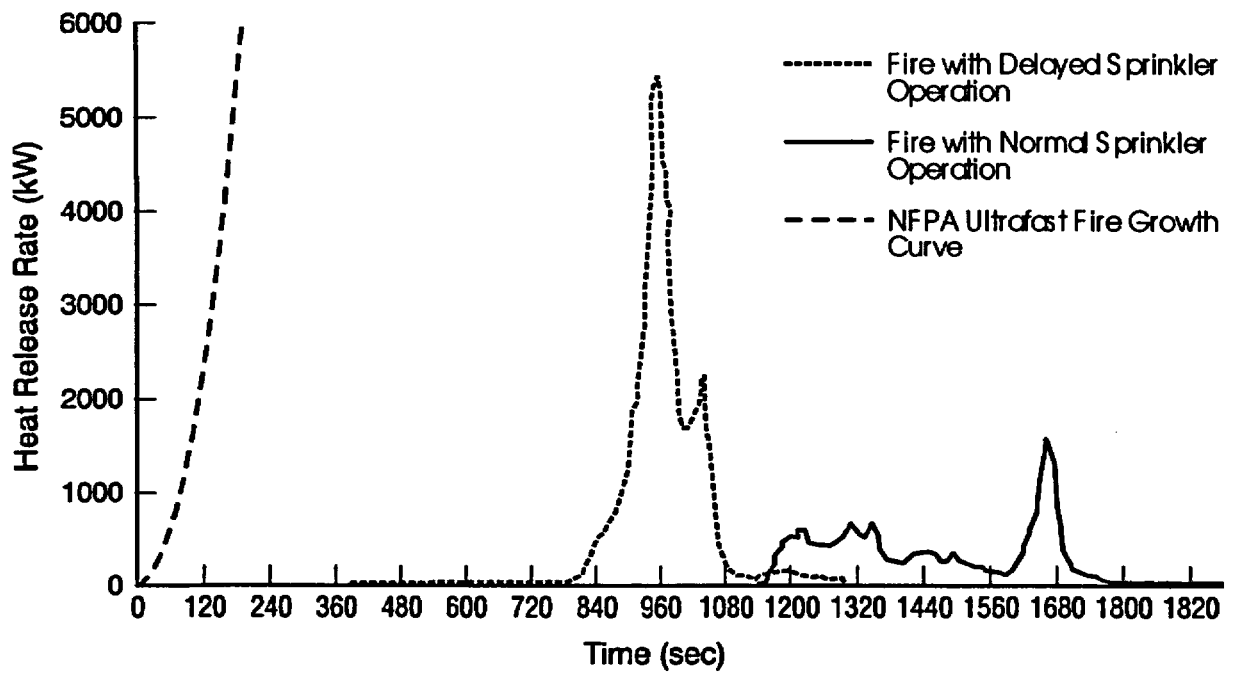

Figure B.1-7 Heat Release Rate Curve for Idle Pallets Compared with t^2 Curves (Garred and Smith, 1999)

**Figure B.1-8 Heat Release Rate for Stacked Box Fires Compared with t^2 Curves
(Garred and Smith, 1999)
(Waiting for copyright permission)**

B.1.3 References

Garred, G., and D.A. Smith, "The Characterization of Fires for Design," Interflam 1996, Conference Proceedings of the 8th International Interflam Conference, Inter Science Communication Limited, England, pp. 555–566, June-July 1999.

Gross, D., "Data Sources for Parameter Used in Predictive Modeling of Fire Growth and Smoke Spread," NBSIR 85-3223, U.S. Department of Commerce, National Bureau of Standards (NBS), Gaithersburg, Maryland, 1985.

Heskestad, G. "Venting Practice," Section 7, Chapter 7, *NFPA Fire Protection Handbook*, 18th Edition, A.E. Cote, Editor-in-Chief, National Fire Protection Association, Quincy, Massachusetts, pp. 7–105, 1997.

Madrzykowski, D., "Office Station Heat Release Study: Full Scale vs Bench Scale," Interflam 1996, Conference Proceedings of the 7th International Interflam Conference, Interscience Communication Limited, England, Compiled by C.A. Franks, pp. 47–55, 1996.

Nelson, H.E., "An Engineering Analysis of the Early Stages of Fire Development: The Fire at the Dupont Plaza Hotel and Casino on December 31, 1986," NBSIR 87-3560, U.S. Department of Commerce, National Bureau of Standards (NBS), Gaithersburg, Maryland, May 1987.

NFPA 72, "National Fire Alarm Code," 1999 Edition, National Fire Protection Association, Quincy, Massachusetts.

NFPA 92B, "Guide for Smoke Management Systems in Malls, Atria, and Large Areas," 2000 Edition. National Fire Protection Association, Quincy, Massachusetts.

B.2 Elements of Hydraulic and Electrical Systems

Table B.2-1 provides the basic elements of a hydraulic systems along with the corresponding elements of an electrical system.

| Table B.2-1. Corresponding Elements of Hydraulic and Electrical Systems (NFPA 921, 2002 Edition) | |
|---|--|
| Elements of a Hydraulic System | Elements of an Electrical System |
| Pump | Generator |
| Pressure | Voltage (potential or electromotive force) |
| Pounds per square inch (psi) | Volts (V) |
| Pressure gauge | Voltmeter |
| Water | Electrons |
| Flow | Current |
| Gallons per minute (gpm) | Amperes (A) |
| Flowmeter | Ammeter |
| Valve | Switch |
| Friction | Resistance (Ohms) |
| Friction loss | Voltage drop |
| Pipe size (inside diameter) | Conductor size - AWG No. |

Hydraulic systems use a pump to create the hydraulic pressure necessary to force water through pipes. The amount of hydraulic pressure is expressed in pounds per square inch (psi) and can be measured with a pressure gauge. By contrast, electrical systems use a generator to create the necessary electrical pressure (voltage) to force electrons through a conductor. The amount of electrical pressure is expressed in volts and can be measured with a voltmeter.

In hydraulic systems, water flows in a useful way. The amount of water flow is expressed in gallons per minute (gpm) and may be measured with a flowmeter. By contrast, electrical systems, it is electrons that flow in a useful way in the form of electrical current. The amount of electrical current is expressed in amperes (A) and may be measured with an ammeter. Electric current can be either direct current (dc), such as supplied by a battery, or alternating current (ac), such as supplied by an electrical utility company.

In hydraulic systems, water pipes provide the pathway for the water to flow. By contrast, electrical systems, conductors such as wires provide the pathway for the current to flow.

In a closed circulating hydraulic system (as opposed to a fire hose delivery system, where water is discharged out of the end of the hose), water flows in a loop, returning to the pump, where it

again circulates through the loop. When the valve is closed, the flow stops everywhere in the system. When the valve is opened, the flow resumes. By contrast, an electrical system *must* be a closed system, in that the current must flow in a loop known as a complete circuit. When the switch is turned on, the circuit is completed and the current flows. When the switch is turned off, the circuit is open (incomplete) and the current flow stops everywhere in the circuit. This voltage drop is called the potential or electromotive force.

Friction losses in the pipes of a hydraulic system result in pressure drops. By contrast, electrical friction (i.e., resistance) in conductors and other parts of an electrical system results in electrical pressure drops or voltage drops. Ohm's law must be used to express resistance as a voltage drop.

When electricity flows through a conducting material, such as a conductor, a pipe, or any piece of metal, heat is generated. The amount of heat depends on the resistance of the material through which the current is flowing and the amount of current. Some electrical equipment, such as heating units, are designed with appropriate resistance to convert electricity to heat.

The flow of water in a pipe at a given pressure drop is controlled by the pipe size. A larger pipe allows a greater volume (more gallons per minute) of water to flow than a smaller pipe at a given pressure drop. Similarly, larger conductors allow more current to flow than smaller conductors. Conductor sizes are given in American Wire Gauge (AWG) numbers. The larger the number, the smaller the conductor diameter. The larger the diameter (and hence the larger the cross-sectional area) of the conductor, the lower the AWG number and the less the resistance the conductor has.

B.2.1 Reference

NFPA 921, "Guide for Fire and Explosion Investigations," 2001 Edition, National Fire Protection Association, Quincy, Massachusetts.

B.3 Classes of Fires

Generally the purpose of a letter designation given to a particular fire category to classify it according to the type of fuel and possible spread of the fire. The letter classification also provides a general indication of the severity and type of the hazard. NFPA 10, "Standard for Portable Fire Extinguishers," classifies fires as either Class A, Class B, Class C, Class D, or Class K according to the fuel involved.

Class A Fires

Fires in ordinary combustible materials, such as wood, cloth, paper, rubber, and many plastics.

Class B Fires

Fires in flammable or combustibles liquids, petroleum greases, tars, oils, oil-based paints, solvents, lacquers, alcohols, and flammable gases,.

Class C Fires

Fires that involve energized electrical equipment where the electrical nonconductivity of the extinguishing media is of importance. (When electrical equipment is de-energized, fire extinguishers designed for Class A or Class B fires can be safely used).

Class D Fires

Fires in combustible metals, such as magnesium, titanium, zirconium, sodium, lithium, and potassium.

Class K Fires

Fires in cooking appliances that involve combustible cooking media (vegetable or animal oils and fats).

B.3.1 Reference

NFPA 10, "Standard for Portable Fire Extinguishers," 2002 Edition, National Fire Protection Association, Quincy, Massachusetts.

This page intentionally left blank.

B.4 Classification of Hazards

B.4.1 Light (Low) Hazard

Light hazard occupancies are locations where the total amount of Class A combustible materials (including furnishings, decorations, and content), is a minor quantity. This can include some buildings or rooms occupied as offices, classrooms, churches, assembly halls, guest room areas of hotels/motels, and so forth. This classification anticipates that the majority of content items are either noncombustible or so arranged that a fire is not likely to spread rapidly. Small amounts of Class B flammables used for duplicating machines, art departments, and so forth, are included, provided that they are kept in closed containers and safely stored (Conroy, 1997 and NFPA 10).

B.4.2 Ordinary (Moderate) Hazard

Ordinary hazard occupancies are locations where of Class A combustibles and Class B flammables are present in greater total amounts than expected under light (low) hazard occupancies. These occupancies could consist of dining areas, mercantile shops, and allied storage; light manufacturing, research operations, auto showrooms, parking garages, workshop or support service areas of light (low) hazard occupancies; and warehouses containing Class I or Class II commodities as defined by NFPA 231, "Standard for General Storage," (Conroy, 1997 and NFPA 10).

B.4.3 Extra (High) Hazard

Extra hazard occupancies are locations where the total amount of Class A combustibles and Class B flammable (in storage, production, use, finished product, or combination thereof) is over and above those expected in occupancies classed as ordinary (moderate) hazard. These occupancies could consist of woodworking, vehicle repair, aircraft and boat servicing, cooking areas, individual product display showrooms, product convention center displays, and storage and manufacturing processes such as painting, dipping, and coating, including flammable liquid handling. Also included is warehousing or in-process storage of other than Class I or Class II commodities (Conroy, 1997 and NFPA 10).

B.4.4 References

Conroy, M.T. "Fire Extinguisher Use and Maintenance," Section 6, Chapter 23, *NFPA Fire Protection Handbook*, 18th Edition, A.E. Cote, Editor-in-Chief, National Fire Protection Association, Quincy, Massachusetts. 1997.

NFPA 10, "Standard for Portable Fire Extinguishers," 2002 Edition, National Fire Protection Association, Quincy, Massachusetts.

NFPA 231, "Standard for General Storage," National Fire Protection Association, Quincy, Massachusetts.

This page intentionally left blank.

B.5 Classes of Fires and Extinguishing Agents

One or more of the following mechanisms—more often, several of them simultaneously—can be used to extinguish fire:

- Physically separating the combustible substance from the flame
- Removing or diluting the oxygen supply
- Reducing the temperature of the combustible or of the flame
- Introducing chemicals that modify the combustion chemistry

For example, when water is applied to a fire of a solid combustible burning in air, several extinguishing mechanisms are involved simultaneously. The solid is cooled by the contact with water, causing its rate of pyrolysis, or gasification, to decrease. The gaseous flame is cooled, causing a reduction in heat feedback to the combustible solid and a corresponding reduction in the endothermic pyrolysis rate. Steam is generated, which, under some confined conditions, may prevent oxygen from reaching the fire. Water in the form of fog may block radiative heat transfer.

As another example, consider the application of a blanket of aqueous foam to a burning pool of flammable liquid. Several mechanisms may be operative. The foam prevents the fire's radiant heat from reaching the surface and supplying the needed heat of vaporization. If the fire point of the flammable liquid is higher than the temperature of the foam, the liquid is cooled and its vapor pressure decrease. If the flammable liquid is water soluble, such as alcohol, then, by a third mechanism, it will become diluted by water from the foam, and the vapor pressure of the combustible will be reduced.

As yet an example, when dry chemical is applied to a fire, the following extinguishing mechanisms may be involved:

- Chemical interaction with the flame
- Coating of the combustible surface
- Cooling of the flame
- Blocking or radiative energy transfer

The agent mentioned above—water, foam, and dry chemicals—each work by a combination of several mechanisms, and the relative importance of the various contributions varies with circumstances. Table B.5-1 provide the classes of fires with examples and extinguishing agent.

| Table B.5-1. Fire Classes with Extinguishing Agents | | | |
|--|--|---|--|
| Fire Class | Description | Examples | Extinguishing Agents |
| A | Ordinary combustibles | Wood, cloth, paper, rubber, and many plastics | Water, dry chemicals, foam, and some Halon |
| B | Flammable liquids, gases, and liquid-derived solids | Gasoline, oils, LPG, paraffin or heavy lubricants, grease | CO₂, dry chemical agents, Halon, foam (Class B extinguishers isolate the fuel from the heat by cutting off oxygen to the combustion zone or by inhibiting and interrupting the formation of molecular chain reactions) |
| C | The same fuels as Class A and B fires, together with energized electrical equipment | Energized Class A material, such as household appliances | CO₂, dry chemical agents, Halon (Extinguishers for Class C fires are rated according to the nonconductive properties of the extinguishing agent) |
| D | Combustible metals or metallic alloy elements with combustible metal components | Magnesium, sodium, potassium, titanium, zirconium, and lithium | Dry chemical agents (Water and water-based extinguishers should never be used on Class D fires. To be effective on a Class D fire, an extinguisher must suppress the fire without reacting physically or chemically with the combustible metal materials) |
| K | Cooking appliances that involve combustible cooking media | Vegetable or animal oils and fats | Dry chemical agents |

B.6 Classification of Flammable and Combustible Liquids

In common usage, *flammable* refers to a liquid that is readily ignited, burns rapidly and vigorously, and produces a lot of thermal energy—in other words, heat. *Combustible* usually refers to a liquid that is less easily ignited, burns less rapidly, and is, therefore, relatively safer. In simple terms, *flammable liquids* produce vapors at normal room temperature in concentrations that can be easily ignited by a small spark or flame. *Combustible liquids* do not produce vapors that can be ignited at normal room temperature. However, if a combustible liquid is heated up to or above its flash point, the vapors generated by the now-heated liquid can be ignited. In these cases, combustible liquids can be just as dangerous as flammable liquids. And, some of them, hydrocarbon fuels for examples, can burn just rapidly and evolve just much heat once they are ignited. Some common combustible liquids—mineral spirits and paint thinners, for example—are blended so they are just above the accepted dividing line between flammable and combustible. So, moderate heating of these liquids or storing them in a very warm environment can also present a fire hazard.

B.6.1 Flammable Liquid

According to the most fire safety codes (NFPA 30, "Flammable Combustible Liquids Code"), a flammable liquid is generally defined as any liquid that has a closed-cup flash point below 37.8 °C (100 °F). Flash points are determined by procedures and apparatus set forth in ASTM D56, "Standard Method of Test for Flash Point by the Tag Closed Tester".

NFPA 11 defined flammable liquids as any liquid having flash point below 37.8 °C (100 °F) and having a vapor pressure not exceeding 276 kPa (40 psi) (absolute) at 37.8 °C (100 °F).

Flammable liquids can be divided into classes (which are further divided into sub-classes), based on their flash points as summarizes in Table B.6-1.

Class I - Liquids have a flash point below 38 °C (100 °F) and subdivided as follows:

| Classification | Flash Point (°F) | Boiling Point (°F) | Example(s) |
|-----------------------|------------------|--------------------|---|
| Class IA Flammable | < 73 | < 100 | Ethyl ether Acetic aldehyde, Dimethyl sulfide, Furan |
| Class IB Flammable | < 73 | ≥ 100 | Ethyl alcohol, gasoline-92 octane, Cyclohexane |
| Class IC Flammable | ≥73 and < 100 | N/A | Butyl ether |

B.6.2 Combustible Liquid

A combustible liquid is defined as any liquid that has a closed-cup flash point above 37.8 °C (100 °F). Combustible liquids can be divided into classes (which are further divided into sub-classes), based on their flash points as summarized in Table B.6-2.

Class II Combustible liquids with flash points at or above 38 °C (100 °F), but below 60 °C (140 °F).

Class III Combustible liquids with flash points at or above 60 °C (140 °F).

| Classification | Flash Point (°F) | Boiling Point (°F) | Examples |
|-------------------------|------------------|--------------------|---|
| Class II Combustible | ≥ 100 | N/A | Fuel oil # 1 (kerosene), diesel fuel oil # 1-D/2-D/4-D, glacial acetic acid, and jet fuel (A & A-1) |
| Class III A Combustible | ≥ 140 and < 200 | N/A | Fuel oil # 6, creosote oil, and butyl carbitol |
| Class III B Combustible | ≥ 200 | N/A | Fuel oil # 4, mineral oil, olive oil, and lubricating oil (motor oil) |

Assume that a liquid spill occurs on a summer day when the ground has been heated by the sun to 35 °C (95 °F). Clearly, a spill of Class I (flammable) liquid is extremely hazardous with regard to fire; however, a spill of a Class II liquid is dangerous from a fire viewpoint only if a heat source exists that is capable of moderately raising the temperature of the liquid and a spill of Class III liquid is safe from ignition unless a heat source exists that can substantially raise its temperature.

Table B.6-3 lists the flash points of some common flammable and combustible liquids. Notice the wide range, from -43 °C to +243 °C (-45 °F to +469 °F). These values are meaningful only for bulk liquids. If a liquid with a high flash point is in the form of a spray, a froth, or a foam, with air present, and comes into contact with even a very small ignition flame, the tiny amount of liquid in contact will be immediately heated to above its flash point and will begin to burn. The combustion energy released will vaporize the surrounding spray or foam, and the fire will propagate (spread).

| Table B.6-3. Flash Points of Flammable and Combustible Liquids (Benedetti, 1997) | |
|---|--------------------------------|
| Liquid Fuel | Flash Point °C (°F) |
| <u>Class I (Flammable) Liquids</u> | |
| Gasoline | -43 (-45) |
| n-Hexane | -26 (-15) |
| JP-4 (jet aviation fuel) | -18 (0) |
| Acetone | -16 (3) |
| Toluene | 9 (48) |
| Methanol | 11 (52) |
| Ethanol | 12 (54) |
| Turpentine | 35 (95) |
| <u>Class II (Combustible) Liquids</u> | |
| No.2 fuel oil (domestic) | >38 (>100) |
| Diesel fuel | 40–50 (104–131) |
| Jet A (jet aviation fuel) | 47 (117) |
| Kerosene | 52 (126) |
| No. 5 fuel oil | >54 (>130) |
| <u>Class III (Combustible) Liquids</u> | |
| JP-5 (jet aviation fuel) | 66 (151) |
| SAE No. 10 lube oil | 171 (340) |
| Triresyl phosphate | 243 (469) |

B.6.3 Storage of Flammable and Combustible Liquids

Flammable and combustible liquids are packed, shipped, and stored in bottle, drums, and other containers ranging in size up to 60 gal (225 L). Additionally, liquids are shipped and stored in intermediate bulk containers up to 793 gal (3,000 L) and in portable intermodal tanks up to 5,500 gal (20,818 L). Storage requirements for each these containers are covered in the NFPA 30 chapters entitled, "Containers and Portable Tank Storage," with the exception of those portable tanks larger than 793 gal (3,000 L) that are required to meet the applicable requirements covered in the NFPA 30 chapter entitled, "Tank Storage".

Examples of containers types used for the storage of liquids include glass, metal, polyethylene (plastic), and fiberboard. The maximum allowable size for the different types of containers is governed by the class of flammable or combustible liquid to be stored in it. Table B.6-4 lists the maximum allowable size (capacity) of a container or metal tank used to store flammable and combustible liquids.

| Table B.6-4. Maximum Allowable Size of Containers and Portable Tanks for Flammable and Combustible Liquids (NFPA 30, 2000 Edition) | | | | | |
|--|------------------|----------|----------|--------------------|-----------|
| Liquids Container Type | Flammable Liquid | | | Combustible Liquid | |
| | Class IA | Class IB | Class IC | Class II | Class III |
| Glass | 1 pt | 1 qt | 1 gal | 1 gal | 5 gal |
| Metal (other than DOT drum) or approved plastic | 1gal | 5 gal | 5 gal | 5 gal | 5 gal |
| Safety cans | 2 gal | 5 gal | 5 gal | 5 gal | 5 gal |
| Metal drum (DOT specification) | 60 gal | 60 gal | 60 gal | 60 gal | 60 gal |
| Approved metal portable tank and IBC | 793 gal | 793 gal | 793 gal | 793 gal | 793 gal |
| Rigid plastic IBC (UN 31H1 or 31H2) or composite IBC (UN 31HZ1) | NP | NP | NP | 793 gal | 793 gal |
| Polyethylene (DOT specification 34, UN 1H1, or as authorized by DOT exemption) | 1 gal | 5 gal | 5 gal | 60 gal | 60 gal |
| Fiber drum (NMFC or UFC Type 2A; Types 3A, 3B-H, or 3B-L; or Type 4A) | NP | NP | NP | 60 gal | 60 gal |
| SI Units - 1pt = 0.473 L; 1 qt = 0.95 L; 1 gal = 3.8 L NP = Not Permitted IBC = Intermediate Bulk Container DOT = U.S. Department of Transportation | | | | | |

B.6.4 Flammable Combustible Storage Cabinets

Most commercially available and approved storage cabinets are built to hold 60 gallons (227 liters) or less of flammable and/or combustible liquids.

Not more than 120 gal (454 L) of Class I, Class II, and Class IIIA liquids shall be stored in a storage cabinet. Of this 120 gal total, not more than 60 gal (227 L) shall comprise Class I and Class II liquids.

B.6.5 Definitions

Flash Point

The minimum temperature to which a liquid must be heated in a standardized apparatus, so that a transient flame moves over the liquid when a small pilot flame is applied.

Alternately, the flash point of a liquid may be defined as the temperature at which the vapor and air mixture lying just above its vaporizing surface is capable of just supporting a momentary flashing propagation of a flame prompted by a quick sweep of small gas pilot flame near its surface (hence the term flash point). The flash point is mainly applied to liquids. The flash point of liquid is one of its characteristics that normally determines the amount of fire safety features required for its handling, storage, and transport.

Fire Point

The minimum temperature to which a liquid must be heated in a standardized apparatus, so that sustained combustion results when a small pilot flame is applied, as long as the liquid is at normal atmospheric pressure.

Boiling Point

The temperature at which the transition from the liquid to the gaseous phase occurs in a pure substance at fixed pressure.

Alternately, the boiling point may be defined as the temperature at which the vapor pressure of a liquid equals the surrounding atmospheric pressure. For purposes of defining the boiling point, atmospheric pressure shall be considered to be 14.7 psia (760 mm Hg). For mixtures that do not have a constant boiling point, the 20-percent evaporated point of a distillation performed in accordance with ASTM D86, "Standard Method of Test for Distillation of Petroleum Products," shall be considered to be the boiling point.

Autoignition

Initiation of fire or combustion by heat but without the application of a spark or flame.

Autoignition Temperature

The lowest temperature at which a mixture of fuel and oxidizer can propagate a flame without the aid of an initiating energy source (pilot, spark, or flame).

High Risk Fuel

Class IA, IB, IC, or II liquids as defined by NFPA 30, "Flammable and Combustible Liquids Code," or Class IIIA, or III B liquids heated to within 10 °C (50 °F) of their flash point, or pressurized to 174.4 kPa (25.3 psi) or more.

B.6.6 Hazardous Materials

A substance (solid, liquid, or gas) capable of creating harm to people, property, and the environment. The general category of hazard assigned to a hazardous material under the U.S. Department of Transportation (DOT) regulation. Table B.6-5 lists the hazardous material classification.

| Table B.6-5. Hazardous Material Classification | |
|---|--|
| Hazard Class | Description |
| Class 1 - Explosives Division 1.1 Division 1.2 Division 1.3 Division 1.4 Division 1.5 Division 1.6 | Explosive with a mass explosion hazard Explosives with a projection hazard Explosives with predominantly a fire hazard Explosives with no significant blast hazard Very insensitive explosives Extremely insensitive explosive articles |
| Class 2 Division 2.1 Division 2.2 Division 2.3 Division 2.4 | Flammable gas Nonflammable, non-poisonous compressed gas Poison gas Corrosive gas |
| Class 3 - Flammable Liquid Division 3.1 Division 3.2 Division 3.3 | Flammable liquids, flash point < 0 °F Flammable liquids, flash point 0 °F and above but < 73 °F Flammable liquids, flash point 73 °F and up to < 141 °F combustible liquid |
| Class 4 Division 4.1 Division 4.2 Division 4.3 | Flammable solid Spontaneously combustible material Dangerous when wet material |
| Class 5 Division 5.1 Division 5.2 | Oxidizer Organic peroxide |
| Class 6 Division 6.1 Division 6.2 | Poisonous material Infectious material |
| Class 7 | Radioactive material |
| Class 8 | Corrosive material |
| Class 9 | Miscellaneous hazardous material, ORM-D material |

B.6.7 References

Benedetti, R.P., Editor, "Flammable and Combustible Liquids Code Handbook," 6th Edition,, National Fire Protection Association, Quincy, Massachusetts, 1997.

NFPA 11, "Standard for Low-Expansion Foam," 2002 Edition, National Fire Protection Association, Quincy, Massachusetts.

NFPA 30, "Flammable and Combustible Liquids Code," 2000 Edition, National Fire Protection Association, Quincy, Massachusetts.

This page intentionally left blank.

B.7 Classification of Flammable Gases

B.7.1 Classification

Flammable gases are classified according to the maximum experimental safe gap (MESG), which prevents flame passage. MESG is determined by test IEC 79-1A, "Electrical Apparatus for Explosive Gas Atmospheres," International Electrotechnical Commission (IEC), 1975 (Senecal, 1997).

Class I **Group A - acetylene**
 Group B - hydrogen
 Group C - ethylene
 Group D - propane

Division 1 **Flammable gases or combustible dust may be present at ignitable concentrations, under normal operating conditions.**

Division 2 **Where hazardous materials may be handled, processed, or used; ignitable atmospheres not normally present due to containment or ventilation of hazardous materials; areas adjacent to Division 1 locations.**

B.7.2 Definitions

Flammable Limits

The minimum and maximum concentration of combustible material in a homogeneous mixture with a gaseous oxidizer that will propagate a flame.

Upper and Lower Flammability Limits

Concentration of fuel in air in which a premixed flame can propagate.

Lower Flammability Limit

The lowest concentration of fuel in air at normal temperature and pressure that can support flame propagation is known as the lower flammability limit (LFL) or lower explosive limit (LEL).

Upper Flammability Limit

The highest concentration of fuel in air at normal temperature and pressure that can support flame propagation is known as the upper flammability limit (UFL) or upper explosive limit (UEL).

B.7.3 Reference

Senecal, J.A., "Explosion Prevention and Protection," Section 4, Chapter 14, *NFPA Fire Protection Handbook*, 18th Edition, A.E. Cote, Editor-in-Chief, National Fire Protection Association, Quincy, Massachusetts, 1997.

This page intentionally left blank.

B.8 Flammability Hazards of Gases

B.8.1 Flammability Potential of Gases

Flammability hazards in a tank or vessel dependent upon the potential for developing a flammable fuel/oxidant/inert gas mixture in the tank or vessel head space. Mixtures of fuel and air are only flammable for limited fuel/air ratio. The most flammable mixture is a stoichiometric mixture, in which the fuel and air (oxygen) are present in exactly the right proportions for oxidation, as dictated by the stoichiometry of the fuel/oxygen combustion reaction. Mixtures with some excess oxygen or excess fuel are also flammable, the lowest concentration of fuel in air that can support flame propagation at normal temperature and pressure is known as the lower explosive limit (LEL). Similarly, the highest concentration of fuel in air that can support flame propagation at normal temperature and pressure is known as the upper explosive limit (UEL). Mixtures of fuel in air with intermediate fuel concentrations will support flame propagation.

The flammability of gas mixtures is determined by one of two widely utilized laboratory methods. The first method uses a 5-foot-long tube that is filled with the test mixture, and a spark is used to ignite the mixture at one end to observe whether ignition occurs and whether the flame can propagate to the other end of the tube. The second method uses a spherical tank or vessel that is filled with the test mixture, and a spark is used to ignite the mixture at the center of the tank or vessel to measure the pressure increase to determine whether flame propagation occurred throughout the tank or vessel (Beyler, 1995). The spherical vessel test method is more representative of an actual tank or vessel than is the tube method.

The terms "explosive limits" and "flammable limits" are used interchangeably in the technical literature. Explosive limits simply refer to compositions, which define when flame propagation is possible. The flame propagation is known as a deflagration and results in a pressure increase as the flame passes through a vessel. This resulting overpressure is the origin of the term explosive limit, where an explosion is any event, that results in a sudden overpressure in the vessel.

The LEL mixture has excess oxygen and insufficient fuel for complete burning. This is known as "fuel lean". The potential heat output, which defines how hot the products of combustion can be is limited not by oxygen, but by fuel concentration. The ideal "no heat loss" post-combustion temperature is known as the "adiabatic flame temperature" (AFT). For most flammable gases, the AFT at atmospheric pressure is about 2,300 K (3,680 °F) for stoichiometric mixtures of fuel in air, and is reduced to about 1,600 K (2,420 °F) for LEL mixtures. The AFT can be calculated using any of a number of chemical equilibrium computer programs, like STANJAN (Reynolds, 1986). The use of such a computer program allows the analysis to be performed for a tank-specific mixture, so that the results are representative of the actual tank environment.

B.8.2 Flammability Potential of Hydrogen

Hydrogen is a highly flammable gas with novel flammability properties and unusually broad explosive limits. Based on upward propagation in the standard flammability tube, the LEL is 4-percent hydrogen in air and the UEL is 75-percent (Zabetakis, 1965). For most gases, the LELs for upward and downward propagation do not differ greatly. However, for hydrogen, the LEL for downward propagation is 8-percent (Furno et al., 1971). The significance of this difference is

that in order for the flame to propagate throughout a tank or a vessel, it must propagate in all directions. As such, overpressures associated with hydrogen explosions are not observed at hydrogen concentrations below 8-percent. This behavior was observed by Furno et al., 1971, in 12-foot spherical vessel experiments using lean hydrogen/air mixtures. Overpressures were only measured above 8-percent hydrogen, and the pressures did not match the theoretical overpressures until about 10-percent hydrogen. Thus, while the LEL of hydrogen is widely quoted as 4-percent, explosion hazards will not occur below 8-percent.

The novel behavior of hydrogen is not reflected in documents like NFPA 69, "Standard on Explosion Prevention Systems." As such, standards of care like NFPA 69, provide an implicit additional safety factor for hydrogen that should be understood in assessing hazards.

B.8.3 Flammable Limits, Detonable Limits, and Potential for Deflagration-to-Detonation Transitions

The formation of flammable fuel/oxidant mixtures within a tank can lead to premixed flame propagation in the form of deflagration or a detonation. The formation of a flammable mixture can result from steady-state generation and transport of flammable gases and oxidizers from an aqueous solution or waste containing radioactive isotopes, from episodic releases of such gases trapped within the waste, or from the formation of large gas bubbles within the waste which contain flammable mixtures of fuels and oxidizers.

Before assessing the potential flammable gas generation rates and resulting flammable gas mixture, it is useful to assess the relevant limits. In mixtures with fuel gas concentrations above the LEL indefinite propagation of a deflagration is possible. Above the detonable limit, indefinite propagation of a detonation is possible given a source that is capable of directly detonating the mixture. While LEL's are a property of the mixture alone, the detonable limits are also impacted by the environment. The ability for a deflagration-to-detonation transition (DDT) is contingent upon both the mixture and the environment. The primary flammable gas is hydrogen.

B.8.4 Flammable Gas Generation

Flammable gases are generated with the aqueous solution or waste by several processes within a tank or a vessel. Specifically, these processes may include (1) radiolysis of the water and waste to produce hydrogen and ammonia, (2) corrosion of the steel liner to produce hydrogen, and (3) chemical decomposition of the waste. These processes generate hydrogen, methane, ammonia, and nitrous oxide, the first three of which are flammable gases, while the fourth is an oxidizer.

B.8.5 Explosion Prevention Methods

The flammability of a tank or vessel can be managed by controlling either the flammable gas concentration or oxygen concentration. Where the oxygen concentration is to be controlled, it needs to be maintained below the limiting oxidant concentration (LOC) (NFPA 69) (LOC is defined as the concentration of oxidant below which deflagration cannot occur in a specified mixture). Safety margins require maintaining the oxygen at 60-percent of the LOC if the LOC is above 5-percent, or 4-percent of the LOC if the LOC is below 5-percent. Where flammability is measured

by controlling the flammable gas concentration, it needs to be maintained below 25-percent of the LEL.

Control of the oxygen concentration is achieved through the use of an inert purge gas. By contrast, control of flammable gas concentration is normally achieved through air dilution or by controlling of flammable gas evolution or regeneration or by catalytic oxidation of flammable gases.

While NFPA 69, provides standards for inerting the tanks, such inerting is not required by codes and standards for flammable liquid storage containers, such as the Uniform Fire Code Article 79; 1997, NFPA 30, 1996 Edition; 49 CFR; FM Data Sheet 7-88, "Storage Tanks for Flammable and Combustible Liquids," 1999; and FM Data Sheet 7-29, "Flammable Liquid Storage," 1999. These codes and standards recognize that ignition sources will not be present in passive containers, so that it is not necessary to control the composition of gases in the tank. By contrast, FM Data Sheet 7-32, "Flammable Liquids Operation," 1993, recommends that processing equipment with the potential for an explosion should have at least one of the following characteristics:

- equipped with explosion venting
- designed to withstand the explosion overpressure
- fitted with an inerting system
- fitted with an explosion suppression system

Tank inerting is recognized as a means of preventing explosions in processing vessels, which are inherently dynamic systems where ignition sources can be limited but not excluded.

B.8.6 References

Beyler, C.L., "Flammability Limits of Premixed and Diffusion Flames," Section 2, Chapter 2-9, *SFPE Handbook of Fire Protection Engineering*, 2nd Edition, P.J. DiNenno, Editor-in-Chief, National Fire Protection Association, Quincy, Massachusetts, 1995.

FM Data Sheet 7-29, "Flammable Liquid Storage," Factory Mutual Engineering Corporation, Norwood, Massachusetts.

FM Data Sheet 7-32, "Flammable Liquid Operations," Factory Mutual Engineering Corporation, Norwood, Massachusetts.

FM Data Sheet 7-88, "Storage Tanks for Flammable and Combustible Liquids," Factory Mutual Engineering Corporation, Norwood, Massachusetts.

Furno, A., E. Cook, J. Kuchta, and D. Burgess, "Some Observations on Near-Limit Flames," Thirteenth Symposium (International) on Combustion, The Combustion Institute, Pittsburgh, Pennsylvania, pp. 593–599, 1971.

NFPA 30, "Flammable and Combustible Liquids Code," 2000 Edition National Fire Protection Association, Quincy, Massachusetts.

NFPA 69, "Standard on Explosion Prevention Systems," 1997 Edition, National Fire Protection Association, Quincy, Massachusetts.

Reynolds, W.C., "The Element Potential Method for Chemical Equilibrium Analysis: Implementation in the Interactive Program STANJAN, Version 3, Department of Mechanical Engineering, Stanford University, 1986.

Uniform Fire Code (UFC), Article 79, "Flammable and Combustible Liquids," International Fire Code Institute, 1997.

Code of Federal Regulations, Title 49, Part 100–177, "Hazardous Materials Transportation," U.S. Government Printing Office, Washington DC.

Zabetakis, M.G., "Flammability Characteristics of Combustible Gases and Vapors," Bulletin 627, U.S. Bureau of Mines, Washington, DC, 1965.

B.9 Combustion Properties of Pure Metals in Solid Form

Nearly all metals will burn in air under certain conditions. Some oxidize rapidly in the presence of air or moisture, generating sufficient heat to reach their ignition temperatures. Others oxidize so slowly that heat generated during oxidation dissipates before the metal becomes hot enough to ignite. Certain metals (notably magnesium, titanium, sodium, potassium, lithium, zirconium, hafnium, calcium, zinc, plutonium, uranium, and thorium) are referred to as "combustible metals" because of the ease of ignition when they reach a high specific area ratio (thin sections, fine particles, or molten states). However, the same metals are comparatively difficult to ignite in massive solid form.

Some metals (such as aluminum, iron, and steel) that are not normally thought of as combustible, may ignite and burn when in finely divided form. Clean fine steel wool, for example, may ignite. Particle size, shape, quantity, and alloy are important factors to be considered when evaluating metal combustibility. Combustibility of metallic alloys may differ and vary widely from the combustibility characteristics of the alloys' constituent elements. Metals tend to be most reactive when in finely divided form and may require shipment and storage under inert gas or liquid to reduce fire risks.

Hot or burning metals may react violently upon contact with other materials, such as oxidizing agents and extinguishing agents used on fires involving ordinary combustibles or flammable liquids. Temperatures produced by burning metals can be higher than temperatures generated by burning flammable liquids. Some metals can continue to burn in carbon dioxide, nitrogen, water, or steam atmospheres in which ordinary combustibles or flammable liquids would be incapable of burning.

Properties of burning metal cover a wide range. Burning titanium, for example, produces little smoke, while burning lithium exudes dense and profuse smoke. Some water-moistened metal powders (such as zirconium) burn with near-explosive violence, while the same powder wet with oil burns quiescently. Sodium melts and flows while burning; calcium does not. Some metals (such as uranium) acquire an increased tendency to burn after prolonged exposure to moist air, while prolonged exposure to dry air makes it more difficult to ignite.

The toxicity of certain metals is also an important factor in fire suppression. Some metals (especially heavy metals) can be toxic or fatal if they enter the bloodstream or their smoke fumes are inhaled. ***Metal fires should never be approached without proper protective equipment (clothing and respirators).***

A few metals (such as thorium, uranium, and plutonium) emit ionizing radiation that can complicate fire fighting and introduce a radioactive contamination problem. Where possible, radioactive materials should not be processed or stored with other pyrophoric materials because of the likelihood of widespread radioactive contamination during a fire. Where such combinations are essential to operations, appropriate engineering controls and emergency procedures should be in place to prevent or quickly suppress fires in the event that the controls fail.

Because extinguishing fires in combustible metals involves techniques not commonly encountered in conventional fire fighting operations, it is necessary for those responsible for controlling combustible metal fires to be thoroughly trained before an actual fire emergency arises.

Table B.9-1. Melting, Boiling, and Ignition Temperatures of Pure Metals in Solid Form (Tapscott, 1997) (Waiting for copyright permission)

| Metal | Melting Temperature (°C) | | Boiling Temperature (°C) | | Ignition Temperature (°C) | |
|-------|--------------------------|---|--------------------------|---|---------------------------|---|
| | 1 | 2 | 1 | 2 | 1 | 2 |
| | | | | | | |
| | | | | | | |
| | | | | | | |
| | | | | | | |
| | | | | | | |
| | | | | | | |
| | | | | | | |
| | | | | | | |
| | | | | | | |
| | | | | | | |
| | | | | | | |
| | | | | | | |
| | | | | | | |
| | | | | | | |
| | | | | | | |
| | | | | | | |
| | | | | | | |
| | | | | | | |
| | | | | | | |
| | | | | | | |
| | | | | | | |
| | | | | | | |

B.9.1 Reference

Tapscott, R.E. "Metals," Section 4, Chapter 16, *NFPA Fire Protection Handbook*, 18th Edition, A.E. Cote, Editor-in-Chief, National Fire Protection Association, Quincy, Massachusetts. 1997.

B.10 Extinguishing Agents for Metal Fires

Water is not usually recommended for fires involving metals since a number of metals can react exothermically with water to form hydrogen, which, of course, burns rapidly. Furthermore, violent steam explosions can result if water enters molten metal. As an exception, fires have been successfully extinguished when large quantities of water were applied to small quantities of burning magnesium in the absence of pools of molten magnesium.

Table B.9-1 lists extinguishing agents used for various metal fires. In general, metal fires are difficult to extinguish because of the very high temperatures involved and the correspondingly long cooling times required. Note that certain metals react exothermically with nitrogen or carbon dioxide, so the only acceptable inert gases for these metals are helium and argon. Halons should not be used on metal fires.

| Table B.10-1. Extinguishing Agents for Metal Fires (Friedman, 1998 and Tapscott, 1997) (Waiting for copyright permission) | | |
|--|--|--|
| | | |
| | | |
| | | |
| | | |
| | | |
| | | |
| | | |
| | | |
| | | |
| | | |
| | | |
| | | |
| | | |
| | | |
| | | |
| | | |
| | | |
| | | |
| | | |
| | | |

B.10.1 References

Friedman, R., *Principles of Fire Protection Chemistry and Physics*, "Fire-Fighting Procedures," Chapter 14, 3rd Edition, National Fire Protection Association, Quincy, Massachusetts, 1998.

Tapscott, R.E., "Combustible Metal Extinguishing Agents and Application Techniques," Section 6, Chapter 26, *NFPA Fire Protection Handbook*, 18th Edition, A.E. Cote, Editor-in-Chief, National Fire Protection Association, Quincy, Massachusetts, 1997.

B.11 Occupancy Classification and Use Groups

National Fire Code (NFC) requirements are occasionally tied to specific type of occupancy. While NPPs are fundamentally industrial occupancy, it is important to have a basic understanding of other occupancy classifications in order to be able to recognize this connection.

The use group classification of a building is probably the most significant design factor that affects the safety of the occupants and fire suppression forces that are called upon in the event of fire. The building's height and size, type of construction, type and capacity of exit facilities, and fixed fire suppression systems are all dependent on this classification. The use group classification system as the foundation for the building and fire prevention codes.

B.11.1 Occupancy Classification

The model building codes¹ and NFPA 101 (Life Safety Code[®]) separate buildings into about ten general uses:

- Assembly
- Business
- Educational
- Factory or Industrial
- High Hazard or Hazardous
- Institutional
- Mercantile
- Residential
- Storage
- Utility, Miscellaneous, or Special

The use are further separated into use groups based on specific characteristics. A church, a nightclub, and a family restaurant are all assemblies, but the specific characteristics of their occupants and functions differ drastically, requiring different built-in levels of protection. The occupants of a church are probably very familiar with the building that they occupy. They have been there before and they know the locations of alternative exits. The occupants of a nightclub may not be so familiar with the building. Dim lighting, loud music, and impairment by alcohol are all common features that may further compromise the ability of the occupants to identify a fire emergency and take appropriate measures to escape.

- Assembly (A) occupancies are subdivided by function, as well as the number of occupants they hold. Assemblies that hold fewer than 50 person are generally considered to be less-restrictive business uses. The Uniform Building Codes (UBC) and Standard Building Codes (SBC) further subdivide assemblies that hold many people. Such assemblies include

¹Model Building Codes

Building Officials & Code Administrators International, Inc. (BOCA) - National Building Codes (NBC).
International Conference of Building Officials (ICBO) - Uniform Building Code (UBC).
Southern Building Code Congress International, Inc., (SBCCI) - Standard Building Code (SBC).

churches, restaurants with occupant loads that exceed 50 persons (100 under the SBC), auditoriums, armories, bowling alleys, courtrooms, dance halls, museums, theaters, and college classrooms that hold more than 50 persons (100 under the SBC).

- **Business (B) areas** include college classrooms with occupant loads up to 50 (100 under the SBC), doctor's and other professional offices, fire stations, banks, barber shops, and post offices. Dry cleaners who use noncombustible solvents (Types IV and V) also qualify as Business uses.
- **Educational (E) areas** include facilities that are *not* used for business or vocational training (shop areas) for students up to and including the twelfth grade. Colleges and universities are Business or Assembly areas (depending on the number of occupants). Day care facilities may be classified as Educational or Institutional depending on the model code.
- **Factory or Industrial (F) areas** include industrial and manufacturing facilities and are subdivided into moderate and low-hazard facilities. High-hazard factory and industrial areas are bumped up from the F Use Group to the H Use Group. Dry cleaners employing combustibles solvents (types II and III) are moderate-hazard factory and industrial uses.
- **High Hazard or Hazardous (H) areas** are those in which more than the exempt amount of a hazardous material or substance is used or stored. Exempt amounts of hazardous materials are not exempt from the provisions of the code. They are a threshold amounts by material, above which the occupancy must comply with the stringent requirements of the H Use Group.
- **Institutional (I) areas** may include halfway houses and group homes, hospitals and nursing homes, and penal institutions. The model codes differ in their breakdown. Care must be taken when considering homes for adults and day care centers as to whether the occupants are ambulatory or capable of self-preservation. The model codes all contain significantly more stringent requirements for institutional occupancies where a "defend-in-place" strategy is necessary because of the inability of the occupants to flee the structure without assistance.
- **Mercantile (M) uses** include retail shops and stores and areas that display and sell stocks of retail goods. Automotive service stations that do minor repairs are considered Mercantile uses.
- **Residential (R) areas** include hotels and motels, dormitories, boarding houses, apartments, townhouses, and one- and two-family dwellings.
- **Storage (S) areas** are used for to store goods and include warehouses, storehouses, and freight depots. Storage uses are separated into low and moderate-hazard storage uses. Auto repair facilities that perform major repairs, including engine overhauls and body work or painting are considered Moderate-Hazard Storage Occupancies by the National Building Codes (BOCA) and Standard Building Codes (SBCCI), and hazardous by the Uniform Building Codes (ICBO). Occupancies that store more than the exempt amounts of hazardous materials or substances are considered H Use Group Occupancies.

- Utility (U), Miscellaneous, or Special Structures, depending on the model code include those that are not classified under any other specific use. Such structures may include tall fences cooling towers, retaining walls, and tanks.
- Mixed use, buildings often contain multiple occupancies with different uses. For example, a three-story building might have a restaurant (assembly) and computer store (mercantile) on the first floor and professional offices throughout the rest of the building. The model code provides for such situations either by requiring that the whole building be constructed to all requirements of the most restrictive use group or by separating the areas with fire-rated assemblies, or by separating the building with fire walls, thereby creates separate buildings. By far the least expensive and most attractive method of separating mixed uses is by using fire separating assemblies, but this method is sometimes impossible because of building height and area requirements.

B.11.2 Special Use and Occupancy Requirements

For most buildings and structures, assigning a use group and then specifying building requirements for all buildings within that use group works relatively well. Most mercantile occupancies share common hazards. Most business occupancies have similar occupants and processes. But what if a given business happens to be on the twenty-sixth floor of a high-rise building? Or what if the men's clothing store is in the middle of a giant shopping mall? The relative hazards suddenly change, and we begin comparing apples to oranges.

Building codes provide an enhanced level of protection for certain occupancies to compensate for special hazards over and above those posed by the use of the building. The inherent hazards posed by being located twenty-six stories above the ground or in a large open area with high fire loading such as a shopping mall are addressed as special use requirements.

B.11.3 Code Advances/Changes

It is important to recognize that NPPs have their design basis rooted in 1970's era code requirements. In some cases, fire science advances revise, or establish new code requirements. A good example is carpeting found in MCR. The original NPPs required ASTM E84, "Standard Test for Surface Characteristics of Building Materials," Class A flame spread requirements. Fire science advances have developed more specialized test methods for carpeting, ASTM E648, "Standard Test Method for Critical Radiant Flux of Floor-Covering Systems Using a Radiant Heat Energy Source". As a result of this, manufacturers do not test the material to 1970's vintage test method. When a NPP perform a plant modification, e.g., replace the carpet in the MCR, ASTM E84 rated carpet is not longer manufacturer. The licensee will either have to perform their own ASTM E84 testing on the proper carpet or prepare an engineering analysis on the commercially available carpeting that is tested to newer test methods recognized by NFPA 101, "Life Safety Code[®]".

Another area of change is cable flame spread testing. Since no new NPPs are being built there is little incentive for cable vendors to qualify electrical cables to IEEE 383 requirements. In parallel, the building code groups are recognizing by grouped electrical cables and testing organizations prepared specialized test methods and rating systems based on application of the cable; UL 910

Test Method for Fire and Smoke Characteristics of Electrical and Optical-Fiber Cables used in Air Handling Spaces. UL 1581 Reference Standard for Electrical Wires, Cables, and Flexible Cords. UL 1666 Standard Test for Flame Propagation Height of Electrical and Optical-Fiber Cable installed Vertically in Shafts. UL 1685 Fire Test of Limited-Smoke Cables.

B.11.4 References

ASTM Fire Test Standard, Fifth Edition, American Society of Testing and Materials, West Conshohocken, Pennsylvania, pp. 765-780, 1999.

ASTM E 648-98¹, "Standard Test Method for Critical Radiant Flux of Floor-Covering Systems Using a Radiant Heat Energy Source," ASTM Fire Test Standard, Fifth Edition, American Society of Testing and Materials, West Conshohocken, Pennsylvania, pp. 894-907, 1998.

NFPA 101[®], "Life Safety Code[®]," 2003 Edition, National Fire Protection Association, Quincy, Massachusetts.

UL 910, "Test Method for Fire and Smoke Characteristics of Electrical and Optical-Fiber Cables used in Air Handling Spaces".

UL 1581, "Reference Standard for Electrical Wires, Cables, and Flexible Cords".

UL 1666, "Standard Test for Flame Propagation Height of Electrical and Optical-Fiber Cable installed Vertically in Shafts".

UL 1685, "Fire Test of Limited-Smoke Cables".

B.12 Building Limitations and Types of Construction

Two of the most effective methods used over the years to limit potential fire spread and prevent conflagration have been limiting the size of buildings and regulating the materials used in their construction. One of the primary purposes of a building code is to prescribe standards that will keep buildings from falling down. Besides gravity, there are many forces that act against a building. Snow loads, wind loads, and potential earthquake loads are provided for in the building code for design and construction of buildings. It can be considered that the potential force that requires the most extensive code provisions is fire. Large portion of the model building codes addresses fire protection issues, fire safety, emergency egress, and structural stability.

The key to understanding building code provisions for structural protection from fire is the concept of fire resistance. In broad terms, fire resistance (also called fire endurance) it is the ability of a building to resist collapse or total involvement in fire. Fire resistance is measured by the length of time typical structural members and assemblies resist specified temperatures. The building codes define fire resistance as that property of materials or their assemblies which prevents or retards the passage of excessive heat, hot gases, or flames under conditions of use.

B.12.1 Types of Construction

There are three key points to remember when dealing with building construction types:

- All construction is either combustible (it will burn) or noncombustible (it won't).
- When applied to construction materials, "protected" refers to measures to reduce or eliminate the effects of fire encasement. Concrete, gypsum, and spray-on coatings are all used to protect construction elements. When the code means "protected with a sprinkler systems," it will say just that.
- Having the ability to determine the construction type by eyeballing a building is not a requirement.

B.12.2 Five Construction Types

The model building codes and NFPA 220, "Standard on Types of Building Construction," recognize five construction types. The Standard Building Code subdivides noncombustible construction and uses six types. The terms vary a little between the different codes, but the concept is the same, based on the classifications from NFPA 220.

Type I Fire Resistive In Type I construction, the structural elements are noncombustible and protected. Type I is divided into two or three subtypes, depending on the model code. The difference between them is the level of protection for the structural elements (expressed in hours).

Only noncombustible materials are permitted, and structural steel must not be exposed. A high-rise building with an encased steel structure is an example of a Type I building.

Type II Noncombustible In Type II construction, the structural elements are either noncombustible or limited combustible. Type II is subdivided into subtypes, dependent upon the level of protection (in hours) for the structural elements. The buildings are noncombustible, but afford limited or no fire resistance to the structural elements. A strip shopping center, with block walls, steel bar joists, unprotected steel columns, and a steel roof deck is an example of a Type II building.

Type III Limited Combustible (Ordinary) In Type III construction, the exterior walls are noncombustible (masonry) and may be rated based on the horizontal distance to exposure. The interior structural elements may be combustible or a combination of combustible and noncombustible. Type III is divided into two subtypes (protected and unprotected). The brick, wood joisted buildings that line city streets are of Type III (ordinary) construction. Buildings with a masonry veneer over combustible framing are not Type III.

Type IV Heavy Timber In type IV construction, the exterior walls are noncombustible (masonry) and the interior structural elements are unprotected wood of large cross-sectional dimensions. Columns must be at least 8 inches if they support a floor load, joists, and beams must be a minimum of 6 inches in width and 10 inches in depth. Type IV is not subdivided. The inherent fire-resistant nature of large-diameter wood members is taken into account. Concealed spaces are not permitted.

Type V Wood Frame In Type V construction, the interior structure may be constructed of wood or any other approved material. Brick veneer may be applied, but the structural elements are wood frame. Type V is divided into two subtypes (protected and unprotected), again depending on the protection provided for the various structural elements.

B.12.3 Fire Resistance Ratings

The various model codes and NFPA 220 each have a table containing the rating (in hours) of the various structural elements. Table B.12-1 summarizes the required ratings by building component type, depending upon the construction classification of the building. The construction classifications used by the model codes and NFPA 220 do not exactly match, type for type. Table B.12-1 and B.12-2 provides an approximate comparison. A notational system was developed to identify the fire resistance required for the three basic elements of the building. These elements are (1) the

exterior wall (2) the primary structural frame, and (3) the floor construction. A three digit notation was developed, as follows:

- (1) First digit - Hourly fire resistance requirement for exterior bearing wall fronting on a street or lot line.
- (2) Second digit - Hourly fire resistance requirement for structural frame or columns and girders supporting loads from more than one floor.
- (3) Third digit - Hourly fire resistance requirement for floor construction.

Thus for example, a "332" building would have 3-hr fire resistant exterior bearing walls, a 3-hr fire resistant structural frame, and 2-hr fire resistant floor construction, and would correspond to the NFPA 220 Type I (332) building, the BOCA National Building Code Type 1B building, the ICBO Uniform Building Code Type I FR (fire resistive) building, and SBCCI Standard Building Code Type II building.

| | | | | | | | | | | |
|-------------------|----------|----------|-----------|-----------|-----------|------------|------------|-----------|-----------|-----------|
| NFPA 220 | I 443 | I 332 | II 222 | II 111 | II 000 | III 211 | III 200 | IV 2HH | V 111 | V 000 |
| UBC Table 6A | - | I FR | II FR | II 1HR | II 1HR | III 1HR | III N | IV HT | V 1HR | V N |
| BNBC Table 602 | 1A | 1B | 2A | 2B | 2C | 3A | 3B | 4 | 5A | 5B |
| SBC Table 600 | I | II | - | IV 1HR | IV U | V 1HR | V UNP | III | VI 1HR | VI UNP |
| IRC | - | - | 1A | 1B | IIA | IIIA | IIIB | I VHT | VA | VB |

| | | |
|----------------------------------|---|------------------------------|
| | Noncombustible | |
| Type I (443) Type I (332) | Type II (222) Type II (111) Type II (000) | |
| | Combustible | |
| Type III (211) Type III (200) | Type IV (2HH) | Type V (111) Type V (000) |

UBC - Uniform Building Code

BNBC - BOCA National Building Code
SBC - Standard Building Code
IRC - Institute of Research in Construction

B.12.4 Reference

NFPA 220, "Standard on Types of Building Construction," National Fire Protection Association, Quincy, Massachusetts, 1999 Edition.

B.13 Deep-Seated Fires In Class A Solid Materials

B.13.1 General Information

Two types of fires can occur in Class A (ordinary) combustibles materials (e.g., wood, cloth, paper, rubber, and many plastics including cable insulation). In the first type, commonly known as flaming combustion, the source of combustion is volatile gases resulting from heating or decomposition of the fuel surface. In the second type, commonly called smoldering or glowing combustion oxidation occurs at the surface of, or within, the mass of fuel. These two types of fires frequently occur concurrently, although one type of burning may precede the other. For example, a wood fire may start as flaming combustion and become smoldering as burning progresses. Conversely, spontaneous ignition in a pile of oily rags may begin as a smoldering fire and break into flames at some later time (Friedman, 1997).

Smoldering combustion can not be immediately extinguished like flaming combustion. This type of combustion is characterized by a slow rate of heat loss from the reaction zone. Thus, the fuel remains hot enough to react with oxygen, even though the rate of reaction, which is controlled by diffusion processes, is extremely slow. Smoldering fires can continue to burn for many weeks, for example in bales of cotton and jute and within heaps of sawdust or mulch. A smoldering fire ceases to burn only either all of the available oxygen or fuel has been consumed or when the temperature of the fuel surface become too low to react. These fires are usually extinguished by reducing the fuel temperature, either directly by applying a heat absorbing medium, (such as water), or by blanketing the fuel with an inert gas. In the latter case, the inert gas slows the rate of reaction to the point at which heat generated by oxidation is less than the heat lost to the surroundings. This causes the temperature to fall below the level necessary for spontaneous ignition following removal of the inert gas atmosphere.

Smoldering fires are divided into two classes, in which the fire is either deep-seated or not. Basically, "deep-seated" implies the presence of sub-surface smoldering combustion that may continue for some time after surface flaming is suppressed. Deep-seated fires may become established beneath the surface of fibrous or particulate material. This condition may result from flaming combustion at the surface or from the ignition within the mass of fuel. Smoldering combustion then progresses slowly through the mass. Whether a fire will become deep-seated depends, in part, on the length of time it has been burning before the extinguishing agent is applied. This time is usually called the "pre-burn" time (Nolan, 2001).

As described above, a deep-seated fire is embedded in the material being consumed by combustion. To extinguish deep-seated fires, an individual must investigate the interior of the material once the surface fire has been extinguished to determine whether interior smoldering has also been extinguished by a gaseous agent. It should be noted, however, that the concentration of the extinguishing agent must be adequate—and must be applied for an adequate duration—to ensure that the smoldering has been effectively suppressed.

B.13.2 Deep-Seated Cable Fires

A deep-seated fire occurs in cables when the burning involves pyrolysing beneath the surface, in addition to a surface phenomenon. This is postulated to occur when the cable fire reaches the stage of a fully developed fire. Extinguishing a cable surface fire does not guarantee that a deep-seated fire is also eliminated. A deep-seated fire is very difficult to suppress since fire suppressing agent cannot easily get to the seat of the fire, and it is also difficult to detect since combustion is primarily under the cooler surface.

Electrical cable fire tests have been conducted at the Sandia Fire Research Facility (Schmidt and Krause, 1982) in order to evaluate cable tray fire safety criteria. A burn mode concept was developed in order to describe and classify the thermodynamic phenomena which occur in the presence of smoke and to compare the fire growth and recession of different cable types under otherwise unchanged fire test conditions. The importance of deep-seated fires in cables trays from the standpoint of propagation, detection, and suppression is emphasized. The cable tray fire tests demonstrate that fire recession and deep-seated fires can result from a decreasing smoke layer and that reignition and secondary fire growth is possible by readmission of fresh air.

B.13.3 Deep-Seated Charcoal Fires

The use of activated charcoal in NPPs presents a potential for deep-seated fires. Simply, that if it says that it is combustible, that it may be ignited, and that if it does become ignited, it is likely to become a deep-seated fire. It does not predict the frequency of those fires, nor form of ignition (Holmes, 1987). On July 17, 1977, a fire occurred at the Browns Ferry Nuclear Power Plant (BFNP) in Unit 3 off-gas system charcoal adsorber bed (Crisler, 1977). The elevation in adsorber bed temperature caused temperature rises of sufficient magnitude to cause carbon ignition.

B.13.4 References

Crisler, H.E. Jr., "July 17, 1977, Off-Gas System Charcoal Adsorber Bed Fire at Browns Ferry Nuclear Plant," Proceedings of the CSNI Specialist Meeting on Interaction of Fire and Explosion with Ventilation Systems in Nuclear Facilities, Volume II , Report Number: LA-9911-C, Vol.2; CSNI-83, pp. 309-316, October 1983.

Friedman, R., "Theory of Fire Extinguishment," Section 1, Chapter 8, NFPA Fire Protection Handbook, 18th Edition, A.E. Cote, Editor-in-Chief, National Fire Protection Association, Quincy, Massachusetts, 1997.

Holmes, W., "Adsorber Fires," Proceedings of the 19th DOE/NRC Nuclear Air Cleaning Conference, NUREG/CP-0086-Vol. 2; CONF-860820-Vol.2, pp. 797-798, May 1987.

Nolan, D.P., *Encyclopedia of Fire Protection*, Delmar Publishers, Albany, New York. 2001.

Schmidt, W.H., and F.R. Krause, "Burn Mode Analysis of Horizontal Cable Tray Fires,"
NUREG/CR-2431, U.S. Nuclear Regulatory Commission, Washington, DC, February 1982.

This page intentionally left blank.

B.14 Special Hazard Gaseous Fire Extinguishing Agents

B.14.1 Introduction

A gaseous (or gas phase) fire suppression agent remains in the gaseous state at normal room temperature and pressure. It has low viscosity, can expand or contract with changes in pressure and temperature, and has the ability to diffuse readily and distribute itself uniformly throughout an enclosure. Gaseous fire extinguishing agents are categorized into two distinct classes, including halocarbon and inert gases (such as nitrogen and mixtures containing argon). Halocarbon agents (e.g., Halon 1301) act largely by absorbing although they also have some chemical effect on flame combustion reactions. Inert agents contains unreactive gases that act primarily by oxygen depleting. One important advantage of gaseous agents is that no cleaning is required if the agent is released in the absence of a fire; a couple of minutes of venting is all that is required. However, gaseous agents with the exception of Halon require a rather large storage area; this is particularly for nitrogen and argon, which are usually stored as compressed gases.

Halogenated extinguishing agents are hydrocarbons in which one or more hydrogen atoms in an organic compound (carbon) have been replaced by atoms from halogens (the chemicals in group 7 of the periodic table of the elements) chlorine (Cl), fluorine (F), bromine (Br), or iodine (I). This substitution confers flame extinguishing properties to many of the resulting compounds that make them useable for certain fire protection applications. The three halogen elements commonly found in Halon extinguishing agents used for fire protection are fluorine, chlorine, and Bromine. Compounds containing combinations of fluorine, chlorine, and bromine can possess varying degrees of extinguishing effectiveness, chemical and thermal stability, toxicity, and volatility. These agents appears to extinguish fire by inhibiting the chemical chain reaction that promotes the combustion process.

Carbon dioxide (CO₂) has a long history as an extinguishing agent, which is primarily used for flammable liquid fires and electrical equipment fires. CO₂ is noncombustible and does not react with most substances. It is a gas, but it can be easily liquified under pressure and is normally stored as a pressure-condensed gas. CO₂ provides its own pressure for release and blankets the fire area when released in sufficient amounts. CO₂ is extremely toxic; humans become unconscious at a 10-percent volume concentration followed by loss of life. Therefore, CO₂ cannot be released while people are present.

B.14.2 Halogenated Agent Extinguishing Systems

Halogenated extinguishing agents are currently known simply as Halons, and are described by a nomenclature that indicate the chemical composition of the materials without the use of chemical names. In this nomenclature the first digit of the number definition represents the number of carbon atoms in the compound molecule; the second digit is the number of fluorine atoms; the third digit is the number of chlorine atoms; the fourth digit is the number of bromine atoms; and the fifth digit is if any, the number of iodine atoms. For example, the number definition for the chemical composition of Halon 1301, perhaps the most widely recognized halogenated extinguishing agent,

is 1 (carbon), 3 (fluorine), 0 (chlorine), 1 (bromine), and 0 (iodine). This simplified system, proposed in 1950 by James Malcolm of the U.S. Army Corps of Engineers Laboratory, avoids the use of possibly confusing names. By contrast, the United Kingdom and parts of Europe still use the initial capital alphabet system [i.e., bromotrifluoromethane (Halon 1301) is BTM and bromochlorodifluoro-methane (Halon 1211) is BFC].

Due to the many chemical combinations available, the characteristics of halogenated fire extinguishing agents differ widely. It is generally agreed, however, that the agents most widely used for fire protection applications are Halon 1011, Halon 1211, Halon 1301, Halon 2402, and (to a lesser degree) Halon 122, which has been used as a test gas because of its economic advantages. However, because of its widespread use as a test agent, many individuals have wrongly assumed that Halon 122 is an effective fire extinguishing agent. Table B.14-1 illustrates the halogenated hydrocarbons most likely to be used today. Of all of these types, however, the most popular halogenated agent is Halon 1301, which offers superior fire extinguishing characteristics and low toxicity. Because Halon 1301 inhibits the chain reaction that promotes the combustion process, it chemically suppresses the fire very quickly, unlike other extinguishing agents that work by removing the fire's heat or oxygen. Stored as a liquid under pressure and released as a vapor at normal room temperature, Halon 1301 readily spreads into blocked and baffled spaces and leaves no corrosive or abrasive residue after use. A high liquid density permits compact storage containers, which on a comparative weight basis, makes Halon 1301 approximately 2.5 times more effective as an extinguishing agent than CO₂ (Grand, 1995).

| Table B.14-1. Halogenated Hydrocarbons Commonly Used for Fire Protection | | |
|--|----------------------------|---|
| Common Name | Chemical Name | Formula |
| Halon 1001 | Methyl Bromide | CH ₃ Br |
| Halon 10001 | Methyl Iodide | CH ₃ I |
| Halon 1011 | Bromochloromethane | CH ₂ BrCl |
| Halon 1202 | Dibromodifluoromethane | CF ₂ Br ₂ |
| Halon 1211 | Bromochlorodifluoromethane | CF ₂ BrCl |
| Halon 122 | Dichlorodifluoromethane* | CF ₂ Cl ₂ |
| Halon 1301 | Bromotrifluoromethane | CF ₃ Br |
| Halon 104 | Carbon Tetrachloride | CCl ₄ |
| Halon 2402 | Dibromotetrafluoroethane | C ₂ F ₄ Br ₂ |
| * A popular test gas without substantial fire extinguishing properties. | | |

Although halogenated agents may be applied using a variety of methods, the most common is the total flooding systems. According to the NFPA 12A, 1997 Edition, Section 2-3.1.1, a Halon 1301 total flooding system shall be automatically actuated for fires involving Class A ordinary

combustible materials (e.g., wood, cloth, paper rubber, and many plastics including cables), with the exception that manual actuation shall be permitted if acceptable to the authority having jurisdiction (AHJ). NFPA 12A, 1997 Edition, Section 3-7.1.2, also indicate that the agent discharge shall be substantially completed in a nominal 10 seconds or as otherwise required by the AHJ. The rapid discharge is specified to prevent the fire from becoming deep-seated, minimize unwanted decomposition products, and achieve complete dispersal of the agent throughout the enclosure so that the Halon quickly knocks down the flames and extinguishes the fire. When exposed to deep-seated fires for long period of times, Halon 1301 decomposes into decomposition products, that are toxic to personnel and corrosive to electronic components (See Section B.18 for further discussion). Therefore, to extinguish fire effectively, while limiting the formation of hazardous decomposition products, it is important to disperse the agent during the incipient stage of the fire.

A significant problem in using of Halon 1301 is that, in the normal firefighting concentrations of 5-percent to 6-percent, it may fail to completely extinguish fires which originate in Class A solid materials (e.g., wood, cloth, paper, rubber, and many plastics). External and visible flame is instantly extinguished by Halon 1301, but internal and unseen flameless (but glowing) combustion may continue. As defined by the NFPA, if a 5-percent concentration of Halon 1301 will not extinguish a fire within 10 minutes of application, it is considered to be deep-seated, as described above. Such deep-seated fires usually require concentrations much higher than 10-percent and soaking times much higher than 10 minutes (NFPA 12A, 1971 Edition). The technical literature does not provide any satisfactory explanation for the ineffectiveness of Halon 1301 in deep-seated fires (Fielding and Woods, 1975).

Sandia National Laboratories (SNL) investigation of the effectiveness of the Halon 1301 fire suppression agent on electrical cables fires in 1981 and again in 1986 at the behest NRC. These full-scale fire suppression tests were performed to determine the concentration and minimum soaking time necessary to suppress electrical cable tray fires and prevent reignition of those fires. Halon 1301 was very effective in suppressing surface fires, but took much longer to suppress deep-seated cable tray fires. The results of Test 60 depicted on Figure B.14-1 indicated that even after Halon 1301 is discharged, the interior temperature of the cable bundle continues to rise, probably as a resulting of continued combustion of the cable insulation. Moreover, a second increase in temperature occurs air is readmitted during ventilation, thereby causing reignition of the cable insulation (Klamerus, 1981).

As illustrated in Figure B.14-1 the Halon 1301 concentration applied to the fire has a direct relationship to the time required to completely extinguish the fire. When the agent is first applied to the cable trays, the flames are immediately extinguished, but the deep-seated combustion (or glow), continues and the fire will reignite if the enclosure is then ventilated.

B.14.2.1 Halon Concentration and Soaking Time

Soaking time is an important requirement for a Halon 1301 total flooding system. This is especially true for Class A fires that may reflash. A minimum soaking period of 10-minutes is typically required for fires in these applications, based on the full-scale total flooding fire suppression tests

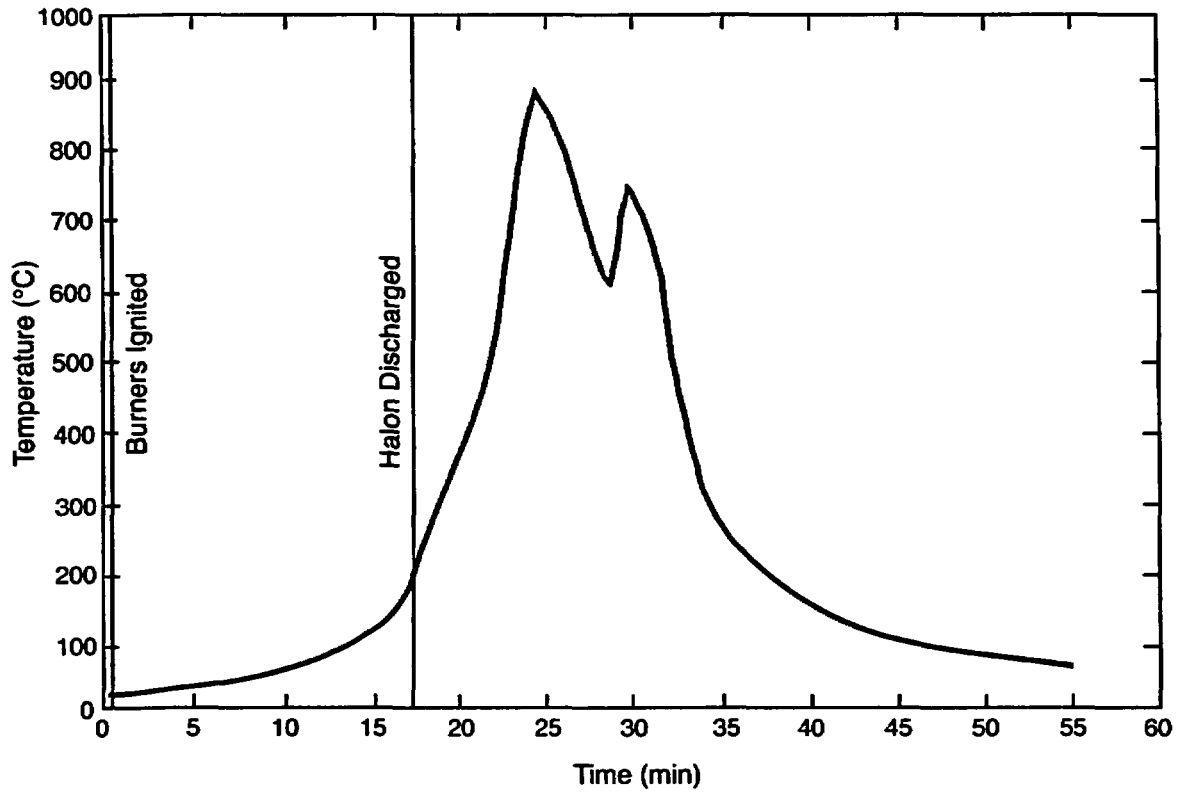

Figure B.14-1 Indication of Deep-Seated Fire and Reignition of Cables, Test # 60, IEEE-383 Qualified Cables, Horizontal Trays, 4-Minute Halon Soak Acceptor Tray Center Temperature (Klamerus, 1981)

for electrical cable tray fires conducted by Klamerus (1981), and Chavez and Lambert (1986). A 6-percent Halon 1301 concentration with a 10-minute soak time successfully extinguished all cable fires in horizontally and vertically oriented trays filled with IEEE-383 unqualified cables, while IEEE-383 qualified cables required a 15-minute soaking time. The measure concentrations in these tests were based on a completely air tight enclosure during discharge (See Figure B.14-2 for Halon 1301 concentration requirements) concentration with 15 minute soak time successfully extinguished all cable fires in horizontal and vertical oriented tray filled with. The measured concentrations in this testing is based on completely tight enclosure during discharge and soaking time of Halon 1301 (see Figure B.14-2 for Halon 1301 concentration requirements).

B.14.2.2 Agent Leakage

Because Halon 1301 is approximately five times heavier than air (with molecular weight 148.93 g/mol compared to 29 g/mol for air), there is a risk of Halon leakage from the protected space if the space is not completely airtight. Therefore, it is important to know the Halon percent and soak time at the highest combustible in the protected enclosure. NFPA 12A requires that the leakage rate should be low enough so that the design concentration is held in the hazard area long enough to ensure that the fire is completely extinguished. Reignition of the fire is a potential concern if the effective concentration are not maintained. In case of leakage during and after discharge, a greater amount of the agent is required to develop a given concentration. To maintain the agent concentration at a given level requires continuous agent discharge for the duration of the soaking period. The leakage rate from an enclosure could be predicted from the detailed knowledge of the size, location, and geometry of any leaks. However, these details are rarely known, as leakage may occur around doors and door seals; wall; ceiling; and floor cracks, duct, conduit, and cable tray penetrations; and fire and isolation dampers. Appendix B to NFPA 12A presents methods of estimating leakage area.

Discharging Halon 1301 into an enclosure to achieve total flooding results in an air/agent mixture with a higher specific gravity than the air surrounding the enclosure. Therefore, any openings in the lower portions of the enclosure will allow the heavier air/agent mixture to flow out and the lighter outside air to flow in. Fresh air entering the enclosure will collect toward the top, forming an interface between the air/agent mixture and fresh air. As the leakage proceeds, the interface will descend toward the bottom of the enclosure. The space above the interface will be completely unprotected, while the lower space will essentially contain the original extinguishing concentration. Grant (1995) presented methods of adjusting the Halon 1301 concentration to unprotected openings (leakage).

Rapid detection of a fire and prompt application of the extinguishing agent without outside assistance can help to prevent a Class A fire from becoming deep-seated. If a fire becomes deep-seated or (begins as a deep-seated fire), it will not likely be extinguished by Halon 1301 concentrations below 10-percent, and some deep-seated fires require concentrations above 18–30-percent to ensure that the glow is completely extinguished (Grant, 1995).

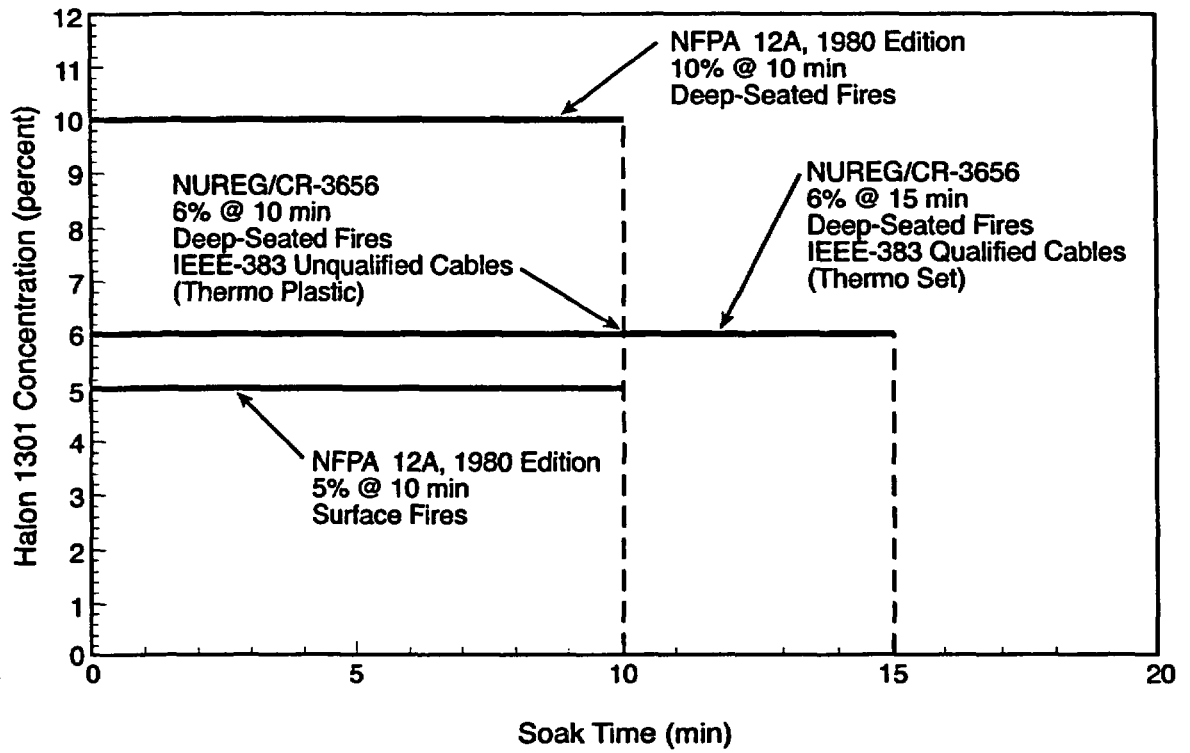

Figure B.14-2 Soaking Time vs. Halon 1301 Concentration for Deep-Seated and Surface Fires

It is important to remember that in most cases, halogenated agent extinguishing systems have only a single chance to extinguish a fire. Such systems should be tested and Halon concentrations measured at various heights within the protected space (at least at the point of the highest combustible) to demonstrate the design concentrations. Timely and automatic actuation of Halon systems would also provide reasonable assurance that a fire would be extinguished before spreading through the combustible material and becoming deep-seated.

B.14.3 Carbon Dioxide Fire Extinguishing Systems

Carbon Dioxide (CO₂) is a colorless, odorless, inert, and electrically nonconductive agent that extinguishes a fire by displacing the normal atmosphere, thereby reducing the oxygen content below the 15-percent required for diffusion flame production. The CO₂ from either low-pressure or high-pressure extinguishing systems is stored and transported as a liquid through the piping system to the nozzles. With the release of pressure at the nozzles, the liquid CO₂ converts to a gas, with some minute solid particles, making it approximately 50-percent heavier than air.

Flame extinguishment by CO₂ is predominantly by a thermophysical mechanism in which reacting gases are prevented from achieving a temperature high enough to maintain the free radical population necessary for sustaining the flame chemistry. For inert gases presently used as fire suppression agent (argon, nitrogen, carbon, carbon, and mixture of these), the extinguishing concentration (as measured by the cup burner method , NFPA 2001) is observed to be linearly related to the heat capacity of the agent-air mixture. Although of minor importance in accomplishing fire suppression, CO₂ also dilutes the concentration of the reacting species in the flame, thereby reducing collision frequency of the reacting molecular species and slowing the rate of heat release.

CO₂ fire extinguishing systems are useful in protecting against fire hazards when an inert, electrically nonconductive, three-dimensional gas is essential or desirable and where clean up from the agent must be minimal. According to the NFPA, some of the types of hazards and equipment that carbon dioxide systems protect are "flammable liquid materials; electrical hazards, such as transformers, switches, circuit breakers, rotating equipment, and electronic equipment; engines utilizing gasoline and other flammable liquid fuels; ordinary combustibles such as paper, wood, and textiles; and hazardous solids" (NFPA 12).

Over the years, two methods of applying CO₂ have been developed. The first technique is the total flooding application, which involves filling an enclosure with CO₂ vapor to a prescribed concentration. In this technique, the CO₂ vapor flows through nozzles that are designed and located to develop a uniform concentration of the agent in all parts of the enclosure. The quantity of CO₂ required to achieve an extinguishing atmosphere is calculated on the basis of the volume of the enclosure and the concentration of the agent required for the combustibles material in the enclosure. This technique is applicable for both surface-type fires and potentially deep-seated fires.

For surface-type fires, as would be expected with liquid fuels, the minimum concentration is of 34-percent of CO₂ by volume. Considerable testing has been done with using CO₂ on liquid fuels and appropriate minimum design concentrations have been derived at for a large number of common liquid fire hazards.

For deep-seated hazards, the minimum concentration is 50-percent of CO₂ by volume. This 50-percent design concentration is used for hazards involving electrical gear, wiring insulation, motors, and the like. Hazards involving record storage, such as bulk paper require a 65-percent

concentration of CO₂, while substances such as fur and bag-type house dust collectors require a 75-percent concentration. It should be noted that most surface burning and open flaming will stop when the concentration of CO₂ in the air reaches about 20-percent or less by volume. Thus, it should be apparent that a considerable margin of safety is built into these minimum CO₂ concentrations required by the standard. This is because those who developed the CO₂ standard never considered it sufficient to extinguish the flame. By contrast, the guidelines given in some of the standards for other gaseous extinguishing agents merely mandate concentrations that are sufficient to extinguish open flame but will not produce a truly inert atmosphere.

The other method of applying CO₂ is local application. This method is appropriate only for extinguishing surface fires in flammable liquids, gases, and very shallow solids where the hazard is not enclosed or where the enclosure of the hazard is not sufficient to permit total flooding. Hazards spray booths, printing presses, rolling mills, and the like can be successfully protected by a local application system designed to discharge CO₂ and direct the flow at the localized fire hazard. The entire fire hazard area is then blanketed in CO₂ without actually filling the enclosure to a predetermined concentration.

The integrity of the enclosure is a very important part of total flooding, particularly if the hazard has a potential for deep-seated fire. If the enclosure is air tight, especially on the sides and bottom, the CO₂ extinguishing atmosphere can be retained for a long time to ensure complete extinguish of the fire. If there are openings on the sides and bottom, however, the heavier mixture of CO₂ and air may rapidly leak out of the enclosure. If the extinguishing atmosphere is lost too rapidly, glowing embers may remain and cause reignition when air reaches the fire zone. Therefore, it is important to close all openings to minimize leakage or to compensate for the openings by discharging additional CO₂.

An extended discharge of CO₂ is used when an enclosure is not sufficiently air tight to retain an extinguishing concentration as long as needed. The extended discharge is normally at a reduced rate, following a high initial rate to develop the extinguishing concentration in a reasonably short time. The reduced rate of discharge should be a function of the leakage rate, which can be calculated on the basis of leakage area, or of the flow rate through ventilating ducts that cannot be shut.

Extended discharge is particularly applicable to enclosed rotating electrical equipment, such as generators, where it is difficult to prevent leakage until rotation stops. Extended discharge can be applied to ordinary total flooding systems, as well to the local application systems where a small hot spot may require prolonged cooling.

B.14.3.1 Carbon Dioxide Requirements for Deep-Seated Fires (NFPA 12)

NFPA 12 recognizes two types of CO₂ extinguishing systems. The first type is the high-pressure CO₂ system, and the second is a low-pressure CO₂ system. The basic difference between the two types lies in the method of storing the CO₂.

The high-pressure system utilizes U.S. Department of Transportation (DOT) spun steel storage cylinders, which are usually kept at room temperature. At an ambient temperature of 21 °C (70 °F), the internal pressure in such a unit reaches 850 psi. These cylinders are available in capacities of 50, 75, or 100 pounds.

By contrast, the low-pressure storage unit maintains the CO₂ in a refrigerated pressure vessel with a typical storage temperature of -18 °C (0 °F) with a corresponding CO₂ vapor pressure of 300 psi. The refrigerated storage concept uses an American Society of Mechanical Engineers (ASME) coded pressure vessel with a working pressure of 2,413 kPa (350 psi). Such units are available in standard capacities from 1.25–60 tons. Larger units have also been made for special applications.

From this basic difference in storage configuration inspired different application and control methods for the two types of systems. Since the maximum capacity of a high-pressure cylinder is 100 pounds of CO₂, most systems consist of multiple cylinders manifolded together to provide the required quantity of agent. Each cylinder has its own individual discharge valve and, once opened, the cylinder contents will completely discharge.

NFPA 12 requires that the quantity of CO₂ for deep-seated fires must be based on fairly air tight enclosures. After the design concentration is reached, it shall be maintained for a substantial period of time, but not less than 20-minutes. Any possible leakage shall be receive special consideration since the basic flooding factor does not include any leakage allowance.

For deep-seated fires the design concentration shall be achieved within 7-minutes from the start of discharge, but the rate shall be not less than that required to develop a concentration of 30-percent within 2 minutes. For surface fires, the design concentration shall be achieved within 1-minute from the start of discharge.

B.14.3.2 Personnel Protection from Carbon Dioxide

The CO₂ that is used to extinguish the diffusion combustion may pose a threat to human life, and NPP personnel must recognize and plan to cope with this threat

Human subjects exposed to low concentrations (less than 4-percent) of CO₂ for upto 30-minutes, dilation of cerebral blood vessels, increased pulmonary ventilation, and increased oxygen delivery to the tissues were observed (Gibbs et al., 1943, Patterson et al., 1955). These results were used by the United Kingdom regulatory community to differentiate between inert gas systems for fire suppression that contain CO₂ and those that do not (HAG, 1995). During similar low-concentration exposure scenarios in humans, however, other researchers have recorded slight increases in blood pressure, hearing loss, sweating, headache, and dyspnea (Gellhorn and Speisman, 1934, 1935; Schneider and Schulte, 1964). 6–7-percent CO₂ is considered the threshold level at which harmful effects become noticeable in human beings. At concentration above 9-percent, most people lose consciousness within a short time. Since the minimum concentrations of CO₂ in air used to

extinguish fire exceed 9-percent, adequate safety precautions must be designed into every CO₂ fire extinguishing system.

B.14.3.3 Harmful Effects of Carbon Dioxide Fire Suppression Systems

As described above CO₂ is lethal to humans at the minimum concentrations required to suppress fires. In fact, since 1975, accidents involving the discharge of CO₂ fire suppression systems have resulted in a total of 64 deaths and 89 injuries. Given its inherent hazard, CO₂ should not be used in areas that are subject to occupancy, except when the risk of fire is documented to be greater than the risk to personnel and no viable suppression alternatives exists.

In land-based workplace environments, Occupation Safety and Health Administration (OSHA) regulates the use of CO₂. These regulations are provided in 29 CFR Parts 1910.160 and 1910.162, which outline the requirements for general and gaseous fixed extinguishing systems, respectively. Despite the fact that the concentration of CO₂ needed to extinguish fires is above the lethal level, U.S. Occupation Safety and Health Administration (OSHA) does not prevent the use of CO₂ in normally occupied areas. (However, OSHA does explicitly limit the use of chlorobromomethane and carbon tetrachloride as extinguishing agents where employees may be exposed [29 CFR Part 1910.160 (b) (11)]. For CO₂ systems, OSHA requires a predischarge alarm for alerting employees of the impending release of CO₂ when the design concentration is greater than 4-percent (which is essentially true for all CO₂ systems). This predischarge alarm must allow sufficient time delay for personnel to safely exit the area prior to discharge. Although it is speculative, it is likely that these regulations would confer adequate protection only in the event of planned discharge, not accidental discharge. Accidental discharges have occurred, however, in which adherence to regulations has provided personnel protection, whereas some planned discharges have resulted in injury to personnel.

U.S. Environmental Protection Agency (EPA) has published a report to provide information on the use and effectiveness of CO₂ in fire protection systems and describes incidents involving inadvertent of personnel to the gas (EPA430-R-00-02, 2000). The results of this comprehensive review identify that from 1975 to the present, a total of 51 CO₂ incident records were located that reported a total of 72 deaths and 145 injuries resulting from accidents involving the discharge of CO₂ fire extinguishing systems. All the deaths that were attributed to CO₂ were the result of asphyxiation. Details about the injuries were generally not provided in the incident reports, although some OSHA inspections listed asphyxia as the nature of the injury. Prior to 1975, a total of 11 incident records were located that reported a total of 47 deaths and 7 injuries involving CO₂. Twenty of the 47 deaths occurred in England prior to 1963; however, the cause of these deaths is unknown. The remainder of this section presents representative examples of the hazards of CO₂ fire suppression systems:

- On July 28, 2000, a bank employee accidentally suffocated in a New York City bank vault after pulling a fire alarm that flooded the space with CO₂. The bank employee was putting stock receipts in the bank's basement vault when she accidentally became locked inside. Apparently thinking she could get help by pulling a fire alarm, she instead activated a CO₂

fire extinguishing system that sucked air from the vault. She was taken to a local hospital in extremely critical condition and was pronounced dead.

- On January 15, 1999, at 5:49 p.m., with the plant at full power, an inadvertent discharge of the CO₂ fire suppression system occurred in the Millstone Unit 3 cable spreading room (CSR), which is located in the control building directly below the control room. The actuation occurred when a non-licensed plant equipment operator trainee in the service building blew dust off a printed circuit board located in the CSR CO₂ control panel, which is located in the service building, rather than the control building. There were no plant personnel in the CSR at the time of the discharge. Shortly after the discharge, CO₂ was found to have migrated down into the switchgear rooms located directly below the CSR. Approximately 37-minutes after initiation, the licensee used a portable instrument to measure the concentration of CO₂ in one of the control building stairwells, which allows access to the control room, the CSR, and the switchgear rooms. The reading was off-scale high indicating that the CO₂ concentration was in excess of 50,000 parts per million (ppm). NRC Regulatory Guide 1.78 currently recommends a CO₂ toxicity limit of 10,000 ppm. On the basis of this indication, the licensee declared the area uninhabitable.

Approximately 2 hours after the CO₂ discharge, operators aligned the control building purge system to remove CO₂ from the switchgear rooms. The switchgear rooms were selected for purging first because they contained important plant equipment, such as the auxiliary shutdown panel. The purge system is a non-safety-related system designed to remove CO₂ and smoke from various control building areas. Placing the purge system in service diverted air from the control room to the switchgear rooms, which reduced the pressure in the control room relative to the CSR. This pressure reduction in the control room may have allowed CO₂ from the CSR room to migrate up through penetrations into the control room. When the concentration of CO₂ reached 5,000 ppm in the control room, the operators donned self-contained breathing apparatus (SCBA), as required by the plant procedures. The concentration of CO₂ in the control room reached a peak level in excess of 17,000 ppm before it began to decrease. The operators wore SCBA for approximately 6 hours until the CO₂ was successfully purged from the control room.

- On July 29, 1998, a high-pressure, total flooding CO₂ extinguishing system discharged without warning during routine maintenance of electrical equipment, resulting in one fatality and several serious injuries in Building 648 of the Idaho National Engineering and Environmental Laboratory (INEEL) (EH2PUB/09-98/01A1). At the time of the accident, the newly installed CO₂ system releasing panel was electronically disabled and considered to be out of service. The work crew began opening circuit breakers in preparation for the preventive maintenance work. Shortly after the last breaker was opened, the CO₂ system discharge, creating near zero visibility. While the evacuation alarms may have briefly sounded for less than one second, they did not continuously sound in conjunction with CO₂ release. After the CO₂ discharge, the worker ran towards the exits, which were visible since they were held open by cables running into the building from portable generators. Eight of the workers were able to exit on their own; however, five remained inside of the building

and were rendered unconscious by the CO₂. Three were later rescued by the workers who had earlier escaped, which left two people remaining in the building. One of the remaining workers was later revived, and the other perished.

- At Duane Arnold Unit 1 on March 22, 1992 (LER 331/92-004), the licensee performed a special test of the CO₂ fire suppression system in the CSR. This test was conducted to check corrective actions taken following a CO₂ discharge in 1990. At the time of this test, the reactor had been shut down and defueled. As a result of this test, CO₂ intruded into the control room, and this intrusion led to an unacceptable reduction in the oxygen level in the area within a few minutes. The operator recorded oxygen levels of 17-percent (at chest level) and 15-percent (at floor level), both of which were below the plant's acceptance criterion of 19.5-percent. Essential control room personnel donned SCBA and were able to remain in the control room. The reduced oxygen levels resulted from increased pressure in the CSR, which is directly beneath the control room. Sealed penetrations between the two rooms leaked under the high differential pressure.

In this incident, the migration of CO₂ into various fire zones may have adversely affected the operators' ability to shut down the plant during a fire in the CSR. Consequently, one can conclude that a severe fire in the CSR may adversely affect the operators' ability to safely shut down the plant from the control room. In the event that the operators are required to evacuate the control room, plant procedures require operators to shut down the plant from the auxiliary shutdown panel and other panels, which are located in the switchgear rooms. During this event, the CO₂ concentration at the auxiliary shutdown panel would prohibit access without SCBA.

- At Surry Nuclear Power Station on December 9, 1986, an accidental discharge of both the CO₂ and Halon extinguishing systems was caused by water damage to the extinguishing system control panels. The water came from a pipe break in the feedwater system. Four died and four were injured in a fire associated with the accident. However, it is not clear if the release of the gases from fire extinguishing systems were responsible for these injuries and deaths (Warnick, 1986).
- At Hope Creek Generating Station, on September 4, 1984, a 10 tons CO₂ system was inadvertently discharged into a diesel generator fuel storage area. The warning bell and beacon light did not operate and workers who were cleaning the corridor walls outside of the fuel storage room with air/water guns under pressure were not alerted. The cause of the discharge was determined to be moisture (that entered the CO₂ control panel through openings at the top of an inadequately installed protective panel) that shorted the CO₂ control panel circuitry. The moisture was believed to have originated from the workers cleaning the corridor walls (PNO-I-85-64a).

B.14.4 References

Chavez, J.M., and L.D. Lambert, "Evaluation of Suppression Methods for Electrical Cables Fires," NUREG/CR-3656, U.S. Nuclear Regulatory Commission, Washington, DC, October 1986.

EPA430-R-00-02, "Carbon Dioxide as a Fire Suppressant: Examining the Risk," U.S. Environmental Protection Agency, Office of Air and Radiation, Stratospheric protection Division, Washington DC, February 2000.

Fielding, G.H., and F.J. Woods, "Halon 1301: Mechanism of Failure to Extinguish Deep-Seated Fires," *Journal of Fire & Flammability*, Volume 6, pp. 37–43, January 1975.

Gellhorn, E., and I. Spiesman, "Influence of Variations of O₂- and Carbon Dioxide Tension in the Inspired Air Upon Hearing," *Proceedings of Society of Exp. Biol. Med.*, Volume 32, pp. 46–44, 1934.

Gellhorn, E., and I. Spiesman, "Influence of Hyperpnea and Variations of O₂- and CO₂-Tension in the Inspired Air Upon Hearing," *American Journal of Physiology.*, Volume 112, pp. 519–528, 1935.

Gibbs, F.A., E.L Gibbs, E.G. Lennox, and L.F. Nims, "The Value of Carbon Dioxide in Counteracting the Effects of Low Oxygen," *Journal of Aviat. Med.*, Volume 14, pp, 250–261, 1943.

Grand, C.C., "Halon Design Calculations," Section 4, Chapter 6, *SFPE Handbook of Fire Protection Engineering*, 2nd Edition, P.J. DiNenno, Editor-in-Chief, National Fire Protection Association, Quincy, Massachusetts, 1995.

HAG, "A Review of the Toxic and Asphyxiating Hazards of Clean Agent Replacements for Halon 1301," Prepared by the Halon Alternatives Group (HAG) in the UK, February 1995. As Cited in a Letter dated May 9, 1995 from J.S. Nicholas, Ansul Inc., to Karen Metchis, EPA.

Klamerus, L.J., "Electrical Cable Fire Suppression Tests with Halon 1301," SAND 81-1785, Sandia National Laboratories (SNL), Albuquerque, New Mexico, August 1981.

NFPA 12, "Carbon Dioxide Extinguishing Systems," National Fire Protection Association, Quincy, Massachusetts.

NFPA 12A, "Standard on Halon 1301 Fire Extinguishing Systems," 1992 Edition, National Fire Protection Association, Quincy, Massachusetts.

NFPA 12A, "Standard on Halon 1301 Fire Extinguishing Systems," 1971 Edition, National Fire Protection Association, Quincy, Massachusetts, pp. 59–69.

NFPA 2001, "Standard on Clean Agent Fire Extinguishing Systems," 2000 Edition, National Fire Protection Association, Quincy, Massachusetts.

NRC Information Notice: 99-05, "Inadvertent Discharge of Carbon Dioxide Fire Protection System and Gas Migration, March 8, 1999.

Patterson, J.L., H. Heyman, L.L. Battery, and R.W. Ferguson, "Threshold of Response of the Cerebral Vessels of Man to Increases in Blood Carbon Dioxide," *Journal of Clin. Invest*, Volume 34, pp. 1857–1864, 1955.

Preliminary Notification of Event or Unusual Occurrence PNO-I-99-004: Carbon Dioxide Discharge into Cable Spreading Room, Millstone Unit 3. January 20, 1999.

Preliminary Notification of Event or Unusual Occurrence - PNO-I-85-64a, U.S. Nuclear Regulatory Commission Region I, September 5, 1985.

Schult, J.H., "Sealed Environments in Relation to Health and Disease," *Arch. Environment Health*, Volume 8, pp. 438–452, 1964.

Sinclair, R.D., J.M. Clark, and B.E. Welch, "Comparison of Physiological Responses of Normal man to Exercise in Air and in Acute and Chronic Hypercapnia," *Underwater Physiology*, C.J. Lambertsen, Editor, Academic Press, New York, New York, pp. 409–417, 1971.

"Type A Accident Investigation Board Report of the July 28, 1998, Fatality and Multiple Injuries Resulting from the Release of Carbon Dioxide at Building 648, Test Reactor Area," Idaho National Engineering and Environmental Laboratory, U.S. Department of Energy, EH2PUB/09-98/01A1, September, 1998.

Warnick, L., "Inadvertent Actuation of Fire Suppression Systems, Surry Nuclear Power Station, Feedwater Pipe Failure," Virginia Power, Richmond, Virginia, 1986.

This page intentionally left blank.

B.15 Dry Chemical Extinguishing Agents

Dry chemicals or powders, or solid phase agents provide an alternative to water or gaseous agents for extinguishing fire. Table B.15-1 lists the chemical names, formulae, and (commercial) names of the various dry chemical agents. In each case, the particles of powder (10–76 μm in size) are coated with an agent (such as zinc stearate or a silicone) to prevent caking and promote flowing, and are projected by an inert gas. The effectiveness of any of these agents depends on the particle size. The smaller the particles, the less agent is needed as long as particles are larger than a critical size. The reason for this fact is believed to be that the agent must vaporize rapidly in the flame to be effective. However, if an extremely fine agent were used, it would be difficult to disperse and apply to the fire.

| Table B.15-1. Dry Chemical Agents | | |
|-----------------------------------|--|---------------------|
| Chemical Name | Formula | Popular Name(s) |
| Sodium bicarbonate | NaHCO_3 | Baking soda |
| Sodium chloride | NaCl | Common salt |
| Potassium bicarbonate | KHCO_3 | Purple K |
| Potassium chloride | KCl | Super K |
| Potassium sulfate | K_2SO_4 | Karate Massive |
| Monoammonium phosphate | $(\text{NH}_4)\text{H}_2\text{PO}_4$ | ABC or multipurpose |
| Urea and Potassium bicarbonate | $\text{NH}_2\text{CONH}_2 + \text{KHCO}_3$ | Monnex |

It is difficult to draw a precise comparison of effectiveness of one dry chemical with another because a comparison based on chemical differences would require each agent to have identical particle size. Furthermore, gaseous agents can be compared by studying the flammability limits of uniform mixtures at rest; however, if particles were present, they would settle out unless the mixture is agitated, thus modifying the combustion behavior. Nonetheless, some general comparisons of various powders have been made:

- Sodium bicarbonate (standard dry chemical) and sodium chloride have comparable effectiveness and are several times as effective (on a weight basis) as powders such as limestone or talc, which are supposedly chemically inert in a flame. Sodium bicarbonate (standard dry chemical) primarily consists of sodium bicarbonate (over 90-percent) with additives to improve fluidity, non-caking, and water-repellent characteristics.
- Potassium bicarbonate or potassium chloride is up to twice as effective (on a weight basis) as the corresponding sodium compounds.

- Under some conditions, monoammonium phosphate is more effective than potassium bicarbonate, however, it can be less effective under other conditions.
- Monnex is twice as effective as potassium bicarbonate because of the rapid thermal decomposition of the complex formed between urea and potassium bicarbonate, which cause a breakup of the particles in the flame to form very fine fragments, which then rapidly gasify.

Dry chemical formulations may be ranked with regard to their effectiveness in extinguishing fires according to their performance in tests. As previously described, this performance is a function of both the chemical composition and the particle size. It seems clear that the effective powders act on a flame through some chemical mechanism, presumably forming volatile species that react with hydrogen atoms or hydroxyl radicals. However, science has not yet firmly established the precise reactions. Although the primary action is probably removal of active species, the powders also discourage combustion by absorbing heat, blocking radiative energy transfer, and in the case of monoammonium phosphate, forming a surface coating.

Of the seven types of dry chemicals commonly in use, only monoammonium phosphate is considered effective against deep-seated fires because of a glassy phosphoric acid coating that forms over the combustible surface. All seven types of dry chemical extinguishing agents act to suppress the flame of a fire (Friedman, 1998), but require significant cleaning after use. As a result their use is limited almost exclusively to environments where this is not a serious concern. Dry chemicals are very common in manual extinguishers and to some extent for local applications. The most common application of these agents is for relatively small flammable liquid fires. Dry chemical total flooding suppression systems are designed to reach the design concentration within the entire protected volume in less than 30 seconds (NFPA 17, "Standard for Dry Chemical Extinguishing System"). Additional dry chemical is required to compensate for losses attributable to openings and ventilation in a compartment.

One reason for the popularity of dry chemical extinguishing agents other than monoammonium phosphate to do with corrosion. Any chemical powder can produce some degree of corrosion or other damage, but monoammonium phosphate is notably acidic and corrodes more readily than other dry chemicals, which are neutral or mildly alkaline. Furthermore, corrosion by the other dry chemicals is stopped by a moderately dry atmosphere, while phosphoric acid has such a strong affinity for water that an exceedingly dry atmosphere would be needed to stop corrosion. Monoammonium phosphate is also not recommended for kitchen fires involving hot fat because of its acidic nature; an alkaline dry chemical (such as potassium bicarbonate) is preferred.

Application of a dry chemical extinguishing agent on an electrical fire is safe (from the viewpoint of electric shock) for fire fighters. However, these agents (especially monoammonium phosphate) can damage delicate electrical equipment.

B.15.1 Hazards Associated with Dry Chemicals

One hazard associated with the use of dry chemical extinguishing agents is attributable to the sudden release of the agent. Another hazard is unexpected reignition. The main toxic hazards following the use of dry chemical agents will generally be those attributable to the combustion processes, since dry chemicals themselves are non-toxic. According to Hague (1997), the ingredients used in dry chemical agents are nontoxic but can cause temporary breathing difficulty and can interfere with visibility.

B.15.2 References

Friedman, R., *Principles of Fire Protection Chemistry and Physics*, 3rd Edition, Chapter 14, "Fire-Fighting Procedures," National Fire Protection Association, Quincy, Massachusetts, pp. 229–230, 1998.

Hague, D.R., "Dry Chemical Agents and Applications Systems," Section 6, *NFPA Fire Protection Handbook*, 18th Edition, National Fire Protection Association, Quincy, Massachusetts, 1997.

NFPA 17, "Standard for Dry Chemical Extinguishing Systems," 2002 Edition, National Fire Protection Association, Quincy, Massachusetts.

This page intentionally left blank.

B.16 Fire Protection Using Foam

Extinguishing foams provide a primary alternative to water, particularly for large fires. Foams are widely used to control and extinguish fires involving of flammable and combustible Class B liquids (e.g., solvents, oil based paints, petroleum greases, paraffin or heavy lubricants, tars, lacquers, hydrocarbons, alcohols, LPG, LNG, and cooking fats). Foams are also suitable for Class A fires involving ordinary combustible materials (e.g., wood, cloth, paper, rubber, and many plastics).

If a flammable liquid is lighter than water and is insoluble in water, application of water to extinguish a fire would simply cause the liquid to float on the water and while continue to burn. Moreover, if the burning liquid is an oil or fat, the temperature of which is substantially above the boiling point of water, the water will penetrate the hot oil, turn into steam below the surface, and cause an eruption of oil that will accelerate the burning rate and possibly spread the fire. By contrast, if the flammable liquid is water soluble (such as alcohols), addition of sufficient water will dilute the liquid to the point where it is no longer flammable. However, if the involves a deep pool of alcohol (rather than a shallow spill), the time required to obtained sufficient dilution might be so great that an aqueous foam would be a better choice of extinguishing agent. If the nature of a liquid is unknown, an aqueous foam might still be chosen over direct application of water. Another important application of foam is on liquids or solids that are burning in spaces that are difficult to assess (such as a room in a basement or the hold of a ship). In such instances, the foam is used to flood the compartment completely.

Fire-fighting is mass of bubbles formed by various methods from aqueous solutions of specially formulated foaming agents. Some foams are thick and viscous, forming tough heat-resistant blankets over burning liquid surfaces and vertical areas. Other foams are thinner and spread more rapidly. Some are capable of producing a vapor-sealing film of surface-active water solution on a liquid surface, and others are meant to be used as large volumes of wet gas cells to inundate surfaces and fill cavities. The foam initially acts as a blanketing agent and then as a cooling agent as the water drains from the foam, as a cooling agent.

The effectiveness of foam is attributable to following factors:

- prevents air from reaching fire
- generates steam, which dilutes the air as well as absorbed heat
- penetrates crevices because of low surface tension
- provides protection of exposed material that not yet burning

Nonetheless, foam is an unstable air-water emulsion, which can easily be broken down by physical or mechanical forces, and certain chemical vapors or fluids can quickly destroy foam. Consequently, when certain other extinguishing agents are used in conjunction with foam, severe breakdown of the foam can occur. In addition, turbulent air or violently uprising combustion gases can divert light foam from the burning area.

Foam breaks down and vaporizes its water content under attack by heat and flames. Therefore, it must be applied to a burning surface in sufficient volume and at a sufficient rate to compensate for this loss and guarantee a residual foam layer over the extinguished portion of the burning liquid. The process of foam spread over a burning liquid fuel is similar to the spread of a less dense liquid (such as oil) on a more dense liquid (such as water).

B.16.1 Properties of Foam

Foams used for fire fighting should possess certain general properties, including (1) expansion, (2) cohesion, (3) stability, (4) fluidity, (5) fuel resistance, and (6) resistance. Clearly, foam extinguishing agents must have an appreciable expansion ratio, the bubbles must adhere together to form a blanket, and the foam must retain its water and remain stable, flowing while freely over the liquid surface and around any obstacles. In addition, foam agents must not pick up so much fuel that the foam would be liable to burn, and the agent must resist the heat of flames on the liquid. Foams for use on alcohol fires must also be alcohol resistant.

Three quantitative criteria for foam are (1) the expansion (2) the fluidity and (3) the drainage time. Expansion is quantitatively measured by the expansion ratio. While fluidity is measured in terms of shear stress. A shear stress in the range 150–200 dyn/cm², measured on a torsional viscometer, is typical of a good foam extinguishing agent. The drainage of liquid out of the foam is usually expressed as the 25-percent drainage rate, which is the time in minutes for 25-percent of the total liquid content to drain away under standard conditions. For a good foam, this drainage time is typically 2–5 minutes.

Foam extinguishing agents can also be affected by the quality of the water used. A study by Dimaio and Lange (1984) detected deleterious effects from contaminants (such as corrosion inhibitors, anti-fouling agents, etc.). In general, however, such effects were found to be much weaker if high application rates were used.

B.16.2 Hazards Associated with Foam

Foam is a water based, consequently, hazards associated with water also apply to foam. These hazards include increased vaporization of low-boiling flammable combustible liquids, reaction with incompatible materials and electric shock from live electrical equipment. Another hazard is rupture of the foam blanket and burn back, which may put fire fighters at risk. Hazards can also arise from the use of a foam on a liquid at a temperature of 100 °C (212 °F) or above, because the formation of steam can cause a four-fold expansion of the foam with slopover of the burning liquid. In the case of the medium- and high-expansion foams used to fill spaces, there is the additional hazard of asphyxiation.

Another hazard of foam is ignition of hydrocarbons in a storage tank roof by static electricity from foam injection, as described by Howells (1993). This author describes several incidents in which ignition of volatile refined products in a floating roof storage tank appears to have been caused by foam injection. He suggests two possible modes of charge generation, including (1) the setting of

water droplets through the hydrocarbon liquid and (2) the streaming current of the foam mixture leaving the nozzle.

B.16.3 Delivery Systems for Foam

Foam is delivered to a fire by means similar to those used for water, which primarily include fixed systems such as foam-water spray systems and fixed foam-water monitors, and mobile foam-water systems such as fire hoses. For low expansion foam, one type of Fixed foam systems used for low-expansion foam include the foam-water deluge system is the foam-water monitor. Fixed-foam systems are used for fire prevention, extinguishment, and control in bunds or on spills. Relevant codes are NFPA 11, "Standard for Low-Expansion Foam," NFPA 11A, "Standard for Medium-and High-Expansion Foam Systems," and NFPA 16, "Standard for the Installation of Foam-Water Sprinkler and Foam-Water Spray Systems". There is limited use of foam in portable devices.

The delivery of foam involves three stages, including (1) proportioning the foam concentrate, (2) generating foam, and (3) distributing foam. There are a number of methods for proportioning the foam concentrate. The devices for generating the foam are incorporated in the devices used for its distribution, as previously described. The basic generation method is aspiration of air into the foam.

B.16.4 Application of Foam

Fire extinction by blanketing may be achieved using foam. Foam can be used for all modern fire protection in warehouses, high storage areas, and process plants of all types for commodities such as rubber tires, rolled paper, and plastics; in bulk storage areas and conveyor tunnels, coal mines, coal handling equipment tunnels, and diked areas; in electric power plants aircraft hangars, and aboard ships. An example of application in a BWR is the use of a foam water sprinkler system (NFPA 16) to protect the large oil hazard of the recirculation pumps motor generator (MG) set.

Low expansion foam is mainly used to prevent, extinguish, or control fires in storage tank tops and bunds and on spills. Medium- and high-expansion foams are used to prevent, extinguish, or control fire in spaces such as fires below grades (e.g., basement).

Foam should be used only if compatible with the hazardous liquid. In particular, foam is essentially expanded water and, apart from its density, has the general characteristics of water. Consequently, it is just as unsuitable as water for fighting fires involving electrical equipment or substances that have undesirable reactions with water. Other prerequisites for the use of foam are that the liquid surface must be horizontal and the temperature of the liquid must be below the boiling point. In addition, the liquid temperature is below the boiling point of the given hazardous liquid, but above 100 °C (212 °F), water in the foam will turn to steam, which can result in very large expansion of the foam.

There are optimum rates of foam application. For low-expansion foam with an expansion ratio of 8:1, an application rate of 0.1 US gal/ft²-min will give 0.8 US gal/ft²-min of foam. Application systems for medium- and high-expansion foams comprise both (1) total flooding systems and (2) local application systems. Fighting a major fire requires a very large quantity of foam. An example quoted by Nash (1966) is a requirement of 300 x 5 UK gal drums for a 30-minute foam attack on a single 150-ft diameter oil storage tank. The supply and disposal of such a large number of drums in an area congested with appliances and hoses constitutes a major problem. Consequently, Nash describes the alternative of providing a piped supply of foam concentrate.

A particularly important application of foam is the protection of storage tanks. For fixed roof tanks, some principle arrangements are foam chambers, internal tank distributors, and subsurface foam injection. Foam chambers are installed at intervals on the outside near the top of the tank wall, providing an over-the-top foam generation. An alternative is internal distributors fitted inside the tank. Application of foam at the top of the tank poses several problems. If the fire is initiated by an explosion, the explosion itself may also disable the foam system. The upward flow of air caused by the fire may also interfere with the distribution of the foam and the foam may not reach the center of a large tank. Subsurface foam injection is designed to counter these difficulties. Such systems inject under pressure up through the liquid in the tank. Injection may be through the product pipe or a dedicated line. Mobile foam trucks may be used to provide the foam supply.

Floating roof tanks may be open topped or closed. Both have a good fire record, so foam systems are generally not required. The one exception to this rule is the need to allow for rim fires, which can occur on either type of tank. An open-topped floating roof tank may be protected by a fixed foam system, which pours foam into the annulus formed by the tank wall and a foam dam. A closed floating roof tank may be protected using a top injection system similar to those used in fixed roof tanks. Subsurface foam injection is not generally used for floating tanks, since a tilted or sunken roof can cause poor foam distribution.

Foam trucks are the principal means of mobile foam of delivery. The trucks are typically purpose-built twin-agent trucks with the capability to deliver dry chemicals in addition to aqueous film forming foam (AFFF). Foam trucks carry a supply of foam concentrate and delivery hoses and can be equipped with telescoping booms or articulated towers. They also have low clearances to allow passage under pipe bridges. Monitor capacities are on the order of 500–1000 US gal-min.

A variety of mobile devices can be used to apply foam to the top of a storage tank that is on fire. These include mobile foam monitors and foam towers. However, using a foam monitor for this purpose poses numerous problems, such as crosswinds and fire updrafts, which can waste a significant proportion of the foam.

Use of foam extinguishing agents is not limited to fire control and extinguishment. Another important application is the suppression of vaporization from toxic liquid spills. This use of foam is treated in ASTM F1129-88, "Standard Guide for Using Aqueous Foams to Control the Vapor Hazard from Immiscible Volatile Liquids". A 500 to 1 foam ratio can be used to control fires and reduce vaporization from liquefied natural gas (LNG) spills.

B.16.5 Types of Foam

A large family of foams of different types and applications are currently available. Water-based foams are available in the following forms:

- chemical foam

- protein-based mechanical foam
 - standard low-expansion foam
 - high-expansion foam
 - medium-expansion foam
- special foam
 - fluorochemical for light-water foam
 - fluoroprotein foam

- synthetic detergent foam
 - aqueous film forming foam (AFFF)
 - film forming fluoroprotein (FFFP) foam
 - alcohol resistant foam
 - low temperature foam

One broad distinction is the viscosity of the foam. The blanket formed by the more viscous type is resistant to rupture by flame, but the less viscous type flows more readily over a liquid surface.

- *Chemical Foam*

Chemical foam is produced by reacting an aqueous solution of sodium bicarbonate and aluminum sulphate in the presence of a foam stabilizer. The reaction generates CO₂, which both forms foam and ejects the mixture from the apparatus. This type of foam may be generally regarded as obsolete, given that its use has long been almost entirely confined to mobile and portable equipment.

- *Protein-Based Mechanical Foam*

- Mechanical foam is generated by mechanical aeration of aqueous solutions of certain chemicals, which usually have a protein base. For example, one type is based on blood hydrolyzed by caustic soda. Standard foam is made by introducing the foam compound into the water in the hose to give a 3–6-percent aqueous solution and then mixing the solution with air in an ejector nozzle to give an approximately 10:1 expansion. This type of foam is the most widely used for both fixed and mobile apparatus. Such standard low-expansion foam is often very economical.

- High-expansion foam is generally similar to standard foam, with the exception that it has a much higher expansion of approximately 1,000:1. Because this type of foam contains little water, it acts almost entirely by blanketing rather than cooling. In addition, it is very light and become easily blown away, it is more suitable for fires in contained spaces than for those in open situations (such as bunds).
- Medium-expansion foam is also generally similar to standard foam, with the exception that has an expansion of approximately 100–150:1. This type of foam is also light, but is not so easily blown away as high-expansion foam. Both medium- and high-expansion foams have a good three-dimensional extinction capability and can be used against fires on piles of materials (such as rubber).

A disadvantage of protein foams is that if the foam blanket is broken, the liquid may re-ignite and burn back the blanket. Low-expansion foam, however, has an advantage in this regard, given that it has reasonably good heat and burnback resistance.

- *Special Foam*

- *Fluorochemical for Light Water Foam*

Fluorochemical foam is one agents that has been developed to overcome the problem of reignition and burnback. One type is fluorochemical foam. This light-water foam contains a straight-chain fluorocarbon surface active agent. This has the effect that as the water drains from the foam, it spreads in a thin film over the liquid and seals it. Even if the film is disturbed by agitation, it reforms rapidly. Light-water foam behaves differently, however, on different liquids, and it is expensive and not universally effective.

- *Fuoroprotein Foam*

Another agent that works in a manner similar to fluorochemical light-water foam is fluoroprotein foam, which contains a branched chain fluorocarbon. Where good burnback resistance is needed, this alternative is less expansive and appears (in many cases) to be more effective than light-water foam. In particular, fluoroprotein foam is less prone to pick up oil particles when passed through oil. This fuel-shedding property is useful in subsurface foam injection on storage tanks. This type of foam also tends to have good compatibility with dry chemicals.

- *Synthetic Detergent Foam*

Synthetic detergent foam is generated by mechanical aeration of an aqueous solution containing 2–3 -percent detergent. This foam is less stable than protein-based foam, but it appears to be useful in massive application in a knockout attack. Despite its limitations, detergent foam has enjoyed some popularity, because it is even less expensive than protein foam.

- ***Aqueous Film Forming Foam (AFFF)***
AFFF has low viscosity and spreads easily over a liquid surface so it can be an effective agent against deep-seated fires. Another useful property of AFFF is that it does not need elaborate foaming devices and can be used in many water sprinkler and water spray systems.
- ***Film-Forming Fluoroprotein (FFFP) Foam***
FFFP foam is another type of foam that has low viscosity and good spreading properties and can be used in many water spray systems. FFFP foam tends to drain rapidly and, therefore, is less reliable in maintaining a foam blanket.
- ***Alcohol-Resistant Foam***
Regular air foams do not perform well on liquids that are of the polar solvent type (notably alcohol). Alcohol-resistant foams have been developed to solve that problem. The first generation of alcohol-resistant foams were not entirely satisfactory, but effective foams have since been developed. One type of alcohol-resistant foam is polymeric-alcohol resistant AFFF.
- ***Low Temperature Foam***
Foam have been developed for use at low ambient temperatures; one quoted temperature for such foams is -29 °C (-20 °F). These foams come in both protein and AFFF types.

B.16.6 References

Dimairo, L.R., and R.F. Lange, "Effect of Water Quality on Fire Fighting Foams," *Plant/Operations Progress*, Volume, 3, 1984.

Friedman, R., *Principles of Fire Protection Chemistry and Physics*, 3rd Edition, National Fire Protection Association, Quincy, Massachusetts, 1998.

Howells, P., "Electrostatic Hazards of Foam Blanketing Operations," *Health, Safety and Loss Prevention*, p. 312, 1983.

Nash, G., "New Concept in the Supply of Foam Compound to Oil Fires," *Fire International*, Volume 1, No. 12, p. 40, 1966.

NFPA 11, "Standard for Low-Expansion Foam," 2002 Edition, National Fire Protection Association, Quincy, Massachusetts.

NFPA 11A, "Standard for Medium-and High-Expansion Foam Systems," 1999 Edition, National Fire Protection Association, Quincy, Massachusetts.

NFPA 16, "Standard for the Installation of Foam-Water Sprinkler and Foam-Water Spray Systems," 1999 Edition, National Fire Protection Association, Quincy, Massachusetts.

B.16.7 Additional Reading

Woodworth, S.P., and J.A. Frank, *Fighting Fire with Foam*, Van Nostrand Reinhold, New York, 1994.

B.17 Harmful Properties of Toxic Gases Found In Fires

B.17.1 Introduction

Historically, more people are injured or killed by fire combustion products than by direct exposure to heat and flame. Evaluations have shown that personnel at distance from the source of a fire are particularly at risk from fire effluent in post-flashover fire scenarios (Beitel et al., 1998). Toxic gases are lethal largely because they cause people to become disoriented and panic thereby making it difficult to find escape routes. Following a period of hyperventilation, resulting from inhaling irritant gases the final cause of death is often carbon monoxide (CO) poisoning or scorching of the lungs by hot fire gases, rather than actual burning by the flames.

The most significant effluent toxicants in ordinary fires are CO, hydrogen cyanide (HCN), carbon dioxide (CO₂), hydrogen chloride (HCl), and nitrogen dioxide (NO₂). Speaking very generally, CO alone accounts for half of the fire toxicity problem, although it is far less toxic than many of the other gases found in fires. Nonetheless, CO is considered to be the primary toxicant because of its copious generation by all fires. The importance of any toxic gas species to a particular fire must reflect both its toxicity and its actual concentration in that particular fire. The time of exposure is also important for determining the effects from toxic gases. In general, a higher concentration allows the same biological effect to be reached in a shorter time. For toxicity data, the exposure period normally used is 30 minutes.

The following definitions of toxicity related terms are commonly used in fire and combustion toxicology, as defined by ASTM Standard E176-98.

Toxic hazard is the potential for physiological harm from the toxic products of combustion. Toxic hazard reflects both the quantity and quality of toxic products (quality is typically expressed as toxic potency. Toxic hazard is not the only hazard associated with fire, and is not an intrinsic characteristic of a material or product. Rather, toxic hazard depends upon the fire scenario, the condition of use of the material or product, and possibly other factors.

Toxic potency is a quantitative expression that relates concentration and exposure time to a particular degree of adverse physiological effects (for example, death) on exposure of humans or animals. The toxic potency of the smoke from any material, product, or assembly is related to the composition of that smoke, which, in turn, depends upon the conditions under which the smoke is generated.

Toxic potency of the smoke from a specimen or product is determined on a per-unit-specimen-mass basis. At present, for fire research, the dominant biological end point adopted is death and the measured quantity is the LC₅₀, which is the concentration (g/m³) of smoke which is lethal to 50-percent of the exposed specified test animals in a specified time period [the meaning of this variable is the amount of mass that needs to be dispersed into a volume of 1 m³ in order to cause a 50-percent probability of lethality. For substances where the composition is known (e.g., purge

gases), the LC_{50} is usually expressed in units of ppmv. The definition here is that 1 ppmv of gas means that there is one part of gas per million parts of air. The "v" denotes parts by volume rather than weight. The LC_{50} notation must include the exposure time, generally 30 minutes (along with a 14-day post-exposure observation period) (Babrauskas et al., 1991). The toxic potency is not an intrinsic characteristic of a material.

B.17.2 Smoke and Toxic Gases

Many studies have been undertaken on toxic combustion products of organic materials, with the objective of realistically assessing the associated hazard. Toxicities of CO, CO₂, HCN, HCl, and low O₂ have been examined in depth by Babrauskas (1991), who determined that narcosis is caused by fire gases, such as CO and HCN, as well as low O₂ concentrations and high CO₂ concentrations. Narcotic gases cause incapacitation mainly by acting on the central nervous system and, to some extent, the cardiovascular system. Most narcotic fire gases produce their effects by causing brain tissue hypoxia. Since the body possesses powerful adaptive mechanisms designed to maximize oxygen delivery to the brain, it is usually possible to maintain normal body functions up to a certain concentration of a narcotic, and be unaware of the impending intoxication. However, once the threshold is reached where normal functioning can no longer be maintained, deterioration is rapid and severe, beginning with signs similar to the effects of alcohol intoxication, including lethargy or euphoria with poor physical coordination, followed rapidly by unconsciousness and death if exposure continues (Tamura, 1994).

The manual of the American Conference of Governmental Industrial Hygienists, Inc., gives the threshold limit values (TLVs) and a description of various toxic gases. The TLV is defined as the time-weighted average concentration for a normal 8-hour workday and a 40-hour workweek to which nearly all workers may be repeatedly exposed, day after day without adverse effect. The TLVs and biological effects of concentrations above the TLV for toxic gases are as follows (Tamura, 1994):

B.17.2.1 Carbon Monoxide (CO)

CO is a common product of combustion generated in a fire environment. This highly toxic, non-irritating gas has long been recognized as a primary cause of fatalities related to combustion sources including fire. In fact, the majority of all fire fatalities are attributed to CO inhalation. CO is produced as a result of incomplete combustion of materials containing carbon and is present in large quantities in most fires. Invisible, odorless, tasteless, and slightly lighter than air, CO is the most significant toxicant as it can cause occupants to become incapacitated if the concentration is high enough and the exposure is long enough. CO acts by combining with hemoglobin in the blood to form carboxyhemoglobin (COHb). This is important because hemoglobin carries oxygen throughout the body, and it cannot do this if it is tied up as COHb and, therefore, unavailable for oxygen transport. In the absence of other contributing factors, a COHb concentration of 50-percent or greater is generally considered lethal in the blood of fire victims.

The highest concentration of CO to which people can be exposed day after day without adverse effect is 50 ppm. This concentration keeps the COHb level below 10-percent. Concentrations of 400 to 500 ppm can be inhaled for 1 hour without appreciable effect. Concentrations of 1,000 to 1,200 ppm cause unpleasant symptoms after 1 hour of exposure. Concentrations of 1,500 to 2,000 ppm for 1 hour of exposure are dangerous, and concentrations above 4,000 ppm are fatal in exposure of less than 1 hour (Sumi and Tsuchiya, 1971).

B.17.2.2 Hydrogen Cyanide (HCN)

HCN is one of the most rapidly acting toxicants, being approximately 20 times more toxic than CO. HCN is produced when materials involved in a fire contain nitrogen [for example, polyacrylonitrile (Orlon®), polyamide (nylon), wool, polyurethane, urea-formaldehyde, and acrylonitrile-butadiene-styrene (ABS)]. Inhalation of HCN may cause severe toxic effects and death within a few minutes up to several hours, depending upon the concentration inhaled. The action of HCN is attributable to the cyanide ion, which is formed by hydrolysis in the blood. Unlike CO, which remains primarily in the blood, the cyanide ion is distributed throughout the body fluids, bringing it into contact with the cells of vital tissues and organs.

The TLV for HCN is 10 ppm, and it can be inhaled for several hours without appreciable effect at concentrations of 20–40 ppm. The maximum amount that can be inhaled for 1 hour without serious reaction is 50–60 ppm. Concentrations of 120–150 ppm are dangerous in 30–60 minutes, and concentrations of 3,000 ppm or more are rapidly fatal (Sumi and Tsuchiya, 1971).

B.17.2.3 Carbon Dioxide (CO₂)

CO₂ usually evolves in large quantities from fires. While not particularly toxic at observer levels, moderate concentrations of CO₂ (on the order of 2-percent) increase both the rate and depth of breathing by about 50-percent, thereby increasing the respiratory minute volume (RMV). This condition contributes to the overall hazard of a fire gas environment by causing accelerated inhalation of toxicants and irritants. If 4-percent CO₂ is breathed, the RMV is approximately doubled, but the individual may scarcely notice the effect. Given any further increase in CO₂ from 4 percent up to 10-percent, the RMV may be 8 to 10 times the resting level (Hartzell, 1989).

The TLV of CO₂ is 5,000 ppm. Stimulation of respiration is pronounced at a concentration of 5-percent (50,000 ppm), and a 30-minute exposure produces signs of intoxication. Above 70,000 ppm, unconsciousness results in a few minutes (Sumi and Tsuchiya, 1971).

B.17.2.3 Hydrogen Chloride (HCl)

HCl is formed from the combustion of materials containing chlorine, the most notable of which is polyvinyl chloride (PVC) as used in common thermoplastic electrical cables. HCl is both a potent sensory irritant and potent pulmonary irritant. It is a strong acid, being corrosive to sensitive tissue such as the eyes. If inhaled, HCl will irritate and damage the upper respiratory tract and lead to

asphyxiation or death.

The TLV for HCl is 5 ppm. Concentrations as low as 75 ppm are extremely irritating to the eyes and upper respiratory tract, and behavioral impairment has been suggested. The maximum concentration allowable for short exposures of 30–60 minutes is 50 ppm. Concentrations of 1,000–2,000 ppm are dangerous even for short exposures (Sumi and Tsuchiya, 1971).

B.17.2.4 Nitrogen Dioxides

Nitrogen dioxides (NO_2 and N_2O_4) the common oxides of nitrogen (N) produced in a fire (the other nitric oxide, or NO). Nitrogen dioxide, which is very toxic, can be produced from the combustion of N-containing material. Nitric oxide has a short life in atmospheric air because it is converted into dioxide in the presence of oxygen. These compounds are strong irritants, particularly to mucous membranes. When inhaled, they damage tissues in the respiratory tract by reacting with moisture to produce nitrous and nitric acids. The TLV for nitrogen dioxide is 5 ppm. Immediate throat irritation can begin at 62 ppm. Short-exposure concentrations of 117–154 ppm are dangerous, and rapidly fatal at 140–775 ppm (Sumi and Tsuchiya, 1971).

B.17.3 Toxic Data

Toxicity or toxic data usually reflect the results of animal testing. The table of relative acute toxicity criteria given below was published by the National Institute for Occupational Safety and Health (NIOSH) in the Registry of the Toxic Effects of Chemical Substances (RTECS) in 1967. It is widely used to interpret animal toxicity data; the lower the dose number, the greater the toxicity. The measures of toxicity used in the Table B.17-1, LD_{50} and LC_{50} are explained in the discussion following the table (Spero, Devito, and Theodore, 2000).

| Rating | Keywords | LD_{50} Single Oral Dose* (mg/kg) | LC_{50} Inhalation Vapor Exposure* (ppm) | LD_{50} Skin** (mg/kg) |
|--------|-----------------------|--|---|---------------------------------|
| 4 | Extremely hazardous | #1 | #10 | #5 |
| 3 | Highly hazardous | 50 | 100 | 43 |
| 2 | Moderately hazardous | 500 | 1000 | 340 |
| 1 | Slightly hazardous | 5,000 | 10,000 | 2,800 |
| 0 | No significant hazard | >5,000 | >10,000 | >2,800 |

* Rats
**Rabbits

Data on animal toxicity usually identify the route of entry into the body (oral ingestion, inhalation, adsorption through the skin, etc.) first, followed by the test animal (mouse, rat, human, etc.), followed by the measure of toxicity. The most common measures of toxicity are as follows:

- **Lethal Dose 50-percent (LD_{50})** is the dose required to kill 50-percent of the test animals when administered by a route of entry other than inhalation. The dose of the chemical (usually solids or liquids) is given as mg/kg, which represents milligrams of chemical per kilogram of body weight of the test animal. The LD_{50} is expressed in this manner because more chemical is needed to kill a larger animal. For example, the oral rat LD_{50} for the HAP calcium cyanamide is 159 mg/kg.
- **Lethal Concentration 50-percent (LC_{50})** is similar to LD_{50} except that the route of entry is inhalation. The concentrations of the inhaled chemicals (usually gases) are expressed as parts per million (ppm) or milligrams per cubic meter (mg/m^3).
- **Lethal Dose Low (LDL_0)** is the lowest dose required to kill any of the animals in the study when administered by a route of entry other than inhalation.
- **Lethal Concentration Low (LCL_0)** is the same as LDL_0 except that the route of entry is inhalation.
- **Toxic Dose Low (TDL_0)** is the lowest dose used in the study that caused any toxic effect (not just death) when administered by a route of entry other than inhalation.
- **Toxic Concentration Low (TCL_0)** is the same as TDL_0 except that the route of entry is inhalation.
- **EC_{50}** is the concentration required to cause a 50-percent reduction in growth.
- **Acute Risks** are the risks associated with brief exposures to high concentrations.
- **Chronic Risks** are the risks associated with long-term exposures to low concentrations.

B.17.4 References

ASTM E176-98, "Standard Terminology of Fire Standards," ASTM Fire Test Standard, 5th Edition, American Society of Testing and Materials, West Conshohocken, Pennsylvania, pp. 834–842, 1999.

Babrauskas, V., "Effective Measurement Techniques for Heat, Smoke, and Toxic Fire Gases," *Fire Safety Journal*, Volume 17, No. 1, pp. 13–26, 1991.

Babrauskas, V., B.C. Levin, R.G. Gann, M. Paabo, R.H. Harris, R.D. Peacock, and S. Yusa, "Toxic Potency Measurement for Fire Hazard Analysis," NIST Special Publication 827, U.S. Department of Commerce, National Institute of Standards and Technology (NIST), Building and Fire Research Laboratory (BFRL), Gaithersburg, Maryland, 1991.

Beitel, J.J., C.L. Beyler, L.A. McKenna, and F.W. Williams, "Overview of Smoke Toxicity Testing and Regulations," NRL/MP/6180-98-8128, Naval Research Laboratory, Naval Technology Center for Safety and Survivability Branch, Chemistry Division, Washington, DC, April 15, 1998.

Hartzell, G.E., "Understanding of Hazards to Humans," Chapter 3, *Advances in Combustion Toxicology*, Volume One, Gordon, E. Hartzell, Editor, Technomic Publishing, Inc., 1989.

Spero, J.M., B. Devito, and L. Theodore, *Regulatory Chemicals Handbook*, Marcel Dekker, Inc., New York, 2000.

Sumi, K., and Y. Tsuchiya, "Toxic Gases and Vapors Produced at Fires," *Canadian Building Digest*, National Research Council of Canada, CBD 144, December 1971.

Tamura, G.T., *Smoke Movement & Control*, National Fire Protection Association, Quincy, Massachusetts, December 1994.

B.18 Effects of Decomposition Products of Halogenated Fire Extinguishing Agents

B.18.1 Introduction

When an ineffective Halon fire extinguishing system that is incapable of extinguishing its design-basis fire is installed in a compartment, the system discharge will actually degrade environmental conditions by introducing additional toxic gases.

The 18th Edition of the National Fire Protection Association (NFPA) Fire Protection Handbook (Taylor, 1997) identifies the effects of the decomposition products of Halon 1301 and 1211 fire extinguishing agents, as follows:

"Consideration of life safety during the use of halogenated agents must also include the effects of decomposition (or breakdown) products, which are relatively more toxic to humans. Decomposition of halogenated agents takes place on exposure to flame or surface temperatures above approximately 482 °C (900 °F). In the presence of available hydrogen (from water vapor or the combustion process itself), the main decomposition products of Halon 1301 are hydrogen fluoride (HF), hydrogen bromide (HBr), and free bromine (Br₂). Although small amounts of carbonyl halides (COF₂, COBr₂) were reported in the early tests, more recent studies have failed to confirm the presence of these compounds."

Table B.18.1-1 summarizes the major decomposition products of Halon 1301 and 1211. The approximate lethal concentration (ALC) for a 15-minute exposure to some of these compounds are given in Column 2 of Table B.18-1. Column 3 gives the concentrations of these materials that have been quoted as "dangerous" for short exposure.

Even in minute concentrations of only a few parts per millions (ppm), the decomposition products of the halogenated agents have a characteristically sharp, acrid odor. This characteristic provides a built-in warning system for the agent, but also creates a noxious, irritating atmosphere for those who must enter the hazard area following a fire. It also serves as a warning that other potentially toxic products of combustion (such as CO) will be present.

B.18.2 Toxicity of Decomposition Products of Halogenated Fire Suppression Agents

Hill (1977), summarizes the effects of hydrogen fluoride (HF) on humans at various concentrations. At concentrations as low as 32 ppm, irritation of eyes and nose occurs. At 60 ppm, irritation of the respiratory tract occurs after 60 seconds. At concentrations of 120 ppm, irritation of the conjunctival and respiratory tracts is tolerable for only 60 seconds. Concentrations between 50 and 100 ppm are considered dangerous to life after several minutes of exposure. Generally, the HF containing atmospheres are so irritating that personnel will be forced to evacuate before serious health risk is incurred. Decomposition product data clearly indicate that life-threatening

concentrations of HF likely. HF concentrations of 300 ppm are typically measured in full-scale tests.

| Table B.18-1. Approximate Lethal Concentrations (ALC) for Predominant Halon 1301 and Halon 1211 Decomposition Products | | |
|---|--|--|
| Compound | ALC for 15-minute Exposure (ppm by Volume in Air) | Dangerous Concentrations (ppm by Volume in Air) |
| Hydrogen fluoride, HF | 2,500 | 50–250 |
| Hydrogen bromide, HBr | 4,752 | - |
| Hydrogen chloride, HCl | - | - |
| Bromine, Br ₂ | 550 | - |
| Chlorine, Cl ₂ | - | 50 |
| Carbonyl fluoride, COF ₂ | 1,500 | - |
| Carbonyl chloride, COCl ₂ | 100–150 | - |
| Carbonyl bromide, COBr ₂ | - | - |

DeMonburn and McCormick (1973) have reported on the design and testing of Halon 1301 in extinguishing a wool bag filter fire in an industrial baghouse situation. The baghouse studied has an area of approximately 13.3 m² (144 ft²). These studies indicate that using rate of thermal detectors and the complete shutdown of the air flow through the baghouse, a 4-percent concentration of Halon 1301 would extinguish a fully developed fire. However, it should be noted that following extinguishment and 20 minutes soaking time, toxic levels of hydrogen fluoride, hydrogen cyanide, and hydrogen sulfide were detected in the unoccupied baghouse as shown in Table B.18-2.

| Table B.18-2. Concentration of Hazardous Gases Attributable to Decomposition of Halon 1301 in Industrial Baghouse Fire Situation | | | |
|---|--|---------------------------|--|
| Time (minutes) | Decomposition Product Concentration (ppm) | | |
| | Hydrogen Fluoride (HF) | Hydrogen Cyanide (HCN) | Hydrogen Sulfide (H ₂ S) |
| 0–4 | 55 | 1,643 | 2,452 |
| 20–24 | 10 | 194 | 112 |

The National Research Council Advisory Center reviewed the toxicity of Halon 1301 for consideration by NASA. In a letter to Dr. G.J. Stopps of the Haskell Laboratory, dated September 22, 1967, R.C. Wands, Director of the Toxicology Center, stated: *"Personnel can be exposed without significant hazard for a maximum of 5 minutes to normal air at 1 atmosphere and mixed with up to 6-percent mean concentration by volume of bromotrifluoromethane (CF₃Br (Halon 1301)) as a fire extinguishing agent. This assumes appropriate engineering design to sense the fire and deliver the agent so as to extinguish the fire promptly in order to minimize that pyrolysis products,"* (Atomic Energy Commission, 1970).

Ford (1975) has evaluated the issue of the decomposition of Halon 1301, and believes caution and limitations should be applied to the utilization of extinguishing systems containing that agent:

- Although safe at a design concentration of 5–7-percent, the Halon 1301 agent will not extinguish deep-seated Class A fires with these concentrations. Thus, water systems should be provided and higher concentrations of Halon 1301 should be used for extinguishment in these situations. If higher concentrations of Halon 1301 are provided, the design of the system should incorporate all of the requirements of the NFPA Standard 12A, and the operation of the system in relation to the personnel hazard should be identical to that of a CO₂ extinguishing system.
- Halon 1301 may decompose to untenable concentrations of hydrogen fluoride and hydrogen bromide when the vapor is in contact with heated surface above 482 °C (900 °F), or when the agent is applied to a large fire in a small enclosure. Table B.18-3 summarizes the relationship between the flame shield exposure and room size. Note in Situation One that the ratio of flame dimension to room size is 0.60, while in Situation Two, the ratio of flame dimension to room size is 6.0. The concentrations of the hydrogen fluoride and hydrogen bromide acid gases in situation two are beyond tolerable limits for human exposure. However, it must be remembered in this situation and the previous industrial baghouse situation presented by DeMonburn and McMormick, that the toxic products of combustion from the fire would in all probability also create an intolerable atmosphere for human exposure. The primary life hazard involves the entry of personnel into the area immediately following extinguishment. These characteristics of the Halon agent under intense thermal or flame exposure make the installation of these systems of oven or furnace chamber unsuitable where the temperature is above 260 °C (500 °F).

B.18.3 Physical Properties of Halon 1301

Under normal conditions, Halon 1301 is a colorless, odorless gas with a density approximately 5 times that of air. It can be liquefied upon compression for convenient shipping and storage. Unlike CO₂, Halon 1301 cannot be solidified at temperatures above -167.8 °C (-270 °F). The molecular weight of Halon 1301 is 148.93 (see Table B.18-4).

B.18.4 Physical Properties of Halon 1211

Under normal conditions, Halon 1211 is a colorless gas with a faintly sweet smell and a density about 5 times that of air. It can be readily liquefied by compression for storage in closed vessels. The molecular weight of Halon 1211 is 165.38 (see Table B.18-4 for properties of Halon).

| Table B.18-3. Halon 1301 Decomposition Produced by n-Heptane Fires | | | | | |
|--|---|----------------------|---------------------------|--|------------------------|
| Situation One | | | | | |
| 1,695 foot Enclosure Volume; 4-Percent Halon 1301 by Volume | | | | | |
| Fire pan size (ft ²) | Fuel area to volume ft ² /1000 ft ² | Discharge time (sec) | Extinguishment time (sec) | Decomposition products (ppm volume in air) | |
| | | | | Hydrogen Fluoride (HF) | Hydrogen Bromide (HBr) |
| 0.1 | 0.06 | 23.0 | 11.5 | 1.8 | 3.5 |
| 0.1 | 0.06 | 13.5 | 7.1 | 1.8 | 2.1 |
| 0.1 | 0.06 | 5.7 | 4.8 | 1.4 | 2.8 |
| Situation Two | | | | | |
| 1,695 foot Enclosure Volume; 4-Percent Halon 1301 by Volume | | | | | |
| Fire pan size (ft ²) | Fuel area to volume ft ² /1000 ft ² | Discharge time (sec) | Extinguishment time (sec) | Decomposition products (ppm volume in air) | |
| | | | | Hydrogen Fluoride (HF) | Hydrogen Bromide (HBr) |
| 10.0 | 6.0 | 25.0 | 20.0 | 1,907 | 397 |
| 10.0 | 6.0 | 15.0 | 16.3 | 1,206 | 382 |
| 10.0 | 6.0 | 6.0 | 10.0 | 666 | 112 |
| 10.0 | 6.0 | 6.0 | 5.2 | 320 | 38 |

| Table B.18-4. Selected Properties of Halon 1301, 1211, and 2402 | | | |
|---|------------------------------------|--------------------------------------|--|
| Extinguishing Agent | Halon 1301 (CF ₃ Br) | Halon 1211 (CF ₂ ClBr) | Halon 2402 (C ₂ F ₄ Br ₂) |
| Boiling point °C (°F) | -58 (-72.5 °F) | -4 (25 °F) | 47 (117 °F) |
| Liquid density at 20 °C (g/cc) | 1.57 | 1.83 | 2.17 |
| Latent heat of vaporization (J/g) | 117 | 134 | 105 |
| Vapor pressure at 20 °C (atm) | 14.5 | 2.5 | 0.46 |

B.18.5 References

Atomic Energy Commission, "Prepackaged Halon 1301 Fire Suppression System Tests," Number 294, Atomic Energy Commission, Health and Safety Information, Washington, DC, 1970.

DeMonburn, J.R., and J.W. McCormick, "Extinguishment of Wool Bag Filter Fires Using Halon 1301," Y-JA-94, Union Carbide Corporation, 1973.

Ford, C.B., "Why Not Halon1301?" *Fire Journal*, Volume 69, pp. 80-81, 1975.

Hill, R., "Evaluation of Halon 1301 System for Aircraft Internal Protection from a Postcrash External Fuel Fire," National Aviation Facilities Experimental Center, Atlantic City, New Jersey, March 1977.

Taylor, G.M., Halogenated Agent and Systems, Chapter 18, Section 6, *NFPA Fire Protection Handbook*, 18th Edition, Edition, A.E. Cote, Editors-in-Chief, National Fire Protection Association, Quincy, Massachusetts, 1997.

This page intentionally left blank.

B.19 An Introduction to Computer Fire Models

B.19.1 Introduction

ASTM E176 defines a fire model as a physical or mathematical representation of burning or other processes associated with fire. Physical models attempt to reproduce fire phenomena in a simplified physical situation. For example, scale models are a very widespread form of modeling, as full-scale experiments are expensive, difficult, and sometimes wholly infeasible. Insight can often be gained by studying fire phenomena at a reduced physical scale. Mathematical fire models include one or more empirical equation(s) that can be solved analytically or a set of complex differential and algebraic equations that must be solved numerically on a computer. A computer program to accomplish the numerical solution of complex set of differential and algebraic equations is called a computer fire model. Fire modeling can normally be considered as the prediction of fire characteristics by the use of a mathematical method which is expressed as a computer program.

The computer fire models have invaluable tools to assist in a wide range of uses in fire protection engineering research and development, fire-safe design of a structure, fire hazard analyses, fire spread, smoke control systems design, structural response of building members, human behavior and egress in the event of fire, actuation of thermal devices (sprinklers, detectors, ceiling vents etc.), hydraulic design of fire suppression systems, and fire investigation and reconstruction. Many building and fire regulations (including NFPA 805, "Performance-Based Standard for Fire Protection for Light Water Reactor Electric Generating Plants") allow for use of computer fire modeling as part of the performance-based fire safety designs to help bridge the gap between building functionality and fire code. The performance-based fire safety engineering is defined as "an engineering approach to fire protection design based on (1) agreed fire safety goals, loss objectives, and design objectives; (2) deterministic and probabilistic evaluation of fire initiation, growth, and development; (3) the physical and chemical properties of fire and fire effluents; and (4) quantitative assessment of the effectiveness of design alternatives against loss objectives and performance objectives" (Meacham and Custer, 1995 and Custer and Meacham, 1997).

B.19.2 Categories of Computer Fire Model

Fire model can be grouped into two categories: probabilistic or stochastic fire model and deterministic fire models. Probabilistic fire models involve the evaluation of the probability of risk due to fire based on the probabilities of all parameters influencing the fire such as human behavior, formation of openings and distribution of fuel load in the compartment of fire origin. The results of the models are in terms of the statistical likelihood of the occurrences of fires and fire outcomes, based on the random nature of fire and the likelihood of occurrence. Little or no information is given with respect to production and distribution of combustion products. In contrast to the probabilistic fire models, deterministic fire models are based on physical, chemical and thermodynamic relationship and empirical correlation to calculate the impact of fire. Deterministic fire models can be very simple requiring a short computing time or highly complex requiring hours of computation. Typically deterministic fire models can be classified as zone models, field models, and other models. The most commonly used computer fire models simulate the consequences of

a fire in an enclosure are zone and field models. Other models are special purpose models such as building evacuation (egress) models, models of thermal actuation devices (sprinklers and detection systems), models of structural fire resistance/endurance, fire sprinkler hydraulic design models, smoke movement/migration models, and fire-sprinkler interaction models.

A large number of fire computer models have been developed in recent years indicating the interest of researchers in the computer fire modeling field. A complete listing of these fire models is available in the fire model survey website, www.firemodelsurvey.com. This website contains information about the latest survey of computer fire models as completed by the developers of these models.

B.19.2.1 Zone Models

A zone model is essentially a one-dimensional model that solves the basic conservation equation for distinct volumes as a function of time. This type of model is used to predict fire growth and smoke spread in single or multi-enclosure structures. The model calculates the temperature and concentration of gas species (oxygen, carbon dioxide, etc.) as a function of time throughout the spaces modeled.

Zone model usually divide each room into two spaces or zones; an upper hot zone that contains the gases produced by the fire and a lower cool zone that is the source of the air for combustion. Zone sizes change during the course of the fire. The upper zone can expand and occupy virtually the entire room volume. By definition, zone models will always be approximate. The primary advantage of a zone model is its relative simplicity, which permits the inclusion of more phenomena. Also, cases may be run more rapidly and inexpensively on a personal computer.

A zone model requires input of the basic geometry of the space(s) being modeled, including physical dimensions, thermal properties of bounding materials, vent opening sizes and locations, mechanical ventilation, and position and growth rates of the specified fire. Output includes the upper and lower smoke layer temperature, interface location between zones (smoke layer height), oxygen and carbon monoxide concentrations, visibility, smoke flow in and out of openings, and heat flux from the hot gas layer to a target in the compartment as a function of time. Some examples of zone models are CFAST, FASTlite, ASET, COMPBRN-III, BRI-2, MAGIC, BRANZFIRE, FIGRO-II, FIREWIND, and FLAMME-S.

B.19.2.2 Field Models

Field models avoid the simplifications inherent in zone models and, consequently, their results are very refined compared to those of a zone fire model. Some field model calculations can be made on fast PCs; however, more complex problems are best run on powerful workstations and advanced computers. Such models numerically solve the conservation of mass, energy, and momentum, as well as diffusion and species equations associated with fire. The temperature, velocity, and gas concentration are calculated in two- or three-dimensional fields by using a finite

difference, finite element, or boundary element method. A compartment or space (domain) is discretized into computational cells. The greater the number of cells, the more refined the solution. The model determines the temperature, pressure, velocity, and species concentration within each cell at each time step.

The advantage of field models over zone models is that they can provide detailed information on fluid motions. The application of field modeling to fire problems has been dramatically increased over time. The ready availability of commercial computational fluid dynamics (CFD) software packages with increasing sophistication enables more widespread application. Applications of field models to fire problems include aircraft terminal atria spaces, air-supported structures, electrical generating stations, aircraft cabins, tunnels, hospitals wards, shopping malls, and warehouses. Some examples of field models are FDS, FLUENT, STAR-CD, JASMINE, PHOENICS, KOBRA-3D, FIRE, VESTA, and SOFIE.

B.19.2.3 Building Evacuation Model

Egress models are not truly fire models. They were developed in response to the need to evaluate the impact of fires on the occupants of a building. Most egress models describe the building as a network of paths along which the occupants travel. The occupants travel rates are usually derived from studies on people movement and vary with the age and ability of the occupants, crowding, and the types of travel paths. Model inputs include the geometry of the building and rooms, the openings between rooms, the number of occupants located each floor throughout the building, and the smoke data if the effect of smoke blockage is to be considered. The outputs include the location of each occupant with time, floor clearing time, stairwell clearing time, exit clearing time, and how many occupants used an exit. Some examples of evacuation models are EVACNET, EVACS, EGRASS, EXIT89, buildingEXODUS, BFIRII, Allsafe, EgressPro, and EESCAPE.

B.19.2.4 Models of Thermal Actuation Devices

Sprinkler and detection activation models are used to calculate the response time of sprinklers and detectors installed below unconfined smooth ceilings. These models also are used to estimate the size of a fire when a detection system activates, at which point egress can begin. Sprinkler and detection activation models use a heat transfer equation to calculate the temperature increase of detector sensing elements. These models assume that the thermal devices are located in a relatively large area and are heated by the ceiling jet flows (convective heat transfer), and predict the device actuation time for a user-specified heat release rate history. The sensitivity of the sprinkler/detector sensing element to an elevated temperature is often characterized by a constant parameter known as the response time index (RTI) which is derived experimentally. The required model inputs are the height of the ceiling above the fuel, distance of the thermal device from the axis of the fire, actuation temperature of the thermal device, RTI for the device, and heat release rate of the fire. The model outputs are the ceiling gas temperature at the device location and the device temperature (both as a function of time), time required for the device to actuate, and heat release rate at actuation. Some examples of thermal actuation modeled are DETACT-QS, DETACT-T2, LAVENT, JET, G-JET, and SPRINK.

B.19.2.5 Models of Structural Fire Resistance/Endurance

Structural fire resistance models estimate the structural fire endurance of a building system or member exposed to a fire environment by numerically solving the conservation of energy equations using a finite difference or finite element technique. The solution techniques are very similar to those used with field models. The structural fire resistance models evaluate the time-temperature history within a solid exposed to a fire environment. The solid region is divided into elements in much the same way that the field models divide a compartment into regions.

Steel and concrete configurations are most commonly analyzed with and without fire protection insulation. The models allow nonlinear material properties and boundary conditions. An effective analysis makes use of a mesh that fine where there are large temperature gradients. The thermal properties that are necessary to perform such an analysis are the thermal conductivity and specific heat. The density is also required, as are phase change (intumescent) data. The time-temperature history of the fire environment is considered by specifically defining the temperature at each time step during the solution. The heat transfer process attributable to the fire exposure is modeled using convection and/or radiation in the fire boundary and conduction through the solid. Some examples of PC-based structural fire resistance models are FIRES-T3, HEATING 7, FASBUS, and TASEF.

B.19.2.6 Fire Sprinkler Hydraulic Design Models

Fire sprinkler hydraulic design models are used to perform all necessary calculations to design a sprinkler system with a grid or loop, as required by NFPA 13, "Standard for Installation of Sprinkler Systems," to ensure that water supplies will meet the water density requirements for the control and extinguishment of fire. These models estimate sprinkler head requirements, water supply pressure, the lowest supply pressure that can adequately drive the sprinkler system, pipe sizes, and equivalent lengths for fittings. These models use conservation of mass and momentum equations based on the principles of hydraulic (fluid) motion. The fire sprinkler models work by dividing a sprinkler system network into a series of nodes and links. The nodes represent pipe junctions of sprinklers, while links represent pipes. The user can specify which sprinklers are open and the model balance the flow and pressure. The inputs to the model are pipe junctions, diameters, and length; the locations and types of fittings; and the sprinkler locations. Some examples of fire sprinkler hydraulic design models are FIRE, HCALC, HP4M-Grid Fire Sprinkler Design, HP6M-Tree and Loop Fire Sprinkler Design, THE, HASS, HyperCalc, and Sprinkler-CALC.

B.19.2.7 Smoke Movement Models

Smoke movement/migration models calculate the airflow and pressure differences throughout a building in which a smoke control system is operating in a fire situation. In these modes, a building is represented as a network of spaces or nodes, each at a specific pressure and temperature. The stairwells and other shafts are modeled by a vertical series of spaces, one for each floor. The air flow is a function of pressure differences across the leakage paths. That is, air flows through leakage paths from regions of high pressure to regions of low pressure. These leakage paths are

doors and windows that may be opened or closed. Leakage can also occur through partitions, floors, and exterior walls and roofs. The model inputs include the interior and exterior building temperatures, a description of the building flow network, and the flow produced by the ventilation or smoke control system. The outputs include the steady-state pressure and flows throughout the building. These models are capable of modeling the stack effect created in taller buildings during extreme temperature conditions. Some examples of smoke movement/migration models are ASCOS, CONTAMW, AIRNET, and ASMET.

B.19.2.8 Fire-Sprinkler Interaction Models

Fire-sprinkler interaction models simulate the environment and the response of sprinkler actuation links in compartment fires with draft curtains and fusible link operated ceiling vents. They include the effects of the ceiling jet and upper layer of hot gases beneath the ceiling. The program inputs include the compartment geometry, thermo-physical properties of the ceiling, fire elevation, fire heat release rate, fire diameter, ceiling vent area, fusible link RTI and actuation temperature, fusible link positions along the ceiling, link assignment to each ceiling vent, and ambient temperature. The model outputs include the temperature, mass, and height of the upper layer; temperature of each link; ceiling jet temperature and velocity at each link; radial temperature distribution along the interior surface of the ceiling; radial distribution of heat flux to the interior and exterior surfaces of the ceiling; fuse time of each link; and vent area that has been open. Examples of fire-sprinkler interaction models include LAVENT and JET.

B.19.2.9 Specialized Fire Models

Special purpose fire simulation programs includes, (1) BREAK1 (Berkeley Algorithm for Window Glass In a Compartment Fire) is a program which calculates the temperature history of a glass window exposed to user described fire condition (2) ELVAC (Elevator Evacuation) is an interactive computer program that estimates the time required to evacuate people from a building with the use of elevators and stairs. It is cautioned that elevators generally are not intended as a means of fire evacuation, and they should not be used during fires. However, it is possible to design elevator systems that for fire emergencies, and ELVAC can be used to evaluate the potential performance of such system (3) FIRDEMND simulates the suppression of post-flashover charring and non-charring solid-fuel fire in compartments using water sprays from portable hose-nozzle equipment used by the fire department. The output of the Fire Demand Model (FDM) shows the extinguishment effects of water spray at various flow rates and droplet sizes (4) SES (Subway Environment Simulation) computer program and subway environmental design handbook were developed in the early 1970's under sponsorship of the Urban Mass Transportation Administration (former name of the Federal Transit Administration (FTA)) to assist in the planning, design, and construction of subway ventilation systems. The SES fulfilled an unmet need in the transit engineering community, and has been widely used in the design of new rail systems or line extensions in: Washington, District of Columbia; Atlanta, Buffalo, Baltimore, Dallas, Los Angeles, San Francisco, Montreal, Toronto, the Seattle Bus Tunnel, and in rail transit systems around the world. The SES provides tunnel designers with the tools to: properly size and locate ventilation shafts, evaluate tunnel geometry and fan size, optimize temperature, and model the effects of heat

and smoke resulting from fires and other sources. The most recent enhancement is the validation of the subroutine which describes the behavior of smoke in emergency conditions.

B.19.3 Limitations and Uncertainties Associated with Computer Fire Modeling

Fire model permit development of a better understanding of the dynamics of building fires, to quantify the performance of a building, and can aid in the fire safety decision making process. This evaluation gives an overall fire assessment of the building systems in terms of preventing fire growth, providing for safe evacuation, fire resistance design, as well as predicting occupant behavior.

Nonetheless, there are certain limitations and uncertainties associated with fire modeling predictions. The decision to use a particular fire model should be based on the understanding of the limitations and assumptions of the model. The limits of applicability of any fire model must be clearly stated and known to the user so that the user does not go beyond the boundaries of realistic application of the theory utilized. The input uncertainty is primarily attributable to error and assumptions in the input data. Sensitivity analyses are used to identify the critical input parameters, which must be specified with much greater care than the parameters to which the model is relatively insensitive. The model uncertainty is primarily attributable to the assumptions made by the model, and can be quantified as a result of the validation process. Full-scale fire test data are subject to experimental uncertainty. Therefore, discrepancies between model predictions and experimental data might be at least partly, attributable to measurement errors. There are many problems in comparing the results from fire model simulations to data from full-scale experiments. Some of the problem are attributable to the difference between the form of the recorded experimental data and the form needed for computer model predictions. For example, contrary to the assumption of pre-flashover compartment zone models, there often is not a clear and sharp change distinguishing the lower and upper gas layers.

Extreme care must be exercised in interpreting the fire modeling results. For scenarios where the level of predicted hazard is well below the damage threshold, the results can be used with a high level of confidence, provided that there is a high level of confidence that all risk-significant scenarios have been considered. For scenarios where the level of predicted hazard is near the damage threshold, the results should be used with caution in view of the inherent uncertainties.

A primary method of handling modeling uncertainties is the use of engineering judgment. Among other things, this judgment is reflected in the selection of appropriate fire scenarios, hazard criteria, and fire modeling techniques. A slightly more formal application of engineering judgment is the use of safety factors, which can be applied in the form of fire size, increased or decreased fire growth rate, or conservative hazard criteria (Custer and Meacham, 1997). Experimental data obtained from fire tests, statistical data from actual fire experience, and other expert judgment can also be used to improve judgment and potentially decrease the level of uncertainty.

When using a fire model, it is wise to perform a sensitivity analysis of the output to changes in the input to determine if changes in the data or the model assumptions and applicability will lead to a

different decision. The sensitivity analysis will determine the most dominant and significant variables. It will also determine whether the user should pay careful attention to particular input values that might affect the result significantly.

B.19.4 Fire Models

A variety of computer fire models employing different features are currently available. Table B.19-1 provide a short description for some common fire models.

| Table B.19-1. Computer Fire Models | | |
|---|----------------|---|
| Model Name | Classification | Model Use |
| CFAST C onsolidated Model of F ire G rowth and S moke T ransport | Zone model | CFAST is a zone model that predicts the effect of a specified fire on temperatures, various gas concentrations and smoke layer heights in a multi-compartment structure. |
| FPETool F ire P rotection E ngineering T ool | Zone model | FPETool is a set of engineering equations useful in estimating potential fire hazard and the response of the space and fire protection systems to the developing hazard. Version 3.2 incorporates an estimate of smoke conditions developing within a room receiving steady-state smoke leakage from an adjacent space. Estimates of human viability resulting from exposure to developing conditions within the room are calculated based upon the smoke temperature and toxicity. |
| FASTLite | Zone model | FASTLite is a user friendly software package which builds on the core routines of FPETool and the computer model CFAST to provide calculations of fire phenomena for use by the building designer, code official, fire protection engineer, and fire-safety related practitioner. |
| ASET A vailable S afe E gress T ime | Zone model | A simple, user-friendly, one-room smoke-filling model computer code which simulates the smoke layer thickness, temperature, and concentrations of products of combustion due to fire of time-dependent, user-specified, energy and product release rate. |

Table B.19-1. Computer Fire Models (continued)

| Model Name | Classification | Model Use |
|--|-----------------------|---|
| BRANZFIRE | Zone model | A zone model to predict the environment in a compartmented structure. |
| COMPBRAN III | Zone model | Zone model for compartment fires, compatible with probabilistic analysis. |
| MAGIC | Zone model | Two zone mode, able to handle up to 24 compartment. MAGIC is designed for nuclear power plants. MEGIC is being extended to include non-rectangular room, convex and sloping ceiling, room cluttered with objects, spread of fire through ventilation ducts, and extinction. |
| FireWind | Zone model | FireWind is a collection of 18 programs which include one- and two-room zone models, heat radiation calculation, egress calculations, a heat conductivity model and more. |
| FIGARO II Fire and Gas Spread in Room | Zone model | It is a two-layer model which can be used for single-room and multi-room fire simulation. |
| FDS Fire Dynamics Simulator | CFD model | General purpose low Mac number CFD code specific to fire-related flows. |
| Star-CD | CFD model | General purpose CFD code, which contains industry standard models for modeling fire and smoke movement. |
| JASMINE | CFD model | A CFD or field model for predicting consequences of fire to evaluate design issues as the assessment of smoke ventilation design and/or interaction with HVAC and other fire protection measures. |
| PHOENICS | CFD model | PHONICS is a general purpose CFD code for use by academia and industry as a design and analysis tool for any process involving fluid flow, combustion, and heat and mass transfer. |

Table B.19-1. Computer Fire Models (continued)

| Model Name | Classification | Model Use |
|--|-----------------------|---|
| SOFIE S imulation of F ire in E nclosures | CFD model | SOFIE is a field modeling code based upon the solution of the Reynolds average Navier-Stokes equations using a finite volume approach. |
| KOBRA-3D | CFD model | Three-dimensional CFD model for complex geometries to be used for smoke spread and heat transfer analyses. |
| FIRE | CFD model | CFD model with water sprays and coupled to solid/liquid phase fuel to predict burning rate and extinguishment. |
| DETECT-QS D ETector A CTuation- Q uasi S teady | Detector actuation | A program for calculating the actuation time of thermal devices below unconfined ceilings for fires with arbitrary heat release rates. |
| DETECT-T2 D ETector A CTuation- T ime squared | Detector actuation | A program for calculating the actuation time of thermal devices below unconfined ceilings for fires with heat release rates which grow with time squared. |
| LAVENT L ink A ctuation V ENTs | Zone model | A zone model which predicts the actuation of fusible links as a function of depth below the ceiling and distance from the plume center in response to a ceiling jet produced by a user specified fire. |
| JET | Zone model | LET is a single compartment zone model for use in spaces where the lower layer remains close to ambient temperature and the fire is not ventilation limited. The model provides temperature predictions for the plume, ceiling jet, upper layer and ceiling as well as the upper layer depth. |
| G-JET | Smoke detection model | Design tool for all categories of smoke detectors to predict their response to performance requirements in applications. |

| Table B.19-1. Computer Fire Models (continued) | | |
|---|---|--|
| Model Name | Classification | Model Use |
| EVACNET4 | Evacuation/ egress model | EVACNET4 is a user-friendly interactive computer program that models building evacuations. The program accepts a network description and information on its initial contents at the beginning of the evacuation. |
| ELVAC | Elevator evacuation | Calculates emergency evacuation time using elevators. |
| EGRESS | Evacuation simulation model | Versatile model for predicting the evacuation of crowds which may be used in a large variety of situations. |
| EXIT89 | Evacuation model | An evacuation model designed to handle the evacuation of a large population of individuals from a high-rise building. |
| buildingEXODUS | Human behavior/ evacuation model | A PC based evacuation model that simulates individual people, behavior and enclosure details. The model includes |
| FIRES-T3 Fire REsponse of Structures - Thermal Three - Dimensional Version | Finite element heat transfer | FEM for 1-, 2- or 3-D conduction heat transfer with time-varying boundary conditions and temperature-dependent material properties. |
| TASEF Temperature Analysis of Structures Exposed to Fire | Structural | TASEF is a computer program for temperature of structures exposed to fire. This program is based on the finite element method. It is developed for temperature analysis of two dimensional and axisymmetrical structures. |
| ASCOS Analysis of Smoke Control Systems | Network air flow analysis | ASCOS is a program for steady air flow analysis of smoke control system |
| CONTAMW | Airflow model | A network model is used to predict pressure differences and airflow between compartments in a building |

Table B.19-1. Computer Fire Models (continued)

| Model Name | Classification | Model Use |
|--|---|--|
| ASMET Atria Smoke Management Engineering Tools | Package of engineering tools | ASMET consists of a set of equations and a zone fire model for analysis of smoke management systems for large spaces such as atria, shopping malls, arcades, sports arenas, exhibition halls and airplane hangers |
| BREAK1 Berkeley Algorithm for Breaking Window Glass in a Compartment Fire | | BREAK1 is a program which calculates the temperature history of a glass window exposed to user described fire conditions. The calculations are stopped when the glass breaks. |

B.19.5 References

ASTM E176, "Standard Terminology of Fire Standards," ASTM Fire Test Standard, 5th Edition, American Society of Testing and Materials, West Conshohocken, Pennsylvania. 1999.

Custer, R.L. and B.J. Meacham, *Introduction to Performance-Based Fire Safety*, "Uncertainty and Safety Factors," Chapter 9, Society of Fire Protection Engineers (SFPE) and National Fire Protection Association (NFPA), Quincy, Massachusetts. 1997.

"Information about Computer Models for Fire Growth and Smoke Transport," available at Fire Model Survey Web Site, www.firemodelsurvey.com This Web Site contains information about the latest survey of computer fire models, as completed by the developers of those models.

Meacham, B.J., and R.L.P. Custer, "Performance-Based Fire Safety Engineering: An Introduction of Basic Concepts," *SFPE Journal of Fire Protection Engineering*, Volume 7, No. 2. pp. 35–54: 1995.

B.19.6 Additional Readings

ASTM E1355-97, "Standard Guide for Evaluating the Predictive Capability of Deterministic Fire Models," ASTM Fire Test Standard, 5th Edition, American Society of Testing and Materials, West Conshohocken, Pennsylvania, pp. 1115–1120, 1999.

ASTM E1472, "Standard Guide for Documenting Computer Software for Fire Models," ASTM Fire Test Standard, 5th Edition, American Society of Testing and Materials, West Conshohocken, Pennsylvania, 1999.

Friedman, R., "An International Survey of Computer Models for Fire and Smoke," *SFPE Journal of Fire Protection Engineering*, Volume 4, No. 3. pp. 81–92, November 1992.

Hunt, S.P., "Computer Fire Models," NFPA Update, Issue 839, p. 7, October/November, 2000.

Janssens, M.L., "Evaluating Computer Fire Models," *Fire Protection Engineering Magazine*, Society of Fire Protection Engineers, Bethesda, Maryland. pp. 19–22, Winter 2002.

Olenick, S.M., and D.J. Carpenter, "An Updated International Survey of Computer Models for Fire and Smoke," *SFPE Journal of Fire Protection Engineering*, Volume 13, No. 2. pp. 87–110, May 2003.

Tubbs, J., "An Overview of the CFAST Computer Model," NFPA Update, Issue 840, p. 5, December/January, 2001.

APPENDIX C. SOURCES OF FIRE

This appendix discusses the various topics related to fire phenomena.

C.1 Heat Sources

Heat sources may vary widely in size, intensity, and duration. For instance, a tiny spark, a hot pin head, an exposure fire, and sun are all heat sources as are the following representative examples:

- A paper match contains about 1 kilo-joule (kJ) of heat energy released at a heat of about 45 watts (W).
- A standard laboratory candle contains about 1,500 kJ of heat energy released at a heat power of about 50 W.
- A small wooden match contains about 1.5 kJ of heat energy released at a heat of about 50 W.
- A large wooden safety match contains about 3 kJ of heat energy released at a heat of about 90 W.
- A common butane-type cigarette lighter contains about 230 kJ of heat energy. A 10 cm flame releases energy at a power of about 150 W; a 5 cm flame about 90 kW.
- A handheld plumber's propane torch contains up to 20 MJ of heat energy. A 10 cm flame releases energy at a power of about 1,800 W, or 1.8 kW.
- The heat energy required to ignite a flammable gas or vapor may be as low as 0.3 mJ (milli-joules).
- The heat energy required to ignite a flammable dust cloud may be as low as 20 mJ.

Table C.1-1 summarizes the common engineering terms and symbols related to heat sources, as they apply to fire hazard analysis.

| Table C.1-1. Common Engineering Terms Related to Heat Sources | | | | |
|--|--------------|-----------------------|-------------------|---------------------------|
| Term | Term Symbol* | Basic Unit | Recommended Units | |
| | | | Symbol | Name |
| Heat quantity is the total amount of heat energy released by the heat source. | Q | joules | kJ | Kilo-joules |
| Heat flux is the rate of heat energy released from the igniter per second. | \dot{Q} | watt | W | watt |
| Heat flux density is the amount of heat energy per unit area emitted from the heat source per second. | \dot{q}'' | watt per square meter | kW/m ² | kilowatt per square meter |
| Heat intensity is the temperature of a heat source. | T | Kelvin | K | Kelvin |
| Duration is the length of time between any two events (e.g., initial ignition to full room involvement). When a duration is specified, the beginning and ending events should be identified. Duration can also be used to represent the length of time the heat source is present. | t | second | s | second |
| *In fire protection engineering, Q and q are usually reserved for heat energy. Lower case t is conventionally used for time; capital T is usually used for temperature, but <i>never</i> time. | | | | |

C.1.1 Reference

SI Units Fire Protection Engineering, 1980 Report of the Measurement of Fire Phenomena Committee, Society of Fire Protection Engineers (SFPE), Boston, Massachusetts, March 1980.

C.2 Incident Heat

Table C.2-1 summarizes the common engineering terms and symbols related to incident heat (heat arriving at the surface of the target fuel).

| Table C.2-1. Incident Heat | | | | |
|--|-------------|-----------------------|-------------------|-------------------|
| Term | Term Symbol | Basic Unit | Recommended Units | |
| | | | Symbol | Name |
| Incident heat flux is the heat energy arriving at the target fuel surface from the igniter per second. | \dot{Q}_i | watt | W | watt |
| Incident heat flux density is the amount of heat energy per unit area arriving at the target fuel surface from the igniter per second. | \dot{q}_i | watt per square meter | kW/m ² | kW/m ² |
| Heat Intensity is the incident temperature near the target fuel surface. | T | Kelvin | K | Kelvin |
| Incident duration is the length of time the heat is received at the target fuel surface. | t | second | s | second |

C.2.1 Reference

SI Units Fire Protection Engineering, 1980 Report of the Measurement of Fire Phenomena Committee, Society of Fire Protection Engineers (SFPE), Boston, Massachusetts, March 1980.

This page intentionally left blank.

C.3 Target Fuel

Table C.3-1 summarizes the common engineering terms related to target fuel, focusing on heat-producing materials (i.e., combustibles) that may be driven to ignition by the incident heat source.

| Table C.3-1. Target Fuel | | | | |
|---|-------------|-----------------------|-------------------|---------------------------|
| Term* | Term Symbol | Basic Unit | Recommended Units | |
| | | | Symbol | Name |
| Heat power resistance is the maximum heat energy that the exposed surface of an initial target fuel can receive per second without causing initial ignition. | \dot{Q} | watt | W | watt |
| Heat power density resistance is the amount of heat energy per unit area received from an igniter (heat source) each second without causing ignition. | \dot{q}'' | watt per square meter | W/m ² | kilowatt per square meter |
| Heat Intensity resistance is the maximum surface temperature that the target fuel will tolerate without experiencing self-sustained burning with a pilot flame present. | T | Kelvin | K | Kelvin |
| Duration resistance is the length of time a target fuel can receive heat energy from an igniter at a given level without igniting. | t | second | s | second |
| *Target fuels generally respond on a time and energy basis. The higher the energy, the lower the time to ignition. This phenomenon is extremely complex (e.g., it depends on geometry, heat balance, and pilot ignition). | | | | |

C.3.1 Reference

SI Units Fire Protection Engineering, 1980 Report of the Measurement of Fire Phenomena Committee, Society of Fire Protection Engineers (SFPE), Boston, Massachusetts, March 1980.

This page intentionally left blank.

C.4 Flame/Heat Growth

Table C.4-1 summarizes common engineering terms related to flame/heat growth, focusing on burning within a space, room, or enclosure.

| Table C.4-1. Flame/Heat Growth | | | | |
|--|-------------|-----------------------|-------------------|---------------------------|
| Term | Term Symbol | Basic Unit | Recommended Units | |
| | | | Symbol | Name |
| Heat flux is the heat energy released from the igniter per second. | \dot{Q} | watt | MW | megawatt |
| Heat flux density is the amount of heat energy per unit area delivered from the burning material into the surrounding space per second. | \dot{q}'' | watt per square meter | kW/m ² | kilowatt per square meter |
| Heat intensity is the temperature within the burning space. The location of this reading within the space should be identified. | T | Kelvin | K | Kelvin |
| Duration is the length of time between two identical events during the fire growth within the space (e.g., time from ignition to first steady flame out the door). | t | Second | s | kilo-second |
| Duration to full room involvement is the length of time the fire takes to reach full room involvement (from ignition). | t | Second | s | kilo-second |
| Ventilation rate is the volume of air (oxygen) entering the burning space per second. | \dot{V} | m | m ³ /s | cubic meters per second |

C.4.1 Reference

SI Units Fire Protection Engineering, 1980 Report of the Measurement of Fire Phenomena Committee, Society of Fire Protection Engineers (SFPE), Boston, Massachusetts, March 1980.

This page intentionally left blank.

C.5 Fire Resistance

The fire resistance of a building may be defined as (1) its ability to withstand exposure to fire without losing its load bearing function and (2) its ability to act as a barrier to the spread of fire. These two abilities confine the fire to the compartment where it started and provide time for people to evacuate a building before it collapses as a result of a fire.

Before the room is fully involved, the temperatures are relatively low and they have a negligible influence on the fire resistance of building elements. The risk that structural members or fire barriers will fail actually begins when the fire reaches the fully developed stage. During In this stage, temperatures of 1,300 K or 1,027 °C (1,881 °F) or higher can be reached, and the heat transferred to building elements may substantially reduce their strength and ability to perform as a fire barrier. This risk also continues to exist during the decay period of the fire.

The behavior of fire-exposed building elements depends, in part on the fire severity and in part on the properties of the fire-exposed elements. The following tables summarizes the most important quantities that determine fire severity and the fire performance of building elements in response to fire exposure.

Table C.5-1. Common Engineering Terms Related to Fire Severity

| Term | Term Symbol | Basic Unit | Recommended Units | |
|---|-------------|------------------------|-------------------|-----------------------------|
| | | | Symbol | Name |
| Total load is the total amount of heat energy available for possible release. | Q | joules | kJ | kilo-joules |
| Heat load density is the amount of heat energy available possible release per unit area (floor or bounding room surface area). | Q" | joule per square meter | MJ/m ² | mega-joule per square meter |
| Heat flux density is the amount of heat energy per unit area emitted from the heat source per second. | \dot{Q} | watt | MW | magawatt |
| Heat intensity is the temperature of the fire. The specific point of measurement should be identified (e.g., flame temperature, average ceiling temperature, average hot gas layer temperature). | T | Kelvin | K | Kelvin |
| Duration of severity is the length of time heat is produced by the fire that could expose building elements to the fire. | T | second | ks | kilosecond |
| Opening factor is the measure of the rate of temperature increase associated with the fire, defined as the area of the openings multiplied by the square root of the height of the openings, divided by the total bounding surface area of the room. | F | square root meter | \sqrt{m} | square root meter |
| Emissivity is the ratio of the intensity of radiation emitted by the fire to that emitted by a blackbody of the same temperature. | ϵ | dimensionless | - | - |

Table C.5-2. Common Engineering Terms Related to Fire Performance

| Term | Term Symbol | Basic Unit | Recommended Units | |
|---|-------------|---------------------------|--------------------|-------------------------------|
| | | | Symbol | Name |
| Heat load resistance is the heat load required to cause the failure of a structural member or fire barrier. | Q_r | joules | MJ | mega-joules |
| Heat flux density is the amount of heat energy received from the fire per unit area of the element per unit time. | \dot{q}'' | watt per square meter | kW/m ² | kilowatt per square meter |
| Heat intensity is the temperature of the element at various locations during exposure to fire. | T | Kelvin | K | Kelvin |
| Thermal conductivity is the length of time the fire produces heat that could expose building elements to the fire. | k | watt per meter Kelvin | W/m-k | watt per meter Kelvin |
| Specific heat capacity is the heat necessary to increase the temperature of unit mass one degree | c_p | joule per kilogram Kelvin | kJ/Kg-K | kilojoule per kilogram Kelvin |
| Density is the mass per unit volume of a material. | ρ | kilogram per cubic meter | kg/m ³ | kilogram per cubic meter |
| Thermal diffusivity is one of the quantities that determine the rate of temperature increase in a material at points away from the surface. It is equal to the thermal conductivity divided by the product of the specific heat and density | α | square meter per second | mm ² /s | square millimeter second |
| Emissivity absorbed is the ratio of the intensity of radiation absorbed by the element to that absorbed by a blackbody of the same temperature. | ϵ | dimensionless | - | - |
| Coefficient of thermal expansion (linear) is the expansion of length per unit degree increase in temperature. | α | reciprocal degree Kelvin | 1/K | reciprocal degree Kelvin |

| Table C.5-2. Common Engineering Terms Related to Fire Performance (continued) | | | | |
|--|-------------|------------|-------------------|-------------|
| Term | Term Symbol | Basic Unit | Recommended Units | |
| | | | Symbol | Name |
| Modulus of elasticity is a measure of elastic deformation, defined as the stress needed to produce a unit strain. | E | Pascal | MPa | mega-pascal |
| Yield strength is the stress at which material exhibits a specified permanent deformation. | F_y | Pascal | MPa | mega-pascal |
| Ultimate strength is the highest stress a material can sustain before its ruptures. | F_u | Pascal | MPa | mega-pascal |

C.5.1 Reference

SI Units Fire Protection Engineering, 1980 Report of the Measurement of Fire Phenomena Committee, Society of Fire Protection Engineers (SFPE), Boston, Massachusetts. March 1980.

C.6 Fire Resistance/Endurance Ratings

This section identifies some of the most common fire-resistance ratings used in construction and industry. "A," "B," and "C" ratings were originally defined by the Safety of Life at Sea (SOLAS) regulations. Hydrocarbon fire exposures for pool and jet fires have recently evolved.

Fire Barriers (NFPA 255, "Standard Method of Test of Surface Burning Characteristics of Building Materials".)

The average temperature increase of any set of thermocouples for each class of element protected is more than 121 °C (250 °F) above the initial temperature; or the temperature increase of any one thermocouple of the set for each class of element protected is more than 163 °C (325 °F) above the initial temperature. Where required by the conditions of acceptance, a duplicate specimen shall be subjected to a fire exposure test for a period equal to one-half of that indicated as the resistance period in the fire endurance test, but not for more than 1 hour. Immediately there after, the specimen shall be subjected to the impact, erosion, and cooling effects of a hose stream directed first at the middle and then at all parts of the exposed face, with changes in direction made slowly. *However, The hose stream test shall not be required in the case of construction having a resistance period, as specified in the fire endurance test, of less than 1 hour.*

A Barriers (SOLAS or Title 46, Section 72.05–75.10, of the Code of Federal Regulations)

A 0 Cellulosic Fire, 60-minute barrier against flame/heat passage, no temperature insulation.

A 15 Cellulosic Fire, 60-minute barrier against flame/heat passage, 15-minute temperature insulation.

A 30 Cellulosic Fire, 60-minute barrier against flame/heat passage, 30-minute temperature insulation.

A 60 Cellulosic Fire, 60-minute barrier against flame/heat passage, 60-minute temperature insulation.

Class A divisions are those divisions formed by decks and bulkheads that comply with the following:

- They are constructed of steel or material of equivalent properties.
- They are suitably stiffened.
- They are constructed to prevent the passage of smoke and flame for a 1 hour standard fire test.
- They are insulated with approved noncombustible materials so that the average temperature of the unexposed side will not rise more than 180 °C (356 °F) above the original temperature within the time listed (A60: 60 minutes; A30: 30 minutes; A15: 15 minutes; A0: 0 minutes).

B Barriers (SOLAS or Title 46, Sections 72.05–72.10, of the Code of Federal Regulations)

B 0 Cellulosic Fire, 30-minute barrier against flame/heat passage, no temperature insulation.

B 15 Cellulosic Fire, 30-minute barrier against flame/heat passage, 15-minute temperature insulation.

Class B divisions are those divisions formed by decks and bulkheads that comply with the following:

- They are constructed to prevent the passage of flame for a 30-minute standard fire test.
- They have an insulation layer such that the average temperature on the unexposed side will not rise more than 139 °C (282 °F) above the original temperature, nor will the temperature at any one point, including any joint, rise more than 225 °C (437 °F) above the original temperature (B15: 15 minutes; B0: 0 minutes).
- They are constructed of noncombustible materials.

C Barriers (SOLAS or Title 46, Sections 72.05–72.10 of the Code of Federal Regulations)

C Noncombustible Construction.

Class C barriers are constructed of noncombustible materials and are not rated to provide any smoke, flame, or temperature passage restrictions.

H Barriers (UL 1709)

An exposure rating to a hydrocarbon (petroleum) fire is typically given one of the following H ratings:

H 0 Hydrocarbon Fire, 120-minute barrier against flame/heat passage, no temperature insulation.

H 60 Hydrocarbon Fire, 120-minute barrier against flame/heat passage, 60-minute temperature insulation.

H 120 Hydrocarbon Fire, 120-minute barrier against flame/heat passage, 120-minute temperature insulation.

H 240 Hydrocarbon Fire, 120-minute barrier against flame/heat passage, 240-minute temperature insulation.

J Ratings

Jet fire exposure or impingement ("J" ratings) are specified by some vendors or property owners for resistance to hydrocarbon jet fire exposures. Currently, no standardized test or test specification has been adopted by an industry or governmental body. Some recognized fire testing and

experimental laboratories (SINTEF, Shell Research, etc.) have conducted extensive research on jet fire exposures and have proposed a test standard based on these studies (Ref. Offshore Technology Report OTO 93028, "Interim Jet Fire Test Procedure for Determining the Effectiveness of Passive Fire Protection Materials").

Fire Doors (NFPA 252, "Standard Methods of Tests of Door Assemblies")

A fire door assembly, which can consist of single doors, doors in pairs, special-purpose doors (e.g., dutch doors, double-egress doors), or multisection doors assembly for which a fire protection rating is determined and that is intended for installation in door openings in fire-resistive walls and provide a specific degree of fire protection to the opening.

The fire test can be conducted until the desired fire protection rating period is reached or until failure to meet any of the performance criteria specified in Chapter 5 of NFPA 252 as follows:

- 0.3 hour (20 minutes), Cellulosic fire
- 0.5 hour (30 minutes), Cellulosic fire
- 0.75 hour (45 minutes), Cellulosic fire
- 1.0 hour (60 minutes), Cellulosic fire
- 1.5 hour (90 minutes), Cellulosic fire
- 3.0 hour (180 minutes), Cellulosic fire
- Over 3.0 hours (in hourly increments), Cellulosic fire

Except for 20-minute rated door assemblies, for which it is optional, immediately following the fire endurance test, the door test assembly shall be subjected to the impact, erosion, and cooling effects of a hose stream. Temperature increase are listed at 121 °C, 232 °C, and 343 °C (250 °F, 450 °F, and 650 °F); absence of a temperature rating indicates an increase of more than 343 °C (650°F) on the unexposed surface of the door after 30 minutes of testing.

Fire Windows (NFPA 257, "Standard on Fire Test for Window and Glass Block Assemblies").

Fire ratings of windows were normally limited to the failure of wired glass at approximately 870 °C (1,600 °F); however, advances in glazing technology have increased the available fire-resistance ratings of window assemblies, as follows:

- 0.3 hour (20 minutes), Cellulosic fire
- 0.5 hour (30 minutes), Cellulosic fire
- 0.75 hours(45 minutes), Cellulosic fire

Higher ratings are also available based on the application of other fire-resistance standard fire tests (NFPA 255, "Standard Method of Test of Surface Burning Characteristics of Building Materials").

- 1.0 hour (60 minutes), Cellulosic fire
- 1.5 hour (90 minutes), Cellulosic fire
- 3.0 hours (180 minutes), Cellulosic fire
- Over 3.0 hours (in hourly increments), Cellulosic fire

Within 2 minutes following the fire endurance test, the fire-exposed side of the fire window assembly is subjected to the impact, erosion, and cooling effects of a standard hose stream.

Fire Dampers (UL Std. 555)

The fire test can be conducted on the fire dampers until the desired fire protection rating period is reached or until failure to meet any of the performance criteria specified in UL Standard 555 as follows:

- 0.3 hour (20 minutes), Cellulosic fire
- 0.75 hour (45 minutes), Cellulosic fire
- 1.0 hour (60 minutes), Cellulosic fire
- 1.5 hours (90 minutes), Cellulosic fire

Smoke Dampers (UL Std. 555S)

Smoke dampers are specified on the basis of the leakage class, maximum pressure, maximum velocity, installation mode (horizontal or vertical), and degradation test temperature of the fire.

Roof Coverings (NFPA 256, "Standard Tests of Fire Tests of Roof Coverings")

The fire test can be conducted on the fire dampers until the desired fire protection rating period is reached or until failure to meet any of the performance criteria specified in NFPA Standard 256 as follows:

- Class A: flame spread less than 6 feet (1.82 meters)
- Class B: flame spread less than 8 feet (2.44 meters)
- Class C: flame spread less than 13 feet (3.96 meters)

For all classes of roof coverings, there is to be no significant lateral flame spread, no flying brands or particles are to continue to flame or glow after reaching the floor, no flaming is to be produced on the underside of the deck of the test sample, and the roof deck should not be exposed.

Fusible Links

Fusible links are available in temperature ratings of 51.6 °C–260 °C (125 °F–500 °F) and in various load ratings.

The following table summarizes the fire-resistance test standards for building materials, aerosol, liquid paints, and plastics.

| Table C.6-1. Fire-Resistance Test Standards for Building Materials | | | |
|---|--|---|--|
| Organization and Test Specification | Name of Test | Sample | Property Measured |
| ASTM E69 | Crib test | Treated wood | Combustible properties |
| ASTM E84 | Surface burning of building materials | Building materials | Flame spread index, Smoke developed |
| ASTM E108 Building Codes, UBC 32-7 UL-790 | Fire rating of roof coverings | Coatings, shingle shake, insulation, etc. | Spread of flame, intermittent flame, burning brand, flying brand |
| ASTM E136 | Behavior of materials in vertical tube furnace | Building materials | Combustibility or non-combustibility of building materials |
| ASTM E160 | Crib test | Treated wood | Combustible properties |
| ASTM E162 | Surface flammability of materials using a radiant heat source | Sheet laminates, tiles, fabrics, liquids, films | Flame spread index, visual characteristics |
| ASTM E648 NFPA 253 | Critical radiant flux of floor covering systems | Floor covering systems | Critical radiant flux at flameout |
| ASTM E662 | Specific optical density of smoke generated by solid materials | Solid materials (e.g., wood, plastic) | Specific optical density |
| CPSC HH-I-515D, HH-I-521F, HH-I-1030B 16CFR 1209.6 | Critical radiant flux of attic insulation | Exposed attic floor insulation | Critical radiant flux at flameout |

| Table C.6-1. Fire-Resistance Test Standards for Building Materials (continued) | | | |
|---|-----------------------------|---------------|--------------------------|
| Organization and Test Specification | Name of Test | Sample | Property Measured |
| NIST NBSIR-82-2532 | Combustion product toxicity | All materials | Inhalation toxicity |
| NY State, Dept. of State 15,1120 | Modified Pittsburgh Test | All materials | Inhalation toxicity |

| Table C.6-2. Fire-Resistance Test Standards for Aerosol and Liquid Paints | | | |
|--|-----------------------------|---------------------------------|--------------------------|
| Organization and Test Specification | Name of Test | Sample | Property Measured |
| ASTM D56, D92, D93, D1310 | Flash point | Liquids | Flash point |
| ASTM D3243 D3278 | Flash point-set a flash | Liquids, aviation turbine fuels | Flash point |
| ASTM D1360 | Fire retardancy of paint | Paint | Fire retardancy |
| FHSA ASTM-API 16 CFR 500.43 | Flash point (tag open cup) | Aerosols | Flash point |
| FHSA CSMA 16 CFR 500.45 | Flame projection | Aerosols | Flame projection |
| CSMA Aerosol Guide | Drum test | Aerosols | Inhalation toxicity |
| NIST NBSIR-82-2532 | Combustion product toxicity | All materials | Inhalation toxicity |
| NY State, Dept. of State 15, 1120 | Modified Pittsburgh test | All materials | Inhalation toxicity |

Table C.6-3. Fire-Resistance Test Standards for Plastics

| Organization and Test Specification | Name of Test | Sample | Property Measured |
|---|--|--|---|
| ASTM D568 | Flammability of plastics 0.050" and under | Plastic sheets and film | non-burning, self-extinguishing, burning rate, visual characteristics |
| ASTM D635 | Rate of burning (self-supporting plastics) | Rigid plastics | Burning rate, visual characteristics |
| ASTM D757 | Incandescence resistance (rigid plastics) | Rigid plastics | Burning rate, visual characteristics |
| ASTM D1929, Procedure B | Ignition properties of plastics | Plastic sheets and films, thermo-plastic pellets | Flash ignition temperature, self-ignition temperature, visual characteristics |
| ASTM D2843 | Smoke density from the burning of plastics | Plastic material | Percent of light absorption |
| Bureau of Ships NObs 84814 MIL-M-14g | Flammability and toxicity | Generally melamine plastic; any material | Flash ignition, self-ignition, composition and toxicity gases evolved |
| CPSC CS 192-53 16- CFR 1611.4 ASTM D-1433 | Flammability of plastic film | Plastic films, coated fabrics | Ignition time, rate of burning |
| Federal Test Method Std. FTMS 406 Method 2023 | Flame resistance of plastics | Plastics difficult to ignite | Ignition time, burning time, flame travel |
| NIST NBSIR-82-2532 | Combustion product toxicity | All materials | Inhalation toxicity |
| NY State, U.S. Department of State 15,1120 | Modified Pittsburgh test | All materials | Inhalation toxicity |

C.6.1 Reference

Nolan, D.P., *Encyclopedia of Fire Protection*, Delmar Publishers, Albany, New York, 2001.

C.7 FIRE TEST STANDARDS

This section lists the empirical standard tests for fire-resistance, flame spread, and flammability.

The following list identifies the empirical standard fire-resistance tests.

| <u>Test Standard</u> | <u>Title</u> |
|----------------------|---|
| API 6 FA | Fire Tests for Valves |
| API 607 | Fire Tests of Quarter-Turn Valves |
| ASTM E119 | Fire Test of Building Constructions and Materials |
| ASTM E814 | Fire Tests of Through-Penetration Fire Stops (Penetration Seals) |
| ASTM E1529 | Determining Effects of Large Hydrocarbon Pool Fires on Structural Members and Assemblies |
| ASTM E1623 | Determination of Fire and Thermal Parameters of Materials, Products, and Systems Using an Intermediate-Scale Calorimeter (ICAL) |
| ASTM E163A | Fire Tests of Window Assemblies |
| ASTM E2074 | Fire Tests of Door Assemblies |
| BS 476, Part 20, 21 | Fire Test of Building Construction and Materials, Window Assemblies, and Door Assemblies (BSI) |
| ISO 834 | Fire Tests of Building Constructions and Materials |
| ISO 3008 | Fire Tests of Door Assemblies |
| ISO 3009 | Fire Tests of Window Assemblies |
| NFPA 251 | Fire Tests of Building Constructions and Materials |
| NFPA 252 | Fire Tests of Door Assemblies |
| NFPA 257 | Fire Tests of Window Assemblies |
| UBC 26-2 | Evaluation of Thermal Barriers |
| UBC 7-1 | Fire Tests of Building Constructions and Materials |
| UBC 7-2 | Fire Test of Door Assemblies |
| UBC 7-4 | Fire Test of Window Assemblies |
| UBC 7-5 | Fire Tests of Through-Penetration Fire Stops (Penetration Seals) |
| UL 9 | Fire Test of Window Assemblies |
| UL 10A/10B | Fire Test of Door Assemblies |
| UL 72 | Fire Resistance of Record Protection Equipment |
| UL 155 | Fire Test of Door Assemblies |
| UL 263 | Fire Test of Building Construction and Materials |
| UL 555 | Fire Dampers and Ceiling Dampers |
| UL 1479 | Fire Test of Through Penetration Fire Seals |
| UL 1709 | Rapid Rise Fire Tests of Protection Materials for Structural Steel |
| UL 2085 | Insulated Above Ground Tanks for Flammable and Combustible Liquids |

The following list identifies the empirical standard flame spread tests.

| <u>Test Standard</u> | <u>Title</u> |
|----------------------|--|
| ASTM E84 | Surface Burning Characteristics of Materials |
| ASTM E162 | Surface Flammability of Materials Using a Radiant Heat Energy Source |
| ASTM E648 | Critical Radiant Flux of Floor Covering Systems Using a Radiant Heat Energy Source |
| ASTM E970 | Critical Radiant Flux of Exposed Attic Floor Insulation Using a Radiant Heat Energy Source |
| IEEE 383 | Standard for Type Test of Class 1E Electric Cables, Field Splices, and Connections for Nuclear Power Generating Stations |
| IEEE 634 | Standard Cable Penetration Fire Stop Qualification Test |
| IEEE 1202 | Standard for Flame Testing of Cable for Use in Cable Tray in Industrial and Commercial Occupancies |
| NFPA 255 | Surface Burning Characteristics of Materials |
| NFPA 262 | Fire and Smoke Characteristics of Electrical and Optical Fiber Cables in Air Handling Spaces |
| NFPA 265 | Full-Scale Test for Room Fire Growth Contribution of Textile Wall Coverings |
| UBC 8-1 | Surface Burning Characteristics of Materials |
| UBC 8-2 | Full-Scale Test for Room Fire Growth Contribution of Textile Wall Coverings |
| UBC 26-3 | Room Fire Test Standard for Interior of Foam Plastic Systems |
| UL 910 | Fire and Smoke Characteristics of Electrical and Optical Fiber Cables in Air Handling Spaces |
| UL 1256 | Under-deck Roof Construction Test |
| UL 1581 | Reference Standard for Electrical Wires, Cables, and Flexible Cords, 1080, VW-1 Vertical Wire Flame Test. |
| UL 1581 | Reference Standard for Electrical Wires, Cables, and Flexible Cords, 1160, UL Vertical-Tray Flame Test. |
| UL 1715 | Room Fire Test Standard of Interior of Foam Plastic Systems |
| UL 1820 | Fire Test of Pneumatic Tubing for Flame and Smoke Characteristics |
| UL 1887 | Fire Test of Plastic Sprinkler Pipe for Flame and Smoke Characteristics |

The following list identifies the empirical standard small-scale flammability tests.

| <u>Test Standard</u> | <u>Title</u> |
|---|---|
| 16 CFR 1610.4 (CPSC) | Flammability of Wearing Apparel |
| 16 CFR 1630.4 (CPSC) | Flammability of Finished Textile Floor Covering Materials |
| 16 CFR 1653.4 (CPSC) | Flammability of Finished Textile Floor Covering Materials |
| ASTM C 1166 | Flame Propagation of Dense and Cellular Elastomeric Gaskets and Accessories |
| ASTM D635 | Rate of Burning and/or Extent and Time of Burning of Self-Supporting Plastics in a Horizontal Position |
| ASTM D1692 | Flammability of Plastic Sheeting and Cellular Plastics |
| ASTM D1929 | Ignition Properties of Plastics |
| ASTM D2584 | Ignition Loss of Cured Reinforced Plastics |
| ASTM D2859 | Flammability of Finished Textile Floor Covering Materials |
| ASTM D2863 | Measuring the Minimum Oxygen Concentration to Support Candle-Like Combustion of Plastics |
| ASTM D3801 | Method for Measuring the Comparative Extinguishing Characteristics of Solid Plastics in a Vertical Position |
| ASTM D3806 | Small-Scale Evaluation of Fire-Retardant Paints |
| ASTM D3894 | Evaluation of Fire Response of Rigid Cellular Plastics Using a Small Corner Configuration |
| ASTM D4804 | Flammability Characteristics of Nonrigid Solid Plastics |
| ASTM D4986 | Horizontal Burning Characteristics of Cellular Polymeric Materials |
| ASTM D5048 | Comparative Burning Characteristics and Resistance to Burn-Through of Solid Plastics Using a 125-mm Flame |
| ASTM E136 | Behavior of Materials in a Vertical Tube Furnace at 750°C |
| ASTM E662 | Specific Optical Density of Smoke Generated by Solid Materials |
| ASTM E1354 | Heat and Visible Smoke Release Rates for Materials and Products Using an Oxygen Consumption Calorimeter |
| ASTM F501 | Aerospace Materials Response to Flame, With Vertical Test Specimen |
| Boston Fire Dept. Code Sec.11.2 & 11.3 | Fire Tests of Flame Resistant Textiles and Films |
| Boston Fire Dept. IX-1 | Classification Fire Tests of Fabrics |
| Calif. Title 19 | Fire Tests of Flame-Resistant Textiles & Films; Intermediate Scale |
| CS 191 | Flammability of Wearing Apparel |
| FAA OSU | Rate of Heat Release Evaluation |
| FAR 25.853 | Test Procedure of Showing Compliance with §§ 25.853, 25.855 and 25.1359 (Aircraft Compartment Interior Fire Test) |
| FMVSS 302 | Flammability of Interior Materials—Passenger Cars, Multipurpose Passenger Vehicles, Trucks, and Buses |
| FTMS 191 | Flame Resistance of Cloth |
| ISO 5660 | Heat and Visible Smoke Release Rates for Materials and Products Using an Oxygen Consumption Calorimeter |

Test Standard**Title**

| | |
|----------|---|
| NFPA 253 | Critical Radiant Flux of Floor Covering Systems Using a Radiant Heat Energy Source |
| NFPA 258 | Specific Optical Density of Smoke Generated by Solid Materials |
| NFPA 263 | Rate of Heat Release Evaluation |
| NFPA 264 | Heat and Visible Smoke Release Rates for Materials and Products Using an Oxygen Consumption Calorimeter |
| NFPA 701 | Fire Tests for Flame Resistant Textiles and Films |
| NFPA 702 | Flammability of Wearing Apparel |
| NFPA 703 | Fire-Retardant Treated Wood |
| UBC 2-1 | Behavior of Materials in a Vertical Tube Furnace at 750 °C |
| UBC 26-6 | Ignition Properties of Plastics |
| UBC 26-7 | Rate of Burning and/or Extent and Time of Burning of Self-Supporting Plastics in a Horizontal Position |
| UBC 31-1 | Flame-Retardant Membranes |
| UL 94 | Flammability of Plastic Materials |
| UL 214 | Tests for Flame Propagation of Fabrics and Films |
| UL 1975 | Fire Tests for Foamed Plastics Used for Decorative Purposes |

Abbreviations

| | |
|------|--|
| API | American Petroleum Institute |
| ASTM | American Society for Testing and Materials |
| BS | British Standard |
| CPSC | Consumer Product Safety Commission |
| FAA | Federal Aviation Administration |
| IEEE | Institute of Electrical and Electronic Engineers |
| ISO | International Standards Organization |
| NFPA | National |
| OSU | Ohio State University |
| UBC | Uniform Building Code |
| UL | Underwriters Laboratories |

APPENDIX D. NRC DOCUMENTS RELATED TO FIRE PROTECTION

This appendix provides the various NRC reference documents related to fire protection.

D.1 Code of Federal Regulations Related to Nuclear Regulatory Commission Fire Protection

The *Code of Federal Regulations* is a codification of the general and permanent rules published in the *Federal Register* by the Executive departments and agencies of the Federal Government. The code is divided into 50 titles, which represent broad areas subject to Federal regulation. Each title is divided into chapters, which usually bear the name of the issuing agency. Each chapter is further subdivided into parts covering specific regulatory areas. Title 10, "Energy," is composed of four volumes. These volumes are subdivided as Parts 1–50, 51–199, 200–499, and 500–end. The first and second volumes containing parts 1–199 comprise Chapter I, "Nuclear Regulatory Commission." The U.S. Nuclear Regulatory Commission sets requirements for the safe operation of commercial nuclear power reactors, licenses the construction and operation of the reactors, and inspects them to ensure that they are operating safely within the agency's regulations. NRC resident inspectors are stationed at each nuclear power plant and additional safety reviews are done by experts from NRC regional offices and headquarters.

- (1) *Code of Federal Regulations*, Title 10, "Energy," Section 50.12, "Specific Exemption", U.S. Government Printing Office, Washington DC.
- (2) *Code of Federal Regulations*, Title 10, "Energy," Section 50.48, "Fire Protection," U.S. Government Printing Office, Washington DC.
- (3) *Code of Federal Regulations*, Title 10, "Energy," Part 50, Appendix A, "General Design Criterion 3 - Fire Protection," U.S. Government Printing Office, Washington DC.
- (4) *Code of Federal Regulations*, Title 10, "Energy," Part 50, Appendix R, "Fire Protection Program for Nuclear Power Facilities Operating Prior to January 1, 1979," U.S. Government Printing Office, Washington DC.
- (5) *Code of Federal Regulations*, Title 10, "Energy," Part 54, "Requirements for Renewal of Operating Licenses for Nuclear Power Plants," U.S. Government Printing Office, Washington DC.

This page intentionally left blank.

D.2 Branch Technical Positions Related to Fire Protection

A branch technical position (BTP) sets forth a solution found to be acceptable by the NRC staff in dealing with a safety problem or safety-related problem. BTPs are included in the standard review plan (SRP) to serve as guides for the NRC staff reviewers as a means of achieving uniformity of interpretation and application of NRC requirements. Like regulatory guides, a BTP sets forth an acceptable method of complying with applicable regulations and not the only acceptable method.

The BTPs related to fire protection has been developed to provide comprehensive review guidance for nuclear power plant (NPP) fire protection programs (FPPs). These guidance identifies the scope and depth of fire protection that the Commission considers acceptable for NPPs. BTPs may be used for review of existing fire protection programs and program elements, proposed changes to existing programs that are subject to NRC review, new applications, fire vulnerability analyses [e.g., fire probabilistic risk assessments (PRA)], and programs for plant shutdown and decommissioning. Risk-informed and performance-based alternatives to the guidance presented in this regulatory guide may be acceptable and are evaluated on a case-by-case basis.

- (1) BTP APCSB 9.5-1, "Guidelines for Fire Protection for Nuclear Power Plants," May 1, 1976, February 24, 1977.
- (2) Appendix A to BTP APCSB 9.5-1, "Guidelines for Fire Protection for Nuclear Power Plants, Docketed Prior to July 1, 1976," (August 23, 1976), February 24, 1977.
- (3) BTP ASB 9.5-1, "Guidelines for Fire Protection for Nuclear Power Plants," Revision 1, March 1979.
- (4) BTP CMEB 9.5-1 (Formerly ASB 9.5-1), "Guidelines for Fire Protection for Nuclear Power Plants," Revision 2, July 1981.
- (5) BTP SPLB 9.5-1, (Formerly CMEB 9.5-1), "Guidelines for Fire Protection for Nuclear Power Plants," Draft, Revision D, December 2002.

Abbreviations

| | |
|--------------|--|
| APCSB | Auxiliary and Power Conversion Systems Branch |
| ASB | Auxiliary Systems Branch |
| CMEB | Chemical and Mechanical Engineering Branch |
| SPLB | Plant Systems Branch |

This page intentionally left blank.

D.3 NRC Regulatory Guides Related to Fire Protection

The Regulatory Guide (RG) provides guidance to licensees and applicants on implementing specific parts of the NRC's regulations, techniques used by the staff in evaluating specific problems or postulated accidents, and data needed by the staff in its review of applications for permits or licenses. Some guides delineate techniques used by the NRC to evaluate specific situations. Other provide guidance to applicants concerning information needed by the NRC in its review of construction permit (CP) and operating license (OL) applications. Many guides refer to or endorse national codes or standards (e.g., American Society of Mechanical Engineers (ASME), American National Standard Institute (ANSI), National Fire Protection Association (NFPA) etc.) that are developed by recognized national organizations. The guides are issued in the following ten broad divisions:

- (1) Power Reactors
- (2) Research and Test Reactors
- (3) Fuels and Materials Facilities
- (4) Environmental and Siting
- (5) Materials and Plant Protection
- (6) Products
- (7) Transportation
- (8) Occupational Health
- (9) Antitrust and Financial Review
- (10) General

Draft RGs are issued for public comment in the early stages of the development of a regulatory position. They have not received complete staff review and do not present an official NRC staff position until finalized and issued. Table D.3-1 provide the list of RGs related to fire protection.

| Table D.3-1. NRC Regulatory Guides Related to Fire Protection | | |
|---|---|--|
| Regulatory Guide | Title | Issue Date |
| 3.16 | General Fire Protection Guide for Plutonium Processing and Fuel Fabrication Plants | January 1974 |
| 1.39 | Housekeeping Requirements for Water-Cooled Nuclear Power Plants, Revision 2 | September 1977 |
| 1.120 | Fire Protection Guidelines for Nuclear Power Plants, Revision 1 | November 1977 (Withdrawn August 2001) |
| 1.52 | Design, Testing, and Maintenance Criteria for Post -accident Engineered Safety-Feature Atmosphere Cleanup System Air Filtration and Adsorption Units of Light-Water-Cooled Nuclear Power Plants, Revision 2 | March 1978 |

| Table D.3-1. NRC Regulatory Guides Related to Fire Protection (continued) | | |
|--|---|-------------------|
| Regulatory Guide | Title | Issue Date |
| 1.75 | Physical Independence of Electric Systems, Revision 2 | September 1978 |
| 1.91 | Evaluations of Explosions Postulated To Occur on Transportation Routes Near Nuclear Power Plants, Revision 1 | February 1978 |
| RTS 809-5 | Qualification Test for Cable Penetration Fire Stops for Use in Nuclear Power Plants | July 1979 |
| 1.175 | An Approach for Plant-Specific, Risk-Informed Decisionmaking: Inservice Testing, August 1998, RS809-5 Qualification Test for Cable Penetration Fire Stops for Use in Nuclear Power Plants | September 1979 |
| RS 902-4 | Fire Stops for Use in Nuclear Power Plants (Second Proposed Revision 3 to Regulatory Guide 1.33) Quality Assurance Program Requirements (Operation) | November 1980 |
| 1.10 | Emergency Planning and Preparedness for Nuclear Power Reactors, Revision 3 | August 1992 |
| 1.174 | An Approach for Using Probabilistic Risk Assessment in Risk-Informed Decisions On Plant-Specific Changes to the Licensing Basis | July 1998 |
| 1.184 | Decommissioning of Nuclear Power Reactors (Draft was issued as DG-1067) | August 2000 |
| 1.189 | Fire Protection for Operating Nuclear Power Plants (Draft was issued as DG-1097) | April 2001 |
| 1.191 | Fire Protection Program for Nuclear Power Plants during Decommissioning and Permanent Shutdown (Draft was issued as DG-1069) | May 2001 |
| DG-1110 | (Proposed Revision 1 to Regulatory Guide 1.174), "An Approach for Using Probabilistic Risk Assessment in Risk-Informed Decisions on Plant-Specific Changes to the Licensing Basis | June 2001 |
| 1.188 | Standard Format and Content for Applications to Renew Nuclear Power Plant Operating Licenses (Drafts were DG-1104 issued 8/00, DG-1047 issued 8/96, Draft DG-1009 issued 12/90) | July 2 2001 |
| 1.170.4 | Fire Protection Considerations for Nuclear Power Plants | |

D.4 NRC Generic Communications Related to Fire Protection

A generic communication is a transmittal to one or more classes of licensees. There are 6 types of generic communications, i.e., administrative letters, bulletins, circulars, generic letters, information notices, and regulatory issue summaries. Circulars were discontinued in February 1985.

D.4.1 NRC Administrative Letters Related to Fire Protection

Administrative letter (AL) is a type of generic communication issued to:

- Inform addressees of any of the following:
 - (1) Administrative procedure changes relating to implementation of the regulations or NRC staff positions.
 - (2) The issuance of a topical report evaluation or a NUREG-type document that is not technical in nature, does not contain a new or revised staff position, and is not appropriate for inclusion in either a generic letter or an information notice.
 - (3) Changes in NRC internal procedures or organizations.
- Request voluntary submittal of information of an administrative nature which will assist NRC in the performance of its function.
- Announce events of interest such as workshops or Regulatory Information Conferences.
- Other purposes of a strictly administrative nature.

Table D.4-1 provide the list of administrative letters related to fire protection.

| Table D.4-1. NRC Administrative Letters Related to Fire Protection | | |
|--|--|------------|
| Administrative Letter Number | Title | Issue Date |
| 94-03 | Announcing An NRC Inspection Procedure On Licensee Self-Assessment Programs For NRC Area-Of-Emphasis Inspections | 03-17-1994 |
| 94-07 | Distribution of Site-Specific and Site Emergency Planning Information | 05-06-1994 |
| 95-06 | Relocation of Technical Specification Administrative Controls Related to Quality Assurance | 12-12-1995 |
| 96-04 | Efficient Adoption of Improved Standard Technical Specifications | 10-09-1996 |
| 98-02 | Revisions to Event Reporting Guidelines for Power Reactors | 03-17-1998 |
| 98-09 | Priority for NRR Review of Risk-Informed Licensing Actions | 10-30-1998 |
| 98-10 | Dispositioning of Technical Specifications That Are Insufficient to Assure Plant Safety | 12-29-1998 |

This page intentionally left blank.

D.4.2 NRC Bulletins Related to Fire Protection

A bulletin (BL) is used to address significant issues having generic applicability that also have great urgency. A BL requests information from, requests specified action by, and requires a written response in accordance with Section 182.a of the Atomic Energy Act of 1954, as amended, and 10 CFR 50.54(f), from the addressees regarding matters of safety, safeguards, or environmental significance. Addressees may be asked to take compensatory action that is commensurate with urgency of the issue being addressed, and provide requested information and perform and submit analyses by a specific time. A BL may not request long term actions. A BL may request new or revised license commitments that are based on analyses performed and license-proposed corrective action. A BL may not require license commitments. To extent that circumstances permit, NRC staff will interact with the nuclear industry on the issue being addressed. Table D.4-2 provide a list of NRC BLs related to fire protection.

| Table D.4-2. NRC Bulletins Related to Fire Protection | | |
|---|--|------------|
| BL No. | Title | Issue Date |
| 75-04 | Cable Fire at Browns Ferry Nuclear Power Station | 03-24-1975 |
| 75-04A | Cable Fire at Browns Ferry Nuclear Power Station | 04-03-1975 |
| 75-04B | Cable Fire at Browns Ferry Nuclear Power Station | 11-03-1975 |
| 77-08 | Assurance of Safety and Safeguards During an Emergency-Locking Systems | 12-28-1977 |
| 78-01 | Flammable Contact-Arm Retainers in G.E. CR120A Relays. | 01-16-1978 |
| 78-03 | Potential Explosive Gas Mixture Accumulation Associated with BWR Offgas System Operations | 02-08-1978 |
| 81-03 | Flow Blockage of Cooling Water to Safety System Components by Corbicula Sp. (Asiatic Clam) and Mytilus Sp. (Mussel) | 04-10-1981 |
| 92-01 | Failure of Thermo-Lag 330 Fire Barrier System to Maintain Cabling in Wide Cable Trays and Small Conduits Free From Fire Damage | 06-24-1992 |
| 92-01 Supp-1 | Failure of Thermo-Lag 330 Fire Barrier System to Perform Its Specified Fire Endurance Function | 08-28-1992 |

This page intentionally left blank.

D.4.3 NRC Circulars Related to Fire Protection

A circular (CR) is a type of generic communication used to transmit information to licensees or permit holders when the information is of safety, safeguards, or environmental interest but replies from licensees are not necessary for IE to assess the significance of the matter. A CR does not involve a specific response to the NRC but, rather, informs the licensees or permit holder. Table D.4-3 provide a list of NRC CRs related to fire protection.

| Table D.4-3. List of NRC Circulars Related to Fire Protection | | |
|--|--|-------------------|
| Circular Number | Title | Issue Date |
| 77-03 | Fire Inside a Motor Control Center | 02-28-1977 |
| 78-04 | Installation Error that Could Prevent Closing of Fire Doors | 05-15-1978 |
| 78-18 | UL Fire Test | 11-02-1978 |
| 79-13 | Replacement of Diesel Fire Pump Starting Contactors | 07-16-1979 |

This page intentionally left blank.

D.4.4 NRC Generic Letters Related to Fire Protection

A generic letter (GL) is used to address an emergent or routine technical issue having generic applicability that is a matter on which NRC staff has interacted with the nuclear industry and has concluded that a generic communication is an appropriate means to effect resolution, or a risk significant, compliance, or adequate protection matter that NRC staff has concluded should be brought to the attention of the nuclear industry without extensive, prior interaction. A GL may request information from and/or request specific action by the addressees regarding matters of safety, safeguards, or environmental significance. The addressee may ask to accomplish the actions and report their completion by letter, with or without prior NRC approval of the action taken. Information requests typically will be on a voluntary basis, i.e., will not require a written response in accordance with Section 182.a of the Atomic Energy Act of 1954, as amended, and 10 CFR 50.54(f). A GL may request that the analyses be performed and, as appropriate, submitted for staff review, that description of proposed corrective action and other information be submitted for staff review, and that corrective actions be taken by a specified time. A GL may request new or revised license commitments based on analyses performed and proposed corrective actions, but may not require license commitments. Table D.4-4 provide the list of NRC GLs related to fire protection.

| Table D.4-4. NRC Generic Letters Related to Fire Protection | | |
|---|--|------------|
| Generic Letter | Title | Issue Date |
| 77-02 | Fire Protection Functional Responsibilities, Administrative Control and Quality Assurance | 08-29-1977 |
| 80-45 | Fire Protection Rule | 05-19-1980 |
| 80-48 | Revision To 5/19/80 Letter On Fire Protection | 05-22-1980 |
| 80-56 | Commission Memorandum And Order On Equipment Qualification | 06-25-1980 |
| 80-96 | Fire Protection | 11-14-1980 |
| 80-100 | Appendix R to 10 CFR 50 Regarding Fire Protection-Federal Register Notice | 11-24-1980 |
| 80-103 | Fire Protection - Revised Federal Register Notice | 11-25-1980 |
| 81-12 | Fire Protection Rule (45 FR 76602, November 19, 1980), February 20, 1981, and Clarification Letter | 03-31-1982 |
| 82-21 | Technical Specifications for Fire Protection Audits | 10-06-1982 |
| 83-33 | NRC Positions on Certain Requirements of Appendix R to 10 CFR 50 | 10-19-1983 |

| Table D.4-4. NRC Generic Letters Related to Fire Protection (continued) | | |
|--|---|-------------------|
| Generic Letter | Title | Issue Date |
| 85-01 | Fire Protection Policy Steering Committee Report, January 9, 1985 (GL 85-01 was issued only as a DRAFT for comment at public meetings which were held in 1984. However, GL 85-01 was never issued as a final and therefore is not available.) | 01-09-1985 |
| 86-10 | Implementation of Fire Protection Requirements | 04-24-1986 |
| 86-10 Supp-1 | Fire Endurance Test Acceptance Criteria for Fire Barrier Systems Used to Separate Redundant Safe Shutdown Trains Within the Same Fire Area | 03-25-1994 |
| 88-12 | Removal of Fire Protection Requirements from Technical Specifications | 08-02-1988 |
| 88-20 | Individual Plant Examination for Severe Accident Vulnerabilities | 11-23-1988 |
| 88-20 Supp-1 | Initiation of the Individual Plant Examination for Severe Accident Vulnerabilities - 10 CFR50.54 | |
| 88-20 Supp-2 | Accident Management Strategies for Consideration in the Individual Plant Examination Process | 04-04-1990 |
| 88-20 Supp-4 | Individual Plant Examination of External Events (IPEEE) for Severe Accident Vulnerabilities | 06-29-1991 |
| 88-20 Supp-5 | Individual Plant Examination of External Events (IPEEE) for Severe Accident Vulnerabilities - 10 CFR50.54(f) | 09-08-1995 |
| 89-13 | Service Water System Problems Affecting Safety-Related Equipment | 07-18-1989 |
| 89-13 Supp-1 | Service Water System Problems Affecting Safety-Related Equipment | 04-04-1990 |
| 91-18 | Information to Licensees Regarding Two NRC Inspection Manual Sections on Resolution of Degraded and Nonconforming Conditions and Operability | 11-07-1991 |
| 91-18 Rev. 1 | Information to Licensees Regarding Two NRC Inspection Manual Sections on Resolution of Degraded and Nonconforming Conditions and Operability | 10-08-1997 |
| 92-08 | Thermo-Lag 330-1 Fire Barriers | 12-17-1992 |
| 93-03 | Verification of Plant Records | 10-20-1995 |

Table D.4-4. NRC Generic Letters Related to Fire Protection (continued)

| Generic Letter | Title | Issue Date |
|-----------------------|---|-------------------|
| 93-06 | Research Results on Generic Safety Issue 106, Piping and the Use of Highly Combustibles Gases in Vital Areas | 10-25-1993 |
| 95-01 | NRC Staff Technical Position on Fire Protection for Fuel Cycle Facilities | 01-26-1995 |

This page intentionally left blank.

D.4.5 NRC Information Notices Related to Fire Protection

An information notice (IN) is a type of generic communication used to inform the nuclear industry of recently-identified, significant safety, safeguards, or environmental issues. Licensees are expected to review the information for applicability to their facilities or operations and consider actions, as appropriate, to avoid similar problems. INs do not convey changes in NRC policy or guidance and do not recommend specific courses of action. The suggestions contained in INs do not constitute NRC requirements and, therefore, no specific action or written response is required. They are rapid transmittals of information that may not yet have been completely analyzed by the NRC but that licensees should be aware of. Table D.4-5 provides the list of all INs related to fire protection.

| Table D.4-5. List of Information Notices Related to Fire Protection | | |
|---|---|------------|
| IN Number | Title | Issue Date |
| 79-32 | Separation of Electrical Cables for HPCI and ADS | 12-18-1979 |
| 80-11 | Generic Problems with ASCO Valves in Nuclear Applications Including Fire Protection Systems | 03-14-1980 |
| 80-25 | Transportation of Pyrophoric Uranium | 05-30-1980 |
| 81-27 | Flammable Gas Mixtures in the Waste Gas Decay Tanks in PWR Plants | 09-03-1981 |
| 82-28 | Hydrogen Explosion while Grinding in the Vicinity of Drained and Open Reactor Coolant System | 07-23-1982 |
| 82-53 | Main Transformer Failures at the North Anna Nuclear Power Station | 12-22-1982 |
| 83-41 | Actuation of Fire Suppression System Causing Inoperability of Safety-Related Equipment | 06-22-1983 |
| 83-69 | Improperly Installed Fire Dampers at Nuclear Power Plants | 10-21-1983 |
| 83-83 | Use of Portable Radio Transmitters Inside Nuclear Power Plants | 12-19-1983 |
| 84-09 | Lessons Learned From NRC Inspections of Fire Protection Safe Shutdown Systems (10 CFR 50, Appendix R) | 02-13-1984 |
| 84-09r1 | Lessons Learned From NRC Inspections of Fire Protection Safe Shutdown Systems (10 CFR 50, Appendix R) | 03-07-1984 |
| 84-16 | Failure of Automatic Sprinkler System Valves to Operate | 03-02-1984 |
| 84-42 | Equipment Availability For Conditions During Outages not Covered by Technical Specifications | 06-05-1984 |

| Table D.4-5. Information Notices Related to Fire Protection (continued) | | |
|--|---|-------------------|
| IN Number | Title | Issue Date |
| 84-92 | Cracking of Flywheels On Cummins Fire Pump Diesel Engines | 12-17-1984 |
| 85-09 | Isolation Transfer Switches and Post-Fire Shutdown Capability | 01-31-1985 |
| 85-30 | Microbiologically Induced Corrosion of Containment Service Water System | 04-19-1985 |
| 85-85 | Systems Interaction Event Resulting in Reactor System Safety Relief Valve Opening Following a Fire-Protection Deluge System Malfunction | 10-31-1985 |
| 86-13 | Standby Liquid Control System Squib Valves Failure to Fire | 02-21-1986 |
| 86-13 Supp-1 | Standby Liquid Control System Squib Valves Failure to Fire | 08-05-1985 |
| 86-17 | Update of Failure of Automatic Sprinkler System Valves to Operate | 03-24-1986 |
| 86-35 | Fire in Compressible Material at Dresden Unit 3 | 05-15-1986 |
| 86-106 | Feedwater Line Break | 12-16-1986 |
| 86-106 Supp-1 | Feedwater Line Break | 02-13-1987 |
| 86-106 Supp-2 | Feedwater Line Break | 03-18-1987 |
| 86-106 Supp-3 | Feedwater Line Break | 11-10-1988 |
| 87-14 | Actuation of Fire Suppression System Causing Inoperability of Safety-Related Ventilation Equipment | 03-27-1987 |
| 87-20 | Hydrogen Leak in Auxiliary Building | 04-20-1987 |
| 87-50 | Potential LOCA at High- and Low-Pressure Interfaces from Fire Damage | 10-09-1987 |
| 88-04 | Inadequate Qualification and Documentation of Fire Barrier Penetration Seals | 02-05-1988 |
| 88-04 Supp-1 | Inadequate Qualification and Documentation of Fire Barrier Penetration Seals | 08-09-1988 |
| 88-05 | Fire in Annunciator Control Cabinets | 02-12-1988 |
| 88-45 | Problems in Protective Relay and Circuit Breaker Coordination | 07-07-1988 |

Table D.4-5. Information Notices Related to Fire Protection (continued)

| IN Number | Title | Issue Date |
|------------------|--|-------------------|
| 88-56 | Potential Problems with Silicone Foam Fire Barrier Penetration Seal | 08-04-1988 |
| 88-60 | Inadequate Design and Installation of Watertight Penetration Seals | 08-11-1988 |
| 88-61 | Control Room Habitability - Recent Reviews of Operating Experience | 08-11-1988 |
| 88-64 | Reporting Fires in Nuclear Process Systems at Nuclear Power Plants | 08-18-1988 |
| 89-44 | Hydrogen Storage on the Roof of the Control Room | 04-27-1989 |
| 89-52 | Potential Fire Damper Operational Problems | 06-08-1989 |
| 90-70 | Pump Explosions Involving Ammonium Nitrate | 11-06-1990 |
| 91-17 | Fire Safety of Temporary Installations or Services | 03-11-1991 |
| 91-20 | Electrical Wire Insulation Degradation Caused Failure in a Safety-Related Motor Control Center | 03-19-1991 |
| 91-37 | Compressed Gas Cylinder Missile Hazards | 06-19-1991 |
| 91-47 | Failure of Thermo-Lag Fire Barrier Material to Pass Fire Endurance Test | 08-06-1991 |
| 91-53 | Failure of Remote Shutdown System Instrumentation Because of Incorrectly Installed Components | 09-04-1991 |
| 91-77 | Shift Staffing at Nuclear Power Plants | 11-26-1991 |
| 91-79 | Deficiencies in the Procedures for Installing Thermo-Lag Fire Barrier Materials | 12-06-1991 |
| 91-79 Supp-1 | Deficiencies Found in Thermo-Lag Fire Barrier Installation | 08-04-1994 |
| 92-14 | Uranium Oxide Fires at Fuel Cycle Facilities | 02-21-1992 |
| 92-18 | Potential for Loss of Remote Shutdown Capability During a Control Room Fire | 02-28-1992 |
| 92-28 | Inadequate Fire Suppression System Testing | 04-08-1992 |

| Table D.4-5. Information Notices Related to Fire Protection (continued) | | |
|--|---|-------------------|
| IN Number | Title | Issue Date |
| 92-46 | Thermo-Lag Fire Barrier Material Special Review Team Final Report Findings, Current Fire Endurance Tests, and Ampacity Calculation Errors | 06-23-1992 |
| 92-55 | Current Fire Endurance Test Results For Thermo-Lag Fire Barrier Material | 07-27-1992 |
| 92-82 | Results of Thermo-Lag 330-1 Combustibility Testing | 12-15-1992 |
| 93-40 | Fire Endurance Test Results for Thermal Ceramics FP-60 Fire Barrier Material | 05-26-1993 |
| 93-41 | One Hour Fire Endurance Test Results for Thermal Ceramics Kaowool, 3M Company FS-195, and 3M Company Interam E-50 Fire Barrier Systems | 05-28-1993 |
| 93-71 | Fire At Chernobyl Unit 2 | 09-13-1993 |
| 94-12 | Insights Gained From Resolving Generic Issue 57: Effects of Fire Protection System Actuation on Safety-Related Equipment | 02-09-1994 |
| 94-22 | Fire Endurance and Ampacity Derating Test Results for 3-hour Fire-Rated Thermo-Lag 330-1 Fire Barriers | 03-16-1994 |
| 94-26 | Personnel Hazards and Other Problems From Smoldering Fire-Retardant Material in the Drywell of a Boiling-Water Reactor | 03-28-1994 |
| 94-28 | Potential Problems With Fire-Barrier Penetration Seals | 04-05-1994 |
| 94-31 | Potential Failure of Wilco, Lexan-Type HN-4-L Fire Hose Nozzles | 04-14-1994 |
| 94-34 | Thermo-Lag 330-660 Flexi-Blanket Ampacity Derating Concerns | 05-13-1994 |
| 94-53 | Hydrogen Gas Burn Inside Pressurizer During Welding | 07-18-1994 |
| 94-58 | Reactor Coolant Pump Lube Oil Fire | 08-16-1994 |
| 94-59 | Accelerated Dealloying of Cast Aluminum-Bronze Valves Caused by Microbiologically Induced Corrosion | 08-17-1994 |
| 94-86 | Legal Actions Against Thermal Science, Inc., Manufacturer of Thermo-Lag | 12-22-1994 |
| 94-86 Supp-1 | Legal Actions Against Thermal Science, Inc., Manufacturer of Thermo-Lag | 11-15-1995 |

Table D.4-5. Information Notices Related to Fire Protection (continued)

| IN Number | Title | Issue Date |
|------------------|--|-------------------|
| 95-27 | NRC Review of Nuclear Energy Institute, Thermo-Lag Combustibility Evaluation Methodology Plant Screening Guide | 05-31-1995 |
| 95-32 | Thermo-lag 330-1 Flame Spread Test Results | 08-10-1995 |
| 95-33 | Switchgear Fire and Partial Loss of Offsite Power at Waterford Generating Station, Unit 3 | 08-23-1995 |
| 95-36 | Potential Problems with Post-Fire Emergency Lighting | 08-29-1995 |
| 95-36 Supp-1 | Potential Problem in Post-Fire Emergency Lighting | 06-10-1997 |
| 95-48 | Results of Shift Staffing Study | 10-10-1995 |
| 95-49 | Seismic Adequacy of Thermo-Lag Panels | 10-27-1995 |
| 95-49 Supp-1 | Seismic Adequacy of Thermo-Lag Panels | 12-10-1997 |
| 95-52 | Fire Endurance Test Results for Electrical Raceway Fire Barrier Systems Constructed From 3M Company Interam Fire Barrier Material | 11-14-1995 |
| 95-52 Supp-1 | Fire Endurance Test Results for Electrical Raceway Fire Barrier Systems Constructed from 3M Company Interam Fire Barrier Materials | 03-17-1998 |
| 96-23 | Fires in Emergency Diesel Generator Exciters During Operation Following Undetected Fuse Blowing | 04-22-1996 |
| 96-33 | Erroneous Data from Defective Thermocouple Results in a Fire. | 05-24-1996 |
| 96-34 | Hydrogen Gas Ignition During Closure Welding of a VSC-24 Multi-Assembly Sealed Baske | 05-31-1996 |
| 97-01 | Improper Electrical Grounding Results in Simultaneous Fires in the Control Room and the Safe-Shutdown Equipment Room | 01-08-1997 |
| 97-23 | Evaluation and Reporting of Fires and Unplanned Chemical Reactor Events at Fuel Cycle Facilities | 05-07-1997 |
| 97-37 | Main Transformer Fault with Ensuring Oil Spill into Turbine Building | 06-20-1997 |
| 97-48 | Inadequate or Inappropriate Interim Fire Protection Compensatory Measures | 07-09-1997 |
| 97-59 | Fire Endurance Test Results of Versawrap Fire Barriers | 08-01-1997 |

| Table D.4-5. List of Information Notices Related to Fire Protection (continued) | | |
|--|---|-------------------|
| IN Number | Title | Issue Date |
| 97-70 | Potential Problems with Fire Barrier Penetration Seals | 09-19-1997 |
| 97-72 | Potential for Failure of the Omega Series Sprinkler Heads | 09-22-1997 |
| 97-73 | Fire Hazard in the Use of a Leak Sealant | 09-23-1997 |
| 97-82 | Inadvertent Control Room Halon Actuation Due to a Camera Flash | 11-28-1997 |
| 98-31 | Fire Protection System Design Deficiencies and Common-Mode Flooding of Emergency Core Cooling System Rooms at Washington Nuclear Project Unit 2 | 08-18-1998 |
| 99-03 | Exothermic Reactions Involving Dried Uranium Oxide Powder (Yellowcake) | 01-29-1999 |
| 99-05 | Inadvertent Discharge of Carbon Dioxide Fire Protection System and Gas Migration | 03-08-1999 |
| 99-07 | Failed Fire Protection Deluge Valves and Potential Testing Deficiencies in Pre-Action Sprinkler Systems | 03-22-1999 |
| 99-17 | Problems Associated with Post-Fire Safe-Shutdown Circuit Analyses | 06-03-1999 |
| 99-28 | Recall of Star Brand Fire Protection Sprinkler Heads | 09-30-1999 |
| 99-28 Supp-1 | Recall of Star Brand Fire Protection Sprinkler Heads | 03-22-2002 |
| 99-34 | Potential Fire Hazard in the Use of Polyalphaolefin in Testing of Air Filters | 12-28-1999 |
| 00-12 | Potential Degradation of Firefighter Primary Protective Garments | 09-21-2000 |
| 00-14 | Non-Vital Bus Fault Leads to Fire and Loss of Offsite Power | 09-27-2000 |
| 01-04 | Neglected Fire Extinguisher Maintenance Causes Fatality | 04-11-2001 |
| 01-10 | Failure of Central Sprinkler Company Model GB Series Fire Sprinkler Head | 06-28-2001 |
| 01-12 | Hydrogen Fire at Nuclear Power Station | 07-13-2001 |
| 01-12 (Errata) | Hydrogen Fire at Nuclear Power Station | 08-08-2001 |

Table D.4-5. Information Notices Related to Fire Protection (continued)

| IN Number | Title | Issue Date |
|--------------------------|--|-------------------|
| 02-01 | Metalclad Switchgear Failures and Consequent Losses of Offsite Power | 01-08-2002 |
| 02-04 | Wire Degradation at Breaker Cubicle Door Hinges | 01-10-2002 |
| 02-07 | Use of Sodium Hypochlorite for Cleaning Diesel Fuel Oil Supply Tanks | 01-28-2002 |
| 02-15 | Hydrogen Combustion Events in Foreign BWR Piping | 04-12-2002 |
| 02-15 Supp. 1 | Potential Hydrogen Combustion Events in BWR Piping | 05-06-2003 |
| 02-24 | Potential Problems With Heat Collectors on Fire Protection Sprinklers | 07-19-2002 |
| 02-27 | Recent Fires at Commercial Nuclear Power Plants in the United States | 09-20-2002 |

This page intentionally left blank.

D.4.6 NRC Regulatory Issue Summaries Related to Fire Protection

A regulatory issue summary (RIS) is an informational document that is used to communicate with the nuclear industry on a broad spectrum have generic applicability. It does not involve a request for action or information unless it is strictly voluntary. Listed below are examples of way in which a RIS may be used:

- Document NRC endorsement of industry-developed resolutions to issues.
- Document NRC endorsement of industry guidance on technical or regulatory matters.
- Provide the status of staff interaction with the nuclear industry on a matter.
- Request the voluntary participation of licensees in staff-sponsored pilot programs.
- Inform licensees of opportunities for regulatory relief.
- Announce staff technical or policy positions on matters that have not been broadly communicated to the nuclear industry or are not fully understood.
- Provide guidance to licensees on regulatory matters, such as the scope and detail of information that should be provided in licensing applications to facilitate staff review.
- Announce the issuance and availability of regulatory documents (topical reports, NUREG-series documents and memoranda documenting the closeout generic safety issues (GSI)).
- Request the voluntary submittal of information which will assist the NRC in the administration of the regulatory process.
- Announce events of interest such as workshops and conferences.
- Announce changes in regulatory practices that could impact licensees.
- Announce changes in agency practices that could impact licensees.

Table D.4-6 provide the list of regulatory summaries related to fire protection.

| Regulatory Issue Summary Number | Title | Issue Date |
|---------------------------------|---|------------|
| 99-02 | Relaxation of Technical Specification Requirements for Porc Review of Fire Protection Program Changes | 10-13-1999 |
| 01-09 | Control of Hazard Barriers | 04-02-2001 |

This page intentionally left blank.

D.5 Commission (SECY) Papers Related to Fire Protection

The primary decision making tool of the Commission is the written issue paper submitted by the Offices of the Executive Director for Operations (EDO), Chief Financial Officer (CFO), Chief Information Officer (CIO), or other offices reporting directly to the Commission. Policy, rulemaking, and adjudicatory matters, as well as general information, are provided to the Commission for consideration in a document style and format established specifically for the purpose. Such documents are referred to as "SECY Papers". A SECY paper gains its nomenclature through the designation (e.g., SECY-95-189) assigned to it by the Secretariat. Headings on the first page designate whether the subject matter relates to the formulation of policy (Policy Issue papers), or to the promulgation of agency rules (Rulemaking Issue papers), or to the granting, suspending, revoking, or amending of licenses (Adjudicatory Issue paper). As described below, each paper also indicates the type of action expected of the Commission:

- **Commission Meeting Paper** indicates a major issue on which collegial deliberation and vote at a Commission meeting, usually in a public session, is anticipated.
- **Notation Vote Paper** indicates an issue requiring consideration by the Commission or consultation with the Commission prior to action by the staff, but not requiring discussion among Commissioners or a formal vote in a meeting.
- **Affirmation Paper** indicates Commission business that does not require discussion among the Commissioners in a meeting mode, but by law must be voted by the Commissioners in the presence of each other.
- **Negative Consent Paper** indicates a relatively minor action proposed to be taken by the staff in the future. The Commission is authorized a period of time (usually 10 days) in which to make its contrary views known; otherwise, SECY will advise the staff that the action proposed in the paper may be taken.
- **Information Paper** provide information on policy, rulemaking, or adjudicatory issues.

As a general policy, SECY papers will be released to the public immediately after Commission action is completed unless they contain specific, limited types of information which warrant protection (adjudicatory, enforcement or investigatory, lawyer-client or legal work product, classified or proprietary, and personal privacy information). Table D.5-1 provide the list of SECY papers related to fire protection.

| Table D.5-1. Commission (SECY) Papers Related to Fire Protection | | |
|---|---|-------------------|
| SECY | Title | Issue Date |
| 81-513 | Plan for Early Resolution of Safety Issues | 08-25-1991 |
| 82-267 | Fire Protection Role for Future Plants | 1982 |
| 83-133 | Integrated Safety Assessment Program (ISAP) | 03-23-1983 |
| 83-269 | Memorandum from W. J. Dircks to the Commissioners, "Fire Protection Role for Future Plants (SECY 82-267)" | 07-1983 |
| 89-081 | Final Report on Chernobyl Implications. | 03-07-1989 |
| 89-170 | Fire Risk Scoping Study: Summary of Results and Proposed Staff Actions | 06-07-1989 |
| 89-244 | Training Symposium on Firearms and Explosives Recognition and Detection | 08-21-1989 |
| 90-16 | Evolutionary Light Water Reactor (LWR) Certification Issues and Their Relationship to Current Regulatory Requirements | 01-12-1990 |
| 91-283 | Evaluation of Shutdown and Low Power Risk Issues | 09-09-1991 |
| 92-263 | Staff Plans for Elimination of Requirements Marginal to Safety | 08-26-1992 |
| 93-049 | Implementation of 10 CFR Part 45, Requirements for Renewal of Operating Licenses for Nuclear Power Plants | 03-01-1993 |
| 93-087 | Policy, Technical, and Licensing Issues Pertaining to Evolutionary and Advanced Light-Water Reactor (LWR) Designs | 04-02-1993 |
| 93-143 | NRC Staff Actions to Address the Recommendations in the Report on the Reassessment of the NRC Fire Protection Program | 05-21-1993 |
| 94-084 | Policy and Technical Issues Associated with the Regulatory Treatment of Non-Safety Systems in Passive Plant Design. | 03-28-1994 |
| 94-090 | Institutionalization of Continuing Program for Regulatory Improvement | 03-31-1994 |
| 94-127 | Options for Resolving the Thermo-Lag Fire Barrier Issue | 05-12-1994 |
| 94-219 | Proposed Agency-Wide Implementation Plan for Probabilistic Risk Assessment (PRA) | 08-19-1994 |
| 95-034 | Status of Recommendations Resulting from the Reassessment of the NRC Fire Protection Program | 02-13-1994 |

Table D.5-1. Commission (SECY) Papers Related to Fire Protection (continued)

| SECY | Title | Issue Date |
|-------------|---|-------------------|
| 99-079 | Status Update of the Agency-Wide Implementation Plan for Probabilistic Risk Assessment | 03-30-1995 |
| 96-134 | Option for Pursuing Regulatory Improvement in Fire Protection Regulations for Nuclear Power Plants | 06-21-1996 |
| 96-162 | Nuclear Power Plant-Specific Time-Temperature Curves for Testing and Qualifying Fire Barriers | 07-19, 1996 |
| 96-267 | Fire Protection Functional Inspection Program | 12-24-1996 |
| 97-127 | Development of a Risk-Informed, Performance-Based Regulation for Fire Protection at Nuclear Power Plants | 06-19-1997 |
| 97-278 | Staff Requirements, Plans to Issue Confirmatory Orders Concerning Schedules for Corrective Actions Regarding Licensee Use of Thermo-Lag 330-1 Fire Barriers | 12-24-1997 |
| 97-287 | Final Regulatory Guidance on Risk-Informing Regulations: Policy Issue | 12-12-1997 |
| 98-058 | Development of a Risk-Informed, Performance-Based Regulation for Fire Protection at Nuclear Power Plants | 03-26-1998 |
| 98-144 | White Paper on Risk-Informed and Performance-Based Regulation | 01-22-1998 |
| 98-161 | The Westinghouse AP600 Standard Design as it Related to the Fire Protection and the Spent Fuel Pool Cooling Systems. | 07-01-1998 |
| 98-187 | Interim Status Report - Fire Protection Functional Inspection Program | 08-03-1998 |
| 98-230 | Insights from NRC Research on Fire Protection and Related Issues | 10-02-1998 |
| 98-247 | Risk-Informed, Performance-Based Regulation for Fire Protection at Nuclear Power Plants | 10-27-1998 |
| 99-007 | Recommendations for Reactor Oversight Process Improvements | 01-08-1999 |
| 99-007A | Recommendations for Reactor Oversight Process Improvements | 03-22-1999 |
| 00-040 | Second Interim Status Report - Fire Protection Functional Inspection Program | 02-05-1999 |
| 99-140 | Recommendations for Reactor Fire Protection Inspections | 05-20-1999 |
| 99-152 | Status of Reactor Fire Protection Projects | 06-07-1999 |

| Table D.5-1. Commission (SECY) Papers Related to Fire Protection (continued) | | |
|---|---|-------------------|
| SECY | Title | Issue Date |
| 99-168 | Improving Decommissioning Regulations for Nuclear Power Plants | 06-30-1999 |
| 99-182 | Assessment of the Impact of Appendix R Fire Protection Exemptions on Fire Risk | 07-09-1999 |
| 99-183 | Proposed Rule: Elimination of the Requirement for Noncombustible Fire Barrier Seal Materials and Other Minor Changes (10 CFR Part 50) | 07-14-1999 |
| 99-204 | Kaowool and FP6-60 Fire Barriers | 08-04-1999 |
| 00-0009 | Rulemaking Plan, Reactor Fire Protection Risk-Informed, Performance-Based Rulemaking | 01-13-2000 |
| 00-0055 | Status Report on The Comprehensive Fire Protection Regulatory Guide For Operating Reactors | 03-02-2000 |
| 00-0080 | Final Rule: Elimination of the Requirement for Noncombustible Fire Barrier Penetration Seal Materials and Other Minor Changes | 04-10-2000 |
| 02-131 | Update of the Risk-Informed Regulation Implementation Plan | 02-12-2002 |
| 02-132 | Proposed Rule: Revision of 10 CFR 50.48 to Permit Light-Water Reactors to Voluntarily Adopt National Fire Protection Association (NFPA) Standard 805," Performance-Based Standard for Fire Protection for Light-Water Reactor Electric Generating Plants, 2001 Edition" (NFPA 805) as an Alternative Set of Risk-Informed, Performance-Based Fire Protection Requirements | 07-15-2002 |
| 03-0002 | Evaluation of the Effects of the Baltimore Tunnel Fire on Rail Transportation of Spent Nuclear Fuel | 03-25-2003 |

D.6 NRC Preliminary Notifications Related to Fire Incidents

Preliminary Notifications issued by the Regions to inform the Commission and NRC staff of incidents of interest occurring at NRC regulated facilities and some state regulated facilities. The following fire incidents were last more than 10 minutes, and the reports are preliminary in nature. Table D.5.1 provide the a list of preliminary notifications related to fire incidents.

Preliminary Notifications Issued in 1997

| Table D.6-1. Preliminary Notifications of Fire Incidents | | |
|--|---|------------|
| PN Number | Title | Issue Date |
| 29713 | Turkey Point 3&4 - Electrical Fire | 03-04-1997 |
| 19749 | Haddam Neck - Control Room Evacuation Due To Halon Activation | 08-08-1997 |
| 39780 | Quad Cities 1, 2 - Fire Response Safe Shutdown Procedure Deficiencies | 09-29-1997 |
| 49764 | General Atomics - Fire in Hot Cell Undergoing Decommissioning | 11-03-1997 |
| 39799 | Quad Cities 1 - Unit 1 Shut Down Because Appendix R (Fire) Safe Shutdown Analysis Not Completed | 12-23-1997 |

Preliminary Notifications Issued in 1998

| Table D.6-1. Preliminary Notifications of Fire Incidents (continued) | | |
|---|---|-------------------|
| PN Number | Title | Issue Date |
| 29816 | General Electric Company - Fire In Dumpster | 03-17-1998 |
| 29818 | GTS Duratek - Bag House Fire | 03-25-1998 |
| 29820 | Kenton Meadows Company, Inc. - Gauge Involved In Building Fire | 03-30-1998 |
| 49817 | Siemens Nuclear Power Corporation - Fire in Waste Handling Area | 04-15-1998 |
| 49817a | Siemens Nuclear Power Corporation - Fire in Waste Handling Area (Update) | 04-16-1998 |
| 29831 | Turkey Point - Notice of Unusual Event Due to Fire on Site Lasting More than 10 Minutes | 06-10-1998 |
| 49826 | Washington Nuclear 2 - Internal Flooding Caused by Fire Header Line Valve Rupture | 06-18-1998 |
| 49826a | Washington Nuclear 2 - Update to Internal Flooding Caused by Fire Water System Valve Rupture and Arrival of Augmented Inspection Team | 06-19-1998 |
| 49826b | Washington Nuclear 2 - AIT Activities for Internal Flooding Caused by Fire Water System Valve Rupture and Termination of NOUE | 06-23-1998 |
| 29833 | Schlumberger Technology - Well Fire Involving 40 Millicurie Cesium 137 Source | 07-02-1998 |
| 29833a | Schlumberger Technology - Well Fire Involving 40 Millicurie Cesium 137 Source (Update) | 07-07-98 |
| 39844 | Department of the Army - Tritium Contamination Event (Broken Fire Control Devices) | 09-14-1998 |
| 19849 | Safety Light Corporation - Fire in Building on Safety Light Corporation Site | 10-19-1998 |
| 19849a | Safety Light Corporation - Fire in Building on Safety Light Corporation Site (Update) | 10/21/1998 |
| 39848 | Fermi 2 - Decl. of Alert Cond. Due to Fire in Emerg. Diesel Gen. Control Panel | 10-21-1998 |
| 39858 | Portsmouth Gaseous Diffusion Plant - Fire in Process Building | 12-09-1998 |

Preliminary Notifications Issued in 1999

| Table D.6-1. Preliminary Notifications of Fire Incidents (continued) | | |
|---|---|-------------------|
| PN Number | Title | Issue Date |
| 39858a | Portsmouth Gaseous Diffusion Plant - Fire in Process Building- Update | 12/15/1998 |
| 39901 | Prairie Island 1 - Station Auxiliary Transformer Explosion and Fire | 01-06/1999 |
| 39858b | Portsmouth Gaseous Diffusion Plant - Fire in Process Building - Second Update | 01-13-1999 |
| 19903 | Fitz Patrick - Notification of Unusual Event Due to a Fire at an Onsite Hydrogen Storage Facility | 01-15-1999 |
| 19904 | Millstone 3 - Carbon Dioxide Discharge Into Cable Spreading Room | 01-20-1999 |
| 19926 | Pilgrim 1 - Main Transformer Fire - Media Interes | 05-19-1999 |
| 39931 | Palisades 1 - Minor Hydrogen Burns During Cask Welding Activities | 06-10-1999 |
| 39932 | Palisades 1 - Dry Cask Storage Project Office Damaged by Fire | 06-18-1999 |
| 39945 | Allied Signal, Inc. - Brush Fire on Site Property One-Fourth Mile From Plant | 10-01-1999 |
| 19946 | Nine Mile Point 1 - Unusual Event Declaration Due to Carbon Dioxide Discharge in Administration Building | 10-8-1999 |
| 29950a | Fairfax County Government - Fixed Gauge Damaged in a Fire | 12-27-1999 |

Preliminary Notifications Issued in 2000

| Table D.6-1. Preliminary Notifications of Fire Incidents (continued) | | |
|---|---|-------------------|
| PN Number | Title | Issue Date |
| 400011 | Unusual Event Because of a Fire Lasting Greater than 15 Minutes | 05-152-00 |
| 400011a | Update - Unusual Event Because of a Fire Lasting Greater Than 15 Minutes | 05-16-2000 |
| 400011b | Unusual Event Because of a Fire Lasting Greater Than 15 Minutes | 05-26-2000 |
| 400016 | Range Fire Nearby NRC Licensed Facilities (Siemens Power Corporation and WNP-2) | 06-30-2000 |
| 200031 | Alert Declared by Farley Due to Fire and Trip of the 2C Service Water Pump | 08-17-2000 |
| 200039 | Fire in B Main Power Transformer | 09-22-2000 |

Preliminary Notifications Issued in 2001

| Table D.6-1. Preliminary Notifications of Fire Incidents (continued) | | |
|---|---|-------------------|
| PN Number | Title | Issue Date |
| 401001 | Accidental Fire Damages Three Portable Gauges | 01-05-2001 |
| 201002 | Incinerator Fire | 01-6-2001 |
| 401004 | Circuit Breaker Failure and Fire, Resulting in Reactor Shutdown | 2-06-2001 |
| 301010 | Alert Declared Due to Small Fire on an Emergency Diesel Generator Bearing Cover | 03-22-2001 |
| 401025 | Fire Affecting The Startup Transformer at Cooper Nuclear Station | 06-25-2001 |
| 401024 | Switchyard Fire Caused by the Failure of the Phase a Bus Potential Transformer. | 06-25-2001 |
| 301027 | Electrical Panel Fire During Plant Startup | 08-06-2001 |
| 301029 | Fixed Gauges Damaged in Fire | 08-29-2001 |
| 301036 | Potential Small Fire Event | 11-06-2001 |

Preliminary Notifications Issued In 2002

| Table D.6-1. Preliminary Notifications of Fire Incidents (continued) | | |
|---|---|-------------------|
| PN Number | Title | Issue Date |
| 302025 | Fire in D.C. Cook Unit 1 Switchyard | 06-12-2002 |
| 302025A | Fire in D.C. Cook Unit 1 Switchyard (UPDATE) | 06-13-2002 |
| 302028 | Fire at Decommissioned Westinghouse-Hematite Uranium Fuel Fabrication Facility | 06-20-2002 |
| 302028A | Fire at Decommissioned Westinghouse-Hematite Uranium Fuel Fabrication Facility (Update) | 06-21-2002 |
| 202031 | Fire Trip of 1C Service Water Pump | 08-21-2002 |
| 202032 | Notification of Unusual Event (NOUN) Due to Fire in the Turbine Building - McGuire (Event Number 39145) | 08-23-2002 |
| 202036 | Unusual Event Declared, Fire in Control Building at Watts Bar Unit 1, Hydro Plant | 09-26-2002 |
| 202036A | Unusual Event Declared, Fire in Control Building at Watts Bar Unit 1, Hydro Plant | 09-30-2002 |

Preliminary Notifications Issued In 2003

| Table D.6-1. Preliminary Notifications of Fire Incidents (continued) | | |
|---|--|-------------------|
| PN Number | Title | Issue Date |
| 303014 | Unusual Event Declared Due to Fire in the Main Turbine | 04-29-2003 |

This page intentionally left blank.

D.7 NRC Miscellaneous Documents Related to Fire Protection

"Operating Experience Assessment, Energetic Faults in 4.16 kV to 13.8 kV Switchgear and Bus Ducts That Caused Fire in Nuclear Power Plants 1986-2001," Office of Nuclear Regulatory Research, U.S. Nuclear Regulatory Commission, Washington, DC, February 2002. (ADAMS Accession # ML021290358).

RES/OERAB/S02-01, Vol.1, "Fire Events - Update of U.S. Operating Experience, 1986-1999, Commercial Power Reactors," Division of Risk Analysis and Applications, Office of Nuclear Regulatory Research, U.S. Nuclear Regulatory Commission, Washington, DC, January 2002. (ADAMS Accession # 020360172) and (ADAMS Accession # ML020450056)

AEOD/S97-03, "Special Study: Fire Events - Feedback of U.S. Operating Experience," U.S. Nuclear Regulatory Commission, Office for Analysis and Evaluation of Operational Experience, June 1997.

"Fire Protection Barriers to Effective Implementation of NRC's Safety Oversight Process," U.S. Nuclear Regulatory Commission Washington, DC, Report to the Honorable Edward J. Markey, House of Representatives, GAO/REED-0039, U.S. General Accounting Office, Washington, DC, April 2000. (ADAMS Accession # ML003718163)

"Circuit Analysis-Failure Mode and Likelihood Analysis," A Letter Report to USNRC, Sandia National Laboratory, Albuquerque, New Mexico, ADAMS Accession # ML010450362, May 8, 2000. (This letter report is available through the NRC Public Document Room under a NRC cover memorandum from T. L. King, NRC/RES/DRAA to G. M. Holahan, NRC/NRR/DSSA and M.E. Mayfield, NRC/RES/DET, dated June 13, 2000.)

"A Evaluation of the Fire Barrier System Thermo-Lag 330-1," SANDIA 94-0146, Sandia National Laboratories (SNL), Albuquerque, New Mexico, September 1994.

NRC Inspection Manual, Part 9900 (IM STS-10) - Technical Guidelines, Standard Technical Specification, Section 1.0 - Operability, p. 31, 1986.

NRC Inspection Manual, Chapter 0609, Appendix F, "Determining Potential Risk Significance of Fire Protection and Post-Fire Safe Shutdown Inspection Findings", February 27, 2001.

Inspection Procedure 64100, (IP 64100) - Postfire Safe Shutdown Emergency Lighting and Oil Collection Capability at Operating and Near-term Operating Reactor Facilities.

Inspection Procedure 64150, (IP 64150) - Triennial Postfire Safe Shutdown Capability.

Inspection Procedure 64704, (IP 64704) - Fire Protection Program, June 24, 1998.

Inspection Procedure 71111.05, (IP 71111.05) - Fire Protection, April 3, 2000.

Temporary Instruction 2515/62 (TI 2515/62) - Post Fire Safe Shutdown Emergency Lighting and Oil Collection Capability at All Operating Plants, Revision 2, February 14, 1985.

Temporary Instruction 2515/XX (TI 2515/XX) - Fire Protection Functional Inspection.

NRR Office Instruction, "NRR Interface With the Office of the General Counsel", September 11, 2002. (ADAMS Accession # ML020910237)

Memorandum for Z. Rosztoczy from S. Bajwa, "Generic Issue 148: Smoke Control and Manual Fire Fighting Effectiveness; Generic Issue 149: Adequacy of Fire Barriers," April 3, 1991.

Letter to D. Basdekas (NRC) from L. Lambright (SNL), "Generic Issue 1480: Smoke Control and Manual Fire Fighting Effectiveness," March 4, 1992.

Memorandum for W. Minners from E. Beckjord, "Generic Issue 148: Smoke Control and Manual Fire Fighting Effectiveness; Generic Issue 149: Adequacy of Fire Barriers," August 26, 1992.

Memorandum from T. King to A. Thadani, "Staff Review Guidance for Generic Issue (GSI) 148: Smoke Control and Manual Fire Fighting Effectiveness; Generic Issue 149: Adequacy of Fire Barriers," July 22, 1992.

Memorandum dated July 22 1999, from Thomas L. King, Office of Nuclear Regulatory Research, NRC, to Ashok C. Thadani, Office of Nuclear Regulatory Research, NRC, Subject: Staff Review Guidance for Generic Safety Issue (GSI) 148, "Smoke Control and Manual Fire-Fighting Effectiveness."

Letter dated November 12, 1999, from Dana A. Powers, Chairman ACRS, NRC, to Dr. William D. Travers, Executive Director of Operations, NRC, Subject: Proposed Resolution of Generic Safety Issue (GSI)-148, "Smoke Control and Manual Fire-Fighting Effectiveness."

Letter dated December 15, 1999, from William D. Travers, Executive Director of Operations, NRC, to Dana A. Powers, Chairman ACRS, NRC, Subject: Resolution of Generic Safety Issue (GSI)-148, "Smoke Control and Manual Fire-Fighting Effectiveness."

NRC Letter to All Licensees Holding Operating Licenses and Construction Permits for Nuclear Power Reactor Facilities, "Individual Plant Examination for Severe Accident Vulnerabilities - 10 CFR § 50.54(f), (Generic Letter 88-20)," November 23, 1988, (Supplement 1) August 29, 1989, (Supplement 2) April 4, 1990, (Supplement 3) July 65, 1990, (Supplement 4) June 28, 1991.

ZAR-791030-01, "Report of the President's Commission on the Accident at Three Mile Island," J G. Kemeny, et al., November 30, 1979.

Memorandum for E. Beckjord from J. Murphy, "Staff Review Guidance for Generic Safety Issue (GSI) 147, Fire-Induced Alternate Shutdown/Control Room Panel Interactions," March 9, 1994.

Memorandum for W. Russell from T. Murley, "Final Report-Special Review Team for the Review of Thermo-lag Fire Barrier Performance," April 21, 1992.

Memorandum to Dr. Dana A. Powers, Chairman Fire Protection Subcommittee from, A. Singh, "Proposed Resolution of Generic Safety Issue 148, Smoke Control and Manual Fire-Fighting Effectiveness," September 17, 1999.

Koski, J.A., J.G. Bobbe, M. Arviso, S.D. Wix, D.E. Beene, R. Byrd, and J. Graupmann, "Experimental Determination of the Shipboard Fire Environment for Simulated Radioactive Material Packages," SAND 97-0606, Sandia National Laboratories, Albuquerque, New Mexico, 1997.

This page intentionally left blank.

D.8 NRR Staff Presentations and Publications Related to Fire Protection

Connell, E.A., "Individual Plant Examination of External Events Program: Perspectives on The Fire Risk Assessment of Operating Reactors," Second International Conference on Fire Research and Engineering on August 12, 1997, at the National Institute of Standards and Technology (NIST) in Gaithersburg, Maryland.

Connell, E.A., "Fire PRA Needs—Regulators Perspective," Proceedings from International Workshop on Fire Risk Assessment, Organized by the Nuclear Energy Agency (NEA), Committee on the Safety of Nuclear Installation (CSNI) Helsinki, Finland, 29 June–2 July 1999, NEA/CSNI/R(99)26.

Iqbal, N., and M.H. Salley, "Development of a Quantitative Fire Scenario Estimating Tool for the U.S. Nuclear Regulatory Commission Fire Protection Inspection Program," Structural Mechanics in Reactor Technology (SMiRT) Post-Conference Fire Protection Seminar No. 1, August 20-23, 2001, at the Millstone Nuclear Power Station Conference Facility in Waterford, Connecticut.

Iqbal, N., and M.H. Salley, "First Applications of a Quantitative Fire Hazard Analysis Tool for Inspection in the U.S. Commercial Nuclear Power Plants," 5th Meeting, International Collaborative Project to Evaluate Fire Models for Nuclear Power Plants Applications, Building and Fire Research Laboratory (BFRL), National Institute of Standards and Technology (NIST), Gaithersburg, Maryland, May 2–3, 2002.

Madden, P.M., "Defense-In-Depth: A Regulatory Approach for Assuring Post-Fire Safe-Shutdown Capability," Proceedings, Specialist Meeting on Fire Protection and Fire Protection Systems in Nuclear Power Plants, Committee on the Safety of Nuclear Installation (CNSI), Organization for Economic Co-Operation and Development (OECD), Cologne, Germany, 6–9 December 1993.

Madden, P.M., "Assessment of Postulated Fires Resulting From Turbine Failures and Their Mitigation at U.S. Nuclear Power Facilities," Fire Safety 1994 Conference, Barcelona, Spain.

Madden, P.M., "Fire Safety Rulemaking Issues Confronting Regulatory Change in the United States," Structural Mechanics in Reactor Technology (SMiRT) 14, Fifth Post Conference Seminar No. 6, Fire Safety in Nuclear Power Plants and Installations," August 25–28, 1997, Lyon, France.

Notley, D.P., "Fire Protection in Nuclear Power Plants - Understanding Competing Requirements for Safety," Proceedings of an International Symposium on Fire Protection and Fire Fighting in Nuclear Installation, Organized by the International Atomic Energy Agency (IAEA) Vienna, Austria, 27 February to 3 March 1989, pp. 53–63.

Salley, M.H., "Tests to Develop Corrective Measures For Electrical Raceway Fire Barrier Systems: Part 1 "Ten Rules of Fire Endurance Testing," The Society of Fire Protection Engineers (SFPE) Technical Symposium on Application of Fire Testing in Fire Protection Engineering Practice, March 12–13, 1998, Hyatt Fair Lakes Hotel, Fairfax, Virginia

Salley, M.H., "Perspectives on the Implementation of Fire Protection Risk-Informed, Performance-Based Regulations in the United States Nuclear Power Industry," NFPA World Fire Safety Congress and Exposition, Baltimore, Maryland, May 19, 1999.

This page intentionally left blank.

D.9 NRC Technical reports in the NUREG series Related to Nuclear Power Plant Fire Protection Engineering Research and Development (R&D)

The NRC publishes a variety of technical and regulatory reports, normally issued as NUREGs (NUREG is the NRC technical report designation (Nuclear Regulatory Commission)).

The NRC publishes the following types of documents in its NUREG-series: reports, including those prepared for international agreements, which cover a variety of regulatory, technical, and administrative subjects; brochures, which usually include directories, manuals, procedural guidance and newsletters and are often intended primarily for internal use; conference proceedings, a compilation of papers that have been presented at a conference or workshop; and books, which serve a unique technical purpose or an industry-wide need. Each NRC publication has a unique alphanumeric designator beginning with the alpha designator NUREG, followed by either a four-digit number or by two letters further identifying the type of report and a four-digit number, as follows:

NUREGs NRC staff reports or books prepared by the NRC staff
NUREG/BRs NRC brochures prepared by the NRC staff
NUREG/CRs NRC contractor reports prepared for the NRC by a contractor
NUREG/CPs NRC conference proceedings prepared by either the NRC staff or a contractor
NUREG/GRs NRC grantee reports prepared with the support of the NRC grant program
NUREG/IAs International agreement reports resulting from an international agreement and usually overseen by the NRC staff
NUREG/TRs Translation reports translated for the NRC

Availability Information

Copies NUREG documents may be obtained from from the following source:

Reproduction & Distribution Services Branch
Web, Publishing, and Distribution Services Division
Office of the Chief Information Officer
U.S. Nuclear Regulatory Commission
Mail Stop OWFN P1-33
Washington, DC 20555-0001
Email: DISTRIBUTION@nrc.gov
Facsimile: (301) 415-2289

Many NRC documents are available electronically in our Reference Library on our web site, www.nrc.gov, and through our Electronic Reading Room (ADAMS, or PARS, document system) at the same site. Copies of NUREGs and many other NRC documents are available for inspection or copying for a fee from the NRC Public Document Room (PDR) at:

U.S. Nuclear Regulatory Commission
Public Document Room
11555 Rockville Pike
Rockville, Maryland 20852

PDR's mailing address is:

U.S. Nuclear Regulatory Commission
Public Document Room
11555 Rockville Pike
Washington, DC 20555-0001;
Phone (301) 415 - 4737 or (800) 397 - 4209
Facsimile (301) 415 - 3548
E-mail pdr@nrc.gov.

Copies of NUREG-series reports are available at current rates from the:

Superintendent of Documents
U.S. Government Printing Office
Mail Stop SSOP
Washington, DC 20402-0001
Email: bookstore@gpo.gov
Phone: (202) 512-1800
Facsimile: (202) 512-2250

Also copies of NUREG-series reports are available from the:

National Technical Information Services (NTIS)
U.S. Department of Commerce
Technology Administration
5285 Port Royal Road
Springfield, Virginia 22161
Phone: (800) 553-6847 or (703) 605-6000
Internet: <http://www.ntis.gov>

The following is a list of NUREG reports related to fire protection:

NUREG-75/014, WASH-1400, "Reactor Safety Study: An Assessment of Accident Risks in U.S. Commercial Nuclear Power Plants," October 1975.

NUREG-75/087, "Standard Review Plan for the Review of Safety Analysis Reports for Nuclear Power Plants," LWR Edition, Interim Report, September 1975.

NUREG-75/087 (A11), "Standard Review Plan for the Review of Safety Analysis Reports for Nuclear Power Plants," LWR Edition, Interim Report, September 1975.

NUREG-75/087-CH2, "Standard Review Plan," Chapter 2, November 24, 1975.

NUREG-0050, "Recommendations Related to Browns Ferry Fire," Report by Special Review Group, February 1976.

NUREG/TR-0018, "Review of Literature on Vapor Explosion: First Technical Report on Research Project BMFT - RS 76", February 1976.

NUREG-0061, "Operation of Browns Ferry, Units 1 and 2 Following the March 22, 1975 Fire," Safety Evaluation Report, March 1976.

NUREG-0061-Suppl-1, "Operation of Browns Ferry, Units 1 and 2 Following the March 22, 1975 Fire," Safety Evaluation Report, Supplement 1, 18 June, 1976.

NUREG-766516, "Report on Task I - Fire Protection System Study," February 1977.

NUREG/CR-0075, "Accidental Vapor Phase Explosion on Transportation Routes Near Nuclear Power Plant," April 1977.

NUREG-0206, "Progress Report on Fire Protection Research," June 1977.

BNL-NUREG-23316, "Turbine Oil Fires as Related to Nuclear Power Stations," September 1977.

BNL-NUREG-23364, "Fire Damage Data Analysis as Related to Current Testing Practices for Nuclear Power Application," October 1977.

BNL-NUREG-23392, "Design Base Fires in Nuclear Power Plants," October 1977.

NUREG-0298 (Vol.1) (No.1), "Fire Protection Action Plan: Status Summary Report," 13 February, 1978.

NUREG/CR-0366, "Fire Protection Research Quarterly Progress Report (October - December 1977)," March 8, 1978.

BNL-NUREG-23910, "Fire Scenarios in Nuclear Power Plant," 1978.

NUREG/CR-0152, "Development and Verification of Fire Tests for Cable Systems and System Components," June 1978.

NUREG-0298 (Vol.1) (No.3), "Fire Protection Action Plan, Status Summary Report, Data for Decisions, Management by Objectives," 28 August, 1978.

NUREG/CR-0403, "High Temperature Testing of Smoke Detector Sources," September 1978.

NUREG/CR-0346, "Development and Verification of Fire Tests for Cable Systems and System Components," September 1978.

NUREG/CR-0381, "A Preliminary Report on Fire Protection Research Program Fire Barriers and Fire Retardant Coatings Tests", September 1978.

NUREG/CR-0376, "Models of Horizontal Electrical Cables and Cable Trays Exposed to a Fire Plume," September 1978.

BNL-NUREG-25101, "Performance of Fire Protection Systems Under Post Earthquake Conditions," October 1978.

NUREG/CR-0596, "Preliminary Report on Fire Protection Research Program Fire Barriers and Suppression (September 15, 1978, Test)," December 1978.

NUREG-0298 (Vol.1)(No.4), "Fire Protection Action Plan, Status Summary Report, Data for Decisions, Management by Objectives," December 1978.

NUREG/CR-0488, "Nuclear Power Plant Fire Protection-Fire Detection," (Subsystems Study Task 2), March 1979.

NUREG/CR-0636, "Nuclear Power Plant Fire Protection-Ventilation," (Subsystems Study Task 1), August 1979.

NUREG/CR-0468, "Nuclear Power Plant Fire Protection-Fire Barriers," (Subsystems Study Task 3), September 1979.

NUREG/CR-0654, "Nuclear Power Plant Fire Protection Fire-Hazard Analysis (Subsystems Study Task 4)," September 1979.

NUREG-0585, "TMI Lessons Learned Task Force Final Report," October 1979.

NUREG/CR-1156, "Environmental Assessment of Ionization Chamber Smoke Detectors Containing Am-241," November 1979.

NUREG/CR-0833, "Fire Protection Research Program Corner Effects Tests," December 1979.

NUREG-0654, "Criteria for Preparation and Evaluation of Radiological Emergency Response Plans and Preparedness in Support of Nuclear Power Plants," Interim Report, January 1980.

NUREG/CR-1405, "NACOM Code for Analysis of Postulated Sodium Spray Fires in LMFBRs," March 1980.

NUREG/CR-1798, "Acceptance and Verification for Early Warning Fire Detection Systems," Interim Guide, May 1980.

NUREG/CR-1184, "Evaluation of Simulator Adequacy for the Radiation Qualification of Safety-Related Equipment," May 1980.

NUREG/CR-2269, "Probabilistic Models for the Behavior of Compartment Fires," August 1980.

NUREG/CR-1552, "Development and Verification of Fire Tests for Cable Systems and System Components," September 1980.

NUREG/CR-1614, "Approaches to Acceptable Risk: A Critical Guide," September 1980.

NUREG/CR-1819, "Development and Testing of a Model for Fire Potential in Nuclear Power Plants," November 1980.

NUREG/CR-1741, "Models for the Estimation of Incapacitation Times Following Exposures to Toxic Gases or Vapors," December 1980.

NUREG-0492, "Fault Tree Handbook," January 1981.

NUREG/CR-1682, "Electrical Insulators in a Reactor Accident Environment," January 1981.

NUREG/CR-1930, "Index of Risk Exposure and Risk Acceptance Criteria," February 1981.

NUREG/CR-1916, "A Risk Comparison," February 1981.

NUREG/CR-1748, "Hazards to Nuclear Power Plants from Nearby Accidents Involving Hazardous Materials-A Preliminary Assessment," April 1981.

NUREG/CP-0018, Proceedings of the Workshop on Frameworks for Developing a Safety Goal, Palo Alto, California, April 1-3, 1981.

NUREG/CR-2079, "Analysis of Credible Accidents for Argonaut Reactors, Report for October 1980-April 1981," April 1981.

NUREG/CR-2040, "Study of the Implications of Applying Quantitative Risk Criteria in the Licensing of Nuclear Power Plants in the United States," May 1981.

NUREG/CR-2269, "Probabilistic Models for the Behavior of Compartment Fires," August 1981.

NUREG/CR-2017-Volume IV of IV, "Halon Inerting as a Hydrogen Control Measure for Sequoyah," Proceedings of the Workshop on the Impact of Hydrogen on Water Reactor Safety, Edited by M. Berman, September 1981.

NUREG/CR-2258, "Fire Risk Analysis for Nuclear Power Plants," September 1981.

NUREG/CR-2017-Volume 3, "Flammability Limits and Pressure Development in Hydrogen-Air Mixtures," Proceedings of the Workshop on the Impact of Hydrogen on Water Reactor Safety, September 1981.

NUREG/CR-2017-Volume 4, "Halon 1301 Protection System for Nuclear Containment," Proceedings of the Workshop on the Impact of Hydrogen on Water Reactor Safety, September 1981.

NUREG/CR-2321, "Investigation of Fire Stop Test Parameters," Final Report, September 1981.

NUREG/CR-2377, "Tests and Criteria for Fire Protection of Cable Penetrations," October 1981.

NUREG/CR-2490, "Hazards to Nuclear Power Plants From Large Liquefied Natural Gas (LNG) Spills on Water," November 1981.

NUREG/CR-2431, "Burn Mode Analysis of Horizontal Cable Tray Fires," February 1982.

NUREG/CR-2486, "Final Results of the Hydrogen Igniter Experimental Program," February 1982.

NUREG/CR-3214, "Aging with Respect to Flammability and Other Properties in Fire-Retarded Ethylene Propylene Rubber and Chlorosulfonated Polyethylene," March 1982.

NUREG/CR-2409, "Requirements for Establishing Detector Siting Criteria in Fires Involving Electrical Materials," July 1982.

NUREG/CR-2868, "Aging Effects on Fire-Retardant Additives in Organic Materials for Nuclear Plant Applications," August 1982.

NUREG/CR-2730, "Hydrogen Burn Survival: Preliminary Thermal Model and Test Results," August 1982.

NUREG/CR-2927, "Nuclear Power Plant Electrical Cable Damageability Experiments," October 1982.

NUREG/CR-2650, "Allowable Shipment Frequencies for the Transport of Toxic Gases Near Nuclear Power Plants," October 1982.

NUREG/CR-2859, "Evaluation of Aircraft Crash Hazards for Nuclear Power Plants," 1982.

NUREG/CR-2300, "PRA Procedures Guide - A Guide to the Performance of Probabilistic Risk Assessments for Nuclear Power Plants," Volume 1 and 2 January 1983.

NUREG/CR-2607, "Fire Protection Research Program for the U.S. Nuclear Regulatory Commission 1975-1981," April 1983.

NUREG/CR-3239, "COMPBRN-A Computer Code for Modeling Compartment Fires," May 1983.

NUREG/CR-2475, "Hydrogen Combustion Characteristics Related to Reactor Accidents," July 1983.

NUREG/CR-2658, "Characteristics of Combustion Products: A Review of the Literature," July 1983.

NUREG/CR-3385, "Measures of Risk Importance and Their Application," July 1983.

NUREG/CR-3122, "Potentially Damaging Failure Modes of High-and Medium-Voltage Electrical Equipment," July 1983.

NUREG/CR-3330, "Vulnerability of Nuclear Power Plant Structures to Large External Fires," August 1983.

NUREG/CR-2726, "Light Water Reactor Hydrogen Manual," August 1983.

NUREG/CR-2462, "Capacity of Nuclear Power Plant Structure to Resist Blast Loading," September 1983.

NUREG/CR-3192, "Investigation of Twenty-Foot Separation Distance as a Fire Protection Method as Specified in 10 CFR 50, Appendix R," October 1983.

NUREG/CR-3242, "Los Alamos National Laboratory/New Mexico State University Filter Plugging Test Facility: Description and Preliminary Test Results" October 1983.

NUREG/CR-3527, "Material Transport Analysis for Accident-Induced Flow In Nuclear Facilities," October 1983.

NUREG/CR-3541, "Measures of the Risk Impacts of Testing and Maintenance Activities," November 1983.

NUREG/CR-3527, "Material Transport Analysis for Accident-Induced Flow in Nuclear Facilities," December 1983.

NUREG/CR-3548, "Hazardous Materials Accidents Near Nuclear Power Plants: An Evaluation of Analyses and Approaches," 1983.

NUREG/CR-2462, "Capacity of Nuclear Power Plant Structures to Resist Blast Loading," 1983.

NUREG/BR-0075, "NRC Field Policy Manual," January 1984.

NUREG-0800, "Standard Review Plan for the Review of Safety Analysis Reports for Nuclear Power Plants, April 1984.

NUREG/CR-3735, "Accident-Induced Flow and Material Transport in Nuclear Facilities: A Literature Review," April 1984.

NUREG/CR-3139, "Scenarios and Analytical Methods for UF Releases at NRC-licensed Fuel Cycle Facilities," June 1984.

NUREG-0675, Supplement 23, "Safety Evaluation Report Related to the Operation of Diablo Canyon Nuclear Power Plant, Units 1 and 2," June 1984.

NUREG-0681, Supplement 4, "Safety Evaluation Report Related to the Operation of South Texas Project, Unit 1 and 2," July 1984.

NUREG/CR-3493, "Review of the Limerick Generating Station Severe Accident Risk Assessment - Review of Core-Melt Frequency," July 1984.

NUREG/CR-3521, "Hydrogen-Burn Survival Experiments at Fully Instrumented Test Site (FITS)," August 1984.

NUREG/CR-3719, "Detonation Calculations Using a Modified Version of CSQII: Examples for Hydrogen-Air Mixtures," August 1984.

NUREG/CR-3922, "Survey and Evaluation of System Interaction Events and Sources," Appendices A and B, Volume 1, January 1985.

NUREG/CR-3922, "Survey and Evaluation of System Interaction Events and Sources," Appendices C and D, Volume 2, January 1985.

NUREG/CR-4479, "Use of a Field Model to Assess Fire Behavior in Complex Nuclear Power Plant Enclosures: Present Capabilities and Future Prospects," January 1985.

NUREG/CR-4112-Volume 1, "Investigation of Cable and Cable System Fire Test Parameters, Volume 1, Task A: IEEE 383 Flame Test," January 1985.

NUREG/CR-4112-Volume 2, "Investigation of Cable and Cable System Fire Test Parameters, Volume 2, Task B: Firestop Test Method," January 1985.

NUREG/CR-3638, "Hydrogen-Steam Jet-Flame Facility and Experiments," February 1985.

NUREG/CR-4230, "Probability-Based Evaluation of Selected Fire Protection Features in Nuclear Power Plants," May 1985.

NUREG/CR-4264, "Investigation of High-efficiency Particulate Air Filter Plugging by Combustion Aerosols," May 1985.

NUREG/CR-4231, "Evaluation of Available Data for Probabilistic Risk Assessments (PRA) of Fire Events at Nuclear Power Plants," May 1985.

NUREG/CR-4229, "Evaluation of Current Methodology Employed in Probabilistic Risk Assessment (PRA) of Fire Events at Nuclear Power Plants," May 1985.

NUREG-1148, "Nuclear Power Plant Fire Protection Research Program," July 1985.

NUREG/CR-4321, "Full-scale Measurements of Smoke Transport and Deposition in Ventilation System Ductwork, July 1985.

NUREG/CR-2815, "Probabilistic Safety Assessment Procedures Guide," August 1985.

BNL-NUREG-36946, "Use of a Field Model to Analyze Probable Fire Environments Encountered Within the Complex Geometries of Nuclear Power Plants," August 1985.

BNL-NUREG-36873, "Probabilistic Analysis of Fires in Nuclear Plants," 1985.

NUREG/CR-4310, "Investigation of Potential Fire-Related Damage to Safety-Related Equipment in Nuclear Power Plants," November 1985.

NUREG/CR-4138, "Data Analysis for Nevada Test Site (NTS) Premixed Combustion Tests," May, 1985.

NUREG/CR-4136, "SMOKE: A Data Reduction Package for Analysis of Combustion Experiments," September 1985.

NUREG/CR-4561, "FIRAC User's Manual: A Computer Code to Simulate Fire Accidents in Nuclear Facilities," April 1986.

NUREG/CR-4330-Vol.1, "Review of Light Water Reactor Regulatory Requirements: Identifications of Regulatory Requirements That May Have Marginal Importance to Risk," Volume 1, April 1986.

NUREG/CR-4330-Vol.2, "Review of Light Water Reactor Regulatory Requirements: Identifications of Regulatory Requirements That May Have Marginal Importance to Risk," Volume 2, June 1986.

NUREG/CR-4596, "Screening Tests Representative Nuclear Power Plant Components Exposed to Secondary Environments Created by Fires," June 1986.

NUREG/CR-4570, "Description and Testing of an Apparatus for Electrically Initiating Fires Through Simulation of a Faulty Connection," June 1986.

NUREG/CR-4566, "COMPBRN III - A Computer Code for Modeling Compartment Fires," July 1986.

NUREG/CR-4586, "User Guide for a Personnel-Computer-Based Nuclear Power Plant Fire Data Base," August 1986.

NUREG/CR-4638/1of 2, "Transient Fire Environment Cable Damageability Test Results: Phase I," September 1986.

NUREG/CR-3656, "Evaluation of Suppression Methods for Electrical Cables Fires," October, 1986.

NUREG/CR-4680, "Heat and Mass Release for Some Transient Fuel Sources Fires: A Test Report," October 1986.

NUREG/CR-3468, "Hydrogen-Air-Steam Flammability Limits and Combustion Characteristics in the FITS Vessel," December 1986.

BNL-NUREG-38839, "Fire Environment Determination in the LaSalle NPP Control Room," 1986.

NUREG/CR-4905, "Detonability of H₂-Air-Diluent Mixtures," 1986.

NUREG-1250, "Report on the Accident at the Chernobyl Nuclear Power Station," January 1987.

NUREG/CR-4679, "Quantitative Data on the Fire Behavior of Combustible Materials Found in Nuclear Power Plants: A Literature Review," February 1987.

NUREG/CR-4829, "Shipping Container Response to Severe Highway and Railway Accident Condition," February 1987.

NUREG/CR-4681, "Enclosure Environment Characterization Testing for Base Line Validation of Computer Fire Simulation Codes," March 1987.

NUREG/CR-4736, "Combustion Aerosols Formed During Burning of Radioactively Contaminated Materials, Experimental Results," March 1987.

NUREG/CR-4830, "MELCOR 1.0 and HECTR 1.5 Calculations for Browns Ferry Reactor Building Burns, MELCOR Validation and Verification: 1986 Papers," March 1987.

NUREG/CR-4527/1 of 2, "An Experimental Investigation of Internally Ignited Fires in Nuclear Power Plant Control Cabinets: Part 1: Cabinet Effects Tests," April 1987.

NUREG/CR-4330-Vol.3, "Review of Light Water Reactor Regulatory Requirements: Identifications of Regulatory Requirements That May Have Marginal Importance to Risk: Post-Accident Sampling System, Turbine Missiles, Combustible Gas Control, Filters," Volume 3, May 1987.

NUREG/CR-4517, "An Aging Assessment of Relays and Circuits Breakers and System Interactions," June 1987.

NUREG/CR-4855, "Development and Application of a Computer Model for Large-Scale Flame Acceleration Experiments," July 1987.

NUREG/CR-4534, "Analysis of Diffusion Flame Tests," August 1987.

NUREG/CR-5037, "Fire Environment Determination in the LaSalle Nuclear Power Plant Control Room," October 1987.

NUREG/CR-5042, "Evaluation of External Hazards to Nuclear Power Plants in the United States," December 1987.

NUREG-1250, Rev. 1, "Report on the Accident at the Chernobyl Nuclear Power Station," Prepared by, the U.S. Department of Energy, Electric Power Research Institute, U.S. Environmental Protection Agency, Federal Emergency Management Agency, Institute of Nuclear Power Operation, and the U.S. Nuclear Regulatory Commission, December 1987.

NUREG/CR-4763, "Safety-Related Equipment Survival in Hydrogen Burns in Large Dry PWR Containment Buildings," March 1988.

NUREG/CR-2331, "Safety Research Programs Sponsored by Office of Nuclear Regulatory Research," Volume 7, No. 2 and 3, June 1988.

NUREG/CR-5233, "Computer Code for Fire Protection and Risk Analysis of Nuclear Plants," September 1988.

NUREG/CP-0097, "The Effects of Aging on the Fire Vulnerability of Nuclear Power Plant Component," Proceedings of the 16th Water Reactor Safety Meeting, October 1988.

NUREG/CR-4527, Volume 2, "An Experimental Investigation of Internally Ignited Fires in Nuclear Power Plant Control Cabinets: Part II: Room Effects Tests," November, 1988.

NUREG/CR-5088, "Fire Risk Scoping Study: Investigation of Nuclear Power Plant Fire Risk, Including Previously Unaddressed Issues," December 1988.

NUREG/CR-5088, "Fire Risk Scoping Study: Investigation of Nuclear Power Plant Fire Risk, Including Previously Unaddressed Issues," January 1989.

NUREG/CR-5042, Supplement 2, "Evaluation of External Hazards to Nuclear Power Plants in the United States: Other External Events," , February 1989.

NUREG/CR-3037, "A Computer Code to Estimate Accidental Fire and Radioactive Airborne Releases in Nuclear Fuel Cycle Facilities," User's Manual for FIRIN, February 1989.

NUREG/CR-5281, "Value/Impact Analyses of Accident Preventive and Mitigative Options for Spent Fuel Pools," March 1989.

NUREG/CR-1251, Vol. 1, "Implications of the Accident at Chernobyl for Safety Regulation of Commercial Nuclear Power Plants in the United States," Volume 1, Main report: Final report. April 1989.

NUREG/CR-1251, Vol. 2, "Implications of the Accident at Chernobyl for Safety Regulation of Commercial Nuclear Power Plants in the United Sates," Volume 2, Appendix - Public Comments and their Disposition: Final Report, April 1989.

NUREG-1335, "Individual Plant Examination: Submittal Guidance," Final Report, Office of Nuclear Regulatory Research, and Office of Nuclear Reactor Regulation, August 1989.

NUREG/CR-5079, "Experimental Results Pertaining to the Performance of Thermal Igniters," October 1989.

NUREG/CR-5457, "Review of the Three Mile Island-1 Probabilistic Risk Assessment," November 1989.

NUREG/CR-5384, "A Summary of Nuclear Power Plant Fire Safety Research at Sandia National Laboratories,1975-1987," December 1989.

NUREG/CR-5275, "FLAME Facility: The Effect of Obstacles and Transverse Venting on Flame Acceleration and Transition to Detonation for Hydrogen/Air Mixture at Large Scale," 1989.

NUREG/CR-5464, "An Identification and Initial Assessment of Potential Fire Safety Issues Associated with Plant Aging," April 1990.

NUREG-1409, "Backfitting Guidelines," July, 1990.

NUREG-1150, Volume 1, "Severe Accident Risks: An Assessment for Five U.S. Nuclear Power Plants," December 1990.

NUREG/CR-4550, "Analysis of Core Damage Frequency: Peach Bottom Unit 2 External Events," December 1990.

NUREG/CR-4840, "Procedures for the External Event Core Damage Frequency Analyses for NUREG-1150," December 1990.

NUREG/CR-5619, "The Impact of Thermal Aging on the Flammability of Electric Cables," March 1991.

NUREG/CR-5546, "An Investigation of the Effects of Thermal Aging on the Fire Damageability of Electric Cables," May 1991.

NUREG/CR-5655, "Submergence and High Temperature Steam Testing of Class 1E Electrical Cables," May 1991.

NUREG-1407, "Procedural and Submittal Guidance for the Individual Plant Examination of External Events (IPEEE) for Severe Accident Vulnerabilities Study," June 1991.

NUREG/CR-5525, "Hydrogen-Air-Diluent Detonation Study for Reactor Safety Analyses," 1991.

NUREG/CR-5669, "Evaluation of Exposure Limits to Toxic Gases for Nuclear Reactor Control Room Operations," July 1991.

NUREG-1422, "Summary of Chernobyl Followup Research Activities," U.S. Nuclear Regulatory Commission, Division of Safety Issue Resolution, June 1992.

NUREG/CR-4839, "Methods for External Event Screening Quantification: Risk Methods Integration and Evaluation Program (RMIEP) Methods Development, July 1992.

NUREG/CR-4832, "Analysis of the LaSalle Unit 2 Nuclear Power Plant: Risk Methods Integration and Evaluation Program (RMIEP)," July 1992.

NUREG/CR-5790, "Risk Evaluation for a Babcock & Wilcox Pressurized Water Reactor, Effects of Fire Protection System Actuation on Safety-Related Equipment: Evaluation of Generic Issue 57," September 1992.

NUREG/CR-4832-Volume 4, "Analysis of the LaSalle Unit 2 Nuclear Power Plant: Risk Methods Integration and Evaluation Program (RMIEP). Initiating Events and Accident Sequence Delineation," October 1992.

NUREG/CR-5580, "Evaluation of Generic Issue 57: Effects of Fire Protection System Actuation on Safety-Related Equipment," (Vol.1, 2, 3, 4, and 5), December 1992 .

NUREG/CR-5789, "Risk Evaluation for a Westinghouse PWR, Effects of Fire Protection System Actuation on Safety-Related Equipment: Evaluation of Generic Issue 57," December 1992.

NUREG/CR-5791, "Risk Evaluation for a General Electric BWR, Effects of Fire Protection System Actuation on Safety-Related Equipment: Evaluation of Generic Issue 57," December 1992.

NUREG/CR-4832, "Analysis of the LaSalle Unit 2 Nuclear Power Plant: Risk Methods Integration and Evaluation Program (RMIEP), Volume 9 , Internal Fire Analysis," March 1993.

NUREG/CP-0129, Proceedings of the Workshop on Program for Elimination of Requirements Marginal to Safety, Bethesda, Maryland, April 27-28, 1993.

NUREG-1364, "Resolution Regulatory Analysis For the Resolution of Generic Safety Issue 106: Piping and the Use of Highly Combustible Gases in Vital Areas," June 1993.

NUREG/CP-0130-Vol.2, "Development of a Personal Computer Code for Fire Protection Analysis of DOE Facility Air-cleaning Systems," Proceedings of the 22nd DOE/NRC Nuclear Air Cleaning Conference, July 1993.

NUREG-1472, "Regulatory Analysis for the Resolution of Generic Issue 57: Effects of Fire Protection System Actuation on Safety-Related Equipment," October 1993.

BNL-NURG-49137, "Fire Protection of Safe Shutdown Capability at Commercial Nuclear Power Plants," 1993.

NUREG/CR-6103, "Prioritization of Reactor Control Components Susceptible to Fire Damage as a Consequence of Aging," January 1994.

NUREG/CR-5904, "Functional Issues and Environmental Qualification of Digital Protection Systems of Advanced Light-Water Nuclear Reactors," April 1994.

NUREG/CR-6095, "Aging, Loss-of-Coolant Accident (LOCA, and High Potential Testing of Damaged Cables)," April 1994.

NUREG/CR-6143-Volume 3, "Evaluation of Potential Severe Accidents During Low Power and Shutdown Operations at Grand Gulf, Unit 1: Analysis of Core Damage Frequency from Internal Fire Events for Plant Operational State 5 During a Refueling Outage, July 1994," 1994.

NUREG/CR-6144-Volume 3-Pt.2, "Evaluation of Potential Severe Accidents During Low Power and Shutdown Operations at Surry, Unit 1: Analysis of Core Damage Frequency from Internal Fires During Mid-Loop Operations," Volume 3, Part 2: Appendices, July 1994.

NUREG/CR-6213, "High Temperature Hydrogen+Air+Steam Detonation Experiments in the BNL Small Scale Development Apparatus," August 1994.

NUREG/CR-6220, "An Assessment of Fire Vulnerability for Aged Electrical Relays," March 1995.

NUREG/CR-6017, "Fire Modeling of the Heiss Dampf Reaktor Containment," September 1995.

NUREG/CR-6358-Vol. 2, "Assessment of United States Industry Structural Codes and Standards for Application to Advanced Nuclear Power Reactors," Appendices, Volume 2, October 1995.

NUREG/CP-0148, "Preliminary Studies on the Impact of Smoke on Digital Equipment," Transactions of the 23rd Water Reactor Safety Information Meeting, Bethesda, Maryland, October 1995.

NUREG/CR-6173, "A Summary of the Fire Testing Program at the German HDR Test Facility," November 1995.

NUREG/CR-6384, "Literature Review of Environmental Qualification of Safety Related Electric Cables," Volume 1, April 1996.

NUREG-1552, "Fire Barrier Penetration Seals in Nuclear Power Plants," July 1996.

NUREG-1547, "Methodology for Developing and Implementing Alternative Time-Temperature Curves for Testing the Fire Resistance of Barriers for Nuclear Power Plant Applications," August 1996.

NUREG/CR-5973, "Codes and Standards and Other Guidance Cited in Regulatory Documents," August 1996.

NUREG/CR-6406, "Environmental Testing of an Experimental Digital Safety Channel," September 1996.

NUREG/CR-6476, "Circuit Bridging of Components by Smoke," October 1996.

NUREG/CR-6530, "Deliberate Ignition of Hydrogen-Air-Steam Mixtures in Condensing Steam Environments," May 1997.

NUREG-1601, "Chemical Process Safety at Fuel Cycle Facilities," August 1997.

NUREG/CP-0153, "Potential for HEPA Filter Damage From Water Spray Systems in Filter Plenums," Proceedings of the 24th DOE/NRC Nuclear Air Cleaning and Treatment Conference, August 1997, pp. 752-777.

NUREG-1611, "Aging Management of Nuclear Power Plant Containment for License Renewal, Office of Nuclear Reactor Regulation, September 1997.

NUREG/CP-0161, "A Recent Results of an Experimental Study on the Impact on Digital I&C Equipments," Transactions of the 25th Water Reactor Safety Information Meeting, Bethesda, Maryland, October 20-22, 1997.

NUREG/CR-6543, "Effects of Smoke on Functional Circuits," October 1997.

NUREG/CR-6479, "Technical Basis for Environmental Qualification of Microprocessor-Based Safety-related Equipment in Nuclear Power Plants," January 1998.

NUREG/CR-6410, "Nuclear Fuel Cycle Facility Accident Analysis Handbook," March 1998.

NUREG/CR-6544, "Methodology for Analyzing Precursors to Earthquake-Initiated and Fire-Initiated Accident Sequences," April 1998.

NUREG/CR-6509, "The Effect of Initial Temperature on Flame Acceleration and Deflagration-to-Detonation Transition Phenomenon," May 1998.

NUREG-1521, "Technical Review of Risk-Informed, Performance-Based Methods for Nuclear Power Plant Fire Protection Analyses," Draft Report for Public Comments, Division of Risk Analysis and Applications, Office of Nuclear Regulatory Research, July 1998.

NUREG/CR-6524, "The Effect of Lateral Venting on DDT in Hydrogen-Air-Steam Mixtures at Various Temperature," 1998.

NUREG-1552, Supplement 1, "Fire Barrier Penetration Seals in Nuclear Power Plants," January 1999.

NUREG-0933, "A Prioritization of Generic Safety Issues," April 1999.

BNL-NUREG-66831, "Fire Safety in Nuclear Power Plants: A Risk-Informed and Performance-Based Approach," November 1999.

NUREG/CP-0170, "International Collaborative Project to Evaluate Fire Models for Nuclear Power Plant Applications: Summary of Planning Meeting," Held at University of Maryland College Park, Maryland, October 25-26, 1999, Office of Nuclear Regulatory Research, U.S. Nuclear Regulatory Commission, Washington, DC, March 2000.

NUREG-1649, Revision 3, "Reactor Oversight Process," July 2000.

NUREG/CR-6681, "Ampacity Derating and Cable Functionality for Raceway Fire Barriers," August 2000.

NUREG-1738, "Technical Study of Spent Fuel Pool Accident Risk at Decommissioning Nuclear Power Plants, January 2001.

NUREG/CR-6597, "Results and Insights on the Impact of Smoke on Digital Instrumentation and Control," January 2001.

NUREG/CP-0173, "International Collaborative Project to Evaluate Fire Models for Nuclear Power Plant Applications: Summary of 2nd Meeting," Held at Institute for Protection and Nuclear Safety, Fontenay-aux-Roses, France, June 19–20, 2000, Office of Nuclear Regulatory Research, U.S. Nuclear Regulatory Commission, Washington, DC, March 2001.

NUREG-1800, "Standard Review Plan for Review of License Renewal Applications for Nuclear Power Plants," July 2001.

NUREG-1801, Volume 1, "Generic Aging Lessons Learned (GALL) Report—Summary," July 2001.

NUREG-1801, Volume 2, "Generic Aging Lessons Learned (GALL) Report—Tabulation of Results," July 2001.

NUREG/CR-6738, "Risk Methods Insights Gained From Fire Incidents," September 2001.

NUREG/CR-6752, "A Comparative Analysis of Special Requirements for Systems, Structures, and Components (SSCs) of Nuclear Power Plants With Commercial Requirements of Non-Nuclear Power Plants," January 2002.

NUREG/CR-6042, Rev. 2, "Perspective on Reactor Safety," March 2002.

NUREG-1753, "Risk-Based Performance Indicators: Results of Phase 1 Development," April 2002.

NEREG-1742, Volume 1, Final Report, "Perspectives Gained from Individual Plant Examination of External Events (IPEEE) Program," Division of Risk Analysis and Applications, Office of Nuclear Regulatory Research, U.S. Nuclear Regulatory Commission, Washington, DC, April 2002.

NEREG-1742, Volume 2, Final Reports Tables, "Perspectives Gained from Individual Plant Examination of External Events (IPEEE) Program," Division of Risk Analysis and Applications, Office of Nuclear Regulatory Research, U.S. Nuclear Regulatory Commission, Washington, DC, April 2002.

NUREG-1758, "Evaluation of Fire Models for Nuclear Power Plant Applications: Cable Tray Fires, International Panel," Office of Nuclear Regulatory Research, U.S. Nuclear Regulatory Commission, Washington, DC, June 2002.

NUREG/CR-6776, "Cable Insulation Resistance Measurements Made During Cable Fire Tests," June 2002.

NUREG/CR-6788, "Evaluation of Aging and Qualification Practices for Cable Splices Used in Nuclear Power Plants," September 2002.

NUREG/CP-0179, "Proceedings of the International Conference on Wire System Aging, November 2002.

NUREG/CR-6797, "Guidance for Post-Fire Safe Shutdown Analysis Including Risk Insights," Draft Report for Public Comments, Office of Nuclear Reactor Regulation, December 16, 2002.

NUREG/CR-6799, Revision 1, "Analysis of Rail Car Components Exposed to a Tunnel Fire Environment," March 2003.

D.10 Safety Evaluation Reports Related to License Renewal for Operating Nuclear Power Plants

NUREG-1705, "Safety Evaluation Report Related to the License Renewal of Calvert Cliffs Nuclear Power Plant, Units 1 and 2," December 1999.

NUREG-1723, "Safety Evaluation Report Related to the License Renewal of Oconee Nuclear Station, Units 1, 2, and 3," March 2000.

NUREG-1743, "Safety Evaluation Report Related to the License Renewal of Arkansas Nuclear One, Unit 1," May 2001.

NUREG-1803, "Safety Evaluation Report Related to the License Renewal of Edwin I. Hatch Nuclear Plant, Units 1 and 2," December 2001.

NUREG-1759, "Safety Evaluation Report Related to the License Renewal of Turkey Point Nuclear Plant, Units 3 and 4," April 2002.

NUREG-1766, "Safety Evaluation Report Related to the License Renewal of North Ann Power Station, Units 1 and 2, and Surry Power Station, Units 1 and 2," December 2002.

NUREG-1772, "Safety Evaluation Report Related to the License Renewal of McGuire Nuclear Station, Units 1 and 2, and Catawba Nuclear Station, Units 1 and 2, March 2003.

NUREG-1769, "Safety Evaluation Report Related to the License Renewal of Peach Bottom Atomic Power Station, Units 2 and 3," March 2003.

This page intentionally left blank.

D.11 National Fire Protection Association (NFPA) Codes and Standards for Nuclear Facilities

- (1) NFPA 801, "Standard for Fire Protection for Facilities Handling Radioactive Materials," 1998 Edition, National Fire Protection Association, Quincy, Massachusetts.**
- (2) NFPA 804, "Standard for Fire Protection for Advanced Light Water Reactor Electric Generating Plants," 2001 Edition, National Fire Protection Association, Quincy, Massachusetts.**
- (3) NFPA 805, "Performance-Based Standard for Fire Protection for Light Water Reactor Electric Generating Plants," 2001 Edition, National Fire Protection Association, Quincy, Massachusetts.**

This page intentionally left blank.

APPENDIX E. CURRENT NATIONAL FIRE PROTECTION ASSOCIATION (NFPA) CODES AND STANDARDS

NFPA develops, publishes, and disseminates timely consensus codes and standards intended to minimize the possibility and effects of fire and other risks. Virtually every building, process, service, design, and installation in society today is affected by NFPA documents. More than 300 NFPA codes and standards are used around the world. This series is referred to as the National Fire Codes (NFC).

NFPA codes and standards have great influence because they are widely used as a basis of legislation and regulation at all levels of government, from local to international. Several NFPA codes have received worldwide recognition, such as the *Life Safety Code®*, the *National Electrical Code®*, and the *National Fuel Gas Code*. Many codes are referenced by Federal Government agencies, such as the regulations of the U.S. Nuclear Regulatory Commission (NRC), General Services Administration (GSA), and U.S. Occupational Safety and Health Administration (OSHA). The documents are also used by insurance authorities for risk evaluation and premium rating and as references in designs and specifications. Table E-1 provides titles of all current NFPA codes, standards, and recommended practices. It is important to recognize that the NFPA codes and standards are constantly revised and updated on 3 to 5 year cycles. The code or standard in effect at the time of design or implementation is the code of record (COR) for that application.

This page intentionally left blank.

APPENDIX E. CURRENT NATIONAL FIRE PROTECTION ASSOCIATION (NFPA) CODES AND STANDARDS

| Table E-1. NFPA Codes and Standards | | |
|--|--|----------------|
| NFPA | Title | Edition |
| 1 | Uniform Fire Code™ | 2003 |
| 10 | Standard for Portable Fire Extinguishers | 2002 |
| 11 | Standard for Low-Expansion Foam | 2002 |
| 11A | Standard for Medium-and High-Expansion Foam Systems | 1999 |
| 12 | Standard on Carbon Dioxide Extinguishing Systems | 2000 |
| 12A | Standard on Halon 1301 Fire Extinguishing Systems | 1997 |
| 13 | Standard for Installation of Sprinkler Systems | 2002 |
| 13D | Standard for Installation of Sprinkler Systems in One-and Two1-Family Dwellings and Manufactured Homes | 2002 |
| 13E | Recommended Practice for Fire Department Operations in Properties Protected by Sprinkler and Standpipe Systems | 2000 |
| 13R | Standard for the Installation of Sprinkler Systems in Residential Occupancies up to and Including Four Stories in Height | 2002 |
| 14 | Standard for the Installation of Standpipe and Hose Systems | 2003 |
| 15 | Standard for Water Spray Fixed Systems for Fire Protection | 2001 |
| 16 | Standard for the Installation of Foam-Water Sprinkler and Foam-Water Spray Systems | 2003 |
| 17 | Standard for Dry Chemical Extinguishing System | 2002 |
| 17A | Standard for Wet Chemical Extinguishing Systems | 2002 |
| 18 | Standard on Wetting Agents | 1995 |
| 20 | Standard for the Installation of Stationary Pumps for Fire Protection | 1999 |
| 22 | Standard for Water Tanks for Private Fire Protection | 2003 |
| 24 | Standard for the Installation of Private Fire Service Mains and Their Appurtenances | 2002 |
| 25 | Standard for the Inspection, Testing, and Maintenance of Water-Based Fire Protection System | 2002 |
| 30 | Flammable and Combustible Liquids Code | 2000 |

Table E-1. NFPA Codes and Standards (continued)

| NFPA | Title | Edition |
|-------------|--|----------------|
| 22 | Standard for Water Tanks for Private Fire Protection | 2003 |
| 24 | Standard for the Installation of Private Fire Service Mains and Their Appurtenances | 2002 |
| 25 | Standard for the Inspection, Testing, and Maintenance of Water-Based Fire Protection Systems | 2002 |
| 30 | Flammable and Combustible Liquids Code | 2000 |
| 30A | Code for Motor Fuel Dispensing Facilities and Repair Garages | 2000 |
| 30B | Code for the Manufacturer and Storage of Aerosol Products | 2002 |
| 31 | Standard for the Installation of Oil-Burning Equipment | 2001 |
| 32 | Standard for the Drycleaning Plants | 2000 |
| 33 | Standard for Spray Application Using Flammable or Combustible Materials | 2000 |
| 34 | Standard for Dipping and Coating Processes Using Flammable or Combustible Liquids | 2000 |
| 35 | Standard for the Manufacturer of Organic Coatings | 1999 |
| 36 | Standard for Solvent Extraction Plants | 2001 |
| 37 | Standard for the Installation and Use of Stationary Combustion Engines and Gas Turbines | 2002 |
| 40 | Standard for the Storage and Handling of Cellulose Nitrate Motion Picture Film | 2001 |
| 42 | Code for the Storage of Pyroxylin Plastic | 2002 |
| 45 | Standard on Fire Protection for Laboratories Using Chemicals | 2000 |
| 50 | Standard for Bulk Oxygen Systems at Consumer Sites | 2001 |
| 50A | Standard for Gaseous Hydrogen Systems at Consumer Sites | 1999 |
| 50B | Standard for Liquefied Hydrogen Systems at Consumer Sites | 1999 |
| 51 | Standard for the Design and Installation of Oxygen-Fuel Gas Systems for Welding, Cutting, and Allied Processes | 2002 |
| 51A | Standard for Acetylene Cylinder Charging Plants | 2001 |

Table E-1. NFPA Codes and Standards (continued)

| NFPA | Title | Edition |
|-------------|---|----------------|
| 51B | Standard for Fire Prevention During Welding, Cutting, and Other Hot Work | 1999 |
| 52 | Compressed Nature Gas (CNG) Vehicular Fuel Systems Code | 2002 |
| 53 | Recommended Practice on Materials, Equipment, and Systems Used in Oxygen-Enriched Atmospheres | 1999 |
| 54 | National Fuel Code | 2002 |
| 55 | Standard for the Storage, Use, and Handling of Compressed Gases and Cryogenic Fluids in Portable and Stationary Containers, Cylinders, and Tanks | 2003 |
| 57 | Liquefied Petroleum Gas (LNG) Vehicular Fuel Systems Code | 2002 |
| 58 | Liquefied Petroleum Gas Code | 2001 |
| 59 | Utility LP-Plant Code | 2001 |
| 59A | Standard for the Protection, Storage, and Handling of Liquefied Natural Gases (LNG) | 2001 |
| 61 | Standard for the Prevention of Fires and Dust Explosions in Agriculture and Food Products Facilities | 2002 |
| 68 | Guide for Venting of Deflagrations | 2002 |
| 69 | Standard on Explosion Prevention Systems | 1997 |
| 70 | National Electrical Code® | 2002 |
| 70B | Recommended Practice for Electrical Equipment Maintenance | 2002 |
| 70E | Standard for Electrical Safety Requirements for Employee Workshops | 2000 |
| 72 | National Fire Alarm Code® | 2002 |
| 73 | Electrical Inspection Code for Existing Dwellings | 2000 |
| 75 | Standard for the Protection of Information Technology Equipment | 2003 |
| 76 | Recommended Practice for the Fire Protection of Telecommunications Facilities | 2002 |
| 77 | Recommended Practice on Static Electricity | 2000 |
| 79 | Electrical Standard for Industrial Machinery | 2002 |

Table E-1. NFPA Codes and Standards (continued)

| NFPA | Title | Edition |
|------------------|---|----------------|
| 80 | Standard for Fire Doors and Fire Windows | 1999 |
| 80A | Recommended Practice for Protection of Building from Exterior Fire Exposures | 2001 |
| 82 | Standard on Incinerators and Waste and Linen Handling Systems and Equipment | 1999 |
| 85 | Boiler and Combustion Systems Hazards Code | 2001 |
| 86 | Standard for Oven and Furnaces | 1999 |
| 86C | Standard for Industrial Furnaces Using a Special Processing and Equipment | 1999 |
| 86D | Standard for Industrial Furnaces Using Vacuum as an Atmosphere | 1999 |
| 88A | Standard for Parking Structures | 2002 |
| 88B | Standard for Repair Garages | 1997 |
| 90A | Standard for the Installation of Air-Conditioning and Ventilating Systems | 2002 |
| 90B | Standard for the Installation of Warm Air Heating and Air-Conditioning Systems | 2002 |
| 91 | Standard for Exhaust Systems for Air Conveying of Vapor, Gases, Mists, and Noncombustibles Particulate Solids | 1999 |
| 92A | Recommended Practice for Smoke-Control Systems | 2000 |
| 92B | Guide for Smoke Management Systems in Mall, Atria, and Large Areas | 2000 |
| 96 | Standard for Ventilation Control and Fire Protection of Commercial Cooking Operations | 2001 |
| 97 | Standard Glossary of Terms Relating to Chimneys, Vents, and Heat-Producing Appliances | 2003 |
| 99 | Standard for Health Care Facilities | 2002 |
| 99B | Standard for Hypobaric Facilities | 2002 |
| 101 [®] | Life Safety Code [®] | 2003 |
| 101A | Guide to Alternative Approaches to Life Safety | 2001 |
| 101B | Code for Mean of Egress for Buildings and Structures | 2002 |

Table E-1. NFPA Codes and Standards (continued)

| NFPA | Title | Edition |
|-------------|--|----------------|
| 102 | Standard for Grandstands, Folding and Telescopic Seating, Tents, and Membrane Structures | 1995 |
| 105 | Standard for the Installation of Smoke Door Assemblies | 2003 |
| 110 | Standard for Emergency and Standby Power Systems | 2002 |
| 111 | Standard on Stored Electrical Energy Emergency and Standby Power Systems | 2001 |
| 115 | Recommended Practice on Laser Fire Protection | 1999 |
| 120 | Standard for Coal Preparation Plants | 1999 |
| 121 | Standard on Fire Protection for Self-Propelled and Mobile Surface Mining Equipment | 2001 |
| 122 | Standard for Fire Prevention and Control in Underground Metal and Nonmetal Mines | 2000 |
| 123 | Standard for Fire Prevention and Control in Underground Bituminous Coal Mines | 1999 |
| 130 | Standard for Fixed Guideway Transit and Passenger Rail Systems | 2000 |
| 140 | Standard on Motion Picture and Television Production Studio Soundstages and Approved Production Facilities | 1999 |
| 150 | Standard on Fire Safety in Racetrack Stables | 2000 |
| 160 | Standard for Flame Effects Before an Audience | 2001 |
| 170 | Standard for Fire Safety Symbols | 2002 |
| 203 | Guide on Roof Coverings and Roof Deck Constructions | 2000 |
| 204 | Guide for Smoke and Heat Venting | 2002 |
| 211 | Standard for Chimneys, Fireplace, Vents, and Solid Fuel-Burning Appliances | 2003 |
| 214 | Standard on Water-Cooling Towers | 2000 |
| 220 | Standard on Types of Building Construction | 1999 |
| 221 | Standard for Fire Walls and Fire Barrier Walls | 2000 |
| 225 | Model Manufactured Home Installation Standard | 2003 |
| 230 | Standard for the Fire Protection of Storage | 2003 |

Table E-1. NFPA Codes and Standards (continued)

| NFPA | Title | Edition |
|-------------|--|----------------|
| 232 | Standard for the Protection of Records | 2000 |
| 241 | Standard for Safeguarding Construction, Alteration, and Demolition Operations | 2000 |
| 251 | Standard Methods of Tests of Fire Endurance of Building Construction and Materials | 1999 |
| 252 | Standard Methods of Fire Tests of Door Assemblies | 1999 |
| 253 | Standard Method of Test for Critical Radiant Flux of Floor Covering Systems Using a Radiant Heat Energy Source | 2000 |
| 255 | Standard Method of Test of Surface Burning Characteristics of Building Materials | 2000 |
| 256 | Standard Methods of Fire Tests of Roof Coverings | 1998 |
| 257 | Standard on Fire Test for Window and Glass Block Assemblies | 2000 |
| 258 | Recommended Practice for Determining Smoke Generation of Solid Materials | 2001 |
| 259 | Standard Test Method for Potential Heat of Building Materials | 2003 |
| 260 | Standard Methods of Tests and Classification System for Cigarette Ignition Resistance of Components of Upholstered Furniture | 1998 |
| 261 | Standard Method of Test for Determining Resistance of Mock-Up Upholstered Furniture Material Assemblies to Ignition by Smoldering Cigarettes | 1998 |
| 262 | Standard Method of Test for Flame Travel and Smoke of Wires and Cables for Use in Air-Handling Spaces | 2002 |
| 265 | Standard Methods of Fire Tests for Evaluating Room Fire Growth Contribution of Textile Wall Coverings on Full Height Panels and Walls | 2002 |
| 267 | Standard Method of Test for Fire Characteristics of Mattresses and Bedding Assemblies Exposed to Flaming Ignition Source | 1998 |
| 268 | Standard Test Method for Determining Ignitability of Exterior Wall Assemblies Using a Radiant Heat Energy Source | 2001 |
| 269 | Standard Test Method for Developing Toxic Potency Data for Use in Fire Hazard Modeling | 2000 |

| Table E-1. NFPA Codes and Standards (continued) | | |
|--|---|----------------|
| NFPA | Title | Edition |
| 270 | Standard Test Method for Measurement of Smoke Obscuration Using a Conical Radiant Source in a Single Closed Chamber | 2002 |
| 271 | Standard Method of Test for Heat and Visible Smoke Release Rates for Materials and Products Using an Oxygen Consumption Calorimeter | 2001 |
| 272 | Standard Method of Test for Heat and Visible Smoke Release Rates for Upholstered Furniture Components or Composites and Mattresses Using an Oxygen Consumption Calorimeter | 2003 |
| 285 | Standard Method of Test for the Evaluation of Flammability Characteristics of Exterior Non-Load-Bearing Wall Assemblies Containing Combustible Components Using the Intermediate-Scale, Multistory Test Apparatus | 1998 |
| 286 | Standard Methods of Fire Tests for Evaluating Contribution of Wall and Ceiling Interior Finish to Room Fire Growth | 2000 |
| 287 | Standard Test Methods for Measurement of Flammability of Materials in Cleanrooms Using a Fire Propagation Apparatus (FPA) | 2001 |
| 288 | Standard Methods of Fire Tests of Floor Fire Door Assemblies Installed Horizontally in Fire Resistance-Rated Floor Systems | 2001 |
| 291 | Recommended Practice for Fire Flow Testing and Marking of Hydrants | 2002 |
| 295 | Standard for Wildfire Control | 1998 |
| 301 | Code for Safety to Life from Fire on Merchant Vessels | 2001 |
| 302 | Fire Protection Standard for Pleasure and Commercial Motor Craft | 1998 |
| 303 | Fire Protection Standard for Marinas and Boatyards | 2000 |
| 306 | Standard for the Control of Gas Hazards on Vessels | 2001 |
| 307 | Standard for the Construction and Fire Protection of Marine Terminals, Piers, and Wharves | 2000 |
| 312 | Standard for Fire Protection of Vessels During Construction, Repair, and Lay-Up | 2000 |
| 318 | Standard for the Protection of Cleanrooms | 2000 |
| 326 | Standard for the Safeguarding of Tanks and Containers for Entry, Cleaning, or Repair | 1999 |
| 329 | Recommended Practice for Handling Releases of Flammable and Combustible Liquids and Gases | 1999 |

Table E-1. NFPA Codes and Standards (continued)

| NFPA | Title | Edition |
|-------------|---|----------------|
| 385 | Standard for Tank Vehicles for Flammable and Combustible Liquids | 2000 |
| 402 | Guide for Aircraft Rescue and Fire Fighting Operations | 2002 |
| 403 | Standard for Aircraft Rescue and Fire-Fighting Services at Airports | 1998 |
| 405 | Recommended Practice for the Recurring Proficiency Training of Aircraft Rescue and Fire-Fighting Services | 1999 |
| 407 | Standard for Aircraft Fuel Servicing | 2001 |
| 408 | Standard for Aircraft Hand Portable Fire Extinguishers | 1999 |
| 409 | Standard on Aircraft Hangars | 2001 |
| 410 | Standard on Aircraft Maintenance | 1999 |
| 412 | Standard for Evaluating Aircraft Rescue and Fire-Fighting Foam Equipment | 1998 |
| 414 | Standard for Aircraft Rescue and Fire-Fighting Vehicles | 2001 |
| 415 | Standard on Airport Terminal Buildings, Fueling Ramp Drainage, and Loading Walkways | 2002 |
| 418 | Standard for Heliports | 2001 |
| 422 | Guide for Aircraft Accident Response | 1999 |
| 423 | Standard for Construction and Protection of Aircraft Engine Test Facilities | 1999 |
| 424 | Guide for Airport/Community Emergency Planning | 2002 |
| 430 | Code for the Storage of Liquid and Solid Oxidizers | 2000 |
| 432 | Code for the Storage of Organic Peroxide Formulations | 2002 |
| 434 | Code for the Storage of Pesticides | 2002 |
| 450 | Guide for Emergency Medical Services and Systems | 2003 |
| 471 | Recommended Practice for Responding to Hazardous Materials Incidents | 2002 |
| 472 | Standard on Professional Competence of Responders to Hazardous Materials Incidents | 2002 |
| 473 | Standard for Competencies for EMS Personnel Responding to Hazardous Materials Incidents | 2002 |

Table E-1. NFPA Codes and Standards (continued)

| NFPA | Title | Edition |
|------|---|---------|
| 484 | Standard for Combustible Metals, Metal Powders, and Metal Dusts | 2002 |
| 490 | Code for the Storage of Ammonium Nitrate | 2002 |
| 495 | Explosive Materials Code | 2001 |
| 496 | Standard for Purged and Pressurized Enclosures for Electrical Equipment | 1998 |
| 497 | Recommended Practice for the Classification of Flammable Liquids, Gases, or Vapors and of Hazardous (Classified) Locations for Electrical Installations in Chemical Process Areas | 1997 |
| 498 | Standard for Safe Havens and Interchange Lots for Vehicles Transporting Explosives | 2001 |
| 499 | Recommended Practice for the Classification of Combustible Dusts and of Hazardous (Classified) Locations for Electrical Installations in Chemical Process Areas | 1997 |
| 501 | Standard on Manufactured Housing | 2003 |
| 501A | Standard for Fire Safety Criteria for Manufactured Home Installations, Sites, and Communities | 2003 |
| 502 | Standard for Road Tunnels, Bridges, and Other Limited Access Highways | 2001 |
| 505 | Fire Safety Standard for Powered Industrial Trucks Including Type Designations, Areas of Use, Conversions, Maintenance, and Operation | 2002 |
| 520 | Standard on Subterranean Spaces | 1999 |
| 550 | Guide to the Fire Safety Concepts Tree | 2002 |
| 551 | Guide for the Evaluation of Fire Risk Assessments | 2003 |
| 555 | Guide on Methods for Evaluating Potential for Room Flashover | 2000 |
| 560 | Standard for the Storage, Handling, and Use of Ethylene Oxide for Sterilization and Fumigation | 2002 |
| 600 | Standard on Industrial Fire Brigades | 2000 |
| 601 | Standard for Security Services in Fire Loss Prevention | 2000 |
| 610 | Guide for Emergency and Safety Operations at Motorsports Venues | 2003 |

Table E-1. NFPA Codes and Standards (continued)

| NFPA | Title | Edition |
|-------------|--|----------------|
| 654 | Standard for the Prevention of Fire and Dust Explosions from the Manufacturing, Processing, and Handling of Combustible Particulate Solids | 2000 |
| 655 | Standard for Prevention of Sulfur Fires and Explosions | 2001 |
| 664 | Standard for the Prevention of Fires and Explosions in Wood Processing and Woodworking Facilities | 2002 |
| 701 | Standard Methods of Fire Tests for Flame Propagation of Textiles and Films | 1999 |
| 703 | Standard for Fire Retardant Impregnated Wood and Fire Retardant Coatings for Building Materials | 2000 |
| 704 | Standard System for the Identification of the Hazards of Materials for Emergency Response | 2001 |
| 705 | Recommended Practice for a Field Flame Test for Textiles and Films | 1997 |
| 720 | Recommended Practice for the Installation of Household Carbon Monoxide (CO) Warning Equipment | 2003 |
| 730 | Premises Security Code | 2003 |
| 731 | Installation of Premises Security Equipment | 2003 |
| 750 | Standard on Water Mist Fire Protection Systems | 2003 |
| 780 | Standard for the Installation of Lightning Protection Systems | 2000 |
| 801 | Standard for Fire Protection for Facilities Handling Radioactive Materials | 2003 |
| 804 | Standard for Fire Protection for Advanced Light Water Reactor Electric Generating Plants | 2001 |
| 805 | Performance-Based Standard for Fire Protection for Light Water Reactor Electric Generating Plants | 2001 |
| 820 | Standard for Fire Protection in Wastewater Treatment and Collection Facilities | 1999 |
| 850 | Recommended Practice for Fire Protection for Electric Generating Plants and High Voltage Direct Current Converter Stations | 2000 |
| 851 | Recommended Practice for Fire Protection for Hydroelectric Generating Plants | 2000 |
| 853 | Standard for the Installation of Stationary Fuel Cell Power Plants | 2000 |

Table E-1. NFPA Codes and Standards (continued)

| NFPA | Title | Edition |
|-------------|---|----------------|
| 900 | Building Energy Code | 2003 |
| 901 | Standard Classifications for Incident Reporting and Fire Protection Data | 2001 |
| 906 | Guide for Fire Incident Field Notes | 1998 |
| 909 | Code for the Protection of Cultural Resources | 2001 |
| 914 | Code for Fire Protection of Historic Structures | 2001 |
| 921 | Guide for Fire and Explosion Investigations | 2001 |
| 1000 | Standard for Fire Service Professional Qualifications Accreditation and Certification Systems | 2000 |
| 1001 | Standard on Fire Fighter Professional Qualifications | 2002 |
| 1002 | Standard for Fire Apparatus Driver/Operator Professional Qualifications | 1998 |
| 1003 | Standard for Airport Fire Fighter Professional Qualifications | 2000 |
| 1006 | Standard for Rescue Technician Professional Qualifications | 2003 |
| 1021 | Standard on Fire Officer Professional Qualifications | 1997 |
| 1031 | Standard for Professional Qualifications for Fire Inspector and Plan Examiner | 1998 |
| 1033 | Standard for Professional Qualifications for Fire Investigator | 1998 |
| 1035 | Standard for Professional Qualifications for Public Fire and Life Safety Educator | 2000 |
| 1041 | Standard for Fire Service Instructor Professional Qualifications | 2002 |
| 1051 | Standard for Wildland Fire Fighter Professional Qualifications | 2002 |
| 1061 | Standard for Professional Qualifications for Public Safety Telecommunicator | 2002 |
| 1071 | Standard for Emergency Vehicle Technician Professional Qualifications | 2000 |
| 1081 | Standard for Industrial Fire Brigade Member Professional Qualifications | 2001 |
| 1122 | Code for Model Rocketry | 2002 |
| 1123 | Code for Fireworks Display | 2000 |
| 1124 | Code for the Manufacture, Transportation, Storage, and Retail Sales of Fireworks and Pyrotechnic Articles | 2003 |

Table E-1. NFPA Codes and Standards (continued)

| NFPA | Title | Edition |
|-------------|--|----------------|
| 1125 | Code for the Manufacture of Model Rocket and High Power Rocket Motors | 2001 |
| 1126 | Standard for the Use of Pyrotechnics before a Proximate Audience | 2001 |
| 1127 | Code for High Power Rocketry | 2002 |
| 1141 | Standard for Fire Protection in Planned Building Groups | 1998 |
| 1142 | Standard on Water Supplies for Suburban and Rural Fire Fighting | 2001 |
| 1145 | Guide for the Use of Class A Foams in Manual Structural Fire Fighting | 2000 |
| 1150 | Standard on Fire-Fighting Foam Chemicals for Class A Fuels in Rural, Suburban and Vegetated Area | 1999 |
| 1192 | Standard on Recreational Vehicles | 2002 |
| 1194 | Standard for Recreational Vehicle Parks and Campgrounds | 2002 |
| 1201 | Standard for Developing Fire Protection Services for the Public | 2000 |
| 1221 | Standard for Installation, Maintenance, and Use of Emergency Service Communications Systems | 2002 |
| 1250 | Recommended Practice in Emergency Service Organization Risk Management | 2000 |
| 1401 | Recommended Practice for Fire Service Training Reports and Records | 2001 |
| 1402 | Guide to Building Fire Service Training Centers | 2002 |
| 1403 | Standard on Live Fire Training Evolutions | 2002 |
| 1404 | Standard for a Fire Department Self-Contained Breathing Apparatus Program | 2002 |
| 1405 | Guide for Land-Based Fire Fighters Who Respond to Marine Vessel Fires | 2001 |
| 1410 | Standard on Training for Initial Emergency Scene Operations | 2000 |
| 1451 | Standard for a Fire Service Vehicle Operations Training Program | 2002 |
| 1452 | Guide for Training Fire Service Personnel to Conduct Dwelling Fire Safety Surveys | 2000 |
| 1500 | Standard on Fire Department Occupational Safety and Health Program | 2002 |
| 1521 | Standard for Fire Department Safety Officer | 2002 |

Table E-1. NFPA Codes and Standards (continued)

| NFPA | Title | Edition |
|------|---|---------|
| 1561 | Standard on Emergency Services Incident Management System | 2002 |
| 1581 | Standard on Fire Department Infection Control Program | 2000 |
| 1582 | Standard on Medical Requirements for Fire Fighters and Information for Fire Department Physicians | 2000 |
| 1583 | Standard on Health-Related Fitness Programs for Fire Fighters | 2000 |
| 1584 | Recommended Practice on the Rehabilitation of Members Operating at Incident Scene Operations and Training Exercises | 2003 |
| 1600 | Standard on Disaster/Emergency Management and Business Continuity Programs | 2000 |
| 1620 | Recommended Practice for Pre-Incident Planning | 1998 |
| 1670 | Standard on Operations and Training for Technical Rescue Incidents | 1999 |
| 1710 | Standard for the Organization and Deployment of Fire Suppression Operations, Emergency Medical Operations, and Special Operations to the Public by Career Fire Department | 2001 |
| 1720 | Standard for the Organization and Deployment of Fire Suppression Operations, Emergency Medical Operations, and Special Operations to the Public by Volunteer Fire Departments | 2001 |
| 1851 | Standard on Selection, Care, and Maintenance of Structural Fire Fighting Protective Ensembles | 2001 |
| 1852 | Standard on Selection, Care, and Maintenance of Open-Circuit Self Contained Breathing Apparatus (SCBA) | 2002 |
| 1901 | Standard for Automotive Fire Apparatus | 1999 |
| 1906 | Standard for Wildland Fire Apparatus | 2001 |
| 1911 | Standard for Service Tests of Fire Pump Systems on Fire Apparatu | 2002 |
| 1912 | Standard for Fire Apparatus Refurbishin | 2001 |
| 1914 | Standard for Testing Fire Department Aerial Devices | 2002 |
| 1915 | Standard for Fire Apparatus Preventive Maintenance Program | 2000 |
| 1925 | Standard on Marine Fire-Fighting Vessels | 1998 |

Table E-1. NFPA Codes and Standards (continued)

| NFPA | Title | Edition |
|-------------|--|----------------|
| 1931 | Standard on Design of and Design Verification Tests for Fire Department Ground Ladders | 1999 |
| 1932 | Standard on Use, Maintenance, and Service Testing of Fire Department Ground Ladders | 1999 |
| 1936 | Standard on Powered Rescue Tool Systems | 1999 |
| 1951 | Standard on Protective Ensemble for USAR Operations | 2001 |
| 1961 | Standard on Fire Hose | 2002 |
| 1962 | Standard for the Inspection, Care, and Use of Fire Hose, Couplings, and Nozzles and the Service Testing of Fire Hose | 2003 |
| 1963 | Standard for Fire Hose Connections | 1998 |
| 1964 | Standard for Spray Nozzles | 2003 |
| 1971 | Standard on Protective Ensemble for Structural Fire Fighting | 2000 |
| 1975 | Standard on Station/Work Uniforms for Fire and Emergency Services | 1999 |
| 1976 | Standard on Protective Ensemble for Proximity Fire Fighting | 2000 |
| 1977 | Standard on Protective Clothing and Equipment for Wildland Fire Fighting | 1998 |
| 1981 | Standard on Open-Circuit Self-Contained Breathing Apparatus for the Fire Service | 2002 |
| 1982 | Standard on Personal Alert Safety Systems (PASS) | 1998 |
| 1983 | Standard on Fire Service Life Safety Rope and System Components | 2001 |
| 1989 | Standard on Breathing Air Quality for Fire and Emergency Services Respiratory Protection | 2003 |
| 1991 | Standard on Vapor-Protective Ensembles for Hazardous Materials Emergencies | 2000 |
| 1992 | Standard on Liquid Splash-Protective Ensembles and Clothing for Hazardous Materials Emergencies | 2000 |
| 1994 | Standard on Protective Ensembles for Chemical/Biological Terrorism Incidents | 2001 |
| 1999 | Standard on Protective Clothing for Emergency Medical Operations | 2003 |

Table E-1. NFPA Codes and Standards (continued)

| NFPA | Title | Edition |
|-------------|--|----------------|
| 2001 | Standard on Clean Agent Fire Extinguishing Systems | 2000 |
| 2112 | Standard on Flame-Resistant Garments for Protection of Industrial Personnel Against Flash Fire | 2001 |
| 2113 | Standard on Selection, Care, Use, and Maintenance of Flame-Resistant Garments for Protection of Industrial Personnel Against Flash Fire | 2001 |
| 5000 | Building Construction and Safety Code™ | 2003 |

This page intentionally left blank.

APPENDIX F. GLOSSARY OF FIRE PROTECTION TERMS

This page intentionally left blank.

APPENDIX F. GLOSSARY OF FIRE PROTECTION TERMS

The purpose of this appendix is to provide definitions and meanings of fire protection engineering term being used in the field of fire science, engineering, and technology today. This appendix contains a collection of terminology and a description of terms and can be used as reference source to understand basic terminology used in fire protection engineering. The reference for the definition is provided in parentheses.

accelerant—a material (gas, liquid, or solid) used to initiate or promote the spread of fire incident. Most accelerants are highly flammable. (Nolan, 2000)

access door—a fire door smaller than conventional doors provides access to utility shafts, chases, manways, plumbing, and various other concealed spaces and equipments. (NFC Online Glossary)

abort switch—a manually activated switch provided for fixed gaseous fire suppression system to cancel the signal to release and discharge the system agent. The use of an abort switch is preferred over other manual means, such as portable fire extinguishers or when a false alarm condition is immediately known, to avoid the unnecessary release of large quantities of fire suppression agent. An abort switch is only practical where individuals may be present to immediately investigate the cause of the system activation and have time to activate the switch.

absolute temperature—a temperature measured in Kelvin (K) or degree Rankine (R). Zero is the lowest possible temperature and 273 K corresponds to 0 °F and 460 °R corresponds to 0 °F. $K = °C + 273$ and $°R = °F + 460$. (Nolan, 2000)

access door, horizontal—an access door installed in the horizontal plane used to protect openings in fire-rated floors or ceilings of floor–ceiling or roof–ceiling assemblies. (NFC Online Glossary)

access door, vertical—an access door installed in the vertical plane used to protect openings in fire-rated walls. (NFC Online Glossary)

access floor system—an assembly consisting of panels mounted on pedestals to provide an under-floor space for the installations of mechanical, electrical communication, or similar systems or to serve as an air supply or return-air plenum. (NFC Online Glossary)

access openings—a window, panel, or similar opening meeting the following criteria: (a) The opening has minimum dimensions of not less than 22 in. (55.9 cm) in width and 24 in. (61 cm) in height and is unobstructed to allow for ventilation and rescue operations from the exterior, and (b) The bottom of the opening is not more than 44 in. (112 cm) above the floor, and (c) The opening is readily identifiable from both the exterior and interior, and (d) The opening is readily openable from both the exterior and interior. (NFC Online Glossary)

access panel—a closure device used to cover an opening into a duct, an enclosure, equipment, or an appurtenance. (NFC Online Glossary)

accessible—having access to but which first may require the removal of a panel, door, or similar covering of the item described. (NFC Online Glossary)

accessible (as applied to wiring methods)—capable of being removed or exposed without damaging the building structure or finish, or not permanently closed in by the structure or finish of the building. (NFC Online Glossary)

accessible—(as applied to equipment.) Admitting close approach; not guarded by locked doors, elevation, or other effective means. (NFC Online Glossary)

accessible means of egress—a path of travel, usable by a person with a severe mobility impairment, that leads to a public way or an area of refuge and that complies with the accessible route requirements of ICC/ANSI A117.1, "American National Standard for Accessible and Usable Buildings and Facilities".(NFC Online Glossary)

accommodation area—a group of accommodation spaces and interconnecting corridors or spaces. (NFC Online Glossary)

accommodation space—spaces designed for living purposes. (NFC Online Glossary)

accommodation spaces—accommodation spaces shall include, but are not limited to, all portions of a vessel used for such purposes as overnight residence, deliberation, worship, entertainment, dining, or amusement. Accommodation spaces shall include the following: (a) passenger or crew cabins (b) lounge areas (c) athletic facilities (d) gaming areas (e) office spaces (f) spaces for religious worship (g) theaters (h) restaurants/messing areas (i) public toilets/washrooms (j) public sales/shops. (NFC Online Glossary)

active fire barrier—a fire barrier element that must be physically repositioned from its normal configuration to an alternate configuration in order to provide its protective function. Example include ventilation system fire dampers and normally open fire door.

activation energy—the minimum energy that colliding fuel and oxygen molecules must possess to permit chemical interaction. (NFC Online Glossary)

active fire protection—a fire protection method that requires manual, mechanical, or other means of initiation, replenishment, or sustenance for its performance during a detected hazard or fire incident. Typical activations include switching on, directing, injecting, or expelling in order to combat smoke, flame, or thermal loadings. Fire sprinkler systems and manual firefighting efforts are examples. Active systems are commonly composed of an integrated detection, signaling, and automated fire control system. (Nolan, 2000)

active smoke detection system—a fire detection system where smoke is transported to and into a sampling port to aspirate smoke into the detector-sensing chamber rather than relying totally on outside forces such as fire plume strength or environmental air flows. These systems actively draw smoke into the sensing chamber through the use of suction fans. Smoke in the immediate vicinity of the sampling ports is drawn into the detector-sensing chamber. (Nolan, 2000)

adiabatio—Referring to any change in which there is no gain or loss of heat. (McGraw-Hill)

adiabatic flame temperature—the maximum possible flame temperature that can be achieved by a particular combustion process (with no heat loss from the combustion). For example, the adiabatic flame temperatures for hydrocarbon fuels burning in air range from 2,000 °C to 2,300 °C (3,632 °F to 4,172 °F). (Nolan, 2000)

advanced light water reactors (ALWR)—advanced light water reactors are divided into two types: (a) evolutionary plants. These are simpler, improved versions of conventional designs employing active safety systems. (b) revolutionary plants. These are the result of completely rethinking the design philosophy of conventional plants. Revolutionary plants currently being proposed replace mechanical safe shutdown systems with passive features that rely on physical properties such as natural circulation, gravity flow, and heat sink capabilities. (NFC Online Glossary)

aerosol—A gaseous suspension of ultramicroscopic particles of a liquid or a solid. (McGraw-Hill)

aerosol detector—a detector designed to be activated by the liquid and solid particulates in smoke.

AFFF-Aqueous Film Forming Foam—a foam that forms a spreading aqueous film over the surface of a flammable liquid. AFFF is a combination of fluorocarbon surfactants and synthetic foam agents. They produce a foam that slides across the surface of hydrocarbon fuels. This is accomplished by the formation of a film that spreads ahead of the foam bubbles. (NFC Online Glossary)

air sampling-type detector—a detector that consists of a piping or tubing distribution network that runs from the detector to the area(s) to be protected. An aspiration fan in the detector housing draws air from the protected area back to the detector through air sampling ports, piping, or tubing. At the detector, the air is analyzed for fire products.

air/fuel ratio, air-rich—the ratio of air to fuel by weight or volume which is significant for proper oxidative combustion of the fuel. (McGraw-Hill)

alarm—a signal indicating an emergency that requires immediate action, such as a signal indicative of fire. (Nolan, 2000)

alarm signal—a signal indicating a concentration of carbon monoxide that could pose a risk to the life safety of the occupants in the family living unit, requiring immediate action. (NFC Online Glossary)

alarms and indicators—any device capable of providing audible, visual, or olfactory indication.

alternative shutdown capability—the ability to safely shut down the reactor and maintain shutdown using equipment and processes outside the normal reactor shutdown process.

ambient temperature—the temperature of the surrounding medium; usually used to refer to the temperature of the air in which a structure is situated or a device operates.

American Wire Gauge (AWG)—a standardized system used to designate the size or "gauge" of wire. As the diameter of wire gets smaller, the "AWG" number of the wire gets larger. The

smallest AWG size is 40 and looks like a metal thread. "Four ought" (0000) is the largest AWG wire size designation. Wires larger than this size are designated by the Thousand Circular Mill system or "KCMIL" sizes (known until recently as MCM).

ampacity—the current, in amperes, that a conductor can carry continuously under the conditions of use without exceeding its temperature rating.

analysis, sensitivity—an analysis performed to determine the degree to which a predicted output will vary given a specified change in an input parameter, usually in relation to models. (NFC Online Glossary)

analysis, uncertainty—an analysis performed to determine the degree to which a predicted value will vary. (NFC Online Glossary)

analyzer, gas—a device that measures concentrations, directly or indirectly, of some or all components in a gas or mixture. (NFC Online Glossary)

annunciator—a unit containing two or more identified targets or indicators lamps in which each target or lamp indicates the circuit, condition, or location to be annunciated. (NFC Online Glossary)

antifreeze sprinkler system—a wet pipe sprinkler system employing automatic sprinklers that are attached to a piping system that contains an antifreeze solution and that are connected to a water supply. The antifreeze solution is discharge, followed by water, immediately upon operation of sprinklers opened by heat from a fire. (NFC Online Glossary)

Appendix R cables—the set of cables that must remain free of fire damage to ensure safe shutdown conditions can be achieved within established criteria.

Appendix R fire area—an area, as defined in the Appendix R analysis, sufficiently bounded by fire barriers that will withstand the fire hazards within the fire area and, as necessary, to protect important equipment within a fire area from a fire outside the area the area. A fire area must be made up of rated fire barriers with openings in the barriers provided with fire doors, fire dampers, and fire penetration seal assemblies having a fire resistance rating at least equivalent to the barrier in which it is installed.

Appendix R fire zones—subdivisions of a fire area.

Appendix R requirements—fire protection requirements specified in Appendix R to 10 CFR 50, "Fire Protection Program for Nuclear Power Facilities Operating Prior to January 1, 1979," (It should be noted that while some specific Appendix R requirements apply to all plants operating prior to January 1, 1979, plants licensed after January 1, 1979, are not subject to Appendix R requirements. These plants must meet the fire protection condition of their licenses which are based upon the guidelines of NUREG-0800, specifically Branch Technical Position CMEB 9.5-1, which mirrors Appendix R with additional information).

approach fire fighting—limited, specialized exterior fire fighting operations at incidents involving fires producing very high levels of conducted, convective, and radiant heat, such as bulk flammable gas and bulk flammable liquid fires. Speciality thermal protection from exposure to high levels of

radiant heat is necessary for the persons involved in such operations due to the limited scope of these operations and greater distance from the fire that these operations are conducted. Not entry, proximity, or structural, or wildland fire-fighting. (NFC Online Glossary)

approved—tested and accepted for a specific purpose or application by a recognized testing laboratory. (Regulatory Guide 1.189)

approved—acceptable to authority having jurisdiction. (NFPA 805)

aqueous film-forming foam (AFFF) concentrate—a concentrated aqueous solution of fluorinated surfactant(s) and foam stabilizers that is capable of producing an aqueous fluorocarbon film on the surface of hydrocarbon fuels to suppress vaporization. (NFC Online Glossary)

arcing—the flashing occurring at electrical terminals when the circuit has been opened or closed.

armored cable—type AC armored cable is a fabricated assembly of insulated conductors in a flexible metallic enclosure. (NFC Online Glossary)

assembly—a unit or structure composed of a combination of materials or products, or both. (NFC Online Glossary)

assembly occupancy—an occupancy (1) used for a gathering of 50 or more persons for deliberation, worship, entertainment, eating, drinking, amusement, awaiting transportation, or similar uses; or (2) used as a special amusement building, regardless of occupant load. (NFC Online Glossary)

associated circuits—circuits that do not meet the separation requirements for safe shutdown systems and components and are associated with safe shutdown systems and components by common power supply, common enclosure, or the potential to cause spurious operations that could prevent or adversely affect the capability to safely shutdown the reactor as a result of fire induced failure (hot shorts, open circuits, and short to ground). (Regulatory Guide 1.189)

associated circuit analysis—a documented, systematic, evaluation of associated circuits of concern to post-fire safe shutdown.

atmospheric pressure—the pressure of the weight of air and water vapor on the surface of the earth, approximately 14.7 pounds per square inch (psia) (101 kPa absolute) at sea level. (NFC Online Glossary)

atmospheric tank—a storage tank that has been designed to operate at gauge pressures from atmospheric through 0.5 psi (3.45 kPa). (NFC Online Glossary)

atmospheric vents—all points where pipes, stacks, or ducts are open to the atmosphere including discharge points from emissions control devices, vent pipes from safety valves, vent pipes from filters or pumps, and other vents. (NFC Online Glossary)

Authority Having Jurisdiction (AHJ)—the organization, office, or individual responsible for approving equipment, materials, an installation, or a procedure. (NFPA 805)

autoignition—the initiation of fire or combustion process by external heat without the application of a spark or flame. (NFC Online Glossary)

autoignition temperature—the lowest temperature at which a mixture of fuel and oxidizer can propagate a flame without the aid of an initiating energy source (pilot, a spark or flame).

autoignition temperature—the lowest temperature at which a vapor/air mixture within its flammability limits can undergo spontaneous ignition.

automatic closing device—a mechanism that can be fitted to a door which will cause the door to close if there is a fire.

automatic door release—a device on a self-closing door that holds the door open during normal operation but causes it to close by releasing electromagnetic holders when activated by a signal, such as from a fire alarm. The closed door prevents the spread of fire and smoke. For personnel exit applications and other locations where smoke spread is a concern, fusible links or other similar heat-activated door-closing devices are not recommended because smoke may pass through the door opening before there is sufficient heat to melt the fusible device. (Nolan, 2000)

automatic fire alarm system—a system of controls, initiating devices, and alarm signals in which all or some of the initiating circuits are activated by automatic devices, such as smoke detectors. (Nolan, 2000)

automatic fire detection system—an arrangement of detectors that ascertains the presence of a combustion process by sensing heat, smoke, or flames. The detectors can be self-annunciating or connected to a fire alarm control panel (FACP) to initiate other alarm devices or signaling systems. Various codes and standards are used to design and provide a fire alarm system, notably NFPA 72, "National Fire Alarm Code[®]". (Nolan, 2000)

automatic fire door—a fire door that closes immediately following the detection of a fire incident. Most fire doors that automatically close are held open by electromagnetic holders. When the fire is detected by a fire detection system, power is removed from the magnetic holders, and the doors swing closed from their self-closer. It may also be called an automatic-closing fire door. (Nolan, 2000)

automatic fire extinguishing system—a fire suppression system that automatically senses the occurrence of a fire and signals a control device for the application of extinguishing agents. It is designed to distribute and apply the extinguishing agents in sufficient quantities and densities to effect fire control and extinguishment. No human intervention is required. Almost all automatic fire extinguishing systems are required to be designed and installed according to prescribed rules and regulations that ensure they are reliable and effective for fire protection applications. (Nolan, 2000)

automatic fire protection—active fire protection measures that are activated immediately following a fire incident without human intervention. Automatic fire protection systems provide for both fire detection and extinguishment. (Nolan, 2000)

automatic sprinkler—a water spray device, commonly a nozzle with a perpendicular spray deflector attached, used to deflect the water spray to a predetermined area at a predetermined density for the purpose of fire protection. Automatic sprinklers for fire protection applications are available in

a variety of configurations and decorative features. The sprinklers for fire protection are normally required to be tested or approved by an independent testing agency (UL or FM). Sprinklers may be installed with an open orifice (dry sprinklers) or provided with an element that contains the system water supply (wet sprinklers). Water is sprayed from the sprinkler once the heat from a fire causes a fusible element in the sprinkler head to melt. Once the element has melted it releases a tension mounted cap on the outlet of the sprinkler. The sprinkler outlet is connected to a water distribution pipe network. Water pressure in the pipe network directs water onto the sprinkler deflector, providing the water spray. (Nolan, 2000)

auxiliarized local system—a local system that is connected to the municipal alarm facilities.

auxiliarized proprietary system—a proprietary system that is connected to the municipal alarm facilities.

auxiliary protective signaling system—a connection to the municipal fire alarm system to transmit an alarm of fire to the municipal communication center. Fire alarms from an auxiliary center on the same equipment and by the same alerting methods as alarms transmitted from municipal fire alarm boxes located on streets.

back pressure—pressure against which a fluid is flowing, resulting from friction in lines, restrictions in pipes or valves, pressure in vessel to which fluid is flowing, hydrostatic head, or other impediment that causes resistance to fluid flow. (NFC Online Glossary)

Backdraft—limited ventilation during an enclosure fire can lead to the production of large amount of unburnt gases. When an opening is suddenly introduced, the inflowing air may mix with these, creating a combustible mixture of gases in some part of the enclosure. Any ignition sources, such as a flowing ember, can ignite this flammable mixture, resulting in an extremely rapid burning of the gases. Expansion due to the heat created by the combustion will expel the burning gases out through the opening and cause a fireball outside the enclosure. The phenomenon can be extremely hazardous. (NFC Online Glossary)

backfire arrester—a flame arrester installed in fully premixed air–fuel gas distribution piping to terminate flame propagation therein, shut off fuel supply, and relieve pressure resulting from a backfire. (NFC Online Glossary)

barrier —a part providing protection against direct contact from any usual direction of access. (IEC 50-826.) (NFC Online Glossary)

barrier failure—the breach of a fire barrier, by a fire or other cause, which could permit propagation of a fire or its combustion products across the barrier.

barrier material—a single-layer fabric or a laminated or coated, multilayer material considered as a single-layer fabric that limits transfer from the face of the layer to the other side. (NFC Online Glossary)

barrier, smoke—a continuous membrane, or a membrane with discontinuities created by protected openings, where such membrane is designed and constructed to restrict the movement of smoke. (NFC Online Glossary)

barrier, thermal—a material that limits the average temperature rise of an unexposed surface to not more than 120 °C (250 °F) for a specified fire exposure complying with the standard time-temperature curve of NFPA 251, "Standard Methods of Tests of Fire Endurance of Building Construction and Materials". (NFC Online Glossary)

blackbody temperature—the temperature of a perfect radiator; a surface with an emissivity of unity and, therefore, a reflectivity of zero. (NFC Online Glossary)

blanketing (or padding)—a technique of maintaining an atmosphere that is either inert or fuel-enriched in the vapor space of a container or vessel. (NFC Online Glossary)

blast—a transient change in the gas density, pressure, and velocity of the air surrounding an explosion point. The initial change can be either discontinuous or gradual. A discontinuous change is referred to as a shock wave, and a gradual change is known as a pressure wave. Blast is also called pressure wave. (Nolan, 2000)

blast area—the area including the blast site and the immediate adjacent area within the influence of flying rock, missiles, and concussion. (NFC Online Glossary)

blast pressure front—the expanding leading edge of an explosion reaction that separates a major difference in pressure between normal ambient pressure ahead of the front and potentially damaging high pressure at and behind the front. (NFC Online Glossary)

blast site—the area where explosive material is handled during loading of the blasthole, including 15.3 m (50 ft) in all directions from the perimeter formed by loaded holes. A minimum of 9.15 m (30 ft) can replace the 15 m (50 ft) requirement if the perimeter for loaded holes is marked and separated from nonblast site areas by a barrier. The 15.3 m (50 ft) or 9.15 m (30 ft) distance requirements, as applicable, apply in all directions along the full depth of the blasthole. In underground mines, at least 4.6 m (15 ft) of a solid rib, pillar, or broken rock can be substituted for the 15.3 m (50 ft) distance. (NFC Online Glossary)

blasting agent—a material or mixture intended for blasting that meets the requirements of the DOT "Hazardous Materials Regulations," as set forth in Title 49, Code of Federal Regulations, Parts 173.56, 173.57, and 173.58, Explosive 1.5D. (NFC Online Glossary)

blaze—terminology for a free-burning fire characterized as spectacular in flame evolution.

Boiling Liquid Expanding Vapor Explosion (BLEVE)—a catastrophic rupture of a pressurized vessel containing a liquid at a temperature above its normal boiling point with the simultaneous ignition of the vaporizing fluid. A short-duration, intense fireball occurs if the liquid is flammable. During the rupture of the vessel, a pressure wave may be produced and fragments of the containment vessel will be thrown considerable distances. (Nolan, 2000)

boilover—a phenomenon that can occur during a fire over an open tank containing a blend of flammable liquids, such as crude oil; water must be present at the bottom of the tank for boilover to occur. (Friedman, 1998)

boiling point—the maximum temperature at which a liquid can evaporate under normal; atmospheric conditions; equilibrium temperature for a liquid and its vapor to coexist at 1 atmosphere of pressure.

boiling point—the temperature at which the vapor pressure of a liquid equals the surrounding atmospheric pressure. For purposes of defining the boiling point, atmospheric pressure shall be considered to be 14.7 psia (760 mm Hg). For mixtures that do not have a constant boiling point, the 20 percent evaporated point of a distillation performed in accordance with ASTM D86, Standard Method of Test for Distillation of Petroleum Products, shall be considered to be the boiling point. (NFC Online Glossary)

bounding analysis—an analysis that intentionally makes use of methods and assumptions (e.g., those pertaining to parameters describing a hazard, a resulting initiating event, and a plant's resistance to the initiator) designed to result in an upper-bound or demonstrably conservative estimate of risk.

British Thermal Unit (Btu)—the quantity of heat required to raise the temperature of one pound of water -17 °C (1 °F) at the pressure of one atmosphere and the temperature of 60 °F (15.5 °C).

building characteristics—a set of data that provides a detailed description of a building, such as building layout (geometry), access and egress, construction, building materials, contents, building services, and fire safety (hardware) systems. (NFC Online Glossary)

building code—a set of requirements intended to ensure that an acceptable level of safety (including fire safety) is incorporated into a building at the time of construction.

building construction types—there are five general types of building construction classifications defined for fire protection purposes. They are classified according to their fire resistive properties. They include the following (Nolan, 2000):

fire resistive—a broad range of structural systems capable of withstanding fires of specified intensity and duration without failure. Common fire-resistive components include masonry load-bearing walls, rein-forced concrete or protective steel columns, and poured or precast concrete floors and roofs (Ref. NFPA 220, Type I).

noncombustible—type of structure made of noncombustible materials in lieu of fire-resistant materials. Steel beams, columns, and masonry or metal walls are used (Ref. NFPA 220, Type II).

ordinary—consists of masonry exterior load-bearing walls that are of noncombustible construction. Interior framing, floors, and roofs are made of wood or other combustible materials, whose bulk is less than that needed to qualify as heavy-timber construction. If the floor and roof construction and their supports have a one-hour fire resistance rating and all openings through the floors (stairwells) are enclosed with partitions having a one-hour fire resistance rating, then the construction is classified as "protected ordinary construction" (Ref. NFPA 220, Type III).

heavy timber—characterized by masonry walls, heavy-timber columns and beams, and heavy plank floors. Although not immune to fire, the large mass of the wooden members

slows the rate of combustion. Heavy timber construction can be used where the smallest dimension of the members exceeds 5.5 in. (14 cm). When timbers are this large, they are charred but not consumed in a fire and are generally considered akin to a fire-resistant type of construction (Ref. NFPA 220, Type IV).

wood frame—building construction characterized by use of wood exterior walls, partitions, floors, and roofs. Exterior walls may be sheathed with brick veneer, stucco, or metal-clad or asphalt siding (Ref. NFPA 220, Type V).

building occupancy—the primary activity for which a building is designed and built. Fire code requirements are based on the risk a building occupancy represents, and, therefore, various building occupancies are normally defined by a fire code. Common building occupancies include assembly, business, educational, factory or industrial, hazardous or high hazard, institutional, mercantile, residential, storage and utility, special, or miscellaneous. (Nolan, 2000)

building services—provisions, such as heating, plumbing, electrical and air handling systems, that render a building habitable.

burning rate—the combustion rate of a fuel, expressed either as the rate of mass consumption per unit exposed area.

burnout—point at which flames cease. (Nolan, 2000)

burning velocity—the speed with which a laminar flame moves in a direction normal to its surface, relative to the unburned portion of combustible gas mixture, at constant pressure. Its value depends on mixture composition, temperature, and pressure.

buoyancy—an effective force on fluid due to density or temperature differences in a gravitational field. (NFC Online Glossary)

burn injury—an injury to the skin and deeper tissues caused by hot liquids, flames, radiant heat, and direct contact with hot solids, caustic chemicals, electricity, or electromagnetic (nuclear) radiation. A first-degree burn injury occurs with a skin temperature of about 48 °C (118 °F), and a second-degree burn injury occurs with a skin temperature of 55 °C (131 °F). Instantaneous skin destruction occurs at 72 °C (162 °F). Inhaling hot air or gases can also burn the upper respiratory tract.

The severity of a burn depends on its depth, its extent, and the age of the victim. Burns are classified by depth as first, second, and third degree. First-degree burns cause redness and pain (sun-burn) and affect only the outer skin layer. Second-degree burns penetrate beneath the superficial skin layer and are marked by edema and blisters (scalding by hot liquid). In third-degree burns, both the epidermis and dermis are destroyed, and underlying tissue may also be damaged. It has a charred or white leathery appearance and initially there may be a loss of sensation to the area. The extent of a burn is expressed as the percent of total skin surface that is injured. Individuals less than 1 year old and over 40 years old have a higher mortality rate than those between 2 and 39 years old for burns of similar depth and extent. Inhalation of smoke from a fire also significantly increases mortality. Thermal destruction of the skin permits infection, which is the most common cause of death for extensively burned individuals. Body fluids and minerals are

lost through the wound. The lungs, heart, liver, and kidneys may be affected by infection and fluid loss. First aid for most burns involves the application of cool water as soon as possible after the burn. Burns of 15-percent of the body surface or less are usually treated in hospital emergency rooms by removing dead tissue (debridement), dressing with antibiotic cream (often silver sulfadiazine), and administering oral pain medication. Burns of 15 to 25-percent of the body surface often require hospitalization to provide intravenous fluids and avoid complications. Burns of more than 25-percent of the body surface are usually treated in specialized burn centers. Aggressive surgical management is directed toward early skin grafting and avoidance of such complications as dehydration, pneumonia, kidney failure, and infection. Pain control with intravenous narcotics is frequently required. The markedly increased metabolic rate of severely burned patients requires high-protein nutritional supplements given intravenously and by mouth. Extensive scarring of deep burns may cause disfigurement and limitation of joint motion. Plastic surgery is often required to reduce the effects of the scars. Psychological problems often result from scarring. Investigations are underway to improve burn victims' nutritional support, enhance the immune response to infection, and grow skin from small donor sites in tissue culture to cover large wounds. Since over 50 percent of all burns are preventable (separation, barriers, protective clothing, etc.), safety programs can significantly reduce the incidence of burn injuries. (Nolan, 2000)

cable failure—a breakdown in the physical and/or chemical properties (e.g., electrical continuity, insulation integrity) of cable conductor(s) such that the functional integrity of the electrical circuit can not be assured (e.g., interrupted or degraded).

cable jacket—a protective covering over the insulation, core, or sheath of a cable. (IEEE Std.100-1988).

cable penetration—an assembly or group of assemblies for electrical conductors to enter and continue through a fire-rated structural wall, floor, or floor-ceiling assembly. (IEEE Std. 100-1988).

cable routing—the pathway electrical wiring takes through the plant from power source or control point to component location.

cable-to-cable fault—a fault condition of relatively low impedance between conductors of one cable and conductors of a different cable.

cable tray fire break—a noncombustible or limited-combustible material used for vertical cable trays to limit fire spread.

carbon dioxide—colorless, odorless, electrically nonconductive inert gas that is a suitable medium for extinguishing Class B and Class C fires. Liquid carbon dioxide forms dry ice (snow) when released directly into the atmosphere. Carbon dioxide gas is 1½ times heavier than air. Carbon dioxide extinguishers fire by reducing the concentrations of oxygen, the vapor phase of the fuel, or both in the air to the point where combustion stops. (NFC Online Glossary)

C-factor—a relative roughness coefficient used in mathematical calculations of friction losses for water flow in pipes for fire protection systems when using the Hazen-Williams friction loss formula. C-factors are dependent on the smoothness of the internal surfaces of pipes and are features of the pipe material and system age. A high C factor (120) represents a smooth internal pipe and a

low C-factor (80 or 90) is a rough internal pipe surface. The C-factor decreases as the level of friction within the pipe interior surface increases. When computerized hydraulic programs are used to determine water pressures and flow conditions within a water distribution system, the friction coefficients to use are specified as part of the input data. Common piping C factors used for fire protection applications include the following (Nolan, 2000):

Unlined Cast or Ductile Iron - 100
Asbestos Cement, Cement-Lined
Cast or Ductile Iron, Cement-Lined
Steel and Concrete - 140
Polyethylene, Polyvinyl Chloride (PVC), and Fiberglass
Epoxy-150 Copper - 150

calorimetry—the heat release rate for a fire is the most significant measure of the magnitude and destructive potential of a fire. The growth rate of the fire is determined by the burning rate characteristics of the fuel as well as the ignitability, flame spread, and geometry of the item. Given the significant complexities of the fire growth process, there is a need to be able to experimentally measure the heat release rate history of combustibles materials. The method for measuring heat release rates are collectively referred to as calorimetry.

While it is in principle possible to measure the heat output of a fire by thermal means, early attempts to use thermal methods were generally unsatisfactory due to practical details of instrument design. Modern calorimeters make use of the empirical fact that the heat released per unit of oxygen consumed is a constant, 13 kJ/g of oxygen. This direct relationship between oxygen consumption and heat release means that a measurement of oxygen depletion can be used to measure the heat release rate.

cavitation—formation of a partial vacuum (creating gas bubbles), in a liquid by a swiftly moving solid body (a propeller). Cavitation may occur in a firewater pumping system due to improper design, arrangement, or installation. The generation and collapse of the gas bubbles produce a vibration and sometimes severe mechanical strain on the pumping system, reducing performance and causing accelerated deterioration of the pumping components (especially the impeller). Specific design and installation requirements are set forth in NFPA 20, "Standard for the Installation of Stationary Pumps for Fire Protection," to prevent cavitation from occurring in fixed fire-water pump installations.

ceiling jet—the radially outward flow under a ceiling resulting when a fire plume impinges on a ceiling. (Friedman, 1998)

cellulosic—a natural polymer $(C_6H_{10}O_5)_n$, which is a principle constituent of cotton, wood, and paper. (Friedman, 1998)

cellulosic fire—a fire with a fuel source composition predominantly of cellulose (wood, paper, cotton, etc.). A fire involving these materials is relatively slow growing, although its intensity may ultimately reach or exceed that of a hydrocarbon fire. Standard building fire barriers are based on a cellulosic fire exposure as defined by ASTM E119, "Standard Test Methods for Fire Tests of Building Construction and Materials,"; ISO Standard No. 834; or BS 476 Part 20. Cellulosic fires reach a maximum temperature of just over 900 °C (1,652 °F).

central station system (or Central station firealarm system)—A fire alarm system controlled and operated by a designated business for fire alarm system operation and maintenance. All signals generated by the system report to a central station (office) and are acted upon as required. (Nolan, 2000)

Celsius temperature—a temperature scale on which pure water at sea level freezes at 0 °C and boils at 100 °C (212 °F). (Friedman, 1998)

char—the carbonaceous remains of burned materials.

charring—the production of a solid carbonaceous residue on heating or burning a solid.

circuit failure modes—open circuit - a condition that is experienced when an individual conductor within a cable loses electrical continuity.

short-to-ground—a condition that is experienced when an individual conductor comes in electrical contact with a grounded conducting device, such as a cable tray, conduit, or metal housing.

hot short—a condition that is experienced when individual conductors of the same or different cables come in contact with each other.

Class of fires (NFPA 10, 2002 Edition)—a letter designation given to a particular fire category for the purpose of generally classifying it accordance to the type of fuel and possible spread of fire.

Class A Fires—fires in ordinary combustible materials, such as wood, cloth, paper, rubber, and many plastics.

Class B Fires—fires in flammable liquids, combustibles liquids, petroleum greases, tars, oils, oil-based paints, solvents, lacquers, alcohols, and flammable gases,.

Class C Fires—fires that involve energized electrical equipment where the electrical non-conductivity of the extinguishing media is of importance. (When electrical equipment is de-energized, fire extinguishers for Class A or Class B fires can be used safely).

Class D Fires—fires in combustible metals, such as magnesium, titanium, zirconium, sodium, lithium, and potassium.

Class K Fires—fires in cooking appliances that involve combustible cooking media (vegetable or animal oils and fats).

circuit—a conductor or system of conductors through which electrical current flows. (IEEE Std.100-1988)

circuit—interconnection of components to provide an electrical path between two or more components.

circuit breaker—a device designed to open and close a circuit by nonautomatic means, and to open the circuit automatically on a predetermined overload of current without injury to itself when properly applied within its rating. (IEEE Std 100-1988)

circuit breaker—a mechanical switching device capable of making, carrying and breaking currents under normal circuit conditions and also, making, carrying for a specified period of time, and breaking currents under specified abnormal circuit conditions such as those of short circuit. (IEEE Std. 100-1988)

clean agent—a volatile or gaseous fire extinguishing agent that is not electrically conductive and does not leave any residue during or after its application following evaporation. Common clean agents include carbon dioxide, Halon, Inergen, and FM-200. Although Halon is considered a clean agent, it may contribute to the Earth's ozone depletion and therefore is considered environmentally harmful. (Nolan, 2000)

clean agent fire suppression system (CAFSS)—a fire suppression application system that utilizes a volatile or gaseous fire extinguishing agent that is not electrically conductive and does not leave any residue during or after its application following evaporation. (Nolan, 2000)

closed-circuit self-contained breathing apparatus (SCBA)—a recirculation-type SCBA in which the exhaled gas is rebreathed by the wearer after the carbon dioxide has been removed from the exhalation gas and the oxygen content within the system has been restored from sources such as compressed breathing air, chemical oxygen, liquid oxygen, or compressed gaseous oxygen.

code—comprehensive set of requirements intended to address fire safety in a facility. Code may reference numerous standards.

code of record—the codes and standards refer to the edition of the code or standard in effect at the time of fire protection systems or features was designed or specifically committed to the authority having jurisdiction.

cold smoke—smoke that is produced from a smoldering fire. The fire itself does not generate adequate quantities of heat to produce a flaming fire. Cold smoke therefore lacks the buoyancy of smoke from a flaming fire because its low heat content does not generate a strong convection current. Cold smoke may be more difficult to detect by ceiling mounted smoke detectors due to its lack of buoyancy. (Nolan, 2000)

combustion—the burning of gas, liquid, or solid, in which the fuel is oxidized, evolving heat and often light. (McGraw-Hill)

combustion efficiency—the ratio of heat actually developed in a combustion process to the heat that would be released if the combustion were perfect. (McGraw-Hill)

combustible gas detector—an instrument designed to detect the presence or concentration of combustible gases or vapors in the atmosphere. It is usually calibrated to indicate the concentration of a gas as a percentage of its lower explosive limit (LEL) so that a reading of 100-percent indicates that the LEL has been reached. They use either a solid-state circuit, infrared (IR) beam,

electrochemical, or dual catalytic bead for the detection of gas in an area. Portable monitors are used for personnel protection and fixed installations are provided for property protection.

combustible liquid—as generally defined, it is any liquid that has a closed-cup flash point at or above 100 °F (37.8 °C). Combustible liquids are classified as Class II or Class III, and flammable liquids are classified as IA, IB or IC. (NFPA 30)

Class II Liquid—any liquid tested with a flash point at or above 37.8 °C (100°F) and below 60 °C (140°F).

Class III A—any liquid tested with a flash point at or above 60 °C (140 °F), but below 93 °C (200 °F).

Class III B—any liquid tested with a flash point at or above 93 °C (200 °F).

combustible liquid area-fixed—an area used for storage of Class II and Class III combustible liquids that is infrequently moved, and where the aggregate quantity present shall not exceed 5,000 gallon (18, 925 L). Handling of liquids incidental to transfer can take place within a storage area. (NFC Online Glossary)

combustible liquid area-large—an area used for storage of Class II and Class III combustible liquids where the aggregate quantity present shall not exceed 1,000 gallon (3,785 L). Handling of liquids incidental to transfer can take place within a storage area. (NFC Online Glossary)

combustible liquid area-mobile—self-propelled or mobile equipment fitted with suitable containers or tanks and other related fixtures used for the storage, transport, and dispensing of Class II and Class III combustible liquids. The aggregate quantity of combustible liquid carried on such equipment shall not exceed 1,000 gallon (3,785 L). (NFC Online Glossary)

combustible liquid area-portable—an area used for storage of Class II and Class III combustible liquids that is periodically moved, and where the aggregate quantity present shall not exceed 1,000 gallon (3,785 L). Handling of liquids incidental to transfer can take place within a storage area. (NFC Online Glossary)

combustible liquid area-small—an area used for storage of Class II and Class III combustible liquids that is periodically moved, and where the aggregate quantity present shall not exceed 60 gallon to 1,000 gallon (227 L to 3,785 L). Handling of liquids incidental to transfer can take place within a storage area. (NFC Online Glossary)

combustible material—any material that will burn or sustain the combustion process when ignited or otherwise exposed to fire conditions. (Regulatory Guide 1.189)

common enclosure—an enclosure (e.g., cable tray, conduit, junction box) that contains circuits required for the operation of safe shutdown components and circuits for non-safe shutdown components.

common-mode failure—multiple failures that are attributable to a common cause. (IEEE Std. 100-1988.)

common power supply/source—a power supply that feeds safe shutdown circuits and non-safe shutdown circuits (Regulatory Guide 1.189)

common path of travel—the portion of an exit access that building occupants must traverse before two distinct paths of travel or two exits are available. (NFC Online Glossary)

compartmentation—a type of building design in which a building is divided into sections that can be closed off from each other so that there is resistance to fire spread beyond the area of origin.

compartmentation—a fire protection strategy whereby a building is subdivided into compartments that are separated from one another by fire resistant barriers.

complete combustion—refers to the chemical reaction where all the product components are in their most stable state.

compressed breathing gas—a respirable gas mixture stored in a compressed state and supplied to the user in a gaseous form. (NFC Online Glossary)

compressed gas—any material or mixture having, when in its container, an absolute pressure exceeding 40 psia (an absolute pressure 276 kPa) at 21.1 °C (70 °F) or, regardless of the pressure at 21.1 °C (70 °F), having an absolute pressure exceeding 104 psia (an absolute pressure of 717 kPa) at 54.4 °C (130 °F). (NFC Online Glossary)

computer fire model—a computer fire model is normally realized as a computer program for predicting fire. This is most common, but not necessarily always true. A computer fire model, for example, could be realized as only a flowchart.

concentration—the percentage of material per unit mass (or volume) of its mixture.

conduction—the mode of heat transfer associated with solid in direct contact, or heat transfer due to molecular energy transfer following Fourier's Law.

conductor—a substance or body that allows a current of electricity to pass continuously along it. (IEEE Std. 100-1988)

conductor—a wire or combination of wires, not insulated from one another, suitable for carrying an electric current. (IEEE Std. 100-1988)

conductor-to-conductor fault—a circuit fault condition of relatively low impedance between two or more conductors of the same or different circuit.

conductor-to-conductor fault—a cable failure mode of relatively low impedance between two or more conductors of the same multi-conductor cable (Intra-cable fault) or between two or more separate cables (Inter-cable fault).

configuration factor—fraction of radiation received by a target compared to the total emitted by the source.

conflagration or mass fire—a fire over a large tract of land where generally the flames are much shorter than the horizontal extent of the fire.

contain a fire—to take suppression action that can reasonably be expected to check the fire spread under prevailing and predicted conditions.

control of burning—application of water spray to equipment or areas where a fire can occur to control the rate of burning and thereby limit the heat release from a fire until the fuel can be eliminated or extinguishment effects.

control cable—cable applied at relatively low current levels or used for intermittent operation to change the operating status of a utilization device of the plant auxiliary system. (IEEE Std. 100-1988)

control circuit—the circuit that carries the electrical signals directing the performance of the controller but does not carry the main power circuit (IEEE Std. 100-1988).

control panel—an assembly of man/machine interface devices (IEEE Std. 100-1988).

control power/voltage—the voltage applied to the operating mechanism of a device to actuate it. (IEEE Std. 100-1988)

control-power transformer—a transformer which supplies power to motors, relays, and other devices used for control purposes. (IEEE Std. 100-1988)

control a fire—to complete a control line around a fire, any spot fire therefrom, or any interior island to be saved; to burn out any unburned area adjacent to the fire side of the control line and cool down all hot spots that are an immediate threat to the control line.(NFC Online Glossary)

convection—the heat transfer associated with fluid movement around the heated body. Warmer, less dense fluid rises and is replaced by cooler, more dense fluid. Convection current rise during a fire event due to heat transfer to the surrounding air, causing it to rise and allow cooler air to enter the fire environment at the base of the fire.

convective heat—energy that is carried by a hot moving fluid.

convective heat transfer coefficient—a quantity that represent the ability of heat to be transformed from a moving fluid to a solid surface expressed in terms of heat flux per unit temperature difference.

consequences—consequences are expected effects from the realization of the hazard and severity, usually measured in terms of property damage, business interruption, life safety exposure, environmental impact, company image etc.

corrosion-resistant material—materials such as brass, copper, monel, stainless steel, or other equivalent corrosion-resistant materials. (NFC Online Glossary)

cracking—pyrolysis; breaking gaseous molecules into other molecules.

credited shutdown equipment—the set of equipment that is relied on (credited in the SSA) for achieving post-fire safe shutdown conditions in the event of fire in a specific fire area.

creep—the high temperatures [over 500 °C (1,000 °F)] reached during fire greatly accelerate the creep strain rate (gradual degradation) in a building element. Although this time-dependent strain is important in all building elements, its effects are critical in the case of tension loads in structural steel members are reinforcing steel. The influence of creep strain on elements should be considered in all but the most gross estimates of fire resistance. An increase in creep strain rate will have the net effect of increased deformation. In general, the stress relief provided by increased creep strain may preclude catastrophic failures in steel beams.

critical heat flux—a threshold level of heating below which ignition (or in other context, flame spread) is not possible.

critical temperature—the temperature at which a structural metal (such as steel) softens when heated and can no longer support load. It is usually below its melting temperature.

cross-linked polymer—a polymer in which the long chains are bonded to one another at intermediate points. Cross-linking reduces flexibility and tendency to melt, and increases the tendency to form char on heating. (Friedman, 1998)

cross-zoning—a method of fire detection whereby adjacent fire detectors are connected to different sensing circuits to the fire alarm control panel. Confirmed fire detection is only achieved if two detectors are activated, one from each of the separate alarm circuits. Cross-zoning is used primarily as a deterrent against false alarms and in particular where a fixed fire suppression system (such as a CO₂ system) is arranged to automatically discharge upon fire detection to avoid accidental release of the suppression gas. It may also be referred to as a voting system. (Nolan, 2000)

cross-zone analysis—the analysis of a potential fire scenario involving fire propagation between adjacent fire zones.

cryogenic gas—a refrigerated, liquid gas having a boiling point below -90 °C (-130 °F) at atmospheric pressure. (NFC Online Glossary)

current licensing basis (CLB)—the set of NRC requirements applicable to a specific plant and a licensee's written commitments for ensuring compliance with and operation within applicable NRC requirements and the plant-specific design basis (including all modifications and additions to such commitments over the life of the license) that are docketed and in effect. The CLB includes the NRC regulations contained in 10 CFR Parts 2, 19, 20, 21, 26, 30, 40, 50, 51, 54, 55, 70, 72, 73, 100 and appendices thereto; orders; license conditions; exemptions; and technical specifications. It also includes the plant-specific design-basis information defined in 10 CFR 50.2 as documented in the most recent final safety analysis report (FSAR) as required by 10 CFR 50.71 and the licensee's commitments remaining in effect that were made in docketed licensing correspondence such as licensee responses to NRC bulletins, generic letters, and enforcement actions, as well as licensee commitments documented in NRC safety evaluations or licensee event reports. (10 CFR 54.3) *See also:* Regulatory Guide 1.189.

curtain wall—an exterior wall non-load bearing prefabricated wall, usually more than one story high supported by the structural frame, which protects the building's interior from weather, noise, or fire.

damper, fire—a device (damper) arranged to seal off airflow automatically through part of an air distribution system to resist the passage of heat and flame. It is usually an assembly of louvers arranged to close from the heat of a fire by melting a fusible link or through a remote activation signal. Fire dampers are required by all building codes to maintain the required level of fire resistance rating for walls, partitions, and floors when they are penetrated by air ducts or other ventilation openings. There are two significant ratings when applying a fire damper; the fire resistance rating and the airflow closure rating. The fire rating is dependent on meeting the fire resistant rating of the fire barrier being penetrated by the airflow duct and the airflow rating is either static or dynamic, depending on whether the air flow is automatically shut down upon fire detection. (NFC Online Glossary)

damper, smoke—a damper arranged to restrict the spread of smoke in a heating, ventilation and air conditioning (HVAC) air duct system. It is designed to automatically shut off air movement in the event of a fire. It is usually applied in a Passive Smoke Control System or as part of an Engineered Smoke Control System to control the movement of smoke within a building when the HVAC is operational in an engineered smoke control system. HVAC control fans are used to create pressure differences in conjunction with fixed barriers (walls and floors). Higher pressures surround the fire area and prevent the spread of smoke from the fire zone into other areas of the building. A smoke damper also can be a standard louvered damper serving other control functions, provided the location lends itself to the dual purpose. A smoke damper is not required to meet all the design functions of a fire damper. Smoke dampers are classified according to leakage rates: Class 1 (lowest), 2, 3, and 4 (highest); elevated temperature 250 °F (121 °C), 350 °F (177 °C) or higher; and prescribed pressure and velocity differences at the damper (specific velocity of airflow when open and to close against a specific pressure differential). (NFC Online Glossary)

dead end—a corridor, hallway, or passageway open to a corridor that can be entered from the exit access without passage through a door, but which does not lead to an exit.

dedicated smoke control systems—systems that are intended for the purpose of smoke control only. They are separate systems of air moving and distribution equipment that do not function under normal building operating conditions. Upon activation, these systems operate specifically to perform the smoke control function.

dedicated shutdown—the ability to shut down the reactor and maintain shutdown conditions using structures, systems, or components dedicated to the purpose of accomplishing post-fire safe shutdown functions. (Regulatory Guide 1.189)

deep-seated fire—a deep-seated fire occurs when the burning solid material (e.g., cable) is not just a surface burning phenomena but pyrolysing beneath the surface. This is postulated to occur when the cable fire has reached the stage of a fully developed fire. Extinguishment of a surface does not guarantee a deep-seated fire may also be eliminated. Extinguishment of deep-seated fires requires an individual to investigate the interior of a material once the surface fire has been extinguished to determine if interior extinguishment has also been accomplished. If a deep-seated fire in an enclosed area is to be extinguished by a gaseous agent, the period of agent concentration has to be adequate to ensure suppression has been accomplished.

deep-seated fire—a deep-seated fires may become established beneath the surface of fibrous or particulate material. This condition may result from flaming combustion at the surface or from the ignition within the mass of fuel. Smoldering combustion then progresses slowly through the mass. A fire of this kind is referred to in this standard as a “deep-seated” fire. The burning rate of these fires can be reduced by the presence of Halon 1301, and they may be extinguished if a high concentration can be maintained for an adequate soaking time. However, it is not normally practical to maintain a sufficient concentration of Halon 1301 for a sufficient time to extinguish deep-seated fires.

defense-in-depth—a principle aimed at providing a high degree of fire protection by achieving a balance of (a) preventing fires from starting (b) detecting fires quickly and suppressing those fires that occur, thereby limiting damage; and (c) designing the plant to limit the consequences of fire to life, property, environment, continuity of plant operation, and safe shutdown capability. It is recognized that, independently, no one of these items is complete in itself. Strengthening any item can compensate for weaknesses, known or unknown, in the other items.

deflagration—mechanism for the propagation of an explosion reaction through a flammable gas mixture that is thermal in nature. The velocity of the reaction is always less than the speed of sound in the mixture but is capable of causing damage. A deflagration is possible if a gases concentration rises above its lower flammability limit (LFL). (Nolan, 2000)

deflagration pressure containment—the technique of specifying the design pressure of a vessel and its appurtenances so they are capable of withstanding the maximum pressure resulting from an internal deflagration. (Nolan, 2000)

deflagration suppression—the technique of detecting and arresting combustion in a confined space while the combustion is still in its incipient stage, thus preventing the development of pressure that could result in an explosion. (Nolan, 2000)

deluge—the immediate release of a commodity, usually referring to a water spray release for fire suppression purposes. (Nolan, 2000)

deluge sprinkler system—a system that uses open sprinklers or nozzles so that all flow water is discharged when the deluge valve actuates.

deluge water mist system—water mist system with open nozzles that discharge water mist simultaneously from all nozzles on the system.

density—the property of a substance which is expressed by the ratio of its mass to its volume.

design fire curve—an engineering description of the development of a fire for use in a design fire scenario. Design fire curves might be described in terms of heat release rate versus time.

design fire scenario—a set of conditions that defines or describe the critical factors for determining outcomes of trial designs.

detonation—propagation of a combustion zone at a velocity that is greater than the speed of sound in the un-reacted medium. (NFC Online Glossary)

developing fire—the early stage of growth (in a compartment fire) before flashover and full involvement.

diffusion—process of species transport in a mixture from its high to low concentration.

diffusion flame—a flame in which the fuel and oxygen are transported (diffused) from opposite sides of the reaction zone (flame). (Nolan, 2000)

dimensionless—having no units of measure (terms combine to produce no units).

draft curtains—barriers suspended from the roof of a structure to limit the spread of smoke.

dry chemicals—a powder composed of very small particles, usually sodium bicarbonate, potassium bicarbonate, or ammonium phosphate-based with added particulate supplemented by special treatment to provide resistance to packing, resistance to moisture absorption (caking), and the proper flow capabilities. (NFC Online Glossary)

Early Suppression Fast Response (ESFR) sprinkler—an automatic fire sprinkler designed to activate quickly from fire conditions. ESFR sprinklers have a thermal element with a response time index (RTI) of 50 (meters-seconds)^{1/2} or less. Standard sprinklers have a thermal element with an RTI of 80 (meters-seconds)^{1/2} or more. ESFR sprinklers are used for special high hazard applications. Large drop ESFR sprinklers are specifically designed for wet pipe sprinkler systems protecting high-piled storage commodity applications. They were developed by the Factory Mutual Research Corporation (FMRC) in the late 1970s and early 1980s. (Nolan, 2000)

egress—a way out or exit. (NFC Online Glossary)

electrical fire—a fire involving energized electrical equipment. They are usually propagated by electrical short circuits, faults, arcs, and sparks, and the equipment remains energized during the fire event. Due to the possibility of electrical shock, nonconductive extinguishing agents, Class C (carbon dioxide), must be used for fire control and suppression efforts. When the equipment is de-energized, Class A or B extinguishing agents may be used. (Nolan, 2000)

ember—a particle of solid material that emits radiant energy due to its temperature or the process of combustion on its surface. (NFC Online Glossary)

emergency voice/alarm communication system—a system that provides dedicated manual or automatic, or both, facilities for originating and distributing voice instructions, as well as alert and evacuation signals pertaining to a fire emergency to the occupants of a building. (NFC Online Glossary)

emissivity—the ratio of radiant energy emitted by a surface to that emitted by a black body of the same temperature (the property (0 to 1) that gives the fraction of being a perfect radiator).

emissive power—the total radiative power discharged from the surface of a fire per unit area (also referred to as surface emissive power).

emissive power—the rate at which radiant energy is emitted by unit surface area of an object.

energy—a state of matter representative of its ability to do work or transfer heat.

energy balance—three modes of heat transfer (i.e., conduction, convection, and radiation) can be combined by adding gains and losses to determine the temperature at some point. This combination of energy gains and energy losses is called an energy balance. The exact form of the energy balance will differ for each situation evaluated.

entrainment—the process of air or gases being drawn into a fire, plume, or jet.

equivalent length—a length of pipe of a given diameter whose friction loss is equivalent to the friction loss of a pipe of differing diameter.

equivalent fitting length—a length of straight pipe that has the same friction loss as a fitting where the water changes direction.

evaporation—the process of gas molecules escaping from the surface of a liquid.

exit—the portion of the means of egress that leads from the interior of a building or structure to the outside at ground level, or an area of refuge. (NFC Online Glossary)

exit access—any portion of an evacuation path that leads to an exit. (NFC Online Glossary)

exit discharge—that portion of a means of egress between the termination of the exit and the exterior of the building at ground level. (NFC Online Glossary)

explosion—a sudden violent expansion or production of gases which may be accompanied by heat, shock waves, and the disruption or enclosing of nearby structural materials.

exposed (cables/circuits/equipment/structures)—structures, systems and components (SSCs), that are subject to the effects of fire and/or fire suppression activities.

exposed (cables/circuits/equipment/structures)—SSC not provided with fire protection features sufficient to satisfy Section III.G.2 of Appendix R or Position C.5.b of SRP 9.5.1.

exposure fire—a fire in a given area that involves either in situ or transient combustibles and is external to any structures, systems, and components located in or adjacent to that same area. The effects of such fire (e.g., smoke, heat, or ignition) can adversely affect those structures, systems, and components important to safety. Thus, a fire involving one success path of safe shutdown equipment may constitute an exposure fire for the redundant success path located in the same area, and a fire involving combustibles other than either redundant success path may constitute an exposure fire to both redundant trains in the same area. (Regulatory Guide 1.189)

exposure hazard—a structure at a location (15.24 m (50 ft) of another building and 9.3 m² (100 ft²) or larger in area.

extinguish—to cause a material to cease burning; to completely control a fire so that no abnormal heat of smoke remains, or to cause to cease burning, or completely put out a fire. (Nolan, 2000)

extinguish—to cause a material to cease burning; to completely control a fire so that no abnormal heat or smoke remains. Fire extinguishment may be obtained by several methods: cooling, oxygen depletion or removal, inhibition of chemical reaction, and flame removal (blowout).

extinguisher rating—the numerical rating given to an extinguisher which indicates the extinguishing potential of the unit based on standardized tests developed by Underwriters' Laboratories, Inc.

Extra Large Orifice (ELO) sprinkler—a fire suppression sprinkler for automatic sprinkler systems that has an orifice size of 0.675 in. (1.59 cm). Standard sprinklers have an orifice size of 0.5 in. (1.27 cm). ELO sprinklers are used for hazards requiring a higher density of water application such as those with a high fuel loading. (Nolan, 2000)

failsafe circuits—circuits designed in such a way that fire-induced faults will result in logic actuation(s) to a desired, safe, mode which can not be overridden by any subsequent circuit failures.

failure mode—the action of a device or system to revert to a specified state upon failure of the utility power source that normally activates or controls the device or system. Failure modes are normally specified as fail open (FO), fail closed (FC), or fail steady (FS) which will result is a fail to danger arrangement.

fault—any undesired state of a component or system. A fault does not necessarily require failure (for example, a pump may not start when required because its feeder breaker was inadvertently left open. (IEEE Std. 100-1988)

fault—a partial or total local failure in the insulation or continuity of a conductor. (IEEE Std. 100-1988)

fault—a physical condition that causes a device, a component or an element to fail to perform in a required manner, for example a short-circuit, a broken wire, an intermittent connection. (IEEE Std.100-1988)

fault current—a current that flows from one conductor to ground or another conductor owing to an abnormal connection (including an arc) between the two. (IEEE Std. 100-1988)

fault current—a current that results from the loss of insulation between conductors or between a conductor and ground. (NEMA Std. ICS-1, 1988)

fire—the process of an advancing fire front: smoldering or flaming or an uncontrolled chemical reaction producing light and sufficient energy.

fire—a processing entailing rapid oxidative, exothermic reactions in which part of the released energy sustains the process.

fire—a rapid oxidation process with the evolution of light and heat in varying intensities. (NFC Online Glossary)

firebrand—a flaming or smoldering airborne object emerging from a fire, which can sometimes ignite remote combustibles.

fire area—the portion of a building or plant that is separated from other areas by rated fire barriers adequate for the fire hazards. (Regulatory Guide 1.189)

fire area boundaries—the term "fire area" as used in Appendix R means an area sufficiently bounded to withstand the hazards associated with the area and, as necessary, to protect important equipment within the area from a fire outside the area. In order to meet the regulation, fire area boundaries need not be completely sealed floor-to-ceiling, wall-to-wall boundaries. However, all unsealed openings should be identified and considered the evaluating the effectiveness of the overall barrier. Where fire area boundaries are not wall-to-wall, floor-to-ceiling boundaries with all penetrations sealed to the fire rating required of the boundaries, licensees must perform an evaluation to assess the adequacy of fire boundaries in their plants to determine if the boundaries will withstand the hazards associated with the area. This analysis must be performed by at least a fire protection engineer and, if required, a systems engineer.
(Generic Letter 86-10)

fire ball—a burning fuel-air cloud whose energy is emitted primarily in the form of radiant heat. The inner core of the cloud consists almost completely of fuel, whereas the outer layer (where ignition first occurs) consists of a flammable fuel-air mixture. As the buoyancy forces of hot gases increases, the burning cloud tends to rise, expand, and assume a spherical shape.

fire barrier—components of construction (wall, floor, and their supports), including beams, joists, columns, penetration seals or closures, fire doors, and fire dampers that are rated by approving laboratories in hours of resistance to fire, that are used to prevent the spread of fire.

fire characteristics—a set of data that provides a description of a fire.

fire control—limiting the size of a fire by distribution of water so as to decrease the heat release rate and pre-wet adjacent combustibles, while controlling ceiling gas temperatures to avoid structural damage. (NFC Online Glossary)

fire control—the stage of firefighting whereby a fire incident is controlled and not allowed to escalate in magnitude. Following fire control, suppression or extinction of the fire incident will occur. Fire control limits the growth of a fire by pre-wetting adjacent combustibles and controlling ceiling gas temperatures to prevent structural damage.

fire department connection—device that allows the fire department to pump water into a fire protection system from their trucks.

fire dynamics—fire dynamics is the scientific description of fire phenomena (e.g., ignition, flame spread, burning, smoke spread) in quantitative terms. It encompasses chemistry, physics, mathematics, fluid mechanics as well as heat and mass transfer.

fire dynamics—the interaction among the complex phenomena involved in a building fire.

fire endurance—the length of time that a structural element can resist fire either up to the point of collapse, or alternatively, to the point when the deflection reaches a limiting value. (Nolan, 2000)

fire extinguishment—the complete suppression of a fire until there are no burning combustibles material. (NFC Online Glossary)

fire extinguisher rating—a rating set forth in NFPA 10, Standard for Portable Fire Extinguishers. This rating is identified on an extinguisher by number (e.g., 5, 20, 70), indicating relative effectiveness, followed by a letter (e.g., A, B, C, or D) indicating the class or classes of fires for which the extinguisher has been found to be effective. (NFC Online Glossary)

fire-fighting foam—a fire fighting medium that is created by adding a foaming agent to a liquid (usually water).

fire growth potential—the potential size or intensity of a fire over a period of time based on the available fuel and the fire's configuration. (NFC Online Glossary)

fire growth rate—rate of change of the heat release rate. Some factors that affect the fire growth rate are exposure, geometry, flame spread, and fire barrier. (NFC Online Glossary)

fire hazard—the existence of conditions that involve the necessary elements to initiate and support combustion, including in situ or transient combustible materials, ignition sources (e.g., heat, sparks, open flame), and an oxygen environment.

fire hazard analysis—an analysis used to evaluate the capability of a nuclear power plant to perform safe shutdown functions and minimize radioactive releases to the environment in the event of a fire. The analysis includes the following features (Regulatory Guide 1.189):

- Identification of fixed and transient fire hazards.
- Identification and evaluation of fire prevention and protection measures relative to the identified hazards.
- Evaluation of the impact of fire in any plant area on the ability to safely shutdown the reactor and maintain shutdown conditions, as well as to minimize and control the release of radioactive material.

fire hazard analysis—a comprehensive assessment of the potential for a fire at any location to ensure that the possibility of injury to people or damage to buildings, equipment, or the environment is within acceptable limits. (NFC Online Glossary)

fire hydraulic—term for the science or study of water in motion (fluid mechanics) as applied to fire protection application (firefighting, fire suppression, fixed water-based suppression systems etc.)

fire hydrant—a device that provides a water supply to fire department pumpers for use in combating structure fires.

fire growth rate—the periodic increase in a fire, dependent on the ignition process, flame spread, and mass burning rate over the area involved.

fire-induced fault—an electrical failure mode (e.g., hot short, open circuit, or short to ground) that may result from circuit/cable exposure to the effects of fire (e.g., heat and smoke) and/or subsequent fire suppression activities (e.g., water spray, hose streams).

fire-induced vulnerability evaluation (FIVE)—five is a semi-quantitative method of fire risk and hazard analysis for screening purposes. The methodology has been used to perform risk-based fire-induced vulnerability evaluations for NPPs. This technique was developed by the Electric

Power Research Institute (EPRI) under the guidance of the Severe Accident Working Group of the Nuclear Management and Resources Council (NUMARC) and the industry's experts, for the purpose of addressing the fire portion of licensee's IPEEE studies.

fire load—the fire load for an enclosure is a measure of the total energy released by the combustion of all combustible materials in the enclosure. It is assigned the symbol W , and is given in joules (J).

fire loading—the amount of combustible present in a given area, expressed in kJ/m^2 (Btu/ft^2). (NFC Online Glossary)

fire load density—the fire load density is the fire load per unit area. The fire load density is assigned the symbol Q'' and is given in J/m^2 . Some times the fire load is given is per unit floor area of the enclosure or some times in terms of the total enclosure surface area.

fire model—a physical or mathematical procedure that incorporates engineering and scientific principles in the analysis of fire and fire effects to simulate or predict fire characteristics and conditions of the fire environment.

fire modeling—fire modeling can normally be considered as the predication of fire characteristics by the use of a mathematical method which is expressed as a computer program.

fire performance—the response of a material or product to a source of heat or flame under controlled fire conditions. Fire performance includes: ease of ignition, flame spread, smoke generation, fire resistance and toxicity of smoke.

fire plume—a buoyant column of fire gases and smoke rising above, usually with flames in the lower portion. In a confined area a fire plume rises almost vertically. In an outside, unconfined area the configuration of a fire plume is affected by ambient conditions (wind, temperature etc.)

fire point—the minimum temperature to which a liquid must be heated in a standardized apparatus, so that sustained combustion results when a small pilot flame is applied, as long as the liquid is at normal atmospheric pressure.

fire point—the lowest temperature at which flaming can be sustained at the liquid's surface.

fireproofing—a common industry term used to denote materials or methods of construction that provide fire resistance for a defined fire exposure and specific time.

fireproof—common trade name for materials used to provide resistance to a fire exposure. Essentially nothing is fireproof, but some materials are resistant to effects of fire (heat flame etc.) for limited periods.

fire prevention code—a set of requirements intended to ensure that, following construction, building, buildings are equipped, operated and maintained to provide an acceptable level of protection from potential hazards created by fires or explosions.

fire prevention research engineer—conducts research to determine cause and methods of preventing fires and prepares educational materials concerning fire prevention for insurance

companies, performing duties as described under Research Engineer. ("Dictionary of Occupational Titles," Volume 1, 14th Edition, U.S. Department of Labor Employment and Training Administration, 1991.)

fire protection engineer—advises and assists private and public organization and military services for purpose of safeguarding life and property against fire, explosion, and related hazards. Make studies of industrial, mercantile. And public buildings, homes, and other property before and after construction, considering factors, such as fire resistance of construction, usage or contents of buildings, water supplies and water delivery, and egress facilities. Designs or recommends materials or equipment, such as structural components protection, fire detection equipment, alarm systems, fire extinguishing devices and systems, and advises on location, handling, installation, and maintenance. Recommends materials, equipment, or methods for alleviation of conditions conducive to fire. Devices fire protection programs, and organizes and trains personnel to carry out such programs. May evaluate fire departments and adequacy of laws, ordinances, and regulations affecting fire prevention or fire safety. Conducts research and test on fire retardants and fire safety of materials and devices and to determine fire causes and methods of fire prevention. May determine fire causes and methods of fire prevention. May teach courses on fire prevention and protection at accredited educational institutions. May advise and plan for prevention of destruction by fire, wind, water, or other causes of damage. ("Dictionary of Occupational Titles," Volume 1, 14th Edition, U.S. Department of Labor Employment and Training Administration, 1991.)

fire protection rating—a designation of fire resistance duration for a material or assembly when exposed to standard test conditions, having met all acceptance criteria. (Nolan, 2000)

fire resistance—the ability of an element of building construction, component, or structure to fulfill, for a stated period of time, the required load-bearing functions, integrity, thermal insulation, or other expected duty specified in a standard fire-resistance test.

fire resistive construction—construction in which the structural members, including walls, columns, floors, and roofs are noncombustible or limited-combustible materials, and have fire resistance rating not less than those specified in NFPA 220; fire resistive construction has more ability to resist structural damage from fire than any other construction type.

fire retardant coating—a coating that reduces that flame spread of combustible materials surfaces to which it is applied, by at least 50 percent or to a flame spread classification value of 75 or less, whichever is the lesser value, and smoke developed rating not exceeding 200. (Nolan, 2000)

fire retardant material—means materials that has been coated or treated with chemical, paints, or other materials that designed to reduce the combustibility of the treated material. The retardants are intended to make the material ignite less readily or burn more slowly, once ignited.

fire risk—refers to the combination of the probability of a given fire event occurring and the estimated consequences of the event should it occur. (Regulatory Guide 1.189)

fire rated cable—electrical cable with a fire resistance rating on maintaining functionality when exposed to fire tests.

fire-resistant cable—electrical cable that has been tested and found resistant to the spread of flames.

fire resistance rating—the time that a particular construction will withstand a standard fire exposure in hours as determined by ASTM E119.

fire resistance rating—the time that materials or assemblies have withstood a fire exposure as established in accordance with the test procedures of NFPA 251 and ASTM E119.
(Regulatory Guide 1.189)

fire pump—a device that provides the required water flow and pressure for a fire protection system.

fire scenario—a set of conditions that defines the development of fire and the spread of combustion products throughout a building or part of a building.

fire separation—a fire-resistive barrier to restrict the spread of fire, provided in a horizontal or vertical orientation.

fire severity—the maximum effects that can be caused by a fire event. Usually described in terms of temperature and duration, and may be used to describe the potential for fire destruction for a particular location. The rate of heat release has also been accepted as a guide of fire severity.
(Nolan, 2000)

fire signature—a property of fire (temperature, smoke concentration, etc.) that is used to detect the presence of fire.

fire spread—the process of an advancing flame front through smoldering or flaming.

fire stop—a feature to the construction that prevents fire propagation along the length of cables or prevents spreading of fire to nearby combustibles within a given fire area or fire zone.

fire suppression—control and extinguishing of fire (fire-fighting). Manual fire suppression is the use of hoses, portable extinguishers, or manually actuated fixed systems by plant personnel. Automatic fire suppression is the use of automatically actuated systems such as water, Halon, or carbon dioxide systems (Regulatory Guide 1.189). Firefighting activity concerned with controlling and reducing a fire prior to its actual extinguishment. Fire suppression is generally taken as the sharp reduction of the rate of heat release of a fire and the prevention of its growth. Fire extinguishment activities encompass the actual direct fire extinction process.

fire suppression—all the work of confining and extinguishing wildland fires.
(NFC Online Glossary)

fire suppression—sharply reducing the heat release rate of a fire and preventing its regrowth by means of direct and sufficient application of water through the fire plume to the burning fuel surface. (NFC Online Glossary)

fire suppression—the activities involved in controlling and extinguishing fires. Fire suppression shall include all activities performed at the scene of a fire incident or training exercise that expose fire department members to the dangers of heat, flame, smoke, and other products of combustion, explosion, or structural collapse. (NFC Online Glossary)

fire suppression—control and extinguishing of fires (firefighting). Manual fire suppression employs the use of hoses, portable extinguishers, or manually actuated fixed systems by plant personnel. Automatic fire suppression is the use of automatically actuated fixed systems such as water, Halon, or carbon dioxide systems.
(Regulatory Guide 1.189).

fire suppression—actions taken with the intent to control the growth of a fire.

fire suppression impacts—the susceptibility of structures, systems and components and operations response to suppressant damage (due to discharge or rupture) (NFPA 805).

fire triangle—a concept describing fire as consisting of three ingredients: fuel, oxygen, and energy.

fire tetrahedron—a schematic representation of fire in which the four elements required to initiate and maintain fire (fuel, oxidant, heat and chain reactions) are depicted as the four corners of a tetrahedron.

fire watch—individuals responsible for providing additional (e.g., during hot work) or compensatory (e.g., for system impairments) coverage of plant activities or areas for the purposes of detecting fires or for identifying activities and conditions that present fire hazard. The individuals should be trained in identifying conditions or activities that present potential fire hazards, as well as the use of fire extinguishers and the proper notification procedures. (Regulatory Guide 1.189)

fire zones—a subdivisions of fire areas (Regulatory Guide 1.189)

fixed fire suppression system—a total flooding or local application system consisting of a fixed supply of extinguishing agent permanently connected for fixed agent distribution to fixed nozzles that are arranged to discharged an extinguishing agent in an enclosure (total flooding), directly onto a hazard (local application), or a combination of both; or an automatic sprinkler system.
(NFC Online Glossary)

fixed fire suppression system—a fire suppression system that provides local application, area coverage, or total flooding protection. It consists of a fixed supply of extinguishing agent, permanently connected distribution piping, and fixed nozzles that are arranged to discharge an extinguishing agent into an enclosure (total flooding), directly onto a hazard (local application), over an entire area (area coverage), or a combination of application.

FIVE—a fire-induced vulnerability evaluation - a quantitative screening technique sponsored by EPRI under the guidance of the Severe Accident Working Group of the Nuclear Management and Resources Council (NUMARC) and the industry's experts, for the purpose of addressing the fire portion of licensees' IPEEE studies.

fire PRA methodology—the set of procedures, based on probabilistic risk analysis, for estimating core damage frequency due to fire events.

fire zones—subdivisions of fire areas.

flare—a flame condition of a fire in which burning occurs with an unsteady flame.

flame arrester—a device installed in a pipe or duct to prevent the passage of smoke.

flame arrester—a device that prevents the transmission of a flame through a flammable gas/air mixture by quenching the flame on the surface of an array of small passages through which the flame must pass. The emerging gases are sufficiently cooled to prevent ignition on the protected side. (NFC Online Glossary)

flame burning velocity—the burning velocity of a laminar flame under stated conditions of composition, temperature, and pressure of the unburned gas. (NFC Online Glossary)

flame detector—a detector that is activated by electromagnetic radiation emitted by flames.

flame height—the vertical measurement of the combustion region.

flame speed—the speed of a flame front relative to a fixed reference point. It is dependent on the turbulence, the equipment geometry, and the fundamental burning velocity.

flame spread—the increase in the perimeter of a fire. Flame spread depends on orientation and the surrounding fluid flow. It can be associated with solids, liquids, forest fuels, smoldering, and gas-phase propagation for premixed systems. Flame spread is influenced by gravity (flame buoyancy) and wind effects.

Relative flame spread speeds are indicated below (Nolan, 2000):

| <u>Phenomenon</u> | <u>Speed (cm/sec)</u> |
|--|------------------------|
| smoldering | 10^{-3} to 10^{-2} |
| downward or horizontal spread (thick solids) | 10^{-1} |
| upward spread (thick solids) | 1 to 10^2 |
| wind-driven spread through forest debris | 1 to 30 |
| horizontal spread on liquids | 1 to 10^2 |
| laminar deflagration | 10 to 10^2 |
| detonation | $\sim 10^5$ |

flame spread index—a relative performance of fire travel over the surface of a material when tested in accordance with the provisions of NFPA 255, Standard method of Test of Surface Burning Characteristics of Building Materials. (Nolan, 2000)

flame spread rating—flame spread rating is a numerical classification determined by the test method ASTM E84, which indexes the relative burning behavior of a material by quantifying the spread of flame of at test specimen. The surface burning characteristic of a material is not a measure of resistance to fire exposure. (NFC Online Glossary)

flammable limits—the minimum and maximum concentration of combustible material in a homogeneous mixture with a gaseous oxidizer that will propagate a flame.

flammable—capable of being ignited.

flammable liquid—as defined by the most fire safety codes (NFPA 30, "Flammable Combustible Liquids Code"), generally a flammable liquid is any liquid that has a closed-cup flash point below

37.8 °C (100 °F). Flash points are determined by procedures and apparatus set forth in ASTM D56, "Standard Method of Test for Flash Point by the Tag Closed Tester".

Class I Flammable Liquid—any liquid that has a defined closed-cup flash point below 37.8 °C (100 °F) and a Reid vapor pressure not exceeding 40 psi (2,068.6 mm Hg) at 37.8 °C (100 °F), as determined by the ASTM D323, "Standard Method of Test for Vapor Pressure of Petroleum Products (Reid Method)".

Class I liquids are further sub-classified into A and B as follows:

Class IA flammable liquids—liquids that have a defined flash point below 22.8 °C (73 °F) and boiling points below 37.7 °C (100 °F).

Class IB flammable liquids—liquids that have a defined flash point below 22.8 °C (73 °F) and boiling points at or above 37.7 °C (100 °F).

Class II flammable liquids—any liquid that has a flash point at or above 37.8 °F (100 °F) and below 60 °C (140 °F).

Class IIIA flammable liquids—any liquid that has a flash point at or 60 °C (140 °F), but below 93 °C (200 °F).

Class IIIB flammable liquids—any liquid that has a flash point at or 93 °C (200 °F).

flame temperature—most open flames of any type produce a flame temperature in the region of 1,093 °C (2,000 °F). The hottest burning substance is carbon subnitride (C_4N_2), which at one atmospheric pressure can produce a flame calculated to reach 4,988 °C (9,010 °F). (Nolan, 2000)

flash—a quick spreading flame or momentary intense outburst of radiant heat. It may also be used to refer to a spark or intense light of short duration.

flash fire—a fire that spreads rapidly through a diffuse fuel, such as dust, gas, or the vapors of an ignitable liquid, without the production of damaging pressure. (NFC Online Glossary)

flash point—the minimum temperature to which a liquid must be heated in a standardize apparatus, so that a transient flame moves over the liquid when a small pilot flame is applied. (NFC Online Glossary)

flash point—the flash point of a liquid is the temperature at which the vapor and air mixture laying just above its vaporizing surface is capable of just supporting a momentary flashing propagation of a flame prompted by a quick sweep of small gas pilot flame near its surface, hence the term flash point. The flash point is mainly applied to a liquid. The flash point of liquid is one of its characteristics that normally determines the amount of fire safety features requires for its handling, storage and transport.

flashover—the transition from fire growth period to the full developed stage in the enclosure fire development that is the demarcation point between two stages of a compartment fire, pre-flashover and post-flashover. Flashover is a phenomenon which defines the point in a compartment fire

where all combustibles in the compartment are involved and flames appears to fill the entire volume. Gas temperatures of 300 to 650 °C (572 to 1,202 °F) have been associated with the onset of flashover, although temperatures of 500 to 600 °C (932 to 1,112 °F) are more widely used.

flashover—when a fire in a compartment is allowed to grow without intervention, assuming sufficient fuel in the burning item, temperatures in the hot upper layer will increase, with increasing radiant heat flux to all objects in the room. If a critical level of heat flux is reached, all exposed combustible items in the room will begin to burn, leading to a rapid increase in both heat release rate and temperatures. This transition is "flashover". The fire is then referred to as "post-flashover fire", a "fully developed fire" or a fire which has reached "full room involvement".

flashover—the formal definition of flashover, from International Standards Organization (ISO), is given as, "the rapid transition to a state of total surface involvement in a fire of combustion material within an enclosure". Flashover is the term given to the relatively abrupt change from a localized fire to the complete involvement of all combustibles within a compartment. This is from ISO, "Glossary of Fire Terms and Definitions," ISO/CD 13943, International Standards Organization, Geneva, 1996.

flash vaporization—the instantaneous vaporization of some or all a liquid whose temperature is above its atmospheric boiling point when its pressure is suddenly reduced to atmosphere.

flow hydrant—a hydrant selected to measure the water flow available from the water supply.

flux—pertains to mass or heat flow rates per unit area.

forced flow—refers to air flow produced by wind or a fan.

free-burning—burning in open-air.

free of fire damage—the structure, system, or component under consideration is capable of performing its intended function during and after the postulated fire, as needed without repair (Regulatory Guide 1.189). In promulgating Appendix R, the Commission has provided methods acceptable for assuring that necessary structures, systems and components are free of fire damage (see Section III.G.2a, b and c), that is, the structure, system or component under consideration is capable of performing its intended function during and after the postulated fire, as needed. Licensees seeking exemptions from Section III.G.2 must show that the alternative proposed provides reasonable assurance that this criterion is met. The term "damage by fire" also includes damage to equipment from the normal or inadvertent operation of fire suppression systems. (Generic Letter 86-10).

Note: Section III.G.2 of Appendix R and Position C.5.b of SRP 9.5.1 establish fire protection features necessary to ensure that systems needed to achieve and maintain hot shutdown conditions remain free of fire damage.

fuel-controlled or fuel-limited fire—after ignition and during the initial fire growth stage, the fire is said to be fuel-controlled, since in the initial stages there is sufficient oxygen available for combustion and the growth of the fire entirely depends on the characteristics of the fuel and its geometry. The fire can also be fuel-controlled in later stages.

fuel lean—description of fuel burning in an excess supply of air.

fuel-limited—state of a compartment fire where the air supply is sufficient to maintain combustion.

fully developed—state of a compartment fire during which the flames fill the room involving all the combustibles, or the state of maximum possible energy release in a room fire.

fundamental burning velocity—the burning velocity of a laminar flame under stated conditions of composition, temperature, and pressure of the unburned gas.

fuse—a device that protects a circuit by fusing open its current responsive element when an overcurrent or short-circuit current passes through it. (IEEE Std. 100-1988).

fuse—a protective device that opens by the melting of a current-sensitive element during specified overcurrent conditions (NEMA Std. FU-1 1986).

fuse current rating—the ac or dc ampere rating which the fuse is capable of carrying continuously under specified conditions. (NEMA Std. FU-1 1986)

fuse voltage rating—the maximum rms ac voltage or the maximum dc voltage at which the fuse is designed to operate. (NEMA Std. FU-1 1986)

fusible link—a system of levers and links held together with a metal alloy which melts at a predetermined temperature.

fusible link—a connecting link of a low-melting alloy that holds an automatic sprinkler head in the closed position and melts at a predetermined temperature; it may also be used to hold a fire door or fire damper in the open position.

gas combustible—gas that is capable of being ignited and burned, such as hydrogen, methane, propane, etc.

gas sensing detector—a detector activates when a critical concentration of some gaseous product of combustion is reached.

generic issue (GI)—a concern that may affect the design, construction, or operation of all, several, or a class of nuclear power plants, which either does not affect safe operation of the plant or the safety significance of the issue has not yet been determined.

generic safety issue (GSI)—according to the NUREG-0933, "A Prioritization of Generic Safety Issues," a GSI is a safety concern that may affect the design, construction, or operation of all, several, or a class of nuclear power plants, and may have the potential for safety improvements and promulgation of new or revised requirements or guidance.

glove box—a sealed enclosure in which items inside the box are handled exclusively using long rubber or neoprene gloves sealed to ports in the walls of the enclosure. The operator places his or her hands and forearms into the gloves from the room outside of the box in order to maintain physical separated from the glove box environment. This allows the operator to retain the ability to manipulate items inside the box with relative freedom while viewing the operation through a window. (NFC Online Glossary)

glowing combustion—luminous burning of solid material without a visible flame. A stage in the ignition of a solid material that occurs before sufficient volatile fuel has evolved to sustain a gas-phase flame. (NFC Online Glossary)

gravity—the force of mutual attraction between masses.

gravity—the force that causes a body to accelerate while falling, usually expressed as 32.2 ft/sec² (9.81 m/sec²).

ground—a conducting connection, whether intentional or accidental, by which an electric circuit or equipment is connected to the earth, or to some conducting body of relatively large extent that serves in place of the earth. (IEEE Std. 100-1988)

grounded circuit—a circuit in which one conductor or point (usually the neutral conductor or neutral point of transformer or generator windings) is intentionally grounded, either solidly or through a non-interrupting current limiting grounding device. (IEEE Std.100-1988)

Halon—any one of several halogenated hydrocarbon compounds, two of which (bromotrifluoromethane and bromochlorodifluoromethane) are commonly used as extinguishing agents; they are inert to almost all chemicals, and resistant to both high and low temperatures.

Halon—as employed in the fire protection industry, a gaseous fire suppression agent. Halon is an acronym for halogenated hydrocarbons, commonly bromotrifluoromethane (Halon 1301) and bromochlorodifluoromethane (Halon 1201). Consider obsolete for fire protection purposes due to a possible environmental impact to the Earth's atmosphere ozone layer and beginning to be phased out or eliminated. In order for a Halon fire suppression system to be an effective fire suppression, the system must:

Provide a very rapid response and be completely discharged while the fire is in its incipient stages, i.e., the fire is still controllable. The system discharge enough of the agent to effectively actively the chemical chain breaking mechanism of the diffusion flame combustion process and that discharge be contained in the area for a long enough period for this to be accomplished.

hazard—a possible source of danger that can initiate or cause undesirable consequences if uncontrolled.

hazard—hazard is a chemical or physical condition that has the potential for causing damage to people, property, or the environment. An example would be flammable liquids or explosive gases or dusts used in the process or in storage.

hazardous material—a substance that, upon release, has the potential of causing harm to people, property, or the environment.

HAZOP—an acronym for the hazard and operability study in which the hazards and operability of a system are identified and analyzed in a systematic manner to determine if adequate safe guards are in place. (Nolan, 2000)

heat—energy transfer due to temperature difference.

heat capacity—the energy that must be added to a unit mass of a substance in order to rise its temperature by 1 °C (34 °F) (as long as no phase change occurs). Also called thermal capacity.

Heat collector plate or Canopy—a covering provided over a heat detector or automatic sprinkler placed in the open, to trap and collect updrafts of heat from a fire incident to aid in its detection or sprinkler activation. They commonly consist of a sheet of steel (Nolan, 2000). Heat collectors were intended to reduce the time a fire takes to activate sprinklers located too far below the ceiling. When sprinklers are too far below the ceiling, most of the heat energy rises past the sprinklers and heat collectors and the sprinklers are not activated. Locating the sprinkler close to the ceiling ensures that the sprinkler will be in the hot gas layer, minimizing activation time and enabling the sprinkler to provide a fully developed water spray pattern to control the fire. In addition, the water from the sprinkler cools the upper gas layer (preventing flashover conditions) and cools the structural steel supports of the compartment boundaries (preventing structural collapse).

heat flux—the rate of heat transfer per unit area that is normal to the direction of heat flow. It is a total of heat transmitted by radiation, conduction, and convection. A radiant heat flux of 1 kW/m² (312.5 Btu/ft²-hr) (that is, direct sunlight) will be felt as pain to exposed skin. A radiant heat of 4 kW/m² (1,250 Btu/ft²-hr) will cause a burn on exposed skin. A heat flux density of 10–20 kW/m² (3,125–6,250 Btu/ft²-hr) may cause objects to ignite, and a heat flux density of 37.8 kW/m² (11,813 Btu/ft²-hr) will cause major damage. Heat flux may also be called heat flow rate. (Nolan, 2000)

heat of combustion—the energy released by the fire per unit mass of fuel burned. (Quintiere, 1998)

heat of condensation—the energy released when a unit mass of vapor condenses to a liquid. (Friedman, 1998)

heat of decomposition—the amount of heat released during a chemical decomposition reaction. (Nolan, 2000)

heat of fusion—the energy absorbed when a unit mass of a solid melts. (Friedman, 1998)

heat of gasification—energy required to produce a unit mass of fuel vapor from a solid or liquid. (Quintiere, 1998)

heat of solidification—the energy released when a unit mass of a liquid solidifies. (Friedman, 1998)

heat of sublimation—the energy absorbed when a unit mass of a solid gasifies directly, without forming a liquid and without chemical change. (Friedman, 1998)

heat of vaporization—the energy absorbed when a unit mass of liquid vaporizes. (Friedman, 1998)

heat release rate—the rate at which heat energy is generated by burning. The heat release rate of a fuel is related to its chemistry, physical form, and availability of oxidant and is expressed as kW (kJ/sec) or Btu/sec. (Nolan, 2000)

heat resistance—the property of a foam to withstand exposure to high heat fluxes without loss of stability. (NFC Online Glossary)

heat transfer—the branch of physics dealing with the calculation of the rate at which thermal energy (heat) moves from a hotter to a cooler region or the transport of energy from a high- to a low-temperature object.

high/low pressure interface—reactor coolant boundary valves whose spurious operation due to fire could: (a) potentially rupture downstream piping on an interfacing system, or (b) result in a loss of reactor coolant inventory in excess of the available makeup capability.

high-impedance fault—an electrical fault of a value that is below the trip point of the breaker on each individual circuit. (Generic Letter 86-10)

high-impedance fault—a circuit fault condition resulting in a short to ground, or conductor to conductor hot short, where residual resistance in the faulted connection maintains the fault current level below the component's circuit breaker long-term setpoint. (Regulatory Guide 1.189)

horizontal exit—an exit from one building to another on approximately the same level; or a passage through or around a rated wall or partition that affords protection from fire or smoke coming from the area from which escape is made. (NFC Online Glossary)

hot short—an electric cable failure mode, resulting from a fire, which involves making an electrical connection between a conductor with power and a conductor that does not currently have power, without a simultaneous short to ground or open-circuit condition. Such failure might, for example, simulate the closing of a control switch, cause errors in an instrument reading, or result in the application of power to an unpowered circuit.

Individual conductors of the same or different cables come in contact with each other and may result in an impressed voltage or current on the circuit being analyzed. (Regulatory Guide 1.189)

Clarification: The term "hot short" is used to describe a specific type of short circuit fault condition between energized and de-energized conductors. Should a de-energized conductor come in electrical contact with an energized conductor (or other external source), the voltage, current or signal being carried by the energized conductor (or source) would be impressed onto one or more of the de-energized conductors

hot work—activities that involve the use of heat, sparks, or open flame such as cutting, welding, and grinding. (Regulatory Guide 1.189)

humidity—the property of the water-air mixture that measure the amount of water present relative to the equilibrium concentration.

hybrid mixture—a mixture of a combustible gas with either a combustible dust or combustible mist.

hyperthermia—heat stress.

hypergolio—property of a material which describes its ability to spontaneously ignite or explode upon contact with an oxidizing agent.

Ignition process—ignition is broadly defined as the initiation of the chemical process of combustion (burning) in any fuel. In most fire protection problems, ignition involves both a heat source and target fuel. A burning wastebasket can be an ignition source for a nearby chair. The burning chair subsequently can be ignition source for another fuel.

In an otherwise free-free environment, the first unwanted burning is the initial ignition, and the initial heat source is called an igniter.

In the environments where gases, vapors, or dust are present, the initial ignition may yield combustion fast enough to generate a pressure or shock wave. This type of sudden over-pressure requires different fire defense than spread from combustible to combustible without a pressure wave.

ignition temperature—the surface temperature needed to cause ignition in solids. (Quintiere, 1998)

ignition temperature—temperature at which an element or compound will catch fire in air (atmospheric oxygen).

impairment—the degradation of a fire protection system or feature that adversely affects the ability to the system or feature to perform its intended function. (Regulatory Guide 1.189)

impulse—a measure that can be used to define the ability of a blast wave to do damage. It is calculated by the integration of the pressure-time curve.

important to safety—nuclear power plant structures, systems, and components "important to safety" are those required to provide reasonable assurance that the facility can be operated without undue risk to the health and safety of the public. (Regulatory Guide 1.189)

incipient stage—refers to the severity of a fire where the progression is in early stage and has not developed beyond that which can be extinguished using portable fire extinguishers or handlines flowing up to 125 gpm (473 L/min). A fire is considered to be beyond the incipient stage when the use of thermal protective clothing or self-contained breathing apparatus is required or an industrial fire brigade member is required to crawl on the ground or floor to stay below smoke and heat. (NFC Online Glossary)

incipient stage fire—a fire which is in the initial or beginning stage and which can be controlled or extinguished by portable fire extinguishers, Class II standpipe or small hose systems without the need for protective clothing or breathing apparatus.

incomplete combustion—a combustion process that does not go the most stable species such as H₂O and CO₂. (Quintiere, 1998)

inflammable—not a permissible word, because it introduces confusion as to whether flammable or nonflammable is meant. (Friedman, 1998)

Inflammable—identical meaning as flammable, however the prefix "in" indicates a negative in many words and can cause confusion, therefore the use of flammable is preferred over inflammable. (Nolan, 2000)

indicating appliance—any audible or visible signal employed to indicate a fire, supervisory, or trouble condition. Example of audible signal appliances are bells, horns, sirens, electronic horns, buzzers, and chimes. A visible indicators consists of a lamp, target, meter deflection, or equivalent.

indicating appliance circuit—a circuit or path directly connected to an indicating deflection, or equivalent.

inert gas—gases, such as carbon dioxide or nitrogen, that will not support combustion.

inert gas agents—an agents that contains one or more inert gases, such as helium, neon, argon, nitrogen, and carbon dioxide. (NFC Online Glossary)

inerting—the process of removing an oxidizer (usually air or oxygen) to prevent a combustion process from occurring normally accomplished by purging.

inerting—adding an agent within an enclosure to reduce a flammable concentration of gas or vapor.

initiating device (appliance)—a manually or automatically operated device, the normal intended operation of which results in a fire alarm or supervisory signal indication from the control unit. Example of alarm signal indicating devices are thermostats, manual boxes, smoke detectors, and water flow switches. Examples of supervisory signal initiating devices are water level indicators sprinklers system, valve position switches, pressure supervisory transmitters, and water temperature switches.

individual plant examination (IPE)—an evaluation to identify any plant-specific vulnerabilities to severe accidents initiated by internal events, including flooding, during full power operation. (Generic Letter 88-20 has requested each licensee of a U.S. power plant to perform such evaluation for its plant(s).

individual plant examination (IPEEE)—an evaluation to identify any plant-specific vulnerabilities to severe accidents initiated by external events during full power operation. (Generic Letter 88-20, Supplement 4, has requested each licensee of a U.S. power plant to perform such evaluation for its plant(s).

internal fire—a fire initiated anywhere within the plant boundaries, including both areas within plant structure and buildings, and contiguous outdoor areas such as the electrical switchyard and transformer areas.

inter-cable fault—a fault between conductors of two or more separate cables.

inter-cable fault—a fault between two or more conductors within a single multi-conductor cable.

Interlock—a device actuated by the operation of some other device with which it is directly associated to govern succeeding operations of the same or allied devices. Note: Interlocks may be either electrical or mechanical. (IEEE Std.100-1988)

interrupting device—a breaker, fuse, or similar device installed in an electrical circuit to isolate the circuit (or a portion of the circuit) from the remainder of the system in the event of an overcurrent or fault downstream of the interrupting device. (Regulatory Guide 1.189)

isolating device/isolation device—a device in a circuit which prevents malfunctions in one section of the circuit from causing unacceptable influences in other sections of the circuit or other circuits. (IEEE Std. 100-1988; Regulatory Guide 1.189)

isolation transfer switch—a device used to provide electrical isolation from the fire affected area and transfer control of equipment from the main control room to the local control station (alternate shutdown panel).

insulated conductor—a conductor covered with a dielectric (other than air) having a rated insulating strength equal to or greater than the voltage of the circuit in which it is used. (IEEE Std. 100-1988).

insulation (cable, conductor)—that which is relied on to insulate the conductor or other conductors or conducting parts from ground. (IEEE Std. 100-1988)

intumescent coating—a protective chemical coating, which, when heated, internally generates gases and expands, resulting in a thermally insulating crust that contains cavities.

in situ combustibles—combustibles materials that constitute part of the construction, fabrication, or installation of plant structure, systems, and components and as such are fixed in place.

irritants—toxicant that irritate the eyes, upper respiratory tract and/or lungs.

irritant gases—acid gases and other hydrocarbon byproducts that can cause pain on contact or inhalation.

jet—a discharge pressurized liquid, vapor, or gas into free space from an orifice, the momentum of which induces the surrounding atmosphere to mix with the discharged material.

jet fire—combustion occurring at the release of liquid, vapor, or gas under pressure from a leakage point (orifice), the momentum of which causes entrainment of the surrounding atmosphere. The jet fire has a high heat flux, turbulent flame, and capability of eroding the material it impacts.

jet flame—flame due to high velocity fuel supply.

K-factor—coefficient specified for individual sprinklers based on their orifice design and used for hydraulic calculations of the sprinkler system. K-factors are determined by the design and manufacturer of the sprinkler head. (Nolan, 2000)

K-factor—the thermal conductivity coefficient of materials. It is a measurement in standard terms of the amount of heat conducted per the thickness of the material per the degree of temperature.

Kelvin (K)—absolute Celsius temperature, $273 + ^\circ\text{C}$.

laminar—refers to orderly, unfluctuating fluid motion. (Quintiere, 1998)

latent heat—the characteristic amount of energy absorbed or released by a substance during a change in its physical state that occurs without changing its temperature. The latent heat associated with melting a solid or freezing a liquid is called the heat of fusion; that associated with vaporizing a liquid or a solid or condensing a vapor is called the heat of vaporization. (Nolan, 2000)

leakage current (Insulation)—the current that flows through or across the surface of insulation and defines the insulation resistance at the specified direct current potential (IEEE Std. 100-1988).

lean mixture—a mixture of flammable gas or vapor and air in which the fuel concentration is below of fuel's lower limit of flammability.

lean mixture—a mixture of air and gas that contains too much air for the amount of gas present to cause an explosion and is thus below the lower flammable limit.

limited sprinkler system—an automatic sprinkler system that is limited to a single fire area and consists of not more than twenty sprinklers.

line fire—elongated fires on a horizontal fuel surface. (Nolan, 2000)

listed—equipment or materials included on a list published by a recognized testing laboratory, inspection agency, or other organization concerned with product evaluation that maintains periodic inspection of production of listed equipment or materials, and whose listing states that certain specific equipment or materials meet nationally recognized standards and have been tested and found suitable for use in a specific manner. ((Regulatory Guide 1.189, NFC Online Glossary)

local control—operation of shutdown equipment using remote controls (e.g., control switches) specifically designed for this purpose from a location other than the main control room.

local control station—a control panel located in the plant which allows operation and monitoring of plant equipment from outside of the main control room. For post-fire safe shutdown control functions and monitoring variables on these panels must be independent (physically and electrically) from those in the main control room.

local operation—manipulation of plant equipment from a location outside of the main control room. For example, manual operation of the circuit breakers or turning the handwheel on the valve to change its position.

load breaker—a circuit breaker that is located on the load side of a power source. Synonym: branch breaker.

LOI—the limiting oxygen index, a characteristic of solid combustibles measured in a standards apparatus in which the O_2/N_2 ratio of the atmosphere is varied, to provide a measure of relative flammability. Also called oxygen index (OI).

lower flammability limit—the lowest concentration of fuel in air at normal temperature and pressure that can support flame propagation is known as the lower flammability limit (LFL) or lower explosive limit (LEL).

lowe flammability limit—the lowest concentration of a vapor/air mixture which can be ignited by a pilot.

manual action—physical manipulation (operation) of equipment when local or remote controls are no longer available of a plant component such as a valve, switch or circuit breaker.

manual valve—a valve that does not have the capability of being manipulated remotely.

manually operated valve—term used to denote a valve credited in the SSA or shutdown procedures for being manually manipulated.

Note: A manually operated valve may be a manual valve or a remotely operated valve (e.g., MOV) that has its power and control capability disabled or removed.

mass burning flux—burning rate per unit area. (Quintiere, 1998)

mass loss rate—the mass of fuel vaporized but not necessarily burned per unit time. (Quintiere, 1998)

mass optical density—a normalized value of the optical density of a smoke cloud, which is intended to be independent of measuring apparatus.

material safety data sheets—a document, prepared in accordance with DOL 29 CFR, that contains information regarding the physical and health hazards associated with a given product or substance and a recommended emergency action.

means of egress—a safe, continuous, and unobstructed way of travel out of any building or structure; this include the exit access, exit, and exit discharge.

model—a model of anything is, simply, a systematic representation of that thing. For example, we can have: thought models (or conceptual models), scale models, and mathematical models. These three examples are probably the main representation which are used by scientists. A thought or conceptual model is simply a proposed schema explaining how something works. Scale models are often used in structural engineering, fluid dynamics, and have occasionally been used in fire science. Model trains are familiar to all. A scale model in scientific work is simply a reduced-size object on which certain measurements will be made. The mathematical model is a series of equations which describe a certain process. If the equations are simple enough, they can be solved on the hand calculator. More commonly, the equations are not so simple. Consequently, a computer is required for their solution. Thus, in the fire field, we would speak of computer fire model.

molded-case circuit breaker—a circuit breaker that is assembled as an integral unit in a supporting and enclosing housing of molded insulating material. (IEEE Std. 100-1988)

modulus of elasticity—as with yield strength, the modulus of elasticity degrades with temperature, causing deformations at elevated temperatures. This degradation has serious impact on the buckling behavior of columns and the midspan deflection of beams.

moisture content—moisture content will affect the thermal transmission qualities of an element significantly, and in rigorous analysis becomes a very complex problem. Methods for idealizing the treatment of moisture have been developed successfully. Water evaporation can also cause chemical changes in material, usually resulting in discontinuous values of thermal properties. Concrete and gypsum materials are good examples. Moisture content also affects the shrinkage and modulus elasticity properties of concrete. Moisture condensation on reinforced and prestressed cables also affects the temperature in these elements.

multi-conductor cable (multiple conductor cable)—a combination of two or more conductors cabled together and insulated from one another and from sheath or armor where used.

Note: Specific cables are referred to as 3-conductor cable, 7-conductor cable, 50-conductor cable, etc. (IEEE Std. 100-1988).

National Fire Protection Association (NFPA) codes and standards—consensus codes and standards intended to minimize the possibility and adverse consequences of fires.

negative phase—that portion of a blast wave whose pressure is below ambient.

neutral plane—the height in a compartment above which smoke will or can flow out during a fire event. A neutral plane may change from one-half to one-third of the compartment height as the fire becomes fully involved in flames. However, the smoke interface can extend very close to the floor of the compartment.

non-combustible material—(a) material that, in the form in which it is used and under conditions anticipated, will not ignite, burn, support combustion, or release flammable vapors when subjected to fire or heat or (b) material having a structural base of noncombustible material, with a surfacing not over 1/8 inch thick that has a flame spread rating not higher than 50 when measured in accordance with the ASTM E84, "Standard Test Method for Surface Burning Characteristics of Building Materials".

non-essential (conductor, cable, component or system)—structures, systems, and components (Class 1E, Non-Class 1E, safety related or non-safety related) whose operation is not required to support the performance of systems credited in the SSA for accomplishing post-fire safe shutdown functions.

norcotic effect—the effect of producing drowsiness and ultimately unconsciousness. Chemical substances in smoke, when inhaled, can enter the bloodstream and interfere with the oxygen supply to the brain, causing narcosis and possible death.

nonflammable—not capable of being ignited.

normally closed or normally open—the component status during normal operating modes of the plant. This terminology is usually applied to valve, circuit breaker, and relay operating positions.

open circuit—a failure condition that results when a circuit (either a cable or individual conductor within a cable) loses electrical continuity.

open circuit—a failure condition that results when a circuit (either a cable or individual conductor within a cable) loses electrical continuity. (Regulatory Guide 1.189)

Clarification: A circuit fault condition where the electrical path has been interrupted or "opened" at some point so that current will not flow. Open circuits may be caused by a loss of conductor integrity due to heat or physical damage (break).

optical density—a number quantifying the fraction of a beam of light that is unable to pass through a given smoke cloud.

overpressure—any pressure above atmospheric caused by a blast.

overcurrent—any current in excess of the rated current of equipment or the rated ampacity of a conductor. It may result from overload, short-circuit, or ground-fault. A current in excess of rating may be accommodated certain equipment and conductors for a given set of conditions. Hence, the rules for overcurrent protection are specific for particular situations (IEEE Std. 100-1988).

overcurrent protection—a form of protection that operates when current exceeds a predetermined value. (IEEE Std. 100-1988)

overcurrent relay—a relay that operates when its input current exceeds a predetermined value. (IEEE Std. 100-1988).

overload—loading in excess of normal rating of equipment (IEEE Std. 100-1988).

overload—generally used in reference to an overcurrent that is not of sufficient magnitude to be termed a short circuit. (IEEE Std. 100-1988).

oxidization—removal electrons from an atom or molecule, usually by chemical reaction with oxygen.

oxidizing agent—chemical substance that gives up oxygen easily, removes hydrogen from another substance, or attracts electrons.

oxygen starvation—for the case where there are no openings in the enclosure or only small leakages areas, the hot gas layer will soon descend toward the flame region and eventually cover the flame. The air entrained into the combustion zone now contains little oxygen and fire may die out due to oxygen starvation.

paired cable—a cable in which all the conductors are arranged in the form of twisted pairs (IEEE Std. 100-1988).

passive fire barriers—a fire barrier that provides its protective function while in its normal orientation, without any need to be repositioned. (Examples of passive fire barriers include walls and normally closed fire doors).

passive fire protection (PFP)—protection measures that prolong the fire resistance of an installation before an eventual fire occurrence from the effects of smoke, flames, and combustion gases. These can consist of insulation (fireproofing) of a structure, choice of noncombustible materials of construction, use of fire-resistant partitions, and compartmentation to resist the passage of fire. It includes coatings, claddings, or free-standing systems that provide thermal protection in the event of fire and that require no manual, mechanical, or other means of initiation, replenishment, or sustainment for their performance during a fire incident. Passive systems also embrace the basic requirements for area separation and classification. (Nolan, 2000)

passive smoke detection system—a fire detection system where smoke is transported to and into a sensing chamber by outside forces, that is, fire plume strength or environmental air-flows. A passive smoke detection system may have difficulty detecting smoke from smoldering types of fires because this smoke may not be hot enough to rise to the smoke detector location. (Nolan, 2000)

penetration seal—a purposely made seal (or seals) formed in situ to ensure that penetrations or "poke through" to fire barriers do not impair its fire resistance. Wiring, cable or piping openings, ducting through floors, ceilings, walls, and building joints must be provided with fire-rated penetration seals to prevent the spread of fire or its effects. The penetration sealing material is to be made of limited-combustible or noncombustible material that meets the requirements of ASTM E 814, "Fire Tests of Through-Penetration Fire Stops," or UL 1479, "Standard for Safety Fire Tests of Through-Penetration Firestops". (Nolan, 2000)

performance-based fire protection design—an engineering approach to fire protection design based on (1) agreed upon fire safety goals, loss objectives, and design objectives; (2) deterministic and probabilistic evaluation of fire initiation, growth, and development; (3) the physical and chemical properties of fire and growth effluents; and (4) a quantitative assessment of the effectiveness of design alternatives against objectives.

One primary difference between a prescriptive and a performance based design is that a fire safety goal life safety, property protection, mission continuity, and environmental impact is explicitly stated. Prescriptive requirements may inhibit fire safety components from effectively meeting the fire safety goals as an integrated system. (Nolan, 2000)

performance codes—regulations providing for engineering analysis.

performance-based requirements—codes and standards that require design solution be engineered to address the expected hazard in such a fashion that an acceptable level of safety (performance) is ensured.

photoelectric (light scattering) smoke detector—a method of smoke detection that uses the scattering of a light beam from the presence of smoke particles onto a photosensitive detector to sense a fire condition and send a signal for alarm. (Nolan, 2000)

piloted ignition—ignition of flammable fuel-air mixture by a hot spot spark, or small flame (pilot). (Quintiere, 1998)

pilot head detection system—a fire detection system that uses fusible heads on a pneumatic charged system placed over the area of protection or hazard. Activation of the fusible head releases the system pressure, which normally is linked by a pressure switch to a water suppression trip valve to activate water flow to a deluge water spray system. The system provides for automatic fire detection and activation of protective devices or alarms. (Nolan, 2000)

plume—the column of hot gases, flames, and smoke rising above a fire. In a confined area a fire plume rises almost vertically. In an outside, unconfined area the configuration of a fire plume is affected by ambient conditions (wind, temperature, etc.). A fire plume consists of a flame plume, a thermal column of combustion gases, and smoke particles. A fire plume's temperature decreases rapidly after the combustion process due to the entrainment of air. Therefore, the ignition hazard from a fire plume is primarily dependent on the flame height of the plume. Objects located above a flame are not likely to ignite unless large amounts of radiated heat are present or flame contact is made. It may also be called a convection column, thermal updraft, or thermal column. (Nolan, 2000)

pneumatic fire detection system—a fire detection system that detects fire from heat, which either melts fusible elements (spot-type detection) in the system or a low melting point pneumatic (plastic) tubing (linear detection). Loss of pressure in the system activates a pressure switch that sends a signal for an alarm and fixed fire suppression system activation. (Nolan, 2000)

pool fire—a turbulent diffusion fire burning above an upward facing horizontal of vaporizing liquid fuel (usually symmetrical) under conditions where the fuel vapor or gas has zero or very low initial momentum. (Nolan, 2000)

positive phase—that portion of blast wave whose pressure is above ambient.

premixed flame—a flame in which fuel and air are mixed first before combustion. (Quintiere, 1998)

pre-flashover fire—the growth stage of a fire, where the emphasis in the fire safety engineering design is on the safety of humans. The design load is in this case characterized by a heat release rate curve, where the growth phase of the fire is most important.

potential transformer—a special class of transformer used to step down high distribution system level voltages (typically 480V and above) to a level that can be safely measured by standard metering equipment. PT's have a voltage reduction ratio given on their nameplate. A PT with a voltage reduction ratio of 200: 5 would reduce the voltage by a ratio of 200 divided by 5 or 40 times.

post-flashover fire—when the objective of fire safety engineering design is to ensure structure stability and safety of firefighters, the post-flashover fire is of greatest concern. The design load in this case is characterized by the temperature-time curve assumed for the full developed fire stage.

positive-pressure breathing apparatus—self-contained breathing apparatus in which the pressure in the breathing zone is positive in relation to the immediate environment during inhalation and exhalation.

positive pressure ventilation (PPV)—the application of positive air ventilation to an enclosed fire event to influence the degree of ventilation, aid in firefighting activities, and influence burning activity. Mechanical ventilators (fans) are used to blow fresh air into an enclosure in sufficient amounts to create a pressure differential within the enclosure that forces the existing air or products of combustion through an exit opening in the enclosure. Positive pressure ventilation has been used to assist in firefighting operations. (Nolan, 2000)

power cable/circuit—a circuit used to carry electricity that operates a load.

pre-discharge employee alarm—an alarm which will sound at a set time prior to actual discharge of an extinguishing system so that employees may evacuate the discharge area prior to system discharge.

pre-fire position/operating mode—terminology used to indicate equipment status prior to a fire.

prescriptive requirements—detailed and often rigid measures mandated in codes and standards as the means to ensure fire safety.

probable maximum loss (PML)—the loss due to a single fire scenario, which assumes an impairment to one suppression system and a possible delay in manual fire-fighting response.

probabilistic safety assessment (PSA)—a comprehensive evaluation of the risk of a facility or process; also referred to a probabilistic risk assessment (PRA).

product safety engineer—develops and conducts tests to evaluate product safety levels and recommends measures to reduce or eliminate hazards. Establishes procedures for detection and elimination of physical and chemical hazards and avoidance of potential toxic effects and other product hazards. Investigates causes of accidents, injuries, and illnesses resulting from product usage and develops solution. Evaluates potential health hazards or damage which could result from misuse of products and applies engineering principles and product standards to improve

safety. May participate in preparation of product usage and precautionary label instructions. ("Dictionary of Occupational Titles," Volume 1, 14th Edition, U.S. Department of Labor Employment and Training Administration, 1991.)

protective relay—a device whose function is to detect defective lines or apparatus or other power system conditions of an abnormal or dangerous nature and to initiate appropriate control action. A protective relay may be classified according to its input quantities, operating principal, or performance characteristics. (IPEEE Std. 100-1988)

Clarification: Protective relays are small, fast acting, automatic switches designed to protect an electrical system from faults and overloads. A single 4160V switchgear have many relays, each with a specific purpose. Protective relays are classified by the variable they monitor or the function they perform. When a relay senses a problem (e.g., short circuit) it quickly sends a signal to one or many circuit breakers to open, or trip, thus protecting the remainder of distribution system.

pyrolysis—the process of heating fuel to cause decomposition.

pyrophoricity—spontaneous combustion of a material upon exposure to air (atmospheric oxygen).

qualitative—measuring or describing with regards to characteristics, generalities, or trends.

quantitative—measuring or describing based on number or quantity.

qualitative risk analysis—an evaluation of risk based on the observed hazards and protective systems that are in place, as opposed to an evaluation that uses specific numerical techniques

quantitative risk analysis—an evaluation of both the frequency and the consequences of potential hazardous events to make a logical decision on whether the installation of a particular safety measure can be justified on grounds of safety and loss control. Frequency and consequences are usually combined to produce a measure risk that can be expressed as the average loss per year in terms of injury or damage arising from an accidental event. The risk calculations of different alternatives can be compared to determine the safest and most economical options. Calculated risk may be compared to set criteria that have been accepted by society or required by law.

qualified cable—a cable that is certified to meet all of the requirements of the IEEE-383 standard (including both the flame spread and the LOCA exposure test protocols).

quick disconnect valve—a device which starts the flow of air by inserting of the hose (which leads from the facepiece) into the regulator of self-contained breathing apparatus, and stops the flow of air by disconnection of the hose from the regulator.

raceway—an enclosure channel of metal or nonmetallic materials designed expressly for holding wires, cables, or busbars, with additional functions as permitted by code. Raceways include, but are not limited to, rigid metal conduit, rigid nonmetallic conduit, intermediate metal conduit, liquid-tight flexible conduit, flexible metallic tubing, flexible metal conduit, electrical nonmetallic tubing, electrical metallic tubing, underfloor raceways, cellular concrete floor raceways, cellular metal floor raceways, surface raceways, wireways, and busways.

(Regulatory Guide 1.189; IEEE Std. 100-1988).

raceway fire barrier—non-load-bearing partition type envelope system installed around electrical components and cabling that are rated by test laboratories in hours of fire resistance and are used to maintain safe shutdown functions free of fire damage. (Regulatory Guide 1.189)

radiation—heat transfer due to electromagnetic energy transfer such as light. (Quintiere, 1998)

Rankine (°R)—absolute Fahrenheit temperature scale, 460 °F. (Quintiere, 1998)

radiant energy (heat) shield—a non-combustible or fire resistive barrier installed to provide separation protection of redundant cables, equipment, and associated non-safety circuits within containment. (Regulatory Guide 1.189)

rated fire barrier—a fire barrier with a fire endurance rating established in accordance with the test procedure of NFPA 251, "Standard Methods of Fire Test of Building Construction and Materials".

rated voltage—the voltage at which operating and performance characteristics of apparatus and equipment are referred. (IEEE Std. 100-1988).

rated voltage—for cables, either single-conductor or multiple conductor, the rated voltage is expressed in terms of phase-to-phase voltage of a three phase system. For single phase systems, a rated voltage of $\sqrt{3}$ * the voltage to ground should be assumed. (IEEE Std. 100-1988).

redundant shutdown—if the system is being used to provide its design function, it generally is considered redundant. If the system is being used in lieu of the preferred system because the redundant components of the preferred system do not meet the separation criteria of Section III.G.2, the system is considered an alternative shutdown capability.

redundant shutdown—for the purpose of analysis to Section III.G.2 criteria, the safe shutdown capability is defined as one of the two normal safe shutdown trains. If the criteria of Section III.G.2 are not met, an alternative shutdown capability is required. (Generic Letter 86-10)

Note: For BWRs, the use of safety relief valves and low pressure injection systems has been found to meet the requirements of a redundant means of post-fire safe shutdown under Section III.G.2 of 10 CFR 50, Appendix R.

regression rate—the burning rate of a solid or liquid, usually measured in centimeters per second measured perpendicular to the surface.

relay—an electrically controlled, usually two-state, device that opens and closes electrical contacts to effect the operation of other devices in the same or another electric circuit. (IEEE Std. 100-1988)

re-radiation—the radiation re-emitted from a heated surface.

reflected pressure—impulse or pressure experienced by an object facing a blast.

remote shutdown—the capability, including necessary instrumentation and control, to safely shutdown the reactor and maintain shutdown conditions from outside the main control room. (Regulatory Guide 1.189)

remote control—control of an operation from a distance: this involves a link, usually electrical, between the control device and the apparatus to be operated. (IEEE Std. 100-1988)

Note: Remote control may be accomplished from the control room or local control stations.

remote shutdown location—a plant location external to the main control room that is used to manipulate or monitor plant equipment during the safe shutdown process. Examples include the remote shutdown panel or valves requiring manual operation.

repair—to restore by replacing a part or putting together what is broken. (Webster's Ninth New Collegiate Dictionary).

Response Time Index (RTI)—a relative measure of the sensitivity of an automatic fire sprinkler's thermal element as installed in a specific sprinkler. It is usually determined by plunging a sprinkler into a heated laminar airflow within a test oven. This type of "plunge" test is not currently applicable to certain sprinklers. These sprinklers must have their thermal sensitivity determined by other standardized test methods. A response time index is also used to quantify the responses of heat detectors used in a fire detection system. A normal RTI for a sprinkler is 300. Early suppression fast response (ESFR) sprinklers have an RTI of 50 or less. (Nolan, 2000)

restricted area—any area to which access is controlled by the licensee for purposes of protecting individuals from exposure to radiation and radioactive materials.

rich mixture—a mixture of flammable gas or vapor and air in which the fuel concentration is above the fuel's upper limit of flammability.

risk—risk is a quantitative measure of fire or explosion incident loss potential in terms of both the event likelihood and aggregate consequences.

risk-informed—the risk-informed approach the analyst factors is not just the severity of a fire but also the likelihood that the fire will occur.

For example, based on the knowledge and experience of the equipment operator, a fire in a given turbine generator is likely to occur 80-percent of the time. Or, based on the knowledge and experience of the fire protection engineer, the sprinkler system protecting that generator is 90-percent likely to be contain and control that fire. Because the risk-informed, performance-based methodology quantifies the likelihood of a fire hazard and the likelihood that the fire protection system will contain or control the fire it provides a more realistic prediction of the actual risk.

risk reduction—risk reduction in define as the application of technological or administrative measures to reduce fire and explosion risk to a tolerable level.

safety engineer—develops and implements safety program to prevent or correct unsafe environmental working conditions, utilizing knowledge of industrial processes, mechanics, chemistry, psychology, and industrial health and safety laws. Examines plans and specifications for new machinery or equipment to determine if all safety precautions have been included. Determines amount of weight that can be safely placed on plant floor. Tour to inspect fire and safety equipment, machinery, and facilities to identify and correct potential hazards and enclothing and devices, and designs, builds, and installs, or directs installation or safety devices on machinery. Conducts or coordinates safety and first aid training to educate workers about safety policies, laws, and practices. Investigates industrial accidents to minimizes recurrence and prepares accident reports. May conduct air quality tests for presence of harmful gases and vapors. ("Dictionary of Occupational Titles," Volume 1, 14th Edition, U.S. Department of Labor Employment and Training Administration, 1991.)

safety factor—safety factors have been used in most engineering designs to account for uncertainties in calculations. Safety factors are also used in fire protection engineering designs, especially for evacuation times and structural fire safety performance design. The addition of safety factors to performance criteria permits the designer to make a conservative assessment while allowing for smaller margin of error by accounting for uncertainty in the models, the input data and the assumptions.

safe shutdown—for fire events, those plant conditions specified in the plant Technical Specifications as Hot Standby , Hot Shutdown, or Cold Shutdown. (Regulatory Guide 1.189)

safe shutdown analysis (post-fire safe shutdown analysis)—a documented evaluation of the potential effects of a postulated fire (including an exposure fire) and fire suppression activities in any single area of the plant (fire area), on the ability to achieve and maintain safe shutdown conditions in a manner that is consistent with established performance goals and safety objectives. (i.e., Sections III.G and III.L of Appendix R or Position C.5.b of SRP 9.5.1).

safe shutdown system—all structures, equipment (components, cables, raceways cable enclosures etc.), and supporting systems (HVAC, electrical distribution, station and instrument air, cooling water, etc.) needed to perform a shutdown function.

self-heating—the result of exothermic reaction, occurring spontaneously in some materials under certain conditions, whereby heat is liberated at a rate sufficient to rise the temperature of the material.

severity—severity is a qualitative estimate of the hazard intensity in terms of source intensity, time, and distance; for example heat flux, temperature, toxic or corrosive smoke concentration, explosion over-pressure versus distance.

short circuit—a failure condition that results when a circuit (either a cable or individual conductor within a cable) comes into electrical contact with another circuit. (Regulatory Guide 1.189)

short circuit—an abnormal connection (including an arc) of relatively low impedance, whether made accidentally or intentionally, between two points of different potential. (IEEE Std. 100-1988)

short to ground—a short circuit between conductor(s) and a grounded reference point (e.g., grounded conductor, conduit, raceway, metal enclosure, shield wrap or drain wire within a cable).

short-to ground—a failure condition that results when a circuit (either a cable or individual conductor within a cable) comes into electrical contact with a grounded conducting device such as a cable tray, conduit, grounded equipment, or grounded component. (Regulatory Guide 1.189)

solid conductor self-ignited cable fire—a conductor consisting of a single wire. (IPEEE Std.100-1988). Electrical cables are often considered as a source of fire because they carry electric power (a potential source of ignition) and are constructed of materials that can sustain combustion. A fire that initiates from a cable, either due to a fault in the cable or due to a current overload, is referred to as a self-ignited cable fire.

SI units—an internationally accepted systems of measurement units.

small hose system—a system of hose ranging in diameter from 5/8" up to 1½" which is for the use of employees and which provides a means for the control and extinguishment of incipient stage fires.

smoke (from fire)—the mixture of tiny particles and gases produced by a fire. The particles consist mainly of soot, aerosol mist, or soot, or gases, no longer chemically reacting, that emanate from the fire.

smoke barrier—a continuous surface (wall, floor, HVAC damper, or ceiling assembly) that is designed and constructed to restrict the movement of smoke. A smoke barrier may or may not also have a fire resistance rating. Such barriers might have protected openings. (Nolan, 2000)

smoke bomb—a device for generating smoke from a chemical source (a pyrotechnic device) to simulate fire conditions. Smoke bombs are used in confined spaces for testing and training purposes (testing smoke detection, smoke management systems, or firefighter training). They usually produce smoke at a standard rate and quality and can be supplied in various durations. Smoke bombs are sometimes called smoke candles. (Nolan, 2000)

smoke chaser—terminology used for a forest firefighter who is lightly equipped to enable him or her to get to a fire quickly. (Nolan, 2000)

smoke compartment—an area enclosed by smoke barriers on all sides, including the top and bottom. (Nolan, 2000)

smoke condensate—the condensed residue of suspended vapors and liquid products of incomplete combustion. (Nolan, 2000)

smoke control—the control of smoke movement by the use of the airflow by itself, if it is of sufficient velocity and application of air pressure differences of sufficient strength across a barrier. Dilution of a smoke environment by only supplying air and extracting air is not considered a method of smoke control within an enclosure for fire safety concerns. (Nolan, 2000)

smoke control system—a system to limit and direct smoke movement within a building to protect occupants and assist with evacuation measures. It consists of mechanical fans that are engineered to produce air flows and pressure differences within the building compartments to achieve smoke control. (Nolan, 2000)

smoke control zone—the subdivision of a building to inhibit the movement of smoke from one area to another for the purpose of life safety, evacuation, and property protection. A smoke control zone can consist of one or more floors, or a floor can consist of more than one smoke control zone. Each zone is separated from the others by partitions, floors, and doors that can be closed to prevent the spread of smoke. (Nolan, 2000)

smoke curtain—salvage covers placed around an area by the fire service to prevent the spread of smoke that may cause further damage. (Nolan, 2000)

smoke damage—the harmful effects to property from the occurrence of unwanted smoke exposure and combustion gases, consisting of stains, odors, and contamination. Exposure of combustion gases and smoke in some locations may cause property damages higher than physical fire damages. High technology clean rooms and the food processing industry, for example, require high

cleanliness standards for their products and smoke damage may cause harmful chemicals to be deposited on the products, making them unsuitable for use or salvage. (Nolan, 2000)

smoke damper—a device to restrict the passage of smoke through a duct that operates automatically and is controlled by a smoke detector. (Nolan, 2000)

smoke density—the relative quantity of solid and gaseous airborne products of combustion in a given volume. (Nolan, 2000)

smoke detection—the sensing of the products of combustion and sending a signal or an alarm for the purpose of safeguarding life or property. Various devices are available that can sense the presence of smoke, which is considered evidence of unwanted combustion. (Nolan, 2000)

smoke detector—a device that senses visible or invisible particles of combustion. They are very effective for a slow smoldering fire and will generally provide an alarm before a heat detector. They may cause a false alarm or be ineffective if not sited and installed where air currents from ventilation or air conditioning systems are likely to carry smoke and other products of combustion away from the detectors. Usually used to warn occupants of a building of the presence of a fire before it reaches a rapidly spreading stage and inhibits escape or attempts to extinguish it. On sensing smoke, the detectors emit a loud, high-pitched alarm tone, usually warbling or intermittent, and are usually accompanied by a flashing light. There are two types of smoke detector: photoelectric and ionization. Photoelectric smoke detectors utilize a light-sensitive cell in either of two ways. In one type, a light source (a small spotlight) causes a photoelectric cell to generate current that keeps an alarm circuit open until visible particles of smoke interrupt the ray of light or laser beam, breaking the circuit and setting off the alarm. The other photoelectric detector widely used in private dwellings employs a detection chamber shaped so that the light-sensitive element cannot ordinarily "see" the light source (usually a light-emitting diode, LED). When particles of smoke enter a portion of the chamber that is aligned with both the LED and the photocell, the particles diffuse or scatter the light ray so it can be "seen" by the photocell. Consequently, a current is generated by the light-sensitive cell, producing an alarm.

ionization detectors employ radioactive material in quantities so tiny they are believed to pose no significant health hazard to ionize the air molecules between a pair of electrodes in the detection chamber. This enables a minute current to be conducted by the ionized air. When smoke enters the chamber, particles attach themselves to ions and diminish the flow of current by attaching themselves to the ions in the air from the radioactive source. The reduction in current sets off the alarm circuit.

photoelectric smoke detectors are relatively slow to respond and are most effective in sensing the larger smoke particles generated by a smoldering, slow-burning fire. Ionization detectors are much faster to respond and are best at sensing the tiny smoke particles released by a fast-burning fire. Ionization smoke detection is also more responsive to invisible particles (smaller than 1 micron in size) produced by most flaming fires. It is somewhat less responsive to the larger particles typical of most smoldering fires. For this reason, some manufacturers produce combination versions of detectors. Many fire prevention authorities recommend the use of both photoelectric and ionization types in various locations in a private home. Either type of detector can be powered by batteries or by household current. Air sampling smoke detectors is a fire detection system where smoke is transported to and into

a sampling port but they aspirate smoke into the detector sensing chamber rather than chamber using suction fans. Smoke in the immediate vicinity of the sampling ports is drawn into the detector sensing chamber. Air sampling smoke detectors have been employed in zero gravity environments (space vehicles) to detect the presence of smoke. The first smoke alarm was invented by W. Jaeger and E. Meili of Switzerland in 1941. The alarm was part of a project named Minerva Fire Alarm System. It was battery powered and had a flashing light and audible alarm when activated. It was also capable of sending a signal to the local fire station. (Nolan, 2000)

smoke detector, duct—a device located within a building air-handling duct, protruding into the duct, or located outside the duct that detects visible or invisible particles of combustion flowing within the duct. Actuation of the device may allow operation of certain control functions. National and local fire codes recognize the hazard posed by building air-handling systems to spread smoke, toxic gases, and flame from one area to another unless they are shut down. The primary purpose of duct smoke detection is to prevent injury, panic, and property damage by preventing the spread (re-circulation) of smoke. Duct smoke detection can also assist in protecting the air-handling system itself as well as sensitive equipment such as computer hardware. Duct smoke detectors may also be used to activate smoke exhaust dampers. Duct smoke detectors are not rated to be used as general area protection nor are general area detectors listed as duct smoke detectors. It may also be called a duct detector (DD). (Nolan, 2000)

smoke developed index (SDI)—a relative index of smoke produced during the burning of a material as measured by a recognized test. The smoke developed rating of materials is determined by NFPA 255, "Standard Test of Surface Burning Characteristics of Building Materials"; ASTM E84, "Surface Burning Characteristics of Building Materials"; and UL 723, "Tests for Surface Burning Characteristics of Building Materials". (Nolan, 2000)

smoke developed rating—a relative index for the smoke produced from a building material test sample as measured and calculated by the Steiner Tunnel Tests (NFPA 255, "Standard Method of Test of Surface Burning Characteristics of Building Materials"; ASTM E84, "Surface Burning Characteristics of Building Materials"; or UL 723, "Tests for Surface Burning Characteristics of Building Materials"). Red oak has a rating of 100, whereas cement board has a rating of zero. It may also be called a smoke density index (SDI). (Nolan, 2000)

smoke eater—slang terminology referring to a firefighter. It has been applied due to the consequences of firefighters inhaling smoke during a fire incident. (Nolan, 2000)

smoke ejector—a device similar to a fan used to exhaust heat, smoke, and harmful combustion gases from a post-fire enclosed environment and to induct fresh air to the affected enclosure. Smoke ejectors are usually carried as part of the complement of equipment on a fire-fighting vehicle and are commonly electrically powered. (Nolan, 2000)

smoke exhaust system—natural (chimney) or mechanical (fans) ventilation for the removal of smoke from an enclosure to its exterior. The provision of a tenable environment for human life is not considered within the capability of a smoke exhaust system. (Nolan, 2000)

smoke extraction—the removal of smoke from an enclosed structure to aid firefighting operations. It is generally acknowledged that correct ventilation in fire conditions reduces (lateral) fire spread and resultant damage, enables firefighters to enter a building fire more easily, and provides greater

visibility for fire-fighting activities. Manual efforts at the time of the fire may be employed, either through rapidly cut openings or the use of portable smoke extraction fans. Where smoke production may be anticipated in buildings, they are provided with automatic smoke extraction devices. (Nolan, 2000)

smoke extractor—machine or fan blower device for extracting or removing smoke and gases from a building or an enclosure.

smokehouse—a structure used to provide simulated smoke conditions for the training of firefighters. Training is provided in smoke environments where conditions can be monitored and observations made to improve performance. Simulated smoke is used as a safety measure and real fires are avoided. (Nolan, 2000)

smoke gas explosion—when unburnt gases from an unventilated fire flow through leakages into an closed space connected to the fire room, the gases there can mix very well with air to form a combustible gas mixture. A small spark is then enough to cause a smoke gas explosion, which can have very serious consequences. This phenomenon is, however, very observed in enclosure fires.

smoke inhalation—the breathing of the combustion products into the lungs. It is considered an injury that damages the respiratory system. The main dangers of smoke inhalation to the lungs are the presence of narcotic gases, principally carbon monoxide (CO), hydrogen cyanide (HCN), carbon dioxide (CO₂), and the asphyxiating effects of an oxygen-depleted atmosphere. Inhalation of narcotic gases often leads to hyperventilation, leading to an increase in the amount of narcotic gases taken into the lungs.

Narcotic gases also cause incapacitation by attacking the central nervous system. A low level of oxygen in the blood results in low oxygen levels to the brain, which causes impaired judgment and concentration. These effects may confuse, panic, or incapacitate an individual. Incapacity occurs in less than 10 minutes with a 0.2 percentage concentration of carbon monoxide (CO) if heavy activities are being performed. Carbon monoxide combines with the hemoglobin of the blood, preventing oxygen from binding with hemoglobin, which will cause death. Carbon monoxide has an affinity to hemoglobin 300 times that of oxygen. The degree of poisoning depends on the time of exposure and concentration of the combustion gases. If the percentage of carbon monoxide in the blood rises to 70 to 80-percent, death is likely to ensue. Hydrogen cyanide is also referred to as hydrocyanic acid. The cyanides are true proto-plasmic poisons, combining in the tissues with enzymes associated with cellular oxidation. They therefore render oxygen unavailable to the tissues and cause death through asphyxia. Inhaling concentrations of more than 180 ppm of HCN leads to unconsciousness in a matter of minutes, but the fatal effects would normally be caused by carbon monoxide poisoning after HCN has made the victim unconscious. Exposure to concentrations of 100 to 200 ppm for periods of 30 to 60 minutes can also cause death. Inhalation of hot smoke gases into the lungs will also cause tissue damage (burns) such that fatal effects could result in 6 to 24 hours after the exposure. Whenever the effects of smoke may affect individuals, protective measures must be provided, such as smoke management systems, smoke barriers, or fresh air supplies. (Nolan, 2000)

smoke interface—the layer in a compartment that separates the smoke layer from the non-smoke layer. A smoke layer will gradually increase as the fire increases if the smoke layer is not vented, which lowers the smoke interface and may eventually fill the compartment. Fully developed fires have a smoke interface several centimeters (inches) above the floor. Cooling, or a decrease in the fire, may allow the smoke layer to dissipate and the interface will rise. May also be called smoke layer interface. (Nolan, 2000)

smoke layer—the accumulated thickness of smoke in an enclosure. (Nolan, 2000)

smoke management system (SMS)—natural or mechanical ventilation for the control or removal of smoke from an enclosure. Smoke management systems provide for smoke control to assist in personnel evacuation and firefighting activities. They provide pressurized areas within a building to prevent the entrance of smoke or to direct smoke to the outside of the building. Smoke control systems can be designated a dedicated or nondedicated. A dedicated smoke control system is provided for smoke control only within an enclosure. It is a separate air moving and distribution system that does not function under normal building operating conditions. It is specifically designated for smoke control functions. A nondedicated smoke control system shares its components with other building systems such as the heating, ventilation, and air conditioning (HVAC) system. Activation of it causes the system to change its mode of operation from normal building HVAC requirements to that of smoke control. (Nolan, 2000)

smoke pencil—a chemical solid that is ignited to produce smoke for testing purposes, primarily for the integrity testing of enclosures that are protected by fixed gaseous fire suppression systems. (Nolan, 2000)

smoke-proof—resistant to the spread of smoke. (Nolan, 2000)

smoke shaft—a continuous shaft extending the full height of a building, with opening at each floor and a fan at the top; during a fire, the dampers on the fire floor open and the fan vents the combustion products.

smoke seal—a flexible membrane provided around the edge of a rated fire door frame. It is used to prevent the passage of smoke particles and combustion gases through the door seam surrounding a fire-rated door when it is closed.

smoke stop—a barrier provided to stop the spread of smoke to another area. (Nolan, 2000)

smoke test—a method for confirming the integrity of a chimney and for detecting any cracks in a masonry chimney flue, or deterioration or breaks in the seal or joints of a factory-built or metal chimney flue. Smoke is generated in a fire-place or solid fuel-burning appliance while simultaneously covering the chimney termination. Smoke leakages are then checked for through the chimney walls or suspected openings. (Nolan, 2000)

smoke visibility—the ability to perceive objects through smoke at a specific distance. Smoke visibility is necessary during fire conditions for evacuation of occupants, rescue operations, and firefighting activities. The ability to see through smoke is a measure of smoke visibility and can be related to the mass optical density (the yield of solid and liquid particulates of smoke generation). Smoke reduces visibility by a reduction in available light through the absorption and scattering of light by the smoke particulates. (Nolan, 2000)

smoldering—a slow combustion process between oxygen and a solid fuel. (Quintiere, 1998)

soot—tiny particles consisting of carbon, often formed in diffusion flames and in very rich premixed flames.

spalling—generally, the breaking away or explosion of concrete materials from a fire exposure. It occurs due to stresses set up by steep temperature gradient onto aggregates in the concrete that

expand, or moisture that is trapped and vaporizes without any means of venting safely. Major factors that affect spalling behavior are moisture contact, rate of temperature rise, permeability, porosity, restraint, and reinforcement. Spalling also is known to occur in fire-resistant protective coating for steel where asbestos or other fiber fillers are added to concrete or other cementitious material to increase insulation value. Spalling promotes exposure of structural steel, steel reinforcing or pre-stressing cables; thermal transmission due to decreased section thickness; fire passage due to openings caused by extreme spalling; and degradation in moment-bearing capacity due to reduced element cross sections. (Nolan, 2000)

species—another name for chemical compounds, usually gases. (Quintiere, 1998)

specific heat—property that measures the ability of matter to store energy. (Quintiere, 1998)

spot detector—a device whose detection element is concentrated at a particular location. Examples are bimetallic detectors, fusible alloy detectors, local rate-of-rise and smoke detectors, and thermoelectric detectors. Spot-type detectors have a defined area of coverage. (Nolan, 2000)

spontaneous combustion—the outbreak of fire without application of heat from an external source. Spontaneous combustion may occur when combustible matter, such as hay or coal, is stored in bulk. It begins with a slow oxidation process (bacterial fermentation or atmospheric oxidation) under conditions not permitting ready dissipating of heat, such as in the center of a haystack or a pile of oil rags. Oxidation gradually raises the temperature inside the mass to the point at which a fire starts.

spontaneous combustion—ignition of a combustible material caused by the accumulation of heat from oxidation reactions.

spontaneous heating—slow oxidation of an element or compound which causes the bulk temperature of the element/compound to rise without the addition of an external heat source.

spontaneous ignition—ignition that occurs as a result of progressive heating, as contrasted with instantaneous ignition caused by exposure to a spark or a flame. The spontaneous ignition can result from self-heating caused by slow oxidation, or from an external heat source.

sprinkler—a water deflector spray nozzle device used to provide distribution of water in specific characteristic patterns and densities for the purpose of cooling exposures exposed to unacceptable heat radiation, and controlling and suppressing fires or combustible vapor dispersions. Water droplet size from a discharging sprinkler is one key factor in determining the effectiveness of its water spray. Water droplets penetrate a fire plume to reach a burning commodity by two modes: gravity and momentum. In the gravity mode, the downward velocity of the water droplets falling through a fire plume must be greater than the upward velocity of the fire plume for it to reach the base of the fire. Gravity action alone cannot accomplish this. Increased system pressure provides water droplets with greater downward thrust (momentum) to overcome the upward thrust of the fire plume. (Nolan, 2000)

sprinkler, automatic—a fire suppression or control device that operates automatically when its heat-actuated element is heated to its thermal rating or above, allowing water to discharge over a specific area. (NFC Online Glossary)

sprinkler density—calculated by gallons per minute discharge divided by the square footage covered.

sprinkler, dry (pendent)—an automatic sprinkler that is not provided with water continuously at its inlet. It is provided where freezing conditions are a concern if the sprinkler system is seasonally drained down. A seal is provided at the main supply pipe to prevent water from entering the sprinkler assembly until the sprinkler is activated from fire conditions. Typically, it is designed so that the fusible element opens the sprinkler and releases a spring-loaded tube that breaks the glass inlet water seal. This allows water to flow to the sprinkler. pattern of the sprinkler. (Nolan, 2000)

sprinkler, on-off—a cycling (on-off), self-actuating snap-action, heat-actuated sprinkler. Water flow automatically shuts off from the sprinkler when the fire has been extinguished (no heat is available to activate the sprinkler head) and it is automatically reset for later operations. This type of sprinkler requires a water supply that is free of contaminants (potable) that could interfere with its operation. It does not have to be replaced after operation. It is provided to avoid water damage by eliminating the need to shut off the water supply after a fire has been extinguished. Typical applications include areas containing high-value inventories, materials, or equipment highly sensitive to water areas subject to flash or repeat fires, and where the water supply is limited. (Nolan, 2000)

sprinkler, open—a sprinkler device that has a permanent open orifice and is not actuated by a heat responsive element. Instead, an upstream device controls water flow from the sprinkler. Its primary purpose is to provide adequate distribution of water in a prescribed pattern. (Nolan, 2000)

sprinkler, pendent—a sprinkler designed for and installed with the head in a downward fashion from the piping, rather than placed in an upward position above the supply pipe. They are primarily used where upright sprinklers cannot be used because of lack of space (headroom) or where concealment of sprinkler piping above a false ceiling is desired because of aesthetic reasons (office areas). (Nolan, 2000)

sprinkler, pilot—an automatic sprinkler head or thermostatic fixed temperature device used in a pneumatic or hydraulic fire detection system, normally connected to an actuating valve that releases when the pilot device is activated. (Nolan, 2000)

sprinkler pintle—an indicating device on sprinklers that have small and large orifices and a standard 0.5 in. (1.27 cm) pipe thread. A pintle highlights the sprinkler orifice size difference compared to standard orifices; that is, 0.5 in. (1.27 cm) sprinklers with 0.5 in. (1.27 cm) pipe threads. It consists of a small, short cylinder centrally mounted and perpendicular to the deflector plate, on the side opposite the water discharge. (Nolan, 2000)

sprinkler, recessed—sprinklers in which all or part of the body, other than the shank thread, is mounted within a recessed housing. Recessed sprinklers are mainly provided for aesthetic reasons, although protection of the sprinkler installed, tested, and evaluated before the installation of the finished ceiling. (Nolan, 2000)

sprinkler, residential—a type of fast-response sprinkler that is well known for its ability to enhance human survivability in the room of fire origin and is used in the protection of dwelling units as specified by listing or approval agencies. The first effective fast-response sprinkler for residential use was developed by the Factory Mutual Research Corporation (under contract to the United States Fire Administration) and was demonstrated in 1979. (Nolan, 2000)

sprinkler riser—the vertical portion of a sprinkler system piping from the ground main to the horizontal cross main that feeds the branch lines. (Nolan, 2000)

sprinkler, sidewall—sprinkler designed to be installed on piping along the sides of a room instead of the normal sprinkler spacing requirements. The sprinkler is made with a special deflector that deflects most of the water away from the nearby walls in a pattern similar to a quarter of a sphere. A small portion of the water is directed at the wall behind the sprinkler. Sidewall sprinklers are generally used because of aesthetic concerns, building construction arrangements, or installation economy considerations. (Nolan, 2000)

sprinkler spacing—distribution of automatic sprinklers to provide the area coverage specified for light, ordinary, and extra hazardous occupancies. (Nolan, 2000)

sprinkler system—for fire protection purposes, an integrated system of underground and overhead piping designed in accordance with fire protection engineering standards. The installation includes one or more automatic water supplies. The portion of the sprinkler system above ground is a network of specially sized or hydraulically designed piping installed in a building, structure, or area, generally over-head, and to which sprinklers are attached in a systematic pattern. The valve controlling each system riser is located in the system riser or its supply piping. Each sprinkler system riser includes a device for actuating an alarm when the system is in operation. The system is usually activated by heat from a fire and discharges water over the fire area.

The first recorded patented sprinkler system was developed in London in 1806 by John Carey. It consisted of a pipe fed by a gravity tank with a number of valves held closed by counterweights on strings; when a fire burned the strings, the valves were opened. The sprinkler head consisted of an outlet similar to a water can perforated nozzle that faced downward. A refined sprinkler system was patented (British Patent No. 3201) by William Congreve in 1809. His system used fusible metal on the wires controlling water supply valves and had various water distribution devices including perforated pipes, devices similar to sidewall sprinklers. Many manually operated systems were installed in 19th century buildings. The first system in America was installed in a plant in Lowell, Massachusetts in about 1852. A number of perforated pipes were fed by a main riser that could be turned on in an adjoining area. James B. Francis improved the distribution of this system by using pipe with perforations about 0.1 in. (0.25 cm) in diameter and spaced 9 in. (22.86 cm) apart, alternately on different sides, to provide a spray at water at an angle slightly above the horizontal. Insurance companies of the time continued to improve on the design. These systems resulted in frequent water damage in parts of a room or building untouched by fire. An improvement was sought and found in the Parmelee sprinkler head, which was introduced in the United States in the 1870s. The Parmelee head had a normally closed orifice that was opened by heat from a fire. The first sprinkler successfully used over a long period was the Grinnel "glass button," which appeared in 1890 (previous Grinnel types were developed from 1884 to 1888). Since about 1900, most changes to sprinklers have been refinements in the design (deflector or activating mechanism improvements) rather than conceptual changes. Modern versions use a fusible link or a bulb containing chemicals that breaks at about 160 °F (70 °C) to open the orifice. Modern sprinkler heads are designed to direct a spray downward. Most sprinkler systems are wet-head; that is, they use pipes filled with water. Where there is danger of freezing, however, dry-head sprinklers are used, in which the pipes are filled with air under moderate pressure; when the system is activated, the air escapes, opening the water-feeder valves. An improved version has air under only atmospheric pressure and is activated by heat-sensing devices. Another special type, used in high-hazard locations, is the deluge system, which delivers a large volume of water quickly. The definitions of several types of sprinkler systems follow. (Nolan, 2000)

wet pipe system—a sprinkler system that uses automatic sprinklers installed in a piping system containing water and connected to a water supply. Individual sprinklers discharge immediately when they are affected by the heat of a fire. Sprinklers that are not affected by

the heat remain closed. It is used where there is no danger of the pipes freezing and where no other conditions require the use of a special system. A wet pipe sprinkler system that uses automatic sprinklers installed in a piping system containing an antifreeze solution and connected to a water supply. The antifreeze solution is discharged (followed by water) immediately upon operation of the sprinklers, which are opened from the heat effects from a fire.

dry pipe system—a sprinkler system that uses automatic sprinklers installed in a piping system containing air or nitrogen under pressure. A release of pressure on the system (as from the opening of a sprinkler) permits the water pressure to open a valve known as a dry pipe valve. The water then flows into the piping system and out the opened sprinklers. Dry pipe systems operate more slowly than do wet pipe systems and are more expensive to install and maintain, therefore they are only used where there is an absolute necessity, such as freezing conditions.

pre-action system—a sprinkler system using automatic sprinklers installed in a piping system containing air that may or may not be under pressure, with a supplemental detection system installed in the same areas as the sprinklers. Actuation of a detection system opens a valve that permits water to flow into the sprinkler piping system and to be discharged from any sprinklers that have opened from the effects of a fire. Sprinklers that are not affected by heat from a fire remain closed. They are designed to counteract the operational delay of dry pipe systems and eliminate the damage from a broken pipe or sprinkler head.

combined dry pipe and pre-action system—a sprinkler system that uses automatic sprinklers installed in a piping system containing air under pressure, with a supplemental fire detection system installed in the same areas as the sprinklers. Operation of the detection system actuates tripping devices that open dry pipe valves simultaneously without a loss of air pressure in the system. Operation of the fire detection system also opens air exhaust valves at the end of the system feed main, facilitating the filling of the system with water, which normally occurs before any sprinklers open. The detection system also serves as an automatic fire alarm system for the area. Only sprinklers that are affected by heat from a fire are opened; others remain closed.

deluge system—a sprinkler system using open sprinklers installed in a piping system connected to a water supply through a valve that is opened by the operation of a detection system installed in the same areas as the sprinklers. When the deluge valve opens, water flows into the system piping and discharges from all sprinklers. There are no closed sprinklers in a deluge system. Its objective is to deliver the most amount of water in the least amount of time. Deluge systems are specified for high hazard locations where a fire occurs quickly and reaches very high temperatures, such as from highly flammable fuels.

water spray system—a fixed pipe system connected to a water supply and equipped with spray nozzles for specific discharge and distribution over the surface or area to be protected. The piping system is connected to the water supply through an automatic or manually activated valve that initiates the flow of water. The control valve is actuated by the operation of automatic fire detection devices installed in the same area as the water spray nozzles (in special cases the automatic detection devices may be located in another area).

foam-water sprinkler system—a fire protection piping system that is connected to a source of air-foam concentrate and a water supply and is equipped with appropriate discharge devices for extinguishing agent discharge and for distribution over the area to be protected.

foam-water spray system—a fire protection piping system connected to a source of air-foam concentrate and a water supply and equipped with foam-water spray nozzles (aspirating or non-aspirating) for extinguishing agent discharge and for distribution over the area to be protected.

Fire protection sprinkler systems may also have several different piping arrangements.

gridded system—a sprinkler system piping arrangement where parallel cross-mains are connected by multiple branch lines. An operating sprinkler receives water from both ends of its branch line while other branch lines help transfer water between cross-mains.

looped system—a sprinkler system piping arrangement where multiple cross-mains are connected to provide more than one path for water to flow to an operating sprinkler, and branch lines are connected to each other.

circulating closed-loop system—a wet pipe sprinkler system that has a non-fire-protection connection to an automatic sprinkler system in a closed-loop piping arrangement. This allows the sprinkler piping to conduct water for heating or cooling in an economical fashion without impacting the ability of the sprinkler system to support its fire protection purpose. Water is not removed or used from the system, but is only circulated through the piping system.

sprinkler temperature classes—sprinklers are designated to operate at specific fire temperatures and are segregated into temperature classes. The actual temperature rating of sprinklers may be less important than is popularly perceived. Where ceiling temperatures rise rapidly, the difference between 165 °F (74 °C) and 212 °F (100 °C) for the first sprinkler to operate may not be important, but it may affect the number of heads that operate. Higher temperature sprinklers are used where the ambient temperatures may be higher than ordinary temperature ratings.

sprinkler tong—a portable tool used to stop the flow from a sprinkler head.

sprinkler types-spray sprinkler

conventional sprinkler

fast-response sprinkler

residential sprinkler

extended coverage sprinkler

quick-response sprinkler

quick-response extended coverage sprinkler

large-drop sprinkler

early suppression fast response sprinkler (ESFR)

open sprinkler

special sprinkler

specific application sprinkler
flush sprinkler
concealed sprinkler
recessed sprinkler
corrosion-resistant sprinkler
in-rack sprinkler
dry sprinkler

sprinkler, upright—a sprinkler designed for and placed in an upward position above the supply pipe, rather than installed in a downward fashion from the supply pipe. It directs 100-percent of its water toward the floor. A sprinkler designated for upright installation cannot be used in the downward position because the water will be directed to the ceiling instead of toward the fire incident and will not achieve its density pattern for fire control and extinguishment. (Nolan, 2000)

spurious actuation—an undesirable actuation of a component or system due to an uncontrolled or unintended signal.

spurious actuation/operation—a change (full or partial) in the operating mode or position of equipment. These operations include but are not limited to: (a) opening or closing normally closed or open valves, (b) starting or stopping of pumps or motors, (c) actuation of logic circuits, (d) inaccurate instrument reading.

spurious operation—the undesired operation of equipment resulting from a fire that could affect the capability to achieve and maintain safe shutdown. (Regulatory Guide 1.189)

spurious indications—false indications (process monitoring, control, annunciator, alarm, etc.) that may occur as a result of fire and fire suppression activities.

spurious signals—false control or instrument signals that may be initiated as a result of fire and fire suppression activities.

suppression—the sum of all the work done to extinguish a fire from the time of its discovery.

stack effect—the air or smoke movement or migration through a tall building due to pressure differentials caused by temperature.

stair pressurization—increasing the air pressure in stair wells (usually with fan systems) to provide refuge area from fire and smoke.

standard—document that address a specific fire safety issue. There are standard practices for installing and inspecting fire protection equipment; and standard methods for testing personal protective equipment, building products and fire protection equipment.

standard sprinkler pendent (SSP)—a sprinkler designated to be installed with its outlet oriented to allow its spray to be directed upward.

standard sprinkler upright (SSU)—a sprinkler designated to be installed with its outlet orientated to allow the spray to be directed downwards.

standpipe hose cabinet—a cabinet provided for the provision of standpipe outlets and/or fire hose storage. Fire hoses are usually pre-connected and stored in a rack with release pins.

standpipe, manual—a standpipe system that relies on the fire service to supply water to it to meet its demands.

standpipe, semi-automatic—a standpipe system that is connected to an adequate water supply, but requires a control device activation to supply water to the hose outlets.

standpipe system—the provision of piping, riser pipes, valves, firewater hose connections, and associated devices for the purpose of providing or supplying firewater hose applications in a building or structure by the occupants or fire department personnel. Standpipe systems are classified according to their intended use by the building occupants, the fire department, or both. Many high-rise or other large buildings have an internal system of water mains (standpipes) connected to fire hose stations. Trained occupants or employees of the building management operate the hoses until the fire department arrives. Firefighters can also connect their hoses to outlets near the fire. The National Fire Protection Association (NFPA) classifies standpipe systems based on their intended use as Classes I, II, or III. Class I is provided for fire service use or other personnel trained in handling heavy fire streams. It is distinguished by the provision of 2.5 in. (6.35 cm) hose stations or hose connections. A Class II standpipe system is provided for use by the building occupants and by the fire service during initial attack operations. It is characterized by the provision of 1.5 in. (3.81 cm) hose stations. A Class III standpipe system combines both the features of Class I and Class II systems.

For fire protection purpose, an integrated system of underground and overhead piping designed in accordance with fire protection engineering standards. The installation includes one or more automatic water supplies. The portion of the sprinkler system aboveground is a network of specially sized or hydraulically designed piping installed in a building, structure, or area, generally overhead, and to which sprinklers are attached in a systematic pattern. The valve controlling each system riser is located in the system riser or its supply piping. Each sprinkler system riser includes a device for actuating an alarm when the system is in operation. The system is usually activated by heat from a fire and discharged water over the fire area.

standpipe systems

Class I standpipe system—a 2½" hose connection for use by fire departments and those trained in handling heavy fire streams.

Class II standpipe system—a 1½" hose system which provides a means for the control or extinguishment of incipient stage fires.

Class III standpipe system—a combined system of hose which is for the use of employees trained in the use of hose operations and which is capable of furnishing effective water discharge during the more advanced stages of fire (beyond the incipient stage) in the interior of workplaces. Hose outlets are available for both 1½" and 2½" hose.

standpipe, wet—a standpipe system that is permanently charged with water for immediate use.

static ignition hazard—an electrical charge build-up of sufficient energy to be considered an ignition source. For an electrostatic charge to be considered an ignition source, four conditions must be present: (1) a means of generating an electrostatic charge, (2) a means of accumulating an

electrostatic charge of sufficient energy to be capable of producing an incendiary spark, (3) a spark gap, and (4) an ignitable mixture in the spark gap. Removal of one or more of these features will eliminate a static ignition hazard. Static charges can accumulate on personnel and metallic equipment. If the static accumulation is separated by materials that are electrically nonconducting, a dangerous potential difference may occur. These nonconducting materials or insulators act as barriers to inhibit the free movement of electrostatic charges, preventing the equalization of potential differences. A spark discharge can occur only when there is no other available path of greater conductivity by which this equalization can be affected (bonding or grounding).

spurious operation—the undesired of equipment resulting from a fire that could affect the capability to achieve and maintain safe shutdown.

standard time-temperature curve—curve representing the standard reproducible test fire used since 1918 to measure the fire endurance of building materials.

Stefan-Boltzmann law—an equation that specifies the intensity of radiation emitted by an object, in terms of its absolute temperature (K).

steiner tunnel test—test to determine the surface burning characteristics of building materials in which the flame spread of the test material is compared to asbestos cement board, rated 0, and red oak, rated 100. The higher the rating, the greater the potential hazard. In addition to flame spread, the test also measure smoke development and fuel contributed to the fire. ASTM E84, NFPA 255, UL 723.

stoichiometric—refers to the amount of air needed to burn the fuel (and to combustion products formed).

stoichiometric reaction—chemical A is said to undergo a stoichiometric reaction with chemical B when the proportions of A and B are such that there is no excess of A and B remaining after the reaction.

stoichiometric air to fuel mass ratio—the ratio of air to fuel mass needed to burn all the fuel to combustion.

stoichiometry—a balance chemical equation defines the stoichiometry of a reaction; stoichiometry gives the exact proportions of the reactants for complete conversion to products, where no reactants are remaining. Stoichiometric ratio is the ideal reaction mass fuel to oxygen (or air) ratio and is given the symbol r .

stratification—the rising or setting of layers of smoke, according to the density or weight, with the heaviest layer on the bottom; smoke layers usually collect from the ceiling down.

sublimation—the evaporation of molecules from a solid to form a gas in the absence of a liquid.

surface emissive power—the heat that is radiated outward from a flame per unit surface area of the flame. Its measurement and calculation units are normally kW/m^2 . (Nolan, 2000)

superheat limit temperature—the temperature of a liquid above which flash vaporization can proceed explosively.

supervisory service—the service required to monitor performance of guard patrols and the operative condition of automatic sprinkler systems and of other systems for the protection of life and property.

supervisory signal—a signal indicating the need of action in connection with the supervision of guards' tours, sprinkler and other extinguishing systems or equipment, or with the maintenance features of other protective systems.

suppression—the sum of all the work done to extinguish an unwanted fire from the time of its discovery until extinguishment. (NFC Online Glossary)

temperature—measurement of heat energy content for a substance/material/fluid, etc.

thermal conductivity—the property of matter that represents the ability to transfer heat by conduction.

thermal decomposition—chemical breakdown of a material induced by the application of heat.

thermal decomposition (pyrolysis)—a process whereby chemical bonds within macromolecules forming a solid are broken by heat and flammable vapors are released.

thermal diffusivity—ratio of a material's thermal conductivity to the product of its heat capacity and density. It is the measure of a material's disposition to absorb and transmit heat to the interior of the material.

thermal energy—energy directly related to the temperature of an object.

thermal expansion—thermal expansion becomes important when an element is heated non-uniformly, as in the case of a fire. It may cause increased axial loads in columns, resulting in earlier buckling failure. In case of beams, however thermal expansion also affects the strain and subsequent stress distribution through a beam section. Normally, tensile strain is increased while compressive strain is decreased. The resulting strain distribution causes a greater deflection of the beam at midspan. The coefficient of thermal expansion varies with temperature. In case of concrete, thermal expansion is significantly affected by aggregate type. Thermal expansion also affects spalling (chipping and scaling) characteristics at the surface of an element.

If the member is partially restrained axially, any added axial thrust caused by the thermal expansion of the element will have the net effects of increasing the moment-bearing capacity (load) of the beam. Of course, the strain caused by the thermal expansion should be considered when calculating deflection histories of elements. Generally, beam-type assemblies are given restrained and unrestrained fire resistance rating.

thermal/hydraulic time line—a documented evaluation of the response of important reactor plant parameters to a postulated transient (thermal/hydraulic analysis) with respect to the time available to accomplish required shutdown functions. For example, the time available to establish Auxiliary Feedwater (AFW) following a reactor scram in a PWR would be determined by a thermal/hydraulic analysis. The objective of the thermal/hydraulic time line is to compare this time to the time needed for operators to perform all system and equipment alignments necessary to establish a secure source of AFW.

Note: All operator actions delineated in alternative shutdown procedures must be supported by a thermal/hydraulic timeline.

thermal inertia—a thermal property responsible for the rate of temperature rise, kpc. Low kpc - Surface heats rapidly, fast ignition (b) High kpc - Surface heats slowly, slow ignition.

thermal inertia—thermal inertia is a measure of the tendency of heat to collect on the surface of a material. It may be a better indicator of ignitability than ignition temperature. Material such as balsa wood and foamed plastics have low thermal inertia; their surfaces will heat up quickly, making them easy to ignite, and to produce rapid flame spread. By contrast, materials with relatively high thermal inertia, such as ebony wood, are difficult to ignite and do not spread fire as rapidly.

thermal inertia—thermal inertia is the resistance to temperature change in a material when the surrounding temperature changes. The lower the thermal inertia of a material, the faster its surface will heat, with accompanying increasing temperature. Thus response to exposing conditions is important in terms of how quickly a combustible material reaches its ignition temperature, how fast it burns when ignited, and the rate of flame spread across its surface. Thermal inertia also plays an important part in determining the amount of heat absorbed by wall, ceiling, and other materials in a compartment. Thermal inertia has an important effect on both the onset of flashover and eventual impact of the fire.

Thermal inertia is an intrinsic material property. Its influence on the temperature of an object is strictly a function of heat transferred to the object. As a material's surface is heated (or cooled), heat is conducted to (or from) the material's interior. At first, this heat transfer is not constant and depends on the thermal inertia of the material. Once the rate of heat transfer from the surface to the interior is constant, the rate of surface temperature change depends only on the conductivity of the material, without regard to the material's density or specific heat. For thicker materials with high density thermal inertia, the time to reach this condition can be extensive.

thermal insulation—one or more layers of noncombustible or fire-resistant, high-density material to reduce the passage of heat for protection against exposure of an ignition source (hot surface), burn injuries, or heat damage. (Nolan, 2000)

thermal lag—when a fixed temperature device senses a rise in ambient temperature, the temperature of the surrounding air will always be higher than the operating temperature of the device itself. This difference between the operating temperature and the actual air temperature is commonly referred to as thermal lag, and is proportional to the rate at which the temperature is rising. (Nolan, 2000)

thermal layering—the process of gases to form layers based on temperature where the hottest layers in a confined space are located at the highest elevations (due to lower densities) and the lowest temperature gases are located at the lowest elevations (due to the highest densities). (Nolan, 2000)

thermal protective clothing—the protective apparel provided for and used by firefighters and other individuals as protective insulation against the adverse effects of heat. Generally consisting of helmets, boots, gloves, hoods, coats, and pants. (Nolan, 2000)

thermal penetration time—time required to be conducted through a particular object, typically to each side of the wall material.

thermal runaway—an accelerating chemical reaction due to an imbalance between heat loss and energy production.

thermocouple—device made of two dissimilar metal wires to measure temperature. (Quintiere, 1998). A temperature difference across an interface of two different metals causes a voltage proportioned to the temperature difference.

thermoplastic—a polymeric solid which melts at a temperature lower than its ignition temperature.

thermoset—a polymeric solid which does not melt but decomposes to generate vapors and char.

thermal lag—the difference between the operating temperature of a fire detection device such as a sprinkler head and the actual air temperature when the device activates.

thermal transmission—among the standard criteria for the fire resistance of a building element is its ability to insulate an adjacent space from the fire zone to prevent ignition of combustibles on the unexposed side of the wall. The problem concerning the prediction of the element's temperature distribution evolves from the effects of increased temperature on thermal properties. The values of thermal conductivity, heat capacity, and density often vary considerably with temperature and material composition, as in the case of concrete. These terms define the thermal diffusivity, which is critical to the analysis of heat flux through an element.

thermoplastic cable—a cable material which will soften, flow, or distort appreciably when subjected to sufficient heat and pressure. Examples are polyvinyl chloride and polyethylene.

Note: Cables using thermoplastic insulation are not usually qualified to IEEE Std. 383.

thermoset cable—a cable material which will not soften, flow, or distort appreciably when subjected to heat and pressure. Examples are rubber and neoprene.

Note: Cables using thermoplastic insulation are usually qualified to IEEE Std. 383.

time/current characteristic curve (trip curves)—a graphic illustration of the operating characteristics of electrical protection devices (fuse, circuit breaker, or relay). The tripping characteristics of protective devices is represented by a characteristic tripping curve that plots tripping time versus current level. The curve shows the amount of time required for the protective device to trip at a given overcurrent level. The larger the overload or fault current, the faster the breaker/fuse will operate to clear the circuit (referred to as inverse time characteristics). A comparison of characteristic trip curves is necessary to determine if proper coordination exists between devices.

TNT equivalence—the amount of TNT (trinitrotoluene) that would produce observer damage effects similar to the explosion under consideration. For non-dense phase explosion, the equivalence has meaning only at a considerable distance from the explosion source, where the nature of the blast wave arising is more or less comparable with that of TNT.

total enclosure surface area—the total surface area bounding the enclosure, not including openings.

total flooding system—a fixed suppression system which is arranged to automatically discharge a predetermined concentration of agent into an enclosed space for the purpose of fire extinguishment or control.

total flooding system—a supply of dry chemical permanently connected to fixed piping and nozzles that are arranged to discharge dry chemical into an enclosure surrounding the hazard.

The provision of a fire extinguishing agent in an enclosed area that completely fills the volume to effect extinguishment or prevent a fire incident. They may be gaseous, liquid, or solid. Most common agents are gaseous, such as carbon dioxide (CO₂) or Halon; liquid types use foaming agents, such as high expansion foam, and solid form may use dry chemical systems. Gaseous agents require a particular concentration of agent to be achieved within the volume before extinguishment can be achieved. Total flooding is used where it may be difficult to immediately reach the seat of a fire, such as in machinery spaces, a computer room, and engine compartments. Because some agents (CO₂) may deplete oxygen from the enclosure to extinguish the fire, special precautions (pre-alarm, evacuation notification, reentry precautions, etc.) must be implemented where personnel may also be present. Application of a total flooding system to an enclosure requires the enclosure to be adequately sealed to prevent the release of the agent out of the enclosure once it is applied.

toxicity—the nature and extent of adverse effects of a substance upon a living organism.

transmissivity—the fraction of radiant energy transmitted from a radiating object through the atmosphere to a target after reduction by atmospheric absorption.

transient combustibles—combustibles materials that are not fixed in place or an integral part of an operating systems or components. (Regulatory Guide 1.189)

travel distance—the length of the path a building occupant must travel before reaching an exterior door or enclosed exit stairway, exit passageway, or horizontal exit. The total length of the exit access.

triplex cable—a cable composed of three insulated single conductor cables twisted together. (IEEE Std. 100-1988)

Note: AC power cables are usually of triplex design.

trouble signal—an audible signal indicating trouble of any nature, such as a circuit break or ground, occurring in the devices or wiring associated with a protective signaling system.

turbulent—refers to randomly fluctuating fluid motion around a mean flow.

under-ventilated—Less than stoichiometric air is available.

upper and lower flammability limits—Concentration of fuel in air in which a premixed flame can propagate.

unconfined vapor cloud explosion (UNVC)—unconfined vapor cloud explosion where there is a cloud of flammable gas/vapor which is within the flammable region and an ignition source creates a deflagration seen as a fireball.

unpiloted ignition—ignition point of a material due entirely to incident heat flux on object, with no pilot or spark present.

unprotected cable/circuit—a cable/circuit which is not provided with fire protection features sufficient to satisfy applicable requirements (Section III.G.2 of Appendix R or Position C.5.b of SRP 9.5.1).

unresolved safety issue (USI)—according to NUREG-0933, "A Prioritization of Generic Issues," a USI is defined as a matter affecting of nuclear power plants that poses important questions concerning the adequacy of existing safety requirements for which a final resolution has not yet been developed and that involves conditions not likely to be acceptable over the lifetime of the plants affected.

upper flammability limit—the highest concentration of fuel in air at normal temperatures and pressure that can support flame propagation is known as the upper flammability limit (UFL) or upper explosive limit (UEL).

vapor barrier—that material used to prevent or substantially inhibit the transfer of water, corrosive liquids and steam or other hot vapors from the outside of a garment to the wearer's body.

vaporization temperature—the temperature of a vaporizing fuel while burning, or needed to cause vaporization.

vent, heat, and smoke—an assembly rated for the release of heat or smoke from a fire event. Heat and smoke vents are commonly provided in the roofs of buildings. They may be activated by means of automatic detection or constructed of materials that cause the material to melt from the heat of the fire and create an opening for venting. The sizing of heat or smoke vents should be based on the anticipated fire event.

vent flow—if there is an opening to the adjacent room or out to the atmosphere, the smoke will flow out through it as soon as the hot layer reaches the top of the opening. Often, the increasing heat in the enclosure will cause the breakage of windows and thereby create an opening.

ventilation—the process of supplying or removing an atmosphere to or from any space by natural or mechanical means.

ventilation factor—the parameter controlling smoke flow rate through a door or window

ventilation-limited or ventilation-controlled—state of a compartment fire where the air supply is limited; smoke gases will have nearly zero oxygen left; under-ventilated

ventilation-controlled fire—a fire which the heat release rate or growth is controlled by the amount of air available to the fire. (NFC Online Glossary)

ventilation, mechanical—the use of exhaust fans, blowers, air conditioning systems, or smoke ejectors to remove products of combustion (smoke, heat, gases) from an area affected by a fire event. (Nolan, 2000)

ventilation rate—ventilation rate is based on air changes per hour and is calculated by the use of 100-percent outside air for the supply air that is exhausted. Air changes per hour is calculated on the basis of the maximum aggregate volume (under normal operating conditions) of the space to be ventilated. (NFC Online Glossary)

venting, fire—the escape of smoke, noxious or toxic fumes, and heat through openings in a building provided as part of the structure (a chimney) or instituted during emergency fire-fighting actions

for the removal of hot gases and smoke particles. In fire conditions, it is generally accepted that the efficient venting of heat, hot gases, and smoke reduces the lateral spread and subsequent damage and enables firefighters to more easily enter a building on fire and begin fire protection measures. In order for roof or ceiling vents to operate efficiently, there has to be an adequate source of low level replacement air. Ventilation through the top of a structure or its roof vents or similar devices (skylights) is called vertical ventilation or top ventilation. (Nolan, 2000)

view factor—the ratio of the incident radiation received by a surface to the emissive power from the emitting surface per unit area.

visibility—the maximum distance one can recognize objects, often referring to an exit sign in a smoke-filled compartment.

voltage—the effective root-mean-square (rms) potential between any two conductors or between a conductor and ground. Voltages are expressed in nominal values unless otherwise indicated. (IEEE Std 100-1988)

Clarification: The electrical force that causes free electrons to move from one atom to another. Similar to pressure in a water pipe.

water curtain—a screen or wide angle spray of water that is set up and used to protect exposures from fire effects mainly from radiated heat, smoke, and billowing flames. It normally consists of open or closed sprinkler heads or perforated pipes installed on the exterior of a building at eaves, cornices, window openings, or peaked roofs under manual control, or installed around the openings in floors or walls of a building with the water supply under thermostatic control. Manual firefighting operations may also provide and position water spray nozzles to provide a water curtain to protect exposures. It may also be called a water screen.

water damage—the damage sustained to a property as a direct result of water-based fire-fighting efforts or because of leakage from a fixed water-based suppression system (sprinkler system).

water flow alarm—a sounding device activated by a water-flow detector or alarm check valve and arranged to sound an alarm that is audible in all living areas over background noise levels with all intervening doors closed.

water flow detector—an electric signaling indicator or alarm check valve actuated by water flow in one direction only.

water flow switch—an assembly approved for the service and so constructed and installed that any flow of water from sprinkler system equal to or greater than that from a single automatic sprinkler of the smallest orifice size installed on the system will result in activation of this switch and subsequently indicate an alarm condition.

water flow test—an evaluation of water supplies and a piping distribution network to determine whether it is of sufficient capacity and pressure to provide or meet fire protection needs or requirements. Static pressure, residual pressure, hydraulic profile, and flow rates may be obtained during water flow tests. (Nolan, 2000)

water horsepower—power necessary to move water.

water supply—source of water for fire protection purposes typically described in terms of volume, flow rate, and pressure.

Watt—Power necessary to move a weight of 1 newton a distance of 1 meter in 1 second. One horsepower is equal to 746 watts.

wet chemical—normally a solution of water and potassium carbonate-based chemical, potassium acetate-based chemical, potassium citrate-based chemical, or a combination thereof that forms an extinguishing agent.

wet chemical—a solution of water and potassium carbonate-based chemical, potassium acetate-based chemical, or a similar combination that is used as a fire extinguishing agent. Its application may cause corrosion or staining of the protected equipment if not removed. Wet chemical solutions are generally considered relatively harmless and normally have no lasting significant effects on human skin, the respiratory system, or personal clothing. (Nolan, 2000)

wet chemical fire suppression system—an automatic fire suppression system that uses a liquid agent. It is applied through a system of piping and nozzles with an expellant gas from a storage cylinder. It is usually released by automatic mechanical thermal linkage. The agent leaves a residue that is confined to the protected area that must be removed after application. Primarily applied to having cooking range hoods and ducts and associated appliances. The wet chemical agent consist of water and usually potassium carbonate or potassium acetate. (Nolan, 2000)

wetting agent—a wetting agent is a chemical compound that, when added to water in amounts indicated by the manufacturer, will materially reduce the water's surface tension, increase its penetrating and spreading abilities, and might also provide emulsification and foaming characteristics. Decreased surface tension disrupts the forces holding the film of water together, thereby allowing it to flow and spread uniformly over solid surfaces and to penetrate openings and recesses over which it would normally flow. Water treated in this manner not only spreads and penetrates, but displays increased absorptive speed and superior adhesion to solid surfaces. Water normally has a surface tension of 73 dynes per centimeter and wetting agents can lower it to about 25 dynes per centimeter. Leaks in piping connections and pump packing can occur that would not have occurred if the wetting agent had not been used. Visual inspection should be made during wet water operations. Wet water should be applied directly to the surface of the combustible. These agents do not increase the heat absorption capacity of water, but the greater spread and penetration of the wet water increase the efficiency of the extinguishing properties of water, as more water surface is available for heat absorption and run-off is decreased. Therefore they enhance fire control and suppression applications, especially for three dimension fires. Wetting agents are broadly defined as being surfactants (surface acting agents). All wetting agents are concentrated and are mixed with a liquid at varying percentages (usually 1 to 2 per-cent). The wetting agent can be liquid or powder. The liquid into which it is mixed for firefighting purposes is water. However, the primary sales for some wetting agents are for use as a carrier for liquid fertilizers, fungicides, insecticides, and herbicides. These wetting agents can be, and are, used for firefighting purposes. They do not have additives that protect tanks, pumps, valves, and bushings, etc., so it is recommended that unused mixtures be drained out of the tank and a flush of all parts made with plain water. With all wetting agents, hard water usually requires a greater amount of additive to produce the same results. Wetting agents designed for fire department use will normally contain rust inhibitors to protect the tank, pump, piping, and valves. Generally, the mixture loses some of its rust-inhibiting characteristics if left in the tank. Wetting agents are best used as a soaking or penetrating agent for a three-dimensional burning mass such as wild-land fuels, coal piles, sawdust, cotton (bales, bedding, upholstery), rags, paper, etc. These agents are used very

effectively on smoldering or glowing combustibles. All of the commercially available products that fall into the pre-ceding category will satisfactorily suppress Class A fires. (Nolan, 2000)

wet water—firefighting water to which a wet-ting agent has been added to reduce its surface tension and increase its penetrating power into the fire environment. Wet water is useful in congested environments where normal water application may be blocked or restricted. Wet water can more easily seep into inaccessible areas.

worst case scenario—a scenario resulting in the worst consequence as defined by the stakeholders or a code. The criteria must be explicitly stated because worst case conditions for life safety and property protection might be incompatible.

worst credible fire—For a specific site, a fire, as defined by the stakeholders or a code, that can be reasonably expected to result in unfavorable consequences equal to or less severe than those resulting from a worst case scenario.

yield strength—yield strength, both compressive and tensile, is degraded by an increase in temperature. This loss of strength can result in the mechanical failure of an element at an elevated temperature. The temperature dependence of the yield strength is a multi-variate function.

zone smoke control—a smoke control system that provides smoke exhaust for a smoke zone and pressurization of all adjacent smoke control zones, thereby providing removal of smoke from the primary area of concern and using preventive measures to avoid additional smoke infiltration to primary area of concern. (Nolan, 2000)

References

Friedman, R., *Principles of Fire Protection Chemistry and Physics*, 3rd Edition, National Fire Protection Association, Quincy, Massachusetts, 1998.

NFC Online Glossary, National Fire Protection Association, Quincy, Massachusetts.

NFPA 30, "Flammable and Combustible Liquids Code," National Fire Protection Association, Quincy, Massachusetts.

NFPA 805, "Performance-Based Standard for Fire Protection for Light Water Reactor Electric Generating Plants," National Fire Protection Association, Quincy, Massachusetts

Nolan, D.P., *Encyclopedia of Fire Protection*, Delmar Publishers, Albany, New York, 2000.

Quintiere, J.G., *Principles of Fire Behavior*, Delmar Publishers, Albany, New York, 1997.

McGraw-Hill Dictionary of Scientific and technical Terms, 5th Edition, S.P. Parker, Editor in Chief, McGraw-Hill, Inc., New York, 1993.

Nuclear Regulatory Commission (U.S.) (NRC). Fire Protection for Operating Nuclear Power Plants, Regulatory Guide 1.189. April 2001.

This page intentionally left blank.

APPENDIX G. ABBREVIATIONS USED IN FIRE PROTECTION ENGINEERING

This page intentionally left blank.

APPENDIX G. ABBREVIATIONS USED IN FIRE PROTECTION ENGINEERING

The purpose of this appendix is to provide abbreviations of the numerous engineering and scientific terms that appear in fire protection printed and electronic information. This collection has been compiled from various sources [e.g., National Fire Protection Association (NFPA), Society of Fire Protection Engineers (SFPE)]. No one abbreviation is recommended to the exclusion of another because the same abbreviation may with equal validity apply to two or more terms. The following abbreviations are commonly used in the field of fire science, engineering, and technology.

| | |
|----------------|---|
| ACI | American Concrete Institute |
| AIChE | American Institute of Chemical Engineers |
| ACMV | Air Conditioning and Mechanical Ventilation |
| ACV | Alarm Check Valve |
| ADA | Americans with Disabilities Act |
| ADAAG | Americans with Disabilities Act Accessibility Guidelines |
| ADD | Actual Delivered Density |
| AFA | Automatic Fire Alarm |
| AFAA | Automatic Fire Alarm Association (USA) |
| AFD | Aspirating Fire Detection |
| AFFF | Aqueous Film-forming Foam (fire suppression agent) |
| AFP | Active Fire Protection |
| AFSA | American Fire Sprinkler Association |
| AFT | Adiabatic Flame Temperature |
| AHJ | Authority Having Jurisdiction |
| AIA | American Insurance Association |
| AISC | American Institute of Steel Construction |
| AISI | American Iron and Steel Institute |
| AIT | Autoignition Temperature |
| ALC | Approximate Lethal Concentration |
| ALV | Alarm Valve |
| ANSI | American National Standards Institute |
| AOV | Air-Operated Valve |
| AP | Annunciator Panel (fire alarm) |
| AR-AFFF | Alcohol Resistant-Aqueous Film Forming Foam (fire suppression agent) |
| ARC | Alcohol-Resistant Concentrates |
| ARV | Air Release Valve |
| AS | Automatic Sprinkler |
| ASCE | American Society of Civil Engineers |
| ASD | Automatic Smoke Detection |
| ASET | Available Safe Egress Time |
| ASSE | American Society of Safety Engineers |
| ASET | Available Safe Egress Time |
| ASHRAE | American Society of Heating, Refrigerating, and Air Conditioning Engineers |
| ASME | American Society of Mechanical Engineers |
| ASMET | Atria Smoke Management Engineering Tools |
| ASRS | Automatic Storage and Retrieval System |
| AST | Aboveground Storage Tank |
| ASTM | American Society for Testing and Materials |

| | |
|-----------------------|--|
| ATC | Alcohol Type Concentrate |
| ATS | Automatic Transfer Switch |
| AWG | American Wire Gage |
| BCMC | Board of Coordination of the Model Code |
| BHF | Bureau of Home Furnishings |
| BHP | Brake Horsepower |
| BI | Barrier Integrity |
| BLEVE | Boiling Liquid Expanding Vapor Explosion |
| BOCA | Building Officials and Code Administrators International, Inc. |
| BNBC | BOCA National Building Code |
| BNFPC | BOCA National Fire Prevention Code |
| BOMA | Building Owners and Managers Association |
| BOP | Blowout Preventor (valve) |
| BP | Boiling Point Temperature |
| BSD | Beam Smoke Detector |
| BTU | British Thermal Unit |
| BFRL | Building and Fire Research Laboratory (USA) |
| CABO | Council of American Building Officials |
| CAFS | Compressed Air Foam System |
| CAFSS | Clean Agent Fire Suppression System |
| CCDS | Critical Combustible Data Sheet |
| CCFM | Consolidated Compartment Fire Model (computer code developed by NIST) |
| CCPA | Center of Chemical Process Safety (AIChE) |
| CDG | Carbon Dioxide Generation Calorimetry |
| CDS | Chemical Data System |
| CFAST | Consolidated Model of Fire Growth and Smoke Transport (computer code developed by NIST) |
| CFI | Certified Fire Investigator (NFPA) |
| CFPE | Certified Fire Plan Examiner (NFPA) |
| CFD | Computational Fluid Dynamics |
| CFPS | Certified Fire Protection Specialist (NFPA) |
| CFR | <i>Code of Federal Regulation</i> |
| CFSI | Congressional Fire Service Institute (USA) |
| CGA | Compressed Gas Association (USA) |
| CHF | Critical Heat Flux |
| CIB | Conseil International du Batiment |
| CLE | Coefficient of Linear Expansion |
| CNG | Compressed Natural Gas |
| CO | Carbon Monoxide |
| CO₂ | Carbon Dioxide |
| COR | Code of Record |
| COHB | Carboxyhemoglobin |
| CSAA | Central Station Alarm Association |
| CSDS | Critical Screen Data Sheet |
| CSI | Construction Specifications Institute |
| CSRF | Construction Sciences Research Foundation |
| CSP | Certified Safety Professional (Board of Certified Safety Professionals, USA) |
| CSPS | Consumer Product Safety Commission (USA) |
| CV | Check Valve |

| | |
|----------------|--|
| CVD | Combustible Vapor Dispersion |
| DACR | Digital Alarm Communicator Receiver |
| DACS | Digital Alarm Communicator System |
| DACT | Digital Alarm Communicator Transmitter |
| DARR | Digital Alarm Radio Receiver |
| DARS | Digital Alarm Radio System |
| DART | Digital Alarm Radio Transmitter |
| DC | Dry Chemical (fire extinguisher agent) |
| DCVA | Double Check Valve Assembly |
| DD | Duct Detector |
| DDT | Deflagration-to-Detonation Transition |
| DH | Double Outlet, Fire Hydrant |
| DID | Defense-in-Depth |
| DIERS | Design Institute for Emergency Relief Systems |
| DP | Dry Pipe or Dry Pendant Sprinkler |
| DPV | Dry Pipe Valve |
| EC | Expansion Coefficient |
| EDS | Explosive Detection System |
| EFP | Electric Fire Pump |
| EFS | Equivalent Fire Severity |
| ELO | Extra Large Orifice (sprinkler) |
| EEBD | Emergency Egress Breathing Device |
| ELO | Extra Large Orifice |
| EMD | Electric Motor Driven |
| EOLR | End of Line Resister |
| EPA | Environment Protection Agency (USA) |
| ER | Electrical Resistance |
| ERFBS | Electric Raceway Fire Barrier System |
| ESF | Engineered Safety Feature |
| ESFR | Early Suppression Fast Response (sprinkler) |
| ESS | Emergency Shutdown System |
| ETA | Event Tree Analysis |
| ESW | Emergency Service Water |
| FA | Fire Alarm |
| FACP | Fire Alarm Control Panel |
| FAG | Fire Alarm Group |
| FAST | Fire Growth and Smoke Transport (computer code developed by NIST) |
| FB | Fire Brigade |
| FCIA | Fire Compartment Interaction Analysis |
| FCP | Fire Control Plan |
| FD | Fire Department, Fire Damper, Fire Detection |
| FDC | Fire Department Connection, Functional Design Criteria |
| FDI | Fire Detection Institute (USA) |
| FDPC | Fire Department Pumper |
| FDU | Fire Detecting Unit |
| FE | Fire Endurance, Fire Escape, Fire Extinguisher |
| F&E | Fire and Explosion |
| FDMS | Fire Data Management System |
| FDS | Fire Dynamics Simulator (CFD computer code developed by NIST) |

| | |
|----------------|--|
| FED | Fractional Effective Exposure Dose |
| FEDB | Fire Event Data Base |
| FED | Fractional Effective Dose |
| FEHM | Fire and Explosion Hazard Management |
| FEMA | Federal Emergency Management Agency (USA) |
| FERP | Fire Emergency Response Plan |
| FFFP | Film-forming Fluoroprotein foam (fire suppression foam agent) |
| FFM | Furniture Fire Model |
| FFR | Fire-Resistance Rating |
| FGC | Fireground Command |
| FH | Fire Hydrant, Fire Hose |
| FHA | Fire Hazards Analysis or Assessment |
| FHAR | Fire Hazards Analysis Report |
| FHR | Fire Hose Reel |
| FHSR | Fire Hazards Safety Report |
| FHZ | Fire Hazard Zone |
| FIDO | Fire Incident Data Organization (NFPA) |
| FID | Fractional Incapacitating Dose |
| FIGRA | Fire Growth Rate Index |
| FIVE | Fire Induced Vulnerability Evaluation |
| FL | Friction Loss |
| FLC | Friction Loss Coefficient |
| FLD | Fractional Lethal Dose |
| FLED | Fire Load Energy Density |
| FMANA | Fire Marshals Association of North America |
| FM | Fire Modeling |
| FMEA | Failure Mode and Effect Analysis |
| FMRC | Factory Mutual Research Corporation (USA) |
| FP | Fire Protection, Fire Pump |
| FP | Flash Point, Flammability Parameter |
| FPE | Fire Protection Engineer |
| FPETOOL | Fire Protection Engineering Tools for Hazard Estimation (computer code developed by NIST) |
| FPFG | Fire Protection Focus Group |
| FPH | Fire Pump House |
| FPI | Fire Propagation Index |
| FPFI | Fire Protection Functional Inspection |
| FPR | Fire Protection Rating |
| FPS | Fire Protection System |
| FPSS | Fire Protection and Supporting Systems |
| FPWG | Fire Protection Working Group |
| FR | Fire Retardant |
| FRAM | Fire Risk Assessment Method |
| FRIS | Fire Research Information Services (NIST) |
| FRG | Fire Resisting Glazing |
| FS | Flow Switch (water) |
| FSAR | Final Safety Analysis Report |
| FSBBS | Fire Safety Bulletin Board System (NIST) |
| FSCS | Fire Fighter's Smoke-Control Station |

| | |
|--------------|---|
| FSES | Fire Safety Evaluation System |
| FSHA | Federal Hazardous Substance Act |
| FSI | Flame Spread Index |
| FSR | Flame Spread Rating |
| FSS | Fire Suppression System |
| FSM | Fire Screening Methodology |
| FSSD | Fire Safe Shutdown |
| FTA | Fault Tree Analysis |
| FW | Fire Water |
| FWP | Firewater Pump |
| FWS | Firewater System |
| GC/MS | Gas Chromatography/Mass Spectrometry |
| GBHP | Gross Break Horsepower |
| GPM | Gallon Per Minute |
| GTR | Gas Temperature Rise Calorimetry |
| HAD | Heat-Activated Device, Heat-Actuated Device |
| HAG | Halon Alternative Group |
| HALON | Halogenated Hydrocarbon (Gaseous fire suppression agent) |
| HAZOP | Hazard and Operability Study |
| HC | Hose Cabinet, Hose Connection |
| HCFC | Hydrochlorofluorocarbon |
| HCN | Hydrogen Cyanide |
| HCP | Halon Control Panel |
| HCS | Hydrogen Control System |
| HD | Heat Detector, Heat of Decomposition |
| HDA | Heat Actuated Device |
| HEPA | High-Efficiency Particulate Air |
| HFC | Hydrofluorocarbon |
| HG | Hydrogen Gas |
| HGL | Hot Gas Layer |
| HIFT | High Intensity Fire Testing |
| HMIS | Hazardous Materials Inventory Statement |
| HMIS | Hazardous Materials Identification System |
| HMMP | Hazardous Materials Management Plan |
| HMR | Hazardous Materials Regulations |
| HPM | Hazardous Production Materials |
| HP | Heat of Polymerization |
| HPR | Highly Protected Risk |
| HRR | Heat Release Rate |
| HRC | Halon Recycling Corporation |
| HRP | Heat Release Parameter |
| HSSC | Highly Safety Significant Component |
| HSSD | High Sensitivity Smoke Detection |
| HST | Hot-Smoke Test |
| HTA | High Temperature Accelerant |
| HTF | Heat Transfer Fluid |
| HTOC | Halon Technical Options Committee |
| HVAC | Heating, Ventilation, and Air Conditioning |
| HX | Heat Exchanger |

| | |
|------------------------|--|
| GN₂ | Gaseous Nitrogen |
| IAFC | International Association of Fire Chiefs |
| IAFSS | International Association of Fire Safety Science |
| ICBO | International Conference of Building Officials |
| I&C | Instrumentation and Controls |
| ICC | International Code Council |
| ICE | International Electrotechnical Commission |
| ICS | Incident Command System |
| IDC | Initiating Device Circuits |
| IE | Initiating Events |
| IEC | International Electrotechnical Commission |
| IEEE | Institute of Electrical and Electronic Engineers, Inc. |
| IFCI | International Fire Code Institute |
| ILBP | In-Line Balanced Proportioner |
| IPA | Integrated Plant Assessment |
| IP | Inert Point, Inspection Procedure |
| IR | Infrared |
| IRI | Industrial Risk Insurers |
| ISDS | Ignition Source Data Sheet |
| ISI | Inservice Inspection |
| ISO | International Organization for Standardization |
| IST | Inservice Testing |
| ITM | Inspection, Testing, and Maintenance |
| JCAHO | Joint Commission on Accreditation of Health Organizations |
| LBTF | Large Building Test Facility |
| LC | Limited-Combustible |
| LC₅₀ | The Concentration Lethal 50 Percent of a Population |
| LD₅₀ | Respiratory Depression |
| L/D | Length to Diameter |
| LDH | Large Diameter Hose |
| LEL | Lower Explosive Limit |
| LES | Large Eddy Simulation |
| LFG | Liquefied Flammable Gas |
| LFL | Lower Flammability Limit |
| LFS | Limiting Fire Scenarios |
| LHD | Linear Heat Detection |
| LIFT | Lateral Ignition and Flame Spread Test (ASTM E1321) |
| LNG | Liquefied Natural Gas |
| LO | Large Orifice (sprinkler) |
| LOC | Limiting Oxidant Concentration, Lower Oxygen Concentration, Loss of Containment |
| LOI | Limiting Oxygen Index |
| LOX | Liquid Oxygen |
| LP | Liquefied Petroleum |
| LPG | Liquefied Petroleum Gas, Liquefied Propane Gas |
| LRFD | Load and Resistance Factor Design |
| LSC | Life Safety Code® (NFPA 101) |
| LOST | Lube Oil Storage Tank |
| M/A | Manual or Automatic |
| MAC | Manual Activation Call Point (fire alarm) |

| | |
|---------------|---|
| MAG | Maximum Allowable Concentration |
| MCFL | Maximum Credible Fire Loss |
| MC | Moisture Content |
| MCSC | Model Codes Standardization Council |
| MDH | Medium Diameter Hose |
| MEC | Minimum Explosive Concentration |
| MEFS | Maximum Expected Fire Scenario |
| MESG | Maximum Experimental Safe Gap |
| MIC | Minimum Ignition Current, Microbiologically Influenced Corrosion |
| MIE | Minimum Ignition Energy |
| MLR | Mass Loss Rate |
| MOC | Maximum Allowable Oxygen Concentration |
| MOD | Mass Optical Density |
| MOV | Motor Operated Valve |
| MPFL | Maximum Possible Fire Loss |
| MPS | Manual Pull Station |
| MPV | Minimum Proper Value |
| MS | Mitigating Systems |
| MSDS | Material Safety Data Sheet |
| NAG | Notification Appliance Circuits |
| NAFED | National Association of Fire Equipment Distributors (USA) |
| NBFAA | National Burglar and Fire Alarm Association, Inc. (USA) |
| NBHP | Net Break Horsepower |
| NBFU | National Board of Fire Underwriters |
| NC | Non-Combustible, Non-Compliance |
| NCEES | National Council of Examiners for Engineering and Surveying |
| NCHRR | Normalized Chemical Heat Release Rate |
| NCSBCS | National Conference of States on Building Codes and Standards |
| NEC | National Electrical Code® (NFPA 70) |
| NFC | National Fire Code |
| NFDC | National Fire Data Center (USA) |
| NFD | Nominal Fire Duration |
| NFDRS | National Fire Danger Rating System (USA) |
| NFIC | National Fire Information Council (USA) |
| NFIRS | National Fire Incident Reporting System (FEMA/USFA) |
| MFL | Maximum Allowable Fuel Loading |
| NFPRF | National Fire Protection Research Foundation (USA) |
| NBS | National Bureau of Standards (now NIST) |
| NEMA | National Electric Manufacturers Association |
| NFPA | National Fire Protection Association (USA) |
| NFPRF | National Fire Protection Research Foundation (USA) |
| NFR | Non-Fire Retardant |
| NFSA | National Fire Sprinkler Association (USA) |
| NHT | National Hose Thread |
| NIBS | National Institute of Building Sciences (USA) |
| NICET | National Institute for Certification in Engineering Technologies (USA) |
| NIFC | National Interagency Fire Center (USA) |
| NIOSH | National Institute for Occupation Safety and Health (USA) |
| NIST | National Institute of Standards and Technology (USA) |

| | |
|--------|---|
| NLE | Normal Loss Expectancy |
| NPP | Neutral Pressure Plane |
| NPSH | Net Positive Section Head |
| NPSHA | Net Positive Section Head Available |
| NPSHR | Net Positive Section Head Required |
| NRS | Nonrising Stem (gate valve) |
| NRTL | Nationally Recognized Testing Laboratory |
| NS | Non-sprinklered |
| NSC | National Safety Council |
| NST | National Standard Thread |
| NTP | Normal Temperature and pressure |
| NUMARC | Nuclear Management and Resources Council |
| OC | Over Compliance |
| OD | Optical Density, Outer Diameter |
| ODP | Ozone Depletion Potential |
| ODS | Ozone Depleting Substance |
| OI | Oxygen Index |
| OSHA | Occupational Safety and Health Administration (USA) |
| OSR | Operational Safety Requirement |
| FSS | Fire Systems Services |
| OS | Open Sprinkler |
| OS&Y | Outside Stem and York or Outside Screw and Yoke (valve) |
| OWSI | Open Web Steel Joist |
| PASS | Personal Alert Safety System |
| PAV | Pre-Action Valve |
| PCV | Pressure Control Valve |
| PDP | Pump Discharge Pressure |
| PDS | Point of Demand Supply |
| PE | Professional Engineer (NCEES) |
| PEL | Permissible Exposure Limit |
| PFC | Perfluorocarbon |
| PFDAS | Plant Fire Detection and Alarm System |
| PFHA | Preliminary Fire Hazard Analysis |
| PFP | Passive Fire Protection |
| PFPCDS | Plant Fire Protection Carbon Dioxide Subsystem |
| PFPHS | Plant Fire Protection Halon Subsystem |
| PFPS | Plant Fire Protection System |
| PFPWS | Plant Fire Protection Water Subsystem |
| PHA | Process Hazard Analysis |
| PHRR | Peak Heat Release Rate |
| PIM | Performance Integrity Measure |
| PIV | Post Indicator Valve |
| PLFA | Power-Limited Fire Alarm (circuits or cables) |
| PLG | Pressure Liquefied Gas |
| PML | Probable Maximum Loss |
| P&IDs | Piping & Instrumentation Diagram, Piping & Instrumentation Drawing, Process & Instrumentation Diagram |
| pphm | Parts Per Hundred Million |
| ppm | Parts Per Million |

| | |
|-----------------|---|
| PPV | Positive Pressure Ventilation |
| PRA | Probabilistic Risk Assessment |
| PRV | Pressure Relief Valve |
| PSA | Probabilistic Safety Analysis or Probabilistic Safety Assessment |
| PSF | Potential of Fire Spread |
| PSV | Pressure Safety Valve |
| PS | Pressure Switch, Pull Station (fire alarm, manual) |
| PZR | Pressurizer |
| QH | Quadruple Outlet, Fire Hydrant |
| QOD | Quick Opening Devices |
| QR | Quick-Response (sprinkler) |
| QRA | Quantitative Risk Analysis or Quantitative Risk Assessment |
| QRES | Quick-Response Early Suppression (sprinkler) |
| RARSR | Radio Alarm Repeater Station Receiver |
| RASSR | Radio Alarm Supervising Station Receiver |
| RAS | Radio Alarm System |
| RAT | Radio Alarm Transmitter |
| RCAP | Root Cause Analysis Report |
| RDD | Required Delivered Density |
| RHR | Rate of Heat Release |
| RF | Radio Frequency |
| RI/PB FP | Risk-Informed and Performance-Based Fire Protection |
| RMV | Respiratory Minute Volume |
| ROR | Rate of Rise |
| RPE | Respiratory Protection Equipment |
| RPM | Revolution Per Minute |
| RPZ | Reduced Pressure Zone (water) |
| RSET | Required Safe Egress Time |
| RTI | Response Time Index |
| RV | Riser Valve, Relief Valve |
| RVP | Reid Vapor Pressure |
| SAWG | Severe Accident Working Group |
| SBC | Standard Building Code |
| SBCCI | Southern Building Code Congress International, Inc. |
| SCBA | Self-Contained Breathing Apparatus |
| SCFM | Standard Cubic Feet Per Minute |
| SD | Smoke Detector, Smoke Damper |
| SDH | Small Diameter Hose |
| SDI | Smoke Density Index or Smoke Developed Index or Smoke Damage Index |
| SDP | Significance Determination Process |
| SEA | Specific Extinction Area |
| SEI | Structural Engineering Institute (USA) |
| SEP | Surface Emissive Power |
| SEPSS | Stored Emergency Power Supply System |
| SF | Safety Factor |
| SFP | Steam Fire Pump |
| SFPC | Standard Fire Prevention Code |
| SFPE | Society of Fire Protection Engineers (USA) |
| SHEVS | Smoke and Heat Exhaust Ventilation System |

| | |
|---------------|---|
| SIS | Safety Instrumented Systems |
| SL | Stoichiometric Limit |
| SLC | Signaling Line Circuits |
| SMS | Smoke Management System |
| SMACNA | Sheet Metal and Air Conditioning Contractors' National Association, Inc. (USA) |
| SOP | Standard Operating Procedures |
| SPR | Smoke Production Rate |
| SRV | Safety Relief Valve |
| STA | Success Tree Analysis |
| STD | Standard Orifice Sprinkler |
| STP | Standard Temperature and Pressure |
| SSCs | Systems, Structures, and Components |
| SSP | Standard Spray Pendant (sprinkler head) |
| SSU | Standard Spray Upright (sprinkler head) |
| STI | Steel Tank Institute |
| STTC | Standard Time-Temperature Curve (ASTM E119) |
| SV | Smoke Vent, Safety Valve |
| SW | Service Water |
| TC | Thermocouple |
| TDL | Threshold Damage Limit |
| TDR | Tender Delivery Rate |
| TGA | Thermogravimetric Analysis |
| THC | Total Unburned Hydrocarbons |
| THR | Total Heat Released |
| TLV | Threshold Limit Value |
| TNT | Trinitrotoluene |
| TPP | Thermal Protective Performance |
| TR | Temperature Rise |
| TRP | Thermal Response Parameter |
| TSR | Total Smoke Released |
| TTI | Time to Sustained Ignition |
| TV | Tidal Volume |
| TWA | Time Weighted Average |
| UBC | Uniform Building Code |
| UEL | Upper Explosive Limit |
| UFC | Uniform Fire Code |
| UFL | Upper Flammability Limit |
| UFSAR | Updated Final Safety Analysis Report |
| UL | Underwriter's Laboratories, Inc. |
| UPS | Uninterruptible Power Supply |
| UFSAR | Updated Final Safety Analysis Report |
| USFA | United States Fire Administration |
| UST | Underground Storage Tank |
| UV | Ultraviolet |
| VESDA | Very Early Smoke Detection and Alarm |
| UVCE | Unconfined Vapor Cloud Explosion |
| VCE | Vapor Cloud Explosion |
| VOC | Volatile Organic Compound |
| VSP | Volume of Smoke Production |

| | |
|--------------|---|
| WATS | Wide Area Telephone Service |
| WE | Wet Chemical (fire extinguisher agent) |
| WCCE | Worst Case Creditable Event |
| WH | Wall Hydrant |
| WHMIS | Workplace Hazardous Materials Identification Systems |
| WHP | Water Horsepower |
| WIC | Withstand and Interrupting Current |
| WOBO | World Organization of Building Officials |
| WOM | Water Oscillating Monitor |
| WPIV | Wall Post Indicator Valve |
| WSO | World Safety Organization |
| ZV | Zone Valve (sprinkler) |

This page intentionally left blank.

APPENDIX H. SELECTED U.S. COMMERCIAL NUCLEAR POWER PLANT FIRE INCIDENTS

H.1 Introduction

Over the past few decades, a number of large fires have occurred in commercial nuclear power plants (NPP), both in the United States and abroad. Particularly notable among the U.S. events was the cable spreading room (CSR) and reactor building fire at Browns Ferry Nuclear Power Plant (BFNP) in 1975, in which a single fire partially or totally disabled numerous safety- and nonsafety-related systems.

Empirical data indicate that a nuclear facility will experience event precursors (in this case, smaller fires that have no impact on nuclear safety) more frequently than actual fires affecting nuclear safety equipment (such as the BFNP fire). Many argue that no fire in a NPP is without nuclear safety implications because every fire threatens safety through its effects on either equipment or personnel operating the facility. Nevertheless, the industry expects a NPP to experience a fire that affects nuclear safety equipment every 6 to 10 years (Ramsey and Modarres, 1998).

The remainder of this appendix provides a summary table and detailed narrative discussions concerning the major fires that have occurred at U.S. commercial NPPs since 1968. The specific incidents included are those fires that led to severe or widespread damage and those that challenged nuclear safety. Additional detail concerning these fire incidents is available in the NRC inspection reports and licensee event reports (LERs)¹.

These general description are provided for information only. The events can be used to develop real life example problems for use with the fire dynamics spreadsheets.

Reference

Ramsey, C.B., and M. Modarres, *Commercial Nuclear Power Assuring Safety For The Future*, John Wiley & Sons, Inc., New York, 1997.

¹Licensee event reports (LERs) are form reports that are often accompanied by narratives, which licensees and the nuclear industry submit to the U.S. Nuclear Regulatory Commission, in accordance with the regulatory requirements following the occurrence of reportable events. Oak Ridge National Laboratory (ORNL) maintains all LERs in a searchable database for use of NRC and its licensees.

| Table H.1-1. Summary of Selected U.S. Commercial Nuclear Power Plant Fire Incidents | | |
|--|--------------------------------------|---|
| Plant | Date of Incident | Description of Fire Incident |
| San Onofre Nuclear Generating Station, Unit 1 | February 7 and March 12, 1968 | Two similar incidents involving self-ignited cable fires took place within a 5-week period. On February 7, 1968, San Onofre Nuclear Generating Station (SONGS) Unit 1 experienced a self-ignited cable fire adjacent to a containment penetration and on March 12, 1968, another self-ignited cable fire occurred in a 480-volt switchgear room. These fires showed significant fire propagation beyond the initiating cable. The licensee reported that three horizontal stacked cable trays were burning at the time that the fire brigade arrived on the scene (several minutes after the apparent time of ignition). |
| Browns Ferry Nuclear Power Plant, Unit 1 | March 22, 1975 | A cable spreading room and reactor building fire challenged nuclear safety and led to important changes in the NRC's fire protection program. |
| North Anna Power Station, Unit 2 | July 3, 1981 | A severe fire involved a large transformer, but did not affect any safety-related components or electrical circuits. |
| Rancho Seco Nuclear Generating Station | March 19, 1984 | A hydrogen fire and explosion occurring in the turbine building. |
| Waterford Steam Electric Generating Station, Unit 3 | June 26, 1985 | This main feedwater pump fire involved operator error leading to a loss of redundant trains. The plant operator at the scene called the control room with the wrong pump tag number. This error resulted in the undamaged pump being shut down from the control room. |
| Fort St. Vrain Nuclear Generating Station | October 2, 1987 | This large turbine building fire involved hydraulic oil and affected control room habitability as a result of smoke ingress. |
| Oconee Nuclear Station, Unit 1 | January 3, 1989 | A fire in a nonsafety-related switchgear led to equipment failure. Smoke from fire propagates outside fire area (e.g., smoke control room from turbine building switchgear fire). In this incident equipment was unavailable to use water to suppress the fire, and fire induced independent failures challenge the operator. |

**Table H.1-1. Summary of Selected U.S. Commercial Nuclear Power Plant Fire Incidents
(continued)**

| Plant | Date of Incident | Description of Fire Incident |
|---|-------------------------|--|
| H.B. Robinson Steam Electric Plant, Unit 2 | January 7, 1989 | This event involved hydrogen fires at multiple locations during an outage because of maintenance crew error. |
| Calvert Cliffs Nuclear Power Plant, Unit 2 | March 1, 1989 | This incident involved multiple initial fires, including a small fire in the control room. |
| Shearon Harris Nuclear Power Plant | October 9, 1989 | This incident involved multiple initial and secondary fires involving one of the main transformers and electrical equipment in the turbine building. |
| Salem Nuclear Generating Station, Unit 2 | November 9, 1991 | This turbine building fire was caused by a turbine blade failure and ejection. |
| Waterford Steam Electric Generating Station, Unit 3 | June 10, 1995 | This incident involved a 4,160V switchgear cabinet fire. The cause of the fire was improper automatic bus transfer due to slow circuit breaker caused by hardened grease. A fire initiated inside a switchgear propagates outside of the switchgear boundary (e.g., arcing, smoke, ionized gases damaged four more switchgear cabinets; and overhead cables are damaged in part from failure of a cable tray fire barrier). The fire burned over an hour. The fire induced and independent equipment failures that challenge the operator. |
| Palo Verde Nuclear Generating Station, Unit 2 | April 4, 1996 | This incident involved multiple initial fires, including a small fire in the main control room. |
| San Onofre Nuclear Generating Station, Unit 3 | February 3, 2001 | This incident involved a circuit breaker fault resulted in a fire, loss of offsite power, and reactor trip. The damage extended to the associated electrical bus and cable trays in the switchgear room. A subsequent failure to start the turbine emergency DC lubricating (lube) oil pump resulted in extensive turbine damage. In this event, a 4.16-kV switchgear fault had an explosive release of energy and the ensuing fire was substantial enough to damage other plant equipment. |

**Table H.1-1. Summary of Selected U.S. Commercial Nuclear Power Plant Fire Incidents
(continued)**

| Plant | Date of Incident | Description of Fire Incident |
|---|------------------|---|
| Point Beach Nuclear Plant, Unit 1 | April 24, 2001 | <p>A small fire originate as the result of a short in a 12-Vdc communication box during a refueling outage in the steam generator (S/G) vault on the access platform to the primary side manway covers. The fire consumed a bag of rags and testing equipment debris, and lasted for approximately 23 minutes. After multiple failed attempts in which the fire brigade discharged approximately 70 pounds of dry chemical (3 portable fire extinguishers), the fire was finally extinguished using 15–20 gallons of water. The dry chemical fire extinguishing agent was dispersed through large areas of the S/G and reactor coolant pump (RCP) vaults. Certain chemicals in the extinguishing agent can result in potential stress corrosion cracking on the exposed stainless steel pipe and tube surfaces in the presence of halogens (chlorides, fluorides, and sulfates) with high temperatures (greater than 250 °F). contaminating of motors, air-operated valves, safety-related snubbers, and other electrical contacts and components. This incident illustrated the importance of fire extinguishing practice and the choice and use of fire extinguishing agents.</p> |
| Prairie Island Nuclear Generating Plant, Unit 1 | August 3, 2001 | <p>A fire occurred in a 4,160V nonsafety-related electrical panel on Unit 1, during initial startup while plant operators were transferring the plant's electrical power from reserve transformer to the main transformer. The breaker failure initiated a fire in cubicle 12-4 of bus 12. The failure also actuated the generator transformer protective relaying scheme, including a lockout of bus 12. The bus lockout opened breaker 12-1 (bus 12 is the source from the 1RX transformer), and actuated the protective relaying scheme. The protective relaying scheme initiated a turbine/reactor trip and actuation of the auxiliary feedwater system.</p> |

**Table H.1-1 Summary of Selected U.S. Commercial Nuclear Power Plant Fire Incidents
(continued)**

| Plant | Date of Incident | Description of Fire Incident |
|---------------------------------|-------------------|---|
| Fort Callhoun Station, Unit 1 | December 19, 2001 | A fire occurred in a corridor between safety injection pump room 22 and the containment tension stressing gallery as a result of an overloaded extension cord used to supply power to a 55-gallon grease drum heater. The fire ignited ordinary combustible materials in the area. Room 22 was completely filled with dense smoke in addition to spreading to adjacent remote areas. The smoke travel resulted in a deluge system actuating in the auxiliary building stairwell (water curtain). The ensuing water sprayed onto safety-related motor control centers (MCCs), causing shorts on safety-related circuits. The water curtain was required since there is no fixed fire barrier between the fire areas. The root cause of this fire event was determined to be unauthorized modifications to the male connection of an extension cord, which resulted in overheating and the subsequent fire. |
| McGuire Nuclear Station, Unit 2 | August 23, 2002 | A fire occurred from a leak in the hydrogen dryer associated with the Unit 2 turbine generator. The fire area was in the Unit 2 turbine building, one level below the turbine. The automatic sprinkler system activated in response to the fire alarm. A manual reactor trip was initiated and Unit 2 experienced an elevated steam generator water level. The plant fire brigade responded to the hydrogen dryer fire and isolated the hydrogen leak. |

This page intentionally left blank.

San Onofre Nuclear Generating Station, Unit 1, February 7 and March 12, 1968

Two similar incidents involving self-ignited cable fires took place within a 5-week period. On February 7, 1968, San Onofre Nuclear Generating Station (SONGS) Unit 1 experienced a self-ignited cable fire adjacent to a containment penetration and on March 12, 1968, another self-ignited cable fire occurred in a 480-volt switchgear room. These fires showed significant fire propagation beyond the initiating cable. The licensee reported that three horizontal stacked cable trays were burning at the time that the fire brigade arrived on the scene (several minutes after the apparent time of ignition).

At 4:45 p.m., on February 7, 1968, the unit was operating at 360 MWe and performing core depletion tests. All of the pressurizer heaters had been on for 96 hours when the operator noticed that the heaters were not actually operating. At about the same time, the control room received a 480-volt bus ground alarm, a loud noise was heard in the control room, and the lights flickered.

At 4:47 p.m. a security officer reported a fire at the southeast side of the containment. The reactor operator transferred the #1 480-volt bus, to the #3 480-volt bus which caused ground indications on both buses. The reactor operator then transferred the 480-volt buses back to their normal sources. The #1 480-volt bus ground cleared when the Group C pressurizer heater breaker was opened. Fire-fighting was initiated immediately, and the fire was very quickly reported to be under control at 4:47 p.m., (Just 2 minutes after the first signs of the presence of fire). The fire was fought with carbon dioxide (CO₂) and Ansul portable extinguishers.

At 5:10 p.m., the reactor and turbine (generator) were manually tripped. No spurious equipment operations were noted during the incident, and there was no apparent effect on the reactor shutdown/cooldown efforts.

On March 12, 1968, SONGS Unit 1 experienced another cable fire, this time in a cable tray in the #2 480-volt switchgear room. At the time of the fire incident, the unit was operating at 380 MWe when, at 12:21 a.m., the control room received several alarms including "Intake Structure Hi Level," "480-volt System Ground," "Station DC Bus Ground or Low Voltage," and "Hydraulic Stop Gate Trouble". These were followed by a "Sphere Heating and Ventilating System Trouble" alarm.

At 12:25 a.m., the annunciator panel for the turbine generator first out, auxiliary, and electrical boards were lost. An auxiliary operator reported smoke in the #2 480-volt switchgear room. At 12:27 a.m., operators observed blue arcing above the east door window of the #2 480-volt switchgear room. At 12:32 a.m., fire was observed in three cable trays above east door.

The reactor was tripped at 12:34 a.m., and operator began unit shutdown actions at 12:37 a.m. The #2 480-volt was cleared by over current relay operation.

At 12:35 a.m., the licensee requested assistance from the closest outside fire department, which happened to be a Marine Corps Fire Department. At 12:45 a.m., 24 minutes after the first control room alarms were received, the fire department arrived on the scene, but the electric motor-driven fire pumps would not start. Therefore, at 12:56 a.m., the licensee started the gasoline engine driven backup emergency fire pump. The fire was declared extinguished at 1:00 a.m., 39 minutes after the initial control room alarms.

During cooldown efforts following the fire, licensee determined that the coolant boron concentration was decreasing instead of increasing as expected. As a result, the cooldown was suspended for 3 hours and 40 minutes until the problem was diagnosed and fixed.

Post-fire investigation revealed that power and/or control circuits were affected for residual heat removal (RHR) suction and discharge valves, the component cooling water (CCW) heat exchanger outlet valve, the south primary makeup water pump, and three annunciator panels. Damaged cables rendered the following equipment electrically inoperable:

- safety injection recirculation valves
- west recirculation pump and discharge valve
- electric auxiliary feedwater pump
- safety injection train valves (west train motor-operated valves (MOVs))
- refueling water pump discharge valve to recirculation system

The following equipment was lost as a result of the relay cutout of the #2 480-volt bus:

- west RHR pump
- south transfer pump
- boric acid injection pump
- boric acid storage tank heaters and boric acid system heat tracing
- south primary plant makeup pump
- flash tank bypass valve
- east and west flash tank discharge pumps
- center component cooling water pump
- several other MOVs

While the first incident had only a minimal impact on the plant, the second incident rendered a large number of components. Nevertheless, a sufficient number of components and systems remained available to allow for orderly shutdown and core cooling. In addition, at least one of the alarms received in the control room was (namely the Intake Structure Hi Level alarm) apparently spurious. An operator reporting from the intake structure found no reason for this alarm to have sounded.

In terms of the fire cause, the two incidents shared many similarities. The investigation concluded that the most probable cause of both fires was thermally and mechanically stressed cables, coupled with the use of individual fuses to provide for clearing of faults on each phase of the three-phase 340-volt circuits. It also appeared that the cables were undersized for their design current loads under their actual installation conditions.

The initial fault was thought to be a cable-to-cable, phase-to-phase hot shot involving two separate power feeds from the same three-phase power bus. The fusing configuration allowed back-feeding of fault current through the unfaulted phases of each power feed, which led to an even more severe overcurrent condition for the conductors.

Both incidents involved self-ignited cable fires. As such, they are important because they were the earliest fire incidents at a nuclear power plant where self-ignition of cables resulted in extensive equipment damage and loss of equipment operability. While the first incident resulted in little or no fire spread, the second incident involved fire spread to three cable trays that were entirely burned for 4.60 m (15 ft). Investigation of the incidents led to recommendations that urged the

industry to reexamine cable qualification and raise the standards for establishing cable ampacity limits and for improving the flammability behavior of cables.

In both incidents, the fires did not cause complete loss of core cooling capability, core damage, radiation release or any injury to plant personnel or the public. The available sources do not offer detailed discussion of fire-fighting activities, occurrence of hot shorts (other than the initial cable-to-cable fault that initiated the second incident), the nature of the other circuit failures or operator actions in response to the failures, caused by the fire.

Reference

San Onofre Nuclear Generating Station Unit 1, Report on Cable Failures—1968, Southern California Edison Company, San Diego Gas & Electric Company, Publication date unknown, but circa 1968.

Browns Ferry Nuclear Power Plant, Unit 1, March 22, 1975

At noon on March 22, 1975, both Units 1 and 2 at the Browns Ferry Nuclear Power Plant (BFNP) were operating at full power, delivering 2,200 megawatts of electricity to the Tennessee Valley Authority (TVA).

The BFNP consists of three boiling-water reactors (BWRs). Units 1 and 2 share a common cable spreading room (CSR) located beneath the control room (CR). Cables carrying electrical signals between the CR and various pieces of equipment in the plant pass through the CSR. Just below the plant's control room, two electricians were trying to seal air leaks in the CSR, where the electrical cables that control the two reactors are separated and routed through different tunnels to the reactor buildings. They were using strips of spongy foam rubber to seal the leaks. They were also using candles to determine whether or not leaks had been successfully plugged by observing how the flame was affected by escaping air. One of the electrician put the candle too close to the foam rubber, and it burst into flame.

Following ignition of the polyurethane (PU) foam in Unit 1 CSR, the fire propagated through the penetration in the wall between the CSR and the Unit 1 reactor building. After the insulation burned off, the electrical cables shorted together and grounded to either their supporting trays or the conduits. In addition to the direct fire damage, the fire deposited an extensive amount of soot on all equipment located in the reactor building below the refueling floor. More than 600 of the burned cables contained circuits for the safe shutdown of one or both of the operating reactors. The direct fire loss was \$10 million, and the cost of fossil fuel used to produce the replacement electricity over the next 18 months was \$200 million.

Approximately 15 minutes passed between the time the fire started (12:20 p.m.) and the time at which a fire alarm was turned in. One of the electricians told a plant guard inside the turbine building that a fire had broken out, but confusion over the correct telephone number caused a delay in sounding the fire alarm.

This fire burned a large number of cables associated with penetrations between the CSR and the reactor building. The fire initiated in the CSR and initially involved the readily combustible and exposed PU foam of an incomplete cable penetration seal. The fire immediately propagated

through a gap in the penetration seal into the adjacent reactor building. This spread was enhanced by air flow through the penetration seal gap, caused by the negative pressure in the reactor building. In this case, the penetration seal was not complete (i.e., the seal was still under construction and lacked noncombustible cover panels).

The fire at BFNP demonstrates that given a sufficient initial source of readily combustible fuel (the PU foam in this case) in close proximity to a large concentration of cables in open cable trays, a self-sustaining and propagating cable fire may result. In this case, fire propagated both horizontally and vertically, thereby igniting and damaging cables. Cables inside conduits running near the burning cable trays were also damaged.

The fire in the Browns Ferry CSR was controlled and extinguished without the use of water. The fire in the reactor building was unsuccessfully fought for several hours with portable carbon dioxide (CO₂) and dry chemical extinguishers; however, once water was used, the fire was extinguished in a few minutes. After actuation of the CSR CO₂ fire suppression system, openings between the CR and the CSR had to be plugged to stop the entry of smoke and CO₂ into the CR. Some of these openings were in the floor of the CR at the points where the cables entered the CR. This appears to violate the design provision that these cable entryways would be sealed. Actuation of the CO₂ system in the CSR made the situation worse, driving the smoke and toxic fumes into the CR, which became uninhabitable.

The BFNP design incorporated provisions for sealing the openings between major structural divisions, such as the reactor building, the CSR and the control room. However, in the case of the Browns Ferry fire, one such seal between the CSR and the reactor building was ineffective in limiting the spread of the fire and was ultimately the primary cause of the fire. The lack of other seals, such as those between the CSR and the CR, impeded plant operation during the fire.

Notably, the smoke detectors in the Browns Ferry CSR did not alarm, despite presence of smoke possibly because the normal flow of air from the CRS to the reactor building drew the smoke away from the installed detector in the CSR. The smoke also penetrated the control room (through the unsealed cable entryways), but the fire detectors installed in the control room were of the ionization type and did not detect the combustion products generated by the cable fire and did not alarm. The reactor building also had a great deal of smoke in the vicinity of the fire, but the licensee had not installed detectors in that area.

A principal lesson learned from the of BFNP fire is the failure of fire prevention. The Review Group (NUREG-0050) recommended that the licensees review the ventilation systems in all operating nuclear power plants (NPPs) and upgrade them as appropriate to ensure their continued functioning if needed during a fire. The Review Group further recommended that the licensees should provided the capability to control ventilation systems to deal with fire and smoke, but such provisions must be compatible with requirements for the containment of radioactivity. Licensees should also protect the CR from both radioactivity and smoke or toxic gases. Adequate breathing apparatus and recharging equipment should be available for operators, fire-fighters, and damage control crews who may be work required to simultaneously during a prolonged incident.

The Review Group concluded that more comprehensive regulatory guidance was needed to provide fire protection design criteria to implement the requirements of General Design Criterion (GDC) 3 as specified by Appendix A to Title 10, Part 50 of the *Code of Federal Regulations* (10

CFR Part 50). The Browns Ferry fire and its aftermath revealed some significant inadequacies in design and procedures related to fire at the plant, including gaps in the defense against fires.

References

BL-75-04, "Cable Fire at Browns Ferry Nuclear Power Station," U.S. Nuclear Regulatory Commission. March 24, 1975.

BL-75-04A, "Cable Fire at Browns Ferry Nuclear Power Station," U.S. Nuclear Regulatory Commission. April 3, 1975.

BL-75-04B, "Cable Fire at Browns Ferry Nuclear Power Station," U.S. Nuclear Regulatory Commission. November 3, 1975.

"Browns Ferry Nuclear Power Plant Fire," Hearings Before the Joint Committee on Atomic Energy, 94th Congress of the United States. September 1997.

Hunter, L.W., "Fire Hazards of Electric Cables in Nuclear Power Plants," *John Hopkins APL Technical Digest*, Volume 4, No. 3, pp. 205-211: 1983.

Murphy, C.E., Office of Inspection and Enforcement, Region II, Regulatory Investigation Report: Subject: "Tennessee Valley Authority, Browns Ferry Units 1 and 2, Docket Nos. 50-259/75-1 and 50-260/75-1, "Fire in Cable Spreading Room and Reactor Building on March 22, 1975." July 25, 1975.

Nuclear Regulatory Commission (U.S) (NRC). NUREG-0050, "Recommendations Related to Browns Ferry Fire." Report by Special Review Group. NRC: Washington, D.C. February 1976.

Ramsey, C.B. and M. Modarres, *Commercial Nuclear Power Assurance Safety for the Future*, John Wiley & Sons, Inc. New York. 1997.

Scott, R.L. "Browns Ferry Nuclear Power Plant Fire on March 22, 1975," *Nuclear Safety*, Volume 1, No. 5: September-October 1976.

North Anna Power Station, Unit 2, July 3, 1981

On July 3, 1981, North Anna Unit 2 was at a power level of 17.9-percent when an internal fault in one phase of main transformer B led to a catastrophic transformer failure and fire. Ceramic insulation shifted, the side of the transformer ruptured, and transformer oil sprayed from the opening over the transformer and the outside wall of the turbine building.

The fire caused the feeder breakers from a reserve station service transformer to two station service buses to trip open. The voltage transient caused by this event led to several bi-stables in the solid-state protection system to drop out, resulting in a high steam line flow signal. Since the reactor coolant temperature was low, this led to a safety injection signal.

The fire brigade was activated immediately the licensee also contacted the local fire department for assistance. The deluge systems on transformers B and C activated. However, the fire was too

severe for the capability of the system and the fire continued to burn. It took the fire brigades about 1 hour to bring the fire under control.

Although this incident is considered a severe fire in classical fire protection terms, it affected only nonsafety components. Despite the low potential risk impact, the incident provided an interesting insight about fixed fire suppression system capabilities. Specifically, the incident demonstrated that a fixed fire suppression system can be overwhelmed even when the fire initiates in those components that the system is intended to protect. In other words, it showed that the effectiveness of the suppression system may be an important factor.

Reference

Licensee Event Report (LER) 339-81-055, North Anna Power Station, Unit 2, Docket No. 50-339, Virginia Electric and Power Company. July 15, 1981.

Rancho Seco, March 19, 1984

On March 19, 1984, Rancho Seco was operating at 85-percent power, and had been experiencing problems with the automatic level control of the de-foaming tank and hydrogen side drain regulator tank of the main generator. The licensee switched the drain regulator tank level to manual mode, requiring direct operator level control. However, operators apparently failed to pay adequate attention to the level control and this allowed the main generator seal oil pressure to decrease. This, in turn, allowed hydrogen to escape from the generator. At 9:50 p.m., hydrogen gas exploded and started a fire.

Plant personnel in the area immediately detected the fire, and it was extinguished by the fixed automatic carbon dioxide (CO₂) system within 14 minutes. Nonetheless, the fire caused significant damage in a relatively short frame, primarily because of the initial explosion and early burning.

This fire is one of few turbine building fire incidents in the United States that has caused significant damage. The incident demonstrated the unique nature of the turbine building fire hazards, which in this case, included a hydrogen gas leak and explosion and the potential for fast-developing fires that may cause damage despite effective operation of the fire suppression systems. This incident also demonstrated that turbine building analyses may warrant attention to more severe fires than might reasonably be postulated in other plant areas. This particular incident apparently had a minimal impact on plant operations and safety systems, but the impact on operators is a plant specific-factor, consistent with the presence (or absence) of safety-significant equipment in the turbine building.

Waterford Steam Electric Station, Unit 3, June 26, 1985

On June 26, 1985, the plant was operating at power when a fire occurred in one of the main feedwater pumps. An electrician notified the control room that smoke was emanating from main feedwater pump A and an operator dispatched to the scene reported back to the control room that the pump was on fire. Control room (CR) operators tripped the cited pump, began reducing reactor power, and declared that an unusual event was underway.

Five minutes after the initial report of a fire, the operator notified the CR that the fire was actually in main feedwater pump B, rather than A as previously reported. As a result, the CR operators immediately tripped the turbine, which, in turn, caused the reactor to trip. Since both main feedwater pumps were secured, the steam generator level dropped below the emergency feedwater system setpoint.

The licensee activated the fire brigade upon confirmation of the fire. The fire brigade used a local hose station and water streams to fight the fire and managed to extinguish it in about 10 minutes. The fire was limited to a small portion of the outer wrapping of insulation on the feedwater piping and was attributed to design and fabrication errors.

In most senses, this fire was relatively small and, overall, presented a relatively minor challenge to nuclear safety (a reactor trip with all safety systems available). The interesting aspect of this incident is that operator/personnel error led to an initial report identifying the wrong pump as the one on fire. As a result, the operator initially tripped the unaffected pump, and ultimately were forced to trip both main feedwater pumps. Although this incident involved only nonsafety-related trains, it provided an interesting insight into the possibility of an indirect impact of fire on multiple train availability. That is, for various reasons, a fire may lead to unaffected trains being taken out of service. In this case, the cause was operator error and the operator's actions were classified as an error of commission. This is, rather than failing to take a desirable action, the operator in this case took an action that was undesirable.

Fort St. Vrain Nuclear Generating Station, October 2, 1987

Fort St. Vrain is a single-unit high temperature gas-cooled reactor (HTGR), which (like other HTGRs) reactor uses graphite as a moderator and helium gas for heat removal from the core. Fort St. Vrain had two main cooling (helium) loops. After passing through the core, the helium flowed through the two steam generators (one per cooling loop). Two steam-driven circulators for each loop provided motive power for the helium. The steam for the circulators comes from the discharge of the high-pressure turbine of the turbine-generator. The steam then passes through the steam generators once more for superheating before being taken to the intermediate and low-pressure turbines.

On October 2, 1987, the plant was coming out of a long outage and was in the midst of its initial power ascension. As part of this process, the operators closed a hydraulic valve in the turbine building, when they noticed a drop in hydraulic oil pressure. An inquiry into the causes of this drop revealed that a filter bowl (canister) had failed and high-pressure oil (about 3,000 psig) was spraying (close to a 15-ft distance) onto hot exposed steel. The petroleum-based hydraulic oil ignited, starting the fire, because the temperature of the hot surfaces was above the auto-ignition point of the oil. The equipment operator who discovered the fire initially succeeded in extinguishing it using a portable dry-chemical extinguisher. However, since he did not close the valve feeding the failed filter, the oil continued to spray and re-flashed (re-ignited). By this time, the fire was relatively large (estimated at 8 ft x 3 ft).

The licensee immediately activated the plant's fire brigade was asked an outside fire department to respond. The licensee also dispatched a reactor operator to the reactor building to close the two control valves for the hydraulic system to cut off the supply of oil to the failed filter. That operator managed to close one of the two valves immediately. However, the handle for the other valve was

missing and, therefore, some delay occurred in cutting off the oil from the fire. As soon as the oil was cut off, the fire was extinguished and the operators managed to close off and isolate the failed filter and activate the available hydraulic system train.

The damage caused by this fire was limited to the immediate area of the fire at the north end of the turbine building. The fire also damaged several cables that had some effect on the control room (CR). In addition, the fire affected valves, instruments, and structural elements. However, the fire had only a minor impact on the plant shutdown and reactor cooling capabilities.

The fire also had some impact on CR habitability. Apparently, the burning oil and cables generated large quantities of smoke that hampered the initial fire-fighting efforts. The cables damaged by the fire also caused the CR ventilation system to shift to radiation emergency mode, and caused a loss of electric power at the fire location, thereby rendering the electric motor-driven smoke ejectors useless. In this mode, the system shifted to suction from the turbine building, thereby drawing some smoke into the CR. Within 2 minutes of the shift in ventilation systems, the ventilation system to the purge mode. However, smoke continued to enter the CR because positive pressure in the room could not be maintained as a result of frequent use of the door between the CR and the turbine building. Ultimately, the operators had to prop open the door separating the control room and Building 10 to allow fresh air to be drawn into the CR.

Reference

"Preliminary Report on the Impact of the FSV October 2nd Fire," Fort St. Vrain Nuclear Generating Station, Public Service Company of Colorado. October 30, 1987.

Oconee Nuclear Station, Unit 1, January 3, 1989

On January 3, 1989, Oconee Unit 1, was being brought up to power following a trip that had occurred a few days earlier. The unit had reached 26-percent power at 7:16pm., when the 6.9 kV switchgear (1TA) failed explosively and caught fire. Subsequent investigation could not establish the precise cause of this incident.

As a result of the switchgear failure, the main turbine and two reactor coolant pumps tripped, thereby initiating a reactor transient. The operators immediately began to reduce reactor power. The average reactor temperature was 302 °C (575 °F) at the beginning of the incident, and core cooling was initially maintained by the two operating reactor coolant pumps (RCPs) and main feedwater flow through the steam generators (S/Gs). The operators also started two high-pressure injection pumps to compensate for contraction of the water in the main coolant loop as it was cooling down in response to the power reduction. When the power dropped to 4-percent, the operators tripped the reactor.

Meanwhile, the control room (CR) received fire alarms and activated the fire brigade to respond to the fire. Later, the licensee called off-duty shift personnel to assist in the fire-fighting effort. The fire brigade made two initial attempts to suppress the fire using carbon dioxide (CO₂) and dry chemical fire extinguishers, but failed to extinguish the fire. CR operators deenergized the DC power bus in order to isolate the impacted 1TA switchgear from all electrical sources. The fire brigade then decided to apply water to the fire using a fog nozzle. To further protect the fire-fighters, the operators also deenergized the other train of the nonsafety related 6.9 kV switchgear (i.e., 1TB),

which was located near 1TA. Fire brigade used the water fog on the fire and at 8:15 pm., about 1 hour after the switchgear failure, the fire brigade declared the fire as being completely extinguished.

Tripping of switchgear 1TB (to protect the fire fighters) caused the remaining reactor coolant pumps to trip. Under these conditions, the integrated control system (ICS) is designed to raise the water level in the S/G to 50-percent and swap the feedwater nozzles from main to auxiliary. However, because of fire damage to the signal cables, the ICS failed and the operators had to manually execute these two actions. In doing so, however, the operators forgot to close the main feedwater valve. This further accelerated the rapid cooldown process that was already underway. Furthermore, since the operators focused on in-core thermocouple readings to monitor reactor temperature, they did not properly monitor the rate of cooldown at different points of the main coolant loop. As a result cold leg temperature dropped to about 219 °C (426 °F) in about 1 hour. The shift engineer and shift supervisor determined that the temperature in parts of the reactor may have dropped faster than 38 °C (100 °F) in that hour, which means that the plant may actually have entered the thermal shock operation region (overcooling).

Because operators had started the high-pressure injection system, reactor pressure reached 2,355 psig for a short time. Later, the pressure reached 2,385 psig, also for a short time. Operations then stopped the high-pressure pumps to control the high-pressure condition. These two pressure spikes, combined with the possibility of operating in the thermal shock operation region, could have endangered the integrity of the main vessel if the conditions had persisted for an extended time.

At some point in the incident, smoke did find its way into the main control room. The available literature does not describe either the extent of the smoke or the path by which the smoke found its way into the CR. Consequently, it is not clear whether the smoke had any impact on operator performance, although one report cites the smoke (rather in passing) as a contributing factor to the error that led to the overcooling transient.

Reference

Licensee Event Report (LER) 26989002, "Fire in 1TA Switchgear Due to Unknown Cause," Oconee Nuclear Station, Unit 1, Event Date 01/03/89.

H.B. Robinson Steam Electric Plant, Unit 2, January 7, 1989

At the time of this incident on January 7, 1989, Robinson Unit 2, was in a refueling outage. At 10:30 pm., as part of an air test of the main generator, a maintenance crew erroneously connected the instrument air header to the main generator hydrogen manifold using a rubber hose. This allowed the bulk hydrogen supply, which is at 120 psig, to be directly connected to the station's 95 psig compressed air system. The configuration was such that hydrogen flow to the generator was blocked, but flow into the station air system was not. Hence, hydrogen spread into the plant's general purpose compressed air system.

At the time the maintenance crew established the hose connection, the station air compressor was out of service and the station air system was connected to the instrument air system. The station air system was in greater demand because plant personnel were using air-driven tools throughout the plant. This caused the majority of the hydrogen to migrate into the station air system.

Approximately 1 hour after the maintenance crew established the connection, the crew noticed that generator pressure had not increased. At approximately the same time a small fire was discovered in an air junction box on the turbine deck inside the turbine building, the fire quickly extinguished and did not notice any damage. However, approximately 3 hours after the maintenance crew established the connection, a contract worker reported that flames were coming out of his air operated-grinder. Upon this discovery, the licensee ceased all work that could cause a spark and prohibited the use of the air system.

The licensee then took samples of the air at several locations and discovered that the hydrogen concentration ranged from 50-percent to 150-percent of lower explosive limit (LEL). The hydrogen had also migrated into the entire system, which encompassed practically all plant locations including the auxiliary building and the containment. No further fires occurred, and the licensee eventually purged the system of hydrogen.

This incident is of interest because it illustrates the somewhat unique point, that unexpected fire sources can arise during a refueling outage. In this case, at least two minor fires occurred, and there was clearly an inherent potential for more, and perhaps more serious, fires.

Reference

Licensee Event Report 26189001, "Hydrogen Introduced Into the Instrument Air System," H.B. Robinson Steam Electric Plant, Unit 2, Event Date 01/07/89.

Calvert Cliffs Nuclear Power Plant, Unit 2, March 1, 1989

On March 1, 1989, Calvert Cliffs Unit 2 was operating at 100-percent power. At 4:45 pm., a fire was discovered in a control panel in the main control room (MCR). At the time, an operator was in the process of verifying a repair on the over-speed trip mechanism of the auxiliary feedwater pump trip/throttle valve actuator. As part of this procedure, the operator put the hand switch for the valve in the shut position. The shut position indicating light flickered, and the operator heard a buzzing noise on the control panel. The operator repeated the action with the same result. The operator opened the panel cover and discovered a fire at the hand switch. Using a hand-held Halon fire extinguisher, the operator extinguished the fire in 1-2 minutes. In the meanwhile, a 10-amp fuse in the associated circuit blew. However, because the fire was extinguished quickly, the control room supervisor did not call the fire brigade.

When the operator discovered the fire, a turbine building operator was called to reset the throttle valve. In the attempt to reset the valve, that operator discovered that a solenoid associated with the valve was smoking, but there were no visible flames. The solenoid stopped smoking, apparently when the 10-amp fuse blew. The fire in the MCR panel caused some damage to nearby wires, but the licensee did not notice any other damage resulting from this incident. Moreover, this incident did not cause a significant safety hazard and its impact was limited to an isolated part of a safety-related system. The lack of damage can be attributed, at least in part, to the immediate response of the operator whose actions led to the initiation of the fire.

This incident is one of only a very few incidents in U.S. commercial nuclear power plants (NPPs) that lend insight into multiple fire ignitions in a single incident. In this case, a small fire occurred

in the MCR and an incipient fire (the smoking solenoid) occurred in the auxiliary feedwater pump room; the common link between the fires was a common electrical circuit.

Reference

Licensee Event Report 31889004, "Auxiliary Feedwater Pump Trip Circuitry Fire in Control Room Due to Maintenance Error," Calvert Cliffs Nuclear Power Plant, Unit 2, Event Date 03/01/89.

Shearon Harris Nuclear Power Plant, October 9, 1989

On October 9, 1989, the Shearon Harris plant was operating at full power. At 11:05 pm., a turbine generator and main power transformer differential relay tripped and started a chain of events that led to fires at three locations involving one main transformer and the main generator. As a result of the relay trip, the main generator output breaker also tripped. This, in turn, caused a turbine trip and a reactor trip. The auxiliary feedwater system actuated as designed, but the turbine-driven pump failed to operate properly so operators switched to motor-driven auxiliary feedwater pumps. The operators closed the main steam isolation valves to limit the cooldown rate.

The initial cause of the event was multiple ground faults in a bus duct near main power transformer B. The licensee event report (LER) stated that the ground faults apparently resulted from aluminum debris carried into the duct by the forced air ventilation system used to cool the bus duct. The licensee suspected that the debris entered the ventilation system as a result of two damper failures, one of which occurred on February 27, 1988, and a second one during the summer of 1989. The ground fault caused arcing over a 50-foot length of the bus, thereby reducing the dielectric strength of the air. In accordance with the air, per the design of the system, the air then entered the bushing box of the transformer, causing ground faults in the bushing box and leading to a crack in the low-voltage bushings. The bushing crack, in turn, led to a spill of oil and ignition of the first fire at the transformer.

The fault in the main transformer bushing box and bus duct A caused the voltage of the generator neutral to become elevated. A current transformer was mounted around the neutral conductor, from which it was isolated by insulating tape. However, the insulation resistance of the tape was apparently insufficient to withstand the elevated neutral voltage and an electrical breakdown occurred, causing the neutral conductor to short to ground. The arcing caused by this short burned holes in generator-related piping, which, in turn, subsequently allowed the housing above the hydrogen fire to ignite (the third fire).

At 11:09 pm., the control room (CR) was notified of a fire at main power transformer B, and an oil fire on the second level of the turbine deck underneath the main generator. The licensee immediately activated its onsite fire brigade who also noted a hydrogen fire on the second level of the turbine deck underneath the main generator (second fire). The deluge system at the main transformer activated as designed.

The licensee also contacted offsite fire departments shortly after the initiation of the incident to assist in the fire-fighting efforts. Later, the licensee created the prompt notification of offsite fire departments as having limited the damage caused by the fires.

As previously noted, the auxiliary feedwater system automatically actuated in response to the incident. However, the turbine-driven auxiliary feedwater pump tripped shortly after it started. The licensee later identified the cause of the trip a spurious over-speed trip signal from the tachometer. No link between the failure of the auxiliary feedwater pump and the fire has been established, and this appears to have been an independent (random) failure event.

At 11:35 pm., an alert was declared and activated the technical support center (TSC). By 12:13 am., on October 10 (a little more than over 1 hour after initiation of the event), the oil fire at the generator housing was extinguished. Also, the fire at the main power transformer was believed to be under control by the deluge system. The hydrogen fire underneath the generator was also considered to be under control.

By 01:45 am., a small residual oil fire at the main transformer was extinguished using a portable dry chemical extinguisher. By 02:45 am., (2 hours and 40 minutes after incident initiation) the licensee completed walkdowns to verify that all three fire were extinguished, fire watches were posted at the fire locations, and purged the main generator CO₂.

The fires in this incident were of relatively long duration, lasting about 1 hour and 45 minutes total, and were relatively severe from a classical fire protection perspective. However, from a nuclear safety perspective, the fires had a relatively modest overall impact. The plant did trip automatically and an auxiliary feedwater pump did fail (apparently a random failure). However, the operators responded appropriately to the situation and properly controlled the plant shutdown including proper control of the cooldown rate.

The incident is of interest because it is one of the few incidents in the United States that involved multiple fires occurring concurrently. As such, the incident demonstrated that multiple fires may occur simultaneously in different areas of a plant. As seen in other such incidents, one of the common links was a common electrical system. However, the secondary hydrogen fire was apparently the result of damage caused by the failure of the current sensor on the generator neutral cable, so there were multiple contributing factors rather than simply a common electrical system that became overloaded.

Reference

Licensee Event Report # 40089017, "Electric Fault on Main Generator Output Bus Causing Plant Trip and Fire Damage in Turbine Building," Shearon Harris Nuclear Power Plant, Event Date 10/09/89.

Salem Generating Station Unit 2, November 9, 1991

On November 9, 1991, Salem Unit 2, was operating at full power when a reactor trip occurred, causing the main generator breaker to open. The auto stop oil system was in test mode and, as result, the turbine valves cycled open while the generator was disconnected from the grid (i.e., the turbine re-started without an appropriate generator load on the system). An over-speed condition occurred, but the over-speed protection system failed to function properly and allowed the turbine's rotational speed to exceed 2,500 rpm compared to the normal operating speed of 1,800 rpm. The forces associated with this level of over-speed caused the blades to break apart, ejecting fragments from the turbine casing. Hydrogen gas escaped and caught fire because of a seal failure caused

by the excessive vibration. The vibration also severed the lube oil pipes causing a release of the oil that also caught fire.

The following automatic fire suppression systems actuated promptly as designed:

- deluge system protecting the inboard generator bearing housing
- deluge system protecting the low-pressure bearing housing
- low pressure CO₂ system protecting the main generator exciter
- wet pipe sprinkler system below the main generator pedestal

The entire sequence of events leading to turbine failure lasted 74 seconds. Fires had already occurred by that time and some of the automatic suppression systems had activated. The automatic suppression systems managed to extinguish some of the fires.

By coincidence the fire brigade happened to be outside the protected area at the time of fire. With the assistance of plant security, the brigade promptly re-entered the plant proper and managed to be on the scene in full gear within 5 minutes of fire ignition. With the help of plant fire brigade personnel, the fire was contained rapidly and extinguished within 15 minutes. The fire caused relatively little damage compared to that done by the ejected blades.

The licensee subsequently determined that the fire impacted turbine and exciter end of the main generator. Because the main turbine generator of Salem Unit 2 is not enclosed, the hydrogen and smoke from the fire escaped directly into the atmosphere. As a result, the fire brigade did not need to be concerned with hydrogen pocketing under the structural elements of the ceiling.

This incident is considered important because despite the potential for a very severe fire, the licensee observed only very limited fire damage. In this case, catastrophic failure of a turbine led to a fire. This event is somewhat unique in that the fire suppression system was adequate to control the ensuing fire and, coupled with the response of the fire brigade, was to extinguish the fire very quickly. Some localized fire damage resulted, and the costs of replacing the failed turbine were extensive, but the fire had no impact on the safety-related elements of the plant.

Another notable aspect of this incident is that a failure related to a main turbine generator system led to turbine disintegration, which, in turn, caused the fire. It is also interesting to note that two independent events contributed directly to the initiation of the fires. First, the auto-stop oil system was in test mode and this created a condition where the turbine was, in effect, re-started without an appropriate load and this, in turn, led directly to the potential for an over-speed condition to occur. Second, the over-speed protection system failed to function, allowing the over-speed condition to progress unchecked.

Reference

Licensee Event Report 31191017, "Reactor/Turbine Trip on Low Auto-Stop Oil Pressure Followed by Turbine/Generator Failure," Salem Generating Station Unit 2, Event Date 11/00/91.

Waterford Steam Electric Station Unit 3, June 10, 1995

On June 10, 1995, Waterford Unit 3 was operating at 100-percent power. At 8:58 a.m., failure of a lightning arrester on a substation transformer (230 kV/34.5 kV) caused a severe electrical transient that, in combination with the failure of a breaker, led to failure of non-vital switchgear 2A and fire in the breaker cubicle for the startup transformer. This led to a reactor trip and a series of other nonsafety-related equipment trips, signal actuations, and equipment activations.

All 36 fire detectors for the turbine building switchgear room alarmed to the control room (CR) indicating panel. However, the CR operators did not become aware of the fire detector alarms because other plant alarms were sounding at the same time, the fire protection alarm board was in an area not readily visible to the operators, and the fire detector alarm panel buzzer had been covered with tape. Hence, CR operators remained unaware of the fact that a fire had started in the switchgear room.

At 9:06 a.m., the control room received a report from an auxiliary operator, who happened to be a trained fire brigade member, that heavy smoke was coming out of the switchgear room. The shift supervisor asked if the auxiliary operator could observe flames or an orange glow. The auxiliary operator responded that he could not see flames but a large amount of smoke was coming out of the switchgear room. The shift supervisor instructed the auxiliary operator to confirm the presence of an actual fire and report back.

Two auxiliary operators donned self-contained breathing apparatus (SCBA) and entered the switchgear room to verify the presence of a fire and subsequently notified the CR that a fire was indeed in progress. The exchange of information took place about 30 minutes after the first fire alarm sounded in the CR (i.e., approximately 9:30 a.m.). At that time the shift supervisor, announced the presence of fire and activated the fire brigade.

The fire brigade arrived on the scene and initially attempted to extinguish the fire using hand-held fire extinguishers charged with carbon dioxide (CO₂), Halon, and dry chemical agents. However, all of their attempts proved ineffective. According to the plant procedures, the shift supervisor, then assumed the leadership of the fire brigade and left the CR for the fire location.

The shift supervisor summoned the local offsite fire department was summoned at 9:41 a.m., and they arrived at about 9:58 a.m., (17 minutes later). Upon arrival, the offsite fire department recommended the use of water. However, the shift supervisor, in consultation with other members of plant operations team, decided to continue using non-water suppression media. The shift supervisor ultimately gave permission to use water about 90 minutes after the initiation of the fire (i.e., about 10:30 a.m.). The fire fighters brought the fire under control within 4 minutes after initial application of water and declared the extinguished about 2½ hours after initiation.

As noted, the fire was initiated as result of a failure of a switchgear breaker cubicle. The fire propagated out of the top of the cubicle and ignited vertical cable tray risers above the cubicle. (One can infer that the switchgear cubicle fire broke through the steel top of the panel and propagated to those cables. However, it is impossible to determine whether this was attributable to heat damage to the top panel or whether the top panel may have been damaged in the initial electrical fault.) In its progression, the fire jumped over a fire stop installed in the vertical section of the cable tray and continued to propagate. As a results, the fire damaged cables in a 5-foot

diameter column up to a height of about 10 feet above the panel top, and the associated heat damaged the fire detectors immediately above the fire zone.

The fire eventually reached a horizontal cable tray about 17 feet above the floor (10 feet above the top of the panel). The fire then propagated horizontally until it came to a fire stop installed in the horizontal cable tray about 8 feet from the junction with the vertical trays. From the available information, one can infer that, for the horizontal segment of the cable trays, the flames were of limited height and/or limited duration. This is because the 6.9-kV power cables that were located a few inches above the burning 4.16-kV cables were not ignited and had only minor surface damage after the fire.

The fire also severely damaged two adjacent switchgear cubicles, but four other nearby cubicles experienced exterior damage only. The investigators postulated that the radiative heat reflected from the shield wall separating the two switchgear trains caused the exterior damage to those four cubicles. The fire did not damage any of the redundant train cubicles (on the opposite side of the shield wall).

It is also interesting to note that the plant's log records indicated erratic behavior of the A2 unit auxiliary transformer breaker that was involved in the fire. Operators also noted a few other erratic indications on the control board during the course of the incident. The records indicated that the transformer breaker first showed closed and then open. One can infer from this that breaker control circuit faults led to inaccurate indications on the sequence of events log.

The non-vital switchgear fire at Waterford Unit 3 had little impact on safety-related functions. Switchgear fires are considered one of the most likely fire scenarios in a nuclear power plant.

This incident provides an interesting account of what can happen to the switchgear cubicles and the cables above it in the event of a switchgear fault and fire. In this case, three cubicles suffered extensive damage, and four experienced minor damage. Further, the fire propagated through the steel panel top into a vertical cable tray, about 10-ft up the vertical tray to a crossing horizontal tray, and about 8-ft along the intersecting horizontal tray before being stopped by a raceway fire barrier. The potential for fires inside closed electrical panels to propagate outside of the panel has been a point of significant recent debate. This incident clearly illustrates that this potential exists under some conditions.

A second factor of interest is the fact that fire fighting was considerably delayed in this incident. The delay was caused by three nominally unrelated factors, two of which related to decisions made by plant personnel during the incident.

One of these three factors was the decision made by the shift supervisor, who insisted on direct observation of flames before declaring a fire and activating the fire brigade. It took close to 30 minutes an hour (from time of ignition) for two operators to don protective breathing apparatus, enter the room, verify the presence of flames, seek out the source of the fire, retreat from the room and report back to the CR.

The second factor related to the strategy used to fight the fire. Once the fire was declared and the fire brigade arrived on-scene, the fire brigade resisted using water on an electrical fire until multiple attempts to extinguish the fire using portable extinguishers proved ineffective. As a result, the fire was allowed to burn far longer and observed damage was perhaps made worse than if prompt and

effective fire suppression had been undertaken. The licensee did not report the reason for the failure of CO₂, Halon, and dry chemical agent to control the fire.

The final factor contributing to the delay in declaring a fire emergency is the position of the fire protection annunciator panel and the suppressed sound of the alarm. The panel was not readily visible to the operators in the CR must have diverted attention from the fire panel. It is important to note that even after receiving a verbal report of smoke in the switchgear room, the operators did not approach the fire protection panel to verify the condition of the fire detectors.

Another point of interest in this incident is the fact that operators noted a few erratic indications on the control board during the course of the incident. This indicates that control circuits can fail erratically under fire conditions. The licensee did not report the exact reasons for the observed behavior.

This incident also demonstrated that a fire stop in a horizontal cable tray can be effective in stopping the progression of the fire. In this case, the fire propagation in the horizontal tray ended at a raceway fire stop; however, a fire stop in a vertical cable tray may be ineffective. In this case the fire in the riser jumped past a fire stop and continued to propagate. It is not clear whether the fire stop delayed propagation.

References

Inspection Report 50-282/95-15, "NRC Augmented Inspection of Waterford 3," U.S. Nuclear Regulatory Commission. July 7, 1995.

Information Notice 95-33, "Switchgear Fire and Partial Loss of Offsite Power at Waterford Generating Station, Unit 3," U.S. Nuclear Regulatory Commission. August 23, 1995.

Palo Verde Nuclear Generating Station Unit 2, April 4, 1996

On April 4, 1996, Palo Verde Unit 2 was in a refueling outage. At 5:00 a.m., a fire watch detected smoke in the back panel area of the control room (CR), emanating from the Train B emergency lighting uninterruptible power supply (UPS) panel. At about the same time, an auxiliary operator discovered smoke and fire in the Train B DC equipment room at the 100-ft elevation of the auxiliary building. This second fire was discovered on the 480/120-volt essential lighting isolation transformer. However, multiple trouble alarms on the fire detectors masked the actual fire alarm coming from this equipment room such that operators did not notice the valid fire alarm signal.

The fires led to the loss of power to the Train B CR emergency lighting circuits, some of general plant essential lighting, and plant fire detection and alarm system panels. The circuit breaker supplying power to the UPS panel tripped open when cables in the conduit supplying the power supply panel overheated causing various conductors to short-circuit. The circuit breaker trip also deenergized power to the fire detection and alarm panels in the auxiliary building. The fire alarm annunciator monitor (a computer screen) indicated a large number of fire detector trouble alarms and these multiple alarms were scrolling on the monitor. This was attributed to the deenergized fire detection and alarm panels.

The fire in the equipment room was reported by the auxiliary operator to the CR and the shift supervisor activated the onsite fire brigade. The onsite fire brigade attacked the fire immediately and extinguished it in a short time. It is not entirely clear whether the fire brigade also reported to the CR or not. The operators approximately handled the fire in the CR and the CR fire was also quickly extinguished. The damage caused by these fires was limited to the components of origin. That is, neither fire propagated beyond its point of ignition.

In this incident, the fires were not severe either from a classical fire protection standpoint or a nuclear safety standpoint. The most interesting aspect of this incident is the occurrence of multiple simultaneous fires, one of which occurred in the plant's main control room. Incidents involving multiple initial fires have been observed in several other plants. In some cases, particularly incidents at non-U.S. reactors, the fires have led to extensive damage.

The cause of simultaneous fires at Palo Verde was traced to a fault in the isolation transformer located in the Train B DC equipment room. This failure caused a short-circuit fault to the station ground through the transformer's panel ground. The neutral leg of the transformer was not connected to ground. Also, an inverter that served as the alternative essential lighting UPS was improperly grounded. The ground connection of the inverter served as the return path for the isolation transformer's ground fault, which passed through the essential lighting power supply panel. The conductors that carried the fault current were not designed to handle the high currents caused by the fault. As a result, they overheated and ignited the combustible materials around them. Clearly, the common factor leading to multiple ignitions was a common overheated electrical conductor.

It is also interesting to note that the fires in this case were, in effect, self-ignited cable fires. An electrical fault led to an ampacity overload on a particular cable, and the cable ignited in two locations as a result. The units at Palo Verde are relatively new (Unit 2 construction began in 1976 and the current U.S. cable flammability standard, IEEE-383, was adopted in 1975); hence, one can assume that the cable installed in the plant are of the low flame spread type. This incident is one of the very few incidents, if not the only incident, where a self-ignited cable fire in low flame spread cable has not self-extinguished. This incident appears to illustrate that the possibility of such fires does exist at some level, although the actual frequency of such fires remains uncertain.

Reference

Information Notice 97-01, "Improper Electrical Grounding Results in Simultaneous Fires in The Control Room and the Safe-Shutdown Equipment Room, U.S. Nuclear Regulatory Commission. January 8, 1997.

San Onofre Nuclear Generating Station, Unit 3, February 3, 2001

On February 3, 2001, San Onofre Unit 3, was operating at 39-percent power following a refueling outage. While switching offsite power sources for Unit 3, a 4160kV breaker (3A0712) faulted and initiated a fire. This resulted in a loss of power to Unit 3 nonsafety-related systems, a reactor trip, a turbine/generator trip, and an automatic start of both Unit 3 emergency diesel generators (EDGs).

The main control room (MCR) received an annunciator fire alarm, along with a visual report of smoke and flames at the 30-foot elevation switchgear room of the turbine building. The incident

was further complicated when the MCR annunciators were lost as a result of a tripped breaker approximately 5 minutes into the event.

The SONGS onsite fire department was dispatched upon receipt of the fire alarm in the switchgear room and arrived at the scene within 7 minutes. The on-scene fire department captain requested additional support from an offsite fire department. Firefighters observed that the room was completely filled with heavy smoke, with essentially zero visibility. The source of the heavy smoke and heat was determined to be within the closed cubicle 4160-V switchgear cabinetry. The firefighters also noted flames from burning instrument gauges on the front of cubicle 3B14, which is located directly across from the 4160-V breaker cubicle. The onsite fire department captain established a command post, initiated fire suppression using portable fire extinguishers, and began ventilating the area. Communication between the onsite fire department captain and the plant shift manager was through the technical advisor at the scene. The firefighters discharged portable Halon and dry chemical fire extinguishers through the cabinet vents in an attempt to extinguish any active fire within the cabinet. The extinguishing agents had no noticeable effect on the production of smoke. The technical advisor transmitted to the operations shift manager a report that the fire was out, although the fire department captain only advised the operations technical advisor that flames were no longer visible.

With the exception of some low-voltage circuits, all power was isolated to the 4160-V switchgear. The firefighters then determined that the cubicle door could be opened safely. Upon opening the cubicle door, the firefighters observed flames within the cubicle, and discharged additional dry chemical in another attempt to extinguish the flames. The firefighters then closed the cubicle door as a containment measure. The cubicle door was subsequently opened several times, and each time the door was opened, in-rushing air caused the fire to reflash. Firefighters then used dry chemical each time the fire reflash.

The fire department captain advised the operations technical advisor that the fire could not be completely extinguished unless the firefighters applied water to the fire. It appeared that the dry chemical temporarily removed air from the fire, but did not reduce the heat, and the fire would reflash once air was reintroduced. The operations technical advisor relayed this request to the shift manager for permission to use water on the smoldering area inside the cubicle to prevent reflash. Because he was concerned that the buses were still energized with 125-V dc and low-voltage ac power, the shift manager initially denied the fire department captain's request to use water. However, after the fire department captain spoke directly with the shift manager to advise him that the deep-seated fire could not be extinguished unless water was applied, the shift manager granted permission to use water to extinguish the fire. The fire was ultimately extinguished after firefighters applied water. The deep-seated fire burned for approximately 3 hours before finally being extinguished. The licensee later determined that communication weaknesses in identifying the actual fire status during the event contributed to the delay in extinguishment.

Discussion

The extensive damage made it difficult to determine the exact cause of the fault. The licensee found that the 4160-V switchgear phase C arcing contact had completely melted, and concluded that the phase C circuit breaker failed to close completely during the bus transfer. The breaker was approximately 25 years old and had its last preventive maintenance performed in 1997. The licensee also believed that arcing, fire, smoke, and ionized gases in the 4160-V circuit breaker

caused multiple faults on a 3A07 bus and the offsite power circuit terminal connection at circuit breaker 3A0714.

The licensee also determined that the fire event generated a much higher heat release rate (HRR) than would normally be assumed in typical fire risk modeling to perform probabilistic risk assessment (PRA). In "A Supplement to EPRI Fire PRA Implementation Guide (TR-105928)," report SU-105928, the Electric Power Research Institute (EPRI) provides data for electrical cabinet fires, indicating an HRR of either 68.60 kW or 200.50 kW (65- or 190 Btu/sec), depending on the type of cable installed. The EPRI data focus on the HRR contributions of combustibles in the electrical cabinet (only cable insulation) and neglect the large amounts of electrical energy that may be released from electrical faults. According to a report by the NRC's Office of Nuclear Regulatory Research, entitled "Operating Experience Assessment Energetic Faults in 4160-V kV to 13800-V Switchgear and Bus Ducts That Caused Fires in Nuclear Power Plants in 1986-2001" (ADAMS Accession # ML021290358, February 28, 2002) for medium- and high-voltage applications, the research indicates that these HRR values [68.60 kW and 200.50 kW (65- and 190 Btu/sec)] may be under predicted by a factor of 1,000.

This operating experience indicates that equipment rated at 4160-V and higher is vulnerable to particularly energetic electrical faults. This event demonstrates that energetic electrical faults instantaneously release large amounts of electrical energy and may bypass the normal fire initiation and growth stages. In the SONGS fire event, the equipment that caught fire was directly connected to the auxiliary transformer (AT), which is powered from the grid or main generator. If a circuit breaker is stuck or slow in responding, there is sufficient energy to cause an explosion and vaporize metal in a few cycles.

Conclusion

This event demonstrates the importance of using water to extinguish deep-seated electrical cable fires. It is similar to previous fire events (Browns Ferry 1975, Waterford 1995) in which delayed application of water on electrical fires extended the duration of the fires and delayed recovery from the events. It is essential that fire brigade and operator training address the appropriate use of water in firefighting operations in energized electrical equipment. This event also highlights that the HRR from fires in electrical cabinets may be much greater than assumed in NPP fire hazard analysis (FHA).

References

Inspection Report No. 50-362/01-05, "San Onofre Nuclear Generating Station NRC Special Team Inspection Report," U.S. Nuclear Regulatory Commission. April 20, 2001.

Preliminary Notification, PN401004, "Circuit Breaker Failure and Fire, Resulting in Reactor Shutdown," U.S. Nuclear Regulatory Commission. February 6, 2001.

Significant Event Notification, SEN 218, "Circuit Breaker Fault Results in Fire, Loss of Off-Site Power, Reactor Scram, and Severe Turbine Damage," San Onofre Nuclear Generating Station Unit 3. March 9, 2001.

Significant Event Report, SER 5-01, "4-kV Breaker Failure Resulting in a Switchgear Fire and Damage to the Main Turbine Generator," San Onofre Nuclear Generating Station Unit 3. September 21, 2001.

Point Beach Nuclear Plant, Unit 1, April 24, 2001

On April 24, 2001, while Point Beach Unit 1 was shut down and defueled for refueling outage U1R26, a fire occurred in the "A" steam generator (S/G) vault on the access platform to the primary side manway covers. The fire was believed to originate as the result of a short in a 12-Vdc communication box. The fire consumed a bag of rags and testing equipment debris, and lasted for approximately 23 minutes. After multiple failed attempts in which the fire brigade discharged approximately 70 pounds of dry chemical (3 portable fire extinguishers), the fire was finally extinguished using 15–20 gallons of water. The licensee reported that approximately 50 percent of the containment basement floor (8 feet elevation), 50 percent of the "A" S/G vault, and 30 percent of the "A" reactor coolant pump (RCP) vault were covered in white dust (dry chemical fire extinguishing agent). Also, a white dust layer was visible on components on the main refueling floor (66 feet elevation). Smoke and soot resulting from the fire left a mark about 4 feet wide by 25 feet high against the vault wall.

Discussion

The dry chemical extinguishing agent is discharged by an inert gas when a fire extinguisher is used. All forms of dry chemical act as extinguishing agents to suppress the flame of a fire (Friedman, 1998), but may require extensive cleanup after use, as illustrated by this event.

Most chemical extinguishing agents can produce some degree of corrosion or other damage, but of the seven types of dry chemicals, monoammonium phosphate is especially acidic and tends to corrode more readily than other dry chemicals, which tend to be more neutral or mildly alkaline. Furthermore, corrosion resulting from the other dry chemicals is stopped in a moderately dry atmosphere, while phosphoric acid generated by using monoammonium phosphate has such a strong affinity for water that an exceedingly dry atmosphere would be needed to stop the corrosion.

Application of dry chemical agents on electrical fires is considered a safe practice from the viewpoint of electric shock. However, these agents, especially monoammonium phosphate, can damage delicate electrical equipment.

One potential issue with using dry chemical extinguishers results from the sudden release of the agent and the large area of discharge. Dry chemicals become sticky when heated and, therefore, are not recommended for locations where it may be difficult to remove residue from equipment. It is important to note that when water is applied to the affected areas, corrosion will occur because moisture initiates a chemical reaction that accelerates corrosion of equipment exposed to the dry chemical.

Dry chemicals are generally nontoxic, but can pose a health hazard when used in closed areas. Persons who breathe concentrations of the dry chemical powder may experience respiratory irritation and coughing. When dry chemicals are discharged into an enclosed area, impaired breathing and reduced visibility should be considered.

Conclusion

Although the Point Beach incident lasted approximately 23 minutes, it was not a large fire in terms of HRR. The dry chemical extinguishing agent did suppress the fire, but failed to completely extinguish the fire (the fire reflashd twice). The fire brigade unsuccessfully attempted to extinguish the fire with dry chemical agent three times before easily extinguishing it with a hose line (water). A more thorough selection of extinguishing media should be considered in light of the cleanup effort from the small fire. It is important to recognize that the fire was successfully extinguished with a relatively small quantity of water, which required minimal post-fire cleanup.

References

Friedman, R. *Principles of Fire Protection Chemistry and Physics*, 3rd Edition, Chapter 14, "Fire-Fighting Procedures," pp. 229-230. National Fire Protection Association, Quincy, Massachusetts. 1998.

Point Beach Nuclear Plant, Inspection Report 50-266/01-08, 50-301/01-08, U.S. Nuclear Regulatory Commission. June 6, 2001. (ADAMS Accession # ML011580082)

"Point Beach Unit 1 Containment Fire," Presented by the Point Beach Senior Resident Inspector, Krohn, P.G. at the Region III Training Seminar. December 2001.

Prairie Island Nuclear Generating Plant, Unit 1, August 3, 2001

On August 3, 2001, at 8:44 p.m., an operator enroute to the Unit 1 bus 11/12 area observed fire and smoke, but could not identify the cubicle from which it was originating. The operator entered the bus 13/14 room and called the main control room (MCR) to report the fire. The MCR immediately initiated the fire alarm and activated the onsite fire brigade. The MCR also notified the offsite Red Wing Fire Department (RWFD).

The fire brigade entered the turbine building to assess the extent and exact location of the fire. They reported flames in the upper and lower compartments of the 12-4 cubicle and along the left side of the breaker. They also found that the door in both the upper and lower compartments of the cubicle were blown open.

At 8:58 p.m., the fire brigade began initial suppression of the fire using three portable carbon dioxide (CO₂) extinguishers and one Halon extinguisher through the open front door of the breaker cubicle. The fire was not extinguished, and the fire brigade observed electrical arcing in cubicle 12-4.

The fire appeared to be localized in one area and not spreading. The initial efforts to deenergize the bus from the MCR failed. The fire brigade chief reported to the MCR that breaker 12-4 was still energized, as evidenced by arcing observed in cubicle 12-4. Because of the uncertainty as to whether bus 12 was deenergized, the Unit 2 shift supervisor decided to deenergize the 1R transformer. The fire department reported to the MCR that there were small flames and heavy smoke in breakers 12-1 and 12-4. At 10:13 p.m., approximately 1.5 hours into the event, the fire brigade extinguished the fire with assistance from the RWFD.

Discussion

The fire was extinguished after 1.5 hours by using more than 20 portable CO₂ fire extinguishers in the evolution (in addition to the 3 CO₂ extinguishers and 1 Halon extinguisher used in the initial attack). One factor that complicated extinguishing the fire was the decision not to use water because of energized electrical equipment. This resulted in continued burning and elevated temperature. Because of the elevated temperature caused by this electrical fire, two fire brigade members were treated for heat exhaustion at the site, and one of them was subsequently transported to the hospital for further treatment. In addition, several inches of the copper feed stabs from the 1M transformer completely vaporized during this fire (providing additional evidence of high temperature).

The licensee determined that the cause of the event was a poor electrical connection between the breaker 12-4 C-phase primary disconnect assembly (PDA) and the 1MY bus stab, which caused the PDA to overheat. The arcing also actuated the protective relaying, which resulted in an automatic turbine/reactor trip. The arcing event at breaker 12-4 released enough energy to cause the cubicle to expand and the door to be blown open. The breaker compartment was heavily oxidized and holes were burned through the cubicle on either side of the breaker. The arcing event destroyed many of the springs and fingers in the PDAs. A few were found at the very bottom of the debris, particularly below C phase.

Conclusion

The root cause evaluation of the nonsafety-related breaker fire concluded that maintenance practices could have contributed to the failure of the PDA by creating a poor connection, which caused localized over heating of parts of the PDA. This overheating caused the PDA to disintegrate. At that point, the loose parts of the PDA created a short-to-ground path. Once the arc was struck, phase-to-phase faulting occurred between the A-B and B-C phases. The initial arcing to ground quickly interrupted the dc circuit below the breaker pan (located directly below the PDA).

In this fire event, the use of portable CO₂ and Halon fire extinguishers may not have been the most effective choice of extinguishing agent to use. Operating experience in energized electrical equipment fires shows that the use of a relatively small quantity of water was effective in successful fire extinguishment.

References

Preliminary Notification PN301027, "Electrical Panel Fire During Plant Startup," Prairie Island Nuclear Generating Plant, Unit 1, U.S. Nuclear Regulatory Commission. August 6, 2001.

Licensee Event Report (LER) 1-01-05, "Fault and Fire in Non-Safeguards Circuit Breaker Results in Reactor Trip and Auxiliary Feedwater System Actuation," Prairie Island Nuclear Generating Plant, Unit 1. October 2, 2001.

Fort Calhoun Station, Unit 1, December 19, 2001

In October 2001, the licensee for Fort Calhoun Station began a surveillance of the Unit 1 containment prestressing system. This surveillance included testing the tension of the containment concrete tensioning cables. It also involved pumping lubricating grease into the containment tendon sheathings to replace the grease that had been lost as a result of leakage. In support of this activity, 55-gallon drums of grease were located in the tension gallery. During this surveillance activity, the plant personnel discovered that the grease was too cold to pump and would need to be heated before use. Drum heaters were, therefore, used on the outside of the drums to heat the grease and facilitate pumping into the containment tension sheathings. Two drum heaters were used, one powered from a receptacle located in the tension gallery and the second powered from a receptacle located in room 22. In order to supply power from the outlet in room 22 to one of the drum heaters, two extension cords were connected in series and routed through the open door separating room 22 from the tension gallery. At the end of the day, the drum heater powered from the receptacle in room 22 was left energized to keep the grease warm overnight so that work could begin the next morning.

Unbeknownst to plant personnel involved in performing the surveillance, the extension cords used to power the drum heater were not rated for this application. The extension cords were rated at 15 amperes, and had male connections that would only allow them to be connected to 15-ampere receptacles. However, the 20-ampere male connection on the drum heater had been inappropriately modified to allow it to be connected to a 15-ampere plug or receptacle. The licensee later determined that the, 2000-watt drum heater drew a current of 17.39 amperes.

As a result of using underrated extension cords, the extension cords continued to heat up during the evening. The extension cords eventually overheated and ignited the plastic on the radiological control point stepoff pad and a rubber air hose.

On December 19, 2001, at 2:48 a.m., the MCR operators received an alarm from an ionization smoke detector located in room 22. A control room operator dispatched the auxiliary building operator and a radiation protection technician to investigate the cause of the fire alarms. The auxiliary building operator arrived at the door to room 22, cracked the door open, and determined that there was too much smoke to enter the room without using protective firefighting bunker gear and a self-contained breathing apparatus (SCBA) and informed the MCR. The fire brigade was activated while operators entered the abnormal operating procedure for fighting fires. During this event, the MCR received another ionization smoke detector alarm in corridor 4.

The fire brigade laid out an attack line from the hose cabinet outside room 22 and a backup line from the cabinet outside room 6 before the attack team prepared to enter room 22. The attack team entered room 22 and proceeded down the stairs toward the entrance to the containment tension stressing gallery. The nozzle man described room 22 as being completely filled with smoke with no visibility. The smoke that traveled from room 22 through the open door caused the actuation of the water curtain open head deluge system on the auxiliary building stairwell, which resulted in water being sprayed onto safety-related motor control centers (MCCs), which subsequently caused actuation of the 480-V bus ground alarms in the MCR.

These MCCs are safety-related but are not required to function during a safe shutdown event, as defined by Appendix R to Title 10, Part 50, of the *Code of Federal Regulations* (10 CFR Part 50). Operators also restarted the room 22 ventilation to remove the smoke.

Discussion

Licensee personnel performed unauthorized modifications to the male connections of two drum heaters, allowing them to be inserted into underrated outlets and extension cords, which ultimately caused the fire. The licensee concluded that the root cause of the fire was the modification of the male connection on a 2,000-watt drum heater. The plug on a second 2,000-watt drum heater was also found to be modified. This unauthorized modification defeated a manufactured safety device (electrical connector standards), thereby allowing the heaters to be energized using undersized extension cords and electrical outlets. On one of the plugs, a prong was twisted 90 degrees to make it similar to a 15-ampere plug. On the other heater, the plug was completely removed and replaced with a 15-ampere plug (see illustrations below).

Standard
15 Amp Receptacle

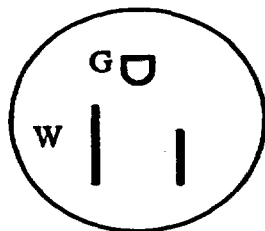

Standard
20 Amp Plug

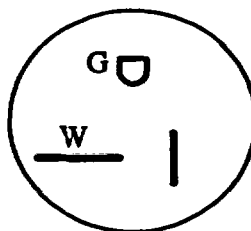

Altered
20 Amp Plug

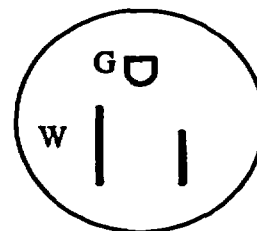

Conclusion

The fire was a result of modified plugs on two drum heaters, which defeated the intent of the design of electrical outlets. The licensee failed to comply with the procedural requirements for a temporary modification. The heavy smoke from the fire caused a deluge sprinkler system to actuate in a different fire area which sprayed on safety-related electrical equipment. 10 CFR 50.48(a) requires licensees to have a fire protection plan that meets General Design Criterion (GDC) 3 of Appendix A to 10 CFR Part 50. GDC 3 requires that structures, systems, and components that are important to safety shall be designed and located to minimize, the probability and effect of fires and explosions, consistent with other safety requirements.

Reference

Fort Calhoun Station NRC Special Team Inspection Report, 50-285/02-06, U.S. Nuclear Regulatory Commission. April 5, 2002. (ADAMS Accession # ML020960001).

APPENDIX I. MATHEMATICS REVIEW AND SYSTEM OF UNITS

This appendix discusses the following topics, which provide the essential, mathematical foundation for quantitative fire hazard analysis:

I.1 Mathematics Review

While it was our goal to minimize the use of mathematics as much as possible, there is a need to use some relatively simple mathematics to understand the principles of fire dynamics used in this NUREG. The mathematical methods used in this NUREG hinge on an understanding of units of measurement, the ability to read various types of graphs, the ability to solve simple algebraic equations and to determine the unit consistency of an equation, and the ability to use simple functions commonly found on a basic scientific calculator. The spreadsheets were designed with this in mind, i.e., each sheet shows equations and variables being input. It was the authors goal to further the science of fire dynamics while not burdening the users down with complex mathematical operations. Like wise it's the users responsibility to use the spreadsheets to gain an understanding of fire dynamics and not view them as "black boxes".

I.1.1 Units of Measurement

Fire dynamics most often uses units of measure from the system international (SI) metric system. While this may seem foreign at first, the transition to metric units is relatively easy and, once mastered, the metric system is much easier to use than English units of measure. Many of the spreadsheets are designed to allow the user to enter the information in English units, the spreadsheet will convert them to SI units, solve the problem and convert the answer back to English units.

Table I.1-1 summarizes the basic units of measure. These are units of length, mass, time, temperature, electric current, amount of light, and quantity of matter. All other units can be derived from these seven basic units. For instance, velocity (or speed) is a derived unit, expressed as meter per second (m/s), which is formed from the units of length and time.

| Units of Measure | Symbol | Unit (SI) | SI Symbol |
|--------------------|--------|-----------------|-----------|
| Length | L | meter | m |
| Mass | m | kilogram | kg |
| Time | t | second | s |
| Temperature | T | Celsius, Kelvin | °C, K |
| Electric current | A | ampere | A |
| Amount of light | cd | candela | cd |
| Quantity of matter | mol | mole | mol |

Table I.1-2 presents a partial listing of the derived units that are useful in fire dynamics. The table does not include units relevant to electricity, magnetism, or other areas that are not relevant to fire dynamics. Note that some units named after individuals are capitalized, while other units are not. For example, because the unit of power watt is named for James Watt of steam engine fame, the abbreviation (W) is capitalized.

| Table I.1-2. Derived Units | | |
|----------------------------|----------------------------|---------------------|
| Unit of Measure | Unit (SI) | SI Symbol |
| Acceleration | meter per square second | m/s ² |
| Area | square meter | m ² |
| Density | kilogram per cubic meter | kg/m ³ |
| Energy | joule (J) | N-m |
| Force | newton (N) | Kg-m/s ² |
| Frequency | hertz (Hz) | 1/s |
| Heat (quantity) | joule (J) | N-m |
| Heat flux | kilowatts per square meter | kW/m ² |
| Illuminance | lux (lx) | lm/m ² |
| Luminance | candela per square meter | cd/m ² |
| Luminous flux | lumen (lm) | lm/m ² |
| Power (heat release rate) | watt (W) | J/s |
| Pressure | pascal (Pa) | N/m ² |
| Radiant intensity | watt per steradian | W/sr |
| Specific heat | joule per kilogram-kelvin | J/kg-K |
| Stress | pascal (Pa) | N/m ² |
| Thermal conductivity | watt per meter-kelvin | W/m-K |
| Velocity | meter per second | m/s |
| Viscosity, dynamic | pascal-second | Pa-sec |
| Viscosity, kinematic | square meter per second | m ² /s |
| Volume | cubic meter | m ³ |
| Work | joule (J) | N-m |

Simple units of the types shown in Table I.1-1 and I.1-2 can be cumbersome if the magnitudes are very large or very small. For example, it is problematic to speak of distances between cities in meters (as in "City A is 5,000 meters from City B"). While this distance may be accurate, meters is not the most convenient unit in terms of magnitude. To avoid very large and very small numbers, the metric system uses prefixes to modify the magnitude of the basic unit. For example, 5,000 m is equivalent to 5 km. The prefix k refers to kilo and indicates multiplication by 1,000. Table I.1-3 lists the common prefixes used in the metric system from names and symbols of multiples (decimal multiples and sub-multiples) of the SI units. While these prefixes are optional, they often simplify matters. The distance in the example above (5,000 m or 5 km) is a common foot race distance, which is often further simplified by referring to a 5-k race.

| Table I.1-3. SI Prefixes | | |
|--|--------|-----------|
| Multiplication Factors | Prefix | SI Symbol |
| 1 000 000 000 000 = 10^{12} | tera | T |
| 1 000 000 000 = 10^9 | giga | G |
| 1 000 000 = 10^6 | mega | M |
| 1 000 = 10^3 | kilo | k |
| 0.01 = 10^{-2} | centi | c |
| 0.001 = 10^{-3} | milli | m |
| 0.000 001 = 10^{-6} | micro | μ |
| 0.000 000 001 = 10^{-9} | nano | n |
| 0.000 000 000 001 = 10^{-12} | pico | p |
| 0.000 000 000 000 001 = 10^{-15} | femto | f |
| 0.000 000 000 000 000 001 = 10^{-18} | atto | a |

Table I.1-4 introduces another useful concept, known as scientific notation. Rather than writing out 1,000,000, it is useful to use scientific notation, which indicates the number of zeros as an exponent. In Table I.1-3, we see an entry for the prefix mega, which refers to multiplication by 1,000,000 or, in scientific notation, 10^6 or $10E+06$. Thus, a distance of 5,000,000 m could be expressed as 5×10^6 m or 5 Mm. We see that scientific notation has essentially the same function as the prefixes.

| Table I.1-4. Scientific Notations, Prefixes and Abbreviations | | |
|---|--------|--------------|
| Multiplier | Prefix | Abbreviation |
| 10^{12} | tera | T |
| 10^9 | giga | G |
| 10^6 | mega | M |
| 10^3 | kilo | k |
| 10^2 | hecto | h |
| 10^{-2} | centi | c |

| Table I.1-4. Scientific Notations, Prefixes (continued) | | |
|---|--------|--------------|
| Multiplier | Prefix | Abbreviation |
| 10^{-3} | milli | m |
| 10^{-6} | micro | μ |
| 10^{-9} | nano | n |
| 10^{-12} | pico | p |
| 10^{-18} | atto | a |

While the information required for use in fire dynamics is generally available in metric units, the data are sometimes available only in English units and conversion to metric is needed. Table I.1-5 gives some of the most common conversions required for fire dynamics. These conversions are simple to apply. For example, to convert from feet to meter, multiply the number of feet by 3.048×10^{-1} (0.3048) to get the number in meter. Many of the spreadsheets have this conversion features built in to the sheet.

| Table I.1-5. Selected Unit Conversions | | |
|--|--|--|
| To Convert from | To | Multiply by |
| Area foot ² inch ² | meter ² (m ²) meter ² (m ²) | 9.290304×10^{-2} 6.451600×10^{-4} |
| Energy/Area Time watt/centimeter ² | watt/meter ² (W/m ²) | 1.0×10^4 |
| Length foot inch | meter (m) meter (m) | 3.048×10^{-1} 2.540×10^{-2} |
| Mass/Area pound-mass/foot ² | kilogram/meter ² (kg/m ²) | 4.882428×10^0 |
| Mass/Volume (including Density and Mass Capacity) pound-mass/foot ³ | kilogram/meter ³ (kg/m ³) | 1.601846×10^1 |

Table I.1-5. Selected Unit Conversions (continued)

| To Convert from | To | Multiply by |
|--|--|--|
| Pressure atmosphere bar inch of mercury inch of water pound-force/inch ² (psi) torr mm Hg, 0 °C) | Pascal (Pa) Pascal (Pa) Pascal (Pa) Pascal (Pa) Pascal (Pa) Pascal (Pa) | 1.01325×10^5 1.0×10^5 3.37685×10^3 2.4884×10^2 6.894757×10^3 1.33322×10^2 |
| Temperature degree Celsius degree Celsius degree Celsius degree Fahrenheit degree Fahrenheit degree Fahrenheit Kelvin Kelvin Kelvin Rankine Rankine Rankine | degree Fahrenheit (°F) Kelvin (K) Rankine (R) degree Celsius (°C) Kelvin (K) Rankine (R) degree Celsius (°C) degree Fahrenheit (°F) Rankine (R) degree Celsius (°C) degree Fahrenheit (°F) Kelvin (K) | $9/5 \text{ } ^\circ\text{C} + 32$ $^\circ\text{C} + 273.15$ $5/9 (R + 491.67)$ $5/9 (^\circ\text{F} - 32)$ $5/9 \text{ } ^\circ\text{F} + 255.37$ $^\circ\text{F} + 459.67$ $K - 273.15$ $9/5(K - 255.37)$ $9/5 K$ $5/9 (R - 491.67)$ $R - 459.67$ $5/9 R$ |
| Time day (mean solar) hour (mean solar) minute (mean solar) | second (s) second (s) second (s) | 8.640×10^4 3.60×10^3 6.0×10^1 |
| Velocity (includes Speed) foot/second mile/hour | meter/second (m/s) meter/second (m/s) | 3.0480×10^{-1} 4.4704×10^{-1} |
| Volume (including Capacity) foot ³ gallon (U.S. liquid) liter | meter ³ (m ³) meter ³ (m ³) meter ³ (m ³) | 2.831685×10^{-2} 3.785412×10^{-3} 1.0×10^{-3} |

The approach taken in converting from customary English units to SI units has been to retain the precision of the original measurement. For example, "It is about 8-miles," properly translates to "It is about 13 kilometers." Thus, would be inappropriate to convert the imprecise 8-mile measurement to a precise value of 12.875 kilometers (based on the exact conversion). The degree of precision implied by such an exact conversion is simply not implied by the original measurement. Therefore, conversions have been chosen to properly reflect the precision of the original measurement. For example, a 12-foot run of sprinkler piping converts to 3.7 meters, if the piping

is measured to the nearest inch. If measured to the nearest foot, the appropriate conversion is 4 meters.

For the most part the SI units into which quantities have been converted follow the SI practice of expressing a quantity so that its numerical value falls between 0.1 and 1,000. For example, 14.7 psi would be converted to 101 kPa, not 101,000 Pa. Some deviations from this practice have been allowed in instances where several values of the same quantity are being compared or presented in tabular form. For example, if four fire test samples have masses of 500 kg, 800 kg, 900 kg, and 1,200 kg, it would be inappropriate to express the last entry as 1.2 Mg.

1.1.2 Math Functions

This section discusses several mathematical functions that are common to many of the equations and empirical correlations used in fire dynamics. These functions can all be calculated using a simple scientific hand calculator.

- (1) A "power" is an exponent (x) that operates on a base (y) real number in the function y^x . When the power is a whole number, the function can be expressed as the base multiplied by itself the number of times indicated by the power.

$$y^x = (3.2)^3 = (3.2) \times (3.2) \times (3.2) = 32.768$$

When the same base (y) is raised to different powers and the quantities are multiplied, the "powers" are added, as illustrated by the following examples:

(a) $(Q)^{\frac{3}{2}} \cdot (Q)^{\frac{4}{2}} = (Q)^{\frac{3+4}{2}} = (Q)^{\frac{7}{2}}$

(b) $(Z)^2 \cdot (Z)^3 = (Z)^{2+3} = (Z)^5$

Similarly, when the same base (y) is raised to different powers and the quantities are divided, the power are subtracted as illustrated by the following examples:

(a) $\frac{(Q)^{\frac{3}{2}}}{(Q)^{\frac{2}{2}}} = (Q)^{\frac{3-2}{2}} = (Q)^{\frac{1}{2}}$

(b) $\frac{(Z)^2}{(Z)^3} = (Z)^{2-3} = (Z)^{-1} = \frac{1}{(Z)^1} = \frac{1}{Z}$

By contrast, when a power (x) is raised to another power, they multiply, as illustrated by the following example:

$$\left(Z \cdot Q^{\frac{1}{2}} \right)^3 = (Z)^{1 \times 3} \cdot (Q)^{\frac{1}{2} \times 3} = Z^3 \cdot Q^{\frac{3}{2}}$$

Finally when a number or variable has no "power", it is assumed to be raised to the power of 1 because any "base" raised to the "power" of 1 is equal to the "base" as illustrated by the following examples:

$$(Z)^1 = Z$$
$$(Q)^1 = Q$$

In summary, the following examples are valid mathematical equations using powers:

(a) $Q^x Q^r = Q^{x+r}$

(b) $\frac{Q^x}{Q^r} = Q^{x-r}$

(c) $(Q^x)^r = Q^{xr}$

A scientific calculator typically has a y^x button.

(2) A logarithm is an exponent indicating the power to which a fixed number (the base) must be raised to produce a given number. For example, if $n^x = a$, then the logarithm of a , with n as the base, is x , as illustrated by the following function:

$$\text{LOG}_n (a) = x$$

Scientific calculators typically have two logarithmic buttons typically identified as LOG and LN. In such cases, LOG returns the logarithm of the imputed value using a base equal to 10.

This common logarithm functions as follows:

$$\text{LOG}_{10} (\text{value entered}) = x (\text{value calculator returns})$$

By contrast, LN returns the logarithm of the imputed value using the base equal to "e", which is the real number for which the whose natural logarithm is 1 (≈ 2.718). This "natural logarithm" function as follows:

$$\text{LOG}_e (\text{value entered}) = x (\text{value calculator returns}).$$

I.1.3 Solving Equations

"Equation solving" is a central theme in mathematics which is considerably broader than the treatment given here. The FDT* we are using for fire hazard analysis (FHA) is simply based on algebraic equations, in which we substitute numbers for the variables and calculate a numerical result. This calculation hinges on inserting numbers for the variable names with units included, and then checking or adjusting the units to ensure dimensional consistency through a process called dimensional analysis. This process is based on the principle that units associated with numbers are operated on, just as the numerical values are, through algebraic manipulations.

Units follow the rules set forth for powers, because units can also have associated powers.

- When divided, units cancel through power subtraction, as illustrated by the following examples:

(a) $\frac{\text{kg} \cdot \text{m}}{\text{kg}} = \text{kg}^{1-1} \cdot \text{m} = \text{m}$

(b) $\frac{\text{kg}^3 \cdot \text{m}}{\text{kg}} = \text{kg}^{3-1} \cdot \text{m} = \text{kg}^2 \cdot \text{m}$

- When multiplied units combine through power addition, as illustrated by the following examples:

(a) $(3 \text{ kg}) \times (5 \text{ kg}^2) = 15 \text{ kg}^3$

(b) $\frac{\text{m} \cdot \text{m}}{\text{kg}^2} = \frac{\text{m}^2}{\text{kg}^2}$

- When raised to other powers, units powers are multiplied, as illustrated by the following examples:

(a) $\left(x \text{ kg}^{\frac{1}{3}} \text{ m}^3 \text{ s}^2\right)^{\frac{1}{2}} = x^{\frac{1}{2}} \text{ kg}^{\frac{11}{32}} \text{ m}^{\frac{3}{2}} \text{ s}^{\frac{1}{2}} = x^{\frac{1}{2}} \text{ kg}^{\frac{1}{6}} \text{ m}^{\frac{3}{2}} \text{ s}^{\frac{1}{2}}$

The horizontal flame spread rate on thick solid fuels equation will serve as good illustration::

$$V = \frac{\Phi}{k\rho c(T_{ig} - T_a)^2}$$

Where:

V = flame spread rate (m/sec)

Φ = a flame spread modulus (kW)²/m³ (determined experimentally)

kρc = thermal inertia (kW/m² K)² sec

T_{ig} = material ignition temperature (°C)

T_a = initial material temperature (°C)

The literature provides the following data for plywood:

$$\Phi = 12.9 \text{ (kW)}^2/\text{m}^3$$

$$k\rho c = 0.54 \text{ (kW/m}^2 \text{ K)}^2 \text{ sec}$$

$$T_{ig} = 390 \text{ }^\circ\text{C}$$

We cannot solve for the flame spread rate until we select a material temperature T_a. Indeed, the point of the equation is to show how the flame spread rate varies with material and material temperature. As an example, let's use T_a = 200 °C. Substituting the numerical values in the equation, we can compute the flame spread rate on plywood, as follows:

$$V = \frac{129 \frac{(\text{kW})^2}{\text{m}^3}}{0.54 \left(\frac{\text{kW}}{\text{m}^2 \text{K}} \right)^2 \text{sec} \left(390 \text{ }^\circ\text{C} - 200 \text{ }^\circ\text{C} \right)^2}$$

$$V = \frac{129}{(0.54)(190)^2} \frac{\frac{\text{kW}^2}{\text{m}^3}}{\frac{\text{kW}^2 \text{sec } ^\circ\text{C}^2}{\text{m}^4 \text{K}^2}}$$

We can now use a calculator to perform the multiplications and division to obtain an answer as follows:

$$V = 0.00066 \frac{\frac{\text{kW}^2}{\text{m}^3}}{\frac{\text{kW}^2 \text{sec } ^\circ\text{C}^2}{\text{m}^4 \text{K}^2}}$$

It remains to check the consistency of the units. The kW^2 and m^3 in the above equation, as follows:

$$V = 0.00066 \frac{1}{\frac{\text{sec } ^\circ\text{C}^2}{\text{m K}^2}}$$

At first inspection, it does not appear that the two temperature units will cancel, even though they are both raised to the power of 2. However, because the $^\circ\text{C}^2$ unit comes from a temperature difference, it will cancel because the only difference between $^\circ\text{C}$ and K is an added constant. Thus to convert from $^\circ\text{C}$ to K , you add 273, as follows:

$$\begin{aligned} (390 \text{ }^\circ\text{C} - 200 \text{ }^\circ\text{C})^2 &= [(390 \text{ }^\circ\text{C} + 273 \text{ K}) - (200 \text{ }^\circ\text{C} + 273 \text{ K})]^2 \\ &= [663 \text{ K} - 473 \text{ K}]^2 \\ &= 190 \text{ K}^2 \end{aligned}$$

The result in terms of temperature differentials (ΔT), $190 \text{ }^\circ\text{K}^2$ is the same as $190 \text{ }^\circ\text{C}^2$.

If the $^\circ\text{C}$ term were not difference, it would require the conversion to K^2 . Thus, in this case, the $^\circ\text{C}^2$ and the K^2 units cancel.

$$V = 0.00066 \frac{1}{\frac{\text{sec}}{\text{m}}}$$

The resulting unit is m/s as follows:

$$V = 0.00066 \frac{\text{m}}{\text{sec}}$$

Thus, the result is complete and the units are consistent and reasonable. Meter/second (m/s) is the unit of velocity as the equation indicated it should be.

I.1.4 Cautions with ΔT Conversions

A word of caution is in order about converting temperature between Celsius ($^{\circ}\text{C}$) and Fahrenheit ($^{\circ}\text{F}$). For conversion between the temperature scales:

$$^{\circ}\text{F} = (^{\circ}\text{C} \times 1.8) + 32$$

$$^{\circ}\text{C} = (^{\circ}\text{F} - 32) / 1.8$$

For example, to convert the temperature 250 $^{\circ}\text{F}$ to $^{\circ}\text{C}$;

$$\begin{aligned}^{\circ}\text{C} &= (250 \text{ }^{\circ}\text{F} - 32) / 1.8 \\ &= (218) / 1.8 \\ &= 121.11 \sim 121 \text{ }^{\circ}\text{C}\end{aligned}$$

However, to establish a ration such as a temperature rise (ΔT);

$$^{\circ}\text{F} = (^{\circ}\text{C} \times 1.8)$$

$$^{\circ}\text{C} = (^{\circ}\text{F} / 1.8)$$

For example, to convert a temperature rise (ΔT) of 250 $^{\circ}\text{F}$ to $^{\circ}\text{C}$;

$$\begin{aligned}^{\circ}\text{C} &= (250 \text{ }^{\circ}\text{F} / 1.8) \\ &= 138.89 \sim 139 \text{ }^{\circ}\text{C}\end{aligned}$$

Note that ASTM E119, "Standard Test Method for Fire Tests of Building Construction and Materials," properly applies these conversions as illustrated in "Tests of Nonbearing Walls and Partitions," Section 18.1.3, "Transmission of heat through the wall or partition during the fire endurance test shall not have been such as to rise the temperature on its unexposed surface more than 250 $^{\circ}\text{F}$ (139 $^{\circ}\text{F}$) above its initial temperature".

NFPA 251, 1995 Edition, "Standard Method of Fire Tests of Building Construction and Materials," does not make this same conversion, "Transmission of heat through the wall or partition during the fire endurance test shall not be sufficient to rise the temperature on its unexposed surface more than 250 $^{\circ}\text{F}$ (121 $^{\circ}\text{C}$) above its initial temperature. For the purpose of this NUREG, the conversion of ASTM E119 will be used.

I.1.5 Miscellaneous Information

The following information provide that involve measurement of geometrical quantities in the form of diameter, circumference, and area etc.

- To find the diameter of a circle, multiply the circumference by 0.31831.

$$D_c = C \ 0.31831$$

- To find the circumference of a circle, multiply the diameter by 3.14159.

$$C_c = \pi D = 3.14159D$$

- To find the area of a circle, multiply the square of the diameter by 0.78539.

$$A_c = \frac{\pi}{4} D^2 = 0.78539D^2$$

- To find the surface of a sphere, multiply the square of the diameter by 3.14159.

$$A_s = \pi D^2 = 3.14159D^2$$

- To find the volume of a sphere, multiply the cube of the diameter by 0.52369.

$$V_s = \frac{\pi}{6} D^3 = 0.52369D^3$$

- Doubling the diameter of a pipe or hose increases its capacity four times.

$$2D = 4\text{Capacity}$$

I.1.6 References

Fire Dynamics Course Guide, Federal Emergency Management Agency (FEMA), United States Fire Administration (USFA), National Emergency Training Center, Emmitsburg, Maryland, 1995.

Qunitiere, J.G., *Principles of Fire Behavior*, Delmar Publishers, Albany, New York, 1997.

"Standard for Use of the International System of Units (SI): The Modern Metric System," IEEE/ASTM SI 10-1997, Institute of Electrical and Electronics Engineer, Inc., (IEEE), New York, New York, and American Society of Testing and Materials (ASTM), West Conshohocken, Pennsylvania, 1997.

Taylor, B.N. "Guide for the Use of the International System of Units (SI)," NIST Special Publication 811, 1995 Edition, National Institute of Standards and Technology (NIST), Gaithersburg, Maryland.

This page intentionally left blank.

1.2 Notation Conventions

This section provide various notation conventions used in the fire dynamics to expressed a quantity related to fire protection engineering, for example, heat flux density (\dot{q}'') or heat release rate (\dot{Q}).

X, x Generally letters are assigned to physical phenomena. In fire protection engineering there is often a special significance implied by either upper or lower case. The use of notation is important in fire dynamics, upper and lower case are recommended.

The following symbols indicate additional characteristics of a single quantity to simplify both memorization needs and dimensional verification of calculations.

- \dot{X} A dot over a letter means that quantity "per unit time" (e.g., rate).
- \ddot{X} A double dot over a letter means that quantity "per unit time per unit time" (e.g., acceleration is the change in velocity over a period of time).
- X' An apostrophe to the right of a letter means that quantity "per unit length".
- X'' Two apostrophies to the right of a letter means that quantity "per unit area."
- X''' Three apostrophies to the right of a letter means that quantity "per unit volume."
- \bar{X} A bar over a letter means the arithmetic average value (the mean value) of varying quantity.

The following usage conventions also apply to the equations used in FHA.

- \dot{X}'' Notations may be combined as needed.
- kW** With unit abbreviations, it is customary to use a capital letter when the abbreviation signifies a person's name (e.g., W for Watt, kW for kilowatt).
- x/y Units in the denominator are generally shown without a prefix (s, m, etc.), but there is an exception (i.e., kg).
- $x/(y z^0)$ Quantities with more than one unit in the denominator are shown with the denominator in parentheses and units separated by a space.

1.2.1 Reference

SI Units Fire Protection Engineering, 1980 Report of the Measurement of Fire Phenomena Committee, Society of Fire Protection Engineers (SFPE), Boston, Massachusetts, March 1980.

This page intentionally left blank.

I.3 System of Units

When expressing a physical quantity by a numerical value, a unit must be selected for that quantity defined by appropriate notation, letters or symbols. Certain units are by convention regarded as dimensionally independent; these units are called base units, and all other units (derived units) can be expressed algebraically in terms of the base units. The following section describes the fundamental basic and derived units of measurements.

I.3.1 Length, Area, and Volume Units

The basic SI unit of length is the meter (m). Originally, the meter was selected as one ten-millionth of the distance from earth's equator to the North Pole.

The basic SI units of area is square meter (m^2), square centimeter (cm^2), and so on. Land areas are expressed in hectares (ha); 1 hectare is $10,000 m^2$. The English equivalent of the hectare is 2.47 acres.

Similarly, volume is expressed in cubic meters (m^3), cubic centimeters (cm^3), and so on. The liter (L), which is also commonly used as a unit of volume, is the same as 1 cubic decimeter (dm^3) or 1,000 cubic centimeters (cm^3). The English equivalency of the liter is 0.264 U.S. gallons.

I.3.2 Mass and Density Units

The basic SI unit of mass is the kilogram (kg). The kilogram was selected because it is approximately the mass of 1 liter of water. The gram (g), also widely used, is one one-thousandth of a kilogram, which is approximately the mass of 1 cubic centimeter of water. (Water expands or contracts slightly as its temperature changes.)

Density (mass per unit volume) is generally expressed in grams per cubic centimeter (g/cm^3) or kilograms per cubic decimeter (kg/dm^3). The numerical value of density is the same in either of these units. "Specific gravity" refers to the ratio of the density of a substance to that of liquid water.

Confusion often exists between mass and weight. Weight refers to the force acting on an object because of gravitational attraction. As such, it is a convenient way to measure mass at sea level on earth. However, if an object were on the moon, its weight would be only about one-sixth of its weight on earth and in an orbiting space station, the object would be weightless; however, its mass would be the same in each case as it is on earth. The mass of an object is the sum of masses of its constituent atoms and is invariant (except in a nuclear bomb explosion, when mass changes into energy). This fact can be proved by an experiment measuring the inertia of an object (the force needed to accelerate it the object).

I.3.3 Time Units

Units of time are the same in the SI system as in the English system. The basic unit is the second (s).

I.3.4 Force and Pressure Units

The basic unit of force in the SI system is the newton (N). A newton is the force needed to accelerate a mass of 1 kg at the rate of 1 m/sec². In the English system, 1 lb of force will accelerate 1 lb of mass at the rate of 32.2 ft/sec². This definition was selected so that 1 lb of mass at sea level would feel a gravitational attraction of 1 lb of force.

From the relationships between the pound and the kilogram, and between the foot and the meter, it is easy to show that a newton is equal to 0.224 lb of force. The gravitational force on 1 kg of mass at sea level is 9.81 N.

Pressure is force per unit area. The basic SI unit of pressure is the pascal (Pa), which is 1 N/m². One Pa is a very low pressure; therefore, we also use a unit called the bar, which is defined as 100,000 Pa or 100 kilopascals (kPa). One bar is only 1.3 percent greater than normal atmospheric pressure at sea level; therefore, 1 bar is nearly equal to 1 atmosphere (atm).

In the English system, pressure is often expressed in pounds per square inch (psi) or in inches of water (H₂O) or mercury (Hg). One bar equals 14.89 psi and kPa equals 4.02 in. of water.

I.3.5 Energy Units

The basic SI unit of energy is the joule (J). A joule is the quantity of energy expended when a force of 1 N pushes something a distance of 1 m. Both thermal and mechanical energy can be expressed as joules. One joule equals 0.239 calorie (cal), and 4.187 J equals 1 cal. (A calorie is the energy needed to heat 1 g of water 1 °C; a dietitian's calorie is actually 1,000 calories.)

Electrical energy can also be expressed in joules; in the case, 1 J equals 1 watt-second (Ws) and one megajoule (MJ) (1,000,000 J) equals 0.278 kilowatt-hour (kW-h). For example, if a power of 1 kW is released in an electric iron for 0.278 h, 1 MJ of thermal energy has been released.

In English units, energy is expressed in foot-pounds (ft-lb) or British thermal units (Btu). One ft-lb is equal to 1.355 J, and 1 Btu is equal to 1,044 J or 252 cal.

I.3.6 Power Units

Power is the rate at which energy is expended. In SI units, power is expressed in watts (W), kilowatts (1,000 W) or megawatts (MW) (1,000,000 W). One watt is 1 J/sec. In English units, power is expressed as horsepower (hp), where one horsepower equals 745 W. Also, note that 1 Btu/sec equals 1.055 kW. (For first order approximation, 1 Btu/sec roughly equals 1 kW).

I.3.7 Temperature Units

The SI system uses both the Celsius (°C) and Kelvin scale (K) temperature scales. A Celsius degree (previously called centigrade) is one one-hundredth of the difference between the temperature of melting ice and boiling water at a pressure of 1 atmosphere (atm). On the Celsius scale (at sea level), 0° is the melting point of ice (or the freezing point of water) and 100° is the boiling point of water. Negative temperatures are possible.

On the Kelvin scale (Celsius absolute), sometimes called the thermodynamic temperature, the zero point is called "absolute zero" and equals $-273.15\text{ }^{\circ}\text{C}$. No temperature colder than this is possible; that is, negative temperatures are not possible. The Kelvin scale is expressed in Kelvin, not degrees Kelvin.

Other features of the Kelvin scale indicate its basic nature:

- The volume occupied by a gas is proportional to its temperature on the Kelvin scale, as long as its pressure is held constant (except at pressures far above atmospheric pressure).
- The thermal radiation emitted by an opening in a hot furnace is proportional to the fourth power of the Kelvin temperature.
- The velocity of sound through a gas is proportional to the square root of its Kelvin temperature.

Because of these and other scientific facts, it would be logical to use only the Kelvin scale for temperature. However, the world continues to use both scales because the Celsius was used for more than century before these facts were discovered.

By contrast, the English system uses the Fahrenheit temperature scale ($^{\circ}\text{F}$). One Fahrenheit degree is one eightieth of the difference between the temperature of melting of ice and boiling water at a pressure of 1 atm. On the Fahrenheit scale (at sea level), 32° is the melting point of ice (or the freezing point of water), and 212° is the boiling point of water.

I.3.8 References

ASTM E-380-93, "Standard Practice for Use of the International System of Units (SI) (the Modernized Metric System)," American Society for Testing and Materials (ASTM), West Conshohocken, Pennsylvania.

IEEE/ASTM SI 10-1997, "Standard for Use of the International System of Units (SI): The Modern Metric System," Institute of Electrical and Electronics Engineer, Inc., (IEEE), New York, New York, and American Society of Testing and Materials (ASTM), West Conshohocken, Pennsylvania, 1997.

Taylor, B.N., "Guide for the Use of the International System of Units (SI)," NIST Special Publication 811, 1995 Edition, National Institute of Standards and Technology (NIST), Gaithersburg, Maryland.

This page intentionally left blank.

I.4 Physical Constants for General Use

Table I.4.1 provides common values of physical constants used in the fire dynamics and other engineering and scientific calculations. Table I.4.1 show the values of several different constants in SI units having special names and symbols.

| Table I.4-1. Values of Constants for General Use | | | |
|---|----------|---------------------------|-------------------------------------|
| Constant Name | Symbol | Value | SI Unit |
| Standard atmospheric pressure | P_a | 100 | kPa |
| Absolute zero (temperature) | T | 0 | K |
| Standard acceleration due to gravity | g | 9.80665 | m/s ² |
| Velocity of sound in air (P_a , 20 °C, 50% R.H.) | M | 344 | m/s |
| Specific volume of perfect gas at standard temperature and pressure | V_a | 22.414 | m ³ /(k-mol) |
| Characteristic gas constant for air | R_a | 287.045 | J/(kg K) |
| Characteristic gas constant for water vapor | R_v | 461.52 | J/(kg K) |
| Natural logarithms | e | 2.7182818285 | – |
| Pi | π | 3.1415926536 | – |
| Stenfan-Boltzman constant | σ | 5.67032×10^{-11} | kW/(m ² K ⁴) |

I.4-1 Reference

SI Units Fire Protection Engineering, 1980 Report of the Measurement of Fire Phenomena Committee, Society of Fire Protection Engineers (SFPE), Boston, Massachusetts. March 1980.

This page intentionally left blank.

APPENDIX J. PRACTICE PROBLEMS AND SOLUTIONS

This page intentionally left blank.

APPENDIX J. PRACTICE PROBLEMS AND SOLUTIONS

This appendix contains problems to apply the principles learned in the NUREG with the FDT[®] program. This appendix provide some additional practice to solve problems related to fire dynamics.

| NUREG Chapter and Related Calculation Method | | |
|--|--|---|
| Problem | NUREG Chapter | FDT [®] |
| J-1 | <p>Chapter 2. Method of Predicting Hot Gas Layer Temperature and Smoke Layer Height in a Room Fire with Natural and Forced Ventilation</p> <p>Method of McCaffrey, Quintiere, and Harkleroad (MQH) Compartment with Thermally Thick Boundaries</p> | <p>Temperature_NV.xls (Temperature-NV Thermally Thin)</p> |
| J-2 | <p>Chapter 2. Method of Predicting Hot Gas Layer Temperature and Smoke Layer Height in a Room Fire with Natural and Forced Ventilation</p> <p>Method of Foote, Pagni, and Alvares (FPA) Compartment with Thermally Thick Boundaries</p> <p>Method of Deal and Beyler Compartment with Thermally Thick Boundaries</p> | <p>Temperature_FV1.xls (Temperature-FV Thermally Thick)</p> <p>Temperature_FV2.xls (Temperature-FV Thermally Thick)</p> |
| J-3 | <p>Chapter 2. Method of Predicting Hot Gas Layer Temperature and Smoke Layer Height in a Room Fire with Natural and Forced Ventilation</p> <p>Method of McCaffrey, Quintiere, and Harkleroad (MQH) Compartment with Thermally Thick Boundaries</p> <p>Method of Foote, Pagni, and Alvares (FPA) Compartment with Thermally Thick Boundaries</p> <p>Method of Deal and Beyler Compartment with Thermally Thick Boundaries</p> | <p>Temperature_NV.xls (Temperature-NV Thermally Thin)</p> <p>Temperature_FV1.xls (Temperature-FV Thermally Thick)</p> <p>Temperature_FV2.xls (Temperature-FV Thermally Thick)</p> |

| NUREG Chapter and Related Calculation Method (continued) | | |
|--|---|--|
| Problem | NUREG Chapter | FDT ^a |
| J-4 | Chapter 3. Estimating Burning Characteristics of Liquid Pool Fire, Heat Release Rate, Burning Duration, and Flame Height | HRR_Flame_Height_Burning_Duration_Calculation.xls |
| J-5 | Chapter 4. Estimating Burning Characteristics of Liquid Pool Fire, Heat Release Rate, Burning Duration, and Flame Height | Flame_Height_Calculations.xls Wall_Line_Flame_Height Corner_Flame_Height Wall_Flame_Height |
| J-6 | Chapter 2. Method of Predicting Hot Gas Layer Temperature and Smoke Layer Height in a Room Fire with Natural and Forced Ventilation Method of Foote, Pagni, and Alvares (FPA) Compartment with Thermally Thick Boundaries Method of Deal and Beyler Compartment with Thermally Thick Boundaries | Temperature_FV1.xls (Temperature-FV Thermally Thick) (Compartment with Thermally Thin Boundaries) Temperature_FV2.xls (Temperature-FV Thermally Thick) (Compartment with Thermally Thin Boundaries) |
| J-7 | Chapter 5. Estimating Radiant Heat Flux from Fire to a Target Fuel <i>Wind Free Condition</i> Solid Flame Radiation Model (Target at Above Ground Level) | Heat_Flux_Calculations_Wind_Free.xls (Solid Flame 2) |
| J-8 | Chapter 6. Estimating the Ignition Time of a Target Fuel Exposed to a Constant Radiative Heat Flux Method of Estimating Piloted Ignition Time of Solid Materials Under Radiant Exposures. Method of (1) Mikkola and Wichman (2) Quintiere and Harleroad and (3) Janssens | Ignition_Time_Calculations.xls (Ignition_Time_Calculations1) |

| NUREG Chapter and Related Calculation Method (continued) | | |
|---|--|--|
| Problem | NUREG Chapter | FDT* |
| J-9 | Chapter 7. Estimating the Full-Scale Heat Release Rate of a Cable Tray Fire | Burning_Duration_Soild.xls |
| J-10 | Chapter 9. Estimating the Centerline Temperature of a Buoyant Fire Plume | Plume_Temperature_Calculations.xls |
| J-11 | Chapter 10. Estimating Sprinkler Response Time | Detector_Activation_Time.xls (Sprinkler) |
| J-12 | Chapter 12. Estimating Heat Detector Response Time | Detector_Activation_Time.xls (FTHDetector) |
| J-13 | Chapter 13. Predicting Compartment Flashover Compartment Post-Flashover Temperature. Method of Law Minimum Heat Release Rate Required to Compartment Flashover. Method of (1) McCaffrey, Quintiere, and Harkleroad (MQH) (2) Babrauskas, and (3) Thomas | Compartment_Flashover_Calculations.xls (Post_Flashover_Temperature) (Flashover-HRR) |
| J-14 | Chapter 14. Estimating Pressure Rise Attributable to a Fire in a Closed Compartment | Compartment_Over_Pressure_Calculations.xls |
| J-15 | Chapter 17. Calculating the Fire Resistance of Structural Steel Members Empirical Correlations | FR_Beams_Columns_Substitution_Correlation.xls FR-Beam |

| NUREG Chapter and Related Calculation Method (continued) | | |
|--|---|---|
| Problem | NUREG Chapter | FDT* |
| J-16 | Chapter 3. Estimating Burning Characteristics of Liquid Pool Fire, Heat Release Rate, Burning Duration, and Flame Height | HRR_Flame_Height_Burning_Duration_Calculation.xls |
| | Chapter 2. Method of Predicting Hot Gas Layer Temperature and Smoke Layer Height in a Room Fire with Natural and Forced Ventilation | |
| | Method of McCaffrey, Quintiere, and Harkleroad (MQH) Compartment with Thermally Thick Boundaries | Temperature_NV.xls (Temperature-NV Thermally Thin) |
| | Chapter 9. Estimating the Centerline Temperature of a Buoyant Fire Plume | Plume_Temperature_Calculations.xls |
| | Chapter 5. Estimating Radiant Heat Flux from Fire to a Target Fuel | Heat_Flux_Calculations_Wind_Free.xls |
| | <i>Wind Free Condition</i> Point Source Radiation Model (Target at Ground Level) | (Point Source) |
| | Solid Flame Radiation Model (Target Above Ground Level) | (Solid Flame 2) |
| Chapter 10. Estimating Sprinkler Response Time | Detector_Activation_Time.xls (Sprinkler) | |
| Chapter 13. Predicting Compartment Flashover | Compartment_Flashover_Calculations.xls (Flashover-HRR) | |

NUREG Chapter and Related Calculation Method (continued)

| Problem | NUREG Chapter | FDT ^s |
|---------|---|---|
| J-17 | <p>Chapter 3. Estimating Burning Characteristics of Liquid Pool Fire, Heat Release Rate, Burning Duration, and Flame Height</p> <p>Heat Release Rate, Burning Duration, and Flame Height</p> <p>Chapter 2. Method of Predicting Hot Gas Layer Temperature and Smoke Layer Height in a Room Fire with Natural and Forced Ventilation</p> <p>Method of McCaffrey, Quintiere, and Harkleroad (MQH) Compartment with Thermally Thick Boundaries</p> <p>Chapter 9. Estimating the Centerline Temperature of a Buoyant Fire Plume</p> <p>Chapter 5. Estimating Radiant Heat Flux from Fire to a Target Fuel</p> <p><i>Wind Free Condition</i> Point Source Radiation Model (Target at Ground Level) Solid Flame Radiation Model (Target Above Ground Level)</p> <p>Chapter 10. Estimating Sprinkler Response Time</p> <p>Chapter 13. Predicting Compartment Flashover</p> | <p>HRR_Flame_Height_Burning_Duration_Calculation.xls</p> <p>Temperature_NV.xls (Temperature-NV Thermally Thin)</p> <p>Plume_Temperature_Calculations.xls</p> <p>Heat_Flux_Calculations_Wind_Free.xls</p> <p>(Point Source)</p> <p>(Solid Flame 2)</p> <p>Detector_Activation_Time.xls (Sprinkler)</p> <p>Compartment_Flashover_Calculations.xls (Flashover-HRR)</p> |

| NUREG Chapter and Related Calculation Method (continued) | | |
|---|---|--|
| Problem | NUREG Chapter | FDT* |
| J-18 | Chapter 3. Estimating Burning Characteristics of Liquid Pool Fire, Heat Release Rate, Burning Duration, and Flame Height | HRR_Flame_Height_Burning_Duration_Calculation.xls |
| J-19 | Chapter 3. Estimating Burning Characteristics of Liquid Pool Fire, Heat Release Rate, Burning Duration, and Flame Height | HRR_Flame_Height_Burning_Duration_Calculation.xls |

Problem J-1

Problem Statement

Consider a compartment 9.0 m wide x 9.0 m long x 3.7 m high (30 ft wide x 30 ft long x 12 ft high) ($w_c \times l_c \times h_c$) with a door vent that is 0.92 m wide x 2.15 m high (3 ft wide x 7 ft high) ($w_v \times h_v$). The fire is constant with an HRR of 1,500 kW (1,422 Btu/sec). Assume that the top of the vent is at 2.45 m (8 ft). Compute the hot gas temperature in the compartment. In addition compute the smoke layer height at 5 minutes after the ignition assuming that the compartment boundaries are made of 2.54 cm (1.0 in) thick gypsum board.

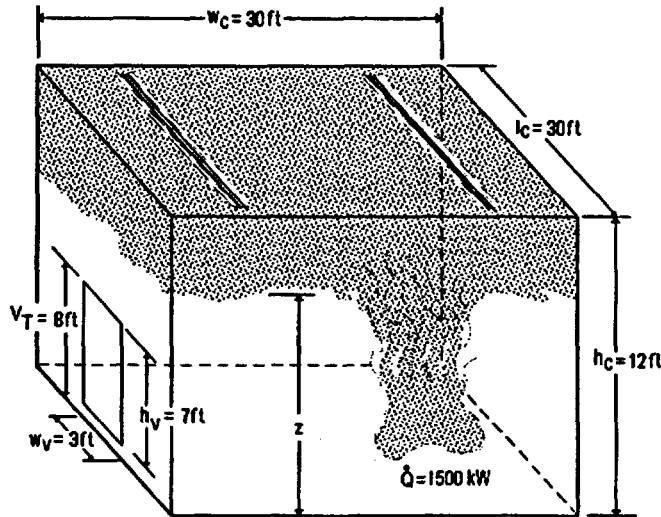

Problem 1: Compartment Fire with Natural Ventilation

Solution

Purpose:

- (1) Determine the hot gas temperature in the compartment (T_g) for $t = 5$ min after ignition.
- (2) Determine the smoke layer height (z) for $t = 5$ min after ignition.

Assumptions:

- (1) Ambient air properties are at 25 °C (77 °F).
- (2) The ceiling is unconfined, unobstructed, and flat.
- (3) The heat flow through the compartment boundaries is one-dimensional.
- (4) The heat release rate (HRR) is constant.
- (5) The fire is located at the center of the compartment or away from the walls.

Spreadsheet (FDT[®]) Solution Procedure:

Use the following FDT[®]:

- (a) Temperature_NV.xls (select *Temperature_NV Thermally Thin*)

Note: Since the interior boundary material thickness is equal to 2.54 cm (1 in), use the spreadsheet for thermally thin material.

FDT[®] Input Parameters:

Enter the following parameters in the spreadsheet (values only):

- Compartment Width (w_c) = 30 ft
- Compartment Length (l_c) = 30 ft
- Compartment Height (h_c) = 12 ft
- Vent Width (w_v) = 3 ft
- Vent Height (h_v) = 7 ft
- Top of Vent from Floor (V_T) = 8 ft
- Interior Lining Thickness (δ) = 1 in
- Select Material: select Gypsum Board from the combo box
- Fire Heat Release Rate (\dot{Q}) = 1,500 kW
- Time after Ignition (t) = 5 min

Note: When Gypsum Board is selected, its thermal properties are automatically selected from the table and entered in the corresponding input cells.

Results*

From the table of results of the spreadsheet at $t = 5$ minutes after ignition we obtain:

| Hot Gas Layer Temperature T_g °C (°F) | Smoke Layer Height z m (ft) |
|--|--|
| 527 (981) | 0.09 (0.28) compartment filled with smoke |

*spreadsheet calculations attached on next page

Spreadsheet Calculations

CHAPTER 2 - PREDICTING HOT GAS LAYER TEMPERATURE AND SMOKE LAYER HEIGHT IN ROOM FIRE WITH NATURAL VENTILATION COMPARTMENT WITH THERMALLY THIN BOUNDARIES

The following calculations estimate the hot gas layer temperature and smoke layer height in enclosure fire. Parameters should be specified ONLY IN THE YELLOW INPUT PARAMETER BOXES. All subsequent output values are calculated by the spreadsheet and based on values specified in the input parameters. This spreadsheet is protected and secure to avoid errors due to a wrong entry in a cell(s). The chapter in the NUREG should be read before an analysis is made.

INPUT PARAMETERS

COMPARTMENT INFORMATION

| | | |
|----------------------------------|----------|----------|
| Compartment Width (w_c) | 30.00 ft | 9.144 m |
| Compartment Length (l_c) | 30.00 ft | 9.144 m |
| Compartment Height (h_c) | 12.00 ft | 3.6576 m |
| Vent Width (w_v) | 3.00 ft | 0.914 m |
| Vent Height (h_v) | 7.00 ft | 2.134 m |
| Top of Vent from Floor (V_T) | 8.00 ft | 2.438 m |
| Interior Lining Thickness () | 1.00 in | 0.0254 m |

For thermally thin case the interior lining thickness should be less than or equal to 1 inch.

AMBIENT CONDITIONS

| | | |
|-----------------------------------|------------------------|----------|
| Ambient Air Temperature (T_a) | 77.00 °F | 25.00 °C |
| Specific Heat of Air (c_p) | 1.00 kJ/kg-K | 298.00 K |
| Ambient Air Density (ρ_a) | 1.20 kg/m ³ | |

THERMAL PROPERTIES OF COMPARTMENT ENCLOSING SURFACES

| | |
|--|---|
| Interior Lining Thermal Inertia ($k c$) | 0.18 (kW/m ² -K) ² -sec |
| Interior Lining Thermal Conductivity (k) | 0.00017 kW/m-K |
| Interior Lining Specific Heat (c) | 1.1 kJ/kg-K |
| Interior Lining Density () | 960 kg/m ³ |

EXPERIMENTAL THERMAL PROPERTIES FOR COMMON INTERIOR LINING MATERIALS

| Material | $k c$ (kW/m ² -K) ² -sec | k (kW/m-K) | c (kJ/kg-K) | (kg/m ³) | Select Material |
|------------------------|---|-----------------|------------------|----------------------|----------------------------|
| Aluminum (pure) | 500 | 0.206 | 0.895 | 2710 | Gypsum Board |
| Steel (0.5% Carbon) | 197 | 0.054 | 0.465 | 7850 | Scroll to desired material |
| Concrete | 2.9 | 0.0016 | 0.75 | 2400 | Click on selection |
| Brick | 1.7 | 0.0008 | 0.8 | 2600 | |
| Glass, Plate | 1.6 | 0.00076 | 0.8 | 2710 | |
| Brick/Concrete Block | 1.2 | 0.00073 | 0.84 | 1900 | |
| Gypsum Board | 0.18 | 0.00017 | 1.1 | 960 | |
| Plywood | 0.16 | 0.00012 | 2.5 | 540 | |
| Fiber Insulation Board | 0.16 | 0.00053 | 1.25 | 240 | |
| Chipboard | 0.15 | 0.00015 | 1.25 | 800 | |
| Aerated Concrete | 0.12 | 0.00026 | 0.96 | 500 | |
| Plasterboard | 0.12 | 0.00016 | 0.84 | 950 | |
| Calcium Silicate Board | 0.098 | 0.00013 | 1.12 | 700 | |
| Alumina Silicate Block | 0.036 | 0.00014 | 1 | 260 | |
| Glass Fiber Insulation | 0.0018 | 0.000037 | 0.8 | 60 | |
| Expanded Polystyrene | 0.001 | 0.000034 | 1.5 | 20 | |

Reference: Klote, J., J. Milke, *Principles of Smoke Management*, 2002, Page 270.

FIRE SPECIFICATIONS

| | | |
|--------------------------------|------------|---------|
| Fire Heat Release Rate (Q) | 1500.00 kW | |
| Time after ignition (t) | 5.00 min. | 300 sec |

METHOD OF McCAFFREY, QUINTIERE, AND HARKLEROD (MQH)

Reference: SFPE Handbook of Fire Protection Engineering, 2nd Edition, 1995, Page 3-139.

$$\Delta T_g = 6.85[Q^2/(A_v(h_v)^{1/2})(A_T h_k)]^{1/3}$$

Where $\Delta T_g = T_g - T_a$ = upper layer gas temperature rise above ambient (K)
 Q = heat release rate of the fire (kW)
 A_v = area of ventilation opening (m²)
 h_v = height of ventilation opening (m)
 h_k = convective heat transfer coefficient (kW/m²-K)
 A_T = total area of the compartment enclosing surface boundaries excluding area of vent openings (m²)

Area of Ventilation Opening Calculation

$$A_v = (w_v)(h_v)$$
$$A_v = 1.95 \quad \text{m}^2$$

Thermal Penetration Time Calculation

Thermally Thin Material

$$t_p = (c_p/k)(\delta)^2$$

Where ρ = interior construction density (kg/m³)
 c_p = interior construction heat capacity (kJ/kg-K)
 k = interior construction thermal conductivity (kW/m-K)
 δ = interior construction thickness (m)

$$t_p = 1001.90 \quad \text{sec}$$

Heat Transfer Coefficient Calculation

$$h_k = k / \delta \quad \text{for } t > t_p$$

Where k = interior construction thermal conductivity (kW/m-K)
 δ = interior construction thickness (m)

$$h_k = 0.00669 \quad \text{kW/m}^2\text{-K}$$

Area of Compartment Enclosing Surface Boundaries

$$A_T = [2(w_c \times l_c) + 2(h_c \times w_c) + 2(h_c \times l_c)] - A_v$$

$$A_T = 299.05 \quad \text{m}^2$$

Compartment Hot Gas Layer Temperature With Natural Ventilation

$$\Delta T_g = 6.85[Q^2/(A_v(h_v)^{1/2})(A_T h_k)]^{1/3}$$

$$\Delta T_g = 502.37 \quad \text{K}$$

$$\Delta T_g = T_g - T_v$$

$$T_g = \Delta T_g + T_v$$

$$T_g = 800.37 \quad \text{K}$$

$$T_g = 527.37 \quad ^\circ\text{C} \quad 981.27 \quad ^\circ\text{F} \quad \text{ANSWER}$$

ESTIMATING SMOKE LAYER HEIGHT METHOD OF YAMANA AND TANAKA

$$z = ((2kQ^{1/3}/3A_c) + (1/h_c^{2/3})^{-3/2}$$

Where z = smoke layer height (m)
 Q = heat release rate of the fire (kW)
 t = time after ignition (sec)
 h_c = compartment height (m)
 A_c = compartment floor area (m²)
 k = a constant given by $k = 0.076/\rho_g$
 ρ_g = hot gas layer density (kg/m³)
 ρ_g is given by $\rho_g = 353/T_g$
 T_g = hot gas layer temperature (K)

Compartment Area Calculation

$$A_c = (w_c)(l_c)$$

$$A_c = 83.61 \text{ m}^2$$

Hot Gas Layer Density Calculation

$$\rho_g = 353/T_g$$

$$\rho_g = 0.44 \text{ kg/m}^3$$

Calculation for Constant K

$$k = 0.076/\rho_g$$

$$k = 0.17$$

Smoke Gas Layer Height With Natural Ventilation

$$z = ((2kQ^{1/3}/3A_c) + (1/h_c^{2/3})^{-3/2} \quad \text{STOP - IF } Z = VT, \text{ SMOKE EXITING VENT}$$

| | | | |
|-------|--------|---------|---------------|
| $z =$ | 0.09 m | 0.28 ft | ANSWER |
|-------|--------|---------|---------------|

If # REFI is given as the smoke layer height then the smoke has completely filled the room

NOTE

The above calculations are based on principles developed in the SFPE Handbook of Fire Protection Engineering, 2nd Edition, 1995. Calculations are based on certain assumptions and have inherent limitations. The results of such calculations may or may not have reasonable predictive capabilities for a given situation, and should only be interpreted by an informed user. Although each calculation in the spreadsheet has been verified with the results of hand calculation, there is no absolute guarantee of the accuracy of these calculations. Any questions, comments, concerns, and suggestions, or to report an error(s) in the spreadsheet, please send an email to nxi@nrc.gov.



This page intentionally left blank.

Problem J-2

Problem Statement

Consider a compartment 12.0 m wide x 12.0 m long x 3.7 m high (40.0 ft wide x 40.0 ft long x 12.0 ft high) ($w_c \times l_c \times h_c$) with a forced ventilation rate of 3.78 m³/s (8,000 cfm). Calculate the hot gas layer temperature in the compartment for a fire size (\dot{Q}) of 2,000 kW (1,896 Btu/sec) at 5 minutes after ignition, assuming that the compartment boundaries are made of 5.10 cm (2.0 in) thick gypsum board.

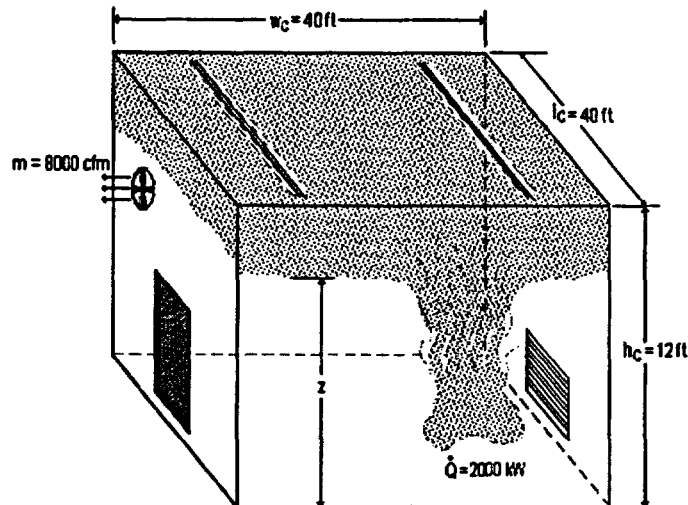

Problem 2: Compartment Fire with Forced Ventilation

Solution

Purpose:

- (1) Determine the hot gas temperature in the compartment (T_g) at $t = 5$ min after ignition.

Assumptions:

- (1) Air properties (ambient) are at 25 °C (77 °F).
- (2) The ceiling is unconfined, unobstructed, and flat.
- (3) The heat flow through the compartment boundaries is one-dimensional.
- (4) The heat release rate (HRR) is constant.
- (5) The fire is located at the center of the compartment or away from the walls.
- (6) The compartment is open to the outside at the inlet (pressure = 1 atm).

Spreadsheet (FDT[®]) Solution Procedure:

Use the following FDT[®]:

- (a) Temperature_FV1.xls (select *Temperature-FV Thermally Thick*)
- (b) Temperature_FV2.xls (select *Temperature-FV Thermally Thick*)

Note: Since the interior boundary material thickness is greater than 2.54 cm (1 in), use the spreadsheet for thermally thick material. Also each spreadsheet has a different method to calculate the hot gas layer temperature (T_g). Both methods will be used to compare results.

FDT* Input Parameters:

Enter the following parameters in both spreadsheets (values only):

- Compartment Width (w_c) = 40 ft
- Compartment Length (l_c) = 40 ft
- Compartment Height (h_c) = 12 ft
- Interior Lining Thickness (δ) = 2 in
- Select Material: select **Gypsum Board** from the combo box
- Compartment Ventilation Rate (\dot{m}) = 8,000 cfm
- Fire Heat Release Rate (\dot{Q}) = 2,000 kW

Note: When Gypsum Board is selected, its thermal properties are automatically selected from the table and entered in the corresponding input cells.

Results

From the table of results of the spreadsheet at $t = 5$ minutes after ignition we obtain:

| Hot Gas Layer Temperature* T_g °C (°F) | |
|---|-------------------------|
| Method of Foot, Pagani, and Alvares (FPA) | Method of Deal & Beyler |
| 202 (396) | 243 (467) |

*spreadsheet calculations attached on next page

Spreadsheet Calculations
Method of Foote, Pagni, and Alvares (FPA)

**CHAPTER 2 - PREDICTING HOT GAS LAYER TEMPERATURE
IN ROOM FIRE WITH FORCED VENTILATION
COMPARTMENT WITH THERMALLY THICK BOUNDARIES**

The following calculations estimate the hot gas layer temperature and smoke layer height in enclosure fire. Parameters should be specified **ONLY IN THE YELLOW INPUT PARAMETER BOXES**. All subsequent output values are calculated by the spreadsheet and based on values specified in the input parameters. This spreadsheet is protected and secure to avoid errors due to a wrong entry in a cell(s). The chapter in the NUREG should be read before an analysis is made.

INPUT PARAMETERS

COMPARTMENT INFORMATION

| | | |
|-------------------------------|----------|----------|
| Compartment Width (w_c) | 40.00 ft | 12.19 m |
| Compartment Length (l_c) | 40.00 ft | 12.19 m |
| Compartment Height (h_c) | 12.00 ft | 3.66 m |
| Interior Lining Thickness () | 2.00 in | 0.0508 m |

For thermally thick case the interior lining thickness should be greater than 1 inch.

AMBIENT CONDITIONS

| | | |
|-----------------------------------|------------------------|----------|
| Ambient Air Temperature (T_a) | 77.00 °F | 25.00 °C |
| Specific Heat of Air (c_p) | 1.00 kJ/kg-K | 298.00 K |
| Ambient Air Density (ρ_a) | 1.20 kg/m ³ | |

THERMAL PROPERTIES OF COMPARTMENT ENCLOSING SURFACES

| | |
|--|---|
| Interior Lining Thermal Inertia ($k c$) | 0.18 (kW/m ² -K) ² -sec |
| Interior Lining Thermal Conductivity (k) | 0.00017 kW/m-K |
| Interior Lining Specific Heat (c) | 1.1 kJ/kg-K |
| Interior Lining Density () | 960 kg/m ³ |

THERMAL PROPERTIES FOR COMMON INTERIOR LINING MATERIALS

| Material | $k c$ (kW/m ² -K) ² -sec | k (kW/m-K) | c (kJ/kg-K) | (kg/m ³) | Select Material |
|------------------------|---|-----------------|------------------|----------------------|--|
| Aluminum (pure) | 500 | 0.206 | 0.895 | 2710 | <input type="text" value="Gypsum Board"/> |
| Steel (0.5% Carbon) | 197 | 0.054 | 0.465 | 7850 | Scroll to desired material Click on selection |
| Concrete | 2.9 | 0.0016 | 0.75 | 2400 | |
| Brick | 1.7 | 0.0008 | 0.8 | 2600 | |
| Glass, Plate | 1.6 | 0.00076 | 0.8 | 2710 | |
| Brick/Concrete Block | 1.2 | 0.00073 | 0.84 | 1900 | |
| Gypsum Board | 0.18 | 0.00017 | 1.1 | 960 | |
| Plywood | 0.16 | 0.00012 | 2.5 | 540 | |
| Fiber Insulation Board | 0.16 | 0.00053 | 1.25 | 240 | |
| Chipboard | 0.15 | 0.00015 | 1.25 | 800 | |
| Aerated Concrete | 0.12 | 0.00026 | 0.96 | 500 | |
| Plasterboard | 0.12 | 0.00016 | 0.84 | 950 | |
| Calcium Silicate Board | 0.098 | 0.00013 | 1.12 | 700 | |
| Alumina Silicate Block | 0.036 | 0.00014 | 1 | 260 | |
| Glass Fiber Insulation | 0.0018 | 0.000037 | 0.8 | 60 | |
| Expanded Polystyrene | 0.001 | 0.000034 | 1.5 | 20 | |

Reference: Klote, J., J. Milke, *Principles of Smoke Management*, 2002 Page 270.

COMPARTMENT MASS VENTILATION FLOW RATE

Forced Ventilation Flow Rate (m)

8000.00 cfm

3.776 m³/sec

4.531 kg/sec

FIRE SPECIFICATIONS

Fire Heat Release Rate (Q)

2000.00 kW

METHOD OF FOOTE, PAGNI, AND ALVARES (FPA)Reference: SFPE Handbook of Fire Protection Engineering, 2nd Edition, 1995, Page 3-140.

$$\Delta T_g/T_a = 0.63(Q/mc_p T_a)^{0.72} (h_k A_T/mc_p)^{-0.36}$$

Where $\Delta T_g = T_g - T_a$ = upper layer gas temperature rise above ambient (K)
 T_a = ambient air temperature (K)
 Q = heat release rate of the fire (kW)
 m = compartment mass ventilation flow rate (kg/sec)
 c_p = specific heat of air (kJ/kg-K)
 h_k = convective heat transfer coefficient (kW/m²-K)
 A_T = total area of the compartment enclosing surface boundaries (m²)

Thermal Penetration Time Calculation**Thermally Thick Material**

$$t_p = (c_p/k)(\delta)^2$$

Where ρ = interior construction density (kg/m³)
 c_p = interior construction heat capacity (kJ/kg-K)
 k = interior construction thermal conductivity (kW/m-K)
 δ = interior construction thickness (m)

$$t_p = 4007.58 \text{ sec}$$

Heat Transfer Coefficient Calculation

$$h_k = v(k c/t) \text{ for } t < t_p$$

Where $k c$ = interior construction thermal inertia (kW/m²-K)²-sec
(a thermal property of material responsible for the rate of temperature rise)
 t = time after ignition (sec)

Area of Compartment Enclosing Surface Boundaries

$$A_T = 2(w_c \times l_c) + 2(h_c \times w_c) + 2(h_c \times l_c)$$

$$A_T = 475.66 \text{ m}^2$$

Compartment Hot Gas Layer Temperature With Forced Ventilation

$$\Delta T_g/T_a = 0.63(Q/mc_p T_a)^{0.72} (h_k A_T/mc_p)^{-0.36}$$

$$\Delta T_g = T_g - T_a$$

$$T_g = T_g + T_a$$

RESULTS

| Time after Ignition (t) | | h_k (kW/m ² -K) | T_g/T_a | T_g (K) | T_g (K) | T_g (°C) | T_g (°F) |
|-------------------------|------|---------------------------------|-----------|--------------|--------------|---------------|---------------|
| (min) | (s) | | | | | | |
| 0 | 0 | - | - | - | 298.00 | 25.00 | 77.00 |
| 1 | 60 | 0.05 | 0.45 | 132.72 | 430.72 | 157.72 | 315.89 |
| 2 | 120 | 0.04 | 0.50 | 150.36 | 448.36 | 175.36 | 347.64 |
| 3 | 180 | 0.03 | 0.54 | 161.74 | 459.74 | 186.74 | 368.13 |
| 4 | 240 | 0.03 | 0.57 | 170.34 | 468.34 | 195.34 | 383.60 |
| 5 | 300 | 0.02 | 0.60 | 177.32 | 475.32 | 202.32 | 395.17 |
| 10 | 600 | 0.02 | 0.67 | 200.88 | 498.88 | 225.88 | 438.58 |
| 15 | 900 | 0.01 | 0.73 | 216.09 | 514.09 | 241.09 | 465.96 |
| 20 | 1200 | 0.01 | 0.76 | 227.57 | 525.57 | 252.57 | 486.63 |

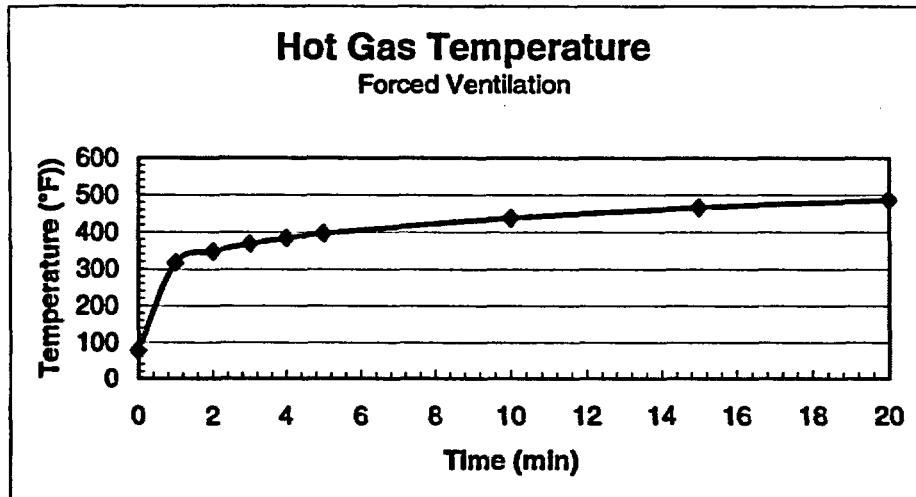

NOTE

The above calculations are based on principles developed in the SFPE Handbook of Fire Protection Engineering, 2nd Edition, 1995.

Calculations are based on certain assumptions and have inherent limitations. The results of such calculations may or may not have reasonable predictive capabilities for a given situation, and should only be interpreted by an informed user.

Although each calculation in the spreadsheet has been verified with the results of hand calculation, there is no absolute guarantee of the accuracy of these calculations.

Any questions, comments, concerns, and suggestions, or to report an error(s) in the spreadsheet, please send an email to nxi@nrc.gov.



**CHAPTER 2 - PREDICTING HOT GAS LAYER TEMPERATURE
IN ROOM FIRE WITH FORCED VENTILATION
COMPARTMENT WITH THERMALLY THICK BOUNDARIES**

The following calculations estimate the hot gas layer temperature in enclosure fires. Parameters should be specified ONLY IN THE YELLOW INPUT PARAMETER BOXES. All subsequent output values are calculated by the spreadsheet and based on values specified in the input parameters. This spreadsheet is protected and secure to avoid errors due to a wrong entry in a cell(s). The chapter in the NUREG should be read before an analysis is made.

INPUT PARAMETERS

| COMPARTMENT INFORMATION | | | |
|---|---|--|----------------------|
| Compartment Width (w_c) | 40.00 ft | | 12.19 m |
| Compartment Length (l_c) | 40.00 ft | | 12.19 m |
| Compartment Height (h_c) | 12.00 ft | | 3.66 m |
| Interior Lining Thickness () | 2.00 in | | 0.0508 m |
| For thermally thick case the interior lining thickness should be greater than 1 inch. | | | |
| AMBIENT CONDITIONS | | | |
| Ambient Air Temperature (T_a) | 77.00 °F | | 25.00 °C 298.00 K |
| Specific Heat of Air (c_p) | 1.00 kJ/kg-K | | |
| Ambient Air Density (ρ_a) | 1.20 kg/m ³ | | |
| THERMAL PROPERTIES OF COMPARTMENT ENCLOSING SURFACES | | | |
| Interior Lining Thermal Inertia ($k c$) | 0.18 (kW/m ² -K) ² -sec | | |
| Interior Lining Thermal Conductivity (k) | 0.00017 kW/m-K | | |
| Interior Lining Specific Heat (c) | 1.1 kJ/kg-K | | |
| Interior Lining Density () | 960 kg/m ³ | | |

THERMAL PROPERTIES FOR COMMON INTERIOR LINING MATERIALS

| Material | $k c$ (kW/m ² -K) ² -sec | k (kW/m-K) | c (kJ/kg-K) | (kg/m ³) | Select Material |
|------------------------|---|-----------------|------------------|----------------------|---|
| Aluminum (pure) | 500 | 0.206 | 0.895 | 2710 | Gypsum Board |
| Steel (0.5% Carbon) | 197 | 0.054 | 0.465 | 7850 | Scroll to desired material then Click on selection |
| Concrete | 2.9 | 0.0018 | 0.75 | 2400 | |
| Brick | 1.7 | 0.0008 | 0.8 | 2600 | |
| Glass, Plate | 1.8 | 0.00076 | 0.8 | 2710 | |
| Brick/Concrete Block | 1.2 | 0.00073 | 0.84 | 1900 | |
| Gypsum Board | 0.18 | 0.00017 | 1.1 | 960 | |
| Plywood | 0.18 | 0.00012 | 2.5 | 540 | |
| Fiber Insulation Board | 0.18 | 0.00053 | 1.25 | 240 | |
| Chipboard | 0.15 | 0.00015 | 1.25 | 800 | |
| Aerated Concrete | 0.12 | 0.00026 | 0.96 | 500 | |
| Plasterboard | 0.12 | 0.00016 | 0.84 | 950 | |
| Calcium Silicate Board | 0.098 | 0.00013 | 1.12 | 700 | |
| Alumina Silicate Block | 0.036 | 0.00014 | 1 | 260 | |
| Glass Fiber Insulation | 0.0018 | 0.000037 | 0.8 | 60 | |
| Expanded Polystyrene | 0.001 | 0.000034 | 1.5 | 20 | |

Reference: Kote, J., J. Milke, *Principles of Smoke Management*, 2002, Page 270.

COMPARTMENT MASS VENTILATION FLOW RATE

Forced Ventilation Flow Rate (m)

8000.00 cfm

3.776 m³/sec

4.531 kg/sec

FIRE SPECIFICATIONS

Fire Heat Release Rate (Q)

2000.00 kW

METHOD OF DEAL AND BEYLERReference: SFPE Handbook of Fire Protection Engineering, 3rd Edition, 2002, Page 3-178.**Heat Transfer Coefficient Calculation**

$$h_k = 0.4 v (kpc / t) \text{ for } t < t_p$$

Where kpc = interior construction thermal inertia (kW/m²-K)²-sec
 (a thermal property of material responsible for the rate of temperature rise)
 δ = thickness of interior lining (m)

$$h_k = 0.022 \text{ kW/m}^2\text{-K}$$

Area of Compartment Enclosing Surface Boundaries

$$A_T = 2(w_c \times l_c) + 2(h_c \times w_c) + 2(h_c \times l_c)$$

$$A_T = 475.66 \text{ m}^2$$

Compartment Hot Gas Layer Temperature With Forced Ventilation

$$\Delta T_g = Q / (m c_p + h_k A_T)$$

Where $\Delta T_g = T_g - T_a$ = upper layer gas temperature rise above ambient (K)
 T_a = ambient air temperature (K)
 Q = heat release rate of the fire (kW)
 m = compartment mass ventilation flow rate (kg/sec)
 c_p = specific heat of air (kJ/Kg-K)
 h_k = convective heat transfer coefficient (kW/m²-K)
 A_T = total area of the compartment enclosing surface boundaries (m²)

Results:

| Time after ignition (t) | | h_k (kW/m ² -K) | ΔT_g (K) | T_g (K) | T_g (°C) | T_g (°F) |
|-------------------------|------|---------------------------------|---------------------|--------------|---------------|---------------|
| (min) | (s) | | | | | |
| 0 | 0 | - | - | 298.00 | 25.00 | 77.00 |
| 1 | 60 | 0.02 | 133.76 | 431.76 | 158.76 | 317.77 |
| 2 | 120 | 0.02 | 168.07 | 466.07 | 193.07 | 379.53 |
| 3 | 180 | 0.01 | 189.62 | 487.62 | 214.62 | 418.32 |
| 4 | 240 | 0.01 | 205.31 | 503.31 | 230.31 | 446.56 |
| 5 | 300 | 0.01 | 217.60 | 515.60 | 242.60 | 468.68 |
| 10 | 600 | 0.01 | 255.55 | 553.55 | 280.55 | 536.99 |
| 15 | 900 | 0.01 | 276.95 | 574.95 | 301.95 | 575.51 |
| 20 | 1200 | 0.00 | 291.50 | 589.50 | 316.50 | 601.71 |

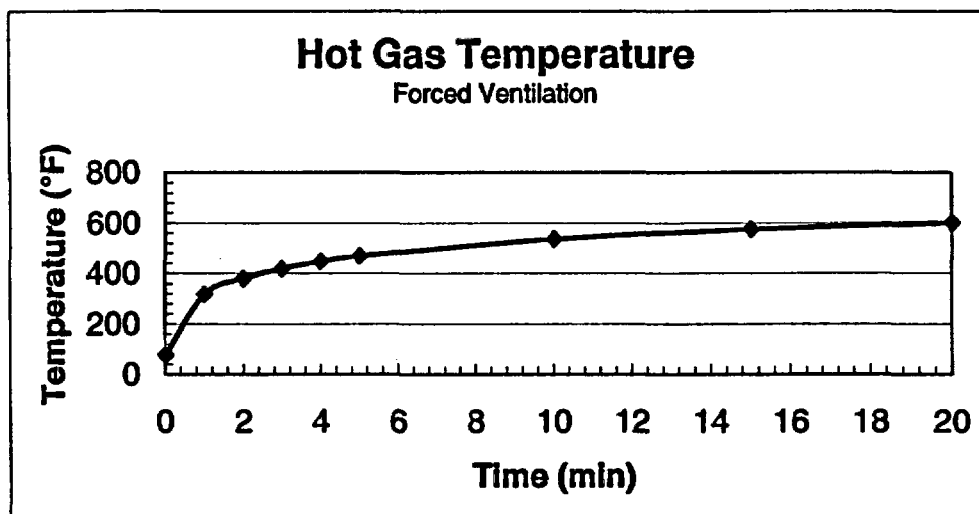

NOTE

The above calculations are based on principles developed in the SFPE Handbook of Fire Protection Engineering, 3rd Edition, 2002.

Calculations are based on certain assumptions and have inherent limitations. The results of such calculations may or may not have reasonable predictive capabilities for a given situation, and should only be interpreted by an informed user.

Although each calculation in the spreadsheet has been verified with the results of hand calculation, there is no absolute guarantee of the accuracy of these calculations.

Any questions, comments, concerns, and suggestions, or to report an error(s) in the spreadsheet, please send an email to nxi@nrc.gov.



Problem J-3

Problem Statement

Consider a compartment 4.6 m wide x 5.5 m long x 3.0 m high (15 ft wide x 18 ft long x 10 ft high) with multiple vents and 15.24 cm (6 in) of gypsum board as interior boundary material. The compartment has two vents of 0.6 m wide x 0.6 m high (2 ft wide x 2 ft high) and one vent of 1.2 m wide x 2.1 m high (4 ft wide x 7 ft high), all located on the same wall. The top of the highest vent is at 2.4 m (8 ft) above the floor. If the ventilation system is not operating (natural ventilation) and at 10 minutes after a fire ignition the hot gas layer temperature reaches the failure temperature of the IEEE-383 unqualified cable (i.e. $T_g = 218\text{ }^\circ\text{C}$) ($T_g = 425\text{ }^\circ\text{F}$); what minimum HRR might cause this failure? Is the smoke exiting the compartment at the time of cable failure?

Consider the same compartment with a mechanical ventilation rate of $0.236\text{ m}^3/\text{s}$ (500 cfm) and a fire with an intensity equals to the HRR of the natural ventilation scenario. What would be the hot gas layer temperature around the cable trays at 10 minutes after ignition? (Use method of FPA and method of Deal & Beyler). What is the effect of the ventilation system on the hot gas layer temperature? Compare the results of the forced ventilation scenario as a function of time after ignition and explain the discrepancy between methods.

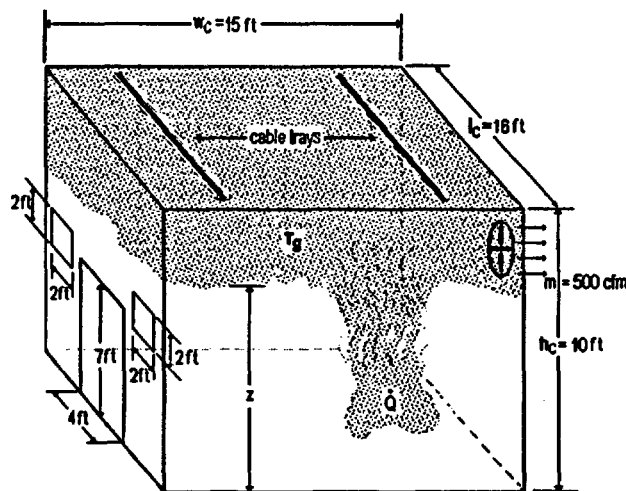

Problem 3: Compartment Fire with Multiple Vents

Solution

Purpose:

- (1) Determine the minimum HRR that could cause the IEEE-383 unqualified cable failure at 10 min after ignition in a natural ventilation scenario.
- (2) Determine if the smoke is exiting the compartment at 10 min after ignition.
- (3) Determine the hot gas layer temperature (T_g) at 10 min after ignition if the mechanical ventilation system is activated and the HRR is equal to the HRR of the natural ventilation scenario (i.e. use the answer of purpose 1).
- (4) Evaluate the effect of the ventilation system in the hot gas layer temperature (i.e. increase, decrease, etc).
- (5) Analyze the discrepancy between method of FPA and method of Deal & Beyler and mention possible causes of that discrepancy.

Assumptions:

- (1) Air properties (ambient) are at 25 °C (77 °F).
- (2) The ceiling is unconfined, unobstructed and flat.
- (3) The heat flow through the compartment boundaries is one-dimensional.
- (4) The HRR is constant.
- (5) The fire is located at the center of the compartment or away from the walls.
- (6) The compartment is open to the outside at the inlet (pressure = 1 atm).

Pre FDT[®] Calculations:

Equivalent Vent

Since the FDT[®] are designed to calculate the hot gas layer temperature and smoke layer height based in only one vent compartment, we need to calculate an equivalent vent that represents the three vent openings.

| Vent Opening Characteristics | | | |
|------------------------------|----------------------|----------------------------------|---|
| Width w_v (ft) | Height h_v (ft) | Area A_o (ft ²) | MQH Factor $A_o \sqrt{h_v}$ (ft ^{5/2}) |
| 2 | 2 | 4 | 5.66 |
| 2 | 2 | 4 | 5.66 |
| 4 | 7 | 28 | 74.08 |
| Total | | 36 | 84.4 |



The equivalent vent dimensions must satisfy the following conditions in order to have the same effect of the actual multiple vents:

$$\text{Condition 1: } A_o \sqrt{h_v} = 85.4 \text{ ft}^{5/2}$$

$$36 \text{ ft}^2 \sqrt{h_v} = 85.4 \text{ ft}^{5/2}$$

$$h_v = 5.63 \text{ ft} = 5.6 \text{ ft}$$

$$\text{Condition 2: } w_v \times h_v = 36 \text{ ft}^2$$

$$w_v \times 5.63 \text{ ft} = 36 \text{ ft}^2$$

$$w_v = 6.39 \text{ ft} = 6.4 \text{ ft}$$

Spreadsheet (FDT[®]) Solution Procedure:

Natural Ventilation Scenario

Use the following FDT[®]:

(a) *Temperature_NV.xls* (select *Temperature_NV Thermally Thick*)

Note: Since the interior boundary material is greater than 2.54 cm (1 in), use the spreadsheet for thermally thick material.

FDT* Input Parameters:

Enter the following parameters in the spreadsheet (values only):

- Compartment Width (w_c) = 15 ft
- Compartment Length (l_c) = 16 ft
- Compartment Height (h_c) = 10 ft
- Vent Width (w_v) = 6.4 ft
- Vent Height (h_v) = 5.6 ft
- Top of Vent from Floor (V_T) = 8 ft
- Interior Lining Thickness (δ) = 6 in
- Select Material: select **Gypsum Board** from the combo box
- Fire Heat Release Rate (\dot{Q}) = 100 kW*

Note: When **Gypsum Board** is selected, its thermal properties are automatically selected from the table and entered in the corresponding input cells.

*The HRR value is a starting value for the trial and error procedure explained below.

Because we are looking for a HRR value that could generate a hot gas layer temperature of 218 °C (425 °F), we need to enter HRR values on the spreadsheet until get a temperature close to 218 °C (425 °F) at 10 min after ignition. This trial and error procedure is shown in the following table.

| Trial and error procedure to determine the HRR Target: $T_g = 425$ °F for natural ventilation scenario | | |
|---|---|--|
| Trial | Heat Release Rate (\dot{Q}) (kW) | Hot Gas Layer Temperature (T_g) at 10 min after Ignition (°F) |
| 1 | 100 | 213 |
| 2 | 200 | 293 |
| 3 | 300 | 360 |
| 4 | 400 | 420 |
| 5* | 410 | 425 |

*spreadsheet calculations attached on next page for last trial at $t = 10$ min

Results

According with the method of McCaffrey, Quintiere, and Harkleroad (MQH), a HRR of approximate **410 kW** could generate a hot gas layer temperature of 213 °C (425 °F) at 10 minutes after ignition. But, what is important for practical purposes is that for the given compartment and ventilation conditions, a fire power of about **400 kW (379 Btu/sec)** may generate a hot gas layer temperature of **204+°C (400+°F)**. Also, the smoke layer height at 10 minutes after ignition is approximately $z = 0.38$ m (1.27 ft), based on the method of Yamana and Tanaka. That means that the smoke could be exiting the compartment because z is less than the height of the vent top (V_T).

Spreadsheet Calculations

CHAPTER 2 - PREDICTING HOT GAS LAYER TEMPERATURE AND SMOKE LAYER HEIGHT IN ROOM FIRE WITH NATURAL VENTILATION COMPARTMENT WITH THERMALLY THICK BOUNDARIES

The following calculations estimate the hot gas layer temperature and smoke layer height in enclosure fire. Parameters should be specified ONLY IN THE YELLOW INPUT PARAMETER BOXES. All subsequent output values are calculated by the spreadsheet and based on values specified in the input parameters. This spreadsheet is protected and secure to avoid errors due to a wrong entry in a cell(s). The chapter in the NUREG should be read before an analysis is made.

INPUT PARAMETERS

COMPARTMENT INFORMATION

| | | |
|----------------------------------|----------|----------|
| Compartment Width (w_c) | 15.00 ft | 4.572 m |
| Compartment Length (l_c) | 16.00 ft | 4.8768 m |
| Compartment Height (h_c) | 10.00 ft | 3.048 m |
| Vent Width (w_v) | 6.40 ft | 1.951 m |
| Vent Height (h_v) | 5.60 ft | 1.707 m |
| Top of Vent from Floor (V_T) | 8.00 ft | 2.438 m |
| Interior Lining Thickness () | 6.00 in | 0.1524 m |

For thermally thick case the interior lining thickness should be greater than 1 inch.

AMBIENT CONDITIONS

| | | |
|-----------------------------------|------------------------|----------|
| Ambient Air Temperature (T_a) | 77.00 °F | 25.00 °C |
| Specific Heat of Air (c_p) | 1.00 kJ/kg-K | 298.00 K |
| Ambient Air Density (ρ_a) | 1.20 kg/m ³ | |

THERMAL PROPERTIES OF COMPARTMENT ENCLOSING SURFACES FOR

| | |
|--|---|
| Interior Lining Thermal Inertia ($k c$) | 0.18 (kW/m ² -K) ² -sec |
| Interior Lining Thermal Conductivity (k) | 0.00017 kW/m-K |
| Interior Lining Specific Heat (c) | 1.1 kJ/kg-K |
| Interior Lining Density () | 960 kg/m ³ |

EXPERIMENTAL THERMAL PROPERTIES FOR COMMON INTERIOR LINING MATERIALS

| Material | $k c$ (kW/m ² -K) ² -sec | k (kW/m-K) | c (kJ/kg-K) | (kg/m ³) | Select Material |
|------------------------|---|-----------------|------------------|----------------------|-----------------|
| Aluminum (pure) | 500 | 0.208 | 0.895 | 2710 | Gypsum Board |
| Steel (0.5% Carbon) | 197 | 0.054 | 0.465 | 7850 | |
| Concrete | 2.9 | 0.0016 | 0.75 | 2400 | |
| Brick | 1.7 | 0.0008 | 0.8 | 2600 | |
| Glass, Plate | 1.6 | 0.00076 | 0.8 | 2710 | |
| Brick/Concrete Block | 1.2 | 0.00073 | 0.84 | 1900 | |
| Gypsum Board | 0.18 | 0.00017 | 1.1 | 960 | |
| Plywood | 0.16 | 0.00012 | 2.5 | 540 | |
| Fiber Insulation Board | 0.16 | 0.00053 | 1.25 | 240 | |
| Chipboard | 0.15 | 0.00015 | 1.25 | 800 | |
| Aerated Concrete | 0.12 | 0.00026 | 0.96 | 500 | |
| Plasterboard | 0.12 | 0.00016 | 0.84 | 950 | |
| Calcium Silicate Board | 0.098 | 0.00013 | 1.12 | 700 | |
| Alumina Silicate Block | 0.036 | 0.00014 | 1 | 260 | |
| Glass Fiber Insulation | 0.0018 | 0.000037 | 0.8 | 60 | |
| Expanded Polystyrene | 0.001 | 0.000034 | 1.5 | 20 | |

Reference: Klotz, J., J. Milke, Principles of Smoke Management, 2002, Page 270.

FIRE SPECIFICATIONS

Fire Heat Release Rate (Q)

410.00 kW

METHOD OF McCAFFREY, QUINTIERE, AND HARKLEROD (MQH)

Reference: SFPE Handbook of Fire Protection Engineering, 2nd Edition, Page 3-139.

$$\Delta T_g = 6.85[Q^2/(A_v(h_v)^{1/2})(A_T h_k)]^{1/3}$$

- Where $\Delta T_g = T_g - T_a$ = upper layer gas temperature rise above ambient (K)
 Q = heat release rate of the fire (kW)
 A_v = area of ventilation opening (m²)
 h_v = height of ventilation opening (m)
 h_k = convective heat transfer coefficient (kW/m²-K)
 A_T = total area of the compartment enclosing surface boundaries excluding area of vent openings (m²)

Area of Ventilation Opening Calculation

$$A_v = (w_v)(h_v)$$

$$A_v = 3.33 \text{ m}^2$$

Thermal Penetration Time Calculation

Thermally Thick Material

$$t_p = (\rho c_p k)(\delta/2)^2$$

Where ρ = interior construction density (kg/m³)
 c_p = interior construction heat capacity (kJ/kg-K)
 k = interior construction thermal conductivity (kW/m-K)
 δ = interior construction thickness (m)

$$t_p = 36068.239 \text{ sec}$$

Heat Transfer Coefficient Calculation

$$h_k = v(kpc/t) \quad \text{for } t < t_p$$

Where kpc = interior construction thermal inertia (kW/m²-K)²-sec
 (a thermal property of material responsible for the rate of temperature rise)
 t = time after ignition (sec)

Area of Compartment Enclosing Surface Boundaries

$$A_T = [2(w_c \times l_c) + 2(h_c \times w_c) + 2(h_c \times l_c)] - A_v$$

$$A_T = 98.86 \text{ m}^2$$

Compartment Hot Gas Layer Temperature With Natural Ventilation

$$\Delta T_g = 6.85[Q^2/(A_v(h_v)^{1/2})(A_T h_k)]^{1/3}$$

$$\Delta T_g = T_g - T_a$$

$$T_g = \Delta T_g + T_a$$

RESULTS

| Time after Ignition (t) | | h_k (kW/m ² -K) | ΔT_g (K) | T_g (K) | T_g (°C) | T_g (°F) |
|-------------------------|------|---------------------------------|---------------------|--------------|---------------|---------------|
| (min) | (s) | | | | | |
| 0 | 0.00 | - | - | 298.00 | 25.00 | 77.00 |
| 1 | 60 | 0.05 | 131.88 | 429.88 | 156.88 | 314.39 |
| 2 | 120 | 0.04 | 148.03 | 446.03 | 173.03 | 343.46 |
| 3 | 180 | 0.03 | 158.38 | 456.38 | 183.38 | 362.08 |
| 4 | 240 | 0.03 | 166.16 | 464.16 | 191.16 | 376.09 |
| 5 | 300 | 0.02 | 172.46 | 470.46 | 197.46 | 387.42 |
| 10 | 600 | 0.02 | 193.57 | 491.57 | 218.57 | 425.43 |
| 15 | 900 | 0.01 | 207.11 | 505.11 | 232.11 | 449.79 |
| 20 | 1200 | 0.01 | 217.28 | 515.28 | 242.28 | 468.10 |

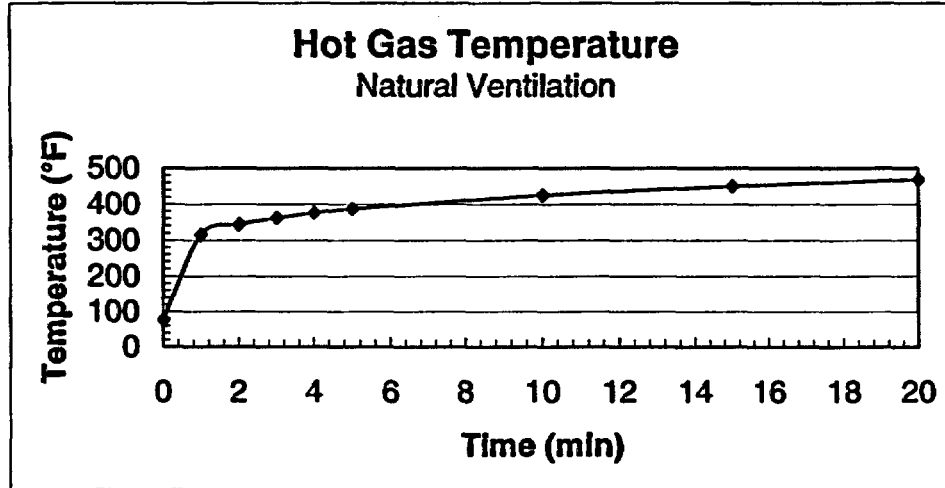

ESTIMATING SMOKE LAYER HEIGHT METHOD OF YAMANA AND TANAKA

$$z = ((2kQ^{1/3}/3A_c) + (1/h_c^{2/3})^{-3/2}$$

Where

- z = smoke layer height (m)
- Q = heat release rate of the fire (kW)
- t = time after ignition (sec)
- h_c = compartment height (m)
- A_c = compartment floor area (m²)
- k = a constant given by k = 0.076/ρ_g
- ρ_g = hot gas layer density (kg/m³)
- ρ_g is given by ρ_g = 353/T_g
- T_g = hot gas layer temperature (K)

Compartment Area Calculation

$$A_c = (w_c)(l_c)$$

$$A_c = 22.30 \text{ m}^2$$

Hot Gas Layer Density Calculation

$$\rho_g = 353/T_g$$

Calculation for Constant K

$$k = 0.076/\rho_g$$

Smoke Gas Layer Height With Natural Ventilation

$$z = ((2kQ^{1/3}/3A_c) + (1/h_c^{2/3})^{-3/2}$$

RESULTS

| Time (min) | ρ_g kg/m ³ | k (kW/m-K) | z (m) | z (ft) |
|---------------|-------------------------------|---------------|----------|-----------|
| 0 | 1.20 | 0.063 | 3.05 | 10.00 |
| 1 | 0.82 | 0.093 | 0.45 | 1.47 |
| 2 | 0.79 | 0.096 | 0.43 | 1.41 |
| 3 | 0.77 | 0.098 | 0.42 | 1.38 |
| 4 | 0.76 | 0.100 | 0.41 | 1.35 |
| 5 | 0.75 | 0.101 | 0.41 | 1.33 |
| 10 | 0.72 | 0.106 | 0.39 | 1.27 |
| 15 | 0.70 | 0.109 | 0.37 | 1.23 |
| 20 | 0.69 | 0.111 | 0.37 | 1.20 |

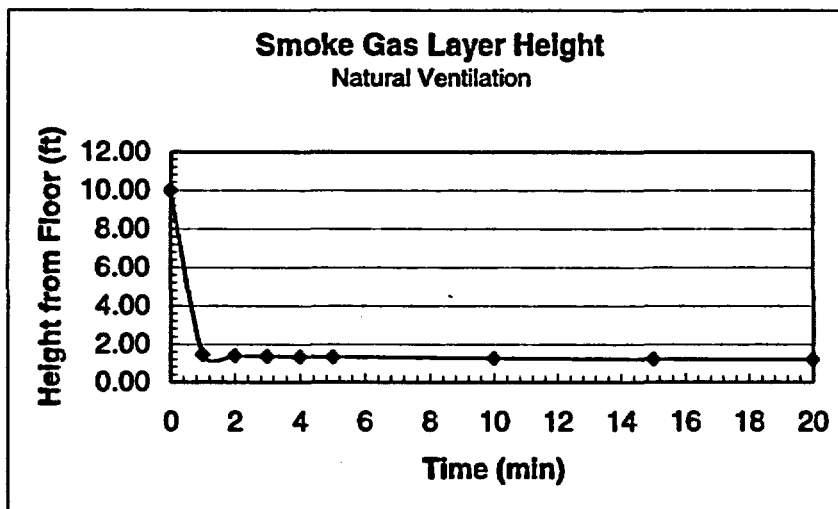

NOTE

The above calculations are based on principles developed in the SFPE Handbook of Fire Protection Engineering, 2nd Edition, 1995.

Calculations are based on certain assumptions and have inherent limitations. The results of such calculations may or may not have reasonable predictive capabilities for a given situation, and should only be interpreted by an informed user.

Although each calculation in the spreadsheet has been verified with the results of hand calculation, there is no absolute guarantee of the accuracy of these calculations.

Any questions, comments, concerns, and suggestions, or to report an error(s) in the spreadsheet, please send an email to nxi@nrc.gov.



Spreadsheet (FDT*) Solution Procedure:

Forced Ventilation Scenario

Use the following FDT*:

- (a) Temperature_FV1.xls (select *Temperature_NV Thermally Thick*)
- (b) Temperature_FV2.xls (select *Temperature_NV Thermally Thick*)

Note: Since the interior boundary material is greater than 2.54 cm (1 in), use the spreadsheet for thermally thick material. Also each spreadsheet has a different method to calculate the hot gas layer temperature (T_g). Both methods will be used to compare results.

FDT* Input Parameters:

Enter the following parameters in both spreadsheets (values only):

- Compartment Width (w_c) = 15 ft
- Compartment Length (l_c) = 16 ft
- Compartment Height (h_c) = 10 ft
- Interior Lining Thickness (δ) = 6 in
- Material: select **Gypsum Board** from the combo box
- Compartment Ventilation Rate (\dot{m}) = 500 cfm
- Fire Heat Release Rate (\dot{Q}) = 410 kW

Note: When **Gypsum Board** is selected, its thermal properties are automatically selected from the table and entered in the corresponding input cells.

Results

From the table of results of the spreadsheet at $t = 10$ minutes after ignition we obtain:

| Hot Gas Layer Temperature* T_g °C (°F) | |
|---|-------------------------|
| Method of Foot, Pagani, and Alvares (FPA) | Method of Deal & Beyler |
| 328 (622) | 439 (822) |

*spreadsheet calculations attached on next page

These results demonstrate that the ventilation system is able to increase the hot gas layer temperature. That is, for a specific compartment and heat release rate, the ventilation system can drastically increase the hot gas layer temperature due to the oxygen supply.

Spreadsheet Calculations

FDT[®]: Temperature_FV1.xls (Method of FPA)

CHAPTER 2 - PREDICTING HOT GAS LAYER TEMPERATURE IN ROOM FIRE WITH FORCED VENTILATION COMPARTMENT WITH THERMALLY THICK BOUNDARIES

The following calculations estimate the hot gas layer temperature and smoke layer height in enclosure fire. Parameters should be specified **ONLY IN THE YELLOW INPUT PARAMETER BOXES**. All subsequent output values are calculated by the spreadsheet and based on values specified in the input parameters. This spreadsheet is protected and secure to avoid errors due to a wrong entry in a cell(s). The chapter in the NUREG should be read before an analysis is made.

INPUT PARAMETERS

COMPARTMENT INFORMATION

| | | |
|-------------------------------|----------|----------|
| Compartment Width (w_c) | 15.00 ft | 4.57 m |
| Compartment Length (l_c) | 16.00 ft | 4.88 m |
| Compartment Height (h_c) | 10.00 ft | 3.05 m |
| Interior Lining Thickness () | 6.00 in | 0.1524 m |

For thermally thick case the interior lining thickness should be greater than 1 inch.

AMBIENT CONDITIONS

| | | |
|-----------------------------------|------------------------|----------|
| Ambient Air Temperature (T_a) | 77.00 °F | 25.00 °C |
| Specific Heat of Air (c_p) | 1.00 kJ/kg-K | 298.00 K |
| Ambient Air Density (ρ_a) | 1.20 kg/m ³ | |

THERMAL PROPERTIES OF COMPARTMENT ENCLOSING SURFACES

| | |
|--|---|
| Interior Lining Thermal Inertia ($k c$) | 0.18 (kW/m ² -K) ² -sec |
| Interior Lining Thermal Conductivity (k) | 0.00017 kW/m-K |
| Interior Lining Specific Heat (c) | 1.1 kJ/kg-K |
| Interior Lining Density () | 960 kg/m ³ |

THERMAL PROPERTIES FOR COMMON INTERIOR LINING MATERIALS

| Material | $k c$ (kW/m ² -K) ² -sec | k (kW/m-K) | c (kJ/kg-K) | (kg/m ³) |
|------------------------|---|-----------------|------------------|----------------------|
| Aluminum (pure) | 500 | 0.206 | 0.895 | 2710 |
| Steel (0.5% Carbon) | 197 | 0.054 | 0.465 | 7850 |
| Concrete | 2.9 | 0.0016 | 0.75 | 2400 |
| Brick | 1.7 | 0.0008 | 0.8 | 2600 |
| Glass, Plate | 1.6 | 0.00076 | 0.8 | 2710 |
| Brick/Concrete Block | 1.2 | 0.00073 | 0.84 | 1900 |
| Gypsum Board | 0.18 | 0.00017 | 1.1 | 960 |
| Plywood | 0.16 | 0.00012 | 2.5 | 540 |
| Fiber Insulation Board | 0.16 | 0.00053 | 1.25 | 240 |
| Chipboard | 0.15 | 0.00015 | 1.25 | 800 |
| Aerated Concrete | 0.12 | 0.00026 | 0.96 | 500 |
| Plasterboard | 0.12 | 0.00016 | 0.84 | 950 |
| Calcium Silicate Board | 0.098 | 0.00013 | 1.12 | 700 |
| Alumina Silicate Block | 0.036 | 0.00014 | 1 | 260 |
| Glass Fiber Insulation | 0.0018 | 0.000037 | 0.8 | 60 |
| Expanded Polystyrene | 0.001 | 0.000034 | 1.5 | 20 |

Select Material

Gypsum Board
 Scroll to desired material then
 Click on selection

Reference: Klotz, J., J. Milke, *Principles of Smoke Management*, 2002 Page 270.

COMPARTMENT MASS VENTILATION FLOW RATE

Forced Ventilation Flow Rate (m)

500.00 cfm

0.236 m³/sec

0.283 kg/sec

FIRE SPECIFICATIONS

Fire Heat Release Rate (Q)

410.00 kW

METHOD OF FOOTE, PAGNI, AND ALVARES (FPA)Reference: SFPE Handbook of Fire Protection Engineering, 2nd Edition, 1995, Page 3-140.

$$\Delta T_g/T_a = 0.63(Q/mc_p T_a)^{0.72} (h_k A_T/mc_p)^{-0.36}$$

Where

 $\Delta T_g = T_g - T_a$ = upper layer gas temperature rise above ambient (K) T_a = ambient air temperature (K)

Q = heat release rate of the fire (kW)

m = compartment mass ventilation flow rate (kg/sec)

 c_p = specific heat of air (kJ/kg-K) h_k = convective heat transfer coefficient (kW/m²-K) A_T = total area of the compartment enclosing surface boundaries (m²)**Thermal Penetration Time Calculation**

Thermally Thick Material

$$t_p = (pc_p/k)(\delta/2)^2$$

Where

 ρ = interior construction density (kg/m³) c_p = interior construction heat capacity (kJ/kg-K)

k = interior construction thermal conductivity (kW/m-K)

 δ = interior construction thickness (m)

$$t_p = 36068.24 \text{ sec}$$

Heat Transfer Coefficient Calculation

$$h_k = v(kpc/t) \text{ for } t < t_p$$

Where

kpc = interior construction thermal inertia (kW/m²-K)²-sec

(a thermal property of material responsible for the rate of temperature rise)

t = time after ignition (sec)

Area of Compartment Enclosing Surface Boundaries

$$A_T = 2(w_c \times l_c) + 2(h_c \times w_c) + 2(h_c \times l_c)$$

$$A_T = 102.19 \text{ m}^2$$

Compartment Hot Gas Layer Temperature With Forced Ventilation

$$\Delta T_g/T_a = 0.63(Q/mc_p T_a)^{0.72} (h_k A_T/mc_p)^{-0.36}$$

$$\Delta T_g = T_g - T_a$$

$$T_g = \Delta T_g + T_a$$

RESULTS

| Time after Ignition (t) | | h_k (kW/m ² -K) | $\Delta T_g/T_a$ | ΔT_g (K) | T_g (K) | T_g (°C) | T_g (°F) |
|-------------------------|------|---------------------------------|------------------|---------------------|--------------|---------------|---------------|
| (min) | (s) | | | | | | |
| 0 | 0 | - | - | - | 298.00 | 25.00 | 77.00 |
| 1 | 60 | 0.05 | 0.67 | 200.13 | 498.13 | 225.13 | 437.24 |
| 2 | 120 | 0.04 | 0.76 | 226.73 | 524.73 | 251.73 | 485.11 |
| 3 | 180 | 0.03 | 0.82 | 243.89 | 541.89 | 268.89 | 518.01 |
| 4 | 240 | 0.03 | 0.86 | 256.85 | 554.85 | 281.85 | 539.34 |
| 5 | 300 | 0.02 | 0.90 | 267.38 | 565.38 | 292.38 | 558.29 |
| 10 | 600 | 0.02 | 1.02 | 302.91 | 600.91 | 327.91 | 622.24 |
| 15 | 900 | 0.01 | 1.09 | 325.85 | 623.85 | 350.85 | 663.52 |
| 20 | 1200 | 0.01 | 1.15 | 343.16 | 641.16 | 368.16 | 694.69 |

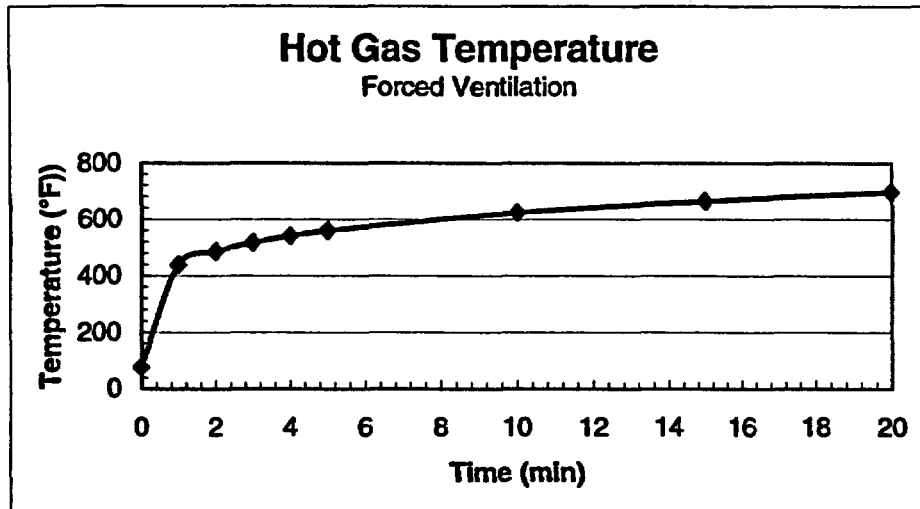

NOTE

The above calculations are based on principles developed in the SFPE Handbook of Fire Protection Engineering, 2nd Edition, 1995.

Calculations are based on certain assumptions and have inherent limitations. The results of such calculations may or may not have reasonable predictive capabilities for a given situation, and should only be interpreted by an informed user.

Although each calculation in the spreadsheet has been verified with the results of hand calculation, there is no absolute guarantee of the accuracy of these calculations.

Any questions, comments, concerns, and suggestions, or to report an error(s) in the spreadsheet, please send an email to nxi@nrc.gov.



CHAPTER 2 - PREDICTING HOT GAS LAYER TEMPERATURE IN ROOM FIRE WITH FORCED VENTILATION COMPARTMENT WITH THERMALLY THICK BOUNDARIES

The following calculations estimate the hot gas layer temperature in enclosure fire. Parameters should be specified **ONLY IN THE YELLOW INPUT PARAMETER BOXES**. All subsequent output values are calculated by the spreadsheet and based on values specified in the input parameters. This spreadsheet is protected and secure to avoid errors due to a wrong entry in a cell(s). The chapter in the NUREG should be read before an analysis is made.

INPUT PARAMETERS

COMPARTMENT INFORMATION

| | | |
|-------------------------------|----------|----------|
| Compartment Width (w_c) | 40.00 ft | 12.19 m |
| Compartment Length (l_c) | 40.00 ft | 12.19 m |
| Compartment Height (h_c) | 12.00 ft | 3.66 m |
| Interior Lining Thickness () | | |
| | 2.00 in | 0.0508 m |

For thermally thick case the interior lining thickness should be greater than 1 inch.

AMBIENT CONDITIONS

| | | |
|-----------------------------------|------------------------|----------------------|
| Ambient Air Temperature (T_a) | 77.00 °F | 25.00 °C 298.00 K |
| Specific Heat of Air (c_p) | 1.00 kJ/kg-K | |
| Ambient Air Density (ρ_a) | 1.20 kg/m ³ | |

THERMAL PROPERTIES OF COMPARTMENT ENCLOSING SURFACES

| | |
|--|---|
| Interior Lining Thermal Inertia ($k c$) | 0.18 (kW/m ² -K) ² -sec |
| Interior Lining Thermal Conductivity (k) | 0.00017 kW/m-K |
| Interior Lining Specific Heat (c) | 1.1 kJ/kg-K |
| Interior Lining Density () | 960 kg/m ³ |

THERMAL PROPERTIES FOR COMMON INTERIOR LINING MATERIALS

| Material | k c (kW/m ² -K) ² -sec | k (kW/m-K) | c (kJ/kg-K) | (kg/m ³) | Select Material |
|------------------------|---|---------------|----------------|----------------------|---|
| Aluminum (pure) | 500 | 0.206 | 0.895 | 2710 | Gypsum Board Scroll to desired material then Click on selection |
| Steel (0.5% Carbon) | 197 | 0.054 | 0.465 | 7850 | |
| Concrete | 2.9 | 0.0016 | 0.75 | 2400 | |
| Brick | 1.7 | 0.0008 | 0.8 | 2600 | |
| Glass, Plate | 1.6 | 0.00076 | 0.8 | 2710 | |
| Brick/Concrete Block | 1.2 | 0.00073 | 0.84 | 1900 | |
| Gypsum Board | 0.18 | 0.00017 | 1.1 | 960 | |
| Plywood | 0.16 | 0.00012 | 2.5 | 540 | |
| Fiber Insulation Board | 0.16 | 0.00053 | 1.25 | 240 | |
| Chipboard | 0.15 | 0.00015 | 1.25 | 800 | |
| Aerated Concrete | 0.12 | 0.00026 | 0.96 | 500 | |
| Plasterboard | 0.12 | 0.00016 | 0.84 | 950 | |
| Calcium Silicate Board | 0.098 | 0.00013 | 1.12 | 700 | |
| Alumina Silicate Block | 0.036 | 0.00014 | 1 | 260 | |
| Glass Fiber Insulation | 0.0018 | 0.000037 | 0.8 | 60 | |
| Expanded Polystyrene | 0.001 | 0.000034 | 1.5 | 20 | |

Reference: Klote, J., J. Milke, *Principles of Smoke Management*, 2002, Page 270.

COMPARTMENT MASS VENTILATION FLOW RATE

Forced Ventilation Flow Rate (m)

500.00 cfm

0.236 m³/sec

0.283 kg/sec

FIRE SPECIFICATIONS

Fire Heat Release Rate (Q)

410.00 kW

METHOD OF DEAL AND BEYLERReference: SFPE Handbook of Fire Protection Engineering, 3rd Edition, 2002, Page 3-178.**Heat Transfer Coefficient Calculation**

$$h_k = 0.4 v(kpc / t) \text{ for } t < t_p$$

Where kpc = interior construction thermal inertia (kW/m²-K)²-sec
 (a thermal property of material responsible for the rate of temperature rise)
 δ = thickness of interior lining (m)

$$h_k = 0.022 \text{ kW/m}^2\text{-K}$$

Area of Compartment Enclosing Surface Boundaries

$$A_T = 2(w_c \times l_c) + 2(h_c \times w_c) + 2(l_c \times l_c)$$

$$A_T = 102.19 \text{ m}^2$$

Compartment Hot Gas Layer Temperature With Forced Ventilation

$$\Delta T_g = Q / (m c_p + h_k A_T)$$

Where $\Delta T_g = T_g - T_a$ = upper layer gas temperature rise above ambient (K)
 T_a = ambient air temperature (K)
 Q = heat release rate of the fire (kW)
 m = compartment mass ventilation flow rate (kg/sec)
 c_p = specific heat of air (kJ/Kg-K)
 h_k = convective heat transfer coefficient (kW/m²-K)
 A_T = total area of the compartment enclosing surface boundaries (m²)

Results:

| Time after Ignition (t) | | h_k (kW/m ² -K) | ΔT_g (K) | T_g (K) | T_g (°C) | T_g (°F) |
|-------------------------|------|---------------------------------|---------------------|--------------|---------------|---------------|
| (min) | (s) | | | | | |
| 0 | 0 | - | - | 298.00 | 25.00 | 77.00 |
| 1 | 60 | 0.02 | 162.56 | 460.56 | 187.56 | 369.61 |
| 2 | 120 | 0.02 | 219.68 | 517.68 | 244.68 | 472.43 |
| 3 | 180 | 0.01 | 260.18 | 558.18 | 285.18 | 545.33 |
| 4 | 240 | 0.01 | 292.31 | 590.31 | 317.31 | 603.15 |
| 5 | 300 | 0.01 | 319.20 | 617.20 | 344.20 | 651.56 |
| 10 | 600 | 0.01 | 413.65 | 711.65 | 438.65 | 821.56 |
| 15 | 900 | 0.01 | 476.05 | 774.05 | 501.05 | 933.88 |
| 20 | 1200 | 0.00 | 523.08 | 821.08 | 548.08 | 1018.55 |

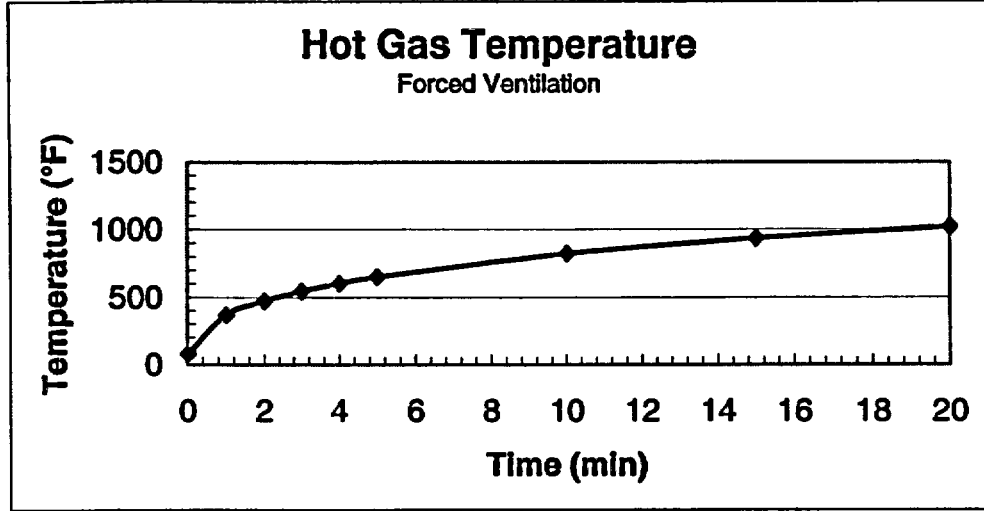

NOTE

The above calculations are based on principles developed in the SFPE Handbook of Fire Protection Engineering, 3rd Edition, 2002.

Calculations are based on certain assumptions and have inherent limitations. The results of such calculations may or may not have reasonable predictive capabilities for a given situation, and should only be interpreted by an informed user.

Although each calculation in the spreadsheet has been verified with the results of hand calculation, there is no absolute guarantee of the accuracy of these calculations.

Any questions, comments, concerns, and suggestions, or to report an error(s) in the spreadsheet, please send an email to nxi@nrc.gov.



Further Analysis

We have seen a significant difference between the method of FPA and method of Deal & Beyler in various forced ventilation problems. Since we obtained a difference in hot gas layer temperature in this problem, we are going to analyze the discrepancy between the FPA and Deal & Beyler methods as a function of time exposure using the data of problem 3. Plotting the results of each method will help us to understand the limitations and validity of the empirical correlations.

Problem Data:

From any attached spreadsheet calculations of problem 3 we can obtain:

$$\text{Heat Release Rate: } (\dot{Q}) = 410 \text{ kW}$$

$$\text{Compartment Initial Temperature: } T_a = 25 \text{ }^\circ\text{C (298K)}$$

$$\text{Ventilation mass flow rate: } \dot{m} = 0.283 \text{ kg/sec}$$

$$\text{Air specific Heat at } T_a: C_p = 1.0 \text{ kJ/kg-K}$$

$$\text{Exposure time: } t = 10 \text{ min} = 600 \text{ sec}$$

$$\text{Total area of compartment enclosing surfaces: } A_T = 102.19 \text{ m}^2$$

$$\text{Material Thermal Inertia: } kpc = 0.18 \left(\frac{\text{kW}}{\text{m}^2 \cdot \text{K}} \right)^2$$

Heat Transfer Coefficient:

$$h_k = \sqrt{\frac{kpc}{t}} = \sqrt{\frac{0.18}{t}} \quad \text{Method of FPA}$$

$$h_k = 0.4 \sqrt{\frac{kpc}{t}} = 0.4 \sqrt{\frac{0.18}{t}} \quad \text{Method of Deal and Beyler}$$

Hot Gas Layer Temperature according to method of FPA

$$T_g = T_a \left\{ 0.63 \left(\frac{\dot{Q}}{\dot{m} C_p T_a} \right)^{0.72} \left(\frac{h_k A_T}{\dot{m} C_p} \right)^{-0.36} \right\} + T_a$$

$$T_g = 298 \left\{ 0.63 \left(\frac{410}{0.283 \times 1.0 \times 298} \right)^{0.72} \left(\frac{\sqrt{\frac{0.18}{t}} (102.19)}{0.283 (1.00)} \right)^{-0.36} \right\} + 298$$

$$T_g = 298 \left\{ 1.967 \left(\sqrt{\frac{0.18}{t}} \right)^{-0.36} \right\} + 298 \quad (1)$$

Where t is in seconds and T_g is in Kelvin
Hot Gas Layer Temperature Method of Deal & Beyler

$$T_g = \frac{\dot{Q}}{\dot{m} C_p + h_k A_T} + T_a = \frac{410}{0.283(1.0) + 0.4 \sqrt{\frac{0.18}{t}} (102.19)} + 298$$

$$T_g = \frac{410}{0.283 + 44.88 \sqrt{\frac{0.18}{t}}} + 298 \quad (2)$$

Where t is in seconds and T_g is in Kelvin

Hot Gas Layer Temperature Plot

Using Microsoft Excel, we can plot the hot gas layer temperature as a function of time according with equations (1) and (2).

**Problem 3: Hot Gas Layer Temperature for Forced Ventilation Scenario
 Method of FPA and Deal-Beyler**

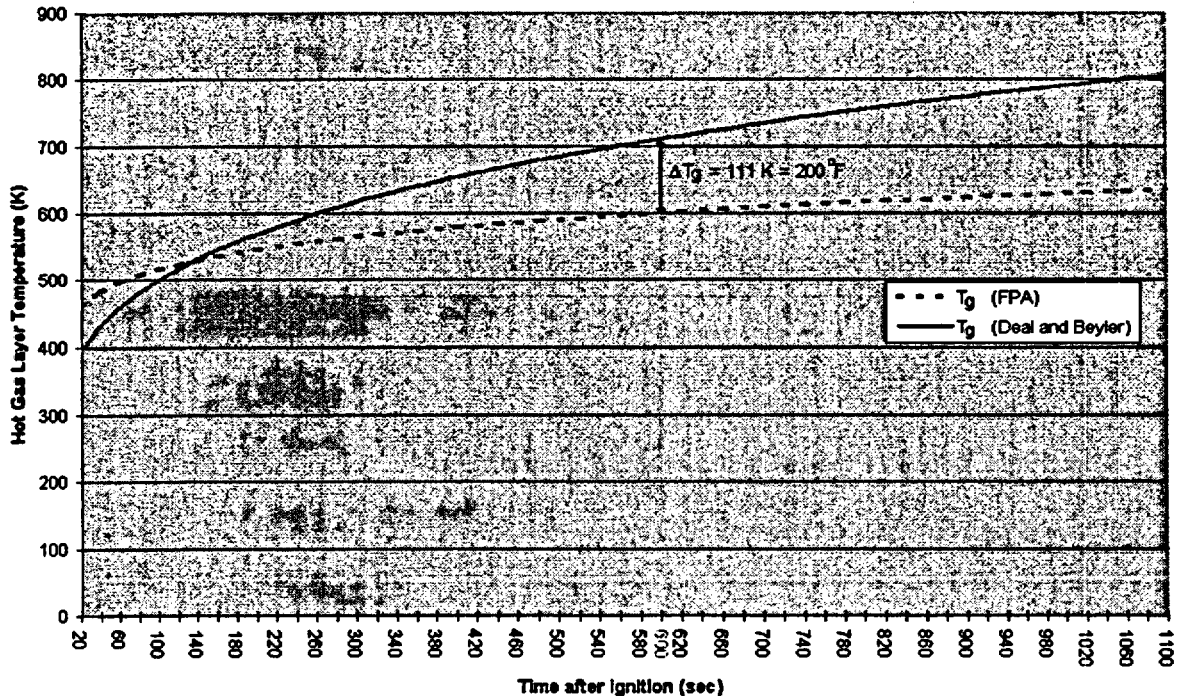

From this T_g vs time plot we can observe how the temperature difference between the two methods (δT_g) increases with the exposure time. We can see that both methods coincide only in one point of the graph ($t = 140$ sec), after this point there is a rapid increase in the δT_g value. Also, we have seen during this analysis that δT_g is strictly dependent of the compartment dimensions, HRR and boundary material properties. That means that the δT_g - time relation is not constant for all fire scenarios.

The difference in two methods could be the nature of the experiments where the correlations were developed. Each experiment maybe was performed under different compartment conditions, configuration, and instruments for measurements. Hence, for a specific fire scenario, we should use the most conservative value depending on the safety significance of the fire hazard.

This page intentionally left blank.

Problem J-4

Problem Statement

Consider a pool fire caused by a 38.0 liters (10 gallons) spill flammable liquid (kerosine oil) in a 0.55 m² (6.0 ft²) dike area in a compartment with a concrete floor. The kerosine oil is ignited and spread rapidly over the surface, reaching steady burning almost instantly. Compute the HRR, burning duration, and flame height of the pool fire. The dimensions of the compartment are 6.0 m wide x 6.0 m long x 3.7 m high (20.0 ft wide x 20.0 ft long x 12.0 ft). Two cable trays are located above the pool fire at heights of 2.15 m (7.0 ft) and 3.0 m (10.0 ft), respectively. Determine whether flame will impinge upon the cable trays. Assume instantaneous, complete involvement of the liquid pool with no fire growth and no intervention by the plant fire department or automatic suppression systems.

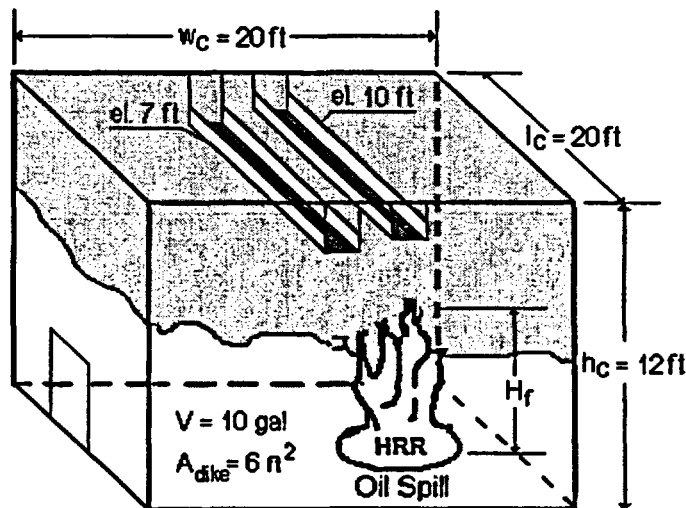

Problem 4: Compartment with Liquid Pool Fire Scenario

Solution

Purpose:

- (1) Determine the HRR of the liquid pool fire.
- (2) Determine the flame duration.
- (3) Determine flame height (H_f).
- (4) Determine if the flame will impinge the cable trays.

Assumptions:

- (1) There is instantaneous and complete involvement of the liquid in the pool fire.
- (2) The pool fire is burning in the open.
- (3) The pool is circular or nearly circular and contains a fixed mass of liquid volume.
- (4) The pool fire is in the center of the compartment or away from the walls.

Spreadsheet (FDT[®]) Solution Procedure:

Use the following FDT[®]:

- (a) HRR_Flame_Height_Burning_Duration_Calculations.xls

FDT[®] Input Parametrs:

Enter the following parameters in the spreadsheet (values only):

- Fuel spill volume (V) = 10 gallons
- Fuel Spill Area or Dike Area (A_{dike}) = 6.0 ft²
- Select Fuel Type: select Kerosine from the combo box

Note: When Kerosine is selected, its properties are automatically selected from the table and entered in the corresponding input cells.

Results

| Heat Release Rate* \dot{Q} kW (Btu/sec) | Burning Duration* t_b (min) | Pool Fire Flame Height* | |
|--|----------------------------------|-------------------------------------|------------------|
| | | Method of Heskestad H_f m (ft) | Method of Thomas |
| 939 (890) | 24 | 2.8 (9.1) | 2.5 (7.6) |

*spreadsheet calculations attached on next page

Both methods for pool fire flame height estimation show that the flame could impinge upon the cable trays.

Spreadsheet Calculations

CHAPTER 3 - ESTIMATING THE HEAT RELEASE RATE, BURNING DURATION, AND FLAME HEIGHT FOR A LIQUID POOL FIRE

The following calculations estimate the heat release rate, burning duration, and flame height for liquid pool fire. Parameters should be specified **ONLY IN THE YELLOW INPUT PARAMETER BOXES**. All subsequent output values are calculated by the spreadsheet and based on values specified in the input parameters. This spreadsheet is protected and secure to avoid errors due to a wrong entry in a cell(s). The chapter in the NUREG should be read before an analysis is made.

INPUT PARAMETERS

| | | |
|--|------------------------------|-----------------------|
| Fuel Spill Volume (V) | 10.00 gallons | 0.0379 m ³ |
| Fuel Spill Area or Dike Area (A _{spill}) | 6.00 ft ² | 0.557 m ² |
| Mass Burning Rate of Fuel (m ³) | 0.039 kg/m ² -sec | |
| Effective Heat of Combustion of Fuel (H _{c,eff}) | 43200 kJ/kg | |
| Fuel Density (ρ) | 820 kg/m ³ | |
| Gravitational Acceleration (g) | 9.81 m/sec ² | |
| Ambient Air Density (ρ _a) | 1.20 kg/m ³ | |

THERMAL PROPERTIES DATA BURNING RATE DATA FOR LIQUID HYDROCARBON FUELS

| Fuel | Mass Burning Rate m ³ (kg/m ² -sec) | Heat of Combustion ΔH _{c,eff} (kJ/kg) | Density ρ (kg/m ³) | Select Fuel Type |
|------------------------------|--|---|-----------------------------------|--|
| Methanol | 0.017 | 20,000 | 796 | Kerosine |
| Ethanol | 0.015 | 26,800 | 794 | Scroll to desired fuel type then Click on selection |
| Butane | 0.078 | 45,700 | 573 | |
| Benzene | 0.085 | 40,100 | 874 | |
| Hexane | 0.074 | 44,700 | 850 | |
| Heptane | 0.101 | 44,800 | 675 | |
| Xylene | 0.09 | 40,800 | 870 | |
| Acetone | 0.041 | 25,800 | 791 | |
| Dioxane | 0.018 | 25,200 | 1035 | |
| Diethyl Ether | 0.085 | 34,200 | 714 | |
| Benzine | 0.048 | 44,700 | 740 | |
| Gasoline | 0.055 | 43,700 | 740 | |
| Kerosine | 0.039 | 43,200 | 820 | |
| Diesel | 0.045 | 44,400 | 918 | |
| JP-4 | 0.051 | 43,500 | 760 | |
| JP-5 | 0.054 | 43,000 | 810 | |
| Transformer Oil, Hydrocarbon | 0.039 | 46,000 | 780 | |
| Fuel Oil, Heavy | 0.035 | 39,700 | 970 | |
| Crude Oil | 0.0335 | 42,800 | 855 | |
| Lube Oil | 0.039 | 46,000 | 780 | |

ESTIMATING POOL FIRE HEAT RELEASE RATE

Reference: SFPE Handbook of Fire Protection Engineering, 2nd Edition, 1995, Page 3-4.

$$Q = m \cdot \Delta H_{c,eff} \cdot A_f$$

Where Q = pool fire heat release rate (kW)
 m = mass burning rate of fuel per unit surface area (kg/m²-sec)
 $\Delta H_{c,eff}$ = effective heat of combustion of fuel (kJ/kg)
 $A_f = A_{c,eff}$ = surface area of pool fire (area involved in vaporization) (m²)

Heat Release Rate Calculation (Liquids with relatively high flash point, like transformer oil, require localized heating to achieve ignition)

$$Q = m \cdot \Delta H_c \cdot A_f$$

$Q =$ 939.14 kW 890.13 BTU/sec ANSWER

ESTIMATING POOL FIRE BURNING DURATION

Reference: SFPE Handbook of Fire Protection Engineering, 2nd Edition, 1995, Page 3-197.

$$t_b = 4V/\pi D^2 v$$

Where t_b = burning duration of pool fire (sec)
 V = volume of liquid (m³)
 D = pool diameter (m)
 v = regression rate (m/sec)

Pool Fire Diameter Calculation

$$A_{c,eff} = \pi D^2/4$$

$$D = \sqrt{4A_{c,eff}/\pi}$$

$$D = 0.842 \quad \text{m}$$

Calculation for Regression Rate

$$v = m/\rho$$

Where m = mass burning rate of fuel (kg/m²-sec)

ρ = liquid fuel density (kg/m³)

$$v = 0.000048 \quad \text{m/sec}$$

Burning Duration Calculation

$$t_b = 4V/\pi D^2 v$$

$t_b =$ 1427.85 sec 23.80 minutes ANSWER

Note that a liquid pool fire with a given amount of fuel can burn for long periods of time over small area or for short periods of time over a large area.

ESTIMATING POOL FIRE FLAME HEIGHT METHOD OF HESKESTAD

Reference: SFPE Handbook of Fire Protection Engineering, 2nd Edition, 1995, Page 2-10.

$$H_f = 0.235 Q^{2/5} - 1.02 D$$

Where H_f = pool fire flame height (m)
 Q = pool fire heat release rate (kW)
 D = pool fire diameter (m)

Pool Fire Flame Height Calculation

$$H_f = 0.235 Q^{2/5} - 1.02 D$$

$H_f =$ 2.77 m 9.10 ft ANSWER

METHOD OF THOMAS

Reference: *SFPE Handbook of Fire Protection Engineering*, 2nd Edition, 1995, Page 3-204.

$$H_f = 42 D (m''/\rho_a \sqrt{g D})^{0.61}$$

Where H_f = pool fire flame height (m)

m'' = mass burning rate of fuel per unit surface area ($\text{kg}/\text{m}^2\text{-sec}$)

ρ_a = ambient air density (kg/m^3)

D = pool fire diameter (m)

g = gravitational acceleration (m/sec^2)

Pool Fire Flame Height Calculation

$$H_f = 42 D (m''/\rho_a \sqrt{g D})^{0.61}$$

| | | | |
|---------|--------|---------|--------|
| $H_f =$ | 2.30 m | 7.54 ft | ANSWER |
|---------|--------|---------|--------|

NOTE

The above calculations are based on principles developed in the *SFPE Handbook of Fire Protection Engineering*, 2nd Edition, 1995. Calculations are based on certain assumptions and have inherent limitations. The results of such calculations may or may not have reasonable predictive capabilities for a given situation and should only be interpreted by an informed user. Although each calculation in the spreadsheet has been verified with the results of hand calculation, there is no absolute guarantee of the accuracy of these calculations. Any questions, comments, concerns, and suggestions, or to report an error(s) in the spreadsheets, please send an email to nxi@nrc.gov.



Office of Nuclear Reactor Regulation

This page intentionally left blank.

Problem J-5

Problem Statement

Consider a compartment with cable trays at 4.60 m (15 ft) above floor. The cable trays are very close to the compartment walls. If 7.6 liters (2 gallons) of lube oil spills covering an area of 1.4 m² (15 ft²), what location or type of fire source will allow the fire flame to impinge on the cable trays?

Solution

Purpose:

- (1) Determine what type of fire source will impinge upon the cable tray.

Assumptions:

- (1) Air is entrained only from one side during the combustion process.

Spreadsheet (FDT[®]) Solution Procedure:

Use the following FDT[®]:

- (a) Flame_Height_Calculations.xls
select *Wall_Line_Flame_Height* for line fire analysis
select *Corner_Flame_Height* for corner fire analysis
Wall_Flame_Height for wall fire analysis

FDT[®] Input Parameters:

Enter the following parameters in all spreadsheets (values only):

- Fuel spill volume (V) = 2 gallons
- Fuel Spill Area or Dike Area (A_{dike}) = 15 ft²
- Select Fuel Type: select **Lube Oil** from the combo box

Note: When **Lube Oil** is selected, its properties are automatically selected from the table and entered in the corresponding input cells.

Results

| Fire Source | Flame Height* H _f m (ft) |
|-------------|--|
| Line Fire | 2.80 (9.20) |
| Corner Fire | 8.20 (26.9) |
| Wall Fire | 5.60 (18.40) |

*spreadsheet calculations attached on next page

The spreadsheet calculations show that a corner or wall fire of lube oil with a dike area of (1.4 m²) 15 ft² could impinge upon the cable trays.

Spreadsheet Calculations

CHAPTER 4 - ESTIMATING LINE FIRE FLAME HEIGHT AGAINST THE WALL

The following calculations estimate the line fire flame height against the wall.
Parameters should be specified ONLY IN THE YELLOW INPUT PARAMETER BOXES.
 All subsequent output values are calculated by the spreadsheet and based on values specified in the input parameters. This spreadsheet is protected and secure to avoid errors due to a wrong entry in a cell(s).
 The chapter in the NUREG should be read before an analysis is made.

INPUT PARAMETERS

| | | | |
|--|-------|------------------------|-----------------------|
| Fuel Spill Volume (V) | 2.00 | gallons | 0.0076 m ³ |
| Fuel Spill Area or Dike Area (A _{dike}) | 15.00 | ft ² | 1.394 m ² |
| Mass Burning Rate of Fuel (m ^o) | 0.039 | kg/m ² -sec | |
| Effective Heat of Combustion of Fuel (H _{c,eff}) | 46000 | kJ/kg | |

THERMAL PROPERTIES FOR

BURNING RATE DATA FOR LIQUID HYDROCARBON FUELS

| Fuel | Mass Burning Rate m ^o (kg/m ² -sec) | Heat of Combustion ΔH _{c,eff} (kJ/kg) |
|------------------------------|--|---|
| Methanol | 0.017 | 20,000 |
| Ethanol | 0.015 | 28,800 |
| Butane | 0.078 | 45,700 |
| Benzene | 0.085 | 40,100 |
| Hexane | 0.074 | 44,700 |
| Heptane | 0.101 | 44,600 |
| Xylene | 0.09 | 40,800 |
| Acetone | 0.041 | 25,800 |
| Dioxane | 0.018 | 26,200 |
| Diethyl Ether | 0.085 | 34,200 |
| Benzene | 0.048 | 44,700 |
| Gasoline | 0.055 | 43,700 |
| Kerosene | 0.039 | 43,200 |
| Diesel | 0.045 | 44,400 |
| JP-4 | 0.051 | 43,500 |
| JP-5 | 0.054 | 43,000 |
| Transformer Oil, Hydrocarbon | 0.039 | 48,000 |
| Fuel Oil, Heavy | 0.035 | 39,700 |
| Crude Oil | 0.034 | 42,600 |
| Lube Oil | 0.039 | 48,000 |

Select Fuel Type

JP-5
 Scroll to desired fuel by
 Click on selection

Reference: SFPE Handbook of Fire Protection Engineering, 2nd Edition, Page 3-2.

Heat Release Rate Calculation

Reference: SFPE Handbook of Fire Protection Engineering, 2nd Edition, 1995, Page 3-4.

$$Q = m^o H_{c,eff} A_f$$

Where Q = pool fire heat release rate (kW)
 m^o = mass burning rate of fuel per unit surface area (kg/m²-sec)
 $\Delta H_{c,eff}$ = effective heat of combustion of fuel (kJ/kg)
 $A_f = A_{dike}$ = surface area of pool fire (area involved in vaporization) (m²)

$$Q = m^o H_{c} A_f$$

(Liquids with relatively high flash point, like transformer oil require localized heating to achieve ignition)

$$Q = 2500.02 \text{ kW} \quad 2369.57 \text{ BTU/sec}$$

Heat Release Rate Per Unit Length of Fire Calculation

$$Q' = Q/L$$

Where Q' = heat release rate per unit length (kW/m)
 Q = fire heat release rate of the fire (kW)
 L = length of the fire source (m)

Fire Source Length Calculation

$$L \times W = A_{\text{disk}}$$

$$L \times W = 1,394 \text{ m}^2$$

$$L = 1.180 \text{ m}$$

$$Q' = Q/L$$

$$Q' = 2117.79 \text{ kW/m}$$

ESTIMATING LINE WALL FIRE FLAME HEIGHT

Reference: *NFPA Fire Protection Handbook*, 18th Edition, 1997, Page 11-96.

$$H_{f(\text{wall line})} = 0.017 Q'^{2/3}$$

Where $H_{f(\text{wall line})}$ = wall fire flame height (m)
 Q' = rate of heat release per unit length of the fire (kW/m)

$$H_{f(\text{wall line})} = 0.017 Q'^{2/3}$$

| | | | |
|-----------------------------|--------|---------|---------------|
| $H_{f(\text{wall line})} =$ | 2.60 m | 9.20 ft | ANSWER |
|-----------------------------|--------|---------|---------------|

NOTE

The above calculations are based on principles developed in the SFPE Handbook of Fire Protection Engineering, 2nd Edition, 1995, and NFPA Fire Protection Handbook, 18th Edition, 1997. Calculations are based on certain assumptions and have inherent limitations. The results of such calculations may or may not have reasonable predictive capabilities for a given situation, and should only be interpreted by an informed user. Although each calculation in the spreadsheet has been verified with the results of hand calculation, there is no absolute guarantee of the accuracy of these calculations. Any questions, comments, concerns, and suggestions, or to report an error(s) in the spreadsheets, please send an email to nxi@nrc.gov.



CHAPTER 4 - ESTIMATING CORNER FIRE FLAME HEIGHT

The following calculations estimate the corner fire flame height.
Parameters should be specified ONLY IN THE YELLOW INPUT PARAMETER BOXES.
 All subsequent output values are calculated by the spreadsheet and based on values specified in the input parameters. This spreadsheet is protected and secure to avoid errors due to a wrong entry in a cell(s).
 The chapter in the NUREG should be read before an analysis is made.

INPUT PARAMETERS

| | | | |
|--|-------|------------------------|-----------------------|
| Fuel Spill Volume (V) | 5.00 | gallons | 0.0189 m ³ |
| Fuel Spill Area or Dike Area (A _{dike}) | 6.00 | ft ² | 0.557 m ² |
| Mass Burning Rate of Fuel (m ^o) | 0.039 | kg/m ² -sec | |
| Effective Heat of Combustion of Fuel (H _{c,eff}) | 46000 | kJ/kg | |

THERMAL PROPERTIES FOR

BURNING RATE DATA FOR LIQUID HYDROCARBON FUELS

| Fuel | Mass Burning Rate m ^o (kg/m ² -sec) | Heat of Combustion ΔH _{c,eff} (kJ/kg) |
|------------------------------|--|---|
| Methanol | 0.017 | 20,000 |
| Ethanol | 0.015 | 28,800 |
| Butane | 0.078 | 45,700 |
| Benzene | 0.085 | 40,100 |
| Hexane | 0.074 | 44,700 |
| Heptane | 0.101 | 44,600 |
| Xylene | 0.09 | 40,800 |
| Acetone | 0.041 | 25,800 |
| Dioxane | 0.018 | 28,200 |
| Diethyl Ether | 0.085 | 34,200 |
| Benzene | 0.048 | 44,700 |
| Gasoline | 0.055 | 43,700 |
| Kerosene | 0.039 | 43,200 |
| Diesel | 0.045 | 44,400 |
| JP-4 | 0.051 | 43,500 |
| JP-5 | 0.054 | 43,000 |
| Transformer Oil, Hydrocarbon | 0.039 | 48,000 |
| Fuel Oil, Heavy | 0.035 | 39,700 |
| Crude Oil | 0.034 | 42,600 |
| Lube Oil | 0.039 | 48,000 |

Select Fuel Type

Lube Oil

Scroll to desired fuel type
Click on selection

Reference: SFPE Handbook of Fire Protection Engineering, 2nd Edition, 1995, Page 3-2.

Heat Release Rate Calculation

Reference: SFPE Handbook of Fire Protection Engineering, 2nd Edition, 1995, Page 3-4.

$$Q = m^o H_{c,eff} A_f$$

Where Q = pool fire heat release rate (kW)
 m^o = mass burning rate of fuel per unit surface area (kg/m²-sec)
 ΔH_{c,eff} = effective heat of combustion of fuel (kJ/kg)
 A_f = A_{dike} = surface area of pool fire (area involved in vaporization) (m²)

$$Q = m^o H_{c,A_f}$$

(Liquids with relatively high flash point, like transformer oil require localized heating to achieve ignition)

$$Q = 1000.01 \text{ kW}$$

$$947.83 \text{ BTU/sec}$$

ESTIMATING CORNER FIRE FLAME HEIGHT

Reference: SFPE Handbook of Fire Protection Engineering, 2nd Edition, Page -2-10.

$$H_{f(\text{corner})} = 0.075 Q^{3/5}$$

Where Q = heat release rate of the fire (kW)

$$H_{f(\text{corner})} = 0.075 Q^{3/5}$$

| | | | |
|--------------------------------|--------|----------|--------|
| $H_{f(\text{corner})} \approx$ | 8.20 m | 26.90 ft | ANSWER |
|--------------------------------|--------|----------|--------|

NOTE

The above calculations are based on principles developed in the SFPE Handbook of Fire Protection Engineering, 2nd Edition, 1995.

Calculations are based on certain assumptions and have inherent limitations. The results of such calculations may or may not have reasonable predictive capabilities for a given situation, and should only be interpreted by an informed user.

Although each calculation in the spreadsheet has been verified with the results of hand calculation, there is no absolute guarantee of the accuracy of these calculations.

Any questions, comments, concerns, and suggestions, or to report an error(s) in the spreadsheet, please send an email to nxi@nrc.gov.



CHAPTER 4 - ESTIMATING WALL FIRE FLAME HEIGHT

The following calculations estimate the wall fire flame height.

Parameters should be specified ONLY IN THE YELLOW INPUT PARAMETER BOXES.

All subsequent output values are calculated by the spreadsheet and based on values specified in the input parameters. This spreadsheet is protected and secure to avoid errors due to a wrong entry in a cell(s).

The chapter in the NUREG should be read before an analysis is made.

INPUT PARAMETERS

| | | | |
|--|-------|------------------------|-----------------------|
| Fuel Spill Volume (V) | 2.00 | gallons | 0.0076 m ³ |
| Fuel Spill Area or Dike Area (A _{dike}) | 15.00 | ft ² | 1.394 m ² |
| Mass Burning Rate of Fuel (m [*]) | 0.039 | kg/m ² -sec | |
| Effective Heat of Combustion of Fuel (H _{c,eff}) | 46000 | kJ/kg | |

THERMAL PROPERTIES FOR

BURNING RATE DATA FOR LIQUID HYDROCARBON FUELS

| Fuel | Mass Burning Rate m [*] (kg/m ² -sec) | Heat of Combustion ΔH _{c,eff} (kJ/kg) |
|------------------------------|--|---|
| Methanol | 0.017 | 20,000 |
| Ethanol | 0.015 | 26,800 |
| Butane | 0.078 | 45,700 |
| Benzene | 0.085 | 40,100 |
| Hexane | 0.074 | 44,700 |
| Heptane | 0.101 | 44,600 |
| Xylene | 0.09 | 40,800 |
| Acetone | 0.041 | 25,800 |
| Dioxane | 0.018 | 26,200 |
| Diethyl Ether | 0.085 | 34,200 |
| Benzene | 0.048 | 44,700 |
| Gasoline | 0.055 | 43,700 |
| Kerosene | 0.039 | 43,200 |
| Diesel | 0.045 | 44,400 |
| JP-4 | 0.051 | 43,500 |
| JP-5 | 0.054 | 43,000 |
| Transformer Oil, Hydrocarbon | 0.039 | 46,000 |
| Fuel Oil, Heavy | 0.035 | 39,700 |
| Crude Oil | 0.034 | 42,600 |
| Lube Oil | 0.039 | 46,000 |

Select Fuel Type

Lube Oil

Scroll to desired fuel type then
Click on selection

Reference: SFPE Handbook of Fire Protection Engineering, 2nd Edition, Page 3-2.

Heat Release Rate Calculation

Reference: SFPE Handbook of Fire Protection Engineering, 2nd Edition, 1995, Page 3-4.

$$Q = m^* H_{c,eff} A_f$$

Where Q = pool fire heat release rate (kW)

m^{*} = mass burning rate of fuel per unit surface area (kg/m²-sec)

ΔH_{c,eff} = effective heat of combustion of fuel (kJ/kg)

A_f = A_{dike} = surface area of pool fire (area involved in vaporization) (m²)

$$Q = m^* H_{c,eff} A_f$$

(Liquids with relatively high flash point, like transformer oil require localized heating to achieve ignition)

$$Q = 2500.02 \text{ kW}$$

$$2369.57 \text{ BTU/sec}$$

Heat Release Rate Per Unit Length of Fire Calculation

$$Q' = Q/L$$

Where Q' = heat release rate per unit length (kW/m)
 Q = fire heat release rate of the fire (kW)
 L = length of the fire source (m)

Fire Source Length Calculation

$$L \times W = A_{dike}$$

$$L \times W = 1.394 \text{ m}^2$$

$$L = 1.180 \text{ m}$$

$$Q' = Q/L$$

$$Q' = 2117.79 \text{ kW/m}$$

ESTIMATING WALL FIRE FLAME HEIGHT

Reference: *NFPA Fire Protection Handbook*, 18th Edition, 1997, Page 11-96.

$$H_{f(wall)} = 0.034 Q'^{2/3}$$

Where $H_{f(wall)}$ = wall fire flame height (m)
 Q' = rate of heat release per unit length of the fire (kW/m)

$$H_{f(wall)} = 0.034 Q'^{2/3}$$

| | | | |
|-----------------|--------|----------|---------------|
| $H_{f(wall)} =$ | 5.61 m | 18.40 ft | ANSWER |
|-----------------|--------|----------|---------------|

NOTE

The above calculations are based on principles developed in the SFPE Handbook of Fire Protection Engineering, 2nd Edition, 1995, and NFPA Fire Protection Handbook, 18th Edition, 1997. Calculations are based on certain assumptions and have inherent limitations. The results of such calculations may or may not have reasonable predictive capabilities for a given situation, and should only be interpreted by an informed user.

Although each calculation in the spreadsheet has been verified with the results of hand calculation, there is no absolute guarantee of the accuracy of these calculations.

Any questions, comments, concerns, and suggestions, or to report an error(s) in the spreadsheet, please send an email to nxi@nrc.gov.



This page intentionally left blank.

Problem J-6

Problem Statement

Consider a compartment that is 15.2 m wide x 12.20 m long x 3.70 m height (50 ft wide x 40 ft long x 12 ft height) with two forced ventilation rates: 2.4 m³/s and 2.8 m³/s (5,000 cfm and 6,000 cfm). If a fire scenario arises with a fire power of 1,500 kW (1,422 Btu/sec), find the minimum thickness of gypsum board (boundary material) to prevent the hot gas temperature of reaching the failure temperature of the IEEE-383 unqualified cable [$T_g = 218\text{ }^\circ\text{C}$ (425 °F)] at 15 min after ignition.

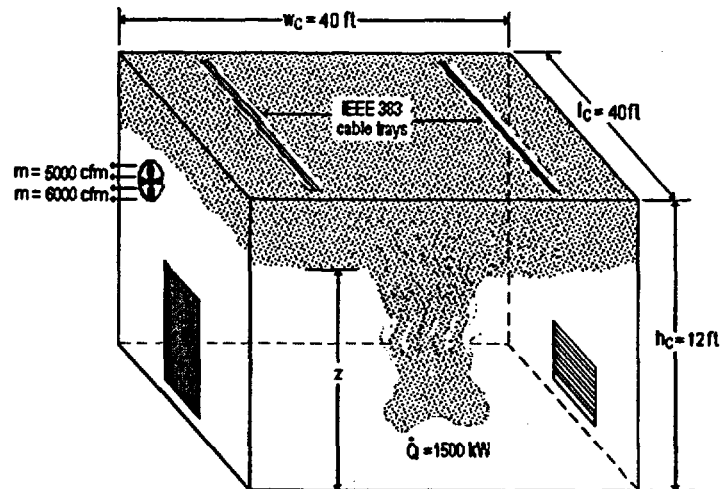

Problem 6: Compartment Fire with Forced Ventilation

Solution

Purpose:

- (1) Determine the minimum thickness of gypsum board to prevent $T_g = 425\text{ }^\circ\text{F}$ for two ventilation rates (5,000 cfm and 6,000 cfm) at 15 minutes after ignition.

Assumptions:

- (1) Air properties (ambient) are at 25 °C (77 °F).
- (2) Neglect the effect of the cable trays on the plume profile.
- (3) The heat flow through the compartment boundaries is one-dimensional.
- (4) The HRR is constant.
- (5) The fire is located at the center of the compartment or away from the walls.
- (6) The compartment is open to the outside at the inlet (pressure = 1 atm).

Spreadsheet (FDT[®]) Solution Procedure:

Use the following FDT[®]:

- (a) Temperature_FV1.xls (*Temperature-FV Thermally Thick* and *Temperature-FV Thermally Thin* will be required for this analysis)
- (b) Temperature_FV2.xls (*Temperature-FV Thermally Thick* and *Temperature-FV Thermally Thin* will be required for this analysis)

Note: Since the material thickness is unknown we have to consider the thermally thick and thermally thin possibilities for the solution. Also we are going to use both methods for forced ventilation scenarios (PFA and Deal & Beyler) to compare results.

FDT[®] Input Parameters:

Enter the following parameters in both spreadsheets (values only):

- Compartment Width (w_c) = 40 ft
- Compartment Length (l_c) = 40 ft
- Compartment Height (h_c) = 12 ft
- Interior Lining Thickness = 2 in (first trial and error value)
- Select Material: select **Gypsum Board** from the combo box
- Compartment ventilation rate (\dot{m}) = 5,000 cfm and 6,000 cfm
- Fire Heat Release Rate (\dot{Q}) = 1,500 kW

Note: When Gypsum Board is selected, its thermal properties are automatically selected from the table and entered in the corresponding input cells.

Results

This problem is solved using a trial and error procedure. Since we are looking for the minimum thickness to avoid that $T_g = 218\text{ °C } (425\text{ °F})$, we need to enter thickness values on the spreadsheets until get a hot gas layer temperature of $218\text{ °C } (425\text{ °F})$ at 15 minutes after ignition. We have to be careful using the FDT[®], because the material can be thick or thin and there is a specific spreadsheet for each case. For example, taking the case where the ventilation rate is $2.4\text{ m}^3/\text{s}$ (5,000 cfm), if we are using the thermally thick spreadsheet and during the trial and error process the minimum material thickness tends to be less or equal to 2.54 cm (1 in), we have to leave the thermally thick spreadsheet and go to the thermally thin spreadsheet to continue the trial and error process. The following table summarizes the trial and error procedure until get a reasonable solution.

| Ventilation rate \dot{m} (cfm) | Trial | Material Thickness (in) | Hot Gas Layer Temperature T_g (°F) | |
|-------------------------------------|-------|-------------------------|--------------------------------------|-------------------------|
| | | | Method of FPA | Method of Deal & Beyler |
| 5,000 | 1 | 2 | 451 | 566 |
| | 2 | 1 | 567 | 740 |
| | 3 | 0.5 | 459 | 584 |
| | 4 | 0.3 | 395 | 464 |
| | 5 | 0.35 | 413 | 499 |
| | 6 | 0.25 | 375 | 423 |
| 6,000 | 1 | 2 | 451 | 520 |
| | 2 | 1 | 536 | 660 |
| | 3 | 0.5 | 435 | 536 |
| | 4 | 0.3 | 375 | 435 |
| | 5 | 0.35 | 392 | 466 |
| | 6 | 0.25 | 356 | 400 |

*spreadsheet calculations attached on next page

Following the results of the FPA and Deal & Beyler method, we could say that any thickness above 0.635 cm (0.25 in) of gypsum board could provide enough heat loss to allow the hot gases reach the 200 °C (400 °F) at 15 minutes after a fire ignition with a HRR of 1,500 kW (1,422 Btu/sec).

Spreadsheet Calculations

Note: The following spreadsheets show the final result (or last trial) of the solution process. Only the 5,000 cfm case is shown, spreadsheet calculations for 6,000 cfm scenario are similar.

Method of Foote, Pagni, and Alvares (FPA)

CHAPTER 2 - PREDICTING HOT GAS LAYER TEMPERATURE IN ROOM FIRE WITH FORCED VENTILATION COMPARTMENT WITH THERMALLY THIN BOUNDARIES

The following calculations estimate the hot gas layer temperature and smoke layer height in enclosure fire. Parameters should be specified **ONLY IN THE YELLOW INPUT PARAMETER BOXES**. All subsequent output values are calculated by the spreadsheet and based on values specified in the input parameters. This spreadsheet is protected and secure to avoid errors due to a wrong entry in a cell(s). The chapter in the NUREG should be read before an analysis is made.

INPUT PARAMETERS

COMPARTMENT INFORMATION

| | | |
|-------------------------------|----------|-----------|
| Compartment Width (w_c) | 40.00 ft | 12.19 m |
| Compartment Length (l_c) | 40.00 ft | 12.19 m |
| Compartment Height (h_c) | 12.00 ft | 3.68 m |
| Interior Lining Thickness () | 0.25 in | 0.00635 m |

For thermally thin case the interior lining thickness should be less than or equal to 1 inch.

AMBIENT CONDITIONS

| | | |
|-----------------------------------|------------------------|----------|
| Ambient Air Temperature (T_a) | 77.00 °F | 25.00 °C |
| Specific Heat of Air (c_p) | 1.00 kJ/kg-K | 298.00 K |
| Ambient Air Density (ρ_a) | 1.20 kg/m ³ | |

THERMAL PROPERTIES OF COMPARTMENT ENCLOSING SURFACES

| | |
|--|---|
| Interior Lining Thermal Inertia ($k c$) | 0.18 (kW/m ² -K) ² -sec |
| Interior Lining Thermal Conductivity (k) | 0.00017 kW/m-K |
| Interior Lining Specific Heat (c) | 1.1 kJ/kg-K |
| Interior Lining Density () | 960 kg/m ³ |

THERMAL PROPERTIES FOR COMMON INTERIOR LINING MATERIALS

| Material | $k c$ (kW/m ² -K) ² -sec | k (kW/m-K) | c (kJ/kg-K) | (kg/m ³) | Select Material |
|------------------------|---|-----------------|------------------|----------------------|---|
| Aluminum (pure) | 500 | 0.206 | 0.895 | 2710 | Gypsum Board |
| Steel (0.5% Carbon) | 197 | 0.054 | 0.465 | 7850 | Scroll to desired material then Click on selection |
| Concrete | 2.9 | 0.0016 | 0.75 | 2400 | |
| Brick | 1.7 | 0.0008 | 0.8 | 2600 | |
| Glass, Plate | 1.6 | 0.00076 | 0.8 | 2710 | |
| Brick/Concrete Block | 1.2 | 0.00073 | 0.84 | 1900 | |
| Gypsum Board | 0.18 | 0.00017 | 1.1 | 960 | |
| Plywood | 0.16 | 0.00012 | 2.5 | 540 | |
| Fiber Insulation Board | 0.16 | 0.00053 | 1.25 | 240 | |
| Chipboard | 0.15 | 0.00015 | 1.25 | 800 | |
| Aerated Concrete | 0.12 | 0.00026 | 0.96 | 500 | |
| Plasterboard | 0.12 | 0.00016 | 0.84 | 950 | |
| Calcium Silicate Board | 0.098 | 0.00013 | 1.12 | 700 | |
| Alumina Silicate Block | 0.036 | 0.00014 | 1 | 260 | |
| Glass Fiber Insulation | 0.0018 | 3.7E-05 | 0.8 | 60 | |
| Expanded Polystyrene | 0.001 | 3.4E-05 | 1.5 | 20 | |

Reference: Kouts, J., J. Milke, *Principles of Smoke Management*, 2002 Page 270.

COMPARTMENT MASS VENTILATION FLOW RATE

Forced Ventilation Flow Rate (m)

5000.00 cfm

2.360 m³/sec

2.832 kg/sec

FIRE SPECIFICATIONS

Fire Heat Release Rate (Q)

1500.00 kW

METHOD OF FOOTE, PAGNI, AND ALVARES (FPA)Reference: *SFPE Handbook of Fire Protection Engineering*, 2nd Edition, 1995, Page 3-140.

$$\Delta T_g/T_a = 0.63(Q/mc_p T_a)^{0.72} (h_k A_T/mc_p)^{-0.36}$$

Where $\Delta T_g = T_g - T_a$ = upper layer gas temperature rise above ambient (K)
 T_a = ambient air temperature (K)
 Q = heat release rate of the fire (kW)
 m = compartment mass ventilation flow rate (kg/sec)
 c_p = specific heat of air (kJ/kg-K)
 h_k = convective heat transfer coefficient (kW/m²-K)
 A_T = total area of the compartment enclosing surface boundaries (m²)

Thermal Penetration Time Calculation

Thermally Thin Material

$$t_p = (\rho c_p/k)(\delta/2)^2$$

Where ρ = interior construction density (kg/m³)
 c_p = interior construction heat capacity (kJ/Kg-K)
 k = interior construction thermal conductivity (kW/m-K)
 δ = interior construction thickness (m)

$$t_p = 62.62 \text{ sec}$$

Heat Transfer Coefficient Calculation

$$h_k = k/\delta \quad \text{for } t > t_p$$

Where k = interior construction thermal conductivity (kW/m-K)
 δ = interior construction thickness (m)

$$h_k = 0.03 \text{ kW/m}^2\text{-K}$$

Area of Compartment Enclosing Surface Boundaries

$$A_T = 2(w_c \times l_c) + 2(h_c \times w_c) + 2(h_c \times l_c)$$

$$A_T = 475.66 \text{ m}^2$$

Compartment Hot Gas Layer Temperature With Forced Ventilation

$$\Delta T_g/T_a = 0.63(Q/mc_p T_a)^{0.72} (h_k A_T/mc_p)^{-0.36}$$

$$\Delta T_g/T_a = 0.55$$

$$\Delta T_g = 165.34 \text{ K}$$

$$\Delta T_g = T_g - T_a$$

$$T_g = \Delta T_g + T_a$$

$$T_g = 463.34 \text{ K}$$

$$T_g = 190.34 \text{ }^\circ\text{C} \quad 374.61 \text{ }^\circ\text{F} \quad \text{ANSWER}$$

NOTE

The above calculations are based on principles developed in the SFPE Handbook of Fire Protection Engineering, 2nd Edition, 1995.

Calculations are based on certain assumptions and have inherent limitations. The results of such calculations may or may not have reasonable predictive capabilities for a given situation, and should only be interpreted by an informed user.

Although each calculation in the spreadsheet has been verified with the results of hand calculation, there is no absolute guarantee of the accuracy of these calculations.

Any questions, comments, concerns, and suggestions, or to report an error(s) in the spreadsheet, please send an email to nxi@nrc.gov.



Office of Nuclear Reactor Regulation

Method of Deal & Beyler

**CHAPTER 2 - PREDICTING HOT GAS LAYER TEMPERATURE
IN ROOM FIRE WITH FORCED VENTILATION
COMPARTMENT WITH THERMALLY THIN BOUNDARIES**

The following calculations estimate the hot gas layer temperature and smoke layer height in enclosure fire. Parameters should be specified **ONLY IN THE YELLOW INPUT PARAMETER BOXES**. All subsequent output values are calculated by the spreadsheet and based on values specified in the input parameters. This spreadsheet is protected and secure to avoid errors due to a wrong entry in a cell(s). The chapter in the NUREG should be read before an analysis is made.

INPUT PARAMETERS

COMPARTMENT INFORMATION

| | | |
|-------------------------------|----------|-----------|
| Compartment Width (w_c) | 40.00 ft | 12.19 m |
| Compartment Length (l_c) | 40.00 ft | 12.19 m |
| Compartment Height (h_c) | 12.00 ft | 3.66 m |
| Interior Lining Thickness () | 0.25 in | 0.00635 m |

For thermally thin case the interior lining thickness should be less than or equal to 1 inch.

AMBIENT CONDITIONS

| | | |
|-----------------------------------|------------------------|----------|
| Ambient Air Temperature (T_a) | 82.00 °F | 27.78 °C |
| Specific Heat of Air (c_p) | 1.00 kJ/kg-K | 300.78 K |
| Ambient Air Density (ρ_a) | 1.20 kg/m ³ | |

THERMAL PROPERTIES OF COMPARTMENT ENCLOSING SURFACES

| | |
|--|---|
| Interior Lining Thermal Inertia ($k c$) | 0.18 (kW/m ² -K) ² -sec |
| Interior Lining Thermal Conductivity (k) | 0.00017 kW/m-K |
| Interior Lining Specific Heat (c) | 1.1 kJ/kg-K |
| Interior Lining Density () | 960 kg/m ³ |

THERMAL PROPERTIES FOR COMMON INTERIOR LINING MATERIALS

| Material | $k c$ (kW/m ² -K) ² -sec | k (kW/m-K) | c (kJ/kg-K) | (kg/m ³) |
|------------------------|---|-----------------|------------------|----------------------|
| Aluminum (pure) | 500 | 0.206 | 0.895 | 2710 |
| Steel (0.5% Carbon) | 197 | 0.054 | 0.465 | 7850 |
| Concrete | 2.9 | 0.0016 | 0.75 | 2400 |
| Brick | 1.7 | 0.0008 | 0.8 | 2600 |
| Glass, Plate | 1.6 | 0.00076 | 0.8 | 2710 |
| Brick/Concrete Block | 1.2 | 0.00073 | 0.84 | 1900 |
| Gypsum Board | 0.18 | 0.00017 | 1.1 | 960 |
| Plywood | 0.16 | 0.00012 | 2.5 | 540 |
| Fiber Insulation Board | 0.16 | 0.00053 | 1.25 | 240 |
| Chipboard | 0.15 | 0.00015 | 1.25 | 800 |
| Aerated Concrete | 0.12 | 0.00026 | 0.96 | 500 |
| Plasterboard | 0.12 | 0.00016 | 0.84 | 950 |
| Calcium Silicate Board | 0.098 | 0.00013 | 1.12 | 700 |
| Alumina Silicate Block | 0.036 | 0.00014 | 1 | 260 |
| Glass Fiber Insulation | 0.0018 | 3.7E-05 | 0.8 | 60 |
| Expanded Polystyrene | 0.001 | 3.4E-05 | 1.5 | 20 |

Select Material

 Scroll to desired material then
 Click on selection

Reference: Klotz, J., J. Milke, *Principles of Smoke Management*, 2002, Page 270.

COMPARTMENT MASS VENTILATION FLOW RATE

Forced Ventilation Flow Rate (m)

5000.00 cfm

2.360 m³/sec

2.832 kg/sec

FIRE SPECIFICATIONS

Fire Heat Release Rate (Q)

1500.00 kW

METHOD OF DEAL AND BEYLERReference: SFPE Handbook of Fire Protection Engineering, 3rd Edition, 2002, Page 3-178.

$$\Delta T_g = Q / (m c_p + h_k A_T)$$

Where $\Delta T_g = T_g - T_a$ = upper layer gas temperature rise above ambient (K)
 T_a = ambient air temperature (K)
 Q = heat release rate of the fire (kW)
 m = compartment mass ventilation flow rate (kg/sec)
 c_p = specific heat of air (kJ/kg-K)
 h_k = convective heat transfer coefficient (kW/m²-K)
 A_T = total area of the compartment enclosing surface boundaries (m²)

Heat Transfer Coefficient Calculation

$$h_k = 0.4 (k/\delta) \text{ for } t > t_p$$

Where k = thermal conductivity of interior lining (kW/m-K)
 (a thermal property of material responsible for the rate of temperature rise)
 δ = thickness of interior lining (m)

$$h_k = 0.011 \text{ kW/m}^2\text{-K}$$

Area of Compartment Enclosing Surface Boundaries

$$A_T = 2(w_c \times l_c) + 2(h_c \times w_c) + 2(h_c \times l_c)$$

$$A_T = 475.66 \text{ m}^2$$

Compartment Hot Gas Layer Temperature With Forced Ventilation

$$\Delta T_g = Q / (m c_p + h_k A_T)$$

$$\Delta T_g = T_g - T_a \quad 189.26$$

$$T_g = 490.04 \text{ K}$$

$$T_g = 217.04 \text{ }^\circ\text{C} \quad 422.677 \text{ }^\circ\text{F} \quad \text{ANSWER}$$

NOTE

The above calculations are based on principles developed in the SFPE Handbook of Fire Protection Engineering, 3rd Edition, 2002.

Calculations are based on certain assumptions and have inherent limitations. The results of such calculations may or may not have reasonable predictive capabilities for a given situation, and should only be interpreted by an informed user.

Although each calculation in the spreadsheet has been verified with the results of hand calculation, there is no absolute guarantee of the accuracy of these calculations.

Any questions, comments, concerns, and suggestions, or to report an error(s) in the spreadsheet, please send an email to nxi@nrc.gov.



Office of Nuclear Reactor Regulation

Problem J-7

Problem Statement

Consider a compartment with an open vent that allows the air entrance at 3.60 m/s (700 ft/min). Assume that heptane from a tank spills on the concrete floor forming a 113.0 m² (126 ft²) pool. The edge to edge distance from the pool fire to a certain target is about 9.0 m (30 ft). The target is 3 m (10 ft) above ground. Calculate the flame radiative heat flux at ground level using the solid flame model.

Solution

Purpose:

- (1) Calculate the radiant heat flux from the pool fire to the target using the solid flame radiation model and considering the effect of the wind.

Assumptions:

- (1) The pool is circular or nearly circular.
- (2) The correlation for solid flame radiation model is suitable for heptane.

Spreadsheet (FDT[®]) Solution Procedure:

Use the following FDT[®]:

- (a) Heat_Flux_Calculations_Wind.xls (select *Solid Flame 2*)

FDT[®] Input Parameters:

Enter the following parameters in the spreadsheet (values only):

- Fuel Spill Area or Dike Area (A_{dike}) = 1,261 ft²
- Distance between Fire and Target (L) = 30 ft
- Vertical Distance of Target from Ground Level ($H_t = H_{t1}$) = 10 ft
- Wind Speed or Velocity (u_w) = 700 ft/min
- Select Fuel Type: select Heptane from the combo box

Note: When Heptane is selected, its thermal properties are automatically selected from the table and entered in the corresponding input cells.

Results

| Radiation Model | Radiant Heat Flux* \dot{q}'' kW/m ² (Btu/ft ² -sec) |
|-----------------|---|
| Solid Flame | 10.54 (0.93) |

*spreadsheet calculations attached on next page

Spreadsheet Calculations

CHAPTER 5 - ESTIMATING RADIANT HEAT FLUX FROM FIRE TO A TARGET FUEL ABOVE GROUND LEVEL IN PRESENCE OF WIND (TILTED FLAME) SOLID FLAME RADIATION MODEL

The following calculations estimate the radiative heat flux from a fire to a target fuel in the presence of wind. The purpose of this calculation is to estimate the radiation transmitted from a burning fuel array to a target fuel positioned some distance from the fire above ground level to determine if secondary ignitions are likely in presence of wind. Parameters should be specified ONLY IN THE RED INPUT PARAMETER BOXES. All subsequent output values are calculated by the spreadsheet and based on values specified in the input parameters. This spreadsheet is protected and secure to avoid errors due to a wrong entry in a cell(s). The chapter in the NUREG should be read before an analysis is made.

INPUT PARAMETERS

| | | |
|--|------------------------------|-----------------------|
| Mass Burning Rate of Fuel (\dot{m}) | 0.101 kg/m ² -sec | |
| Effective Heat of Combustion of Fuel ($H_{c,eff}$) | 44600 kJ/kg | |
| Fuel Area or Dike Area (A_{fuel}) | 1281.00 ft ² | 117.15 m ² |
| Distance between Fire and Target (L) | 30.00 ft | 9.144 m |
| Vertical Distance of Target from Ground Level ($H_t = H_{t1}$) | 10.00 ft | 3.048 m |
| Wind Speed or Velocity (u_w) | 700 ft/min | 3.58 m/sec |
| Gravitational Acceleration (g) | 9.81 m/sec ² | |
| Ambient Air Density (ρ_a) | 1.20 kg/m ³ | |
| Density of Combustion Products (ρ_c) | 0.28 kg/m ³ | |

THERMAL PROPERTIES DATA

BURNING RATE DATA FOR FUELS

| Fuel | Mass Burning Rate m ² (kg/m ² -sec) | Heat of Combustion $H_{c,eff}$ (kJ/kg) |
|------------------------------|--|---|
| Methanol | 0.017 | 20,000 |
| Ethanol | 0.015 | 26,800 |
| Butane | 0.078 | 45,700 |
| Benzene | 0.085 | 40,100 |
| Hexane | 0.074 | 44,700 |
| Heptane | 0.101 | 44,600 |
| Xylene | 0.09 | 40,800 |
| Acetone | 0.041 | 25,800 |
| Dioxane | 0.018 | 26,200 |
| Diethyl Ether | 0.085 | 34,200 |
| Benzine | 0.048 | 44,700 |
| Gasoline | 0.055 | 43,700 |
| Kerosene | 0.039 | 43,200 |
| Diesel | 0.045 | 44,400 |
| JP-4 | 0.051 | 43,500 |
| JP-5 | 0.054 | 43,000 |
| Transformer Oil, Hydrocarbon | 0.039 | 46,000 |
| Fuel Oil, Heavy | 0.035 | 39,700 |
| Crude Oil | 0.0335 | 42,600 |
| Lube Oil | 0.039 | 46,000 |
| Douglas Fir Plywood | 0.01082 | 10,900 |

Select Fuel Type

Heptane
Scroll to desired fuel type then Click on selection

Reference: SFPE Handbook of Fire Protection Engineering, 2nd Edition, 1995, Page 3-2.

ESTIMATING RADIATIVE HEAT FLUX TO A TARGET FUEL IN PRESENCE OF WIND

Reference: SFPE Handbook of Fire Protection Engineering, 3rd Edition, 1995, Page 3-272.

SOLID FLAME RADIATION MODEL IN PRESENCE OF WIND

$$q'' = EF_{1 \rightarrow 2}$$

Where

 q'' = incident radiative heat flux on the target (kW/m²)E = emissive power of the pool fire flame (kW/m²) $F_{1 \rightarrow 2}$ = view factor between target and the flame in presence of wind**Pool Fire Diameter Calculation**

$$\begin{aligned} \text{Adike} &= \rho D^2/4 \\ D &= \sqrt{4 \text{Adike}/\rho} \\ D &= 12.21314646 \text{ m} \end{aligned}$$

Pool Fire Radius Calculation

$$\begin{aligned} r &= D/2 \\ r &= 6.106573231 \text{ m} \end{aligned}$$

Flame Emissive Power Calculation

$$\begin{aligned} E &= 58 (10 - 0.00823 D) \\ E &= 46.01652277 \text{ (kW/m}^2\text{)} \end{aligned}$$

View Factor Calculation in Presence of Wind

$$\begin{aligned} p_{F_{1 \rightarrow 2}, V_1} &= \text{See Equation 5-19} \\ p_{F_{1 \rightarrow 2}, V_2} &= \text{See Equation 5-20} \\ A_1 &= a_1^2 + (b+1)^2 - 2a_1(b+1)\sin q \\ A_2 &= a_2^2 + (b+1)^2 - 2a_2(b+1)\sin q \\ B_1 &= a_1^2 + (b-1)^2 - 2a_1(b-1)\sin q \\ B_2 &= a_2^2 + (b-1)^2 - 2a_2(b-1)\sin q \\ C &= 1 + (b^2 - 1)\cos 2q \\ a_1 &= 2H_f1/r = 2H_1/r \\ a_2 &= 2H_f2/r = 2(H_f - H_f1)/r \\ b &= R/r \\ F_{1 \rightarrow 2, V} &= F_{1 \rightarrow 2, V_1} + F_{1 \rightarrow 2, V_2} \end{aligned}$$

Where

 $F_{1 \rightarrow 2, V}$ = total vertical view factor in presence of wind

R = distance from center of the pool fire to edge of the target (m)

 H_f = height of the pool fire flame (m)

r = pool fire radius (m)

q = flame tilt or angle of deflection (radians)

Distance from Center of the Pool Fire to Edge of the Target Calculation

$$R = L + r = 15.25057323 \text{ m}$$

Heat Release Rate Calculation

$$\begin{aligned} Q &= m^* D H_c A_f \\ Q &= 527717.1939 \text{ kW} \end{aligned}$$

Pool Fire Flame Height Calculation

$$H_f = 55 D (m^3 / (v(g D)))^{0.47} (u^*)^{0.21}$$

Where m^* = mass burning rate of fuel (kg/m²-sec)
 D = pool fire diameter (m)
 ρ_a = ambient air density (kg/m³)
 g = gravitational acceleration (m/sec²)
 u^* = nondimensional wind velocity

Nondimensional Wind Velocity Calculation

$$u^* = u_w / (g m^* D / \rho_c)^{1/3}$$

Where u_w = wind velocity (m/sec)
 g = gravitational acceleration (m/sec²)
 m^* = mass burning rate of fuel (kg/m²-sec)
 D = pool fire diameter (m)
 ρ_c = density of combustion products (kg/m³)

$$u^* = u_w / (g m^* D / \rho_c)^{1/3}$$

$$u^* = 1.013$$

$$H_f = 55 D (m^3 / (v(g D)))^{0.47} (u^*)^{0.21}$$

$$H_f = 25.68 \text{ m}$$

Flame Tilt or Angle of Deflection Calculation

$$\text{COS} = 1 \quad \text{for } u^* = 1$$

$$\text{COS} = 1 / (u^*) \quad \text{for } u^* = 1$$

Since $u^* = 1$

| | | |
|---------------------------------------|-----------|-------------|
| $\theta = \text{ACOS}(1/(u^*)^{0.5})$ | 0.115 Rad | 6.58 degree |
| | 0.115 Rad | 6.58 degree |
| | 0 Rad | 0.00 degree |

| | |
|--|-------|
| $A_1 = a_1^2 + (b+1)^2 - 2a_1(b+1) \sin$ | 12.43 |
| $A_2 = a_2^2 + (b+1)^2 - 2a_2(b+1) \sin$ | 61.22 |
| $B_1 = a_1^2 + (b-1)^2 - 2a_1(b-1) \sin$ | 2.90 |
| $B_2 = a_2^2 + (b-1)^2 - 2a_2(b-1) \sin$ | 54.62 |
| $C = 1 + (b^2 - 1) \text{Cos}^2$ | 6.17 |
| $a_1 = 2H_1/r = 2H_1/r =$ | 1.00 |
| $a_2 = 2H_2/r = 2(H_2 - H_1)/r =$ | 7.41 |
| $b = R/r =$ | 2.50 |

| | | | | | | | | | |
|---|---------|----------|----------|----------|-------|----------|----------|----------|---------------------------|
| $F_{1 \rightarrow 2, v1}$ | 0.13579 | F_{v1} | F_{v2} | F_{v3} | F_w | F_{v6} | F_{v8} | F_{v7} | $F_{1 \rightarrow 2, v1}$ |
| $F_{1 \rightarrow 2, v2}$ | 0.09325 | 0.416 | 1.277 | 0.935 | 0.400 | 0.321 | 0.105 | 0.241 | 0.135788 |
| $F_{1 \rightarrow 2} = F_{1 \rightarrow 2, v1} + F_{1 \rightarrow 2, v2} =$ | 0.22904 | F_{v1} | F_{v2} | F_{v3} | F_w | F_{v6} | F_{v8} | F_{v7} | $F_{1 \rightarrow 2, v2}$ |
| | | 4.467 | 1.002 | 0.606 | 0.400 | 0.321 | 0.105 | 2.588 | 0.093251 |

Radiative Heat Flux Calculation in Presence of Wind

$$q^* = EF_{1 \rightarrow 2}$$

| | | | |
|---------|-------------------------|----------------------------|--------|
| $q^* =$ | 10.54 kW/m ² | 0.93 BTU/r ² -s | ANSWER |
|---------|-------------------------|----------------------------|--------|

CRITICAL HEAT FLUX FOR CABLE FAILURE

| Cable Type | Damage Threshold Heat Flux (kW/m ²) |
|----------------------|--|
| IEEE-383 qualified | 10 |
| IEEE-383 unqualified | 5 |

Reference: EPRI TR-100370, Fire-Induced Vulnerability Evaluation (FIVE), April 1992, page 10.4-7.

NOTE

The above calculations are based on principles developed in the SFPE Handbook of Fire Protection Engineering, 3rd Edition, 2002.

Calculations are based on certain assumptions and have inherent limitations. The results of such calculations may or may not have reasonable predictive capabilities for a given situation, and should only be interpreted by an informed user.

Although each calculation in the spreadsheet has been verified with the results of hand calculation, there is no absolute guarantee of the accuracy of these calculations.

Any questions, comments, concerns, and suggestions, or to report an error(s) in the spreadsheet, please send an email to nxi@nrc.gov.



This page was intentionally left blank

Problem J-8

Problem Statement

Consider a compartment that has been insulated with 1.27 cm (½ in) of gypsum board, wallboard (S142M). If a pool fire scenario arises with a heat flux of 75 kW/m², what will be the ignition time of the gypsum board?

Solution

Purpose:

- (1) Calculate the ignition time of Gypsum Board, Wallboard (S142M) for the given conditions.

Assumptions:

- (1) The material is infinitely thick.

Spreadsheet (FDT[®]) Solution Procedure:

Use the following FDT[®]:

- (a) Ignition_Time_Calculations.xls (select *Ignition_Time_Calculations1*)

FDT[®] Input Parameters:

Enter the following parameters in the spreadsheet (values only):

-Exposure or External Radiative Heat Flux to Target Fuel (\dot{q}_e) = 75 kW/m²

-Select Material: select **Gypsum Board, Wallboard (S142M)** from the combo box

Note: When **Gypsum Board, Wallboard (S142M)** is selected, its thermal properties are automatically selected from the table and entered in the corresponding input cells.

Results

| Calculation Method | Ignition Time* t_{ig} (min) |
|--------------------------|----------------------------------|
| Mikkola and Wichmann | 0.34 min |
| Quintiere and Harkleroad | 0.20 min |
| Janssens | 0.86 min |

*spreadsheet calculations attached on next page

Spreadsheet Calculations

CHAPTER 6 - ESTIMATING THE IGNITION TIME OF A TARGET FUEL EXPOSED TO A CONSTANT RADIATIVE HEAT FLUX

The following calculations estimate time to ignition for flame spread of solid fuels exposed to a constant external radiative heat flux. Parameters should be specified ONLY IN THE YELLOW INPUT PARAMETER BOXES. All subsequent output values are calculated by the spreadsheet and based on values specified in the input parameters. This spreadsheet is protected and secure to avoid errors due to a wrong entry in a cell(s). The chapter in the NUREG should be read before an analysis is made.

INPUT PARAMETERS

MATERIAL FLAME SPREAD PROPERTIES

Material Ignition Temperature (T_i)
 Material Thermal Inertia ($k \cdot c$)
 Material Critical Heat Flux for Ignition (q''_{crit})
 Flame Spread Parameter b
 Exposure or External Radiative Heat Flux (q''_e)
 Ambient Air Temperature (T_a)
 Heat Transfer Coefficient at Ignition (h_c)

| | |
|--------|--|
| 412.00 | °C |
| 0.57 | (kW/m ² ·K) ² ·sec |
| 18.00 | kW/m ² |
| 0.07 | (s) ^{1/2} |
| 75.00 | kW/m ² |
| 77.00 | °F |
| 0.0275 | kW/m ² ·K |

28.00 °C

FLAME SPREAD PROPERTIES OF COMMON MATERIALS

| Materials | Ignition Temperature T_i (°C) | Thermal Inertia $k \cdot c$ (kW/m ² ·K) ² ·sec | Critical Heat Flux q''_{crit} (kW/m ²) | Flame Spread Parameter b (s) ^{1/2} | Select Material |
|---------------------------------------|------------------------------------|---|---|--|--|
| PMMA Polycast (1.59 mm) | 278 | 0.73 | 9 | 0.04 | Gypsum Board, Wallboard (S142M) Scroll to desired material then Click on selection |
| Hardboard (6.35 mm) | 298 | 1.87 | 10 | 0.03 | |
| Carpet (Acrylic) | 300 | 0.42 | 10 | 0.08 | |
| Fiber Insulation Board | 355 | 0.46 | 14 | 0.07 | |
| Hardboard (3.175 mm) | 365 | 0.88 | 14 | 0.05 | |
| PMMA Type G (1.27 cm) | 378 | 1.02 | 15 | 0.05 | |
| Asphalt Shingle | 378 | 0.7 | 15 | 0.08 | |
| Douglas Fire Particle Board (1.27 cm) | 382 | 0.94 | 16 | 0.05 | |
| Plywood Plain (1.27 cm) | 390 | 0.54 | 16 | 0.07 | |
| Plywood Plain (0.635 cm) | 390 | 0.46 | 16 | 0.07 | |
| Foam Flexible (2.54 cm) | 390 | 0.32 | 16 | 0.09 | |
| GRP (2.24 mm) | 390 | 0.32 | 16 | 0.09 | |
| Hardboard (Gloss Paint) (3.4 mm) | 400 | 1.22 | 17 | 0.05 | |
| Hardboard Nitrocellulose Paint) | 400 | 0.79 | 17 | 0.08 | |
| GRP (1.14 mm) | 400 | 0.72 | 17 | 0.08 | |
| Particle Board (1.27 cm Stock) | 412 | 0.93 | 18 | 0.05 | |
| Carpet (Nylon/Wool Blend) | 412 | 0.68 | 18 | 0.08 | |
| Gypsum Board, Wallboard (S142M) | 412 | 0.57 | 18 | 0.07 | |
| Carpet # 2 (Wool Untreated) | 435 | 0.25 | 20 | 0.11 | |
| Foam Rigid (2.54 cm) | 435 | 0.03 | 20 | 0.32 | |
| Fiberglass Shingle | 445 | 0.5 | 21 | 0.08 | |
| Polyisocyanurate (5.08 cm) | 445 | 0.02 | 21 | 0.36 | |
| Carpet # 2 (Wool Treated) | 455 | 0.24 | 22 | 0.12 | |
| Carpet # 1 (Wool, Stock) | 465 | 0.11 | 23 | 0.18 | |
| Aircraft Panel Epoxy Fiberite | 505 | 0.24 | 28 | 0.13 | |
| Gypsum Board FR (1.27 cm) | 510 | 0.4 | 28 | 0.1 | |
| Polycarbonate (1.52 mm) | 528 | 1.16 | 30 | 0.06 | |
| Gypsum Board (Common) (1.27 mm) | 565 | 0.45 | 35 | 0.11 | |
| Plywood FR (1.27 cm) | 620 | 0.76 | 44 | 0.1 | |
| Polystyrene (5.08 cm) | 630 | 0.38 | 46 | 0.14 | |

Reference: SFPE Engineering Guide, "Predicted Ignition of Solid Materials Under Radiant Exposure," 2002, Page 14.

**METHOD OF MIKKOLA AND WICHMAN
THERMALLY THICK MATERIALS**

Reference: SFPE Engineering Guide, "Piloted Ignition of Solid Materials Under Radiant Exposure," 2002, Page 7.

$$t_{ig} = \pi/4 kpc (T_{ig} - T_a)^2 / (q_e'' - q_{critical}'')^2$$

Where
 t_{ig} = material ignition time (sec)
 kpc = material thermal inertia (kW/m²-K)²-sec
 T_{ig} = material ignition temperature (°C)
 T_a = ambient air temperature (°C)
 q_e'' = exposure or external heat flux (kW/m²)
 $q_{critical}''$ = material critical heat flux for ignition (kW/m²)

$$t_{ig} = \pi/4 kpc (T_{ig} - T_a)^2 / (q_e'' - q_{critical}'')^2$$

t_{ig} = 20.64 sec 0.34 minute ANSWER

**METHOD OF QUINTIERE AND HARKLEROAD
THERMALLY THICK MATERIALS**

Reference: SFPE Engineering Guide, "Piloted Ignition of Solid Materials Under Radiant Exposure," 2002, Page 12.

$$t_{ig} = (q_{critical}'' / b q_e'')^2$$

Where
 t_{ig} = material ignition time (sec)
 $q_{critical}''$ = material critical heat flux for ignition (kW/m²)
 b = flame spread parameter (s)^{-1/2}
 q_e'' = exposure or external heat flux (kW/m²)

$$t_{ig} = (q_{critical}'' / b q_e'')^2$$

t_{ig} = 11.76 sec 0.20 minute ANSWER

**METHOD OF JANSSENS
THERMALLY THICK MATERIALS**

Reference: SFPE Engineering Guide, "Piloted Ignition of Solid Materials Under Radiant Exposure," 2002, Page 15.

$$t_{ig} = 0.563 (kpc / h_{ig}^2) ((q_e'' / q_{critical}'') - 1)^{-1.25}$$

Where
 t_{ig} = material ignition time (sec)
 kpc = material thermal inertia (kW/m²-K)²-sec
 h_{ig} = heat transfer coefficient at ignition (kW/m²-K)
 q_e'' = exposure or external heat flux (kW/m²)
 $q_{critical}''$ = material critical heat flux for ignition (kW/m²)

$$t_{ig} = 0.563 (kpc / h_{ig}^2) ((q_e'' / q_{critical}'') - 1)^{-1.25}$$

t_{ig} = 51.48 sec 0.86 minute ANSWER

SUMMARY OF RESULTS

| | |
|------------------------------------|-------------|
| METHOD OF MIKKOLA AND WICHMAN | 0.34 minute |
| METHOD OF QUINTIERE AND HARKLEROAD | 0.20 minute |
| METHOD OF JANSSENS | 0.86 minute |

NOTE

The above calculations are based on principles developed in the SFPE Engineering Guide "Piloted Ignition of Solid Materials Under Radiant Exposure," January 2002. Calculations are based on certain assumptions and have inherent limitations. The results of such calculations may or may not have reasonable predictive capabilities for a given situation, and should only be interpreted by an informed user. Although each calculation in the spreadsheet has been verified with the results of hand calculation, there is no absolute guarantee of the accuracy of these calculations. Any questions, comments, concerns, and suggestions, or to report an error(s) in the spreadsheet, please send an email to nrc@nrc.gov.



This page intentionally left blank.

Problem J-9

Problem Statement

A 75.0 liters (20 gallons) trash bag exposure fire source is located 3.0 m (10.0 ft) beneath a horizontal cable tray. Assume that the trash fire ignites an area of approximately 1.0 m² (11.0 ft²) of the cable tray, and the cables in the tray are IEEE-383 qualified XPE/FRPE cables. Compute the full-scale HRR, (\dot{Q}_f) of the XPE/FRPE cable insulation. The bench scale HRR (\dot{Q}_f) of the XPE/FRPE is 475 kW/m².

Solution

Purpose:

- (1) Calculate the full-scale HRR of the XPE/FRPE for the given scenario.

Assumptions:

- (1) Lee's correlation is valid for this fire scenario.

Spreadsheet (FDT³) Solution Procedure:

Use the following FDT³:

- (a) Cable_HRR_Calculations.xls

FDT³ Input Parameters:

Enter the following parameters in the spreadsheet (values only):

- Exposure Cable Tray Burning Area (A_f) = 11 ft²
- Select Cable Type: select XPE/FRPE from the combo box

Note: When XPE/FRPE is selected, its thermal properties are automatically selected from the table and entered in the corresponding input cells.

Results

| Cable Insulation | Full Scale HRR \dot{Q}_f kW (Btu/sec) |
|------------------|---|
| XPE/FRPE | 218 (207) |

*spreadsheet calculations attached on next page.

Spreadsheet Calculations

CHAPTER 7 - ESTIMATING FULL-SCALE HEAT RELEASE RATE OF A CABLE TRAY FIRE

The following calculations estimate the full-scale cable tray heat release rate. Parameters should be specified **ONLY IN THE YELLOW INPUT PARAMETER BOXES**. All subsequent output values are calculated by the spreadsheet and based on values specified in the input parameters. This spreadsheet is protected and secure to avoid errors due to a wrong entry in a cell(s). The chapter in the NUREG should be read before an analysis is made.

INPUT PARAMETERS

| | | | | |
|---|-------|-------------------|--|----------------|
| Cable Bench-Scale HRR (Q_{bs}) | 475 | kW/m ² | | |
| Exposed Cable Tray Burning Area (A_t) | 11.00 | ft ² | | 1.022 |
| | | | | m ² |

**HEAT RELEASE RATE DATA FOR CABLE TRAY FIRE
BENCH-SCALE HRR OF CABLE TRAY FIRE**

| Cable Type | Bench-Scale HRR per Unit Floor Area Q_{bs} (kW/m ²) |
|---------------------------------|---|
| ld PE | 1071 |
| PE/PVC | 589 |
| XPE/FRXPE | 475 |
| PE/PVC | 395 |
| PE/PVC | 359 |
| XPE/Neoprene | 354 |
| PE, PP/Cl.S.PE | 345 |
| PE/PVC | 312 |
| XPE/Neoprene | 302 |
| PE, PP/Cl.S.PE | 299 |
| PE, PP/Cl.S.PE | 271 |
| FRXPE/Cl.S.PE | 258 |
| PE, Nylon/PVC, Nylon | 231 |
| PE, Nylon/PVC, Nylon | 218 |
| XPE/Cl.S.PE | 204 |
| Silicone, glass braid, asbestos | 182 |
| XPE/XPE | 178 |
| PE, PP/Cl.S.PE | 177 |
| Silicone, glass braid | 128 |
| Teflon | 98 |

Select Cable Type

 Scroll to desired cable type then Click on selection

Reference: "Categorization of Cable Flammability, Part 1: Laboratory Evaluation of Cable Flammability Parameters," EPRI Research Project 1165-1, NP-1200, Part 1.

ESTIMATING FULL-SCALE CABLE TRAY HEAT RELEASE RATE

Reference: *SFPE Handbook of Fire Protection Engineering*, 2nd Edition 1995, Page 3-12.

$Q_{fs} = 0.45 Q_{bs} A_t$

Where Q_{fs} = cable tray full-scale HRR (kW)
 Q_{bs} = cable tray bench-scale HRR (kW)
 A_t = exposed cable tray burning area (m²)

Heat Release Rate Calculation

$Q_{fs} = 0.45 Q_{bs} A_t$

$Q_{fs} =$ **218.44 kW** **207.04 BTU/sec** **ANSWER**

NOTE

The above calculations are based on principles developed in the SFPE Handbook of Fire Protection Engineering, 2nd Edition, 1995.

Calculations are based on certain assumptions and has inherent limitations. The results of such calculations may or may not have reasonable predictive capabilities for a given situation, and should only be interpreted by an informed user.

Although each calculation in the spreadsheet has been verified with the results of hand calculation, there is no absolute guarantee of the accuracy of these calculations.

Any questions, comments, concerns, and suggestions, or to report an error(s) in the spreadsheet, please send an email to nxi@nrc.gov.



Office of Nuclear Reactor Regulation

This page intentionally left blank.

Problem J-10

Problem Statement

Estimate the maximum plume temperature ($T_{p(\text{centerline})}$) at the ceiling of a 6.0 m (20.0 ft) high compartment above a 1,420 kW fire involving a 1½ ft high stack of wood pallets in a 0.92 m² (10.0 ft²) pallet area. Assume that the ambient temperature is 25 °C (77 °F).

Solution

Purpose:

- (1) Estimate the maximum plume temperature for the given fire scenario.

Assumptions:

- (1) All heat is released at a point.
- (2) Buoyant forces are more significant than momentum forces.

Spreadsheet (FDT[®]) Solution Procedure:

Use the following FDT[®]:

- (a) Plume_Temperature_Calculations.xls

FDT[®] Input Parameters:

Enter the following parameters in the spreadsheet (values only):

- Heat Release Rate (\dot{Q}) = 1,420 kW
- Distance from the Top of the Fuel to the Ceiling (z) = 20 ft
- Area of Combustible Fuel = 10 ft²

Results

| Heat Release Rate \dot{Q} (kW) | Plume Centerline Temperature $T_{p(\text{centerline})}$ °C (°F) |
|-------------------------------------|--|
| 1,420 | 135 (276) |

*spreadsheet calculations attached on next page.

Spreadsheet Calculations

CHAPTER 9 - ESTIMATING CENTERLINE TEMPERATURE OF A BUOYANT FIRE PLUME

The following calculations estimate the centerline plume temperature in a compartment fire. Parameters should be specified ONLY IN THE YELLOW INPUT PARAMETER BOXES. All subsequent output values are calculated by the spreadsheet and based on values specified in the input parameters. This spreadsheet is protected and secure to avoid errors due to a wrong entry in a cell(s). The chapter in the NUREG should be read before an analysis is made.

INPUT PARAMETERS

| | | |
|--|-------------------------|----------------------|
| Heat Release Rate of the Fire (Q) | 1420.00 kW | |
| Distance from the Top of the Fuel to the Ceiling (z) | 20.00 ft | 6.10 m |
| Area of Combustible Fuel (A _c) | 10.00 ft ² | 0.93 m ² |
| AMBIENT CONDITIONS | | |
| Ambient Air Temperature (T _a) | 77.00 °F | 25.00 °C 298.00 K |
| Specific Heat of Air (c _p) | 1.00 kJ/kg-K | |
| Ambient Air Density (ρ _a) | 1.20 kg/m ³ | |
| Acceleration of Gravity (g) | 9.81 m/sec ² | |
| Convective Heat Release Fraction (χ _c) | 0.50 | |

ESTIMATING PLUME CENTERLINE TEMPERATURE

Reference: SFPE Handbook of Fire Protection Engineering, 2nd Edition, 1995, Page 2-9.

$$T_{p(\text{centerline})} - T_a = 9.1 (T_a/g c_p^2 \rho_a^2)^{1/3} Q_c^{2/3} (z - z_0)^{-5/3}$$

Where

- Q_c = convective portion of the heat release rate (kW)
- T_a = ambient air temperature (K)
- g = acceleration of gravity (m/sec²)
- c_p = specific heat of air (kJ/kg-K)
- ρ_a = ambient air density (kg/m³)
- z = distance from the top of the fuel package to the ceiling (m)
- z₀ = hypothetical virtual origin of the fire (m)

Convective Heat Release Rate Calculation

$$Q_c = \chi_c Q$$

Where

- Q = heat release rate of the fire (kW)
- χ_c = convective heat release fraction
- Q_c = 710 kW

Pool Fire Diameter Calculation

$$A_c = D^2/4$$

$$D = \sqrt{4 A_c}$$

$$D = 1.09 \text{ m}$$

Hypothetical Virtual Origin Calculation

$$z_0/D = -1.02 + 0.083 (Q^{2/5})/D$$

Where z_0 = virtual origin of the fire (m)
 Q = heat release rate of fire (kW)
 D = diameter of pool fire (m)

$$z_0/D = 0.37$$
$$z_0 = 0.40 \text{ m}$$

Centerline Plume Temperature Calculation

$$T_{p(\text{centerline})} - T_a = 9.1 (T_a/g c_p^2 \rho_a^2)^{1/3} Q_c^{2/3} (z - z_0)^{-5/3}$$

$$T_{p(\text{centerline})} - T_a = 110.29$$
$$T_{p(\text{centerline})} = 408.29 \text{ K}$$

| | | | |
|------------------------------|-----------|-----------|---------------|
| $T_{p(\text{centerline})} =$ | 135.29 °C | 275.52 °F | ANSWER |
|------------------------------|-----------|-----------|---------------|

NOTE

The above calculations are based on principles developed in the SFPE Handbook of Fire Protection Engineering, 2nd Edition, 1995. Calculations are based on certain assumptions and have inherent limitations. The results of such calculations may or may not have reasonable predictive capabilities for a given situation, and should only be interpreted by an informed user. Although each calculation in the spreadsheet has been verified with the results of hand calculation, there is no absolute guarantee of the accuracy of these calculations. Any questions, comments, concerns, and suggestions, or to report an error(s) in the spreadsheet, please send an email to nxi@nrc.gov.



This page intentionally left blank.

Problem J-11

Problem Statement

A fire with $\dot{Q} = 3,000$ kW occurs in a makeup pump room protected with sprinkler protection. The sprinklers are rated at 74 °C (165 °F) [standard response bulb with RTI 235 (m-sec)^{1/2}] and located 3.0 m (10.0 ft) from the center of the fire source. The height from the top of the fuel package to the ceiling is 5.5 m (18.0 ft). Determine whether the sprinklers would activate and if so, how long it would take for them to activate.

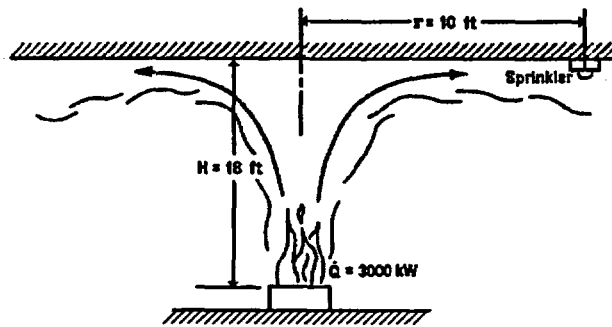

Problem 11: Fire Scenario with Sprinkler Protection

Solution

Purpose:

- (1) Determine if the sprinklers will be activated for the given fire scenario.
- (2) If the sprinkles are activated, determine how long it takes for the activation.

Assumptions:

- (1) The fire is located away from walls and corners.
- (2) The fire is steady state
- (3) The ceiling is unconfined, unobstructed, and flat.
- (4) Only convective heat transfer from the hot fire gases is considered.
- (5) There is heavily obstructed overhead.
- (6) The ambient temperature before the fire ignition is 70 °F

Spreadsheet (FDT[®]) Solution Procedure:

Use the following FDT[®]:

- (a) Detector_Activation_Time.xls (select *Sprinkler*)

FDT[®] Input Parameters:

Enter the following parameters in the spreadsheet (values only):

- Heat Release Rate of the Fire (\dot{Q}) = 3,000 kW
- Distance from the Top of the Fuel Package to the Ceiling (H) = 18 ft
- Radial Distance from the Plume Centerline to the Sprinkler (r) = 10 ft
- Ambient Air Temperature (T_a) = 70 °F
- Select Type of Sprinkler = select **Standard response bulb** from the combo box
- Select Sprinkler Classification = select **Ordinary** from the combo box

Note: Ordinary classification is selected because the rated value for the sprinklers in this problem (165 °F) is within the range of temperature ratings for ordinary sprinklers (135 °F–170 °F).

Note: When the **sprinkler type** and **classification** are selected, their respective values are automatically selected from the table and entered in the corresponding input cells.

Results

| Sprinkler Type | Sprinkler Activation Time* $t_{\text{activation}}$ (min.) |
|---------------------------|--|
| Standard response bulb | 3 |

*spreadsheet calculations attached on next page.

Spreadsheet Calculations

CHAPTER 10 - ESTIMATING SPRINKLER RESPONSE TIME

The following calculations estimate sprinkler activation time.
Parameters should be specified ONLY IN THE YELLOW INPUT PARAMETER BOXES.
 All subsequent output values are calculated by the spreadsheet and based on values specified in the input parameters. This spreadsheet is protected and secure to avoid errors due to a wrong entry in a cell(s).
 The chapter in the NUREG should be read before an analysis is made.

INPUT PARAMETERS

| | | | |
|--|---------|------------------------|----------|
| Heat Release Rate of the Fire (Q) | 3000.00 | kW | |
| Sprinkler Response Time Index (RTI) | 235 | (m-sec) ^{1/2} | |
| Activation Temperature of the Sprinkler (T _{activation}) | 165 | °F | 73.89 °C |
| Distance from the Top of the Fuel Package to the Ceiling (H) | 18.00 | ft | 5.49 m |
| Radial Distance from the Plume Centerline to the Sprinkler (r) | 10.00 | ft | 3.05 m |
| Ambient Air Temperature (T _a) | 70.00 | °F | 21.11 °C |
| | | | 294.11 K |
| Convective Heat Release Fraction (c) | 0.70 | | |
| r/H = | 0.56 | | |

GENERIC SPRINKLER RESPONSE TIME INDEX (RTI)*

| Common Sprinkler Type | Generic Response Time Index RTI (m-sec) ^{1/2} |
|------------------------|---|
| Standard response bulb | 235 |
| Standard response link | 130 |
| Quick response bulb | 42 |
| Quick response link | 34 |

Select Type of Sprinkler

Standard response bulb
 Scroll to desired sprinkler type then Click on selection

Reference: Madrzykowski, D., "Evaluation of Sprinkler Activation Prediction Methods"
 ASIAFLAM'95, International Conference on Fire Science and Engineering, 1st Proceeding,
 March 15-16, 1995, Kowloon, Hong Kong, pp. 211-218.

*Note: The actual RTI should be used when the value is available.

GENERIC SPRINKLER TEMPERATURE RATING (T_{activation})*

| Temperature Classification | Range of Temperature Ratings (°F) | Generic Temperature Ratings (°F) |
|----------------------------|--------------------------------------|-------------------------------------|
| Ordinary | 135 to 170 | 165 |
| Intermediate | 175 to 225 | 212 |
| High | 250 to 300 | 275 |
| Extra high | 325 to 375 | 350 |
| Very extra high | 400 to 475 | 450 |
| Ultra high | 500 to 575 | 550 |
| Ultra high | 650 | 550 |

Select Sprinkler Classification

Ordinary
 Scroll to desired sprinkler class then Click on selection

Reference: Automatic Sprinkler Systems Handbook, 6th Edition, National Fire Protection
 Association, Quincy, Massachusetts, 1994, Page 67.

*Note: The actual temperature rating should be used when the value is available.

ESTIMATING SPRINKLER RESPONSE TIME

Reference: NFPA Fire Protection Handbook, 18th Edition, 1997, Page 11-97.

$$t_{\text{activation}} = (RTI / (v u_{\text{jet}})) (\ln (T_{\text{jet}} - T_a) / (T_{\text{jet}} - T_{\text{activation}}))$$

Where $t_{\text{activation}}$ = sprinkler activation response time (sec)
RTI = sprinkler response time index (m-sec)^{1/2}
 u_{jet} = ceiling jet velocity (m/sec)
 T_{jet} = ceiling jet temperature (°C)
 T_a = ambient air temperature (°C)
 $T_{\text{activation}}$ = activation temperature of sprinkler (°C)

Ceiling Jet Temperature Calculation

$$T_{\text{jet}} - T_a = 16.9 (Q_c)^{2/3} / H^{5/3} \quad \text{for } r/H = 0.18$$

$$T_{\text{jet}} - T_a = 5.38 (Q_c/r)^{2/3} / H \quad \text{for } r/H > 0.18$$

Where T_{jet} = ceiling jet temperature (°C)
 T_a = ambient air temperature (°C)
 Q_c = convective portion of the heat release rate (kW)
 H = distance from the top of the fuel package to the ceiling level (m)
 r = radial distance from the plume centerline to the sprinkler (m)

Convective Heat Release Rate Calculation

$$Q_c = \chi_c Q$$

Where Q = heat release rate of the fire (kW)
 χ_c = convective heat release fraction

$$Q_c = 2100 \text{ kW}$$

Radial Distance to Ceiling Height Ratio Calculation

$$r/H = 0.56 \quad r/H > 0.15$$

$$T_{\text{jet}} - T_a = (5.38 (Q_c/r)^{2/3}) / H$$

$$T_{\text{jet}} - T_a = 76.49$$

$$T_{\text{jet}} = 97.61 \text{ (°C)}$$

Ceiling Jet Velocity Calculation

$$u_{\text{jet}} = 0.96 (Q/H)^{1/3} \quad \text{for } r/H = 0.15$$

$$u_{\text{jet}} = (0.195 Q^{1/3} H^{1/2}) / r^{5/8} \quad \text{for } r/H > 0.15$$

u_{jet} = ceiling jet velocity (m/sec)
 Q = heat release rate of the fire (kW)
 H = distance from the top of the fuel package to the ceiling (m)
 r = radial distance from the plume centerline to the sprinkler (m)

Radial Distance to Ceiling Height Ratio Calculation

$$r/H = 0.56 \quad r/H > 0.15$$

$$u_{\text{jet}} = (0.195 Q^{1/3} H^{1/2}) / r^{5/8}$$

$$u_{\text{jet}} = 2.602 \text{ m/sec}$$

Sprinkler Activation Time Calculation

$$t_{\text{activation}} = (RTI / (v u_{\text{jet}})) (\ln (T_{\text{jet}} - T_a) / (T_{\text{jet}} - T_{\text{activation}}))$$

$$t_{\text{activation}} = 170.59 \text{ sec}$$

The sprinkler will respond in approximately **2.84 minutes** ANSWER

NOTE: If $t_{\text{activation}}$ = "NUM" Sprinkler does not activate

NOTE

The above calculations are based on principles developed in the NFPA Fire Protection Handbook 18th Edition, 1997. Calculations are based on certain assumptions and have inherent limitations. The results of such calculations may or may not have reasonable predictive capabilities for a given situation, and should only be interpreted by an informed user. Although each calculation in the spreadsheet has been verified with the results of hand calculation, there is no absolute guarantee of the accuracy of these calculations. Any questions, comments, concerns, and suggestions, or to report an error(s) in the spreadsheet, please send an email to nxi@nrc.gov.



This page intentionally left blank.

Problem J-12

Problem Statement

A trash fire with an HRR (\dot{Q}) of 1,000 kW occurs in a battery room protected with fixed temperature heat detectors with an RTI of $306 \text{ (m-sec)}^{1/2}$. The distance from the top of the fuel package to the ceiling 3.7 m (12 ft) and the radial distance from the plume center to the heat detector location is 10 ft. Calculate the activation time ($t_{\text{activation}}$) for the detectors, using listed spacing of 4.6 m (15.0 ft). Assume that the detector activation temperature of $54 \text{ }^\circ\text{C}$ ($128 \text{ }^\circ\text{F}$), and the ambient temperature is $20 \text{ }^\circ\text{C}$ ($68 \text{ }^\circ\text{F}$).

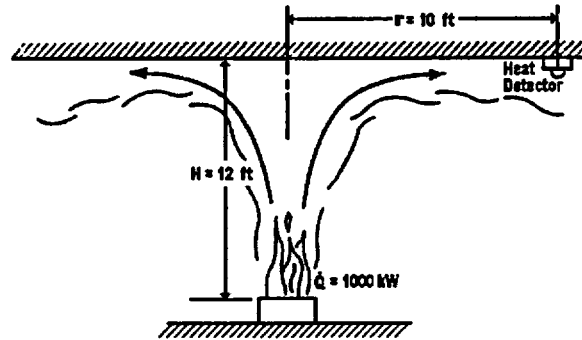

Problem 12: Fire Scenario with Heat Detectors

Solution

Purpose:

- (1) Determine the response time of the fixed-temperature heat detectors for the given fire scenario.

Assumptions:

- (1) The fire is located away from walls and corners.
- (2) The fire is steady state
- (3) The ceiling is unconfined, unobstructed, and flat.
- (4) Only convective heat transfer from the hot fire gases is considered.
- (5) There is heavily obstructed overhead.

Spreadsheet (FDT^s) Solution Procedure:

Use the following FDT^s:

- (a) Detector_Activation_Time.xls (select *FTHDetectors*)

FDT^s Input Parameters:

Enter the following parameters in the spreadsheet (values only):

- Heat Release Rate of the Fire (\dot{Q}) = 1,000 kW
- Radial Distance to the Detector (r) = 10 ft
- Distance from the Top of the Fuel Package to the Ceiling (H) = 12 ft
- Ambient Air Temperature (T_a) = $68 \text{ }^\circ\text{F}$
- Select the option button (o) for FTH detectors with $T_{\text{activation}} = 128 \text{ }^\circ\text{F}$
- Select Detector Spacing: select 15 from the combo box

Note: When $T_{\text{activation}}$ and Detector Spacing are selected, their respective values are automatically selected from the table and entered in the corresponding input cells.

Results

| Detector Type | Heat Detector Activation Time $t_{\text{activation}}$ (min.) |
|----------------------|---|
| Fixed Temperature | 4 |

*spreadsheet calculations attached on next page.

Spreadsheet Calculations

CHAPTER 12 - ESTIMATING FIXED TEMPERATURE HEAT DETECTOR

The following calculations estimate fixed temperature heat detector activation time. Parameters should be specified **ONLY IN THE YELLOW INPUT PARAMETER BOXES**. All subsequent output values are calculated by the spreadsheet and based on values specified in the input parameters. This spreadsheet is protected and secure to avoid errors due to a wrong entry in a cell(s). The chapter in the NUREG should be read before an analysis is made.

INPUT PARAMETERS

| | | | |
|--|---------|------------------------|----------|
| Heat Release Rate of the Fire (Q) | 1000.00 | kW | |
| Radial Distance to the Detector **never more than 1/2 of the listed spacing** | 10.00 | ft | 3.05 m |
| Activation Temperature of the Fixed Temperature Heat Detector ($T_{activation}$) | 128 | °F | 53.33 °C |
| Detector Response Time Index (RTI) | 306.00 | (m-sec) ^{1/2} | |
| Distance from the Top of the Fuel Package to the Ceiling (H) | 12.00 | ft | 3.66 m |
| Ambient Air Temperature (T_a) | 68.00 | °F | 20.00 °C |
| | | | 293.00 K |
| Convective Heat Release Fraction (α_c) | 0.70 | | |
| $r/H =$ | 0.83 | | |

INPUT DATA FOR ESTIMATING HEAT DETECTOR RESPONSE TIME

Activation Temperature $T_{activation}$

| $T = 128$ F | UL Listed Spacing r (ft) | Response Time Index RTI (m-sec) ^{1/2} | Activation Temperature (°F) |
|-------------|-----------------------------|---|--------------------------------|
| | 10 | 490 | 128 |
| | 15 | 306 | 128 |
| | 20 | 325 | 128 |
| | 25 | 152 | 128 |
| | 30 | 116 | 128 |
| | 40 | 87 | 128 |
| | 50 | 72 | 128 |
| | 70 | 44 | 128 |

Select Detector Spacing

 Scroll to desired spacing then
 Click on selection

| $T = 135$ F | UL Listed Spacing r (ft) | Response Time Index RTI (m-sec) ^{1/2} | Activation Temperature (°F) |
|-------------|-----------------------------|---|--------------------------------|
| | 10 | 404 | 135 |
| | 15 | 233 | 135 |
| | 20 | 165 | 135 |
| | 25 | 123 | 135 |
| | 30 | 98 | 135 |
| | 40 | 70 | 135 |
| | 50 | 54 | 135 |
| | 70 | 29 | 135 |

Select Detector Spacing

 Scroll to desired spacing then
 Click on selection

| ● T= 145 F | UL Listed Spacing r (ft) | Response Time Index RTI (m-sec)^{1/2} | Activation Temperature (°F) | Select Detector Spacing |
|-------------------|-------------------------------------|--|--|--|
| | 10 | 321 | 145 | <input type="text" value="15"/> |
| | 15 | 191 | 145 | |
| | 20 | 129 | 145 | |
| | 25 | 96 | 145 | |
| | 30 | 75 | 145 | |
| | 40 | 50 | 145 | |
| | 50 | 37 | 145 | |
| | 70 | 11 | 145 | |
| | | | | Scroll to desired spacing then Click on selection |

| ● T= 160 F | UL Listed Spacing r (ft) | Response Time Index RTI (m-sec)^{1/2} | Activation Temperature (°F) | Select Detector Spacing |
|-------------------|-------------------------------------|--|--|--|
| | 10 | 239 | 160 | <input type="text" value="20"/> |
| | 15 | 135 | 160 | |
| | 20 | 86 | 160 | |
| | 25 | 59 | 160 | |
| | 30 | 44 | 160 | |
| | 40 | 22 | 160 | |
| | | | | Scroll to desired spacing then Click on selection |

| ● T= 170 F | UL Listed Spacing r (ft) | Response Time Index RTI (m-sec)^{1/2} | Activation Temperature (°F) | Select Detector Spacing |
|-------------------|-------------------------------------|--|--|--|
| | 10 | 196 | 170 | <input type="text" value="20"/> |
| | 15 | 109 | 170 | |
| | 20 | 64 | 170 | |
| | 25 | 39 | 170 | |
| | 30 | 27 | 170 | |
| | | | | Scroll to desired spacing then Click on selection |

| ● T= 196 F | UL Listed Spacing r (ft) | Response Time Index RTI (m-sec)^{1/2} | Activation Temperature (°F) | Select Detector Spacing |
|-------------------|-------------------------------------|--|--|--|
| | 10 | 119 | 196 | <input type="text" value="15"/> |
| | 15 | 55 | 196 | |
| | 20 | 21 | 196 | |
| | | | | Scroll to desired spacing then Click on selection |

Reference: NFPA Standard 72, National Fire Alarm Code, Appendix B, Table B-3.2.5.1, 1999, Edition.

ESTIMATING FIXED TEMPERATURE HEAT DETECTOR RESPONSE TIME

Reference: *NFPA Fire Protection Handbook*, 18th Edition, 1997, Page 11-97.

$$t_{\text{activation}} = (RTI / (v u_{\text{jet}})) (\ln (T_{\text{jet}} - T_a) / (T_{\text{jet}} - T_{\text{activation}}))$$

- Where
- $t_{\text{activation}}$ = detector activation time (sec)
 - RTI = detector response time index (m-sec)^{1/2}
 - u_{jet} = ceiling jet velocity (m/sec)
 - T_{jet} = ceiling jet temperature (°C)
 - T_a = ambient air temperature (°C)
 - $T_{\text{activation}}$ = activation temperature of detector (°C)

Ceiling Jet Temperature Calculation

$T_{jet} - T_a = 16.9 (Q_c)^{2/3} / H^{5/3}$ for $r/H = 0.18$
 $T_{jet} - T_a = 5.38 (Q_c/r)^{2/3} / H$ for $r/H > 0.18$

Where T_{jet} = ceiling jet temperature (°C)
 T_a = ambient air temperature (°C)
 Q_c = convective portion of the heat release rate (kW)
 H = distance from the top of the fuel package to the ceiling level (m)
 r = radial distance from the plume centerline to the detector (m)

Convective Heat Release Rate Calculation

$Q_c = \chi_c Q$

Where Q = heat release rate of the fire (kW)
 χ_c = convective heat release fraction

$Q_c = 700 \text{ kW}$

Radial Distance to Ceiling Height Ratio Calculation

$r/H = 0.83$ $r/H > 0.15$
 >0.15 55.16 <0.15 153.4469934

$T_{jet} - T_a = 5.38 ((Q_c/r)^{2/3})/H$
 $T_{jet} - T_a = 55.16$
 $T_{jet} = 75.16 \text{ (°C)}$

Ceiling Jet Velocity Calculation

$u_{jet} = 0.96 (Q/H)^{1/3}$ for $r/H = 0.15$
 $u_{jet} = (0.195 Q^{1/3} H^{1/2}) / r^{5/6}$ for $r/H > 0.15$

u_{jet} = ceiling jet velocity (m/sec)
 Q = heat release rate of the fire (kW)
 H = distance from the top of the fuel package to the ceiling (m)
 r = radial distance from the plume centerline to the detector (m)

Radial Distance to Ceiling Height Ratio Calculation

$r/H = 0.83$ $r/H > 0.15$
 $u_{jet} = (0.195 Q^{1/3} H^{1/2}) / r^{5/6}$
 $u_{jet} = 1.473 \text{ m/sec}$

Detector Activation Time Calculation

$t_{activation} = (RTI / (v u_{jet})) (\ln (T_{jet} - T_a) / (T_{jet} - T_{activation}))$
 $t_{activation} = 233.71 \text{ sec}$

The detector will respond in approximately **3.90 minutes** **ANSWER**

NOTE: If $t_{activation} = \text{"NUM"}$ Detector does not activate

NOTE

The above calculations are based on principles developed in the NFPA Fire Protection Handbook 18th Edition, 1997. Calculations are based on certain assumptions and have inherent limitations. The results of such calculations may or may not have reasonable predictive capabilities for a given situation, and should only be interpreted by an informed user. Although each calculation in the spreadsheet has been verified with the results of hand calculation, there is no absolute guarantee of the accuracy of these calculations. Any questions, comments, concerns, and suggestions, or to report an error(s) in the spreadsheet, please send an email to nxi@nrc.gov.

This page intentionally left blank.

Problem J-13

Problem Statement

Calculate the HRR necessary for flashover (\dot{Q}_{FO}) and the post-flashover temperature in a long access corridor that is 30.5 m long x 5.5 m wide x 3.0 m high (100.0 ft long x 18.0 ft wide x 10.0 ft high), with an opening that is 0.91 m (3.0 ft) wide x 2.5 m (8.0 ft) high. Assume that corridor boundary material is 15 cm (6 in) thick concrete.

Solution

Purpose:

- (1) Determine the HRR necessary for flashover and the post-flashover temperature for the given compartment

Assumptions:

- (1) Natural Ventilation.

Spreadsheet (FDT[®]) Solution Procedure:

Use the following FDT[®]:

- (a) *Compartment_Flashover_Calculations.xls*
 - select *Flashover-HRR* to calculate the HRR for flashover
 - select *Post_Flashover_Temperature* to calculate the post-flashover temperature

FDT[®] Input Parameters:

Enter the following parameters in both spreadsheets (values only):

- Compartment Width (w_c) = 18 ft
- Compartment Length (l_c) = 100 ft
- Compartment Height (h_c) = 10 ft
- Vent Width (w_v) = 3 ft
- Vent Height (h_v) = 8 ft
- Interior Lining Thickness (δ) = 6 in (*Flashover-HRR only*)
- Select Material: select **Concrete** from the combo box (*Flashover-HRR only*)

Note: When **Concrete** is selected in *Flashover-HRR spreadsheet*, its respective properties are automatically selected from the table and entered in the corresponding input yellow cells.

Results

| Post-Flashover Temperature $T_{PFO(max)}$ °C (°F) | Flashover HRR \dot{Q}_{FO} kW (Btu/sec) | | |
|---|--|----------------------|------------------|
| | Method of MQH | Method of Brabauskas | Method of Thomas |
| 478 (892) | 2,739 (2,596) | 2,611 (2,475) | 5,618 (5,325) |

*spreadsheet calculations attached on next page

Spreadsheet Calculations

CHAPTER 13 - PREDICTING COMPARTMENT FLASHOVER

The following calculations estimate the minimum heat release rate required to compartment flashover. Parameters should be specified **ONLY IN THE YELLOW INPUT PARAMETER BOXES**. All subsequent output values are calculated by the spreadsheet and based on values specified in the input parameters. This spreadsheet is protected and secure to avoid errors due to a wrong entry in a cell(s). The chapter in the NUREG should be read before an analysis is made.

INPUT PARAMETERS

COMPARTMENT INFORMATION

| | | |
|--|---------------|----------|
| Compartment Width (w_c) | 18.00 ft | 5.4864 m |
| Compartment Length (l_c) | 100.00 ft | 30.48 m |
| Compartment Height (h_c) | 10.00 ft | 3.048 m |
| Vent Width (w_v) | 3.00 ft | 0.914 m |
| Vent Height (h_v) | 8.00 ft | 2.44 m |
| Interior Lining Thickness () | 6.00 in | 0.1524 m |
| Interior Lining Thermal Conductivity (k) | 0.0016 kW/m-K | |

THERMAL PROPERTIES DATA

| Material | Thermal Conductivity k (kW/m-K) |
|------------------------|------------------------------------|
| Aluminum (pure) | 0.208 |
| Steel (0.5% Carbon) | 0.054 |
| Concrete | 0.0016 |
| Brick | 0.0008 |
| Glass, Plate | 0.00076 |
| Brick/Concrete Block | 0.00073 |
| Gypsum Board | 0.00017 |
| Plywood | 0.00012 |
| Fiber Insulation Board | 0.00053 |
| Chipboard | 0.00015 |
| Aerated Concrete | 0.00028 |
| Plasterboard | 0.00016 |
| Calcium Silicate Board | 0.00013 |
| Alumina Silicate Block | 0.00014 |
| Glass Fiber Insulation | 0.000037 |
| Expanded Polystyrene | 0.000034 |

Select Material

Concrete

Scroll to desired material then Click on selection

Reference: Klote, J., J. Milke, *Principles of Smoke Management*, 2002, Page 270.

**PREDICTING FLASHOVER HEAT RELEASE RATE
METHOD OF McCAFFREY, QUINTIERE, AND HARKLEROAD (MQH)**

Reference: *SFPE Handbook of Fire Protection Engineering*, 2nd Edition, 1995, Page 3-145.

$$Q_{FO} = 610 v (h_k A_T A_v (vh_v))$$

Where Q_{FO} = heat release rate necessary for flashover (kW)
 h_k = effective heat transfer coefficient (kW/m²-K)
 A_T = total area of the compartment enclosing surface boundaries excluding area of vent op
 A_v = area of ventilation opening (m²)
 h_v = height of ventilation opening (m)

Heat Transfer Coefficient Calculation

$h_k = k/\delta$ Assuming that compartment has been heated thoroughly before flashover, i.e., $t > t_p$

Where h_k = effective heat transfer coefficient (kW/m²-K)
 k = interior lining thermal conductivity (kW/m-K)
 δ = interior lining thickness (m)

$$h_k = 0.010 \text{ kW/m}^2\text{-K}$$

Area of Ventilation Opening Calculation

$$A_v = (w_v) (h_v)$$

Where A_v = area of ventilation opening (m²)
 w_v = vent width (m)
 h_v = vent height (m)

$$A_v = 2.23 \text{ m}^2$$

Area of Compartment Enclosing Surface Boundaries

$$A_T = [2 (w_c \times l_c) + 2 (h_c \times w_c) + 2 (h_c \times l_c)] - A_v$$

Where A_T = total area of the compartment enclosing surface boundaries excluding area of vent op
 w_c = compartment width (m)
 l_c = compartment length (m)
 h_c = compartment height (m)
 A_v = area of ventilation opening (m²)

$$A_T = 551.47 \text{ m}^2$$

Minimum Heat Release Rate for Flashover

$$Q_{FO} = 610 v (h_k A_T A_v (vh_v))$$

$$Q_{FO} = 2738.77 \text{ kW} \quad \text{ANSWER}$$

METHOD OF BABRAUSKAS

Reference: *SFPE Handbook of Fire Protection Engineering*, 2nd Edition, 1995, Page 3-145.

$$Q_{FO} = 750 A_v (vh_v)$$

Where Q_{FO} = heat release rate necessary for flashover (kW)
 A_v = area of ventilation opening (m²)
 h_v = height of ventilation opening (m)

Minimum Heat Release Rate for Flashover

$$Q_{FO} = 750 A_v (vh_v)$$

$$Q_{FO} = 2611.29 \text{ kW} \quad \text{ANSWER}$$

METHOD OF THOMAS

Reference: *SFPE Handbook of Fire Protection Engineering*, 2nd Edition, 1995, Page 3-146.

$$Q_{FO} = 7.8 A_T + 378 A_v (vh_v)$$

Where Q_{FO} = heat release rate necessary for flashover (kW)
 A_T = total area of the compartment enclosing surface boundaries excluding area of vent openings (m²)
 A_v = area of ventilation opening (m²)
 h_v = height of ventilation opening (m)

Minimum Heat Release Rate for Flashover

$$Q_{FO} = 7.8 A_T + 378 A_v (vh_v)$$

| | | |
|------------|------------|--------|
| $Q_{FO} =$ | 5617.57 kW | ANSWER |
|------------|------------|--------|

SUMMARY OF RESULTS

| | Flashover HRR |
|----------------------|---------------|
| METHOD OF MQH | 2739 kW |
| METHOD OF BABRAUSKAS | 2611 kW |
| METHOD OF THOMAS | 5618 kW |

NOTE

The above calculations are based on principles developed in the *SFPE Handbook of Fire Protection Engineering*, 2nd Edition, 1995. Calculations are based on certain assumptions and have inherent limitations. The results of such calculations may or may not have reasonable predictive capabilities for a given situation, and should only be interpreted by an informed user. Although each calculation in the spreadsheet has been verified with the results of hand calculation, there is no absolute guarantee of the accuracy of these calculations. Any questions, comments, concerns, and suggestions, or to report an error(s) in the spreadsheets, please send an email to nrd@nrc.gov.



CHAPTER 13 - PREDICTING COMPARTMENT POST-FLASHOVER TEMPERATURE

The following calculations estimate the compartment post-flashover temperature. Parameters should be specified **ONLY IN THE YELLOW INPUT PARAMETER BOXES**. All subsequent output values are calculated by the spreadsheet and based on values specified in the input parameters. This spreadsheet is protected and secure to avoid errors due to a wrong entry in a cell(s). The chapter in the NUREG should be read before an analysis is made.

INPUT PARAMETERS

COMPARTMENT INFORMATION

| | | |
|------------------------------|-----------|----------|
| Compartment Width (w_c) | 18.00 ft | 5.4864 m |
| Compartment Length (l_c) | 100.00 ft | 30.48 m |
| Compartment Height (h_c) | 10.00 ft | 3.048 m |
| Vent Width (w_v) | 3.00 ft | 0.914 m |
| Vent Height (h_v) | 8.00 ft | 2.438 m |

PREDICTING COMPARTMENT POST-FLASHOVER TEMPERATURE METHOD OF LAW

Reference: *SFPE Handbook of Fire Protection Engineering*, 2nd Edition, 1995, Page 3-142.

$$T_{PFO(max)} = 6000 (1 - e^{-\Omega}) / (\nu)$$

Where $T_{PFO(max)}$ = maximum compartment post-flashover temperature (°C)
 Ω = ventilation factor

Where $\Omega = (A_T - A_v) / A_v (\nu h_v)$
 A_T = total area of the compartment enclosing surface boundaries excluding area of vent openings (m²)
 A_v = area of ventilation opening (m²)
 h_v = height of ventilation opening (m)

Area of Ventilation Opening Calculation

$$A_v = (w_v) (h_v)$$

Where A_v = area of ventilation opening (m²)
 w_v = vent width (m)
 h_v = vent height (m)

$$A_v = 2.23 \text{ m}^2$$

Area of Compartment Enclosing Surface Boundaries

$$A_T = [2 (w_c \times l_c) + 2 (h_c \times w_c) + 2 (h_c \times l_c)] - A_v$$

Where A_T = total area of the compartment enclosing surface boundaries excluding area of vent openings (m²)
 w_c = compartment width (m)
 l_c = compartment length (m)
 h_c = compartment height (m)
 A_v = area of ventilation opening (m²)

$$A_T = 551.47 \text{ m}^2$$

Ventilation Factor Calculation

$$\Omega = (A_T - A_v) / A_v (vh_v)$$

Where Ω = ventilation factor

A_T = total area of the compartment enclosing surface boundaries excluding area of vent openings (m²)

A_v = area of ventilation opening (m²)

h_v = vent height (m)

$$\Omega = 157.75 \text{ m}^{-1/2}$$

Compartment Post-Flashover Temperature Calculation

$$T_{PFO (max)} = 6000 (1 - e^{-0.1\Omega}) / (v\Omega)$$

| | | |
|---|---------------------------------|--------|
| $T_{PFO (max)} = 477.71 \text{ }^\circ\text{C}$ | $891.88 \text{ }^\circ\text{F}$ | ANSWER |
|---|---------------------------------|--------|

NOTE

The above calculations are based on principles developed in the SFPE Handbook of Fire Protection Engineering, 2nd Edition, 1995.

Calculations are based on certain assumptions and have inherent limitations. The results of such calculations may or may not have reasonable predictive capabilities for a given situation, and should only be interpreted by an informed user.

Although each calculation in the spreadsheet has been verified with the results of hand calculation, there is no absolute guarantee of the accuracy of these calculations.

Any questions, comments, concerns, and suggestions, or to report an error(s) in the spreadsheets, please send an email to nxi@nrc.gov.



Office of Nuclear Reactor Regulation

Problem J-14

Problem Statement

Consider a closed compartment in a facility (a pump room) 2.75 m wide x 2.75 m long x 3.7 m high (9.0 ft wide x 9.0 ft long x 12 ft high) ($w_c \times l_c \times h_c$). A fire starts with a constant power of 75 kW. Estimate the pressure increase attributable to the expansion of gases after 15 seconds.

Solution

Purpose:

- (1) Estimate the pressure rise in the compartment at 15 seconds after ignition.

Assumptions:

- (1) The energy release rate is constant.
- (2) The mass rate of the fuel is neglected in the conversion of mass.
- (3) The specific heat is constant with temperature.
- (4) The hydrostatic pressure difference over the height of the compartment is negligible compared to the dynamic pressure.

Spreadsheet (FDT[®]) Solution Procedure:

Use the following FDT[®]:

- (a) Compartment_Over_Pressure_Calculations.xls

FDT[®] Input Parameters:

Enter the following parameters in the spreadsheet (values only):

- Compartment Width (w_c) = 9 ft
- Compartment Length (l_c) = 9 ft
- Compartment Height (h_c) = 12 ft
- Fire Heat Release Rate (\dot{Q}) = 75 kW
- Time After Ignition (t) = 15 sec

Results

| | |
|----------------|--------------|
| Pressure Rise* | 16.83 (2.44) |
| kPa (psi) | |

*spreadsheet calculations attached on next page

Spreadsheet Calculations

CHAPTER 14 - ESTIMATING PRESSURE RISE DUE TO A FIRE IN A CLOSED COMPARTMENT

The following calculations estimate the pressure rise in a compartment due to fire and combustion. Parameters should be specified **ONLY IN THE YELLOW INPUT PARAMETER BOXES**. All subsequent output values are calculated by the spreadsheet and based on values specified in the input parameters. This spreadsheet is protected and secure to avoid errors due to a wrong entry in a cell(s). The chapter in the NUREG guide should be read before an analysis is made.

INPUT PARAMETERS

COMPARTMENT INFORMATION

| | | |
|------------------------------|-----------|--------|
| Compartment Width (w_c) | 9.00 ft | 2.74 m |
| Compartment Length (l_c) | 9.00 ft | 2.74 m |
| Compartment Height (h_c) | 12.00 ft | 3.66 m |
| Fire Heat Release Rate (Q) | 75.00 kW | |
| Time after Ignition (t) | 15.00 sec | |

AMBIENT CONDITIONS

| | | |
|--|------------------------|------------|
| Ambient Air Temperature (T_a) | 68.00 °F | 20.00 °C |
| Initial Atmospheric Pressure (P_a) | 14.70 psi | 293.00 K |
| Specific Heat of Air at Constant Volume (c_v) | 0.70 kJ/kg-K | 101.35 kPa |
| (Note: Values of c_v ranges from 0.71 to 0.85 kJ/kg-k) | | |
| Ambient Air Density (ρ_a) | 1.20 kg/m ³ | |

METHOD OF KARLSSON AND QUINTIERE

Reference: Karlsson and Quintiere, *Enclosure Fire Dynamics*, 1999, Page 192.

$$(P - P_a) / P_a = Q / (V \rho_a c_v T_a)$$

- Where
- P = compartment pressure due to fire and combustion (kPa)
 - P_a = initial atmospheric pressure (kPa)
 - Q = heat release rate of the fire (kW)
 - t = time after ignition (sec)
 - V = compartment volume (m³)
 - ρ_a = ambient density (kg/m³)
 - c_v = specific heat of air at constant volume (kJ/kg-K)
 - T_a = ambient air temperature (K)

Compartment Volume Calculation

$$V = w_c \times l_c \times h_c$$

- Where
- V = volume of the compartment (m³)
 - w_c = compartment width (m)
 - l_c = compartment length (m)
 - h_c = compartment height (m)

$$V = 27.52 \text{ m}^3 \qquad 972 \text{ ft}^3$$

Pressure Rise in Compartment

$$(P - P_a) / P_a = Q t / (V_a c_v T_a)$$

$$(P - P_a) / P_a = 0.166 \text{ atm}$$

Multiplying by the atmospheric pressure (P_a) = 101 kPa

Gives a pressure difference =

16.83 kPa

2.44 psi

ANSWER

This example shows that in a very short time the pressure in a closed compartment rises to quite large value.

Most buildings have leaks of some sort. The above example indicates that even though a fire compartment may be closed, the pressure is very rapid and would presumably lead to sufficient leaks to prevent further pressure rise from occurring. We will use this conclusion when dealing with pressure rises in enclosures with small leaks.

NOTE

The above calculations are based on principles developed in the Enclosure Fire Dynamics. Calculations are based on certain assumptions and have inherent limitations. The results of such calculations may or may not have reasonable predictive capabilities for a given situation, and should only be interpreted by an informed user.

Although each calculation in the spreadsheet has been verified with the results of hand calculation, there is no absolute guarantee of the accuracy of these calculations.

Any questions, comments, concerns, and suggestions, or to report an error(s) in the spreadsheet, please send an email to nxi@nrc.gov.



Office of Nuclear Reactor Regulation

This page intentionally left blank.

Problem J-15

Problem Statement

The licensee used UL Design No. 816 to protect a number of unrestrained beams. The licensee's quality assurance (QA) program verified that there is 6.35 cm (2½ in) thickness of fire protection insulation on all of the beams. The size of the tested beam was W12 x 26. Determine whether the 6.35 cm (2½ in) thickness of fire protection insulation is acceptable for a beam that is W8 x 13.

Solution

Purpose:

- (1) Determine whether the 6.35 cm (2½ in.) thickness of fire protection insulation is acceptable for a W8 x 13 beam using the data for a W12 x 26 beam.

Assumptions:

- (1) The heat transfer is one-dimensional.
- (2) The analysis assumes that as the structural member heats up, structural properties change substantially.

Spreadsheet (FDT^s) Solution Procedure:

Use the following FDT^s:

- (a) FR_Beams_Columns_Substitution_Correlation.xls

FDT^s Input Parameters:

Enter the following parameters in the spreadsheet (values only):

- Rated Design Thickness of Beam Insulation (T₂) = 2.5 in
- Select Beam with known rating for insulation thickness: select W12 x 26
- Select Beam with unknown rating for insulation thickness: select W8 x 13

Note: When beam size (ex. W12 x 26) is selected from the combo box, its properties are automatically selected from the table ("Data" spreadsheet) and entered in the corresponding input yellow cells.

Results

| | |
|---|-----------------------------|
| Required Equivalent Thickness* cm (in.) | 7 (2.79) not appropriate |
|---|-----------------------------|

*spreadsheet calculations attached on next page

From the substitution correlation we obtain that 6.35 cm (2.5 in.) of fire protection insulation is not appropriate for W8 x 13 because the required thickness is more than 6.35 cm (2.5 in.).

A similar problem can be analyzed for a column, the calculations for columns are included in the same FDT^s (not shown).

Spreadsheet Calculations

CHAPTER 17 - ESTIMATING THICKNESS OF FIRE PROTECTION SPRAY-APPLIED COATING FOR STRUCTURAL STEEL BEAMS (SUBSTITUTION-CORRELATION)

For beams protected by spray-applied protections, following correlation enables substitution of one beam from another by varying the thickness of the fire protection insulation.
 Parameters should be specified **ONLY IN THE YELLOW INPUT PARAMETER BOXES**.
 All subsequent output values are calculated by the spreadsheet, and based on values specified in the input parameters. This spreadsheet is protected and secure to avoid errors due to a wrong entry in a cell(s).
 The chapter in the NUREG should be read before an analysis is made.

INPUT PARAMETERS

Rated Design Thickness of Beam Insulation (T_2) in

Known Insulation Rating

Weight of the Beam (W_2) lb/ft

Heated Perimeter of Beam (D_2) in

Unknown Insulation Rating

Weight of the Beam (W_1) lb/ft

Heated Perimeter of Beam (D_1) in

SECTIONAL FACTORS FOR STEEL BEAMS

Select the Beam with known rating for insulation thickness

Subscript 2
(Rated Beam)

Select the Beam with unknown rating for insulation thickness

Subscript 1
(Substitute Beam)

ESTIMATING THICKNESS OF FIRE PROTECTION INSULATION ON UNRATED BEAM

Reference: UL Fire Resistance Directory, Volume 1, 1995 (Page 19).

$$T_1 = ((W_2/D_2) T_2) / (W_1/D_1 + 0.6)$$

Where T_1 = calculated thickness of fire protection insulation on unrated beam (in)

T_2 = design thickness of insulation on rated beam (in)

W_1 = weight of beam with unknown insulation rating (lb/ft)

W_2 = weight of design rated beam (lb/ft)

D_1 = heated perimeter of unrated beam (in)

D_2 = heated perimeter of the rated beam (in)

Required Equivalent Thickness of Fire Protection Insulation on Unrated Beam

$$T_1 = ((W_2/D_2) T_2) / (W_1/D_1 + 0.6)$$

$T_1 =$ ANSWER

Beams with a larger W/D ratio can always be substituted for the structural member listed with a specific fire resistive covering without changing the thickness of the covering.

NOTE

The above calculations are based on method developed in the UL Fire Resistance Directory, Volume 1, 1995. Calculations are based on certain assumptions and have inherent limitations. The results of such calculations may or may not have reasonable predictive capabilities for a given situation, and should only be interpreted by an informed user.

Although each calculation in the spreadsheet has been verified with the results of hand calculation, there is no absolute guarantee of the accuracy of these calculations.

Any questions, comments, concerns, and suggestions, or to report an error(s) in the spreadsheet, please send an email to nxi@nrc.gov.



This page intentionally left blank.

Problem J-16

Problem Statement

During a routine fire protection inspection, an NRC inspector discovers a significant oil leak in a station air compressor in an access corridor in the fuel building. It is important to determine whether a fire involving a 76.0 liters (20.0 gallons) spill of lubricating oil from a compressor could damage the safety-related cable tray and electrical cabinet in the corridor. The compressor is on a pedestal approximately (1.0 ft) above floor level and has a 1.12 m² (12.0 ft²) oil retention dike. The safety-related cable trays are located 2.5 m (8.0 ft) above the corridor floor with a horizontal distance of 1.2 m (4.0 ft) from the edge of the compressor's oil retention dike. The horizontal distance between the compressor oil dike and the electrical cabinet is 1.52 m (5.0 ft).

The access corridor has a floor area of 6.0 m wide x 4.6 m long (20 ft wide x 15 ft long) ($w_c \times l_c$), ceiling height of 3.0 m (10.0 ft) (h_c), and a single unprotected vent opening (door) that is 1.2 m wide x 1.8 m high (4.0 ft wide x 6.0 ft high) ($w_v \times h_v$). The corridor has no forced ventilation and it is constructed of 0.3048 m (1.0 ft) thick concrete. The corridor has a smoke and heat detection system and a wet pipe sprinkler system. The nearest sprinkler is rated at 74 °C (165 °F) with an RTI of 235 (m-sec)^{1/2} and is located 2.98 m (9.8 ft) from the center of the dike. Determine whether there is a credible fire hazard to the safety-related cable trays and electrical cabinet.

Evaluate the hazard of the fire scenario using the following parameters:

- (a) pool fire heat release rate, \dot{Q} , flame height, z , and burning duration, t_b
- (b) compartment hot gas layer temperature, T_g , as well as gas layer height z
- (c) heat flux to the target (electrical cabinet) using the point source model, $\dot{q}''_{\text{cabinet}}$
- (d) heat flux to the target (cable trays) using the solid-flame radiation model, \dot{q}''_{cable}
- (e) centerline plume temperature, $T_{p(\text{centerline})}$
- (f) sprinkler activation time, $t_{\text{activation}}$
- (g) HRR necessary to cause flashover, \dot{Q}_{FO}

Solution

Purpose:

- (1) Determine if the given fire scenario could represent a hazard for the safety-related cable trays and electrical cabinet.

Solution Approach:

To analyze this fire scenario we are going to use various concepts that have been presented individually in the NUREG. A logical approach for this type of problem is to analyze the heat source and then its effect over the safety-related targets and fire suppression systems. First, we are going to calculate the HRR, flame height, and the burning duration of the pool fire (see Chapter 3) in order to determine the intensity and geometrical characteristics of the fire. Then calculate the hot gas layer temperature and gas layer height (see Chapter 2). Then calculate the centerline plume temperature to obtain an estimate of the maximum temperature in the fire scenario (see Chapter 9). Then, we are going to calculate the radiative heat flux from the pool fire to the electrical cabinet and cable tray (see Chapter 5). After that, evaluate the activation time of the sprinkler system to determine if the system is able to respond to the actual developed fire (see Chapter 10). The last calculation is the required HRR for flashover (see Chapter 13). Once we get all these values, we have to use them to evaluate the hazard of the fire scenario.

Assumptions:

- (1) There is instantaneous and complete involvement of the liquid in the pool fire.
- (2) The pool fire is burning in the open.
- (3) The pool is circular or nearly circular.
- (4) The fire is located at the center of the corridor or away from the walls.
- (5) All heat is released at a point
- (6) Buoyant forces are more significant than momentum forces
- (7) Radiation to the surroundings can be approximated as being isotropic or emanating from a point source (valid for point source radiation model only).
- (8) Only convective heat transfer from the hot fire gases is considered for sprinklers activation.
- (9) The ambient (or initial condition of the air) is at 25 °C (77 °F)
- (10) The bottom of the oil retention dike is at ground level.
- (11) The distance from the top of the fuel package (oil pool) to the ceiling is 10 ft, the pool height or oil layer thickness is negligible compared with the height of the ceiling (about 0.22 ft).

Spreadsheet (FDT*) Solution Procedure:

Use the following FDT*:

- (a) HRR_Flame_Height_Burning_Duration_Calculations.xls
- (b) Temperature_NV.xls (select *Temperature_NV Thermally Thick*)
- (c) Plume_Temperature_Calculations.xls
- (d) Heat_Flux_Calculations_Wind_Free.xls (select *Point Source* and *Solid Flame 2* for the target cabinet and cable tray heat flux analyses respectively)
- (e) Detector_Activation_Time.xls (select *Sprinkler*)
- (f) Compartment_Flashover_Calculations.xls (select *Flashover-HRR* to calculate the HRR for flashover)

FDT* Input Parameters:

Enter the following parameters in the spreadsheets (values only):

- (a) HRR_Flame_Height_Burning_Duration_Calculations.xls
 - Fuel spill volume (V) = 20 gallons
 - Fuel Spill Area or Dike Area (A_{dike}) = 12 ft²
 - Select Fuel Type: select **Lube Oil** from the combo box

Note: When **Lube Oil** is selected, its properties are automatically selected from the table and entered in the corresponding input cells.

Results*

| Heat Release Rate \dot{Q} kW (Btu/sec) | Burning Duration t_b (min) | Pool Fire Flame Height H_f m (ft) | |
|---|---------------------------------|--|------------------|
| | | Method of Heskestad | Method of Thomas |
| 2,000 (1,900) | 22.0 | 3.7 (12.1) | 2.9 (9.6) |

*spreadsheet calculations attached at the end of the problem

(b) Temperature_NV.xls

- Compartment Width (w_c) = 20 ft
- Compartment Length (l_c) = 15 ft
- Compartment Height (h_c) = 10 ft
- Vent Width (w_v) = 4 ft
- Vent Height (h_v) = 6 ft
- Top of Vent from Floor (V_T) = 6 ft
- Interior Lining Thickness (δ) = 12 in
- Select Material: select **Concrete** from the combo box

Note: When **Concrete** is selected, its properties are automatically selected from the table and entered in the corresponding input cells.

Results*

| Time (min) | Hot Gas Layer Temperature T_g °C (°F) | Gas Layer Height z m (ft) |
|------------|---|---------------------------|
| 0 | 25 (77) | 3.05 (10) |
| 1 | 279 (534) | 0.24 (0.77) |
| 2 | 310 (590) | 0.22 (0.72) |
| 3 | 330 (626) | 0.21 (0.69) |
| 4 | 345 (653) | 0.20 (0.67) |
| 5 | 357 (675) | 0.20 (0.65) |
| 10 | 398 (748) | 0.18 (0.61) |
| 15 | 424 (795) | 0.18 (0.58) |
| 20 | 443 (830) | 0.17 (0.56) |

*spreadsheet calculations attached at the end of the problem

(c) Plume_Temperature_Calculations.xls

- Heat Release Rate (\dot{Q}) = 2,000 kW
- Distance from the Top of the Fuel to the Ceiling (z) = 10 ft
- Area of Combustible Fuel: 12 ft²

Results*

| Heat Release Rate \dot{Q} (kW) | Plume Centerline Temperature $T_{p(\text{centerline})}$ °C (°F) |
|----------------------------------|---|
| 2,000 | 561 (1,042) |

*spreadsheet calculations attached at the end of the problem

(d) Heat_Flux_Calculations_Wind_Free.xls

Point Source (heat flux to the electrical cabinet)

- Fuel Spill Area or Dike Area (A_{dike}) = 12 ft²
 - Distance between Fire and Target (L) = 5 ft
 - Select Fuel Type: select **Lube Oil** from the combo box
- Solid Flame 2* (heat flux to the cable tray)
- Fuel Spill Area or Dike Area (A_{dike}) = 12 ft²

- Distance between Fire and Target (L) = 4 ft
 - Vertical Distance of Target from Ground ($H_1 = H_{11}$) = 8 ft
 - Select Fuel Type: select **Lube Oil** from the combo box
- Note:** When **Lube Oil** is selected, its properties are automatically selected from the table and entered in the corresponding input cells.

Results*

| Radiation Model | Target | Radiant Heat Flux \dot{q}'' kW/m ² (Btu/ft ² -sec) |
|-----------------|--------------------|--|
| Point Source | Electrical Cabinet | 12.4 (1.1) |
| Solid Flame | Cable Tray | 16.3 (1.4) |

*spreadsheet calculations attached at the end of the problem

(e) Detector_Activation_Time.xls

Sprinkler

- Heat Release Rate of the Fire (\dot{Q}) = 2,000 kW
 - Distance from the Top of the Fuel Package to the Ceiling (H) = 10 ft
 - Radial Distance from the Plume Centerline to the Sprinkler (r) = 9.8 ft
 - Ambient Air Temperature (T_a) = 77 °F
 - Select Type of Sprinkler = select **Standard response link** from the combo box
 - Select Sprinkler Classification = select **Ordinary** from the combo box
- Note:** **Standard response** is selected because it corresponds with the given RTI value. Also, **Ordinary** classification has been selected because the rated value for the sprinklers in this problem (165 °F) is within the range of temperature ratings for ordinary sprinklers (135 °F–170 °F).

Results*

| Sprinkler Type | Sprinkler Activation Time $t_{\text{activation}}$ (min.) |
|------------------------|---|
| Standard response link | 1.8 |

*spreadsheet calculations attached at the end of the problem

(f) Compartment_Flashover_Calculations.xls

- Compartment Width (w_c) = 20 ft
 - Compartment Length (l_c) = 15 ft
 - Compartment Height (h_c) = 10 ft
 - Vent Width (w_v) = 4 ft
 - Vent Height (h_v) = 6 ft
 - Interior Lining Thickness (δ) = 12 in
 - Select Material: select **Concrete** from the combo box
- Note:** When **Concrete** is selected, its properties are automatically selected from the table and entered in the corresponding input cells.

Results*

| HRR for Flashover \dot{Q}_{FO} kW (Btu/sec) | | |
|--|----------------------|------------------|
| Method of MQH | Method of Brabauskas | Method of Thomas |
| 836 (729) | 2,261 (2,143) | 2,064 (1,956) |

*spreadsheet calculations attached at the end of the problem

Conclusions

According to the calculations the fire could represent a hazard to the safety related targets (cable tray and electrical cabinets) due to the following results:

- From the pool fire analysis we obtain that the flame height is greater than the cable tray height. That means that the flame probably will impinge upon the cable trays since the pool is just at 4 ft from the cable tray (horizontal distance).
- The hot gas layer analysis estimates that the hot gas temperature will be 700+ °F and 500+ °F at 10 minutes and one (1) minute respectively. These temperature values are the critical temperatures for IEEE-383 qualified and unqualified cables respectively. Also the corridor will be almost filled with smoke at one minute after the ignition, which means that the cable tray and electrical cabinet will be rapidly exposed to the hot gas layer.
- Heat flux calculations show that the solid flame model predicts a radiant heat flux greater than the critical heat flux for IEEE-383 qualified and unqualified cables. Also the heat flux to the electrical cabinet could represent a hazard for the integrity of the cabinet components.
- The HRR of the fire is very close to the HRR for flashover. Therefore, the whole corridor could flashover. The sprinkler will activate approximately at 2 minute after the fire development, during this time the fire should begin to be controlled. The burning time of the pool is significantly greater than the activation time of the sprinklers, thus a complete and immediate extinguishment of the fire is not expected.

Spreadsheet Calculations

CHAPTER 3 - ESTIMATING THE HEAT RELEASE RATE, BURNING DURATION, AND FLAME HEIGHT FOR A LIQUID POOL FIRE

The following calculations estimate the heat release rate, burning duration, and flame height for liquid pool fire. Parameters should be specified ONLY IN THE YELLOW INPUT PARAMETER BOXES. All subsequent output values are calculated by the spreadsheet and based on values specified in the input parameters. This spreadsheet is protected and secure to avoid errors due to a wrong entry in a cell(s). The chapter in the NUREG should be read before an analysis is made.

INPUT PARAMETERS

| | | | |
|--|-------|------------------------|-----------------------|
| Fuel Spill Volume (V) | 20.00 | gallons | 0.0757 m ³ |
| Fuel Spill Area or Dike Area (A _{spill}) | 12.00 | ft ² | 1.115 m ² |
| Mass Burning Rate of Fuel (m ³) | 0.039 | kg/m ² -sec | |
| Effective Heat of Combustion of Fuel (H _{c,eff}) | 48000 | kJ/kg | |
| Fuel Density (ρ) | 780 | kg/m ³ | |
| Gravitational Acceleration (g) | 9.81 | m/sec ² | |
| Ambient Air Density (ρ _a) | 1.20 | kg/m ³ | |

THERMAL PROPERTIES DATA BURNING RATE DATA FOR LIQUID HYDROCARBON FUELS

| Fuel | Mass Burning Rate m ³ (kg/m ² -sec) | Heat of Combustion ΔH _{c,eff} (kJ/kg) | Density ρ (kg/m ³) | Select Fuel Type |
|------------------------------|--|---|-----------------------------------|--|
| Methanol | 0.017 | 20,000 | 798 | Lube Oil |
| Ethanol | 0.015 | 28,800 | 794 | Scroll to desired fuel type then Click on selection |
| Butane | 0.078 | 45,700 | 573 | |
| Benzene | 0.085 | 40,100 | 874 | |
| Hexane | 0.074 | 44,700 | 650 | |
| Heptane | 0.101 | 44,600 | 675 | |
| Xylene | 0.09 | 40,300 | 870 | |
| Acetone | 0.041 | 25,800 | 791 | |
| Dioxane | 0.018 | 28,200 | 1035 | |
| Diethyl Ether | 0.085 | 34,200 | 714 | |
| Benzine | 0.048 | 44,700 | 740 | |
| Gasoline | 0.055 | 43,700 | 740 | |
| Kerosene | 0.039 | 43,200 | 820 | |
| Diesel | 0.045 | 44,400 | 918 | |
| JP-4 | 0.051 | 43,500 | 780 | |
| JP-8 | 0.054 | 43,000 | 810 | |
| Transformer Oil, Hydrocarbon | 0.039 | 46,000 | 780 | |
| Fuel Oil, Heavy | 0.036 | 39,700 | 970 | |
| Crude Oil | 0.0335 | 42,600 | 855 | |
| Lube Oil | 0.039 | 46,000 | 780 | |

Reference: SFPE Handbook of Fire Protection Engineering, 2nd Edition, 1995, Page 3-2.

ESTIMATING POOL FIRE HEAT RELEASE RATE

Reference: *SFPE Handbook of Fire Protection Engineering*, 2nd Edition, 1995, Page 3-4.

$$Q = m^* H_{c,eff} A_f$$

Where Q = pool fire heat release rate (kW)
 m^* = mass burning rate of fuel per unit surface area (kg/m²-sec)
 $\Delta H_{c,eff}$ = effective heat of combustion of fuel (kJ/kg)
 $A_f = A_{disk}$ = surface area of pool fire (area involved in vaporization) (m²)

Heat Release Rate Calculation

(Liquids with relatively high flash point, like transformer oil, require localized heating to achieve ignition)

$$Q = m^* H_c A_f$$

| | | | |
|-------|------------|-----------------|--------|
| $Q =$ | 2000.02 kW | 1895.66 BTU/sec | ANSWER |
|-------|------------|-----------------|--------|

ESTIMATING POOL FIRE BURNING DURATION

Reference: *SFPE Handbook of Fire Protection Engineering*, 2nd Edition, 1995, Page 3-197.

$$t_b = 4V / D^2$$

Where t_b = burning duration of pool fire (sec)
 V = volume of liquid (m³)
 D = pool diameter (m)
 v = regression rate (m/sec)

Pool Fire Diameter Calculation

$$A_{disk} = D^2 / 4$$

$$D = \sqrt{4A_{disk} / v}$$

$$D = 1.191 \text{ m}$$

Calculation for Regression Rate

$$v = m^* / \rho$$

Where m^* = mass burning rate of fuel (kg/m²-sec)

ρ = liquid fuel density (kg/m³)

$$v = 0.000051 \text{ m/sec}$$

Burning Duration Calculation

$$t_b = 4V / D^2$$

| | | | |
|---------|-------------|---------------|--------|
| $t_b =$ | 1323.37 sec | 22.06 minutes | ANSWER |
|---------|-------------|---------------|--------|

Note that a liquid pool fire with a given amount of fuel can burn for long periods of time over small area or for short periods of time over a large area.

ESTIMATING POOL FIRE FLAME HEIGHT METHOD OF HESKESTAD

Reference: *SFPE Handbook of Fire Protection Engineering*, 2nd Edition, 1995, Page 2-10.

$$H_f = 0.235 Q^{2/5} - 1.02 D$$

Where H_f = pool fire flame height (m)
 Q = pool fire heat release rate (kW)
 D = pool fire diameter (m)

Pool Fire Flame Height Calculation

$$H_f = 0.235 Q^{2/5} - 1.02 D$$

| | | | |
|---------|--------|----------|--------|
| $H_f =$ | 3.70 m | 12.14 ft | ANSWER |
|---------|--------|----------|--------|

METHOD OF THOMAS

Reference: *SFPE Handbook of Fire Protection Engineering*, 2nd Edition, 1995, Page 3-204.

$$H_f = 42 D (m''/\rho_a v(g D))^{0.61}$$

Where H_f = pool fire flame height (m)

m'' = mass burning rate of fuel per unit surface area ($\text{kg/m}^2\text{-sec}$)

ρ_a = ambient air density (kg/m^3)

D = pool fire diameter (m)

g = gravitational acceleration (m/sec^2)

Pool Fire Flame Height Calculation

$$H_f = 42 D (m''/\rho_a v(g D))^{0.61}$$

$H_f =$ 2.92 m 9.59 ft **ANSWER**

NOTE

The above calculations are based on principles developed in the *SFPE Handbook of Fire Protection Engineering*, 2nd Edition, 1995. Calculations are based on certain assumptions and have inherent limitations. The results of such calculations may or may not have reasonable predictive capabilities for a given situation and should only be interpreted by an informed user. Although each calculation in the spreadsheet has been verified with the results of hand calculation, there is no absolute guarantee of the accuracy of these calculations. Any questions, comments, concerns, and suggestions, or to report an error(s) in the spreadsheets, please send an email to rd@nrc.gov.



CHAPTER 2 - PREDICTING HOT GAS LAYER TEMPERATURE AND SMOKE LAYER HEIGHT IN ROOM FIRE WITH NATURAL VENTILATION COMPARTMENT WITH THERMALLY THICK BOUNDARIES

The following calculations estimate the hot gas layer temperature and smoke layer height in enclosure fire. Parameters should be specified **ONLY IN THE YELLOW INPUT PARAMETER BOXES**. All subsequent output values are calculated by the spreadsheet and based on values specified in the input parameters. This spreadsheet is protected and secure to avoid errors due to a wrong entry in a cell(s). The chapter in the NUREG should be read before an analysis is made.

INPUT PARAMETERS

COMPARTMENT INFORMATION

| | | |
|----------------------------------|----------|----------|
| Compartment Width (w_c) | 20.00 ft | 6.096 m |
| Compartment Length (l_c) | 15.00 ft | 4.572 m |
| Compartment Height (h_c) | 10.00 ft | 3.048 m |
| | | |
| Vent Width (w_v) | 4.00 ft | 1.219 m |
| Vent Height (h_v) | 6.00 ft | 1.829 m |
| Top of Vent from Floor (V_T) | 6.00 ft | 1.829 m |
| Interior Lining Thickness () | 12.00 in | 0.3048 m |

For thermally thick case the interior lining thickness should be greater than 1 inch.

AMBIENT CONDITIONS

| | | |
|-----------------------------------|------------------------|----------------------|
| Ambient Air Temperature (T_a) | 77.00 °F | 25.00 °C 298.00 K |
| | | |
| Specific Heat of Air (c_p) | 1.00 kJ/kg-K | |
| Ambient Air Density (ρ_a) | 1.20 kg/m ³ | |

THERMAL PROPERTIES OF COMPARTMENT ENCLOSING SURFACES FOR

| | |
|--|--|
| Interior Lining Thermal Inertia ($k c$) | 2.9 (kW/m ² -K) ² -sec |
| Interior Lining Thermal Conductivity (k) | 0.0016 kW/m-K |
| Interior Lining Specific Heat (c) | 0.75 kJ/kg-K |
| Interior Lining Density () | 2400 kg/m ³ |

EXPERIMENTAL THERMAL PROPERTIES FOR COMMON INTERIOR LINING MATERIALS

| Material | k c (kW/m ² -K) ² -sec | k (kW/m-K) | c (kJ/kg-K) | (kg/m ³) | Select Material <input type="text" value="Concrete"/> |
|------------------------|---|---------------|----------------|----------------------|--|
| Aluminum (pure) | 500 | 0.206 | 0.895 | 2710 | Scroll to desired material then Click the selection |
| Steel (0.5% Carbon) | 197 | 0.054 | 0.465 | 7850 | |
| Concrete | 2.9 | 0.0016 | 0.75 | 2400 | |
| Brick | 1.7 | 0.0008 | 0.8 | 2600 | |
| Glass, Plate | 1.6 | 0.00076 | 0.8 | 2710 | |
| Brick/Concrete Block | 1.2 | 0.00073 | 0.84 | 1900 | |
| Gypsum Board | 0.18 | 0.00017 | 1.1 | 960 | |
| Plywood | 0.16 | 0.00012 | 2.5 | 540 | |
| Fiber Insulation Board | 0.16 | 0.00053 | 1.25 | 240 | |
| Chipboard | 0.15 | 0.00015 | 1.25 | 800 | |
| Aerated Concrete | 0.12 | 0.00026 | 0.96 | 500 | |
| Plasterboard | 0.12 | 0.00016 | 0.84 | 950 | |
| Calcium Silicate Board | 0.098 | 0.00013 | 1.12 | 700 | |
| Alumina Silicate Block | 0.036 | 0.00014 | 1 | 260 | |
| Glass Fiber Insulation | 0.0018 | 0.000037 | 0.8 | 60 | |
| Expanded Polystyrene | 0.001 | 0.000034 | 1.5 | 20 | |

Reference: Klote, J., J. Milke, *Principles of Smoke Management*, 2002, Page 270.

FIRE SPECIFICATIONS

Fire Heat Release Rate (Q)

2000.00 kW**METHOD OF McCAFFREY, QUINTIERE, AND HARKLEROAD (MQH)**Reference: SFPE Handbook of Fire Protection Engineering, 2nd Edition, Page 3-139.

$$\Delta T_g = 6.85[Q^2/(A_v(h_v)^{1/2})(A_T h_k)]^{1/3}$$

Where $\Delta T_g = T_g - T_a$ = upper layer gas temperature rise above ambient (K)
 Q = heat release rate of the fire (kW)
 A_v = area of ventilation opening (m²)
 h_v = height of ventilation opening (m)
 h_k = convective heat transfer coefficient (kW/m²-K)
 A_T = total area of the compartment enclosing surface boundaries excluding area of vent openings (m²)

Area of Ventilation Opening Calculation

$$A_v = (w_v)(h_v)$$

$$A_v = 2.23 \text{ m}^2$$

Thermal Penetration Time Calculation**Thermally Thick Material**

$$t_p = (\rho c_p/k)(\delta/2)^2$$

Where ρ = interior construction density (kg/m³)
 c_p = interior construction heat capacity (kJ/kg-K)
 k = interior construction thermal conductivity (kW/m-K)
 δ = interior construction thickness (m)

$$t_p = 26128.98 \text{ sec}$$

Heat Transfer Coefficient Calculation

$$h_k = v(k\rho c/t) \quad \text{for } t < t_p$$

Where $k\rho c$ = interior construction thermal inertia (kW/m²-K)²-sec
 (a thermal property of material responsible for the rate of temperature rise)
 t = time after ignition (sec)

Area of Compartment Enclosing Surface Boundaries

$$A_T = [2(w_c \times l_c) + 2(h_c \times w_c) + 2(h_c \times l_c)] - A_v$$

$$A_T = 118.54 \text{ m}^2$$

Compartment Hot Gas Layer Temperature With Natural Ventilation

$$\Delta T_g = 6.85[Q^2/(A_v(h_v)^{1/2})(A_T h_k)]^{1/3}$$

$$\Delta T_g = T_g - T_a$$

$$T_g = \Delta T_g + T_a$$

RESULTS

| Time after Ignition (t) | | h_k (kW/m ² -K) | ΔT_g (K) | T_g (K) | T_g (°C) | T_g (°F) |
|-------------------------|------|---------------------------------|---------------------|--------------|---------------|---------------|
| (min) | (s) | | | | | |
| 0 | 0.00 | - | - | 298.00 | 25.00 | 77.00 |
| 1 | 60 | 0.22 | 253.86 | 651.86 | 278.86 | 533.96 |
| 2 | 120 | 0.16 | 284.95 | 582.95 | 309.95 | 589.91 |
| 3 | 180 | 0.13 | 304.87 | 602.87 | 329.87 | 625.77 |
| 4 | 240 | 0.11 | 319.85 | 617.85 | 344.85 | 652.73 |
| 5 | 300 | 0.10 | 331.97 | 629.97 | 356.97 | 674.54 |
| 10 | 600 | 0.07 | 372.62 | 670.62 | 397.62 | 747.72 |
| 15 | 900 | 0.06 | 398.67 | 696.67 | 423.67 | 794.61 |
| 20 | 1200 | 0.05 | 418.25 | 716.25 | 443.25 | 829.86 |

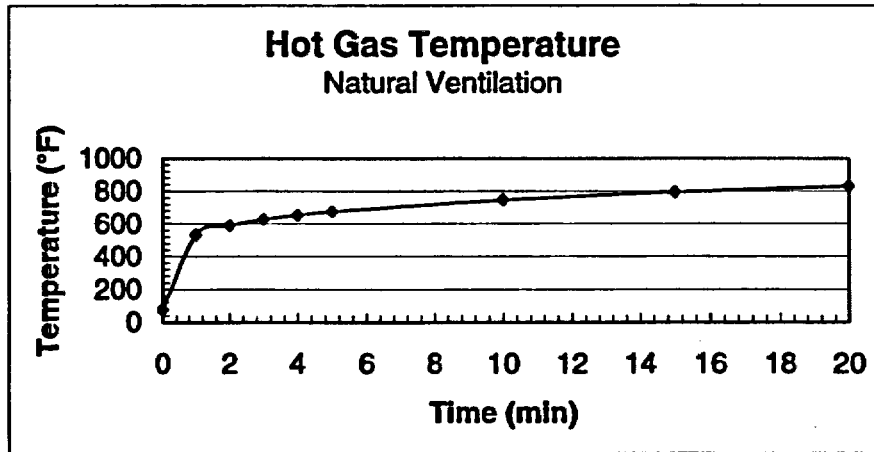

ESTIMATING SMOKE LAYER HEIGHT METHOD OF YAMANA AND TANAKA

$$z = ((2kQ^{1/3}/3A_c) + (1/h_c^{2/3})^{-3/2}$$

Where z = smoke layer height (m)
 Q = heat release rate of the fire (kW)
 t = time after ignition (sec)
 h_c = compartment height (m)
 A_c = compartment floor area (m²)
 k = a constant given by $k = 0.076/\rho_g$
 ρ_g = hot gas layer density (kg/m³)
 ρ_g is given by $\rho_g = 353/T_g$
 T_g = hot gas layer temperature (K)

Compartment Area Calculation

$$A_c = (w_c)(L_c)$$

$$A_c = 27.87 \text{ m}^2$$

Hot Gas Layer Density Calculation

$$\rho_g = 353/T_g$$

Calculation for Constant K

$$k = 0.076/\rho_g$$

Smoke Gas Layer Height With Natural Ventilation

$$z = ((2kQ^{1/3}/3A_c) + (1/h_c^{2/3})^{-3/2}$$

RESULTS

| Time (min) | ρ_g (kg/m ³) | k (kW/m-K) | z (m) | z (ft) |
|------------|-------------------------------|------------|-------|--------|
| 0 | 1.20 | 0.063 | 3.05 | 10.00 |
| 1 | 0.64 | 0.119 | 0.24 | 0.77 |
| 2 | 0.61 | 0.126 | 0.22 | 0.72 |
| 3 | 0.59 | 0.130 | 0.21 | 0.69 |
| 4 | 0.57 | 0.133 | 0.20 | 0.67 |
| 5 | 0.56 | 0.136 | 0.20 | 0.65 |
| 10 | 0.53 | 0.144 | 0.18 | 0.61 |
| 15 | 0.51 | 0.150 | 0.18 | 0.58 |
| 20 | 0.49 | 0.154 | 0.17 | 0.56 |

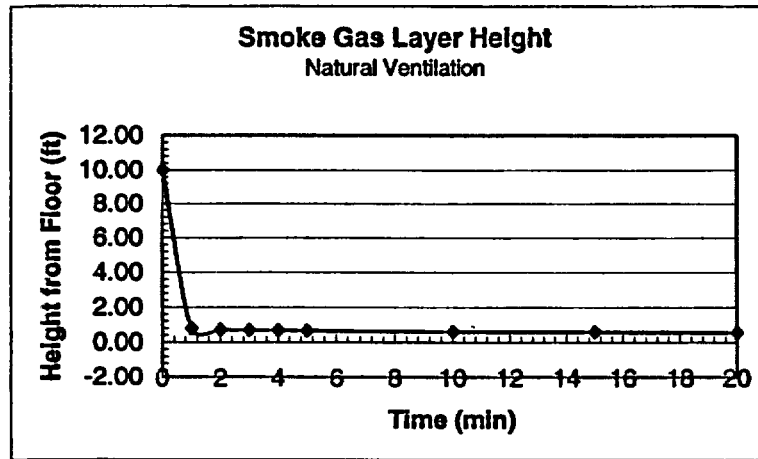

NOTE

The above calculations are based on principles developed in the SFPE Handbook of Fire Protection Engineering, 2nd Edition, 1995.

Calculations are based on certain assumptions and have inherent limitations. The results of such calculations may or may not have reasonable predictive capabilities for a given situation, and should only be interpreted by an informed user.

Although each calculation in the spreadsheet has been verified with the results of hand calculation, there is no absolute guarantee of the accuracy of these calculations.

Any questions, comments, concerns, and suggestions, or to report an error(s) in the spreadsheet, please send an email to nxi@nrc.gov.



CHAPTER 9 - ESTIMATING CENTERLINE TEMPERATURE OF A BUOYANT FIRE PLUME

The following calculations estimate the centerline plume temperature in a compartment fire. Parameters should be specified **ONLY IN THE YELLOW INPUT PARAMETER BOXES**. All subsequent output values are calculated by the spreadsheet and based on values specified in the input parameters. This spreadsheet is protected and secure to avoid errors due to a wrong entry in a cell(s). The chapter in the NUREG should be read before an analysis is made.

INPUT PARAMETERS

| | | |
|--|-------------------------|----------------------|
| Heat Release Rate of the Fire (Q) | 2000.00 kW | |
| Distance from the Top of the Fuel to the Ceiling (z) | 10.00 ft | 3.05 m |
| Area of Combustible Fuel (A _c) | 12.00 ft ² | 1.11 m ² |
| AMBIENT CONDITIONS | | |
| Ambient Air Temperature (T _a) | 77.00 °F | 25.00 °C 298.00 K |
| Specific Heat of Air (c _p) | 1.00 kJ/kg-K | |
| Ambient Air Density (ρ _a) | 1.20 kg/m ³ | |
| Acceleration of Gravity (g) | 9.81 m/sec ² | |
| Convective Heat Release Fraction (χ _c) | 0.50 | |

ESTIMATING PLUME CENTERLINE TEMPERATURE

Reference: SFPE Handbook of Fire Protection Engineering, 2nd Edition, 1995, Page 2-9.

$$T_{p(\text{centerline})} - T_a = 9.1 (T_a/g c_p^2 \rho_a^2)^{1/3} Q_c^{2/3} (z - z_0)^{-5/3}$$

- Where
- Q_c = convective portion of the heat release rate (kW)
 - T_a = ambient air temperature (K)
 - g = acceleration of gravity (m/sec²)
 - c_p = specific heat of air (kJ/kg-K)
 - ρ_a = ambient air density (kg/m³)
 - z = distance from the top of the fuel package to the ceiling (m)
 - z₀ = hypothetical virtual origin of the fire (m)

Convective Heat Release Rate Calculation

$$Q_c = \chi_c Q$$

- Where
- Q = heat release rate of the fire (kW)
 - χ_c = convective heat release fraction
 - Q_c = 1000 kW

Pool Fire Diameter Calculation

$$A_c = D^2/4$$

$$D = \sqrt{4 A_c}$$

$$D = 1.19 \text{ m}$$

Hypothetical Virtual Origin Calculation

$$z_0/D = -1.02 + 0.083 (Q^{2/3})/D$$

Where z_0 = virtual origin of the fire (m)
 Q = heat release rate of fire (kW)
 D = diameter of pool fire (m)

$$z_0/D = 0.44$$
$$z_0 = 0.52 \text{ m}$$

Centerline Plume Temperature Calculation

$$T_{p(\text{centerline})} - T_a = 9.1 (T_a/g c_p^2 \rho_a^2)^{1/3} Q_c^{2/3} (z - z_0)^{-5/3}$$

$$T_{p(\text{centerline})} - T_a = 536.16$$
$$T_{p(\text{centerline})} = 834.16 \text{ K}$$

| | | | |
|------------------------------|------------------|-------------------|---------------|
| $T_{p(\text{centerline})} =$ | 561.16 °C | 1042.08 °F | ANSWER |
|------------------------------|------------------|-------------------|---------------|

NOTE

The above calculations are based on principles developed in the SFPE Handbook of Fire Protection Engineering, 2nd Edition, 1995. Calculations are based on certain assumptions and have inherent limitations. The results of such calculations may or may not have reasonable predictive capabilities for a given situation, and should only be interpreted by an informed user. Although each calculation in the spreadsheet has been verified with the results of hand calculation, there is no absolute guarantee of the accuracy of these calculations. Any questions, comments, concerns, and suggestions, or to report an error(s) in the spreadsheet, please send an email to nxi@nrc.gov.



**CHAPTER 5 - ESTIMATING RADIANT HEAT FLUX FROM FIRE
TO A TARGET FUEL AT GROUND LEVEL UNDER WIND-FREE CONDITION
POINT SOURCE RADIATION MODEL**

The following calculations estimate the radiative heat flux from a fire to a target fuel.
The purpose of this calculation is to estimate the radiation transmitted from a burning fuel array to a target fuel positioned some distance from the fire at ground level to determine if secondary ignitions are likely with no wind. Parameters should be specified **ONLY IN THE YELLOW INPUT PARAMETER BOXES**. All subsequent output values are calculated by the spreadsheet and based on values specified in the input parameters. This spreadsheet is protected and secure to avoid errors due to a wrong entry in a cell(s). The chapter in the NUREG should be read before an analysis is made.

INPUT PARAMETERS

| | | |
|--|------------------------------|---------------------|
| Mass Burning Rate of Fuel (\dot{m}) | 0.039 kg/m ² -sec | |
| Effective Heat of Combustion of Fuel ($H_{c,eff}$) | 46000 kJ/kg | |
| Fuel Area or Dike Area (A_{fuel}) | 12.00 ft ² | 1.11 m ² |
| Distance between Fire and Target (L) | 5.00 ft | 1.524 m |
| Radiative Fraction (α) | 0.35 | |

THERMAL PROPERTIES DATA

BURNING RATE DATA FOR FUELS

| Fuel | Mass Burning Rate m ² (kg/m ² -sec) | Heat of Combustion $\Delta H_{c,eff}$ (kJ/kg) | Density (kg/m ³) | Select Fuel Type |
|-----------------------------|--|--|---------------------------------|--|
| Methanol | 0.017 | 20,000 | 796 | Lube Oil |
| Ethanol | 0.015 | 26,800 | 794 | Scroll to desired fuel type then Click on selection |
| Butane | 0.078 | 45,700 | 573 | |
| Benzene | 0.085 | 40,100 | 874 | |
| Hexane | 0.074 | 44,700 | 650 | |
| Heptane | 0.101 | 44,600 | 675 | |
| Xylene | 0.09 | 40,800 | 870 | |
| Acetone | 0.041 | 25,800 | 791 | |
| Dioxane | 0.018 | 26,200 | 1035 | |
| Diethyl Ether | 0.085 | 34,200 | 714 | |
| Benzine | 0.048 | 44,700 | 740 | |
| Gasoline | 0.055 | 43,700 | 740 | |
| Kerosine | 0.039 | 43,200 | 820 | |
| Diesel | 0.045 | 44,400 | 918 | |
| JP-4 | 0.051 | 43,500 | 780 | |
| JP-5 | 0.054 | 43,000 | 810 | |
| Transformer Oil, Hydrocarbo | 0.039 | 46,000 | 760 | |
| Fuel Oil, Heavy | 0.035 | 39,700 | 970 | |
| Crude Oil | 0.0335 | 42,600 | 855 | |
| Lube Oil | 0.039 | 46,000 | 760 | |
| Douglas Fir Plywood | 0.01082 | 10,900 | 500 | |

Reference: SFPE Handbook of Fire Protection Engineering, 2nd Edition, 1995, Page 3-2.

ESTIMATING RADIATIVE HEAT FLUX TO A TARGET FUEL

Reference: SFPE Handbook of Fire Protection Engineering, 3rd Edition, 2002, Page 3-272.

POINT SOURCE RADIATION MODEL

$$q'' = Q / 4 R^2$$

Where

q'' = incident radiative heat flux on the target (kW/m²)

Q = pool fire heat release rate (kW)

χ_r = radiative fraction

R = distance from center of the pool fire to edge of the target (m)

Pool Fire Diameter Calculation

$$A_{disk} = D^2/4$$

$$D = \sqrt{4 A_{disk}}$$

$$D = 1.19 \text{ m}$$

Heat Release Rate Calculation

$$Q = m'' \Delta H_c A_{disk}$$

Where

Q = pool fire heat release rate (kW)

m'' = mass burning rate of fuel per unit surface area (kg/m²-sec)

ΔH_c = effective heat of combustion of fuel (kJ/kg)

A = surface area of pool fire (area involved in vaporization) (m²)

$$Q = 2000.02 \text{ kW}$$

Distance from Center of the Fire to Edge of the Target Calculation

$$R = L + D/2$$

Where

R = distance from center of the pool fire to edge of the target (m)

L = distance between pool fire and target (m)

D = pool fire diameter (m)

$$R = 2.12 \text{ m}$$

Radiative Heat Flux Calculation

$$q'' = Q / 4 R^2$$

| | | | |
|---------|-------------------------|-------------------------------|---------------|
| $q'' =$ | 12.40 kW/m ² | 1.09 BTU/ft ² -sec | ANSWER |
|---------|-------------------------|-------------------------------|---------------|

CRITICAL HEAT FLUX FOR CABLES FAILURE

| Cable Type | Damage Threshold (kW/m ²) | Heat Flux |
|------------|--|-----------|
|------------|--|-----------|

| | | |
|--------------------|----|--|
| IEEE-383 qualified | 10 | |
|--------------------|----|--|

| | | |
|----------------------|---|--|
| IEEE-383 unqualified | 5 | |
|----------------------|---|--|

Reference: EPRI 100370, Fire-Induced Vulnerability Evaluation (FIVE), April 1992, page 10.4-7.

NOTE

The above calculations are based on principles developed in the SFPE Handbook of Fire Protection Engineering, 3rd Edition, 2002.

Calculations are based on certain assumptions and have inherent limitations. The results of such calculations may or may not have reasonable predictive capabilities for a given situation, and should only be interpreted by an informed user.

Although each calculation in the spreadsheet has been verified with the results of hand calculation, there is no absolute guarantee of the accuracy of these calculations.

Any questions, comments, concerns, and suggestions, or to report an error(s) in the spreadsheet, please send an email to rxl@nrc.gov.



Office of Nuclear Reactor Regulation

**CHAPTER 5 - ESTIMATING RADIANT HEAT FLUX FROM FIRE TO A TARGET FUEL ABOVE GROUND LEVEL UNDER WIND-FREE CONDITION
SOLID FLAME RADIATION MODEL**

The following calculations estimate the radiative heat flux from fire to a target fuel.
The purpose of this calculation is to estimate the radiation transmitted from a burning fuel array to a target fuel positioned some distance from the fire above ground level to determine if secondary ignitions are likely with no wind.
Parameters should be specified **ONLY IN THE RED INPUT PARAMETER BOXES**.
All subsequent output values are calculated by the spreadsheet and based on values specified in the input parameters. This spreadsheet is protected and secure to avoid errors due to a wrong entry in a cell(s).
The chapter in the NUREG should be read before an analysis is made.

INPUT PARAMETERS

| | | | |
|--|-------|------------------------|---------------------|
| Mass Burning Rate of Fuel (m'') | 0.039 | kg/m ² -sec | |
| Effective Heat of Combustion of Fuel ($H_{c,eff}$) | 46000 | kJ/kg | |
| Fuel Area or Dike Area (A_{fuel}) | 12.00 | ft ² | 1.11 m ² |
| Distance between Fire and Target (L) | 4.00 | ft | 1.2192 m |
| Vertical Distance of Target from Ground ($H_1 = H_{t1}$) | 8.00 | ft | 2.4384 m |

THERMAL PROPERTIES DATA

BURNING RATE DATA FOR FUELS

| Fuel | Mass Burning Rate m'' (kg/m ² -sec) | Heat of Combustion $\Delta H_{c,eff}$ (kJ/kg) | Density (kg/m ³) | Select Fuel Type |
|------------------------------|---|--|---------------------------------|--|
| Methanol | 0.017 | 20,000 | 796 | Lube Oil |
| Ethanol | 0.015 | 26,800 | 794 | Scroll to desired fuel type then Click on selection |
| Butane | 0.078 | 45,700 | 573 | |
| Benzene | 0.085 | 40,100 | 874 | |
| Hexane | 0.074 | 44,700 | 650 | |
| Heptane | 0.101 | 44,600 | 675 | |
| Xylene | 0.09 | 40,800 | 870 | |
| Acetone | 0.041 | 25,800 | 791 | |
| Dioxane | 0.018 | 26,200 | 1035 | |
| Diethyl Ether | 0.085 | 34,200 | 714 | |
| Benzine | 0.048 | 44,700 | 740 | |
| Gasoline | 0.055 | 43,700 | 740 | |
| Kerosene | 0.039 | 43,200 | 820 | |
| Diesel | 0.045 | 44,400 | 918 | |
| JP-4 | 0.051 | 43,500 | 760 | |
| JP-5 | 0.054 | 43,000 | 810 | |
| Transformer Oil, Hydrocarbon | 0.039 | 46,000 | 760 | |
| Fuel Oil, Heavy | 0.035 | 39,700 | 970 | |
| Crude Oil | 0.0335 | 42,600 | 855 | |
| Lube Oil | 0.039 | 46,000 | 760 | |
| Douglas Fir Plywood | 0.01082 | 10,900 | 500 | |

Reference: SFPE Handbook of Fire Protection Engineering, 2nd Edition, 1995, Page 3-2.

ESTIMATING RADIATIVE HEAT FLUX TO A TARGET FUEL

Reference: SFPE Handbook of Fire Protection Engineering, 3rd Edition, 2002, Page 3-276.

SOLID FLAME RADIATION MODEL

$$q'' = EF_{1 \rightarrow 2}$$

Where q'' = incident radiative heat flux on the target (kW/m²)
 E = emissive power of the pool fire flame (kW/m²)
 $F_{1 \rightarrow 2}$ = view factor between target and the flame

Pool Fire Diameter Calculation

$$A_{\text{base}} = \pi D^2/4$$

$$D = \sqrt{(4 A_{\text{base}}/\pi)}$$

$$D = 1.19 \text{ m}$$

Emissive Power Calculation

$$E = 58 (10^{-0.00223 D})$$

$$E = 58.71 \text{ (kW/m}^2\text{)}$$

View Factor Calculation

$$F_{1 \rightarrow 2, V1} = \frac{1/(\pi S) \tan^{-1}(h_1/(S^2-1)^{1/2}) - (h_1/\pi S) \tan^{-1}((S-1)/(S+1))^{1/2} + A_1 h_1 / \pi S (A_1^2-1)^{1/2} \tan^{-1}((A_1+1)(S-1)/(A_1-1)(S+1))^{1/2}}{1/(\pi S) \tan^{-1}(h_2/(S^2-1)^{1/2}) - (h_2/\pi S) \tan^{-1}((S-1)/(S+1))^{1/2} + A_2 h_2 / \pi S (A_2^2-1)^{1/2} \tan^{-1}((A_2+1)(S-1)/(A_2-1)(S+1))^{1/2}}$$

$$F_{1 \rightarrow 2, V2} = \frac{1/(\pi S) \tan^{-1}(h_1/(S^2-1)^{1/2}) - (h_1/\pi S) \tan^{-1}((S-1)/(S+1))^{1/2} + A_1 h_1 / \pi S (A_1^2-1)^{1/2} \tan^{-1}((A_1+1)(S-1)/(A_1-1)(S+1))^{1/2}}{1/(\pi S) \tan^{-1}(h_2/(S^2-1)^{1/2}) - (h_2/\pi S) \tan^{-1}((S-1)/(S+1))^{1/2} + A_2 h_2 / \pi S (A_2^2-1)^{1/2} \tan^{-1}((A_2+1)(S-1)/(A_2-1)(S+1))^{1/2}}$$

$$A_1 = (h_1^2 + S^2 + 1)/2S$$

$$A_2 = (h_2^2 + S^2 + 1)/2S$$

$$B = (1 + S^2)/2S$$

$$S = 2R/D$$

$$h_1 = 2H_1/D$$

$$h_2 = 2H_2/D$$

$$F_{1 \rightarrow 2, V} = F_{1 \rightarrow 2, V1} + F_{1 \rightarrow 2, V2}$$

Where $F_{1 \rightarrow 2, V}$ = total vertical view factor
 R = distance from center of the pool fire to edge of the target (m)
 H_1 = height of the pool fire flame (m)
 D = pool fire diameter (m)

Distance from Center of the Pool Fire to Edge of the Target Calculation

$$R = L + D/2 = 1.815 \text{ m}$$

Heat Release Rate Calculation

$$Q = m'' \Delta H_c A_f$$

$$Q = 2000.02 \text{ kW}$$

Pool Fire Flame Height Calculation

$$H_f = 0.235 Q^{2/5} - 1.02 D$$

$$H_f = 3.699 \text{ m}$$

$$S = 2R/D = 3.047$$

$$h_1 = 2H_1/D = 4.093$$

$$h_2 = 2H_2/D = 2(H_2 - H_1)/D = 2.117$$

$$A_1 = (h_1^2 + S^2 + 1)/2S = 4.437$$

$$A_2 = (h_2^2 + S^2 + 1)/2S = 2.423$$

$$B = (1 + S^2)/2S = 1.687$$

| | | | | | | |
|--|-------|----------|----------|----------|----------|---------------------------|
| $F_{1 \rightarrow 2, V1} =$ | 0.156 | F_{V1} | F_{V2} | F_{V3} | F_{V4} | $F_{1 \rightarrow 2, V1}$ |
| $F_{1 \rightarrow 2, V2} =$ | 0.132 | F_{V1} | 0.100 | 0.264 | 0.439 | 0.730 |
| $F_{1 \rightarrow 2, V} = F_{1 \rightarrow 2, V1} + F_{1 \rightarrow 2, V2} =$ | 0.288 | 0.066 | F_{V2} | 0.137 | 0.243 | 0.834 |
| | | | F_{V3} | | | 0.158 |
| | | | | F_{V4} | | $F_{1 \rightarrow 2, V2}$ |

Radiative Heat Flux Calculation

$q'' = EF_{1 \rightarrow 2}$

| | | | |
|---------|-------------------------------|------------------------------------|---------------|
| $q'' =$ | 16.34 kW/m² | 1.44 BTU/ft²-sec | ANSWER |
|---------|-------------------------------|------------------------------------|---------------|

CRITICAL HEAT FLUX FOR CABLES FAILURE

| Cable Type | Damage Threshold (kW/m ²) | Heat Flux |
|----------------------|--|-----------|
| IEEE-383 qualified | | 10 |
| IEEE-383 unqualified | | 5 |

Reference: EPRI 100370, Fire-Induced Vulnerability Evaluation (FIVE), April 1992, page 10.4-7.

NOTE

The above calculations are based on principles developed in the SFPE Handbook of Fire Protection Engineering, 3rd Edition, 2002.

Calculations are based on certain assumptions and have inherent limitations. The results of such calculations may or may not have reasonable predictive capabilities for a given situation, and should only be interpreted by an informed user.

Although each calculation in the spreadsheet has been verified with the results of hand calculation, there is no absolute guarantee of the accuracy of these calculations.

Any questions, comments, concerns, and suggestions, or to report an error(s) in the spreadsheet, please send an email to nxd@nrc.gov.



CHAPTER 10 - ESTIMATING SPRINKLER RESPONSE TIME

The following calculations estimate sprinkler activation time. Parameters should be specified **ONLY IN THE YELLOW INPUT PARAMETER BOXES**. All subsequent output values are calculated by the spreadsheet and based on values specified in the input parameters. This spreadsheet is protected and secure to avoid errors due to a wrong entry in a cell(s). The chapter in the NUREG should be read before an analysis is made.

INPUT PARAMETERS

| | | | |
|--|---------|------------------------|----------|
| Heat Release Rate of the Fire (Q) | 2000.00 | kW | |
| Sprinkler Response Time Index (RTI) | 235 | (m-sec) ^{1/2} | |
| Activation Temperature of the Sprinkler (T _{activation}) | 165 | °F | 73.89 °C |
| Distance from the Top of the Fuel Package to the Ceiling (H) | 10.00 | ft | 3.05 m |
| Radial Distance from the Plume Centerline to the Sprinkler (r) | 9.80 | ft | 2.99 m |
| Ambient Air Temperature (T _a) | 77.00 | °F | 25.00 °C |
| | | | 298.00 K |
| Convective Heat Release Fraction (α) | 0.70 | | |
| r/H = | 0.98 | | |

GENERIC SPRINKLER RESPONSE TIME INDEX (RTI)*

| Common Sprinkler Type | Generic Response Time Index RTI (m-sec) ^{1/2} | Select Type of Sprinkler |
|------------------------|---|--------------------------|
| Standard response bulb | 235 | Standard response bulb |
| Standard response link | 130 | |
| Quick response bulb | 42 | |
| Quick response link | 34 | |

Scroll to desired sprinkler type then Click on selection

Reference: Madrzykowski, D., "Evaluation of Sprinkler Activation Prediction Methods" ASIAFLAM'95, International Conference on Fire Science and Engineering, 1st Proceeding, March 15-18, 1995, Kowloon, Hong Kong, pp. 211-218.

*Note: The actual RTI should be used when the value is available.

GENERIC SPRINKLER TEMPERATURE RATING (T_{activation})

| Temperature Classification | Range of Temperature Ratings (°F) | Generic Temperature Ratings (°F) | Select Sprinkler Classification |
|----------------------------|--------------------------------------|-------------------------------------|---------------------------------|
| Ordinary | 135 to 170 | 165 | Ordinary |
| Intermediate | 175 to 225 | 212 | |
| High | 250 to 300 | 275 | |
| Extra high | 325 to 375 | 350 | |
| Very extra high | 400 to 475 | 450 | |
| Ultra high | 500 to 575 | 550 | |
| Ultra high | 650 | 550 | |

Scroll to desired sprinkler class then Click on selection

Reference: Automatic Sprinkler Systems Handbook, 6th Edition, National Fire Protection Association, Quincy, Massachusetts, 1994, Page 67.

*Note: The actual temperature rating should be used when the value is available.

ESTIMATING SPRINKLER RESPONSE TIME

Reference: NFPA Fire Protection Handbook, 18th Edition, 1997, Page 11-97.

$$t_{activation} = (RTI / (v_{jet})) \cdot (\ln(T_{jet} - T_a) / (T_{jet} - T_{activation}))$$

- Where
- t_{activation} = sprinkler activation response time (sec)
 - RTI = sprinkler response time index (m-sec)^{1/2}
 - v_{jet} = ceiling jet velocity (m/sec)
 - T_{jet} = ceiling jet temperature (°C)
 - T_a = ambient air temperature (°C)
 - T_{activation} = activation temperature of sprinkler (°C)

Ceiling Jet Temperature Calculation

$$T_{jet} - T_a = 16.9 (Q_c)^{2/3} / H^{5/3} \quad \text{for } r/H = 0.18$$

$$T_{jet} - T_a = 5.38 (Q_c/r)^{2/3} / H \quad \text{for } r/H > 0.18$$

Where T_{jet} = ceiling jet temperature (°C)
 T_a = ambient air temperature (°C)
 Q_c = convective portion of the heat release rate (kW)
 H = distance from the top of the fuel package to the ceiling level (m)
 r = radial distance from the plume centerline to the sprinkler (m)

Convective Heat Release Rate Calculation

$$Q_c = \chi_c Q$$

Where Q = heat release rate of the fire (kW)
 χ_c = convective heat release fraction

$$Q_c = 1400 \text{ kW}$$

Radial Distance to Ceiling Height Ratio Calculation

$$r/H = 0.98 \text{ } r/H > 0.15$$

$$T_{jet} - T_a = (5.38 (Q_c/r)^{2/3})/H$$

$$T_{jet} - T_a = 106.50$$

$$T_{jet} = 131.50 \text{ (°C)}$$

Ceiling Jet Velocity Calculation

$$u_{jet} = 0.96 (Q/H)^{1/3} \quad \text{for } r/H = 0.15$$

$$u_{jet} = (0.195 Q^{1/3} H^{1/2})/r^{5/6} \quad \text{for } r/H > 0.15$$

u_{jet} = ceiling jet velocity (m/sec)
 Q = heat release rate of the fire (kW)
 H = distance from the top of the fuel package to the ceiling (m)
 r = radial distance from the plume centerline to the sprinkler (m)

Radial Distance to Ceiling Height Ratio Calculation

$$r/H = 0.98 \text{ } r/H > 0.15$$

$$u_{jet} = (0.195 Q^{1/3} H^{1/2})/r^{5/6}$$

$$u_{jet} = 1.723 \text{ m/sec}$$

Sprinkler Activation Time Calculation

$$t_{activation} = (RTI/(v u_{jet})) (\ln (T_{jet} - T_a)/(T_{jet} - T_{activation}))$$

$$t_{activation} = 109.99 \text{ sec}$$

The sprinkler will respond in approximately 1.83 minutes . ANSWER

NOTE: If $t_{activation} = \text{"NUM"}$ Sprinkler does not activate

NOTE

The above calculations are based on principles developed in the NFPA Fire Protection Handbook 18th Edition, 1997. Calculations are based on certain assumptions and have inherent limitations. The results of such calculations may or may not have reasonable predictive capabilities for a given situation, and should only be interpreted by an informed user. Although each calculation in the spreadsheet has been verified with the results of hand calculation, there is no absolute guarantee of the accuracy of these calculations. Any questions, comments, concerns, and suggestions, or to report an error(s) in the spreadsheet, please send an email to nrd@nrc.gov.



CHAPTER 13 - METHOD OF PREDICTING COMPARTMENT FLASHOVER

The following calculations estimate the minimum heat release rate required to compartment flashover. Parameters should be specified **ONLY IN THE YELLOW INPUT PARAMETER BOXES**. All subsequent output values are calculated by the spreadsheet and based on values specified in the input parameters. This spreadsheet is protected and secure to avoid errors due to a wrong entry in a cell(s). The chapter in the NUREG should be read before an analysis is made.

INPUT PARAMETERS

COMPARTMENT INFORMATION

| | | | | |
|--|--------|--------|--------|---|
| Compartment Width (w_c) | 20.00 | ft | 6.096 | m |
| Compartment Length (l_c) | 15.00 | ft | 4.57 | m |
| Compartment Height (h_c) | 10.00 | ft | 3.048 | m |
| Vent Width (w_v) | 4.00 | ft | 1.219 | m |
| Vent Height (h_v) | 6.00 | ft | 1.83 | m |
| Interior Lining Thickness (δ) | 12.00 | in | 0.3048 | m |
| Interior Lining Thermal Conductivity (k) | 0.0016 | kW/m-K | | |

THERMAL PROPERTIES DATA

| Material | Thermal Conductivity k (kW/m-K) | Select Material |
|------------------------|------------------------------------|-----------------|
| Aluminum (pure) | 0.208 | Concrete |
| Steel (0.5% Carbon) | 0.054 | |
| Concrete | 0.0016 | |
| Brick | 0.0008 | |
| Glass, Plate | 0.00076 | |
| Brick/Concrete Block | 0.00073 | |
| Gypsum Board | 0.00017 | |
| Plywood | 0.00012 | |
| Fiber Insulation Board | 0.00053 | |
| Chipboard | 0.00015 | |
| Aerated Concrete | 0.00026 | |
| Plasterboard | 0.00016 | |
| Calcium Silicate Board | 0.00013 | |
| Alumina Silicate Block | 0.00014 | |
| Glass Fiber Insulation | 0.000037 | |
| Expanded Polystyrene | 0.000034 | |

Scroll to desired material then Click on selection

Reference: Klote, J., J. Milke, *Principles of Smoke Management*, 2002, Page 270.

PREDICTING FLASHOVER HEAT RELEASE RATE METHOD OF McCaffrey, Quintiere, and Harkleroad (MQH)

Reference: *SFPE Handbook of Fire Protection Engineering*, 2nd Edition, 1995, Page 3-145.

$$Q_{FO} = 610 v (h_k A_T A_v (v h_v))$$

Where

Q_{FO} = heat release rate necessary for flashover (kW)

h_k = effective heat transfer coefficient (kW/m²-K)

A_T = total area of the compartment enclosing surface boundaries excluding area of vent opening

A_v = area of ventilation opening (m²)

h_v = height of ventilation opening (m)

Heat Transfer Coefficient Calculation

$$h_k = k/\delta$$

Assuming that compartment has been heated thoroughly before flashover, i.e., $t > t_p$.

Where

 h_k = effective heat transfer coefficient (kW/m²-K) k = interior lining thermal conductivity (kW/m-K) δ = interior lining thickness (m)

$$h_k = 0.005 \text{ kW/m}^2\text{-K}$$

Area of Ventilation Opening Calculation

$$A_v = (w_v)(h_v)$$

Where

 A_v = area of ventilation opening (m²) w_v = vent width (m) h_v = vent height (m)

$$A_v = 2.23 \text{ m}^2$$

Area of Compartment Enclosing Surface Boundaries

$$A_T = [2(w_c \times l_c) + 2(h_c \times w_c) + 2(h_c \times l_c)] - A_v$$

Where

 A_T = total area of the compartment enclosing surface boundaries excluding area of vent openings (m²) w_c = compartment width (m) l_c = compartment length (m) h_c = compartment height (m) A_v = area of ventilation opening (m²)

$$A_T = 118.54 \text{ m}^2$$

Minimum Heat Release Rate for Flashover

$$Q_{FO} = 610 v(h_k A_T A_v (vh_v))$$

$$Q_{FO} = 835.57 \text{ kW} \quad \text{ANSWER}$$

METHOD OF BABRAUSKAS

Reference: *SFPE Handbook of Fire Protection Engineering*, 2nd Edition, 1995, Page 3-145.

$$Q_{FO} = 750 A_v (vh_v)$$

Where

 Q_{FO} = heat release rate necessary for flashover (kW) A_v = area of ventilation opening (m²) h_v = height of ventilation opening (m)**Minimum Heat Release Rate for Flashover**

$$Q_{FO} = 750 A_v (vh_v)$$

$$Q_{FO} = 2261.44 \text{ kW} \quad \text{ANSWER}$$

METHOD OF THOMAS

Reference: *SFPE Handbook of Fire Protection Engineering*, 2nd Edition, 1995, Page 3-148.

$$Q_{FO} = 7.8 A_T + 378 A_v (v_h)$$

Where Q_{FO} = heat release rate necessary for flashover (kW)
 A_T = total area of the compartment enclosing surface boundaries excluding area of vent openings (m²)
 A_v = area of ventilation opening (m²)
 h_v = height of ventilation opening (m)

Minimum Heat Release Rate for Flashover

$$Q_{FO} = 7.8 A_T + 378 A_v (v_h)$$

$Q_{FO} =$ 2064.41 kW ANSWER

SUMMARY OF RESULTS

| | Flashover HRR |
|----------------------|---------------|
| METHOD OF MQH | 836 kW |
| METHOD OF BABRAUSKAS | 2261 kW |
| METHOD OF THOMAS | 2064 kW |

NOTE

The above calculations are based on principles developed in the SFPE Handbook of Fire Protection Engineering, 2nd Edition, 1995.

Calculations are based on certain assumptions and have inherent limitations. The results of such calculations may or may not have reasonable predictive capabilities for a given situation, and should only be interpreted by an informed user.

Although each calculation in the spreadsheet has been verified with the results of hand calculation, there is no absolute guarantee of the accuracy of these calculations.

Any questions, comments, concerns, and suggestions, or to report an error(s) in the spreadsheets, please send an email to nrd@nrc.gov.



Problem J-17

Problem Statement

Consider a triangular corner compartment (as shown in the figure) in a boiling water reactor (BWR). The compartment is 4.6 m (15.0 ft) high with 0.3048 m (12.0 in) thick concrete walls, floor, and ceiling and with a door that is 2.15 m (7.0 ft) wide x 3.0 m (10.0 ft) high (w , x h_v).

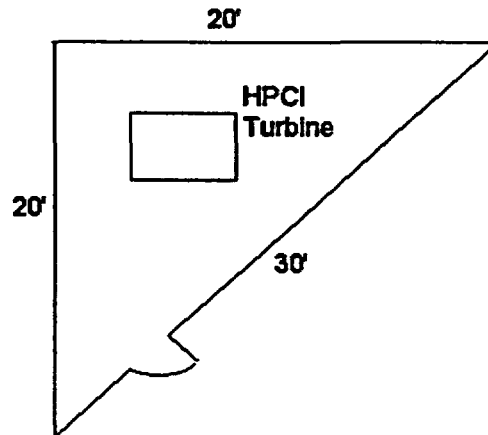

Problem 17: Pool Fire Scenario in a Triangular compartment

A fire scenario arises from a spill of lube oil from the high-pressure coolant injection (HPCI) turbine. Assume that 113.5 liters (30.0 gallons) of lube oil spills in a 1.12 m^2 (12.0 ft^2) oil retention dike. The lube oil spreads and reaches steady burning almost instantly. Two unprotected safety-related cable trays are located 3.0 m (10.0 ft) above the HPCI turbine. Determine whether there is a credible fire hazard to the unprotected safety related cable trays.

Evaluate the hazard of the fire scenario using the following parameters:

- pool fire HRR, \dot{Q} , flame height, z , and burning duration, t_b
- compartment hot gas layer temperature, T_g , as well as gas layer height z
- heat flux to the target (electrical cabinet) using the point source model, $\dot{q}_{\text{cabinet}}''$
- heat flux to the target (cable trays) using the solid-flame radiation model, \dot{q}_{cable}''
- centerline plume temperature, $T_{p(\text{centerline})}$
- sprinkler activation time, $t_{\text{activation}}$
- HRR necessary to cause flashover, \dot{Q}_{FO}

Solution

Purpose:

- Determine if the given fire scenario could represent a hazard for the safety-related cable trays.

Solution Approach:

The solution of this problem is very similar to the previous problem, but in this case we do not have or we are not considering any heat radiation and fire suppression system. First,

we are going to calculate the heat release rate, flame height, and the burning duration of the pool fire (see Chapter 3) in order to determine the fire source characteristics. Notice that regardless the compartment is triangular, we are not going to consider a corner fire. It is reasonable to assume that the HPCI turbine is at large distance away from the walls. Also, we will determine the hot gas layer temperature and the gas layer height (see Chapter 2). Once we get all these values, we have to use them to estimate the hazard of the fire scenario.

Assumptions:

- (1) There is instantaneous and complete involvement of the liquid in the pool fire.
- (2) The pool fire is burning in the open.
- (3) The pool is circular or nearly circular.
- (4) The fire is located away from the walls.
- (5) The ambient (or initial condition of the air) is at 25 °C (77 °F)
- (6) The bottom of the oil retention dike is at ground level.
- (7) The distance from the top of the fuel package (oil pool) to the ceiling is 15 ft, the pool height or oil layer thickness is negligible compared with the height of the ceiling.

Spreadsheet (FDT[®]) Solution Procedure:

Use the following FDT[®]:

- (a) HRR_Flame_Height_Burning_Duration_Calculations.xls
- (b) Temperature_NV.xls

FDT[®] Input Parameters:

Enter the following parameters in the spreadsheets (values only):

- (a) HRR_Flame_Height_Burning_Duration_Calculations.xls

- Fuel spill volume (V) = 30 gallons
- Fuel Spill Area or Dike Area (A_{dike}) = 12 ft²
- Select Fuel Type: select **Lube Oil** from the combo box

Note: When **Lube Oil** is selected, its properties are automatically selected from the table and entered in the corresponding input cells.

Results*

| Heat Release Rate \dot{Q} kW (Btu/sec) | Burning Duration (t_b) (min) | Pool Fire Flame Height H_f m (ft) | |
|---|-------------------------------------|--|------------------|
| | | Method of Heskestad | Method of Thomas |
| 2,000 (1,900) | 2,000 (1,900) | 3.7(12.1) | 2.9 (9.6) |

*spreadsheet calculations attached at the end of the problem

(b) Temperature_NV.xls

Equivalent Compartment:

The FDT^s for hot gas layer temperature and flame height are designed for quadrilateral compartment. Since the compartment is triangular we have to calculate an equivalent square compartment in order to use the FDT^s.

❑ Triangular Compartment Area:

$$A = \frac{1}{2} \times (\text{base}) \times (\text{width}) = \frac{1}{2} \times (20 \text{ ft}) \times (20 \text{ ft}) = 200 \text{ ft}^2$$

❑ Equivalent Rectangular Compartment:

$$L = w_c = l_c = (200 \text{ ft}^2)^{1/2} = 14.0 \text{ ft}$$

Input Parameters:

- Compartment Width (w_c) = 14 ft
- Compartment Length (l_c) = 14 ft
- Compartment Height (h_c) = 15 ft
- Vent Width (w_v) = 7 ft
- Vent Height (h_v) = 10 ft
- Top of Vent from Floor (V_T) = 10 ft
- Interior Lining Thickness (δ) = 12 in
- Select Material: select **Concrete** from the combo box
- Fire Heat Release Rate (\dot{Q}) = 2,000 kW

Note: When **Concrete** is selected, its thermal properties are automatically selected from the table and entered in the corresponding input cells.

Results*

| Time (min) | Hot Gas Layer Temperature T_g °C (°F) | Gas Layer Height z m (ft) |
|------------|--|--------------------------------|
| 0 | 25 (77) | 4.57 (15) |
| 1 | 194 (380) | 0.18 (0.59) |
| 2 | 214 (417) | 0.17 (0.56) |
| 3 | 227 (441) | 0.16 (0.54) |
| 4 | 237 (459) | 0.16 (0.52) |
| 5 | 245 (473) | 0.16 (0.51) |
| 10 | 272 (522) | 0.15 (0.48) |
| 15 | 289 (553) | 0.14 (0.46) |
| 20 | 302 (576) | 0.14 (0.44) |

*spreadsheet calculations attached at the end of the problem

Conclusions

We can note that the fire power (HRR) and the pool fire flame height values are similar to the previous problem. The reason for this similarity is because the correlations to determine the HRR and flame height are based on the type of fuel and the dike area (or dike diameter), and in this problem we are dealing with a pool fire similar to problem 16. The amount of combustible in the pool (volume) will determine the duration of the pool fire, that is, the burning time. Thus, we obtained a different burning time value because we have more fuel volume.

As problem 16, we have a high intensity fire with a flame height that probably will impinge upon the cable trays. Also, the hot gas layer temperature analysis predicts that the temperature of the gases will reach the failure temperature for IEEE-383 unqualified cables ($T = 425 \text{ }^\circ\text{F}$) approximately at 2 minutes after ignition and the compartment will be full with smoke at this time too. If there is no intervention of any suppression system during the 33 minutes of flame exposure, there is no doubt that there is a credible hazard for the safety related cables.

Spreadsheets Calculations

CHAPTER 3 - ESTIMATING THE HEAT RELEASE RATE, BURNING DURATION, AND FLAME HEIGHT FOR A LIQUID POOL FIRE

The following calculations estimate the heat release rate, burning duration, and flame height for liquid pool fire. Parameters should be specified ONLY IN THE YELLOW INPUT PARAMETER BOXES. All subsequent output values are calculated by the spreadsheet and based on values specified in the input parameters. This spreadsheet is protected and secure to avoid errors due to a wrong entry in a cell(s). The chapter in the NUREG should be read before an analysis is made.

INPUT PARAMETERS

| | | | |
|--|-------|------------------------|---|
| Fuel Spill Volume (V) | 30.00 | gallons | 0.1136 m ³ 1.115 m ³ |
| Fuel Spill Area or Dike Area (A _{spill}) | 12.00 | ft ² | |
| Mass Burning Rate of Fuel (m ³) | 0.039 | kg/m ² -sec | |
| Effective Heat of Combustion of Fuel (H _{c,eff}) | 46000 | kJ/kg | |
| Fuel Density (ρ) | 760 | kg/m ³ | |
| Gravitational Acceleration (g) | 9.81 | m/sec ² | |
| Ambient Air Density (ρ _a) | 1.20 | kg/m ³ | |

THERMAL PROPERTIES DATA BURNING RATE DATA FOR LIQUID HYDROCARBON FUELS

| Fuel | Mass Burning Rate m ³ (kg/m ² -sec) | Heat of Combustion ΔH _{c,eff} (kJ/kg) | Density ρ (kg/m ³) |
|------------------------------|--|---|-----------------------------------|
| Methanol | 0.017 | 20,000 | 796 |
| Ethanol | 0.015 | 26,800 | 794 |
| Butane | 0.078 | 45,700 | 573 |
| Benzene | 0.065 | 40,100 | 874 |
| Hexane | 0.074 | 44,700 | 650 |
| Heptane | 0.101 | 44,600 | 675 |
| Xylene | 0.09 | 40,800 | 870 |
| Acetone | 0.041 | 25,800 | 791 |
| Dioxane | 0.018 | 26,200 | 1035 |
| Diethyl Ether | 0.065 | 34,200 | 714 |
| Benzine | 0.048 | 44,700 | 740 |
| Gasoline | 0.055 | 43,700 | 740 |
| Kerosine | 0.039 | 43,200 | 820 |
| Diesel | 0.045 | 44,400 | 918 |
| JP-4 | 0.051 | 43,500 | 760 |
| JP-5 | 0.054 | 43,000 | 810 |
| Transformer Oil, Hydrocarbon | 0.039 | 46,000 | 760 |
| Fuel Oil, Heavy | 0.035 | 39,700 | 970 |
| Crude Oil | 0.0335 | 42,600 | 855 |
| Lube Oil | 0.039 | 46,000 | 760 |

Select Fuel Typ

 Scroll to deslrec
 fuel type then
 Click on selectio

Reference: SFPE Handbook of Fire Protection Engineering, 2nd Edition, 1995, Page 3-2.

ESTIMATING POOL FIRE HEAT RELEASE RATE

Reference: *SFPE Handbook of Fire Protection Engineering*, 2nd Edition, 1995, Page 3-4.

$$Q = m'' H_{c,eff} A_f$$

Where Q = pool fire heat release rate (kW)
 m'' = mass burning rate of fuel per unit surface area ($\text{kg}/\text{m}^2\text{-sec}$)
 $\Delta H_{c,eff}$ = effective heat of combustion of fuel (kJ/kg)
 $A_f = A_{disk}$ = surface area of pool fire (area involved in vaporization) (m^2)

Heat Release Rate Calculation

(Liquids with relatively high flash point, like transformer oil, require localized heating to achieve ignition)

$$Q = m'' H_c A_f$$

| | | | |
|-------|------------|-----------------|--------|
| $Q =$ | 2000.02 kW | 1895.66 BTU/sec | ANSWER |
|-------|------------|-----------------|--------|

ESTIMATING POOL FIRE BURNING DURATION

Reference: *SFPE Handbook of Fire Protection Engineering*, 2nd Edition, 1995, Page 3-197.

$$t_b = 4V / D^2$$

Where t_b = burning duration of pool fire (sec)
 V = volume of liquid (m^3)
 D = pool diameter (m)
 v = regression rate (m/sec)

Pool Fire Diameter Calculation

$$A_{disk} = D^2/4$$

$$D = \sqrt{4A_{disk} / v}$$

$$D = 1.191 \quad \text{m}$$

Calculation for Regression Rate

$$v = m'' / \rho$$

Where m'' = mass burning rate of fuel ($\text{kg}/\text{m}^2\text{-sec}$)

ρ = liquid fuel density (kg/m^3)

$$v = 0.000051 \quad \text{m/sec}$$

Burning Duration Calculation

$$t_b = 4V / D^2$$

| | | | |
|---------|-------------|---------------|--------|
| $t_b =$ | 1985.05 sec | 33.08 minutes | ANSWER |
|---------|-------------|---------------|--------|

Note that a liquid pool fire with a given amount of fuel can burn for long periods of time over small area or for short periods of time over a large area.

ESTIMATING POOL FIRE FLAME HEIGHT METHOD OF HESKESTAD

Reference: *SFPE Handbook of Fire Protection Engineering*, 2nd Edition, 1995, Page 2-10.

$$H_f = 0.235 Q^{2/5} - 1.02 D$$

Where H_f = pool fire flame height (m)
 Q = pool fire heat release rate (kW)
 D = pool fire diameter (m)

Pool Fire Flame Height Calculation

$$H_f = 0.235 Q^{2/5} - 1.02 D$$

| | | | |
|---------|--------|----------|--------|
| $H_f =$ | 3.70 m | 12.14 ft | ANSWER |
|---------|--------|----------|--------|

METHOD OF THOMAS

Reference: *SFPE Handbook of Fire Protection Engineering*, 2nd Edition, 1995, Page 3-204.

$$H_f = 42 D (m^* \cdot \rho_a v(g D))^{0.61}$$

Where H_f = pool fire flame height (m)

m^* = mass burning rate of fuel per unit surface area ($\text{kg}/\text{m}^2\text{-sec}$)

ρ_a = ambient air density (kg/m^3)

D = pool fire diameter (m)

g = gravitational acceleration (m/sec^2)

Pool Fire Flame Height Calculation

$$H_f = 42 D (m^* \cdot \rho_a v(g D))^{0.61}$$

| | | | |
|---------|--------|---------|--------|
| $H_f =$ | 2.92 m | 9.59 ft | ANSWER |
|---------|--------|---------|--------|

NOTE

The above calculations are based on principles developed in the *SFPE Handbook of Fire Protection Engineering*, 2nd Edition, 1995. Calculations are based on certain assumptions and have inherent limitations. The results of such calculations may or may not have reasonable predictive capabilities for a given situation and should only be interpreted by an informed user. Although each calculation in the spreadsheet has been verified with the results of hand calculation, there is no absolute guarantee of the accuracy of these calculations. Any questions, comments, concerns, and suggestions, or to report an error(s) in the spreadsheets, please send an email to nxi@nrc.gov.



Office of Nuclear Reactor Regulation

CHAPTER 2 - PREDICTING HOT GAS LAYER TEMPERATURE AND SMOKE LAYER HEIGHT IN ROOM FIRE WITH NATURAL VENTILATION COMPARTMENT WITH THERMALLY THICK BOUNDARIES

The following calculations estimate the hot gas layer temperature and smoke layer height in enclosure fire. Parameters should be specified ONLY IN THE YELLOW INPUT PARAMETER BOXES. All subsequent output values are calculated by the spreadsheet and based on values specified in the input parameters. This spreadsheet is protected and secure to avoid errors due to a wrong entry in a cell(s). The chapter in the NUREG should be read before an analysis is made.

INPUT PARAMETERS

COMPARTMENT INFORMATION

| | | |
|------------------------------|----------|----------|
| Compartment Width (w_c) | 14.00 ft | 4.2672 m |
| Compartment Length (l_c) | 14.00 ft | 4.2672 m |
| Compartment Height (h_c) | 15.00 ft | 4.572 m |

| | | |
|----------------------------------|----------|----------|
| Vent Width (w_v) | 7.00 ft | 2.134 m |
| Vent Height (h_v) | 10.00 ft | 3.048 m |
| Top of Vent from Floor (V_T) | 10.00 ft | 3.048 m |
| Interior Lining Thickness () | 12.00 in | 0.3048 m |

For thermally thick case the interior lining thickness should be greater than 1 inch.

AMBIENT CONDITIONS

| | | |
|-----------------------------------|------------------------|----------------------|
| Ambient Air Temperature (T_a) | 77.00 °F | 25.00 °C 298.00 K |
| Specific Heat of Air (c_p) | 1.00 kJ/kg-K | |
| Ambient Air Density (ρ_a) | 1.20 kg/m ³ | |

THERMAL PROPERTIES OF COMPARTMENT ENCLOSING SURFACES FOR

| | |
|--|--|
| Interior Lining Thermal Inertia ($k c$) | 2.9 (kW/m ² -K) ² -sec |
| Interior Lining Thermal Conductivity (k) | 0.0016 kW/m-K |
| Interior Lining Specific Heat (c) | 0.75 kJ/kg-K |
| Interior Lining Density () | 2400 kg/m ³ |

EXPERIMENTAL THERMAL PROPERTIES FOR COMMON INTERIOR LINING MATERIALS

| Material | k c (kW/m ² -K) ² -sec | k (kW/m-K) | c (kJ/kg-K) | (kg/m ³) |
|------------------------|---|---------------|----------------|----------------------|
| Aluminum (pure) | 500 | 0.206 | 0.895 | 2710 |
| Steel (0.5% Carbon) | 197 | 0.054 | 0.465 | 7850 |
| Concrete | 2.9 | 0.0016 | 0.75 | 2400 |
| Brick | 1.7 | 0.0008 | 0.8 | 2600 |
| Glass, Plate | 1.6 | 0.00076 | 0.8 | 2710 |
| Brick/Concrete Block | 1.2 | 0.00073 | 0.84 | 1900 |
| Gypsum Board | 0.18 | 0.00017 | 1.1 | 960 |
| Plywood | 0.16 | 0.00012 | 2.5 | 540 |
| Fiber Insulation Board | 0.16 | 0.00053 | 1.25 | 240 |
| Chipboard | 0.15 | 0.00015 | 1.25 | 800 |
| Aerated Concrete | 0.12 | 0.00026 | 0.96 | 500 |
| Plasterboard | 0.12 | 0.00016 | 0.84 | 950 |
| Calcium Silicate Board | 0.098 | 0.00013 | 1.12 | 700 |
| Alumina Silicate Block | 0.036 | 0.00014 | 1 | 260 |
| Glass Fiber Insulation | 0.0018 | 0.000037 | 0.8 | 60 |
| Expanded Polystyrene | 0.001 | 0.000034 | 1.5 | 20 |

Select Material

 Scroll to desired material then
 Click the selection

Reference: Klote, J., J. Milke, *Principles of Smoke Management*, 2002, Page 270.

FIRE SPECIFICATIONS

Fire Heat Release Rate (Q)

2000.00 kw**METHOD OF McCAFFREY, QUINTIERE, AND HARKLEROAD (MQH)**Reference: *SFPE Handbook of Fire Protection Engineering*, 2nd Edition, Page 3-139.

$$\Delta T_g = 6.85[Q^2/(A_v(h_v)^{1/2})(A_T h_k)]^{1/3}$$

Where $\Delta T_g = T_g - T_a$ = upper layer gas temperature rise above ambient (K)
 Q = heat release rate of the fire (kW)
 A_v = area of ventilation opening (m²)
 h_v = height of ventilation opening (m)
 h_k = convective heat transfer coefficient (kW/m²-K)
 A_T = total area of the compartment enclosing surface boundaries excluding area of vent openings (m²)

Area of Ventilation Opening Calculation

$$A_v = (w_v)(h_v)$$

$$A_v = 6.50 \text{ m}^2$$

Thermal Penetration Time Calculation**Thermally Thick Material**

$$t_p = (\rho c_p/k)(\delta/2)^2$$

Where ρ = interior construction density (kg/m³)
 c_p = interior construction heat capacity (kJ/kg-K)
 k = interior construction thermal conductivity (kW/m-K)
 δ = interior construction thickness (m)

$$t_p = 26128.98 \text{ sec}$$

Heat Transfer Coefficient Calculation

$$h_k = v(kpc/t) \quad \text{for } t < t_p$$

Where kpc = interior construction thermal inertia (kW/m²-K)²-sec
 (a thermal property of material responsible for the rate of temperature rise)
 t = time after ignition (sec)

Area of Compartment Enclosing Surface Boundaries

$$A_T = [2(w_c \times l_c) + 2(h_c \times w_c) + 2(h_c \times l_c)] - A_v$$

$$A_T = 107.85 \text{ m}^2$$

Compartment Hot Gas Layer Temperature With Natural Ventilation

$$\Delta T_g = 6.85[Q^2/(A_v(h_v)^{1/2})(A_T h_k)]^{1/3}$$

$$\Delta T_g = T_g - T_a$$

$$T_g = \Delta T_g + T_a$$

RESULTS

| Time after Ignition (t) | | h_c (kW/m ² -K) | ΔT_g (K) | T_g (K) | T_g (°C) | T_g (°F) |
|-------------------------|------|---------------------------------|---------------------|--------------|---------------|---------------|
| (min) | (s) | | | | | |
| 0 | 0.00 | - | - | 298.00 | 25.00 | 77.00 |
| 1 | 60 | 0.22 | 168.35 | 466.35 | 193.35 | 380.03 |
| 2 | 120 | 0.16 | 188.97 | 488.97 | 213.97 | 417.14 |
| 3 | 180 | 0.13 | 202.18 | 500.18 | 227.18 | 440.92 |
| 4 | 240 | 0.11 | 212.11 | 510.11 | 237.11 | 458.79 |
| 5 | 300 | 0.10 | 220.14 | 518.14 | 245.14 | 473.26 |
| 10 | 600 | 0.07 | 247.10 | 545.10 | 272.10 | 521.79 |
| 15 | 900 | 0.06 | 264.38 | 562.38 | 289.38 | 552.88 |
| 20 | 1200 | 0.05 | 277.36 | 575.36 | 302.36 | 576.26 |

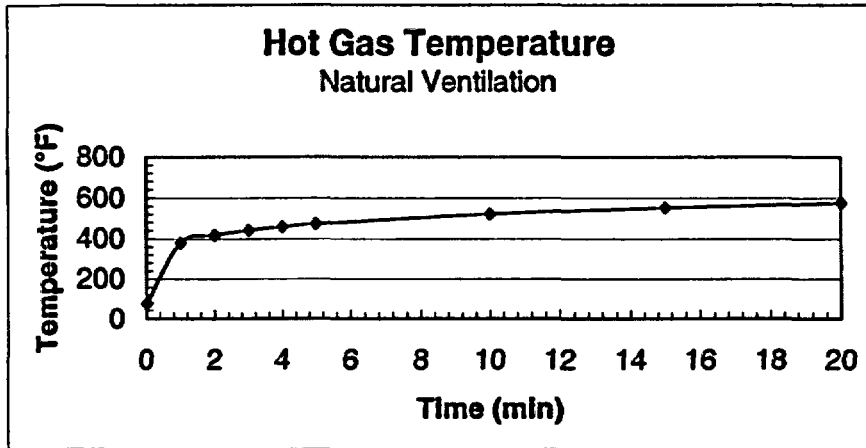

**ESTIMATING SMOKE LAYER HEIGHT
METHOD OF YAMANA AND TANAKA**

$$z = ((2kQ^{1/3}/3A_c) + (1/h_c^{2/3})^{-3/2}$$
 Where z = smoke layer height (m)
 Q = heat release rate of the fire (kW)
 t = time after ignition (sec)
 h_c = compartment height (m)
 A_c = compartment floor area (m²)
 k = a constant given by $k = 0.076/\rho_g$
 ρ_g = hot gas layer density (kg/m³)
 ρ_g is given by $\rho_g = 353/T_g$
 T_g = hot gas layer temperature (K)

Compartment Area Calculation

$A_c = (w_c)(l_c)$
 $A_c = 18.21 \text{ m}^2$

Hot Gas Layer Density Calculation

$\rho_g = 353/T_g$

Calculation for Constant K

$k = 0.076/\rho_g$

Smoke Gas Layer Height With Natural Ventilation

$$z = ((2kQ^{1/3}/3A_c) + (1/h_c^{2/3})^{-3/2}$$

RESULTS

| Time (min) | ρ_g (kg/m ³) | k (kW/m-K) | z (m) | z (ft) |
|------------|-------------------------------|------------|-------|--------|
| 0 | 1.20 | 0.063 | 4.57 | 15.00 |
| 1 | 0.76 | 0.100 | 0.18 | 0.59 |
| 2 | 0.72 | 0.105 | 0.17 | 0.56 |
| 3 | 0.71 | 0.108 | 0.16 | 0.54 |
| 4 | 0.69 | 0.110 | 0.16 | 0.52 |
| 5 | 0.68 | 0.112 | 0.16 | 0.51 |
| 10 | 0.65 | 0.117 | 0.15 | 0.48 |
| 15 | 0.63 | 0.121 | 0.14 | 0.46 |
| 20 | 0.61 | 0.124 | 0.14 | 0.44 |

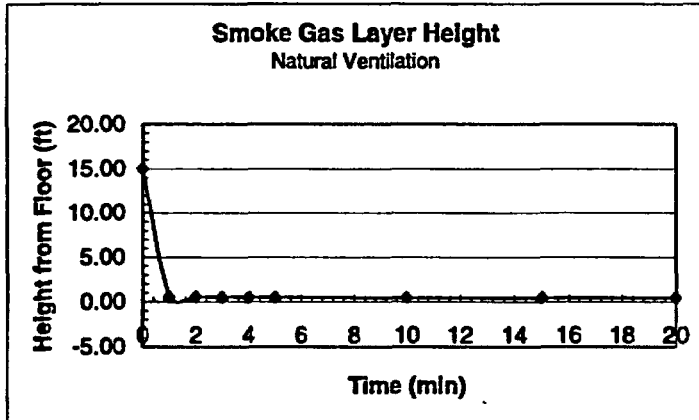

NOTE

The above calculations are based on principles developed in the SFPE Handbook of Fire Protection Engineering, 2nd Edition, 1995. Calculations are based on certain assumptions and have inherent limitations. The results of such calculations may or may not have reasonable predictive capabilities for a given situation, and should only be interpreted by an informed user. Although each calculation in the spreadsheet has been verified with the results of hand calculation, there is no absolute guarantee of the accuracy of these calculations. Any questions, comments, concerns, and suggestions, or to report an error(s) in the spreadsheet, please send an email to nxi@nrc.gov.



This page intentionally left blank.

Problem J-18

Problem Statement

A fire scenario arise from a pile of instant-lighting charcoal briquets. Ten 3.62-kg (8.0-lb) bags of these briquets have been stored on the floor of a corridor in a facility. Assume that a strong ignition source is present and ignites the charcoal briquets. Compute the heat release rate, \dot{Q} flame height, H_f and burning duration, t_b of pile of charcoal briquets, assuming that the area of the charcoal pile is 0.28 m^2 (3 ft^2).

Additional Information

Charcoal briquets are a combustible material and become more combustible when soaked with lighter fluid (an accelerant) during the manufactures process (Ref. 1). The lighter fluid is usually kerosine or a petroleum distillate (Refs. 2 and 3). No direct burning rate data are available for instant-lighting charcoal briquets. A breakdown of the combustion data for plain charcoal and kerosine (Ref. 4) is provided below. Average values can be used as a composition when specific burning rate data are not available. The density of charcoal is approximately 400 kg/m^3 .

| Combustion Properties of Charcoal and Kerosine | | |
|--|--|--|
| Combustible Material | Heat of Combustion ΔH_c (kJ/kg) | Mass Loss Rate \dot{m}'' (kg/m ² -sec) |
| Charcoal | 31,400 | 0.01082* |
| Kerosine | 43,300 | 0.039 |
| Average | 37,350 | 0.02491 |
| * Mass loss rate of charcoal is not available in the literature, mass loss rate of plain plywood can be used, since charcoal is derivatives of wood. | | |

References

1. Roblee, C.L., "Hazards of Charcoal Briquets," *Fire and Arson Investigator*, Volume 33, No. 3, March, 1993.
2. Lincoln, S., "Case in Review: Charcoal Lighter Fluid Used as an Arson Accelerant," *Fire and Arson Investigator*, Volume 41, No. 1, September, 1991.
3. Wiltshire, L.L., and Alger, R. S., "Carbon Monoxide Production in Charcoal Briquete Fires," NOLTR 71-104, Project MAT-03L-00/ZRO11-01-01, Naval Ordnance Laboratory, Silver Spring, Maryland, July 7, 1971.
4. SFPE Handbook of Fire Protection Engineering, 2nd Edition, 1995.

Solution

Purpose:

- (1) Determine the heat release rate, \dot{Q} , flame height, H_f , and burning duration, t_b , of the pile of charcoal briquets for the given fire scenario.

Solution Approach:

To calculate the HRR and flame height we are going to use the pool fire approach. These calculations are just fuel type and area dependent, therefore we are going to model the area of the charcoal pile as the area of a dike and use the average values of heat of combustion, mass loss rate and density (values are given in the problem statement). The burning duration of the pile can be calculated with the learned concepts in Chapter 8 of NUREG.

Assumptions:

- (1) There is instantaneous and complete involvement of the charcoal pile.
- (2) The charcoal pile is burning in the open.
- (3) The charcoal pile area is circular or nearly circular.
- (4) The fire is located away from the walls.
- (5) The ambient (or initial condition of the air) is at 25 °C (77 °F)
- (6) Combustion is incomplete and takes place entirely within the confines of the compartment.

Spreadsheet (FDT[®]) Solution Procedure:

Use the following FDT[®]:

- (a) HRR_Flame_Height_Burning_Duration_Calculations.xls
2. Burning_Duration_Solid.xls

FDT[®] Input Parameters:

Enter the following parameters in the spreadsheets (values only):

- (a) HRR_Flame_Height_Burning_Duration_Calculations.xls
 - Fuel spill volume (V) = 0 gallons
 - Fuel Spill Area or Dike Area (A_{dike}) = 3 ft²
 - Mass Burning Rate of Fuel (\dot{m}'') = 0.02491 kg/m²-sec
 - Effective Heat of Combustion of Fuel ($\Delta H_{c,eff}$) = 37,350 kJ/kg
 - Fuel Density (ρ) = 400 kg/m³

Note: For this calculation, use any value of spill volume because the burning time based on the pool fire calculation is not applicable. We are just going to accept the HRR and flame height values as reasonable estimates. Mass burning rate, heat of combustion and density values are from the given properties in the problem statement. Once this values are entered in the corresponding input cells, do not select any fuel type from the combo box, this action will change the values previously entered.

Results*

| Heat Release Rate \dot{Q} kW (Btu/sec) | Pool Fire Flame Height H_f m (ft) | |
|---|--|------------------|
| | Method of Heskestad | Method of Thomas |
| 259 (246) | 1.56 (5.13) | 1.37 (4.51) |

*spreadsheet calculations attached at the end of the problem

(b) Burning_Duration_Solid.xls

HRR per Unit Floor Area:

The HRR per unit of area is defined as $\dot{Q}'' = \Delta H_{c,eff} \dot{m}''$. Therefore, from the given properties in the problem statement we have:

$$\dot{Q}'' = \Delta H_{c,eff} \dot{m}'' = 37,350 \text{ kJ/kg} (0.02491 \text{ kg/m}^2\text{-sec}) = 930 \text{ kW/m}^2$$

Input Parameters:

- Mass of Solid Fuel (m_{solid}) = 80 lb
- Exposed Fuel Surface Area (A_{fuel}) = 3 ft²
- HRR per Unit Floor Area (\dot{Q}'') = 930 kW/m²
- Effective Heat of Combustion of Fuel ($\Delta H_{c,eff}$) = 37,350 kJ/kg

Note: Do not select any material after you enter the previous inputs.

Results*

| Material | Burning Duration t_{solid} (min.) |
|-------------------|---|
| Charcoal briquets | 87 |

*spreadsheet calculations attached at the end of the problem

Spreadsheet Calculations

CHAPTER 3 - ESTIMATING THE HEAT RELEASE RATE, BURNING DURATION, AND FLAME HEIGHT FOR A LIQUID POOL FIRE

The following calculations estimate the heat release rate, burning duration, and flame height for liquid pool fire. Parameters should be specified ONLY IN THE YELLOW INPUT PARAMETER BOXES. All subsequent output values are calculated by the spreadsheet and based on values specified in the input parameters. This spreadsheet is protected and secure to avoid errors due to a wrong entry in a cell(s). The chapter in the NUREG should be read before an analysis is made.

INPUT PARAMETERS

| | | | |
|--|---------|------------------------|-----------------------|
| Fuel Spill Volume (V) | 0.00 | gallons | 0.0000 m ³ |
| Fuel Spill Area or Dike Area (A _{spill}) | 3.00 | m ² | 0.279 m ² |
| Mass Burning Rate of Fuel (m ³) | 0.02491 | kg/m ² -sec | |
| Effective Heat of Combustion of Fuel (H _{c,eff}) | 37350 | kJ/kg | |
| Fuel Density (ρ) | 400 | kg/m ³ | |
| Gravitational Acceleration (g) | 9.81 | m/sec ² | |
| Ambient Air Density (ρ _a) | 1.20 | kg/m ³ | |

THERMAL PROPERTIES DATA BURNING RATE DATA FOR LIQUID HYDROCARBON FUELS

| Fuel | Mass Burning Rate m ³ (kg/m ² -sec) | Heat of Combustion ΔH _{c,eff} (kJ/kg) | Density ρ (kg/m ³) | Select Fuel Type |
|------------------------------|--|---|-----------------------------------|------------------|
| Methanol | 0.017 | 20,000 | 798 | Methanol |
| Ethanol | 0.015 | 26,800 | 794 | |
| Butane | 0.078 | 45,700 | 573 | |
| Benzene | 0.086 | 40,100 | 874 | |
| Hexane | 0.074 | 44,700 | 650 | |
| Heptane | 0.101 | 44,600 | 675 | |
| Xylene | 0.09 | 46,800 | 870 | |
| Acetone | 0.041 | 25,800 | 791 | |
| Dioxane | 0.018 | 26,200 | 1035 | |
| Diethyl Ether | 0.085 | 34,200 | 714 | |
| Benzine | 0.048 | 44,700 | 740 | |
| Gasoline | 0.056 | 43,700 | 740 | |
| Kerosene | 0.039 | 43,200 | 820 | |
| Diesel | 0.045 | 44,400 | 918 | |
| JP-4 | 0.051 | 43,500 | 780 | |
| JP-5 | 0.054 | 43,000 | 810 | |
| Transformer Oil, Hydrocarbon | 0.039 | 46,000 | 780 | |
| Fuel Oil, Heavy | 0.035 | 39,700 | 970 | |
| Crude Oil | 0.0336 | 42,600 | 855 | |
| Lube Oil | 0.039 | 46,000 | 799 | |

Scroll to desired fuel type then
Click on selection

Reference: SFPE Handbook of Fire Protection Engineering, 2nd Edition, 1995, Page 3-2.

ESTIMATING POOL FIRE HEAT RELEASE RATEReference: *SFPE Handbook of Fire Protection Engineering*, 2nd Edition, 1995, Page 3-4.

$$Q = m^* \Delta H_{c,eff} A_f$$

Where Q = pool fire heat release rate (kW)
 m^* = mass burning rate of fuel per unit surface area (kg/m²-sec)
 $\Delta H_{c,eff}$ = effective heat of combustion of fuel (kJ/kg)
 $A_f = A_{disk}$ = surface area of pool fire (area involved in vaporization) (m²)

Heat Release Rate Calculation (Liquids with relatively high flash point, like transformer oil, require localized heating to achieve ignition)

$$Q = m^* \Delta H_{c,eff} A_f$$

| | | | |
|-------|-----------|----------------|--------|
| $Q =$ | 259.31 kW | 245.78 BTU/sec | ANSWER |
|-------|-----------|----------------|--------|

ESTIMATING POOL FIRE BURNING DURATIONReference: *SFPE Handbook of Fire Protection Engineering*, 2nd Edition, 1995, Page 3-197.

$$t_b = 4V/\pi D^2 v$$

Where t_b = burning duration of pool fire (sec)
 V = volume of liquid (m³)
 D = pool diameter (m)
 v = regression rate (m/sec)

Pool Fire Diameter Calculation

$$A_{disk} = \pi D^2 / 4$$

$$D = \sqrt{4A_{disk} / \pi}$$

$$D = 0.596 \quad \text{m}$$

Calculation for Regression Rate

$$v = m^* / \rho$$

Where m^* = mass burning rate of fuel (kg/m²-sec)
 ρ = liquid fuel density (kg/m³)

$$v = 0.000062 \quad \text{m/sec}$$

Burning Duration Calculation

$$t_b = 4V/\pi D^2 v$$

| | | | |
|---------|----------|--------------|--------|
| $t_b =$ | 0.00 sec | 0.00 minutes | ANSWER |
|---------|----------|--------------|--------|

Note that a liquid pool fire with a given amount of fuel can burn for long periods of time over small area or for short periods of time over a large area.

**ESTIMATING POOL FIRE FLAME HEIGHT
METHOD OF HESKESTAD**Reference: *SFPE Handbook of Fire Protection Engineering*, 2nd Edition, 1995, Page 2-10.

$$H_f = 0.235 Q^{2/5} - 1.02 D$$

Where H_f = pool fire flame height (m)
 Q = pool fire heat release rate (kW)
 D = pool fire diameter (m)

Pool Fire Flame Height Calculation

$$H_f = 0.235 Q^{2/5} - 1.02 D$$

| | | | |
|---------|--------|---------|--------|
| $H_f =$ | 1.56 m | 5.13 ft | ANSWER |
|---------|--------|---------|--------|

METHOD OF THOMAS

Reference: *SFPE Handbook of Fire Protection Engineering*, 2nd Edition, 1995, Page S-204.

$$H_f = 42 D (m^* \rho_a v (g D))^{0.61}$$

Where H_f = pool fire flame height (m)
 m^* = mass burning rate of fuel per unit surface area (kg/m²-sec)
 ρ_a = ambient air density (kg/m³)
 D = pool fire diameter (m)
 g = gravitational acceleration (m/sec²)

Pool Fire Flame Height Calculation

$$H_f = 42 D (m^* \rho_a v (g D))^{0.61}$$

$H_f =$ 1.37 m 4.51 ft ANSWER

NOTE

The above calculations are based on principles developed in the *SFPE Handbook of Fire Protection Engineering*, 2nd Edition, 1995. Calculations are based on certain assumptions and have inherent limitations. The results of such calculations may or may not have reasonable predictive capabilities for a given situation and should only be interpreted by an informed user. Although each calculation in the spreadsheet has been verified with the results of hand calculation, there is no absolute guarantee of the accuracy of these calculations. Any questions, comments, concerns, and suggestions, or to report an error(s) in the spreadsheets, please send an email to nxi@nrc.gov.



CHAPTER 8 - ESTIMATING BURNING DURATION OF SOLID COMBUSTIBLES

The following calculations provides an approximation of the burning duration of solid combustibles based on free burning rate with a given surface area.

Parameters should be specified ONLY IN THE YELLOW INPUT PARAMETER BOXES.

All subsequent output values are calculated by the spreadsheet and based on values specified in the input parameters. This spreadsheet is protected and secure to avoid errors due to a wrong entry in a cell(s).

The chapter in the NUREG should be read before an analysis is made.

INPUT PARAMETERS

COMPARTMENT INFORMATION

| | | |
|---|-----------------------|---------------------|
| Mass of Solid Fuel (m_{solid}) | 80.00 lb | 36.29 kg |
| Exposed Fuel Surface Area (A_{fuel}) | 3.00 ft ² | 0.28 m ² |
| Heat Release Rate per Unit Floor Area (Q'') | 930 kW/m ² | |
| Effective Heat of Combustion ($H_{c,eff}$) | 37350 kJ/kg | |

THERMAL PROPERTIES OF SOLID COMBUSTIBLE MATERIALS

| Materials | HRR per Unit Floor Area Q'' (kW/m ²) | Heat of Combustion ΔH_c (kJ/kg) | Select Material |
|---------------------------------------|---|--|---|
| | | | PE/PVC |
| PE/PVC | 589 | 24000 | Scroll to desired material then Click on selection |
| XPE/FRXPE | 475 | 28300 | |
| XPE/Neoprene | 354 | 10300 | |
| PE, Nylon/PVC, Nylon | 231 | 9200 | |
| Teflon | 98 | 3200 | |
| Douglas fir plywood | 221 | 17600 | |
| Fire retardant treated plywood | 81 | 13500 | |
| Particleboard, 19 mm thick | 1900 | 17500 | |
| Nylon 6/6 | 1313 | 32000 | |
| Polymethylmethacrylate (PMMA) | 665 | 26000 | |
| Polypropylene (PP) | 1509 | 43200 | |
| Polystyrene (PS) | 1101 | 42000 | |
| Polyethylene (PE) | 1408 | 46500 | |
| Polycarbonate | 420 | 24400 | |
| Polyurethane | 710 | 45000 | |
| Polyvinyl Chloride (PVC) Flexible | 237 | 15700 | |
| Strene-butadiene Copolymers (SBR) | 163 | 44000 | |
| Ethylene Propylene Dien Rubber (EPDM) | 956 | 28800 | |
| Empty Cartons 15 ft high | 1700 | 12700 | |
| Wood pallets, stacked 1.5 ft high | 1420 | 14000 | |
| Wood pallets, stacked 5 ft high | 3970 | 14000 | |
| Wood pallets, stacked 10 ft high | 6800 | 14000 | |

References: "Categorization of Cable Flammability, Part 1: Laboratory Evaluation of Cable Flammability Parameters," EPRI Research Project 1185-1, NP-1200, Part 1. Karlsson and Quantiere, *Enclosure Fire Dynamics*, Chapter 3: Energy Release Rate," CRC Press, 1999.

Johnson, D. G., "Combustion Properties of Plastics," *Journal of Applied Fire Science*, Volume 4, No. 3, 1994-95, pp. 185-201.

Hirschler, M. M., "Heat Release from Plastic Materials," *Heat Release in Fires*, Babrauskas and Grayson, Editors, Elsevier Applied Science, 1992.

G DURATION OF SOLID COMBUSTIBLES

Reference: *NFPA Fire Protection Handbook*, 18th Edition, 1997.

$$t_{\text{solid}} = (m_{\text{Fuel}} \Delta H_c) / (Q^* A_{\text{Fuel}})$$

Where m_{Fuel} = mass of solid fuel (kg)
 ΔH_c = fuel effective heat of combustion (kJ/kg)
 Q^* = heat release rate per unit floor area of fuel (kW/m²)
 A_{Fuel} = exposed fuel surface area (m²)

$$t_{\text{solid}} = (m_{\text{solid}} \Delta H_c) / (Q^* A_{\text{solid}})$$

| | | | |
|----------------------|-------------|----------------|---------------|
| $t_{\text{solid}} =$ | 5228.92 sec | 87.15 minutes* | ANSWER |
|----------------------|-------------|----------------|---------------|

*Note: In fires, combustion is never complete, leaving some residual fuel, therefore this method provides a reasonable burning duration for solid fuel.

NOTE

The above calculations are based on principles developed in the NFPA Fire Protection Handbook 18th Edition, 1997. Calculations are based on certain assumptions and have inherent limitations. The results of such calculations may or may not have reasonable predictive capabilities for a given situation, and should only be interpreted by an informed user. Although each calculation in the spreadsheet has been verified with the results of hand calculation, there is no absolute guarantee of the accuracy of these calculations. Any questions, comments, concerns, and suggestions, or to report an error(s) in the spreadsheet, please send an email to nxi@nrc.gov.



Office of Nuclear Reactor Regulation

ADDITIONAL PROBLEMS

Consider a pool fire caused by a 38.0 liters (10 gallons) spill of flammable liquid (kerosine oil) in a 0.55 m^2 (6.0 ft^2) dike area in a compartment with a concrete floor. The kerosine oil is ignited and spreads rapidly over the surface, reaching steady burning almost instantly. Compute the HRR, burning duration, and flame height of the pool fire. The dimensions of the compartment are 6.0 m wide x 6.0 m long x 3.7 m high (20.0 ft wide x 20.0 ft long x 12.0 ft high). Two cable trays are located above the pool fire at heights of 2.15 m (7.0 ft) and 3.0 m (10.0 ft), respectively. Determine whether flame will impinge upon the cable trays. Assume instantaneous, complete involvement of the liquid pool with no fire growth and no intervention by the plant fire department or automatic suppression systems.

Assume that heptane from a tank spills on a concrete floor forming a 113.0 m^2 (1261.0 ft^2) pool, the distance from the center of the pool fire to the target edge is 30.0 m (98.0 ft). Calculate the radiative heat flux of the flame at ground level with no wind using—

- (b) Point Source Model
- (c) Solid Flame Radiation Model

A trash fire with an HRR (\dot{Q}) of 1,500 kW occurs in a NPP backup power battery room protected with the fixed temperature heat detectors with an RTI of $165 \text{ (m-sec)}^{1/2}$. Calculate the activation time for the detectors, using listed spacing of 3.05 m (20.0 ft) with a ceiling height of 4.60 m (15 ft). Assume that the detectors have an activation temperature of $57 \text{ }^\circ\text{C}$ ($135 \text{ }^\circ\text{F}$) and the ambient temperature is $20 \text{ }^\circ\text{C}$ ($68 \text{ }^\circ\text{F}$).

A fire scenario arises from the failure of a 4,160V switchgear in a cable spreading room. A stack of safety-related cable (IEEE-383 qualified PE/PVC) is located 4.6 m (15.0 ft) horizontally from the 4,160V breaker. Assume that the breaker fire produces a maximum flame heat flux 50 kW/m^2 and the surface of the cable trays initially at $20 \text{ }^\circ\text{C}$ ($68 \text{ }^\circ\text{F}$). Calculate the ignition time (t_{ig}) of IEEE-383 qualified PE/PVC cables.

A pool fire scenario arises from a rupture in an oil-filled transformer. This event allows the fuel contents of the transformer to spill along a wall with an area of 1.4 m^2 (15 ft^2). A safety-related cable tray is located 5.5 m (18 ft) above the pool fire. Calculate the wall flame height ($H_{f(\text{wall})}$) of the fire, and determine whether flame will impinge upon the cable tray.

A fire scenario arises from a rupture in the housing of a auxiliary lube oil pump. This event allows the fuel contents of the pump to spill along a wall with an area of 0.75 m^2 (8.0 ft^2). A cable tray is located 3.0 m (10.0 ft) above the fire. Calculate flame the height of the line fire ($H_{f(\text{wall line})}$), and determine whether flame will impinge upon the cable tray.

A fire scenario arises from a rupture in an oil-filled transformer in a facility. This event allows the fuel contents of the transformer to spill along the corners of walls with an area of 0.55 m^2 (6.0 ft^2). A cable tray is located 5.5 m (18 ft) above the fire. Calculate the corner fire flame height ($H_{f(\text{corner})}$), and determine whether flame will impinge upon the cable tray.

Consider a compartment that is 9.0 m wide x 9.0 m long x 3.7 m high (30.0 ft wide x 30.0 ft long x 12.0 ft high) (w_c x l_c x h_c) with a door vent that is 0.91 m (3.0 ft) wide x 2.15 m (7.0 ft) high (w_v x h_v). The fire is constant with an HRR (\dot{Q}) of 1,500 kW. Compute the hot gas temperature (T_g) in

the compartment as well as smoke layer height (z) at 5 minutes after ignition, assuming that the compartment boundaries are made of 2.54 cm (1.0 in) thick gypsum board.

Consider a compartment that is 12.2 m wide x 12.2 m long x 3.0 m high (40.0 ft wide x 40.0 ft long x 10.0 ft high) ($w_c \times l_c \times h_c$) with a door vent that is (4.0 ft) wide x (8.0 ft) high ($w_v \times h_v$). The fire is constant with an HRR(\dot{Q}) of 2,000 kW. Compute the hot gas temperature (T_p) in the compartment as well as smoke layer height (z) at 3 minutes after ignition, assuming that the compartment boundaries are made of 0.3048 (12.0 in) thick concrete.

Consider a compartment that is 15.25 m wide x 12.2 m long x 3.7 m high (50.0 ft wide x 40.0 ft long x 12.0 ft high) ($w_c \times l_c \times h_c$) with a forced ventilation rate of 1,500 cfm. Calculate the hot gas layer temperature (T_p) in the compartment for a fire size (\dot{Q}) of 1,800 kW at 5 minutes after ignition, assuming that the compartment boundaries are made of 2.54 cm (1.0 in) thick gypsum board.

Consider a compartment that is 13.7 m wide x 15.25 m long x 3.35 m high (45.0 ft wide x 50.0 ft long x 11.0 ft high) ($w_c \times l_c \times h_c$) with a forced ventilation rate of 1,800 cfm. Calculate the hot gas layer temperature (T_p) in the compartment for a fire size (\dot{Q}) of 2,200 kW at 8 minutes after ignition, assuming compartment boundaries are made of 0.245 m (10.0 in) thick concrete.

Consider a pool fire caused by a 30.30 liters (8.0 gallons) spill of flammable liquid (lube oil) in 0.38 m² (4.0 ft²) dike area in a compartment with a finished concrete floor. The lube oil is ignited and spreads rapidly over the surface reaching steady burning almost instantly. Compute the HRR, burning duration, and flame height of the pool fire. The dimensions of the compartment are 4.9 m wide x 3.7 m long x 3.0 m high (16.0 ft wide x 12.0 ft long x 10.0 ft high). Two cable trays are located above the pool fire at heights of 1.8 m (6.0 ft) and 2.5 m (8.0 ft), respectively. Determine whether flame will impinge upon the cable trays. Assume instantaneous, complete involvement of the liquid pool with no fire growth and no intervention by the plant fire department or automatic suppression systems.

A 75.7 liters (20.0 gallons) trash bag (transient) exposure fire source is located 2.5 m (8.0 ft) beneath a horizontal cable tray. Assumed that the trash fire ignites an area of approximately 0.92 m² (10.0 ft²) of the cable tray, and the cables in the tray are 1d PE. Compute the full-scale HRR of 1d PE cable insulation. The bench-scale HRR (\dot{Q}_{w}^*) of the 1d PE type cable material is 1,071 kW/m².

Assume that heptane from a tank spills on a concrete floor, forming a 0.92 m² (10.0 ft²) pool and exposing an safety-related electrical cabinet in a corridor. The distance from the center of the pool fire to the target (cabinet) edge is 3.7 m (12.0 ft). Calculate the radiative heat flux of the flame to the electrical cabinet with no wind using—

- (a) Point Source Model
- (b) Solid Flame Radiation Model

Estimate the maximum plume temperature ($T_{p(\text{centerline})}$) at the ceiling of a 4.6 m (15.0 ft) high room above a 1,500 kW fire involving a 1½ ft high stack of wood pallets in an 0.92 m² (10.0 ft²) pallet area. Assume that the ambient temperature is 25 °C (77 °F).

A fire with $\dot{Q} = 3,000 \text{ kW}$ occurs in a makeup pump room protected with a wet pipe sprinkler system. Fire sprinklers are rated at $74 \text{ }^\circ\text{C}$ ($165 \text{ }^\circ\text{F}$) [standard response bulb with RTI 235 ($\text{m}\cdot\text{sec}$)^{1/2}] and are located 3.0 m (10.0 ft) on the center. The compartment ceiling is 5.5 m (18.0 ft) high. Determine whether the sprinklers would activate, and if so how long it would take for them to activate.

A fire scenario may arise from failure of a vital 480V AC breaker in a switchgear room. A stack of safety-related cable (IEEE-383 qualified PE/PVC) is located 3.0 m (10.0 ft) horizontally from the 480V AC breaker. Assumed that the vital breaker fire produces a maximum flame heat flux of 30 kW/m^2 and the surface of cable trays initially at $20 \text{ }^\circ\text{C}$ ($68 \text{ }^\circ\text{F}$). Calculate the ignition time (t_{ig}) of IEEE-383 qualified PE/PVC cables.

A pool fire scenario arises from a rupture in an oil-filled transformer containing (5 gallons) lube oil. This event allows the fuel contents of the transformer to spill along a wall with an area of 1.4 m^2 (15.0 ft^2). A safety-related cable tray is located 4.6 m (15.0 ft) above the pool fire. Calculate the wall flame height of the fire, and determine whether flame will impinge upon the cable tray.

A fire scenario arises from a rupture in the housing of a makeup pump containing 30.3-liters (8 gallons) lube oil. This event allows the fuel contents of the pump to spill along a wall with an area of 0.75 m^2 (8.0 ft^2). A cable tray is located 3.7 m (12.0 ft) above the fire. Calculate the flame height of the line fire, and determine whether flame will impinge upon the cable tray.

A fire scenario arises from a rupture in an oil-filled transformer in a facility containing (6 gallons) lube oil. This event allows the fuel contents of the transformer to spill along the corners of the walls with an area of 0.55 m^2 (6 ft^2). A cable tray is located 4.3 m (14.0 ft) above the fire. Calculate the corner fire flame height, and determine whether flame will impinge on the cable tray.

Calculate the HRR necessary for flashover (\dot{Q}_{fo}) in a compartment that is 5.5 m wide x 6.0 m long x 3.7 m high (18.0 ft wide x 20.0 ft long x 12.0 ft high) ($w_c \times l_c \times h_c$), with an opening that is 0.60 m (2.0 ft) wide x 1.83 m (6.0 ft) high ($w_v \times h_v$). Assume that the boundary material is concrete and the door is open.

Calculate the HRR necessary for flashover (\dot{Q}_{fo}) in a cable spreading room (CSR) that is 15.3 m wide x 24.4 m long x 6.0 m high (50.0 ft wide x 80.0 ft long x 20.0 ft high) ($w_c \times l_c \times h_c$) with an door opening 1.2 m (4.0 ft) wide x 3.0 m (10.0 ft) high ($w_v \times h_v$). The compartment boundaries are made of concrete and the door is open.

Consider a compartment in a facility pump room that is 3.0 m wide x 2.7 m long x 2.5 m high (10.0 ft wide x 9.0 ft long x 8.0 ft high) ($w_c \times l_c \times h_c$). A fire starts with a constant effect of 75 kW. Estimate the pressure increase attributable to the expansion of hot fire gases after 15 seconds, assuming that the door is closed.

The licensee used UL Design No. 816 to protect a number of unrestrained beams. The licensee's quality assurance (QA) program verified that there is 6.35 cm (2½ in) thickness of fire protection insulation on all of the beams. The size of the tested beam was W12 x 26. Determine whether the 6.35 cm (2½ in) thickness of fire protection insulation is acceptable for a beam that is W8 x 13.

The licensee used UL listed fire resistance insulation designed to protect columns. The thickness of the fire resistive material (insulation) applied to the rated column (W16 x 40)

is 5.08 cm (2 in). Determine whether 5.08 cm (2 in) thickness of fire protection coating is acceptable for a column that is W6 x 12.

BIBLIOGRAPHIC DATA SHEET

(See instructions on the reverse)

1. REPORT NUMBER
(Assigned by NRC, Add Vol., Supp., Rev.,
and Addendum Numbers, if anv.)

NUREG-1805, Vol. 2

3. DATE REPORT PUBLISHED

| MONTH | YEAR |
|-------|------|
| June | 2003 |

4. FIN OR GRANT NUMBER

6. TYPE OF REPORT

Technical

7. PERIOD COVERED (Inclusive Dates)

2. TITLE AND SUBTITLE

Fire Dynamics Tools (FDTs)
Quantitative Fire Hazard Analysis Methods for the
U.S. Nuclear Regulatory Commission
Fire Protection Inspection Program
Appendices Draft Report for Comment

5. AUTHOR(S)

N. Iqbal, M.H. Salley

8. PERFORMING ORGANIZATION - NAME AND ADDRESS (If NRC, provide Division, Office or Region, U.S. Nuclear Regulatory Commission, and mailing address; if contractor, provide name and mailing address.)

Division of Systems Safety and Analysis
Office of Nuclear Reactor Regulation
U.S. Nuclear Regulatory Commission
Washington, DC 20555-0001

9. SPONSORING ORGANIZATION - NAME AND ADDRESS (If NRC, type "Same as above"; if contractor, provide NRC Division, Office or Region, U.S. Nuclear Regulatory Commission, and mailing address.)

Same as above

10. SUPPLEMENTARY NOTES

11. ABSTRACT (200 words or less)

The U.S. Nuclear Regulatory Commission (NRC), Office of Nuclear Reactor Regulation (NRR), Division of Systems Safety and Analysis (DSSA), Plant Systems Branch (SPLB), Fire Protection Engineering and Special Projects Section has developed quantitative methods, known as "Fire Dynamics Tools (FDTs)," to assist regional fire protection inspectors in performing fire hazard analysis (FHA). These methods have been implemented in spreadsheets and taught at the NRC's quarterly regional inspector workshops conducted in 2001-2002. The goal of the training is to assist inspectors in calculating the quantitative aspects of a postulated fire and its effects on safe nuclear power plant (NPP) operation. FDTs were developed using state-of-the-art fire dynamics equations and correlations that were pre-programmed and locked into Microsoft Excel® spreadsheets. These FDTs will enable the inspector to perform quick, easy, first-order calculations for the potential fire scenarios using today's state-of-the-art principles of fire dynamics. Each FDTs spreadsheet also contains a list of the physical and thermal properties of the materials commonly encountered in NPPs. The FDTs are intended to assist fire protection inspectors in performing risk-informed evaluations of credible fires that may cause critical damage to essential safe-shutdown equipment. This is the process required by the new reactor oversight process (ROP) in the NRC's inspection manual. In the new ROP, the NRC is moving toward a more risk-informed, objective, predictable, understandable, and focused regulatory process. This NUREG addresses the technical bases for FDTs. The subject matter of this NUREG covers many aspects of fire dynamics and contains descriptions of the most important fire processes. A significant number of examples, reference tables, illustrations, and conceptual drawings are presented in this NUREG to expand the inspector's appreciation in visualizing and retaining the material and understanding calculation methods.

12. KEY WORDS/DESCRIPTORS (List words or phrases that will assist researchers in locating the report.)

Fire dynamics
Hazard analysis
Inspection
Significance determination process
Risk-informed evaluation

13. AVAILABILITY STATEMENT

unlimited

14. SECURITY CLASSIFICATION

(This Page)

unclassified

(This Report)

unclassified

15. NUMBER OF PAGES

16. PRICE

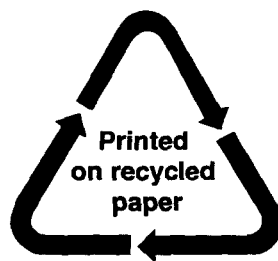

Federal Recycling Program

**UNITED STATES
NUCLEAR REGULATORY COMMISSION
WASHINGTON, DC 20555-0001**

OFFICIAL BUSINESS