

Common-Cause Failure Event Insights

Pumps

Idaho National Engineering and Environmental Laboratory

U.S. Nuclear Regulatory Commission
Office of Nuclear Regulatory Research
Washington, DC 20555-0001

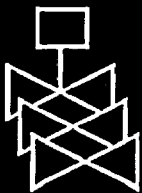
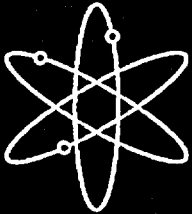
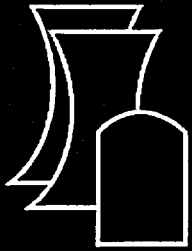

AVAILABILITY OF REFERENCE MATERIALS IN NRC PUBLICATIONS

NRC Reference Material

As of November 1999, you may electronically access NUREG-series publications and other NRC records at NRC's Public Electronic Reading Room at <http://www.nrc.gov/reading-rm.html>. Publicly released records include, to name a few, NUREG-series publications; *Federal Register* notices; applicant, licensee, and vendor documents and correspondence; NRC correspondence and internal memoranda; bulletins and information notices; inspection and investigative reports; licensee event reports; and Commission papers and their attachments.

NRC publications in the NUREG series, NRC regulations, and *Title 10, Energy*, in the Code of *Federal Regulations* may also be purchased from one of these two sources.

1. The Superintendent of Documents
U.S. Government Printing Office
Mail Stop SSOP
Washington, DC 20402-0001
Internet: bookstore.gpo.gov
Telephone: 202-512-1800
Fax: 202-512-2250
2. The National Technical Information Service
Springfield, VA 22161-0002
www.ntis.gov
1-800-553-6847 or, locally, 703-605-6000

A single copy of each NRC draft report for comment is available free, to the extent of supply, upon written request as follows:

Address: Office of the Chief Information Officer,
Reproduction and Distribution
Services Section
U.S. Nuclear Regulatory Commission
Washington, DC 20555-0001
E-mail: DISTRIBUTION@nrc.gov
Facsimile: 301-415-2289

Some publications in the NUREG series that are posted at NRC's Web site address <http://www.nrc.gov/reading-rm/doc-collections/nuregs> are updated periodically and may differ from the last printed version. Although references to material found on a Web site bear the date the material was accessed, the material available on the date cited may subsequently be removed from the site.

Non-NRC Reference Material

Documents available from public and special technical libraries include all open literature items, such as books, journal articles, and transactions, *Federal Register* notices, Federal and State legislation, and congressional reports. Such documents as theses, dissertations, foreign reports and translations, and non-NRC conference proceedings may be purchased from their sponsoring organization.

Copies of industry codes and standards used in a substantive manner in the NRC regulatory process are maintained at—

The NRC Technical Library
Two White Flint North
11545 Rockville Pike
Rockville, MD 20852-2738

These standards are available in the library for reference use by the public. Codes and standards are usually copyrighted and may be purchased from the originating organization or, if they are American National Standards, from—

American National Standards Institute
11 West 42nd Street
New York, NY 10036-8002
www.ansi.org
212-642-4900

Legally binding regulatory requirements are stated only in laws; NRC regulations; licenses, including technical specifications; or orders, not in NUREG-series publications. The views expressed in contractor-prepared publications in this series are not necessarily those of the NRC.

The NUREG series comprises (1) technical and administrative reports and books prepared by the staff (NUREG-XXXX) or agency contractors (NUREG/CR-XXXX), (2) proceedings of conferences (NUREG/CP-XXXX), (3) reports resulting from international agreements (NUREG/IA-XXXX), (4) brochures (NUREG/BR-XXXX), and (5) compilations of legal decisions and orders of the Commission and Atomic and Safety Licensing Boards and of Directors' decisions under Section 2.206 of NRC's regulations (NUREG-0750).

DISCLAIMER: This report was prepared as an account of work sponsored by an agency of the U.S. Government. Neither the U.S. Government nor any agency thereof, nor any employee, makes any warranty, expressed or implied, or assumes any legal liability or responsibility for any third party's use, or the results of such use, of any information, apparatus, product, or process disclosed in this publication, or represents that its use by such third party would not infringe privately owned rights.

Common-Cause Failure Event Insights

Pumps

Manuscript Completed: March 2003

Date Published: May 2003

Prepared by

T. E. Wierman, INEEL

D. M. Rasmuson, NRC

N. B. Stockton, INEEL

Idaho National Engineering and Environmental Laboratory
Idaho Falls, ID 83415

T.R. Wolf, NRC Project Manager

Prepared for

Division of Risk Analysis and Applications

Office of Nuclear Regulatory Research

U.S. Nuclear Regulatory Commission

Washington, DC 20555-0001

NRC Job Code Y6194



ABSTRACT

This report documents a study performed on the set of common-cause failures (CCF) of pumps from 1980 to 2000. The data studied here were derived from the NRC CCF database, which is based on US commercial nuclear power plant event data. This report is the result of an in-depth review of the pump CCF data and presents several insights about the pump CCF data. The objective of this document is to look beyond the CCF parameter estimates that can be obtained from the CCF data to gain further understanding of why CCF events occur and what measures may be taken to prevent, or at least mitigate the effect of, pump CCF events. This report presents quantitative presentation of the pump CCF data and discussion of some engineering aspects of the pump events.

CONTENTS

Abstract.....	iii
Executive Summary.....	xi
Foreword.....	xv
Acknowledgments	xvii
Acronyms.....	xix
Glossary	xxi
1. Introduction.....	1
1.1 Background.....	1
1.2 Common-Cause Failure Event Concepts.....	2
1.3 Report Structure.....	4
2. Pump Component Description	7
2.1 Introduction.....	7
2.2 Risk Significance	7
2.3 Component Description and Boundary.....	7
2.4 Segment Description.....	8
2.4.1 Pump	8
2.4.2 Driver	8
2.4.3 Suction	9
2.4.4 Discharge	9
2.5 System Descriptions	9
2.6 Failure Modes	13
3. High Level Overview Of Pump Insights.....	15
3.1 Introduction.....	15
3.2 CCF Trends Overview	16
3.3 CCF Segment Overview	18
3.4 CCF Proximate Cause.....	19
3.5 CCF Coupling Factor.....	22

3.6	CCF Discovery Method Overview	25
3.7	Pump CCF System Observations.....	26
3.8	Other Pump CCF Observations	26
4.	Engineering Insights By Pump Segment.....	29
4.1	Introduction.....	29
4.2	Pump.....	31
4.3	Driver.....	34
4.4	Suction	38
4.5	Discharge	43
5.	Engineering Insights By Pump System.....	47
5.1	Introduction.....	47
5.2	Emergency Service Water	47
5.3	High Pressure Injection.....	50
5.4	Auxiliary Feedwater	52
5.5	Residual Heat Removal (PWR).....	55
5.6	Standby Liquid Control	57
5.7	Residual Heat Removal (BWR).....	60
5.8	Other Systems.....	62
6.	How To Obtain More Detailed Information.....	63
7.	References.....	65
Appendix A	Data Summary	A-1
Appendix B	Pump Data Summary by Segment.....	B-1
Appendix C	Pump CCF Data Summary by System	C-1

FIGURES

Figure ES-1. Trend for all pump CCF events. The decreasing trend is statistically significant with a p-value = 0.0001.....	xii
Figure ES-2. Proximate cause distribution for all pump CCF events.....	xiii
Figure ES-3. System distribution for all pump CCF events.....	xiv
Figure 2-1. Pump component boundary drawing.....	8
Figure 2-2. PWR Containment Spray system diagram.....	9
Figure 2-3. BWR RHR system diagram.....	10
Figure 2-4. PWR Auxiliary Feedwater system diagram.....	10
Figure 2-5. Generic Emergency Service Water system diagram.....	11
Figure 2-6. PWR High Pressure Safety Injection and Coolant Charging system diagram.....	11
Figure 2-7. BWR High Pressure Coolant Injection and Reactor Core Isolation Cooling systems diagram.....	12
Figure 2-8. PWR RHR system diagram.....	12
Figure 2-9. BWR Standby Liquid Control system diagram.....	13
Figure 3-1. Trend for all pump CCF events. The decreasing trend is statistically significant with a p-value = 0.0001.....	16
Figure 3-2. Trend for Complete pump CCF events. The decreasing trend is statistically significant with a p-value = 0.0001.....	17
Figure 3-3. Trend for all pump CCF events for the fail-to-start failure mode. The decreasing trend is statistically significant with a p-value = 0.0001.....	17
Figure 3-4. Trend for all pump CCF events for the fail-to-run failure mode. The decreasing trend is statistically significant with a p-value = 0.0001.....	18
Figure 3-5. Segment distribution for all pump CCF events.....	19
Figure 3-6. Proximate cause distribution for all pump CCF events.....	20
Figure 3-7. Coupling factor distribution for all pump CCF events.....	23
Figure 3-8. Discovery method distribution for all pump CCF events.....	26
Figure 3-9. Distribution of pump CCF events by system.....	27

Figure 3-10. Distribution of NPP units experiencing a multiplicity of CCFs for all pump CCF events.....	27
Figure 4-1. Distribution of proximate causes for the pump segment.	31
Figure 4-2. Distribution of the method of discovery for the pump segment.	32
Figure 4-3. Distribution of the affected piece parts for the pump segment.	33
Figure 4-4. Distribution of proximate causes for the driver segment.	34
Figure 4-5. Distribution of the method of discovery for the driver segment.	35
Figure 4-6. Distribution of the affected piece part for the driver segment.	36
Figure 4-7. Distribution of proximate causes for the suction segment.	39
Figure 4-8. Distribution of the method of discovery for the suction segment,	40
Figure 4-9. Distribution of the affected piece parts for the suction segment.....	40
Figure 4-10. Distribution of proximate causes for the discharge segment.	44
Figure 4-11. Distribution of the method of discovery for the discharge segment.	45
Figure 4-12. Distribution of the affected piece parts for the discharge segment.....	46
Figure 5-1. Proximate cause distribution for the ESW system.	48
Figure 5-2. Method of discovery distribution for the ESW system.....	48
Figure 5-3. Piece part distribution for the ESW system.	49
Figure 5-4. Segment distribution for the ESW system.	49
Figure 5-5. Proximate cause distribution for the HPI system.	50
Figure 5-6. Method of discovery distribution for the HPI system.	51
Figure 5-7. Piece part distribution for the HPI system.	51
Figure 5-8. Segment distribution for the HPI system.	52
Figure 5-9. Proximate cause distribution for the AFW system.	53
Figure 5-10. Method of discovery distribution for the AFW system.	53
Figure 5-11. Piece part distribution for the AFW system.....	54
Figure 5-12. Segment distribution for the AFW system.....	54
Figure 5-13. Proximate cause distribution for the RHR-P system.....	55

Figure 5-14. Method of discovery distribution for the RHR-P system.....	56
Figure 5-15. Piece part distribution for the RHR-P system.....	56
Figure 5-16. Segment distribution for the RHR-P system.....	57
Figure 5-17. Proximate cause distribution for the SLC system.....	58
Figure 5-18. Method of discovery distribution for the SLC system.....	58
Figure 5-19. Piece part distribution for the SLC system.....	59
Figure 5-20. Segment distribution for the SLC system.....	59
Figure 5-21. Proximate cause distribution for the RHR-B system.....	60
Figure 5-22. Method of discovery distribution for the RHR-B system.....	61
Figure 5-23. Piece part distribution for the RHR-B system.....	61
Figure 5-24. Segment distribution for the RHR-B system.....	62

TABLES

Table F-1. Summary of insights from pump common-cause failure events.....	xv
Table 3-1. Summary statistics of pump data.....	15
Table 4-1. Summary of segments.	29
Table 4-2. Proximate cause hierarchy.	30
Table 4-3. CCF events in pump segment by cause group and degree of failure.	31
Table 4-4. Pump segment event short descriptions for Complete events.	33
Table 4-5. CCF events in the driver segment by cause group and degree of failure.	34
Table 4-6. Driver segment event short descriptions for Complete events.	36
Table 4-7. CCF events in the suction segment by cause group and degree of failure.	38
Table 4-8. Suction segment event short descriptions for Complete events.	41
Table 4-9. CCF events in the discharge segment by cause group and degree of failure.	44
Table 4-10. Discharge segment event short description for the Complete event.	46
Table 5-1. Summary of systems.	47

EXECUTIVE SUMMARY

This report provides insights related to pump common-cause failure (CCF) events. These events were obtained from the U.S. Nuclear Regulatory Commission's (NRC) CCF Database. The pump CCF data contains attributes about events that are of interest in the understanding of: completeness of the failures, occurrence rate trends of the events, pump segments affected, causal factors, coupling or linking factors, event detection methods, and pump manufacturer. Distributions of these CCF characteristics and trends were analyzed and individual events were reviewed for insights.

General Insights. The study identified 274 events occurring at U.S. nuclear power plant (NPP) units during the period from 1980 through 2000. Thirty-three NPP units each had one CCF event during the period; 21 NPP units did not experience a CCF event. This accounts for about 50 percent of the NPP units. While only 38 NPP units experienced more than two pump CCF events, these 38 NPP units account for 76 percent of the total number of pump CCF events. Of the 274 events, 62 (23 percent) were Complete common-cause failures (failure events with all components failed due to a single cause in a short time).

Failure Modes. The events were classified as either fail-to-start or fail-to-run. The failure mode for the majority of the pump CCF events is fail-to-run (54 percent). The fail-to-start failure mode accounted for the other 46 percent of the events.

Trends. Figure ES-1 shows the trend for all pump CCF events. The decreasing trend for all pump CCF events is statistically significant with a p-value of 0.0001. There was insufficient information to determine what caused the decreasing trend in CCF events, but there were several regulatory initiatives by the NRC and industry initiatives by utilities, INPO, and EPRI involving improved operation, maintenance, testing, and inspection during the 21 years of improving performance. Both the fail-to-start and the fail-to-run failure modes for pump CCF events were similar statistically-significant decreasing trends. The trend for the Complete events from 1980-2000 is a decreasing trend and is statistically significant with a p-value = 0.0001.

Method of Discovery. When the method of discovery was investigated, Testing accounted for 95 events, (35 percent), 83 events (30 percent) were discovered during Demand, Inspection accounted for 69 events (25 percent), and 27 events (10 percent) were detected during Maintenance activities. Considering the extensive and frequent surveillance test requirements for pumps contained in the Technical Specifications and the standby nature of most of the pumps in this study, it is expected that a majority of the pump CCF events would be detected by Testing. The failures detected by testing tended to be Internal to Component causes attributed to wear and aging and only a small percentage of these failures resulted in Complete CCF events. It was expected that fewer failures would be detected by Demand. Analysis of events showed that over half of the events discovered by Demand were Complete or Almost Complete. The majority of events detected by Demand were attributed to design errors, human errors, and the Others category. These causes were also dominant for all Complete CCF events. This implies that testing may be effective at detecting normal wear and aging problems, but less effective at detecting failures related to design and human errors.

Segment. Overall, for all pumps, the highest number of events occurred in the pump segment (106 events or 39 percent). The driver and suction segments were also significant contributors (32 and 24 percent, respectively), while relatively few events involved the discharge segment. These statistics vary by system. For the emergency service water (ESW) and standby liquid control (SLC) systems, most of the failures occurred in the pump segment. However, for the auxiliary feedwater (AFW), high pressure injection (HPI), and BWR residual heat removal (RHR-B) systems, most of the failures occurred in the driver segment, and for the PWR residual heat removal (RHR-P) system, most of the failures occurred in the suction segment. Events involving the driver and suction segments were more likely to be Complete. Ninety-two percent of all Complete events occurred in these two segments.

Piece Parts. The most common piece parts involved in pump segment CCF events were the impellers and wear rings. The most likely piece parts involved in driver segment CCF events were circuit breakers and instrument and control circuits. The most likely piece part involved in the suction segment CCF events was piping. The most likely piece part involved in discharge segment CCF events was the valves.

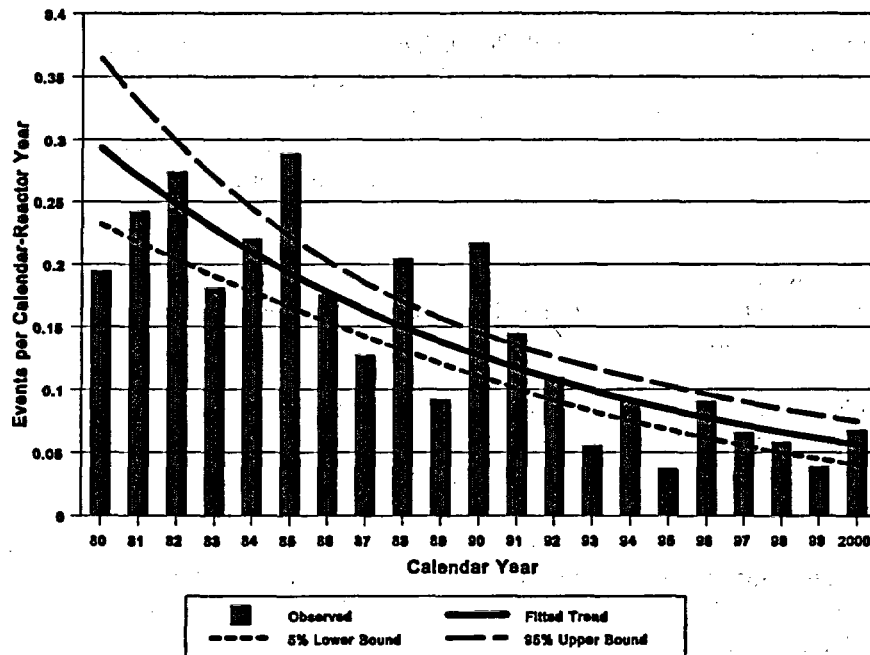

Figure ES-1. Trend for all pump CCF events. The decreasing trend is statistically significant with a p-value = 0.0001.

Proximate Cause. As shown in Figure ES-2, the leading proximate cause was Internal to Component, which accounted for about 39 percent of the total events; however, none of these events were Complete. Design/Construction/Installation/Manufacture Inadequacy and Human Error accounted for 24 and 20 percent of the total events, respectively. The Other and External Environment proximate causes were attributed to a small fraction of the pump CCF events.

The Internal to Component proximate cause category is the most likely for the pumps and encompasses the malfunctioning of hardware internal to the component. Internal causes result from phenomena such as normal wear or other intrinsic failure mechanisms, which are influenced by the

ambient environment of the component. Specific mechanisms include erosion, corrosion, internal contamination, fatigue, wear-out, and end of life.

The Design/Construction/Installation /Manufacture Inadequacy proximate cause group is important for pumps and encompasses events related to the design, construction, installation, and manufacture of components, both before and after the plant is operational. Included in this category are events resulting from errors in equipment and system specifications, material specifications, and calculations. Events related to maintenance activities are not included.

The Operational/Human Error proximate cause group is the next most likely for pumps and represents causes related to errors of omission or commission on the part of plant staff or contractor staff. Included in this category are accidental actions, failures to follow the correct procedures or following inadequate procedures for construction, modification, operation, maintenance, calibration, and testing. This proximate cause group also includes deficient training.

Coupling Factors. Maintenance was the leading coupling factor with 111 events (41 percent). The next leading coupling factor was Design with 76 events (28 percent). While not the leading coupling factor, over half (51 percent) of the Design coupled events were either Complete or Almost Complete. The Environmental and Operational coupling factors account for the majority of the remaining events (44 and 28 events, respectively). Only a small fraction of the events coupled by Environmental were Complete; however, over half (57 percent) of the events coupled by Operational were Complete. These Complete events were almost all coupled by inadequate operations procedures. Only 15 events were coupled by Quality, and three of these were Complete and affected the Driver segment.

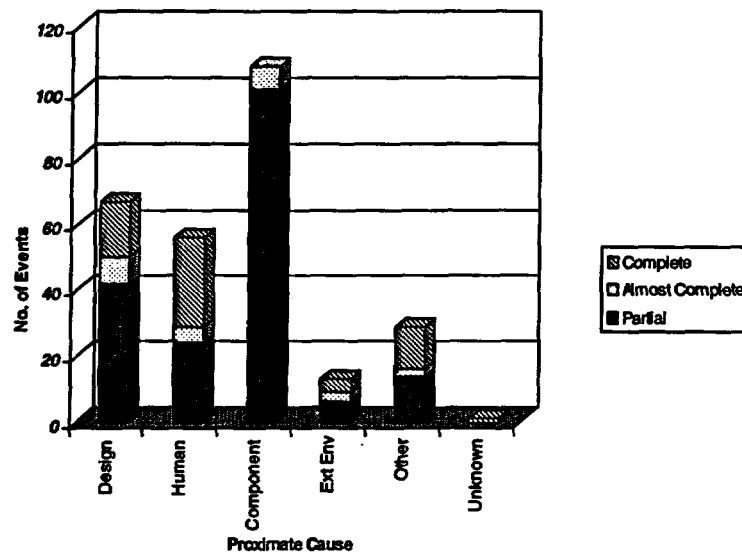

Figure ES-2. Proximate cause distribution for all pump CCF events.

System. Figure ES-3 shows the distribution of pump CCF events by affected system. The ESW system had the most events. Most pump CCF events in the ESW system involved problems with the pump impellers and wear rings. The RHR-P system had the largest fraction of Complete CCF events (92

percent). Most of the RHR-P system events involved loss of suction, usually during refueling outages with reduced water level in the reactor coolant system.

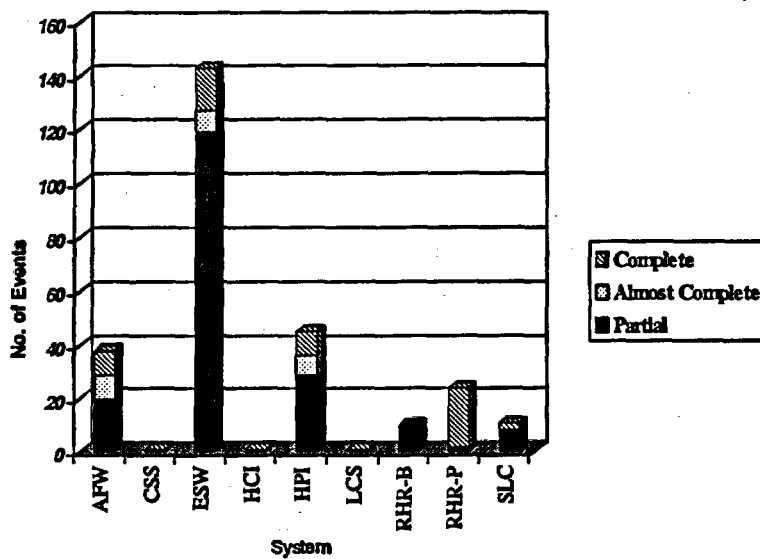

Figure ES-3. System distribution for all pump CCF events.

FOREWORD

This report provides common-cause failure (CCF) event insights for pumps. The results, findings, conclusions, and information contained in this study, the initiating event update study, and related system reliability studies conducted by the Office of Nuclear Regulatory Research support a variety of risk-informed NRC activities. These include providing information about relevant operating experience that can be used to enhance plant inspections of risk-important systems, and information used to support staff technical reviews of proposed license amendments, including risk-informed applications. In addition, this work will be used in the development of enhanced performance indicators that will be based largely on plant-specific system and equipment performance.

Findings and conclusions from the analyses of the pump CCF data, which are based on 1980-2000 operating experience, are presented in the Executive Summary. High-level insights of the pump CCF data are presented in Section 3. Section 4 summarizes the events by sub-component. Section 5 presents pump CCF insights by the pump system. Section 6 provides information about how to obtain more detailed information for the pump CCF events. The information to support risk-informed regulatory activities related to the pump CCF data is summarized in Table F-1. This table provides a condensed index of risk-important data and results presented in discussions, tables, figures, and appendices.

Table F-1. Summary of insights from pump common-cause failure events.

Item	Description	Text Reference	Page(s)	Data
1.	CCF trends overview	Section 3.2	16	Figure 3-1 – Figure 3-4
2.	CCF segment overview	Section 3.3	18	Figure 3-5
3.	CCF proximate cause overview	Section 3.4	19	Figure 3-6
4.	CCF coupling factor overview	Section 3.5	22	Figure 3-7
5.	CCF discovery method overview	Section 3.6	25	Figure 3-8
6.	CCF system overview	Section 3.7	26	Figure 3-9
7.	Engineering Insights – Pump Segment	Section 4.2	31	Figure 4-1 – Figure 4-3
8.	Engineering Insights – Driver Segment	Section 4.3	34	Figure 4-4 – Figure 4-6
9.	Engineering Insights – Suction Segment	Section 4.4	38	Figure 4-7 – Figure 4-9
10.	Engineering Insights – Discharge Segment	Section 4.5	43	Figure 4-10 – Figure 4-12
11.	Engineering Insights - ESW System	Section 5.2	47	Figure 5-1 – Figure 5-4
12.	Engineering Insights - HPI System	Section 5.3	50	Figure 5-5 – Figure 5-8
13.	Engineering Insights - AFW System	Section 5.4	52	Figure 5-9 – Figure 5-12
14.	Engineering Insights - RHR (PWR) System	Section 5.5	55	Figure 5-13 – Figure 5-16
15.	Engineering Insights – Standby Liquid Control System	Section 5.6	57	Figure 5-17 – Figure 5-20
16.	Engineering Insights – RHR (BWR) System	Section 5.7	60	Figure 5-21 – Figure 5-24
17.	Data Summaries	Appendix A, B, and C		

The application of results to plant-specific applications may require a more detailed review of the relevant Licensee Event Report (LER) and Nuclear Plant Reliability Data System (NPRDS) or Equipment

Performance Information and Exchange System (EPIX) data cited in this report. This review is needed to determine if generic experiences described in this report and specific aspects of the pump CCF events documented in the LER and NPRDS failure records are applicable to the design and operational features at a specific plant or site. Factors such as system design, specific pump components installed in the system, and test and maintenance practices would need to be considered in light of specific information provided in the LER and NPRDS failure records. Other documents such as logs, reports, and inspection reports that contain information about plant-specific experience (e.g., maintenance, operation, or surveillance testing) should be reviewed during plant inspections to supplement the information contained in this report.

Additional insights may be gained about plant-specific performance by examining the specific events in light of overall industry performance. In addition, a review of recent LERs and plant-specific component failure information in NPRDS or EPIX may yield indications of whether performance has undergone any significant change since the last year of this report. NPRDS archival data (through 1996) and EPIX failure data are proprietary information that can be obtained from the EPIX database through the Institute of Nuclear Power Operations (INPO). NRC staff and contractors can access that information through the EPIX database.

Common-cause failures used in this study were obtained from the common-cause failure database maintained for the NRC by the INEEL. NRC staff and contractors can access the plant-specific CCF information through the CCF database that is available on CD-ROM and has been provided to the NRC Regions and NRC Office of Nuclear Reactor Regulation (NRR). To obtain access to the NRC CCF Database, contact Dale Rasmuson [dmr@nrc.gov; (301) 415-7571] at the NRC or S. Ted Wood at the INEEL [stw@inel.gov; (208) 526-8729].

Periodic updates to the information in this report will be performed, as additional data become available. In the future, these insights will be available on the RES internal web page.

Scott F. Newberry, Director
Division of Risk Analysis & Applications
Office of Nuclear Regulatory Research

ACKNOWLEDGMENTS

This report benefited from the questions and comments of P.W. Baranowsky, S.E. Mays, T.R. Wolf, W.S. Raughley, R.L. Lloyd, A. Serkiz, D.E. Hickman, S.R. Stein, D.H. Coe, P.S. Koltay, A.A. El-Bassioni, W.E. Scott, G.W. Parry, H.J. VanderMolen, L.L. Collins, and W.C. Leschek of the Nuclear Regulatory Commission.

Technical reviews by M.B. Sattison of the INEEL, T. J. Mikschl, and K. N. Fleming of ERIN Engineering, and A. Mosleh contributed substantially to the final report.

Technical contributions were made by F. M. Marshall and W. J. Kohn of the INEEL.

ACRONYMS

AFW	auxiliary feedwater (PWR)
BWR	boiling water reactor
CCCG	common-cause failure component group
CCF	common-cause failure
CCP	centrifugal charging pump
CSR	containment spray recirculation (PWR)
CVC	chemical and volume control
EPIX	equipment performance and information exchange
ESW	emergency service water
FTR	fail-to-run
FTS	fail-to-start
HCI	high pressure coolant injection (BWR)
HPI	high pressure safety injection (PWR)
INEEL	Idaho National Engineering and Environmental Laboratory
INPO	Institute of Nuclear Power Operations
IPE	individual plant examination
LCS	low pressure core spray (BWR)
LER	licensee event report
LOCA	loss of coolant accident
MDAFP	motor-driven auxiliary feedwater pump
MDP	motor-driven pump
NPP	nuclear power plant
NPRDS	Nuclear Plant Reliability Data System
NPSH	net positive suction head
NRC	Nuclear Regulatory Commission
PRA	probabilistic risk assessment
PWR	pressurized water reactor
RCI	reactor core isolation cooling (BWR)
RCS	reactor coolant system
RHR	residual heat removal
RHR-B	residual heat removal (BWR)
RHR-P	residual heat removal (PWR)
RHRSW	residual heat removal service water
RWST	refueling water storage tank
SCSS	Sequence Coding and Search System
SDC	shutdown cooling (BWR)

SG	steam generator
SI	safety injection
SLC	standby liquid control (BWR)
SW	service water
TDP	turbine-driven pump
USI	unresolved safety issue

GLOSSARY

Application—A particular set of CCF events selected from the common-cause failure database for use in a specific study.

Average Impact Vector—An average over the impact vectors for different hypotheses regarding the number of components failed in an event.

Basic Event—An event in a reliability logic model that represents the state in which a component or group of components is unavailable and does not require further development in terms of contributing causes.

Common-cause Event—A dependent failure in which two or more component fault states exist simultaneously, or within a short time interval, and are a direct result of a shared cause.

Common-cause Basic Event—In system modeling, a basic event that represents the unavailability of a specific set of components because of shared causes that are not explicitly represented in the system logic model as other basic events.

Common-cause Component Group—A group of (usually similar [in mission, manufacturer, maintenance, environment, etc.]) components that are considered to have a high potential for failure due to the same cause or causes.

Common-cause Failure Model—The basis for quantifying the probability of common-cause events. Examples include the beta factor, alpha factor, basic parameter, and the binomial failure rate models.

Component—An element of plant hardware designed to provide a particular function.

Component Boundary—The component boundary encompasses the set of piece parts that are considered to form the component.

Component Degradation Value—The assessed probability ($0.0 \leq p \leq 1.0$) that a functionally- or physically-degraded component would fail to complete the mission.

Component State—Component state defines the component status in regard to its intended function. Two general categories of component states are defined, available, and unavailable.

Available—The component is available if it is capable of performing its function according to a specified success criterion. (N.B., available is not the same as availability.)

Unavailable—The component is unavailable if the component is unable to perform its intended function according to a stated success criterion. Two subsets of unavailable states are failure and functionally unavailable.

Coupling Factor/Mechanism—A set of causes and factors characterizing why and how a failure is systematically induced in several components.

Date—The date of the failure event, or date the failure was discovered.

Defense—Any operational, maintenance, and design measures taken to diminish the probability and/or consequences of common-cause failures.

Degree of Failure—The Degree of Failure category has three groups: Complete, Almost Complete, and Partial. The degree of failure is a categorization of a CCF event by the magnitude of three quantification parameters: component degradation value, shared cause factor, and timing factor. These parameters can be given values from zero to 1.0. The degree of failure categories are defined as follows:

Complete—A common-cause failure in which all redundant components are failed simultaneously as a direct result of a shared cause; i.e., the component degradation value equals 1.0 for all components, and both the timing factor and the shared cause factor are equal to 1.0.

Almost Complete—A common-cause failure in which one of the parameters is not equal to 1.0. Examples of events that would be termed Almost Complete are: events in which most components are completely failed and one component is degraded, or all components are completely failed but the time between failures is greater than one inspection interval.

Partial—All other common-cause failures (i.e., more than one of the quantification parameters is not equal to 1.0.)

Dependent Basic Events—Two or more basic events, A and B, are statistically dependent if, and only if,

$$P[A \cap B] = P[B | A]P[A] = P[A | B]P[B] \neq P[A]P[B],$$

where $P[X]$ denotes the probability of event X.

Event—An event is the occurrence of a component state or a group of component states.

Exposed Population—The set of components within the plant that are potentially affected by the common-cause failure event under consideration.

Failure—The component is not capable of performing its specified operation according to a success criterion.

Failure Mechanism—The history describing the events and influences leading to a given failure.

Failure Mode—A description of component failure in terms of the component function that was actually or potentially unavailable.

Failure Mode Applicability—The analyst's probability that the specified component failure mode for a given event is appropriate to the particular application.

Functionally Unavailable—The component is capable of operation, but the function normally provided by the component is unavailable due to lack of proper input, lack of support function from a source outside the component (i.e., motive power, actuation signal), maintenance, testing, the improper interference of a person, etc.

Impact Vector—An assessment of the impact an event would have on a common-cause component group. The impact is usually measured as the number of failed components out of a set of similar components in the common-cause component group.

Independent Basic Events—Two basic events, A and B, are statistically independent if, and only if,

$$P[A \cap B] = P[A]P[B],$$

where $P[X]$ denotes the probability of event X.

Mapping—The impact vector of an event must be “mapped up” or “mapped down” when the exposed population of the target plant is higher or lower than that of the original plant that experienced the common-cause failure. The result of mapping an impact vector is an adjusted impact vector applicable to the target plant.

Mapping Up Factor—A factor used to adjust the impact vector of an event when the exposed population of the target plan is higher than that of the original plant that experienced the common-cause failure.

P-Value—A p-value is a probability, that indicates a measure of statistical significance. The smaller the p-value, the greater the significance. A p-value of less than 0.05 is generally considered statistically significant.

Potentially Unavailable—The component is capable of performing its function according to a success criterion, but an incipient or degraded condition exists. (N.B., potentially unavailable is not synonymous with hypothetical.)

Degraded—The component is in such a state that it exhibits reduced performance but insufficient degradation to declare the component unavailable according to the specified success criterion.

Incipient—The component is in a condition that, if left un-remedied, could ultimately lead to a degraded or unavailable state.

Proximate Cause—A characterization of the condition that is readily identified as leading to failure of the component. It might alternatively be characterized as a symptom.

Reliability Logic Model—A logical representation of the combinations of component states that could lead to system failure. A fault tree is an example of a system logic model.

Root Cause—The most basic reason for a component failure, which, if corrected, could prevent recurrence. The identified root cause may vary depending on the particular defensive strategy adopted against the failure mechanism.

Shared-Cause Factor (c)—A number that reflects the analyst’s uncertainty ($0.0 \leq c \leq 1.0$) about the existence of coupling among the failures of two or more components, i.e., whether a shared cause of failure can be clearly identified.

Shock—A shock is an event that occurs at a random point in time and acts on the system; i.e., all the components in the system simultaneously. There are two kinds of shocks distinguished by the potential impact of the shock event, i.e., lethal and nonlethal.

Statistically Significant—The term “statistically significant” means that the data are too closely correlated to be attributed to chances and consequently have a systematic relationship.

System—The entity that encompasses an interacting collection of components to provide a particular function or functions.

Timing Factor (q)—The probability ($0.0 \leq q \leq 1.0$) that two or more component failures (or degraded states) separated in time represent a common-cause failure. This can be viewed as an indication of the strength-of-coupling in synchronizing failure times.

Common-Cause Failure Event Insights for Pumps

1. INTRODUCTION

This report presents insights about the common-cause events that have occurred in the pump (pump) system at operating nuclear power plants.

The insights for the U.S. plants are derived from information captured in the common-cause failure (CCF) database maintained for the Nuclear Regulatory Commission (NRC) by the Idaho National Engineering and Environmental Laboratory (INEEL). The database contains CCF-related events that have occurred in U.S. commercial nuclear power plants reported in licensee event reports (LERs) and reports to the Nuclear Plant Reliability Data System (NPRDS) and the Equipment Performance Information Exchange (EPIX) system maintained by the Institute for Nuclear Power Operations (INPO)

The information presented in this report is intended to help focus NRC inspections on the more risk-important aspects of pump CCF events. Utilities can also use the information to help focus maintenance and test programs such that pump CCF events are minimized.

1.1 Background

The following four criteria must be met for an event to be classified as resulting from a common-cause:

- Two or more individual components must fail or be degraded, including failures during demand, inservice testing, or from deficiencies that would have resulted in a failure if a demand signal had been received;
- Two or more individual components must fail or be degraded in a select period of time such that the probabilistic risk assessment (PRA) mission would not be certain;
- The component failures or degradations must result from a single shared cause and coupling mechanism; and
- The component failures are not due to the failure of equipment outside the established component boundary.

To help resolve NRC Generic Issue 145,¹ *Actions to Reduce Common-Cause Failures*, and to address deficiencies related to the availability and analysis of CCF data, the NRC and the INEEL developed a CCF database that codifies information on CCF-related events that have occurred in U.S. commercial nuclear power plants from 1980 to date. The data is derived from both licensee event reports (LERs) submitted to the NRC and equipment performance reports submitted to the INPO. Accompanying the development of the CCF database was the development of CCF analysis software for investigating the CCF aspect of system reliability analyses and related risk-informed applications.

The quantitative results of this CCF data collection effort are described in the four volumes of NUREG/CR-6268, *Common-Cause Failure Database and Analysis System*.^{2,3,4,5} Some quantitative insights about the data for use in PRA studies were also published in NUREG/CR-5497,⁶ *Common-Cause Failure Parameter Estimations*. Copies of the CCF database together with supporting technical documentation and the analysis software are available on CD-ROM from the NRC to aid in system reliability analyses and risk-informed applications.

The CCF event data collected, classified, and compiled in the CCF database provide a unique opportunity to go beyond just estimation of CCF frequencies but to also gain more engineering insights into how and why CCF events occur. The data classification employed in the database was designed with this broader objective in mind. The data captured includes plant type, system component, piece parts, failure causes, mechanisms of propagation of failure to multiple components, their functional and physical failure modes. Other important characteristics such as defenses that could have prevented the failures are also included.

Section 1.2 of Volume 3 of NUREG/CR-6268 (Reference 4) proposes methods for classifying common-cause failures using the concepts of causes, coupling factors, and defensive mechanisms. The methods suggest a causal picture of failure with an identification of a root cause, a means by which the cause is more likely to impact a number of components simultaneously (the coupling), and the failure of the defenses against such multiple failures. Utilizing these methods, the CCF data associated with pump systems were analyzed to provide a better understanding of pump CCFs. This report presents the results of this effort.

The data analyzed are derived from the CCF database. The coding and quality assurance (QA) process for entering data into the database is as follows: Each event is coded from an LER or an NPRDS or EPIX report by analysts at the INEEL. Each analyst has access to coding guidelines (NUREG/CR-6268), which provides specific direction to the analyst about what the required information means and how to enter the information into the database. Each analyst is knowledgeable about PRA and plant systems and operations. Each event is initially coded by one analyst and reviewed by another analyst with a comparable background. Any disagreement is resolved before coding of the event is considered completed. An additional review of the events is done by another person familiar with PRA and CCF concepts. An independent outside expert in CCF and PRA then reviews the coding. Any differences are resolved and the final coding changes made in the database. The data collection, analysis, independent review, and quality assurance process are described in more detail in NUREG/CR-6268, Volumes 1 and 3 (References 2 and 4).

1.2 Common-Cause Failure Event Concepts

CCFs can be thought of as resulting from the coexistence of two main factors: one that provides a susceptibility for components to fail or become unavailable due to a particular cause of failure and a coupling factor (or coupling mechanism) that creates the condition for multiple components to be affected by the same cause.

An example is a case where two relief valves fail-to-open at the required pressure due to set points being set too high. Because of personnel error (the proximate cause), each of the two valves fails due to an incorrect setpoint. What makes the two valves fail together, however, is a common calibration procedure and common maintenance personnel. These commonalities are the coupling factors of the failure event in this case.

Characterization of CCF events in terms of these key elements provides an effective means of performing engineering assessments of the CCF phenomenon including approaches to identification of plant vulnerabilities to CCFs and evaluation of the need for, and effectiveness of, defenses against them. It is equally effective in evaluation and classification of operational data and quantitative analysis of CCF frequencies.

It is evident that each component fails because of its susceptibility to the conditions created by the root cause, and the role of the coupling factor is to make those conditions common to several components. In analyzing failure events, the description of a failure in terms of the most obvious "cause" is often too

simplistic. The sequence of events that constitute a particular failure mechanism is not necessarily simple. Many different paths by which this ultimate reason for failure could be reached exist. This chain can be characterized by two useful concepts— proximate cause and root cause.

The proximate cause of a failure event is the condition that is readily identifiable as leading to the failure. The proximate cause can be regarded as a symptom of the failure cause, and it does not in itself necessarily provide a full understanding of what led to that condition. As such, it may not be the most useful characterization of failure events for the purposes of identifying appropriate corrective actions. The proximate cause classification consists of six major categories:

- Design, construction, installation, and manufacture inadequacy causes,
- Operational and human-related causes (e.g. procedural errors, maintenance errors),
- Internal to the component, including hardware-related causes and internal environmental causes,
- External environmental causes,
- State of other component, and
- Other causes.

The causal chain can be long and, without applying a criterion identifying an event in the chain as a “root cause,” is often arbitrary. Identifying root causes in relation to the implementation of defenses is a useful alternative. The root cause is therefore the most basic reason or reasons for the component failure, which if corrected, would prevent recurrence. Volume 3 of NUREG/CR-6268 (Reference 4) contains additional details on the cause categories and how CCF event causes are classified.

The coupling factor is a characteristic of a group of components or piece parts that identifies them as susceptible to the same causal mechanisms of failure – it is a characteristic that links the components. Such factors include similarity in design, location, environment, mission, and operational, maintenance, and test procedures. Coupling factors are categorized into the following five groups for analysis purposes:

- Hardware Quality,
- Hardware Design,
- Maintenance,
- Operations, and
- Environment.

Note that proximate causes of CCF events are no different from the proximate causes of single component failures.

The proximate causes and the coupling factors may appear to overlap because the same name is sometimes used as a proximate cause and as a coupling factor (e.g., design, maintenance). However, they are different. For example, maintenance, as a proximate cause, refers to errors and mistakes made during maintenance activities. As a coupling factor, maintenance refers to the similarity of maintenance among the components (e.g., same maintenance personnel, same maintenance procedures).

The defense or defensive mechanism is any operational, maintenance, or design measure taken to diminish the probability and/or consequences of a common-cause failure event. Three ways of defending against a CCF event are the following: (1) defend against the failure proximate cause, (2) defend against

the coupling factor, or (3) defend against both the proximate cause and the coupling factor. As an example, consider two redundant components in the same room as a steam line. A barrier that separates the steam line from the components is an example of defending against the proximate cause. A barrier that separates the two components is an example of defending against the coupling factor (same location). Installing barriers around each component is an example of defending against both the cause and the coupling factor.

Proximate causes of CCF events are no different from the proximate causes of single component failures. This observation suggests that defending against single component failures can have an impact on CCFs as well. Most corrective actions usually attempt to reduce the frequency of failures (single or multiple). That is, very often the approach to defending against CCFs is to defend against the cause, not the coupling. Given that a defensive strategy is established based on reducing the number of failures by addressing proximate causes, it is reasonable to postulate that if fewer component failures occur, fewer CCF events would occur.

Defenses against causes result in improving the reliability of each component but do not necessarily reduce the fraction of failures that occur due to common-cause. They typically include design control, use of qualified equipment, testing and preventive maintenance programs, procedure review, personnel training, quality control, redundancy, diversity, and barriers. It is important to remember that the susceptibility of a system of redundant components to dependent failures as opposed to independent failures is determined by the presence of coupling factors.

The above cause-defense approach does not address the way that failures are coupled. Therefore, CCF events can occur, but at a lower probability. If a defensive strategy is developed using protection against a coupling factor as a basis, the relationship among the failures is eliminated. A search for coupling factors is primarily a search for similarities among components. A search for defenses against coupling, on the other hand, is primarily a search for dissimilarities among components, including differences in the components themselves (diversity); differences in the way they are installed, operated, and maintained; and in their environment and location.

During a CCF analysis, a defense based on a coupling factor is easier to assess because the coupling mechanism among failures is more readily apparent and therefore easier to interrupt. The following defenses are oriented toward eliminating or reducing the coupling among failures: diversity, physical or functional barriers, and testing and maintenance policies. A defensive strategy based on addressing both the proximate cause and coupling factor would be the most comprehensive.

A comprehensive review should include identification of the root causes, coupling factors, and defenses in place against them. However, as discussed in NUREG/CR-5460,⁷ *A Cause-Defense Approach to the Understanding and Analysis of Common-Cause Failures*, given the rarity of common-cause events, current weaknesses of event reporting and other practical limitations, approaching the problem from the point of view of defenses is, perhaps, the most effective and practical. A good defense can prevent a whole class of CCFs for many types of components, and in this way, the application of a procedure based on this philosophy can provide a systematic approach to screening for potential CCF mechanisms.

1.3 Report Structure

This report presents an overview of the pump CCF data and insights into the characteristics of that data. This report is organized as follows: Section 2 presents a description of the pump, a short description of the associated segments, and a definition of the pump failure modes. High-level insights of all the pump CCF data are presented in Section 3. Section 4 summarizes the events by segment. Section

5 presents pump CCF insights by selected systems. Section 6 explains how to obtain more detailed information for the pump events. A glossary of terms used in this report is included in the front matter. Appendix A contains three listings of the pump CCF events sorted by proximate cause, coupling factor, and discovery method. Appendix B contains a listing of the pump CCF events sorted by the sub-component. Appendix C contains a listing of the pump CCF events sorted by the system.

2. PUMP COMPONENT DESCRIPTION

2.1 Introduction

Pumps are used in many safety-related systems at commercial nuclear utilities. Pumps are installed in redundant configurations to ensure the movement of water under accident conditions. Pumps provide water to makeup for the loss of inventory, loss of pressure, cooling, and the addition of chemical poisons. Many of these systems use the pumps in more than one mode of operation.

The pumps in this study are normally in standby, except for the emergency service water pumps and the chemical and volume control system pumps include in the HPI system. The systems containing pumps included in this insights study include:

- AFW Auxiliary Feedwater System (PWR)
- CSR Containment Spray Recirculation (PWR)
- ESW Emergency Service Water
- HCI High Pressure Coolant Injection (BWR)
- HPI High Pressure Safety Injection (PWR)
- RHR-B Residual Heat Removal (BWR)
- LCS Low Pressure Core Spray (BWR)
- RHR-P Residual Heat Removal (PWR)
- RCI Reactor Core Isolation Cooling (BWR)
- SDC Shutdown Cooling (BWR)
- SLC Standby Liquid Control (BWR)

2.2 Risk Significance

The emergency core cooling system (ECCS) is designed to supply sufficient water to the reactor vessel and reactor coolant system (RCS) to keep the core covered and to remove decay heat in the event of a loss of coolant inventory or normal core cooling. Thus, the ECCS systems play significantly in transients with a loss of secondary cooling (including loss of off-site power and station blackout), and loss of coolant accidents (LOCAs).⁸ In general, the motor-driven and turbine-driven pumps are the most risk-important component and common-cause failures of the pumps are routinely the dominant risk contributors for the ECCS systems.

The auxiliary feedwater system (AFW) in PWRs provides a means of removing decay heat using the secondary system when the normal feedwater system is not available. The most common demands for AFW are transients with loss of secondary heat removal and loss of off-site power (including station blackout), two prominent risk contributors in PWRs. Individually, the system pumps are risk significant. Although most AFW systems employ diversity to combat common-cause failures (motor-driven and turbine-driven pumps), such failures are still significant.⁹

2.3 Component Description and Boundary

The pumps in the systems listed above have varying characteristics such as discharge pressure, flow rate, number of stages, suction type, discharge point, and control systems. However, all pumps have a set of similar characteristics that are of interest when examining failures. Therefore, we define the pump component as the combination of the suction source, the driver, the pump, and the discharge. In

this study, we will look at the segments as well as the overall pump component. Figure 2-1 shows the component boundary as defined for this study.

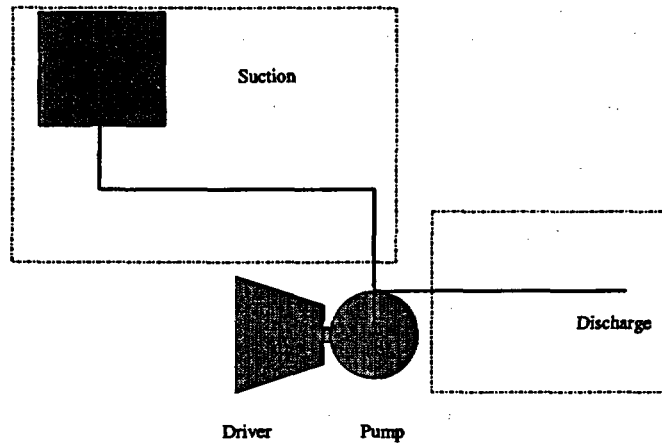

Figure 2-1. Pump component boundary drawing.

2.4 Segment Description

This section contains a brief description of each of the segments that comprise the pump. These descriptions are intended only to provide a general overview of the most common pumps. Failure of the pump due to external components (e.g., MOVs, check valves, and strainers) required that the components were not failed, but inhibited the pump. Otherwise, these types of components would have been classified as a failure of the specific component.

2.4.1 Pump

The pump segment performs the function of converting rotational energy to fluid kinetic energy to move fluid from the suction to the discharge flow paths. Most of the pumps in this study are centrifugal type pumps. The SLC system and some of the coolant charging systems employ reciprocating positive displacement pumps. The pump may include the bearings, couplings, impeller/wear rings, shaft, packing/seals, casing, lubrication, supports, and the plungers and cylinders (positive displacement).

2.4.2 Driver

The driver segment performs the function of providing the motive force to the pump. Most pumps are motor-driven. The driver may include the circuit breaker, bearings, lubrication system, cooling system, rotor, gearbox (positive displacement and some turbine-driven pumps), instrumentation and controls, motor or turbine, and power cables.

2.4.3 Suction

The suction segment performs the function of supplying the fluid to the pump. The suction includes the supply tank or other water source; manual, power-operated, or check valves; strainers; and piping. Suction segment failures are evaluated to determine the effect on pump operability. Insufficient net positive suction head (NPSH) is generally the type of event that occurs in the suction path. Low levels in water source, high temperature in the suction source, or plugged strainers are typical examples.

2.4.4 Discharge

The discharge segment performs the function of directing fluid to the desired flow path. The discharge includes manual valves, power-operated valves, relief valves, check valves, the recirculation flow path, and piping. Discharge segment failures are evaluated to determine the effect on pump operability. The state of the valves in the discharge path, insufficient recirculation flow, pipe leaks, etc. are typical examples.

2.5 System Descriptions

Figure 2-2 to Figure 2-9 are shown to provide the reader with generic representations of the system configurations discussed within this document.

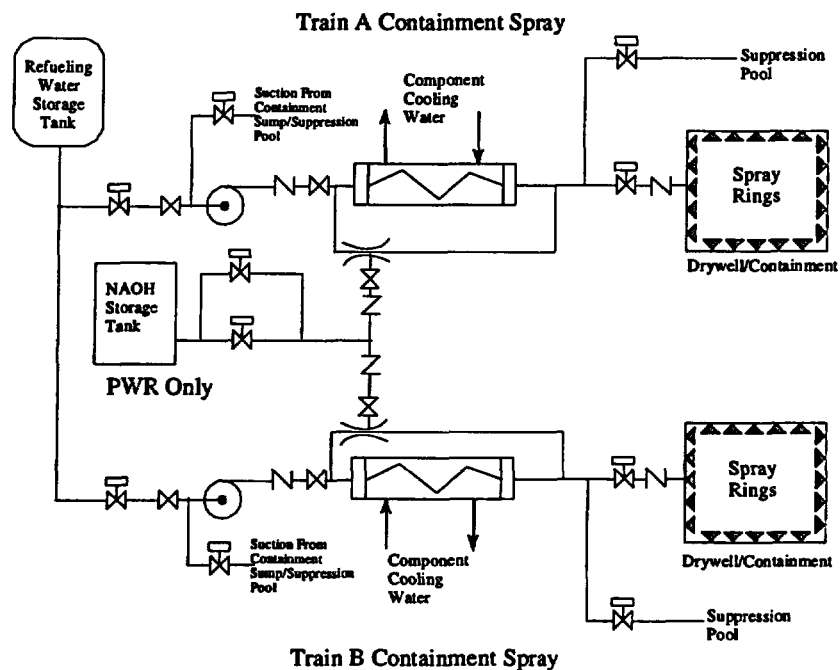

Figure 2-2. PWR Containment Spray system diagram.

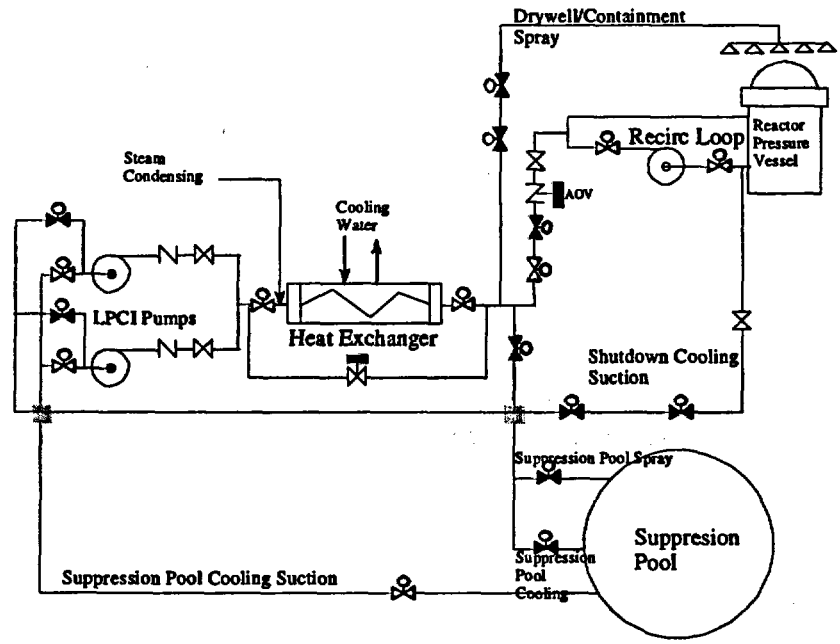

Figure 2-3. BWR RHR system diagram.

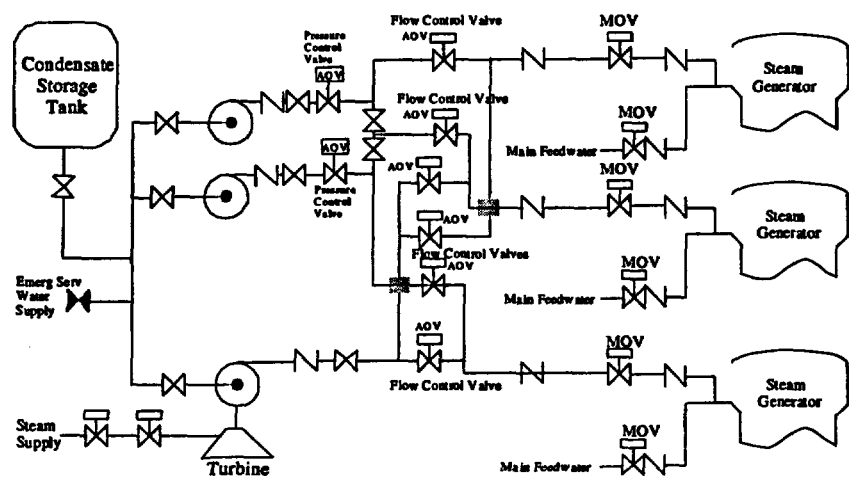

Figure 2-4. PWR Auxiliary Feedwater system diagram.

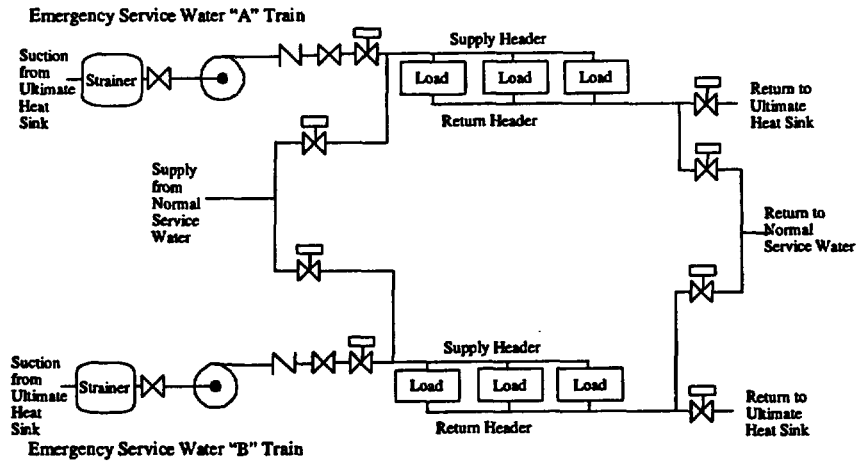

Figure 2-5. Generic Emergency Service Water system diagram.

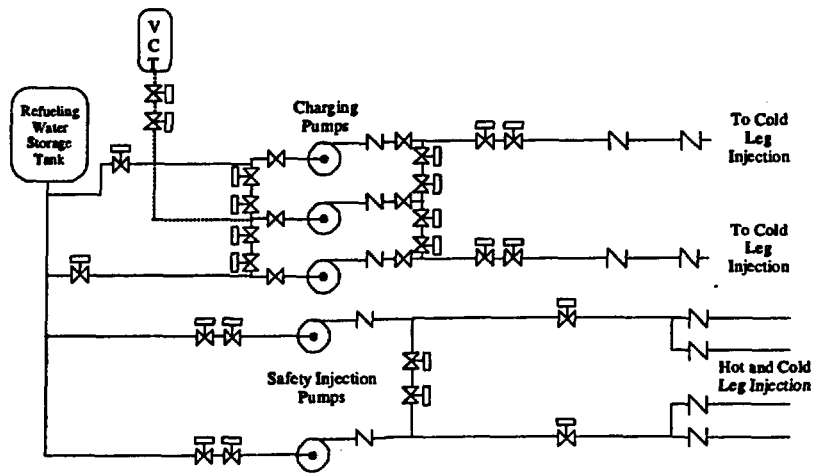

Figure 2-6. PWR High Pressure Safety Injection and Coolant Charging system diagram.

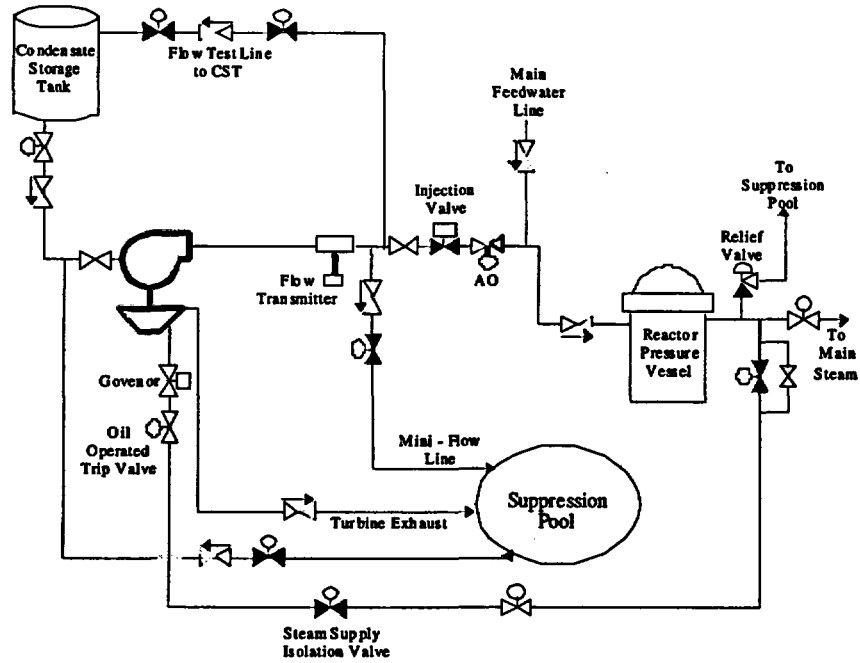

Figure 2-7. BWR High Pressure Coolant Injection and Reactor Core Isolation Cooling systems diagram.

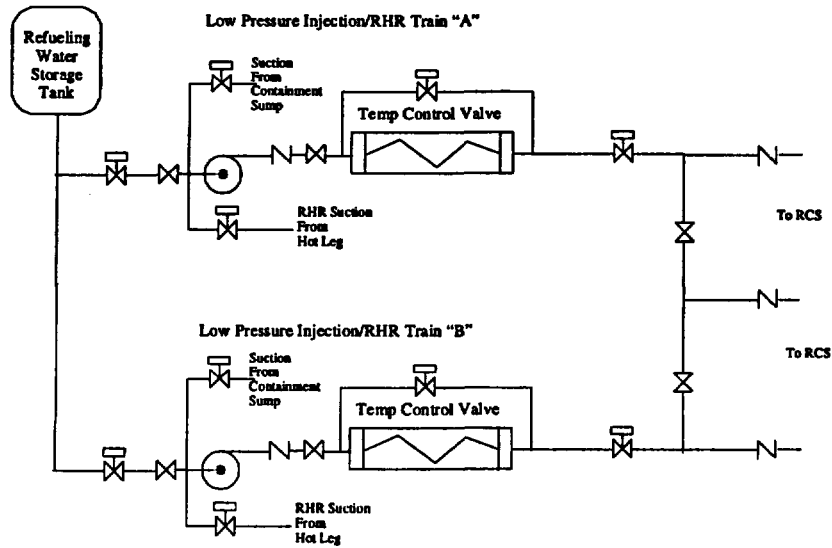

Figure 2-8. PWR RHR system diagram.

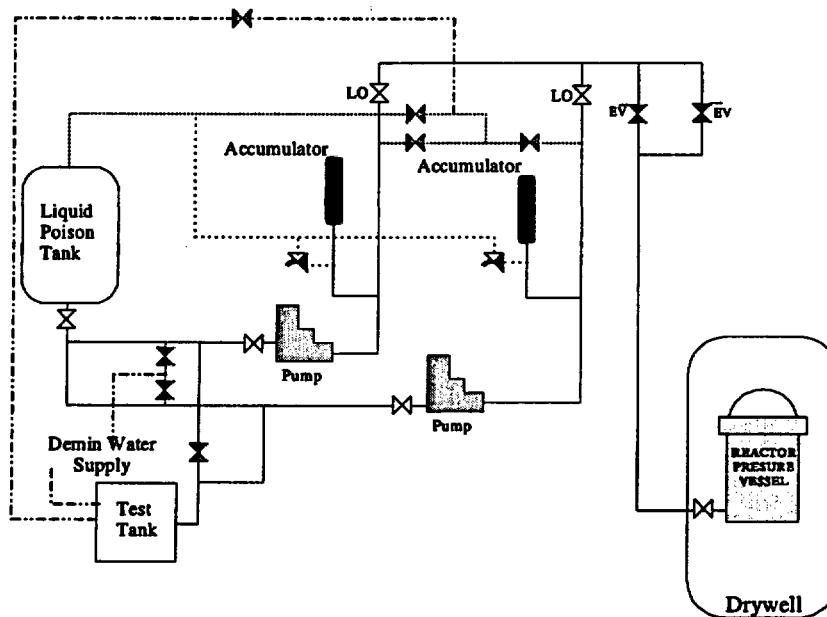

Figure 2-9. BWR Standby Liquid Control system diagram.

2.6 Failure Modes

Successful operation of a pump is defined for two distinct modes of operation. If the system is in the normal standby condition, it must respond to an actuation signal by starting, which consists of obtaining design discharge pressure and flow. Once running, the pump must continue to produce design flow and discharge pressure until its service is no longer needed. Failures that occurred during testing are included with the failures that occurred during plant transients requiring operation of the pumps. The respective failure modes used for evaluating the pump data are:

- Fail-to-start (FTS)** A successful pump start is defined as the start of the pump up to the point where design flow (or minimum flow) and discharge pressure are achieved.
- Fail-to-run (FTR)** A successful pump run is defined, as the continuation of full flow and discharge pressure for the time the pump is needed. In the cases where some degradation of the pump is observed, a determination is made as to the ability of the pump to perform throughout its PRA mission time (typically 24 hours).

Pump segment failures are evaluated to determine the effect on pump operability. Pump failures include those failures that are caused by pump internals such as the impeller/wearing rings, bearings, lubrication, packing, etc.

Driver segment failures are evaluated to determine the effect on pump operability. Failures of the sensors or control circuitry to provide input in other systems (e.g., interlocks or indication) are not considered pump failures.

Suction segment failures are evaluated to determine the effect on pump operability. Insufficient net positive suction head (NPSH) is generally the type of event that occurs in the suction path. Low levels in water source, high temperature in the suction source, or plugged strainers are typical examples.

Discharge segment failures are evaluated to determine the effect on pump operability. The state of the valves in the discharge path, insufficient recirculation flow, and pipe leaks are typical examples.

Failure of the pump due to external components (e.g., MOVs, check valves, and strainers) required that the components were not failed, but inhibited the pump. Otherwise, these types of components would have been classified as a failure of the specific component.

3. HIGH LEVEL OVERVIEW OF PUMP INSIGHTS

3.1 Introduction

This section provides an overview of CCF data for the pump component that has been collected from the NRC CCF database. The set of pump CCF events is based on industry data from 1980 to 2000. The pump CCF data contains attributes about events that are of interest in the understanding of: degree of completeness, trends, pump segment affected, causal factors, linking or coupling factors, and event detection methods.

Not all pump CCF events included in this study resulted in observed failures of multiple pumps. Many of the events included in the database, in fact, describe degraded states of the pumps where, given the conditions described, the pumps may or may not have performed as required. The CCF guidance documents (References 3 and 4) allow the use of three different quantification parameters (component degradation value, shared cause factor, and timing factor) to measure degree of failure for CCF events. Based on the values of these three parameters, a Degree of Failure was assigned to each pump CCF event.

The Degree of Failure category has three groups—Complete, Almost Complete, and Partial. Complete CCF events are CCF events in which each component within the common-cause failure component group (CCCG) fails completely due to the same cause and within a short time interval (i.e., all quantification parameters equal 1.0). Complete events are important since they show us evidence of observed CCFs of all components in a common-cause group. Complete events also dominate the parameter estimates obtained from the CCF database. All other events are termed partial CCF events (i.e., at least one quantification parameter is not equal to 1.0). A subclass of partial CCF events are those that are Almost Complete CCF events. Examples of events that would be termed Almost Complete are: events in which most components are completely failed and one component is degraded, or all components are completely failed but the time between failures is greater than one inspection interval (i.e., all but one of the quantification parameters equal 1.0).

Table 3-1 summarizes, by failure mode and degree of failure, the pump CCF events contained in this study. The majority of the pump CCF events were fail-to-run (54 percent), suggesting that often the pump must be running at rated conditions for failures to develop and/or for those failures to be detected. While most events (68 percent) were classified as Partial, a significant fraction of events (32 percent) were classified as either Complete or Almost Complete.

Table 3-1. Summary statistics of pump data.

Failure Mode	Degree of Failure			Total
	Partial	Almost Complete	Complete	
Fail-to-Start (FTS)	86	12	27	125
Fail-to-Run (FTR)	101	13	35	149
Total	187	25	62	274

3.2 CCF Trends Overview

Figure 3-1 shows the yearly occurrence rate, the fitted trend, and its 90 percent uncertainty bounds for all pump CCF events over the time span of this study. The decreasing trend is statistically significant^a with a p-value^b of 0.0001. There was insufficient information to determine what caused the decreasing trend in CCF events, but there were several regulatory initiatives by the NRC and industry initiatives by utilities, INPO, and EPRI involving improved operation, maintenance, testing, and inspection during the 21 years of improving performance. Examples of these initiatives include improvements in testing, inspection, and maintenance associated with Generic Letter 89-13, *Problems with Service Water Systems Affecting Safety-Related Components*¹⁰, and Generic Letter 89-04, *Guidance on Developing Acceptable Inservice Testing Programs*¹¹. Additionally, the testing and examination code for pumps has been improved significantly since 1980.

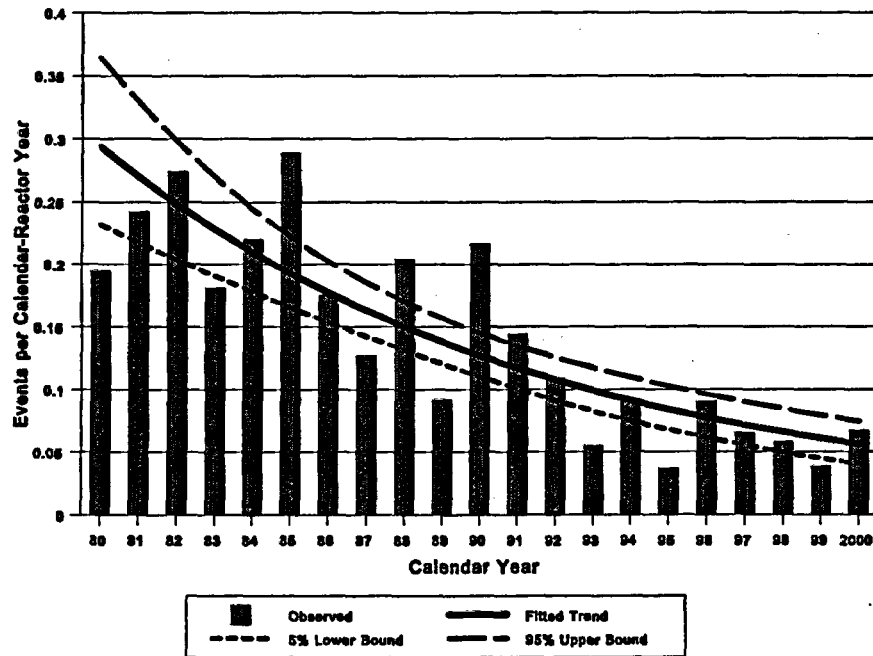

Figure 3-1. Trend for all pump CCF events. The decreasing trend is statistically significant with a p-value = 0.0001.

Figure 3-2 through Figure 3-4 show trends for subsets of the pump CCF events contained in Figure 3-1. Figure 3-2 shows the trend for Complete pump CCF events. The overall trend for Complete pump CCF events from 1980 to 2000 is also statistically significant with a p-value of 0.0001. This indicates a dramatic decrease of Complete pump CCF events, especially since the mid-1980's. Figure 3-3

a. The term "statistically significant" means that the data are too closely correlated to be attributed to chances and consequently have a systematic relationship. A p-value of less than 0.05 is generally considered to be statistically significant.

b. A p-value is a probability, with a value between zero and one, which is a measure of statistical significance. The smaller the p-value, the greater the significance. A p-value of less than 0.05 is generally considered statistically significant. A p-value of less than 0.0001 is reported as 0.0001.

and Figure 3-4 show similar statistically significant decreasing trends for both the fail-to-start and the fail-to-run failure modes for all pump CCF events, both with p-values of 0.0001.

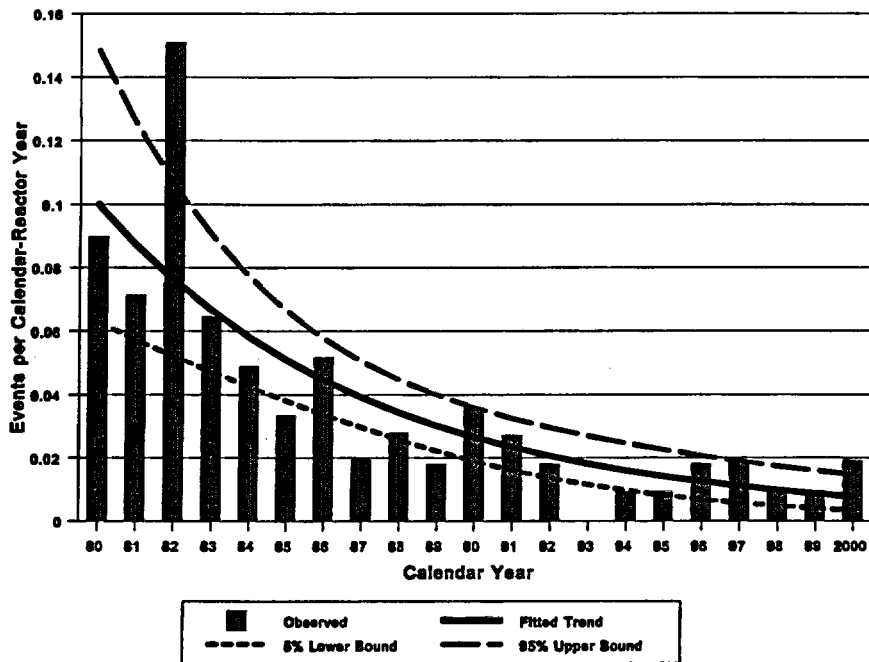

Figure 3-2. Trend for Complete pump CCF events. The decreasing trend is statistically significant with a p-value = 0.0001.

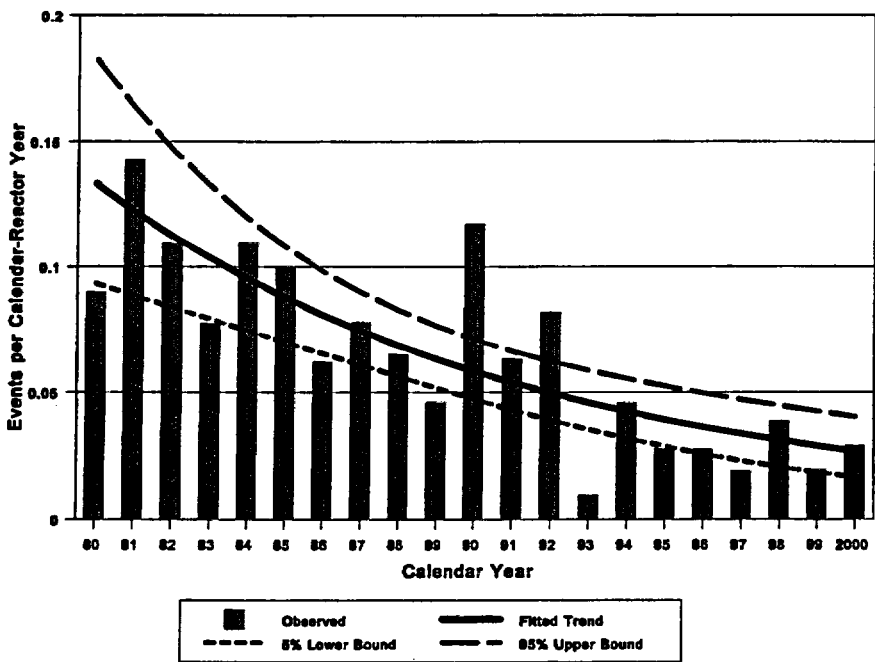

Figure 3-3. Trend for all pump CCF events for the fail-to-start failure mode. The decreasing trend is statistically significant with a p-value = 0.0001

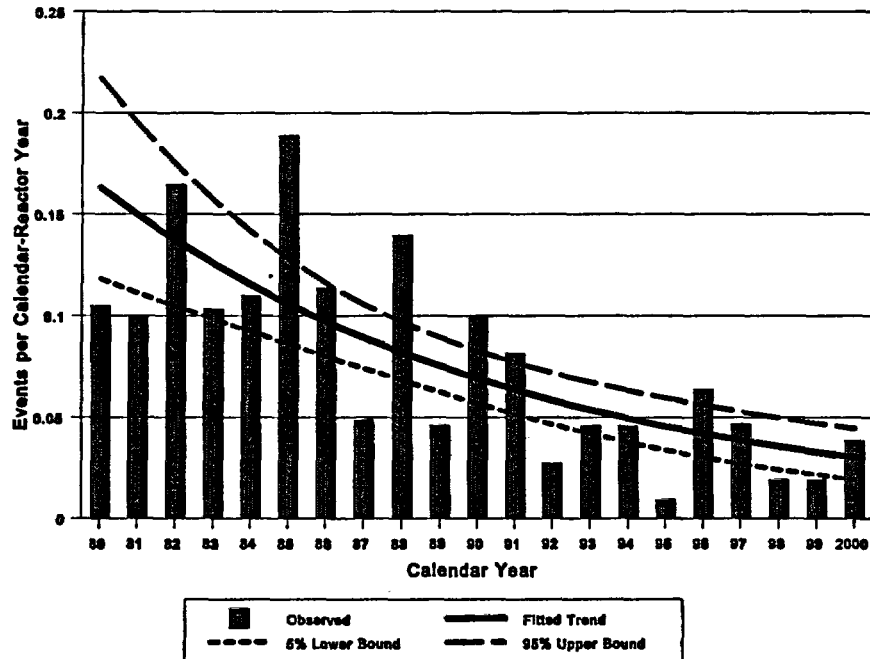

Figure 3-4. Trend for all pump CCF events for the fail-to-run failure mode. The decreasing trend is statistically significant with a p-value = 0.0001.

3.3 CCF Segment Overview

Pumps are complex machines and can easily be thought of as a collection of segments, each with many components. The pump CCF data were reviewed to determine the affected segment and the affected piece part in that segment. This was done to provide insights to the most vulnerable areas of the pump component to common-cause failure events. Section 2.4 describes these segments.

Figure 3-5 shows the distribution of the CCF events by pump segment. Overall, for all pumps, the highest number of events occurred in the pump segment (106 events or 39 percent). The driver and suction segments were also significant contributors (32 and 24 percent, respectively), while relatively few events involved the discharge segment. These statistics vary by system. For the ESW and SLC systems, most of the failures occurred in the pump segment. However, for the AFW, HPI, and RHR-B systems, most of the failures occurred in the driver segment, and for the RHR-P system, most of the failures occurred in the suction segment. Events involving the driver and suction segments were more likely to be Complete. Ninety-two percent of all Complete events occurred in these two segments. Section 4 of this report provides an in-depth analysis of the CCF events assigned to these segments.

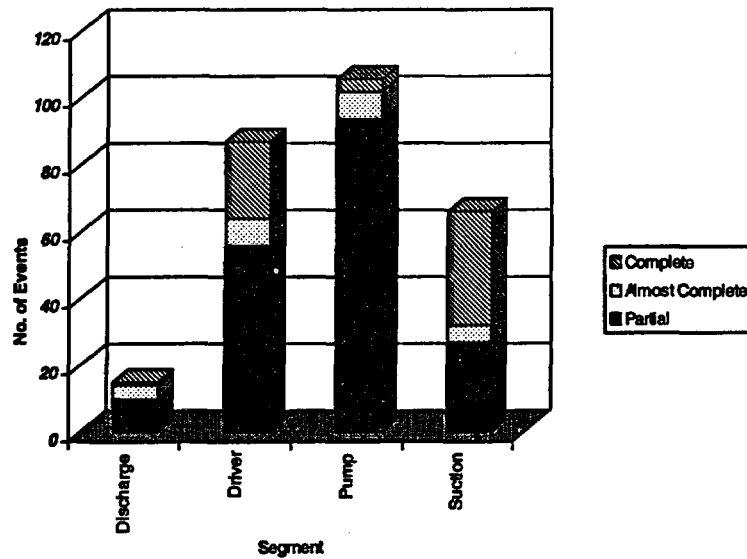

Figure 3-5. Segment distribution for all pump CCF events.

3.4 CCF Proximate Cause

It is evident that each component fails because of its susceptibility to the conditions created by the root cause, and the role of the coupling factor is to make those conditions common to several components. In analyzing failure events, the description of a failure in terms of the most obvious "cause" is often too simplistic. The sequence of events that constitute a particular failure mechanism is not necessarily simple. Many different paths by which this ultimate reason for failure could be reached exist. This chain can be characterized by two useful concepts— proximate cause and root cause.

A **proximate cause** of a failure event is the condition that is readily identifiable as leading to the failure. The proximate cause can be regarded as a symptom of the failure cause, and it does not in itself necessarily provide a full understanding of what led to that condition. As such, it may not be the most useful characterization of failure events for the purposes of identifying appropriate corrective actions.

The proximate cause classification consists of six major groups or classes:

- Design/Construction/Installation/Manufacture Inadequacy
- Operational/Human Error
- Internal to the component, including hardware-related causes and internal environmental causes
- External environmental causes
- Other causes
- Unknown causes.

The causal chain can be long and, without applying a criterion identifying an event in the chain as a "root cause," is often arbitrary. Identifying proximate causes in relation to the implementation of

defenses is a useful alternative. The proximate cause is therefore the most basic reason or reasons for the component failure, which if corrected, would prevent recurrence. (See Table 4-2 in Section 4.1 for a display of the major proximate cause categories and a short description.) Reference 4 contains additional details on the proximate cause categories, and how CCF event proximate causes are classified.

Figure 3-6 shows the distribution of CCF events by proximate cause. The leading proximate cause was Internal to Component, which accounted for about 39 percent of the total events; however, none of these events were Complete. Design/Construction/Installation/Manufacture Inadequacy and Human error accounted for 24 and 20 percent of the total events, respectively. The Other and External Environment proximate causes were attributed to a small fraction of the pump CCF events.

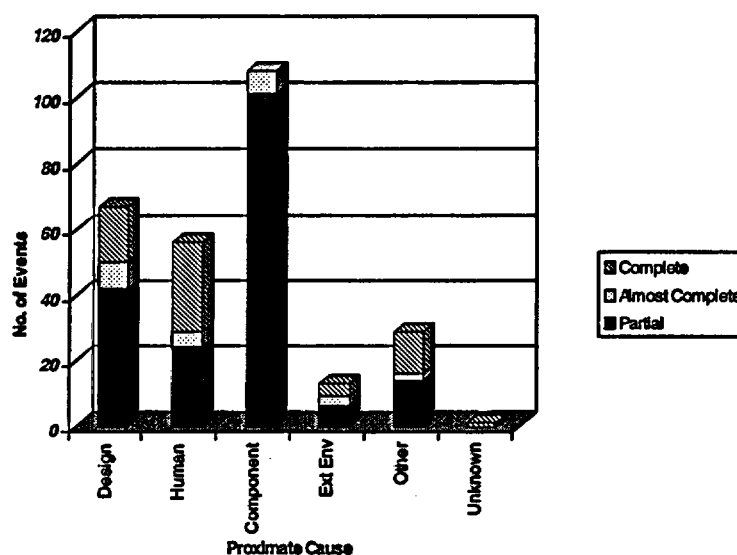

Figure 3-6. Proximate cause distribution for all pump CCF events.

Table A-1 in Appendix A presents the entire pump data set, sorted by the proximate cause. This table can be referred to when reading the following discussions to see individual events described.

The **Internal to Component** proximate cause category is dominant for pump events and involves the failure or malfunction of parts internal to the pump. Internal causes result from phenomena such as normal wear or other intrinsic failure mechanisms that are influenced by the ambient environment of the component. Specific mechanisms include erosion, corrosion, internal contamination, fatigue, wear-out, and end of life. Internal to Component failures resulted in 108 events. Of these, 61 events were classified as fail-to-run and 47 were fail-to-start. Although this is the dominant proximate cause group, there were no Complete failure events attributed to the Internal to Component proximate cause. This is because most failure mechanisms in this group are gradual in nature; infrequently causing all system components to fail at once. In addition, the lack of a large number of Complete events may be due to the method of discovery. The majority of events in this cause group were discovered by Testing. These data suggest that the testing programs are succeeding in finding and fixing gradual failures of pumps before full failure is observed.

The **Design/Construction/Installation/Manufacture Inadequacy** proximate cause category is the next most likely for pump events and encompasses events related to the design, construction,

installation, and manufacture of components, both before and after the plant is operational. Included in this category are events resulting from errors in equipment and system specifications, material specifications, and calculations. Events related to maintenance activities are not included. Design/Construction/Installation/Manufacture Inadequacy errors resulted in 67 events. The failure mode for 42 of these events was fail-to-run, and 25 events had fail-to-start as the failure mode. There were 17 Complete CCF events in this proximate cause group: 13 Complete events were fail-to-run and 4 were fail-to-start. The majority of these Complete events (11 out of 17) occurred in the Suction segment. Typically, these events were due to a lack of adequate NPSH due to design discrepancies. Instead of the loss of suction events being distributed over a large number of NPP units, two stations account for approximately 65 percent of the Suction segment CCF events with the Design, Construction, and Manufacturer proximate. The rest of the CCF events were relatively evenly distributed between the Driver segment and the Pump segment.

The Operational/Human Error proximate cause category is also likely for pump CCF events. This proximate cause category represents causes related to errors of omission or commission on the part of plant staff or contractor staff. Included in this category are accidental actions, failures to follow the correct procedures or following inadequate procedures for construction, modification, operation, maintenance, calibration, and testing. This proximate cause group may also include deficient training. Operational/Human Error was assigned to 56 pump CCF events. The majority of these events involved inadequate procedures and accidental action. The failure mode for 24 events was fail-to-run and 32 events had fail-to-start as the failure mode. Almost half (48 percent) of the pump CCF events in this cause category were Complete. This highlights the importance of maintenance and operations in the availability of the pump component. The majority of CCF events were discovered by either Demand or Inspection. The high number of events discovered by Demand is explained by the fact that human errors are prone to occur during operations involving system demands. In addition, maintenance personnel errors also show up when the system is called upon to function. However, for those events not discovered by system demands, Inspection discovered more events than Maintenance and Testing. Many of these events involved problems such as system misalignments, improper circuit breaker operations, Technical Specification violations (non-allowed combinations of systems/components out of service at the same time) that were discovered by plant operators. It is expected that routine Inspection would discover more of these events than Testing and Maintenance, which are conducted only periodically.

The Other proximate cause category is comprised of events that were caused by instrumentation and control circuit setpoint drift or failure components outside the defined pump component boundary. There were 29 events assigned to this cause category. The failure mode for 13 events was fail-to-run and 16 events had fail-to-start as the failure mode. Again, almost half (45 percent) of the pump CCF events in this cause category were Complete. The most common Complete events in this category involved an interlock dependent on either a temperature or pressure sensor that prevented pump start or an actual low level in the suction source. Therefore, this cause category is important although the total number of events was relatively small. Most of the events were discovered by Demand in lieu of Testing, Maintenance, and Inspection. This is expected due to the nature of CCF events in this proximate cause group. The dependencies outside the pump component that initiate these CCF events may not be the specific target of system component testing; therefore, it is reasonable that more events would be discovered during system operation than by less-frequent test surveillance. In addition, because CCF events that occur due to the state of other components typically are indirectly initiated by failure of other components, they may not be readily apparent during routine inspections and maintenance. Fourteen events (48 percent) affected the Driver segment. This is reasonable to expect because the pump Drivers are dependent on a large number of other components, such as circuit breakers, instruments, interlocks and controls. The other important segment is Suction, with 11 events. This is a reflection of the number of events in the RHR-P system related to loss of suction due to system configuration.

The **External Environment proximate cause category** represents causes related to a harsh environment that are not within the component design specifications. Specific mechanisms include chemical reactions, electromagnetic interference, fire or smoke, impact loads, moisture (sprays, floods, etc.), radiation, abnormally high or low temperature, vibration load, and acts of nature (high wind, snow, etc.). There were 13 pump CCF events in this cause category. The failure mode for eight events was fail-to-run, and five events had fail-to-start as the failure mode. There were four Complete CCF events in attributed to External Environment.

The **Unknown proximate cause category** is used when the cause of the component state cannot be identified. There was one Complete, fail-to-run event in this cause category that occurred in the Suction segment.

3.5 CCF Coupling Factor

Closely connected to the proximate cause is the concept of **coupling factor**. A coupling factor is a characteristic of a component group or piece parts that links them together so that they are more susceptible to the same causal mechanisms of failure. Such factors include similarity in design, location, environment, mission, and operational, maintenance, design, manufacturer, and test procedures. These factors have also been referred to as examples of coupling mechanisms, but because they really identify a potential for common susceptibility, it is preferable to think of these factors as characteristics of a common-cause component group. Reference 4 contains additional detail about the coupling factors.

The coupling factor classification consists of five major classes:

- Hardware Quality based coupling factors,
- Design-based coupling factors,
- Maintenance coupling factors,
- Operational coupling factors, and
- Environmental coupling factors.

Figure 3-7 shows the coupling factor distribution for the pump CCF events. Maintenance was the leading coupling factor with 111 events (40 percent). The next leading coupling factor was Design with 76 events (28 percent). While not the leading coupling factor, over half (51 percent) of the Design, coupled events were either Complete or Almost Complete. The Environmental and Operational coupling factors account for the majority of the remaining events (44 and 28 events, respectively). Only a small fraction of the events coupled by Environmental were Complete; however, over half (57 percent) of the events coupled by Operational were Complete. These Complete events were almost all coupled by inadequate operations procedures. Only 15 events were coupled by Quality, and three of these were Complete and affected the Driver segment.

Table A-2 in Appendix A presents the entire pump data set, sorted by the coupling factor. This table can be referred to when reading the following discussions to see individual events described.

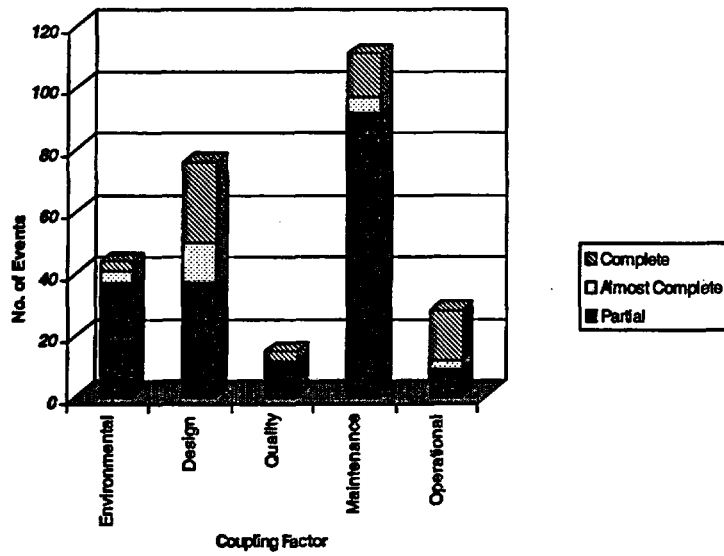

Figure 3-7. Coupling factor distribution for all pump CCF events.

The Maintenance coupling factor indicates that the maintenance frequency, procedures, or personnel provided the linkage among the events. Most of the pump CCF events with this coupling factor were coupled by maintenance/test schedules (74 out of 111) and maintenance/test procedures (23 out of 111). Internal to Component was the most prevalent proximate cause to be linked by maintenance (75 events). The maintenance linkage to the component failure proximate cause usually indicated that maintenance that is more frequent could have prevented the CCF mechanism. Very few of these events actually resulted in Complete CCF events, and most were detected as incipient failures. Examples of these are:

- The circuit breakers associated with the Auxiliary Feedwater Pumps failed to close as required. The cause of the failure was the binding in the operating mechanism due to accumulated dirt and lack of lubrication.
- The AFW pumps failed to start due to steam binding. The cause of the steam binding was determined to be leakage past the downstream AFW system check valves.
- Two of three ESW pumps failed to start on demand. The cause was determined to be bad couplings between the pumps and drivers. The cause was determined to be lack of periodic maintenance and inspection.
- The two gland seal retaining bolts inside the centrifugal charging pump speed increaser lube oil pump were found to be backed out allowing the gland seal to loosen. This resulted in reduced oil flow to the speed increaser causing significant damage. Other centrifugal charging pumps (CCPs) were inspected, and the same gland seal bolts as on the first pump were found loosened. The cause of the bolts backing out was determined to be lack of a periodic adjustment of the gland seal bolts.

The **Design** coupling factor indicates that the failures were linked by the components having the same design and component parts or by the system configuration. **Design/Construction/Installation/Manufacture** was the most prevalent proximate cause to be linked by Design (45 events). This means that design errors and inadequacies were both the cause and the link between the events. Examples of these events are:

- A modification design error removed a start permissive interlock contact. This flaw de-energized the auxiliary lube oil pump; consequently, when one AFW pump was started it ran for 2.5 seconds and tripped on low oil pressure. Further investigation showed that both units AFW pumps would be affected in the same way.
- Both RHR-P pumps failed to run due to high bearing temperatures caused by inadequate bearing clearances and using the wrong lubricating oil, which had too high a viscosity. Inadequate vendor design information resulted in the higher viscosity oil being used.
- During the performance of a special test to determine the available net positive suction head of the SLC Pumps, the pumps began to cavitate unexpectedly. The causes of this event were determined to be inadequate modification testing and errors in the original design calculations.
- During a unit load shed test, the service water pumps lost suction and tripped. The loss of suction pressure was caused by a loss of prime in the condenser circulating water siphon flow system. The event was attributed to poor system design.

The **Environmental** coupling factor propagates a failure mechanism via identical external or internal environmental characteristics. **Internal to Component** was the most prevalent proximate cause to be linked by Environmental (29 events). Examples of these events are:

- Failure of the HPI Pumps due to clam and sludge fouling of the pump lube oil coolers.
- A CCP seized during surveillance testing. Subsequent inspection revealed resin particles and metal shavings in the pump casings and suction lines for all the charging pumps.

The **Operational** based coupling factor links the CCF events via inadequate operations procedures and operations staff errors. **Human Error** was the dominant proximate cause for events linked by Operational factors (25 events). Examples of these events are:

- HPI pumps not restored to service before a mode change as required by Technical Specifications due to a procedural inadequacy.
- The CCPs were erroneously placed in pull-to-lock when required to operable.
- During a routine Control Board walk-down it was discovered that the AFW pump discharge MOVs were closed. Subsequent investigation revealed the AFW system had not been previously placed in standby readiness per the operating procedure after the system was secured.

The **Quality** based coupling factor propagates a failure mechanism among several components by manufacturing and installation errors. **Design** was the dominant proximate cause for events linked by Quality based coupling factors (12 events). Examples of these events are:

- During surveillance testing, neither motor-driven AFW pump would start. The pump control circuit was found with auto-start defeat switches labeled backwards, causing all auto-starts except

the low-low steam generator level to be defeated. This was an original installation error resulting from an inadequate design change process.

- Both motor-driven AFW pumps failed to start when the operator tried to start them manually. While preparing a design change, the designer failed to review all the unit specific documentation associated with the motor-driven AFW pump wiring and made the erroneous assumption that both units switchgear compartment internal wiring was identical. In fact, the wiring for each unit was different. Consequently, when the design change was installed, it was installed in accordance with the erroneous design.

3.6 CCF Discovery Method Overview

An important facet of these CCF events is the way in which the failures were discovered. Each CCF event was reviewed and categorized into one of four discovery categories: Test, Maintenance, Demand, or Inspection. These categories are defined as:

Test	The equipment failure was discovered either during the performance of a scheduled test or because of such a test. These tests are typically periodic surveillance tests, but may be any of the other tests performed at nuclear power plants, e.g., post-maintenance tests and special systems tests.
Maintenance	The equipment failure was discovered during maintenance activities. This typically occurs during preventative maintenance activities.
Demand	The equipment failure was discovered during a demand for the equipment. The demand can be in response to an automatic actuation of a safety system or during normal system operation.
Inspection	The equipment failure was discovered by personnel, typically during system tours or by operator observations.

Figure 3-8 shows the distribution of how the events were discovered or detected. Testing accounted for 95 events, (35 percent), 83 events (30 percent) were discovered during Demand, Inspection accounted for 69 events (25 percent), and 27 events (10 percent) were detected during Maintenance activities. Considering the extensive and frequent surveillance test requirements for pumps contained in Technical Specifications, it is expected that a majority of the pump CCF events would be detected by Testing. The intent of testing programs is to detect degradation and initiate corrective actions before total failure. The failures detected by testing tended to be Internal to Component causes attributed to wear and aging and only a small percentage of these failures resulted in Complete CCF events. It was expected that fewer failures would be detected by Demand. Analysis of events showed that over half of the events discovered by Demand were Complete or Almost Complete. The majority of events detected by Demand were attributed to design errors, human errors, and the Others. These causes were also dominant for all Complete CCF events. This implies that testing may be effective at detecting normal wear and aging problems, but less effective at detecting failures related to design and human errors.

Table A-3 in Appendix A presents the entire pump data set, sorted by the discovery method. This table can be referred to when reading the following discussions to see individual events described.

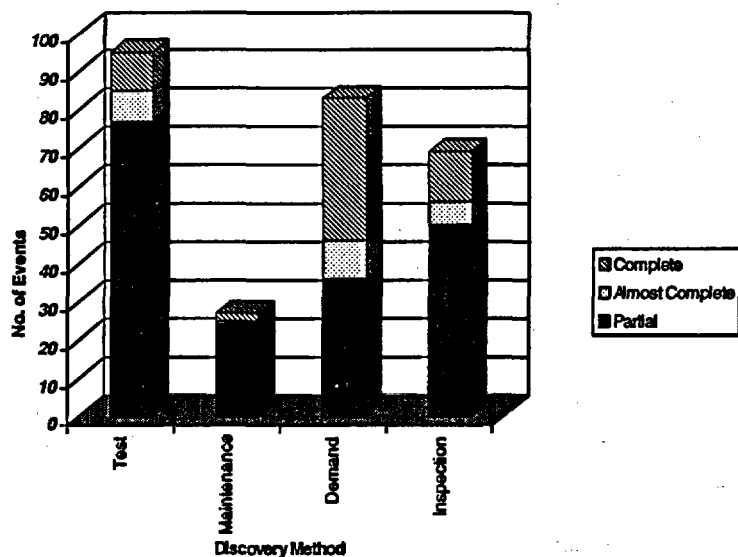

Figure 3-8. Discovery method distribution for all pump CCF events.

3.7 Pump CCF System Observations

Figure 3-9 shows the distribution of pump CCF events by system and the degree of failure. The ESW system had the most events. Most pump CCF events in the ESW system involved problems with the pump impellers and wear rings. The RHR-P system had the largest fraction of Complete CCF events (92 percent). Most of the RHR-P system events involved loss of suction, usually during refueling outages with reduced water level in the RCS. Section 5 of this report provides an in-depth analysis of the pump CCF events in these systems.

3.8 Other Pump CCF Observations

Figure 3-10 shows the distribution of pump CCF events among the NPP units. The data are based on 109 NPP units represented in the insights CCF studies. Eighty-eight of the NPP units included in this study (81 percent) experienced at least one pump CCF event, and 55 NPP units had more than one pump CCF event. While only 38 NPP units experienced more than two pump CCF events, these 38 NPP units account for 76 percent of the total number of pump CCF events.

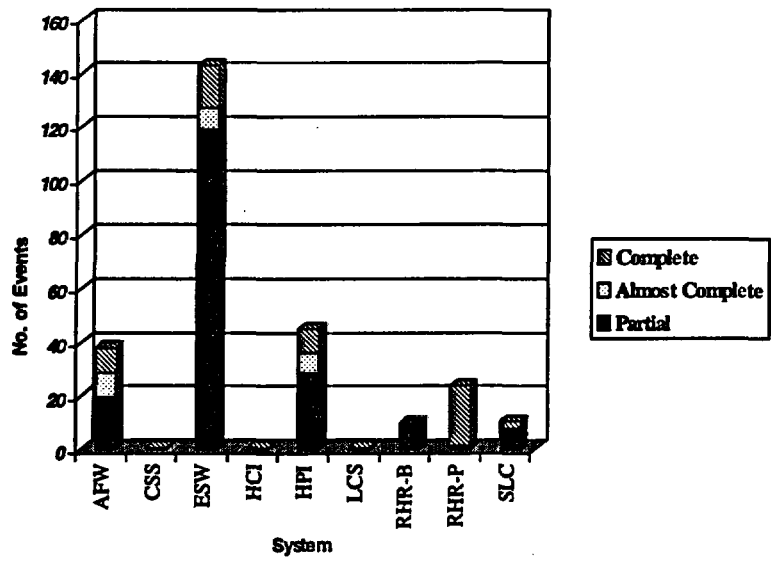

Figure 3-9. Distribution of pump CCF events by system.

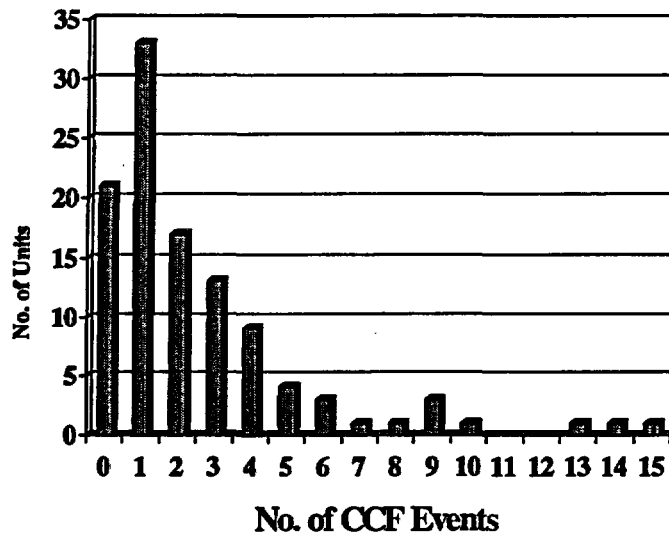

Figure 3-10. Distribution of NPP units experiencing a multiplicity of CCFs for all pump CCF events.

4. ENGINEERING INSIGHTS BY PUMP SEGMENT

4.1 Introduction

This section presents an overview of the pump CCF data that have been collected from the NRC CCF database, grouped by the affected segment. Pumps are relatively complex machines and can easily be thought of as a collection of segments, each with many components. The pump CCF data were reviewed to determine the affected segment and the affected piece part in that segment. This was done to determine which pump segments and piece-parts are most vulnerable to common-cause failure events. For the descriptions of the pump and its segments, see Section 2.4.

Table 4-1 summarizes the CCF events by segment. The rest of this section provides discussions of pump segment, summarizing selected attributes of that segment. At the end of each discussion is a list of the Complete pump CCF events, with identification of the proximate cause, the failure mode, and a short description of the event. For a listing of all pump CCF events by segment, see Appendix B.

Table 4-1. Summary of segments.

Segment	Sub-Section	Partial	Almost Complete	Complete	Total	Percent
Pump	4.2	94	8	4	106	38.7%
Driver	4.3	56	8	23	87	31.8%
Suction	4.4	27	5	34	66	24.1%
Discharge	4.5	10	4	1	15	5.5%
Total		187	25	62	274	100.0%

The majority of the pump CCF events originated in the pump segment followed by the driver and suction segments. The majority of Complete CCF events occurred in the driver and suction segments. There were relatively few events involving the discharge segment. The Complete events in the driver segment were dominated by instrument and control failures and circuit breaker failures. The Complete events in the suction segment were dominated by lack or loss of suction head. The failure mode for the majority of CCF events in the pump and suction segments was fail-to run. However, the failure mode for the majority of events in the driver segment was fail-to-start.

In this study, the proximate causes of the pump CCF events in the NRC CCF database have been grouped into higher-order proximate cause categories to facilitate the graphical depiction of proximate causes. Table 4-2 contains a hierarchical mapping of the proximate causes of pump CCF events into the higher-order groups. Since the graph x-axis labels are restricted in length, the proximate cause category names have been shortened and are shown in parenthesis in Table 4-2. Table 4-2 also describes each of these groups.

Table 4-2. Proximate cause hierarchy.

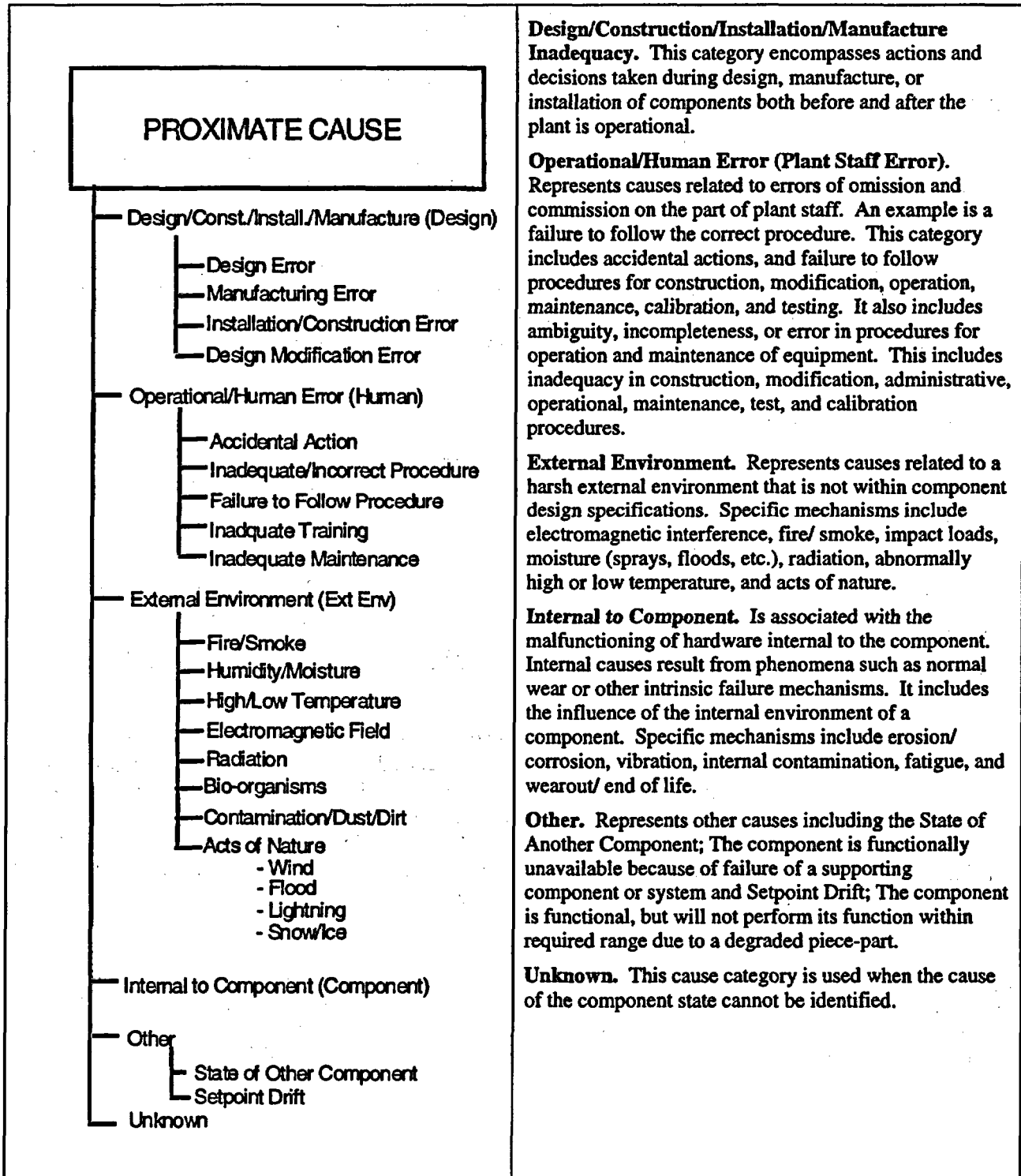

4.2 Pump

There were 106 pump CCF events affecting the pump segment (see Table B-1 in Appendix B, items 103 – 208). Of these 106 events, 37 were fail-to-start and 69 were fail-to-run. Only four of the pump segment events were Complete CCF events. Table 4-3 contains a summary of these events by proximate cause group and degree of failure. Figure 4-1 displays the events by proximate cause and failure mode.

Table 4-3. CCF events in pump segment by cause group and degree of failure.

Proximate Cause Group	Complete	Almost Complete	Partial	Total	Percent
Design/Construction/Installation/ Manufacture Inadequacy	1	3	13	17	16.0%
Internal to Component		3	75	78	73.6%
Operational/Human	2	1	4	7	6.6%
External Environment	1	1	1	3	2.8%
Other			1	1	0.9%
Total	4	8	94	106	100.0%

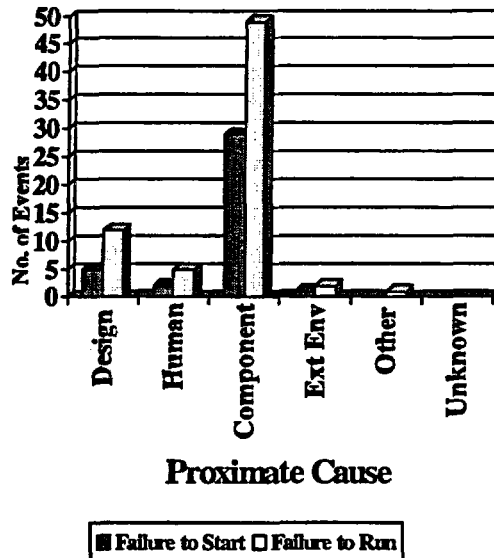

Figure 4-1. Distribution of proximate causes for the pump segment.

The Design/Construction/Installation/Manufacture Inadequacy proximate cause group had 17 events, of which one was Complete and three were Almost Complete (see Table B-1 in Appendix B, items 103 – 119). The causes were primarily due to installation of improper materials that led to corrosion and or failure of piece parts. Other causes included installation errors and failures due to improper design specifications.

The Internal to Component proximate cause group had 78 events, of which none were Complete and three were Almost Complete (see Table B-1 in Appendix B, items 123 – 200). The causes included failed bearings, failed and leaking seals/packing, worn impellers and wear rings due to aging and normal wear and erosion damage of pump internals.

The Operational/Human Error proximate cause group had seven events of which two were Complete and one was Almost Complete (see Table B-1 in Appendix B, items 201 – 207). The causes of these events included pump failures due to misalignment, failures due to maintenance personnel errors such as improper pump assembly or failure to add sufficient lubricant, and gas binding of pumps due to failure to follow procedures.

There were three events with External Environment as the proximate cause group. One of these events was Complete and one was Almost Complete (see Table B-1 in Appendix B, items 120 – 122). The causes for these events included damage from water spray, foreign material in the process fluid and damage due to air entrainment. The Other proximate cause group (see Table B-1 in Appendix B, item 208) contains one event, which was partial. The event involved loss of pump cooling water.

Testing was the most likely method of discovery for CCF events involving the pump segment (59 out of 106 events) as shown in Figure 4-2. The pumps are frequently tested and typically in standby during power operations. Inspection and Demand are the next most likely discovery methods (27 and 13 events, respectively). The most common piece parts involved in pump segment CCF events were the impellers and wear rings, as shown in Figure 4-3.

Table 4-4 lists the short descriptions by proximate cause for the Complete events. The descriptions of all pump CCF events can be found in Appendix A.

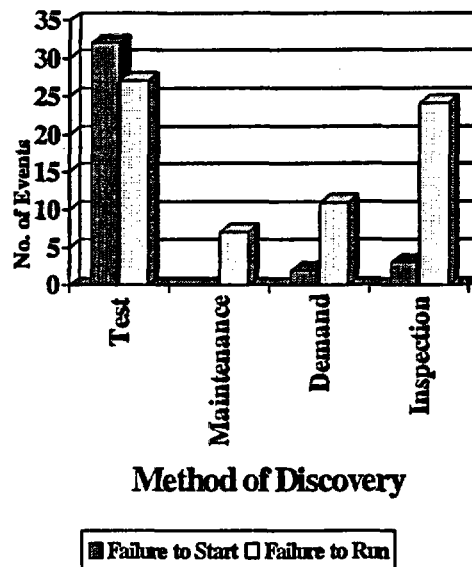

Figure 4-2. Distribution of the method of discovery for the pump segment.

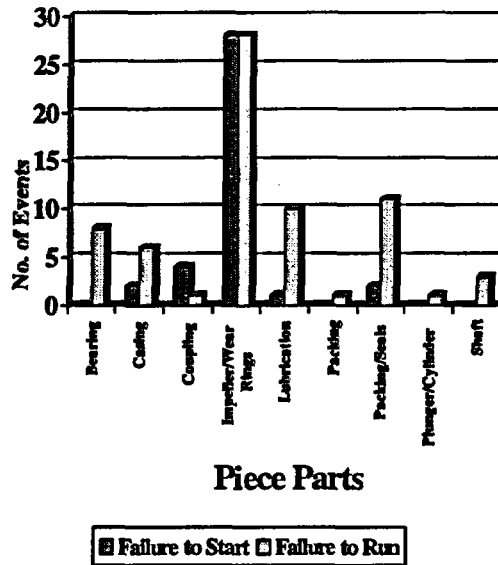

Figure 4-3. Distribution of the affected piece parts for the pump segment.

Table 4-4. Pump segment event short descriptions for Complete events.

System	Proximate Cause Group	Failure Mode	Description
ESW	Design/ Construction/ Manufacture/ Installation Inadequacy	Failure to Run	Both charging pump service water pumps failed. A carbon cap screw failed allowing the impeller of one pump to bind on the casing. The ensuing leakage shorted the motor windings of the other pump.
HPI	Operational/ Human Error	Failure to Start	A routine preventive maintenance (oil change) was mistakenly performed on the north charging pump instead of the south as scheduled. Since the south pump was previously cleared for this oil change, and the test pump was valved out, none of these three pumps were in service as required by tech specs for the approximately 20 minutes it took to change the oil in the north pump.
RHR-P	External Environment	Failure to Start	Following a trip, water was found spraying from both low head safety injection pump wedge control rod seals. Both pumps were declared inoperable. Postulated failure on the seals was from a minor flow induced pressure transient.
RHR-P	Operational/ Human Error	Failure to Start	Both loops of the residual heat removal system were declared inoperable due to gas binding of both RHR pumps. The gas binding was caused by entry of nitrogen gas into the reactor coolant system from accumulator. The root cause of this event has been attributed to personnel error. Personnel did not comply with the specific requirements in the accumulator discharge check valve full flow test procedure due to inattention to detail.

4.3 Driver

There were 87 pump CCF events affecting the driver segment, of which 24 were Complete events and 6 were Almost Complete (see Table B-1 in Appendix B, items 16 – 102). The failure mode for the majority of the pump CCF events involving the driver was fail-to-start (68 events). Only 19 events involved fail-to-run. The most likely proximate cause was Operational/Human, followed by Internal to Component and Design/Construction/ Installation/Manufacture Inadequacy. Table 4-5 contains a summary of these events by proximate cause group and degree of failure. Figure 4-4 shows the distribution of events for the driver segment by proximate cause and failure mode.

Table 4-5. CCF events in the driver segment by cause group and degree of failure.

Proximate Cause Group	Complete	Almost Complete	Partial	Total	Percent
Design/Construction/Installation/ Manufacture Inadequacy	5	3	10	18	20.7%
Internal to Component		3	16	19	21.8%
Operational/Human	12	2	15	29	33.3%
External Environment	2		4	6	6.9%
Other	4		11	15	17.2%
Total	23	8	56	87	100.0%

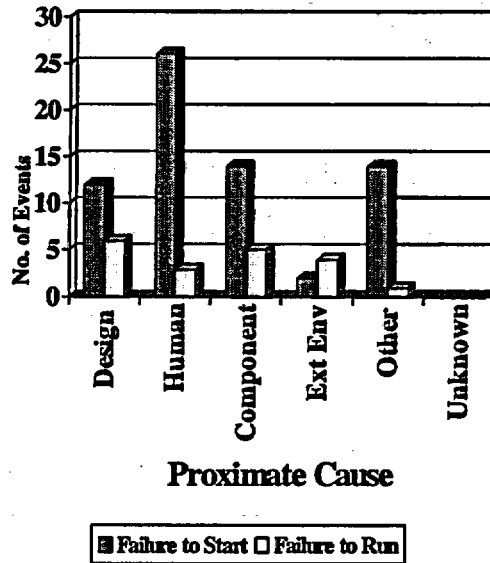

Figure 4-4. Distribution of proximate causes for the driver segment.

There were 18 events involving the driver segment in the Design/Construction/Installation/Manufacture Inadequacy proximate cause group, of which five were Complete and three were Almost Complete (see Table B-1 in Appendix B, items 16 – 33). Most of these events were caused by design related errors with instruments and control circuits.

There were 19 pump CCF events involving the driver segment with Internal to Component as the proximate cause, of which none were Complete and three were Almost Complete (see Table B-1 in Appendix B, items 40 – 58). Most of these events involved circuit breaker failures due to worn internal parts and binding.

A third of the CCF events attributed to the driver segment were assigned to the Operational/ Human Error proximate cause group (see Table B-1 in Appendix B, items 59 – 87). There were 29 driver failures with this proximate cause, of which 12 were Complete and two were Almost Complete. The causes of these events included operations and maintenance personnel errors such as improper lineups, poor maintenance, work on the wrong components, and inadequate procedures.

External Environment was the proximate cause for six driver segment events (see Table B-1 in Appendix B, items 34 – 39). Two of these events were Complete and none were Almost Complete. Causes for these events included foreign material contamination, flooding, low ambient temperatures.

Other was determined to be the proximate cause for 15 driver segment events (see Table B-1 in Appendix B, items 88 – 102). Four of these were Complete and none were Almost Complete. Most of these events were caused by instrument problems or failures of valves and piping in other systems.

Inspection was the most likely method of discovery for driver events (29 events) as shown in Figure 4-5, followed closely by Demands and testing. The most likely piece parts involving driver segment events were circuit breakers, instruments, and control circuits as shown in Figure 4-6.

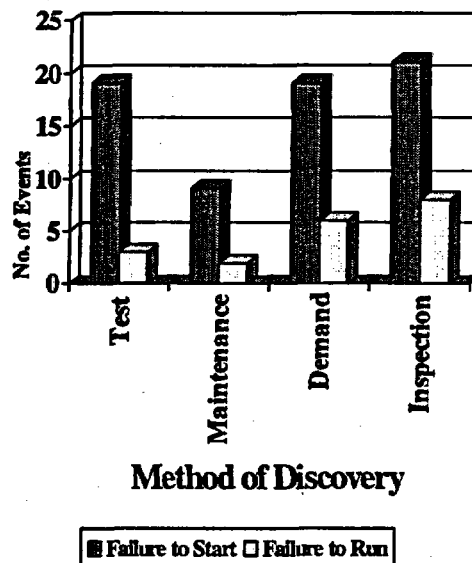

Figure 4-5. Distribution of the method of discovery for the driver segment.

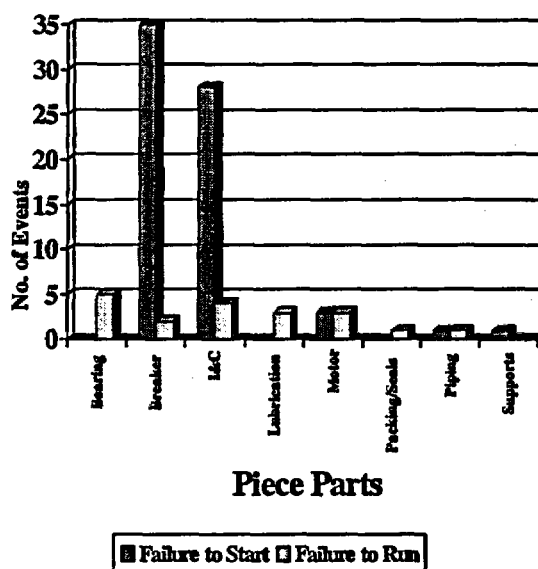

Figure 4-6. Distribution of the affected piece part for the driver segment.

Table 4-6 lists the short descriptions by proximate cause for the Complete events, the events that failed all the pumps. The descriptions of all pump CCF events can be found in Appendix A.

Table 4-6. Driver segment event short descriptions for Complete events.

System	Proximate Cause Group	Failure Mode	Description
AFW	Design/ Construction/ Manufacture/ Installation Inadequacy	Failure to Start	During surveillance testing, neither motor-driven AFW pump would start. The pump control circuit was found with autostart defeat switches labeled backwards, causing all autostarts except the low-low steam generator level to be defeated. The labels were corrected and the links were closed. The original installation error was the result of an inadequate design change process that did not require sufficient verification and testing of the modification.
LCS	Design/ Construction/ Manufacture/ Installation Inadequacy	Failure to Start	Relay extra contacts left connected during construction, prevented Core Spray pump start with emergency diesel generator breakers racked out.
RHR-P	Operational/ Human Error	Failure to Start	All RHR pumps de-energized to replace RHR Relief valve. T.S. allows this condition for 1 hour. Operated in the mode in excess of 5 hours.
ESW	Other	Failure to Start	Following a reactor scram, an attempt to initiate suppression pool cooling revealed that both RHRSW loops were inoperable as neither loop's pumps could be started. Low suction header pressure lockout signals in each loop prevented starting each loop's pumps. Plugging of the sensing line to each loop's suction header pressure switch prevented both switches from sensing actual pressure, although a lack of operating fluid in one switch and an open power supply breaker to the other switch also would have prevented pumps from starting.
HPI	Operational/ Human Error	Failure to Start	During the draining of the reactor coolant system, both centrifugal charging pumps were rendered inoperable. The initial conditions in the draining procedure contained a confusing statement, which led to an erroneous assumption that both CCP breakers had to be racked out and tagged.

System	Proximate Cause Group	Failure Mode	Description
AFW	Operational/ Human Error	Failure to Start	An operator incorrectly secured the diesel and steam-driven AFW pumps, which prevented their restart on low SG level.
AFW	External Environment	Failure to Start	Both AFW pumps failed to start. The problem was traced to two relays (1 per pump). Examination of the relays revealed open circuiting and severe degradation of the insulation.
AFW	Operational/ Human Error	Failure to Start	Both AFW pumps failed to start when tested, due to the circuit breakers not being racked in properly.
SLC	Other	Failure to Start	During a test, both Squib Valve Detonators shorted after firing and the Control Power Transformer fuse blew causing the pump motor trip. This was caused by improper fuse coordination between the Control Power Transformer fuse and the Squib Valve Detonator fuses. The redundant system's Squib Valve was also fired during this test, without running the associated pump, and one of the Squib Valve Detonators shorted after firing. The same fuse coordination problem existed for both systems.
RHR-P	Other	Failure to Start	Two LPI pumps, when given a start signal, would not start. An ongoing investigation revealed the probable root cause of the event to be poor electrical contact of the breaker auxiliary stabs for the pumps.
HPI	Operational/ Human Error	Failure to Start	With alternate CCP pump out-of-service, the remaining operable pump was erroneously placed in pull-to-lock.
HPI	Operational/ Human Error	Failure to Start	HPI pumps not restored before mode change due to procedural inadequacy.
AFW	Design/ Construction/ Manufacture/ Installation Inadequacy	Failure to Start	Both motor-driven auxiliary feedwater pumps failed to start when the operator tried to start them manually. While preparing a design change, the designer failed to review all the unit specific documentation associated with the motor-driven AFW pump wiring and made the erroneous assumption that both units switchgear compartment internal wiring was identical. In fact, the wiring for each unit was different. Consequently, when the design change was installed, it was installed in accordance with the erroneous design. The wiring discrepancy was corrected and the motor-driven AFW pumps were tested and returned to service.
AFW	Operational/ Human Error	Failure to Start	During testing one AFW pump was tested and other was tested without returning first to auto. Both pumps were unavailable at the same time. The procedure was the cause.
ESW	Operational/ Human Error	Failure to Start	An emergency service water pump failed to start and was declared inoperable. Further investigation determined that the failure of the pump to start was due to a tripped emergency engine shutdown device. Operations personnel performing the testing did not recognize the need to reset it prior to starting the pump. Examination of the other two ESW pumps revealed that their emergency shutdown devices were also in the tripped condition.
HPI	Operational/ Human Error	Failure to Start	By opening incorrect breaker, HPI pump tripped while others were unavailable.
HPI	External Environment	Failure to Run	It was determined that the common minimum flow path return line for the safety injection pumps to the refueling water storage tank was frozen. Previous actions to investigate problems with the freeze protection system were unsuccessful in preventing development of this condition. The two HPI pumps were declared inoperable with this return line frozen. A faulty ambient temperature switch for the RWST heat trace system prevented the heat trace from activating and was subsequently replaced. In addition, administrative controls did not sufficiently recognize the safety significance of flow through this line and the need to ensure flow capability.
CSR	Operational/ Human Error	Failure to Start	CSR control power de-energized prior to mode change. Technical Specification violation. Inadequate procedure review.
AFW	Design/ Construction/ Manufacture/ Installation Inadequacy	Failure to Start	A modification design error (in 1983-1984) removed a start permissive interlock contact. At cold shutdown this de-energized the auxiliary lube oil pump, consequently, when one AFW pump was started it ran for 2.5 seconds and tripped on low oil pressure. Further investigation showed that both units AFW pumps would be affected in the same way. The design error combined with insufficient post modification testing led to this CCF event.
RHR-P	Operational/ Human Error	Failure to Start	Both trains of RHR were rendered inoperable for two minutes, while performing an operational readiness test surveillance procedure. The surveillance procedure required that the one RHR train pump be placed in pull to lock and the other train heat exchanger flow control valve throttled to 30-40% open. The procedure directed the

System	Proximate Cause Group	Failure Mode	Description
	Error	to Start	operators to perform operations that resulted in both trains of RHR being inoperable
RHR-P	Operational/ Human Error	Failure to Start	The switches for the containment spray and recirculation pumps were in a trip pullout when the Technical Specifications and plant procedures required the pumps to be operable.
HCI	Other	Failure to Start	Water entered the HCI and RCI steam supply lines, rendering both pumps inoperable. Failed reactor vessel instrumentation allowed water to overflow and fill the HCI/RCI steam lines. Pumps were unavailable.
RHR-P	Design/ Construction/ Manufacture/ Installation Inadequacy	Failure to Run	Both RHR/LPI pumps fail-to-run due to improper oil in system. High bearing temperatures occurred when the pumps were operated. This was due to the wrong lube oil being used, which had too high a viscosity. Inadequate vender design information resulted in the higher viscosity oil being used and additional exacerbating problems such as insufficient bearing clearances.

4.4 Suction

Sixty-six events affected the suction segment of the pumps (see Table B-1 in Appendix B, items 209 – 274). Thirty-four were Complete events. The most likely proximate cause was Design/Construction/Installation/Manufacture. The failure mode was fail-to-run for 54 events and fail-to-start for 12 events. Table 4-7 contains a summary of these events by proximate cause group and degree of failure. Figure 4-7 shows the distribution of events by proximate cause and failure mode.

Table 4-7. CCF events in the suction segment by cause group and degree of failure.

Proximate Cause Group	Complete	Almost Complete	Partial	Total	Percent
Design/Construction/Installation/ Manufacture Inadequacy	11	2	16	29	43.9%
Internal to Component			6	6	9.1%
Operational/Human	12	1	4	17	25.8%
External Environment	1			1	1.5%
Other	9	2	1	12	18.2%
Unknown	1			1	1.5%
Total	34	5	27	66	100.0%

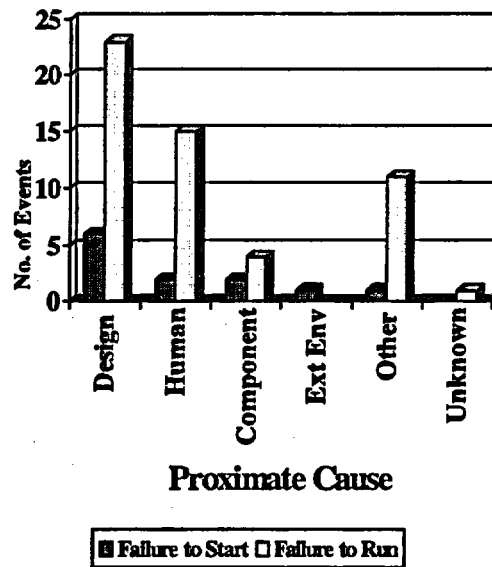

Figure 4-7. Distribution of proximate causes for the suction segment.

The Design/Construction/Installation/Manufacture Inadequacy proximate cause group had 29 events, of which 11 were Complete and two were Almost Complete (see Table B-1 in Appendix B, items 209 – 237). Most of these events involved inadequate net positive suction head due to poor system design.

The Internal to Component proximate cause group had six events, of which none were Complete or Almost Complete (see Table B-1 in Appendix B, items 239 – 244). All of these events involved blocked suction due to foreign material intrusion.

There were 17 events assigned to the Operational/Human Error proximate cause group. Twelve of these events were Complete and one was Almost Complete (see Table B-1 in Appendix B, items 245 – 261). These events mostly involve inadequate procedures and personnel errors related loss of pump suction due to improper venting or system lineups. This has the largest (35 percent) contribution to the Complete suction events.

Other was identified as the proximate cause of 12 events, of which nine were Complete and two were Almost Complete (see Table B-1 in Appendix B, items 262 – 273). These events involved failures of other components impacting pump suction, such as leaking or blocked valves, failed vent valves, and erroneous level instruments.

There was one event assigned to each of the External Environment and Unknown proximate cause groups, and both these events were Complete (see Table B-1 in Appendix B, items 238 and 274). One event involved loss of RHR pump suction, the cause of which could not be determined or repeated. The other event was caused by boron solidification in the suction piping.

Demand was the most likely method of discovery for the suction segment events (39 of 68 events) as shown in Figure 4-8. Since most events were attributed to design problems and human error, this implies that testing has not been effective in detecting failures with these causes. The most likely

piece part involved in the suction segment CCF events was piping as shown in Figure 4-9. The piping piece part indicates that something caused a loss of NPSH to the pumps that is not a valve, strainer, etc.

Table 4-8 lists the short descriptions by proximate cause for the Complete events. The descriptions of all pump CCF events can be found in Appendix A.

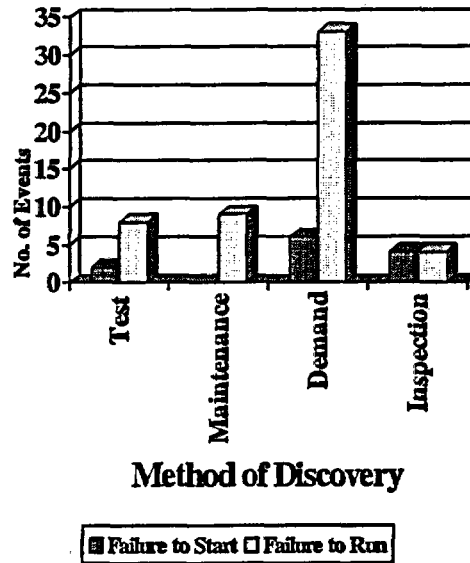

Figure 4-8. Distribution of the method of discovery for the suction segment.

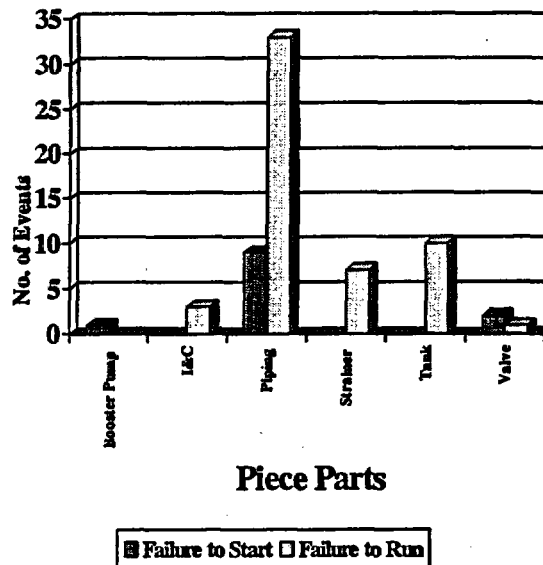

Figure 4-9. Distribution of the affected piece parts for the suction segment.

Table 4-8. Suction segment event short descriptions for Complete events.

System	Proximate Cause Group	Failure Mode	Description
AFW	Operational/ Human Error	Failure to Run	Both emergency feedwater pumps lost feed pump suction. The emergency feedwater pump suction flashed to steam due to the feedwater train flashing and forcing hot water back through the startup and blowdown tanks and into the feedwater pump suction. To prevent this recurrence, the operating procedures have been changed to require isolating the startup and blowdown effluent as a source of emergency feedwater suction prior to increasing power.
RHR-P	Other	Failure to Run	A complete loss of RHR flow occurred while plant operators were increasing RHR heat exchanger flow by closing down on the heat exchanger bypass valve.
RHR-P	Operational/ Human Error	Failure to Run	While attempting to increase RHR flow, the plant experienced a total loss of flow due to the pumps being air-bound. The pump was not vented when starting to increase flow. Operating procedures have been changed to have an operator present while changing flow in the RHR system. There have been losses of RHR flow in the past because the pumps were air-bound and methods are being investigated to improve the system design.
RHR-P	Operational/ Human Error	Failure to Run	The reactor vessel vent eductor was in service in preparation for refueling with RHR operating. A low flow alarm was received and low flow and low motor current were indicated. A second pump was started and became air-bound. Putting the vessel vent eductor system into service was the root cause of the incident.
ESW	Design/ Construction/ Manufacture/ Installation Inadequacy	Failure to Run	Increasing flow to chillers robs NPSH from charging service water pumps.
ESW	Design/ Construction/ Manufacture/ Installation Inadequacy	Failure to Run	Increased flow to chillers resulted in loss of NPSH to Charging Water Service Water pumps.
RHR-P	Other	Failure to Run	Temporary coolant loop level indicator showed level slowly increasing over a period of days. The system was periodically drained to maintain 65 percent indicated level. A RHR pump lost suction on reduction of actual level. The second pump was started, and lost suction. Indication drift was due to evaporation of reference leg.
ESW	Design/ Construction/ Manufacture/ Installation Inadequacy	Failure to Run	The use of service water by the chillers can cause a loss of suction pressure to the charging pump service water pumps.
ESW	Design/ Construction/ Manufacture/ Installation Inadequacy	Failure to Run	Increased flow to chillers resulted in loss of NPSH to Charging Water Service Water pumps.
ESW	Design/ Construction/ Manufacture/ Installation Inadequacy	Failure to Run	The use of service water by the chillers can cause a loss of suction pressure to the Charging Water Service Water pumps.
ESW	Design/ Construction/ Manufacture/ Installation Inadequacy	Failure to Run	The use of service water by the chillers can cause a loss of suction pressure to the charging pump service water pumps.
HPI	Other	Failure to Start	Hydrogen from the suction dampener got into suction piping and failed both CCPs.

System	Proximate Cause Group	Failure Mode	Description
RHR-P	Other	Failure to Run	RHR Suction lost due to erroneous RCS level while draining the RCS.
RHR-P	Operational/ Human Error	Failure to Run	Shutdown cooling was lost due to nitrogen intrusion because of backflushing a filter in the purification system.
RHR-P	Operational/ Human Error	Failure to Run	Suction was lost to both RHR pumps. RHR flow was less than 3000 gpm and pump amps were fluctuating prior to taking corrective action. Each of these events appear to have been caused by a slow decrease in RCS level in conjunction with the vortex action at the pump suction.
RHR-P	Other	Failure to Run	With unit drained to centerline of the nozzles, suction to both RHR pumps was lost for 36 minutes. Suction to the RHR pumps was lost because of ambiguous reactor coolant system level indication while drained to centerline of the nozzles. The actual RCS level was lower than observed.
ESW	Design/ Construction/ Manufacture/ Installation Inadequacy	Failure to Run	Increased flow to chillers resulted in loss of NPSH to Charging Water Service Water pumps.
RHR-P	Other	Failure to Run	The RHR pumps began to cavitate and eventually both pumps were stopped. The reactor vessel level gauge being used to provide an indication that the level was approaching the vessel flange level had been isolated (reactor coolant drain tank isolation valve had been closed during an attempt to reduce leakage). Additionally, procedures did not require visual monitoring of cavity level.
RHR-P	Unknown	Failure to Run	RHR pumps cavitated. Unable to repeat. Unknown cause.
HPI	External Environment	Failure to Start	Boron solidification in the suction and gas binding of pumps led to the failure of all three safety injection pumps. Flushing procedures inadequate.
RHR-P	Operational/ Human Error	Failure to Run	The control room operators started a second residual heat removal pump in preparation for removing the operating RHR pump from service. With both pumps running, flow became excessive for the half-loop condition causing cavitation and air binding of both pumps. To prevent recurrence the procedure which controls the operation of the RHR pumps has been changed to include specific instructions to stop the operating pump prior to starting the second pump while at half-loop.
RHR-P	Other	Failure to Run	Both RHR pumps were unable to operate due to the introduction of air into the RHR system. The incident occurred during the drain down of the RCS, when the level of the RCS was being monitored via a standpipe off the centerline of one of the RCS loops. The isolation valve to which the standpipe was attached became clogged sometime during the drain down and falsely indicated above centerline when in fact the level was below the RHR suction line (below centerline).
RHR-P	Operational/ Human Error	Failure to Run	Swap over of RHR pumps resulted in both trains becoming inoperable due to air injection into the suction of the pumps. This required both pumps to be vented and required RCS level to be raised to prevent a possible recurrence of the vortex problem.
ESW	Operational/ Human Error	Failure to Run	A service water strainer was placed in service without being vented resulting in air binding system and loss of charging pump service water pumps.
ESW	Operational/ Human Error	Failure to Run	Failure to properly vent and fill a newly installed pipe introduced air into the charging pump service water system.
ESW	Design/ Construction/ Manufacture/ Installation Inadequacy	Failure to Run	Loss of prime in the condenser circulating water siphon flow system caused loss of low pressure service water pumps. Pumps lost suction during a test due to poor design.
RHR-P	Other	Failure to Run	SDC pumps cavitated due to lowering RCS level. Level indication was in error.

System	Proximate Cause Group	Failure Mode	Description
RHR-P	Other	Failure to Run	RHR flow was interrupted when both RHR trains became inoperable due to air bound RHR pumps. The loss of RCS inventory to the reactor coolant drain tank due to a leaking valve caused a decrease in RCS water level, vortexing in the pumps' suction line, and air entrainment in the RHR pumps.
ESW	Operational/ Human Error	Failure to Run	The procedure failed to adequately caution the operator to slowly fill a drained line. Rapid filling resulted in a loss of NPSH to the charging service water pumps.
SLC	Design/ Construction/ Manufacture/ Installation Inadequacy	Failure to Run	During the performance of a special test on the available NPSH of the SLC pumps, the pumps began to cavitate unexpectedly. The SLC systems of both units were declared inoperable. The causes of this event are inadequate modification testing and an error in the original design calculations.
SLC	Design/ Construction/ Manufacture/ Installation Inadequacy	Failure to Run	During the performance of a special test on Unit 1 to determine the available NPSH of the SLC pumps, the pumps began to cavitate unexpectedly. The SLC systems of both units were declared inoperable. The causes of this event are inadequate modification testing and an error in the original design calculations.
ESW	Operational/ Human Error	Failure to Run	Both trains of both units charging pump service water pumps became air bound. Underwater diving maintenance activities on one units circulating water and service water lines was identified as the source of the air. The air entered the service water supply lines when a valve was opened in preparation for a Safety Injection logic test.
ESW	Operational/ Human Error	Failure to Run	Both trains of both units charging pump service water pumps became air bound. Underwater diving maintenance activities on one units circulating water and service water lines was identified as the source of the air. The air entered the service water supply lines when a valve was opened in preparation for a Safety Injection logic test.
HPI	Design/ Construction/ Manufacture/ Installation Inadequacy	Failure to Run	HPI pumps fail due to operation with inadequate suction head. Two pumps damaged due to operation with inadequate suction, but all three system pumps were unavailable due to the loss of the suction source. Suction source level instrumentation was the cause.
SDC	Other	Failure to Start	SDC pump suction high temperature interlock failed, causing all three SDC pumps to be inoperable.

4.5 Discharge

Fifteen events affected the discharge segment of the pumps, of which one event was Complete and four were Almost Complete (see Table B-1 in Appendix B, items 1 – 15). No one proximate cause was dominant. The failure mode for eight events was fail-to-start and the failure mode for seven events was fail-to-run. Table 4-9 contains a summary of these events by proximate cause group and degree of failure. Figure 4-10 shows the distribution of events by proximate cause and failure mode.

Table 4-9. CCF events in the discharge segment by cause group and degree of failure.

Proximate Cause Group	Complete	Almost Complete	Partial	Total	Percent
Design/Construction/Installation/ Manufacture Inadequacy			3	3	20.0%
Internal to Component		1	4	5	33.3%
Operational/Human	1	1	1	3	20.0%
External Environment		2	1	3	20.0%
Other			1	1	6.7%
Total	1	4	10	15	100.0%

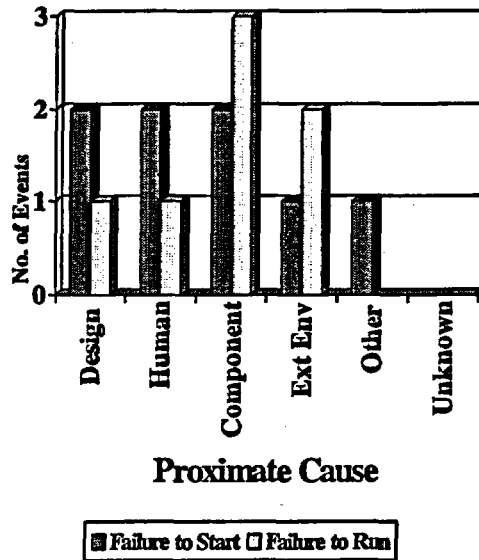

Figure 4-10. Distribution of proximate causes for the discharge segment.

The Design/Construction/Installation/Manufacture Inadequacy proximate cause group had three events, of which none were Complete or Almost Complete (see Table B-1 in Appendix B, items 1 – 3). These events involved failure of the discharge flow controller, pumps dead-headed by other operating pumps, and discharge valve failure.

The Internal to Component proximate cause group had five events, of which none were Complete and one was Almost Complete (see Table B-1 in Appendix B, items 7 – 11). These events involved degradation of discharge valves and line blockage.

The Operational/Human Error proximate cause group contains three events, with one Complete event and one Almost Complete event (see Table B-1 in Appendix B, items 12 – 14). Two of these events were due to inadvertent valve closures in the discharge flow path. The third event was due to

procedural problems that allowed pumps to be run with no flow or beyond the maximum allowable flow rate.

External Environment was the proximate cause for three events, two of which were Almost Complete (see Table B-1 in Appendix B, items 4 – 6). These events were caused by voiding in the discharge lines due to high temperatures, voiding due to air entrainment, and blockage due to foreign material intrusion.

The Other proximate cause group was identified for one Partial event, which was caused by failure of an automatic vent valve on the pump discharge lines (see Table B-1 in Appendix B, item 15).

The method of detection was rather evenly split among demand, inspection, and testing for the discharge segment events as shown in Figure 4-11. Most discharge segment events involved the state of the valves in the discharge of the pumps as shown in Figure 4-12. Table 4-10 lists the short description for the Complete discharge segment event. The descriptions of all pump CCF events can be found in Appendix A.

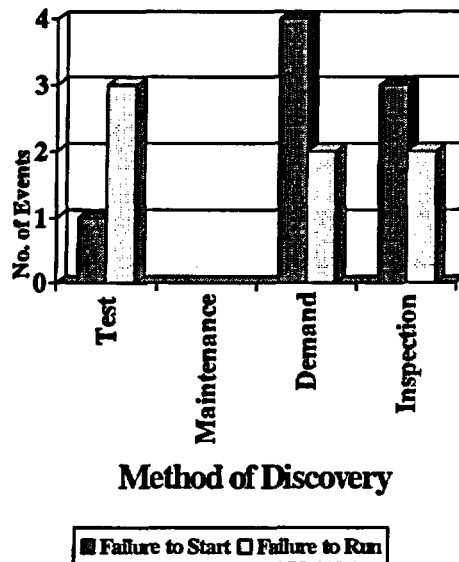

Figure 4-11. Distribution of the method of discovery for the discharge segment.

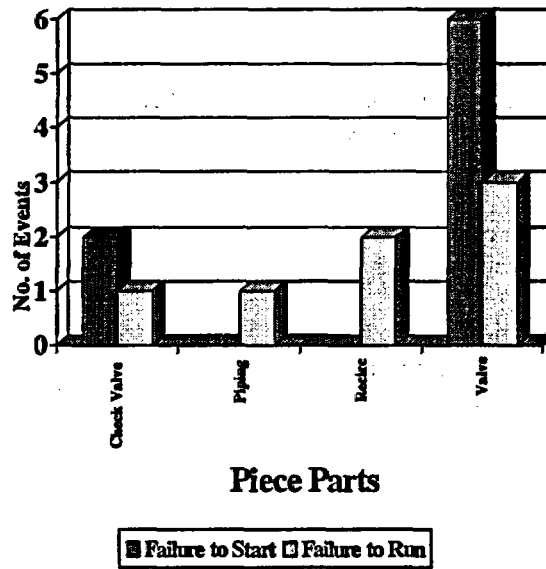

Figure 4-12. Distribution of the affected piece parts for the discharge segment.

Table 4-10. Discharge segment event short description for the Complete event.

System	Proximate Cause Group	Failure Mode	Description
AFW	Operational/ Human Error	Failure to Start	Following a trip, the AFW Pumps were secured and the discharge flow control valves for the Motor-driven Pumps were closed. Later, an operator discovered during a routine Control Board walkdown that the valves were closed. Subsequent investigation revealed the AFW system had not been placed in standby readiness per the operating procedure after the system was secured.

5. ENGINEERING INSIGHTS BY PUMP SYSTEM

5.1 Introduction

This section presents an overview of the CCF data for the pump component that have been collected from the NRC CCF database, grouped by the system. Each discussion of a system summarizes selected attributes of that system. Table 5-1 shows the summary of the event counts by system and the degree of failure. For a listing of all pump CCF events, by system, see Appendix C.

Table 5-1. Summary of systems.

System	Sub-Section	Partial	Almost Complete	Complete	Total	Percent
ESW	5.2	119	8	16	143	52.2%
HPI	5.3	29	7	9	45	16.4%
AFW	5.4	20	9	9	38	13.9%
RHR-P	5.5	1	1	22	24	8.8%
SLC	5.6	8		3	11	4.0%
RHR-B	5.8	10			10	3.6%
CSS	5.8			1	1	0.4%
HCI	5.8			1	1	0.4%
LCS	5.8			1	1	0.4%
Total		187	25	62	274	100.0%

5.2 Emergency Service Water

One hundred and forty three pump CCF events affected pumps in the ESW system (see Table C-1 in Appendix C, items 40 – 182). Figure 5-1 through Figure 5-4 show selected distributions graphically. The Internal to Component was the dominant proximate cause (51 percent of the events for this system) affecting both the fail-to-start and fail-to-run. The most likely discovery method was testing. Most pump CCF events in the ESW system involved problems with the pump impellers and wear rings. Consistent with this, most of the failures involved the pump segment (50 percent).

Sixteen of the ESW pump CCF events were Complete. The set of Complete CCF events is dominated by two units at a single facility, accounting of 14 of the 16 events. Most these events occurred in the early 1980s and involved a design configuration issue, which caused the ESW pumps to fail when suction water was diverted for the chillers. Most of the other events involved air introduction into the ESW suction path. Very few of the Complete and Almost Complete events are attributed to the impeller or wearing rings. However, the ESW pumps CCFs are dominated by this piece part.

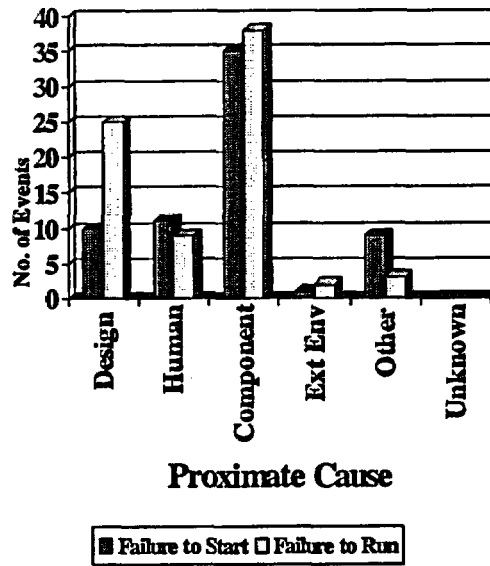

Figure 5-1. Proximate cause distribution for the ESW system.

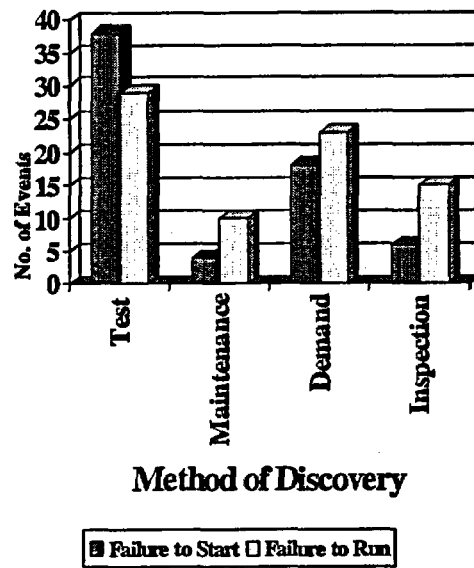

Figure 5-2. Method of discovery distribution for the ESW system.

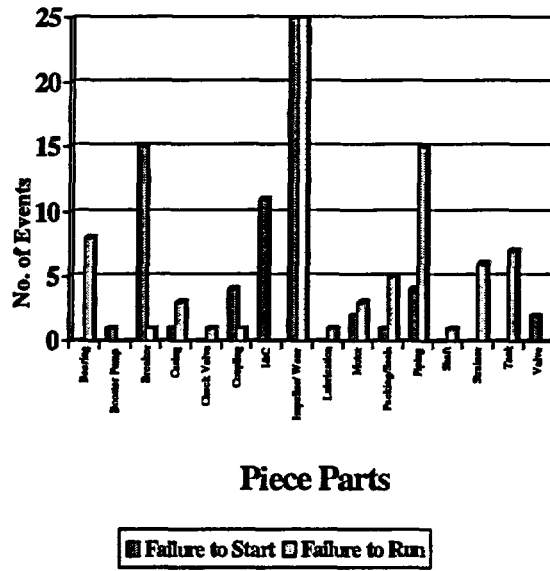

Figure 5-3. Piece part distribution for the ESW system.

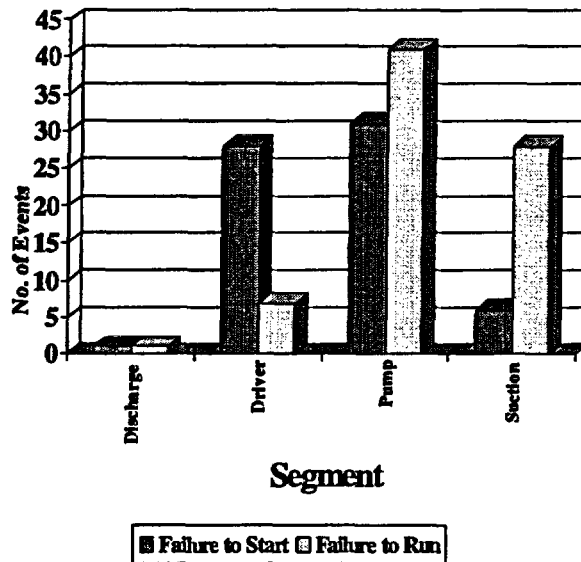

Figure 5-4. Segment distribution for the ESW system.

5.3 High Pressure Injection

Forty-five pump CCF events affected pumps in the HPI system (see Table C-1 in Appendix C, items 184 – 228). Figure 5-5 through Figure 5-8 show selected distributions graphically. The most likely proximate causes were the Internal to Component, Design/Construction/Installation/Manufacture Inadequacy, and Operational/Human Error. The failure mode for 26 events was fail-to-run and the failure mode for 19 events was fail-to-start. The most likely discovery method was Inspection.

Nine of the HPI pump CCF events were Complete and seven events were Almost Complete. Most of these events involve line blockage (foreign material, bio-fouling, boron solidification, frozen lines) or system misalignment. For all HPI events, the dominant failed piece parts were lubrication, piping, instruments, and control circuits and circuit breakers. Sixteen events involved failure of the driver segment while 13 events involved the pump segment.

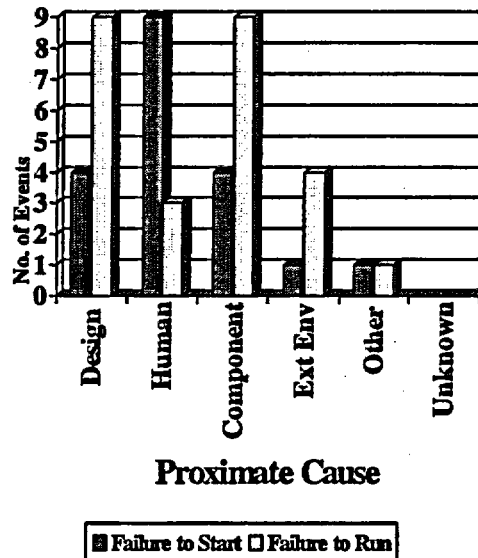

Figure 5-5. Proximate cause distribution for the HPI system.

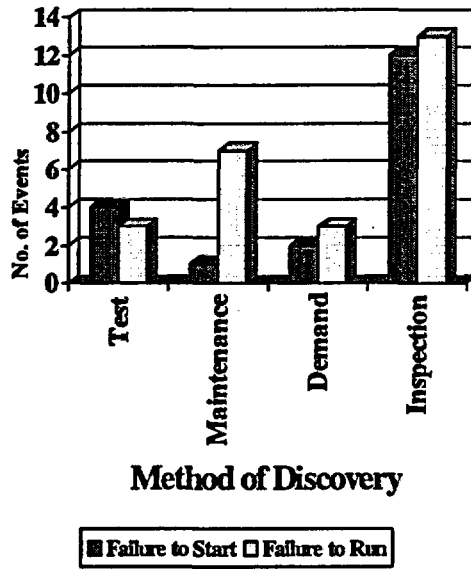

Figure 5-6. Method of discovery distribution for the HPI system.

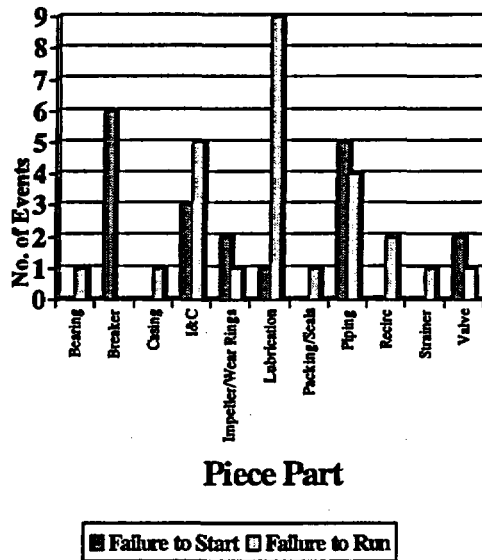

Figure 5-7. Piece part distribution for the HPI system.



Figure 5-8. Segment distribution for the HPI system.

5.4 Auxillary Feedwater

Thirty-eight pump CCF events affected pumps in the AFW system (see Table C-1 in Appendix C, items 1 – 38). Figure 5-9 through Figure 5-12 show selected distributions graphically. The most likely proximate cause was Design/Construction/ Installation/Manufacture Inadequacy (37 percent), followed by Internal to Component (26 percent) and Operational/Human Error (21 percent). The failure mode for 18 events was fail-to-run and the failure mode for 20 events was fail-to-start. The most likely discovery method was Demands. There were nine Complete and nine Almost Complete AFW pump CCF events. Almost half the AFW pump CCF events were observed safety-significant events. The last Complete AFW pump CCF event occurred in 1994.

The dominant piece parts involved in the AFW pump Complete and Almost Complete CCF events were instrument and control circuits. Examples follow: Degraded relays, permissive interlock, interlock improperly engaged, pumps not returned to automatic, autostart defeat switches labeled backwards, incorrect modification of pump circuitry. These events involved human error, failed equipment, improper operation, and bad design. Consistent with this, most of the events involved the driver segment with a dominant failure mode of fail-to-start. Another important contribution was the leaking of check valves that caused the AFW pumps to become steam bound.

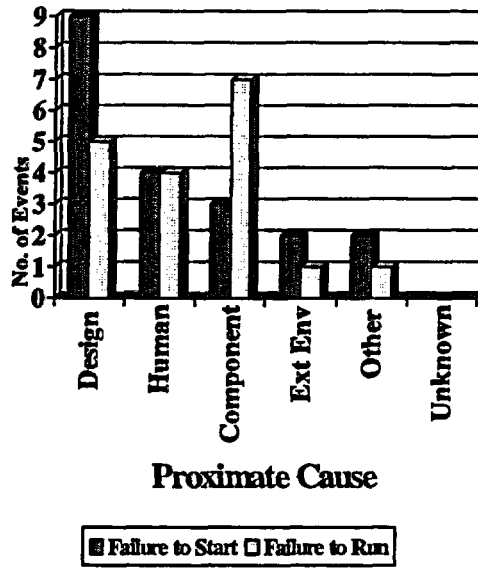

Figure 5-9. Proximate cause distribution for the AFW system.

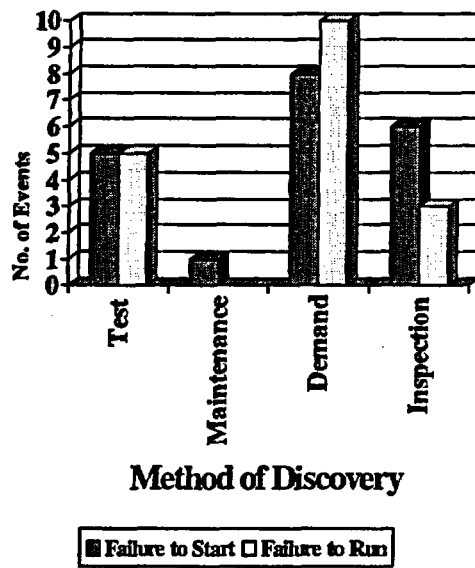

Figure 5-10. Method of discovery distribution for the AFW system.

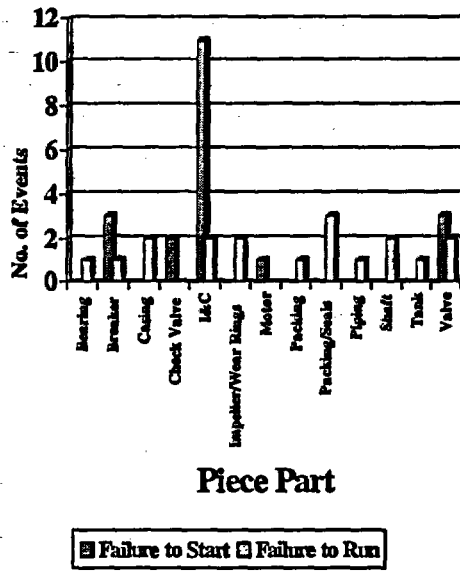

Figure 5-11. Piece part distribution for the AFW system.

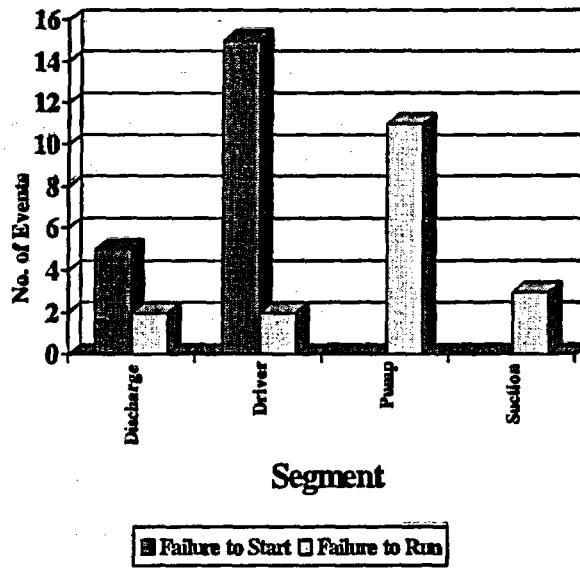

Figure 5-12. Segment distribution for the AFW system.

5.5 Residual Heat Removal (PWR)

Twenty-four pump CCF events affected pumps in the RHR-P system (see Table C-1 in Appendix C, items 240 – 263). Figure 5-13 through Figure 5-16 show selected distributions graphically. The RHR-P system had the largest fraction of Complete CCF events (92 percent). One event was Almost Complete. Consistent with this, the dominant proximate causes were Operational/Human Error and Other, and the dominant method of discovery was Demands. The pump CCF data indicates that events caused by human error or component failures outside the pump boundary are more likely to be Complete events and are more likely to be detected by demand than by testing, maintenance or inspection. The failure mode for most RHR-P system CCF events was fail-to-run (18 events). The last Complete RHR-P pump CCF event was in 2000, indicating that the overall problems with RHR-P pumps have not been completely addressed. However, the last loss of suction CCF event was in 1987, which indicates that this failure mode has been addressed.

The Suction segment and the piping piece part (piping was used as the piece part for the loss of suction events) dominate the events in this system. Most of the RHR-P system events involved loss of suction, usually during refueling outages with reduced water level in the RCS. These events occurred repeatedly, but were caused by different mechanisms including suction vortexing, air entrainment, operator error, and malfunctioning level instruments. All 16 of the suction segment events were either Complete or Almost Complete. Four of the remaining Complete events were due to improper system lineups caused by human error.

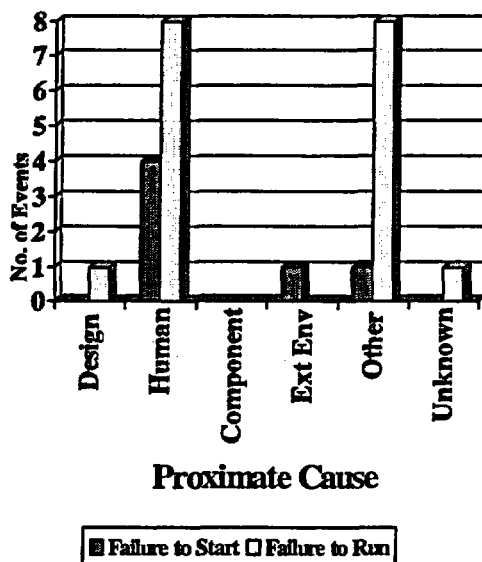

Figure 5-13. Proximate cause distribution for the RHR-P system.

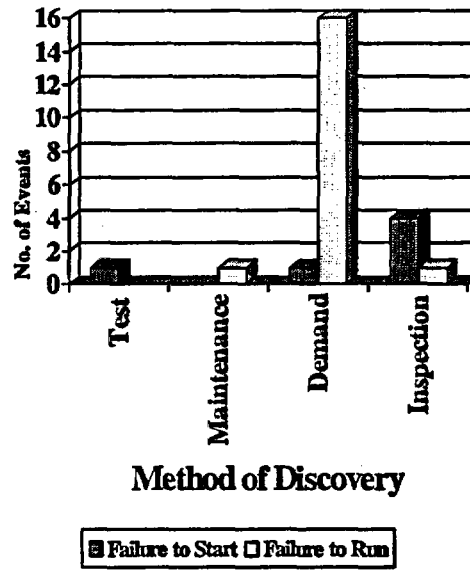

Figure 5-14. Method of discovery distribution for the RHR-P system.

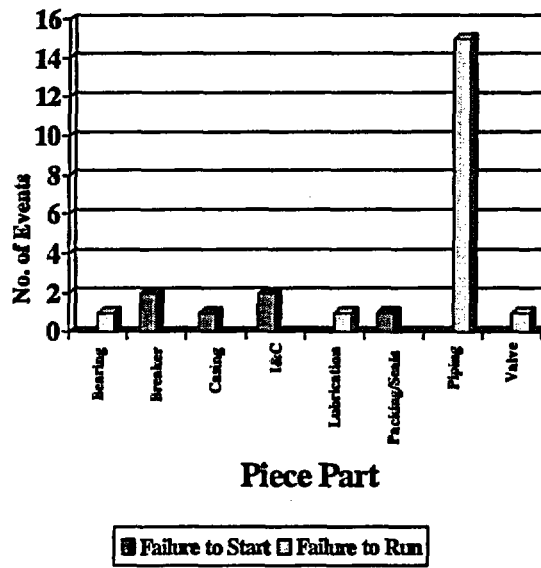

Figure 5-15. Piece part distribution for the RHR-P system.

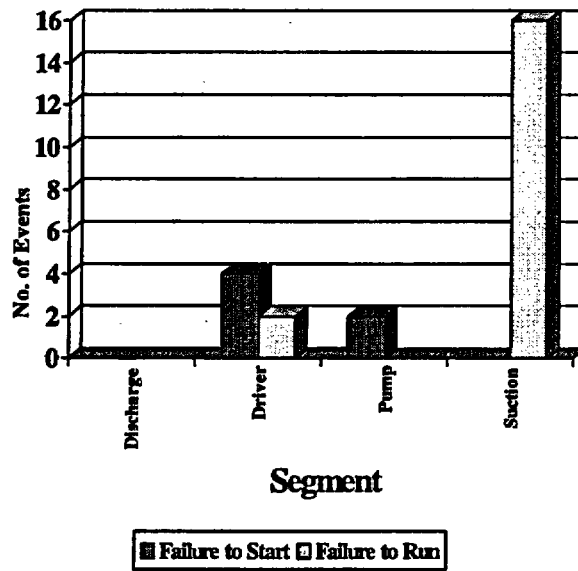

Figure 5-16. Segment distribution for the RHR-P system.

5.6 Standby Liquid Control

Eleven pump CCF events affected pumps in the SLC system (see Table C-1 in Appendix C, items 264 – 274). Figure 5-17 through Figure 5-20 show selected distributions for the SLC system. The dominant proximate cause was Internal to Component (64 percent) and the dominant failure mode was fail-to-run (73 percent). The most likely discovery methods were inspection and testing. A variety of piece parts failed, affecting mostly the pump segment. Three of the SLC system CCF events were Complete and none were Almost Complete. One of the Complete events involved a short circuit in the pump control circuit and two events involved inadequate pump suction head. The Partial SLC pump CCF events were associated with worn internals and leaks.

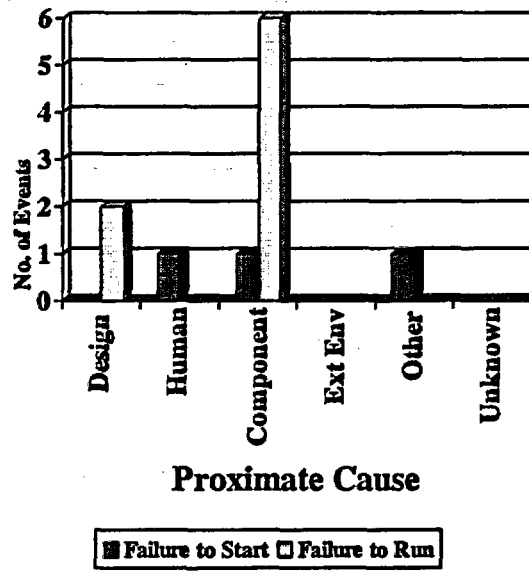

Figure 5-17. Proximate cause distribution for the SLC system.

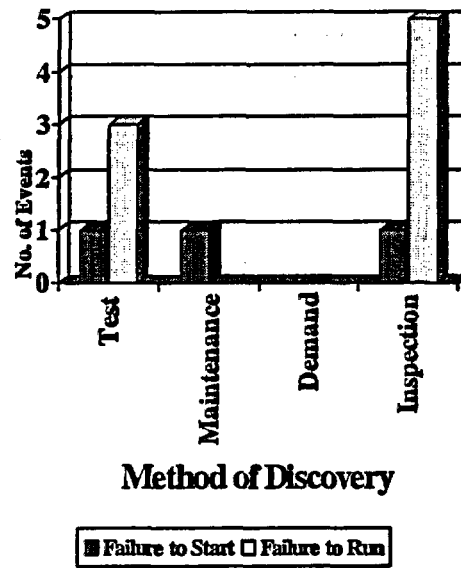

Figure 5-18. Method of discovery distribution for the SLC system.

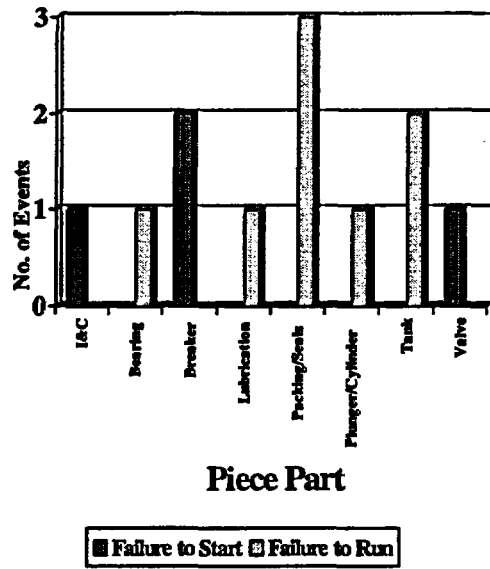

Figure 5-19. Piece part distribution for the SLC system.

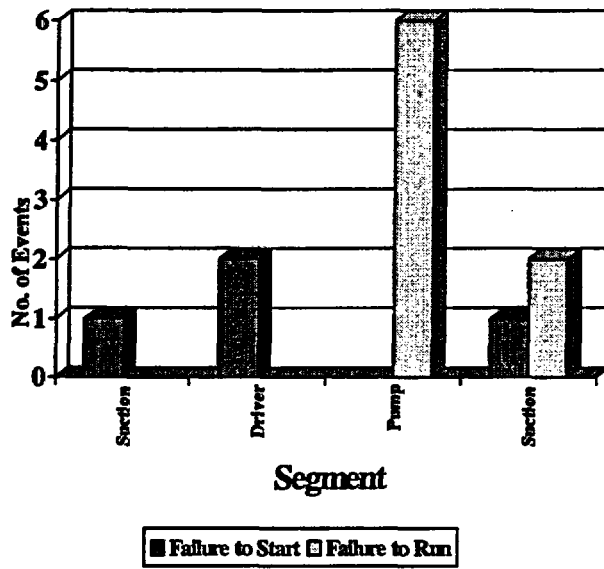

Figure 5-20. Segment distribution for the SLC system.

5.7 Residual Heat Removal (BWR)

Ten pump CCF events affected pumps in the RHR-B system (see Table C-1 in Appendix C, items 230 – 239). Figure 5-21 through Figure 5-24 show selected distributions for the RHR-B system. The most likely proximate cause was Internal to Component (50 percent) and the dominant failure mode was fail-to-start (80 percent). The most likely discovery method was Testing and half of the events involved circuit breaker failures. None of the RHR-B system CCF events were classified as either Complete or Almost Complete.

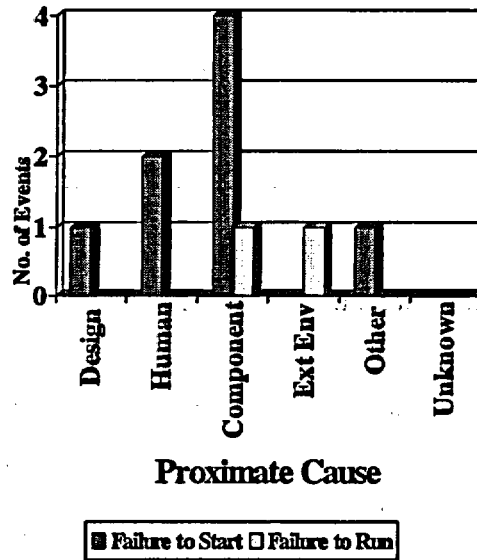

Figure 5-21. Proximate cause distribution for the RHR-B system.

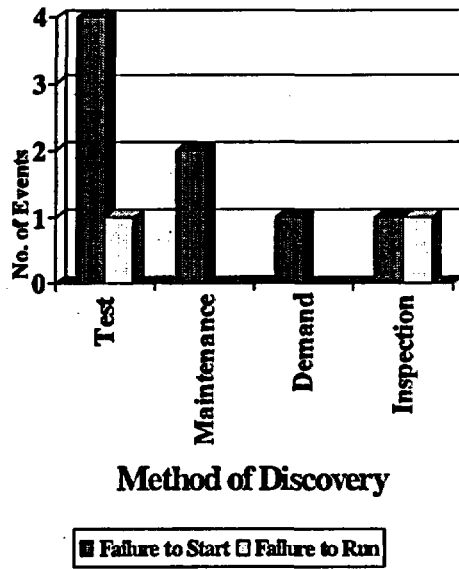

Figure 5-22. Method of discovery distribution for the RHR-B system.

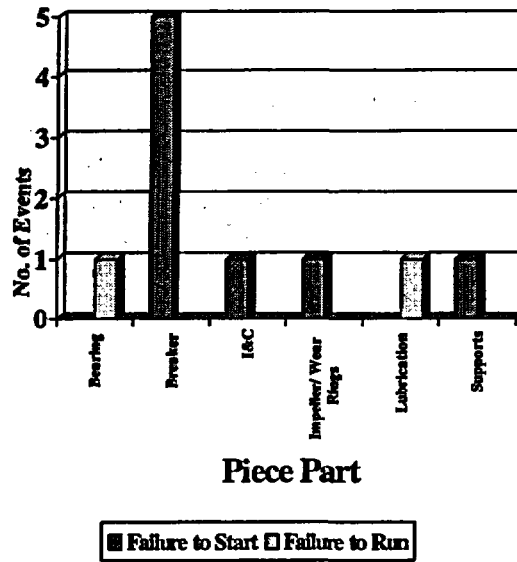

Figure 5-23. Piece part distribution for the RHR-B system.

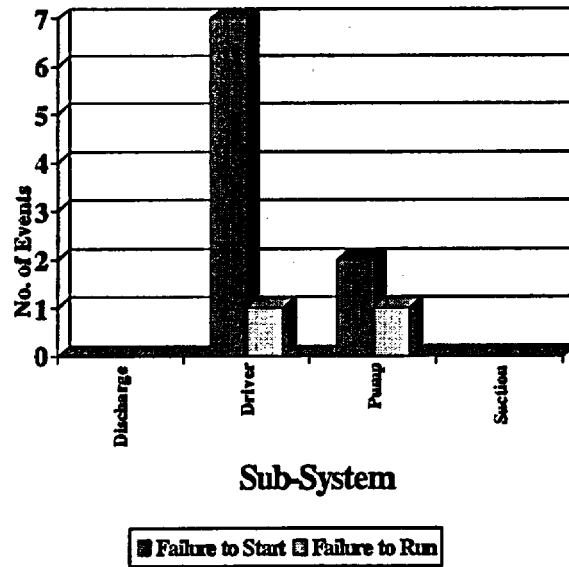

Figure 5-24. Segment distribution for the RHR-B system.

5.8 Other Systems

Three pump CCF events affected pumps in the CSS, HCI/RCI, and LCS systems. The small number of events in these systems precludes the presentation of CCF parameter charts. These events are included in this study since they are of interest. All of the events for these systems were Complete. The CSS event (Appendix C, Table C-1, item 39) involved the removal of control power prior to mode change. The HCI/RCI event (Appendix C, Table C-1, item 183) involved failure of both systems due to overfilling the reactor vessel, which filled the steam supply lines with water. The HCI count is low because it requires coincident failure of RCI. Most HCI failures were independent or RCI. In the LCS system (Appendix C, Table C-1, item 229), the CCF event involved improperly wired relays, which prevented auto start of the pumps under certain conditions.

6. HOW TO OBTAIN MORE DETAILED INFORMATION

The pump CCF insights for the U.S. plants are derived from information contained in the CCF Database maintained for the NRC by the INEEL. The database contains CCF-related events that have occurred in U.S. commercial nuclear power plants reported in LERs, NPRDS failure records, and EPIX failure records. The NPRDS and EPIX information is proprietary. Thus, the information presented in the report has been presented in such a way to keep the information proprietary.

The subset of the CCF database presented in this volume is based on the pump component data from 1980 through 2000. The information contained in the CCF Database consists of coded fields and a descriptive narrative taken verbatim from LERs or NPRDS/EPIX failure records. The database was searched on component type (MDP and TDP) and failure mode. The failure modes selected were fail-to-start and fail-to-run. The additional fields, (e.g., proximate cause, coupling factor, shared cause factor, and component degradation values), along with the information contained in the narrative, were used to glean the insights presented in this report. The detailed records and narratives can be obtained from the CCF Database and from respective LERs and NPRDS/EPIX failure records.

The CCF Database was designed so that information can be easily obtained by defining searches. Searches can be made on any coded fields. That is, plant, date, component type, system, proximate cause, coupling factor, shared cause factor, reactor type, reactor vendor, CCCG size, defensive mechanism, degree of failure, or any combination of these coded fields. The results for most of the figures in the report can be obtained or a subset of the information can be obtained by selecting specific values for the fields of interest. The identified records can then be reviewed and reports generated if desired. To obtain access to the NRC CCF Database, contact Dale Rasmuson at the NRC or Ted Wood at the INEEL.

7. REFERENCES

1. U.S. Nuclear Regulatory Commission, *A Prioritization of Safety Issues*, Generic Issue 145, NUREG-0933, April 1999.
2. U.S. Nuclear Regulatory Commission, *Common-Cause Failure Database and Analysis System Volume 1 - Overview*, NUREG/CR-6268, June 1998, INEEL/EXT-97-00696.
3. U.S. Nuclear Regulatory Commission, *Common-Cause Failure Database and Analysis System Volume 2 - Event Definition and Classification*, NUREG/CR-6268, June 1998, INEEL/EXT-97-00696.
4. U.S. Nuclear Regulatory Commission, *Common-Cause Failure Database and Analysis System Volume 3 - Data Collection and Event Coding*, NUREG/CR-6268, June 1998, INEEL/EXT-97-00696.
5. U.S. Nuclear Regulatory Commission, *Common-Cause Failure Database and Analysis System Volume 4 - CCF Software Reference Manual*, NUREG/CR-6268, July 1997, INEEL/EXT-97-00696.
6. U.S. Nuclear Regulatory Commission, *Common-Cause Failure Parameter Estimations*, NUREG/CR-5497, May 1998, INEEL/EXT-97-01328.
7. U.S. Nuclear Regulatory Commission, *A Cause-Defense Approach to the Understanding and Analysis of Common-cause Failures*, NUREG/CR-5460, March 1990, SAND89-2368.
8. U.S. Nuclear Regulatory Commission, *Individual Plant Examination Program: Perspectives on Reactor Safety and Plant Performance*, NUREG-1560, December 1997.
9. Idaho National Engineering and Environmental Laboratory, *Standardized Plant Analysis Risk (SPAR) Models, Rev 3 Series*, developed under Job Code Number W6467.
10. U.S. Nuclear Regulatory Commission, *Problems with Service Water Systems Affecting Safety-Related Components*, Generic Letter 89-13, April 4, 1990.
11. U.S. Nuclear Regulatory Commission, *Guidance on Developing Acceptable Inservice Testing Programs*, Generic Letter 89-04, April 3, 1989.

Appendix A
Data Summary

Appendix A

Data Summary

This appendix is a summary of the data evaluated in the common-cause failure (CCF) data collection effort for pumps. The tables in this appendix support the charts in Chapter 3. Each table is sorted alphabetically, by the first four columns.

Appendix A

Table A-1. Pump CCF event summary, sorted by proximate cause.....	3
Table A-2. Pump CCF event summary, sorted by coupling factor.....	25
Table A-3. Pump CCF events, sorted by the method of discovery.....	48

Table A-1. Pump CCF event summary, sorted by proximate cause.

Item	Proximate Cause	Coupling Factor	Segment	Discovery Method	Piece Part	System	Year	Failure Mode	Degree of Failure	Description
1	Design/ Construction/ Manufacture/ Installation Inadequacy	Design	Discharge	Demand	Valve	AFW	1986	Failure to Start	Partial	Both the turbine driven and motor driven AFW pumps could not produce full flow because the cages in their discharge valve trapped debris and plugged.
2	Design/ Construction/ Manufacture/ Installation Inadequacy	Design	Discharge	Demand	Valve	AFW	1985	Failure to Start	Partial	Controller problems in the steam and diesel driven AFW pumps caused the pumps to trip on low suction pressure. The pump discharge flow controller valves were also not set properly after last maintenance. Low suction trips were due to design error.
3	Design/ Construction/ Manufacture/ Installation Inadequacy	Design	Driver	Demand	Lubrication	RHR-P	2000	Failure to Run	Complete	Both RHR/LPI pumps fail to run due to improper oil in system. High bearing temperatures occurred when the pumps were operated. This was due to the wrong lube oil being used, which had too high a viscosity. Inadequate vendor design information resulted in the higher viscosity oil being used and additional exacerbating problems such as insufficient bearing clearances.
4	Design/ Construction/ Manufacture/ Installation Inadequacy	Design	Driver	Demand	I&C	AFW	1981	Failure to Start	Almost Complete	Two AFW pumps failed to automatically start due to low suction pressure trips. A modification was installed to prevent this. This effect was discovered previously, but apparently had not been corrected prior to an attempt to start the pumps three weeks later.
5	Design/ Construction/ Manufacture/ Installation Inadequacy	Design	Driver	Demand	I&C	AFW	1997	Failure to Run	Partial	One actual AFW pump failure due to spurious electronic overspeed trip. Determined that all three pumps were susceptible to spurious overspeed trips.
6	Design/ Construction/ Manufacture/ Installation Inadequacy	Design	Driver	Demand	I&C	AFW	1981	Failure to Start	Almost Complete	A modification to the control instrumentation for two AFW pumps resulted in a backfeed situation such that when called upon to start, both pumps would not start.
7	Design/ Construction/ Manufacture/ Installation Inadequacy	Design	Driver	Inspection	I&C	AFW	1994	Failure to Start	Partial	Single failure would prevent auto initiation of AFW. Circuit design did not provide separation required by standards and code. The single failure identified was a short circuit across two conductors of the actuation relays associated with the initiation logic matrix.
8	Design/ Construction/ Manufacture/ Installation Inadequacy	Design	Driver	Inspection	Lubrication	HPI	2000	Failure to Run	Partial	CVC makeup oil pump motor too small for certain accidents.

Item	Proximate Cause	Coupling Factor	Segment	Discovery Method	Piece Part	System	Year	Failure Mode	Degree of Failure	Description
9	Design/ Construction/ Manufacture/ Installation Inadequacy	Design	Driver	Inspection	Supports	RHR-B	1986	Failure to Start	Partial	RHR motor internal supports were cracked due to stress and vibration. Design improvements were made.
10	Design/ Construction/ Manufacture/ Installation Inadequacy	Design	Driver	Maintenance	I&C	HPI	1996	Failure to Run	Partial	A lead was lifted in an emergency bus DC control circuit resulting in one charging pump tripping while running on the alternate power supply. Further investigation into this event revealed an anomaly, which could result in having no operating charging pumps. The cause of the event has been determined to be an error in the original design of the charging pump interlock logic. The anomaly would occur upon a loss of the DC control power to one emergency bus if 'C' charging pump was powered from the other bus.
11	Design/ Construction/ Manufacture/ Installation Inadequacy	Design	Driver	Maintenance	I&C	HPI	1996	Failure to Run	Partial	A lead was lifted in an emergency bus DC control circuit resulting in one charging pump tripping while running on the alternate power supply. Further investigation into this event revealed an anomaly, which could result in having no operating charging pumps. The cause of the event has been determined to be an error in the original design of the charging pump interlock logic. The anomaly would occur upon a loss of the DC control power to one emergency bus if 'C' charging pump was powered from the other bus.
12	Design/ Construction/ Manufacture/ Installation Inadequacy	Design	Driver	Test	I&C	AFW	1981	Failure to Start	Almost Complete	Two low suction pressure trips for the AFW pumps were mis-calibrated, which prevented the pumps from starting.
13	Design/ Construction/ Manufacture/ Installation Inadequacy	Design	Driver	Test	I&C	AFW	1992	Failure to Start	Complete	A modification design error (in 1983-1984) removed a start permissive interlock contact. At cold shutdown this de-energized the auxiliary lube oil pump, consequently, when one AFW pump was started it ran for 2.5 seconds and tripped on low oil pressure. Further investigation showed that both units AFW pumps would be affected in the same way. The design error combined with insufficient post modification testing led to this CCF event.
14	Design/ Construction/ Manufacture/ Installation Inadequacy	Design	Driver	Test	Breaker	HPI	1980	Failure to Start	Partial	Upon testing the safety injection pumps it was found that the 6900-v breakers would lock-out preventing pump start if they were given a close signal for >0.32 seconds when a trip condition existed. There is no indication to operations when this locked-out condition exists. The breaker appears to be available for service when it actually is not. The only means of clearing the condition is to remove and reinstall the fuses at the breaker or manually change the state of the relays.
15	Design/ Construction/ Manufacture/ Installation Inadequacy	Design	Pump	Demand	Impeller/Wear Rings	ESW	1986	Failure to Run	Partial	All four emergency service water pumps showed cavitation damage. Two of the pumps had minor damage and were placed back in service. Recirculation cavitation occurs at flows significantly less than design.
16	Design/ Construction/ Manufacture/ Installation Inadequacy	Design	Pump	Demand	Impeller/Wear Rings	ESW	1981	Failure to Run	Complete	Both charging pump service water pumps failed. A carbon cap screw failed allowing the impeller of one pump to bind on the casing. The ensuing leakage shorted the motor windings of the other pump.

Item	Proximate Cause	Coupling Factor	Segment	Discovery Method	Piece Part	System	Year	Failure Mode	Degree of Failure	Description
17	Design/ Construction/ Manufacture/ Installation Inadequacy	Design	Pump	Demand	Impeller/Wear Rings	ESW	1996	Failure to Run	Partial	A Nuclear Service Water pump tripped on overcurrent after operating for approximately 20 minutes. Initial troubleshooting indicated that the pump was binding and disassembly was required to determine the cause. It was determined that the pump impeller thrust ring had become loose due to thrust ring retainer bolt failure, which allowed the impeller to slip on the shaft and resulted in pump binding and the overcurrent condition. The bolts failed due to corrosion. Similar bolt degradation was discovered on other service water pumps. The investigation results indicate the primary cause of the bolt failures was corrosion induced by galvanic coupling of the retainer bolting and other pump components.
18	Design/ Construction/ Manufacture/ Installation Inadequacy	Design	Pump	Test	Shaft	AFW	1988	Failure to Run	Partial	The AFW pumps were susceptible to corrosion cracking of their bushings. A different material was needed for the bushings.
19	Design/ Construction/ Manufacture/ Installation Inadequacy	Design	Pump	Test	Coupling	ESW	1994	Failure to Start	Partial	Pump produced no flow when started. A shaft coupling failed. Material was determined to be brittle and have low impact properties. The coupling was replaced on all pumps with a type of material more suitable for this application.
20	Design/ Construction/ Manufacture/ Installation Inadequacy	Design	Pump	Test	Shaft	AFW	1988	Failure to Run	Almost Complete	An auxiliary feedwater pump failed its performance test. Subsequent inspection of the pump internals revealed significant damage, including a split in the center shaft sleeve. The AFW pumps were susceptible to corrosion cracking of their bushings. A different material was needed for the bushings.
21	Design/ Construction/ Manufacture/ Installation Inadequacy	Design	Suction	Demand	Piping	ESW	1982	Failure to Run	Complete	The use of service water by the chillers can cause a loss of suction pressure to the charging pump service water pumps.
22	Design/ Construction/ Manufacture/ Installation Inadequacy	Design	Suction	Demand	Piping	ESW	1983	Failure to Run	Almost Complete	Increased flow to chillers resulted in loss of NPSH to Charging Pump Service Water pumps.
23	Design/ Construction/ Manufacture/ Installation Inadequacy	Design	Suction	Demand	Piping	ESW	1982	Failure to Run	Complete	Increased flow to chillers resulted in loss of NPSH to Charging Water Service Water pumps.
24	Design/ Construction/ Manufacture/ Installation Inadequacy	Design	Suction	Demand	Piping	ESW	1983	Failure to Run	Complete	Increased flow to chillers resulted in loss of NPSH to Charging Water Service Water pumps.

Item	Proximate Cause	Coupling Factor	Segment	Discovery Method	Piece Part	System	Year	Failure Mode	Degree of Failure	Description
25	Design/ Construction/ Manufacture/ Installation Inadequacy	Design	Suction	Demand	Piping	ESW	1982	Failure to Run	Almost Complete	Increased flow to chillers resulted in loss of NPSH to Charging Water Service Water pumps.
26	Design/ Construction/ Manufacture/ Installation Inadequacy	Design	Suction	Demand	Piping	ESW	1981	Failure to Run	Complete	Increased flow to chillers resulted in loss of NPSH to Charging Water Service Water pumps.
27	Design/ Construction/ Manufacture/ Installation Inadequacy	Design	Suction	Demand	Piping	ESW	1982	Failure to Run	Complete	The use of service water by the chillers can cause a loss of suction pressure to the charging pump service water pumps.
28	Design/ Construction/ Manufacture/ Installation Inadequacy	Design	Suction	Demand	Piping	ESW	1982	Failure to Run	Complete	The use of service water by the chillers can cause a loss of suction pressure to the Charging Water Service Water pumps.
29	Design/ Construction/ Manufacture/ Installation Inadequacy	Design	Suction	Demand	Piping	ESW	1996	Failure to Start	Partial	Freezing of diesel generator service water piping in intake bay. Inadequate initial design.
30	Design/ Construction/ Manufacture/ Installation Inadequacy	Design	Suction	Demand	Piping	ESW	1981	Failure to Run	Complete	Increasing flow to chillers robs NPSH from charging service water pumps.
31	Design/ Construction/ Manufacture/ Installation Inadequacy	Design	Suction	Inspection	Piping	HPI	1988	Failure to Run	Partial	Ultrasonic examination of the chemical and volume control system suction piping was performed. These examinations revealed voids in the suction piping.
32	Design/ Construction/ Manufacture/ Installation Inadequacy	Design	Suction	Inspection	Piping	HPI	1991	Failure to Start	Partial	Ultrasonic examination of the chemical and volume control system suction piping was performed. These examinations revealed voids in the alternate boration line and the gravity feed line from the boric acid storage tank.
33	Design/ Construction/ Manufacture/ Installation Inadequacy	Design	Suction	Inspection	Piping	HPI	1988	Failure to Start	Partial	It was determined that various pipes of the safety injection system and chemical volume and control system collected or trapped gas which might affect the functions of these systems. There was a concern that the gas pockets may adversely effect pump operation. Voids were detected in some of the high head SI pump piping.

Item	Proximate Cause	Coupling Factor	Segment	Discovery Method	Piece Part	System	Year	Failure Mode	Degree of Failure	Description
34	Design/ Construction/ Manufacture/ Installation Inadequacy	Design	Suction	Inspection	Piping	HPI	1990	Failure to Start	Partial	A quantity of gas was found in the centrifugal charging pump suction header that exceeded the maximum allowed gas volume. It was subsequently determined that hydrogen gas had been coming out of solution on both units and accumulating in the suction piping as a probable result of gas stripping by the CCP miniflow orifices. In addition, entrainment of hydrogen bubbles from the volume control tank to the CCP suction pipe may be a contributor as well.
35	Design/ Construction/ Manufacture/ Installation Inadequacy	Design	Suction	Maintenance	Tank	ESW	1985	Failure to Run	Partial	An engineering evaluation revealed that ESW had been inoperable several times due to low NPSH. All three units were affected.
36	Design/ Construction/ Manufacture/ Installation Inadequacy	Design	Suction	Maintenance	Tank	ESW	1990	Failure to Run	Partial	An engineering evaluation revealed that ESW had been inoperable several times due to low NPSH. All three units were affected.
37	Design/ Construction/ Manufacture/ Installation Inadequacy	Design	Suction	Maintenance	Tank	ESW	1990	Failure to Run	Partial	An engineering evaluation revealed that ESW had been inoperable several times due to low NPSH. All three units were affected.
38	Design/ Construction/ Manufacture/ Installation Inadequacy	Design	Suction	Maintenance	Tank	ESW	1985	Failure to Run	Partial	An engineering evaluation revealed that ESW had been inoperable several times due to low NPSH. All three units were affected.
39	Design/ Construction/ Manufacture/ Installation Inadequacy	Design	Suction	Maintenance	Tank	ESW	1990	Failure to Run	Partial	An engineering evaluation revealed that ESW had been inoperable several times due to low NPSH. All three units were affected.
40	Design/ Construction/ Manufacture/ Installation Inadequacy	Design	Suction	Maintenance	Tank	ESW	1985	Failure to Run	Partial	An engineering evaluation revealed that ESW had been inoperable several times due to low NPSH. All three units were affected.
41	Design/ Construction/ Manufacture/ Installation Inadequacy	Design	Suction	Test	Tank	SLC	1991	Failure to Run	Complete	During the performance of a special test on the available NPSH of the SLC pumps, the pumps began to cavitate unexpectedly. The SLC systems of both units were declared inoperable. The causes of this event are inadequate modification testing and an error in the original design calculations.

Item	Proximate Cause	Coupling Factor	Segment	Discovery Method	Piece Part	System	Year	Failure Mode	Degree of Failure	Description
42	Design/ Construction/ Manufacture/ Installation Inadequacy	Design	Suction	Test	Tank	SLC	1991	Failure to Run	Complete	During the performance of a special test on Unit 1 to determine the available NPSH of the SLC pumps, the pumps began to cavitate unexpectedly. The SLC systems of both units were declared inoperable. The causes of this event are inadequate modification testing and an error in the original design calculations.
43	Design/ Construction/ Manufacture/ Installation Inadequacy	Design	Suction	Test	Piping	AFW	1999	Failure to Run	Partial	All AFW trains declared inoperable due to inadequate suction flow capability from the nuclear service water alternate source. Inadequate flow caused by corroded piping. Piping is undersized so there is little margin for piping degradation. Since this is 1 of 4 suction sources, the safety significance is limited.
44	Design/ Construction/ Manufacture/ Installation Inadequacy	Design	Suction	Test	Valve	ESW	1983	Failure to Start	Partial	Low discharge pressure was caused by insufficient suction pressure. Service water flow to parallel components was adjusted.
45	Design/ Construction/ Manufacture/ Installation Inadequacy	Design	Suction	Test	Tank	ESW	1986	Failure to Run	Complete	Loss of prime in the condenser circulating water siphon flow system caused loss of low pressure service water pumps. Pumps lost suction during a test due to poor design.
46	Design/ Construction/ Manufacture/ Installation Inadequacy	Environmental	Driver	Inspection	Piping	HPI	2000	Failure to Run	Partial	Microbiologically induced corrosion leak on service water lines to two charging/HPI pump lube oil coolers.
47	Design/ Construction/ Manufacture/ Installation Inadequacy	Environmental	Pump	Demand	Impeller/Wear Rings	ESW	2000	Failure to Start	Almost Complete	Two of the River Water pumps tripped on overcurrent when they were attempted to be started. The trips were a result of physical contact between the impeller and the lower casing liner of the pumps. This condition was due to differential thermal expansion between the pump shaft and the pump casing as a result of an elevated seal injection water temperature. The elevated temperature was due to an abnormal configuration of the Filtered Water System (the backup seal water supply).
48	Design/ Construction/ Manufacture/ Installation Inadequacy	Environmental	Pump	Inspection	Lubrication	HPI	1995	Failure to Run	Partial	High lube oil temperatures were observed during HPI pump operation. Zinc particles from anode were discovered plugging the lube oil coolers. Accelerated corrosion was attributed to a corrosion inhibitor that was added to the system, which chemically interacted with the zinc.
49	Design/ Construction/ Manufacture/ Installation Inadequacy	Environmental	Pump	Test	Coupling	ESW	1987	Failure to Start	Partial	Test showed two ESW pumps failed. Pump shafts were corroded and found to be made of incorrect material.

Item	Proximate Cause	Coupling Factor	Segment	Discovery Method	Piece Part	System	Year	Failure Mode	Degree of Failure	Description
50	Design/ Construction/ Manufacture/ Installation Inadequacy	Environmental	Suction	Inspection	Strainer	ESW	2000	Failure to Run	Partial	RHRWSW Pumps Failed to Develop flow/pressure. Debris in intake structure. Requires modifications to the traveling Water Screen.
51	Design/ Construction/ Manufacture/ Installation Inadequacy	Maintenance	Pump	Inspection	Packing/Seals	ESW	1997	Failure to Run	Partial	Both ESW pumps leaking greater than 4 gpm because of inappropriate material for packing and sleeve (nitronic 60).
52	Design/ Construction/ Manufacture/ Installation Inadequacy	Maintenance	Pump	Test	Impeller/Wear Rings	ESW	1988	Failure to Start	Partial	Essential service water pumps were declared inoperable, due to low pump head valves. The low pump heads were caused by excessive wear of pump impeller due to foreign material in the service water.
53	Design/ Construction/ Manufacture/ Installation Inadequacy	Maintenance	Pump	Test	Casing	ESW	1997	Failure to Run	Almost Complete	Both ESW pumps failed due to installation of wrong material for pump casing flanges by vendor during pump overhaul. The vendor overhauled the pumps without changing material. The plant returned the pumps to the warehouse also without verifying material.
54	Design/ Construction/ Manufacture/ Installation Inadequacy	Maintenance	Suction	Demand	I&C	HPI	1997	Failure to Run	Complete	HPI pumps fail due to operation with inadequate suction head. Two pumps damaged due to operation with inadequate suction, but all three system pumps were unavailable due to the loss of the suction source. Suction source level instrumentation was the cause.
55	Design/ Construction/ Manufacture/ Installation Inadequacy	Operational	Discharge	Test	Check Valve	ESW	1999	Failure to Run	Partial	Two ESW pumps had low flow due to interaction with the two other pumps when all four pumps were running.
56	Design/ Construction/ Manufacture/ Installation Inadequacy	Quality	Driver	Demand	I&C	AFW	1989	Failure to Start	Complete	Both motor driven auxiliary feedwater pumps failed to start when the operator tried to start them manually. While preparing a design change, the designer failed to review all the unit specific documentation associated with the motor-driven AFW pump wiring and made the erroneous assumption that both units switchgear compartment internal wiring was identical. In fact, the wiring for each unit was different. Consequently, when the design change was installed, it was installed in accordance with the erroneous design. The wiring discrepancy was corrected and the motor-driven AFW pumps were tested and returned to service.
57	Design/ Construction/ Manufacture/ Installation Inadequacy	Quality	Driver	Demand	Breaker	ESW	1996	Failure to Start	Partial	Two RHRWSW pumps fail to start due to breaker failures. Wrong contacts were installed. Design called for contacts to have a minimum current interrupt rating of 6 amps; contacts installed (that subsequently failed) had current interrupt rating of only 2.2 amps.

Item	Proximate Cause	Coupling Factor	Segment	Discovery Method	Piece Part	System	Year	Failure Mode	Degree of Failure	Description
58	Design/ Construction/ Manufacture/ Installation Inadequacy	Quality	Driver	Demand	Motor	ESW	1987	Failure to Start	Partial	ESW pump motors tripped on overcurrent. The overcurrent trip was due to a ground and a short on the pump motor.
59	Design/ Construction/ Manufacture/ Installation Inadequacy	Quality	Driver	Test	Breaker	LCS	1980	Failure to Start	Complete	Relay extra contacts left connected during construction, prevented Core Spray pump start with emergency diesel generator breakers racked out.
60	Design/ Construction/ Manufacture/ Installation Inadequacy	Quality	Driver	Test	I&C	AFW	1980	Failure to Start	Complete	During surveillance testing, neither motor-driven AFW pump would start. The pump control circuit was found with autostart defeat switches labeled backwards, causing all autostarts except the low-low steam generator level to be defeated. The labels were corrected and the links were closed. The original installation error was the result of an inadequate design change process that did not require sufficient verification and testing of the modification.
61	Design/ Construction/ Manufacture/ Installation Inadequacy	Quality	Pump	Demand	Impeller/Wear Rings	ESW	1988	Failure to Run	Partial	ESW pumps drawing excessive current. Carbon steel snap rings corroded allowing impeller to come in contact with casing. The third pump, although not exhibiting abnormal current, had similar corrosion
62	Design/ Construction/ Manufacture/ Installation Inadequacy	Quality	Pump	Demand	Impeller/Wear Rings	ESW	1996	Failure to Run	Partial	A Nuclear Service Water pump tripped on overcurrent after operating for approximately 20 minutes. Initial troubleshooting indicated that the pump was binding and disassembly was required to determine the cause. It was determined that the pump impeller thrust ring had become loose due to thrust ring retainer bolt failure, which allowed the impeller to slip on the shaft and resulted in pump binding and the overcurrent condition. The bolts failed due to corrosion. Similar bolt degradation was discovered on other service water pumps. The investigation results indicate the primary cause of the bolt failures was corrosion induced by galvanic coupling of the retainer bolting and other pump components.
63	Design/ Construction/ Manufacture/ Installation Inadequacy	Quality	Pump	Inspection	Casing	AFW	1983	Failure to Run	Partial	Two AFW pumps thrust tolerance was out of specification. These events were caused by improperly installed balancing drum parts. One turbine driven and one motor driven pump was involved.
64	Design/ Construction/ Manufacture/ Installation Inadequacy	Quality	Pump	Inspection	Casing	HPI	1987	Failure to Run	Partial	During inspection of a centrifugal charging pump, a portion of the stainless steel cladding on the inside surface of the pump casing exhibited corrosion. Corrosion of the pump casing was through the stainless steel cladding into the carbon steel base material. Inspection of the other CCP revealed similar corrosion. The cause of this event was a manufacturing deficiency. Corrosion observed at the pump casing discharge nozzle was attributed to a cladding breakthrough during final machining. Corrosion observed at the pump casing inlet end was attributed to either over-machining of the cladding or inadequate overlay of two adjacent weld beads.

Item	Proximate Cause	Coupling Factor	Segment	Discovery Method	Piece Part	System	Year	Failure Mode	Degree of Failure	Description
65	Design/ Construction/ Manufacture/ Installation Inadequacy	Quality	Pump	Test	Impeller/Wear Rings	ESW	1986	Failure to Start	Partial	Testing of the service water system disclosed that the performance of the three service water pumps was below requirements. The condition is the result of both an inadequate system design and the installation of replacement impellers, which were not modified by the vendor to improve performance, as were the original impellers.
66	Design/ Construction/ Manufacture/ Installation Inadequacy	Quality	Suction	Demand	Piping	ESW	1984	Failure to Start	Partial	Both RHR service water pumps tripped as a result of inadequate venting of suction header resulting from poor orientation of the vent line.
67	Design/ Construction/ Manufacture/ Installation Inadequacy	Quality	Suction	Inspection	Piping	HPI	1988	Failure to Run	Partial	Vortex breakers had not been installed in the containment emergency sumps. Vortex breakers are required to be installed in the containment emergency sumps to prevent the formation of vortices which could adversely affect performance of safety injection pumps during the safety injection and containment spray systems were declared inoperable.
68	External Environment	Design	Discharge	Demand	Check Valve	AFW	1983	Failure to Start	Almost Complete	Hot water in the AFW pump casings caused the pumps to become vapor bound. The hot water was from leaking check valves upstream of the pumps. This event occurred once on the turbine driven pump and 5 times on the motor driven pump.
69	External Environment	Design	Discharge	Inspection	Piping	HPI	1994	Failure to Run	Partial	Due to a leaking socket weld in the common recirculation line, all three SI pumps were declared inoperable. The underlying cause of the leak was a crack in the socket weld in the common recirculation line, caused by pipe displacement from air entrainment and pump misalignment.
70	External Environment	Design	Pump	Inspection	Bearing	HPI	1991	Failure to Run	Almost Complete	Charging/safety pumps beyond operational limits. Damage was found to the thrust bearings. Air was introduced into this train of chilled water during modifications and testing being performed on the system. This air became trapped in high points of either, or both of, the supply and return chilled water lines to the charging pump. At the reduced flow rate, sufficient cooling was not available and oil temperature increased to the point where bearing damage occurred.
71	External Environment	Environmental	Discharge	Test	Recirc	HPI	1992	Failure to Run	Almost Complete	Safety Injection pumps were declared inoperable due to an observed declining trend in the pump's recirculation flow. The cause of the Safety Injection pump reduced recirculation flow is attributed to foreign material blockage within the associated minimum flow recirculation line flow orifice.
72	External Environment	Environmental	Driver	Demand	Motor	ESW	1985	Failure to Run	Partial	Two service water motors failed on demand as a result of cement dust contamination.
73	External Environment	Environmental	Driver	Demand	I&C	AFW	1984	Failure to Start	Complete	Both AFW pumps failed to start. The problem was traced to two relays (1 per pump). Examination of the relays revealed open circuiting and severe degradation of the insulation.
74	External Environment	Environmental	Driver	Maintenance	Motor	ESW	1987	Failure to Start	Partial	During an extended service water bay flooding incident, one ESW pump was found grounded by testing, later two more pumps were found to be failed also.
75	External Environment	Environmental	Driver	Test	Bearing	RHR-B	1991	Failure to Run	Partial	Two LCI pumps were declared inoperable due to high motor vibration.
76	External Environment	Environmental	Pump	Inspection	Coupling	ESW	1993	Failure to Run	Partial	Entrained debris caused ESW pump shaft coupling to fail. Plant equipment did not prevent this debris from entering pump.

Item	Proximate Cause	Coupling Factor	Segment	Discovery Method	Piece Part	System	Year	Failure Mode	Degree of Failure	Description
77	External Environment	Environmental	Pump	Inspection	Packing/Seals	RHR-P	1985	Failure to Start	Complete	Following a trip, water was found spraying from both low head safety injection pump wedge control rod seals. Both pumps were declared inoperable. Postulated failure on the seals was from a minor flow induced pressure transient.
78	External Environment	Environmental	Suction	Demand	Piping	HPI	1984	Failure to Start	Complete	Boron solidification in the suction and gas binding of pumps led to the failure of all three safety injection pumps. Flushing procedures inadequate.
79	External Environment	Maintenance	Driver	Demand	Breaker	AFW	1990	Failure to Run	Partial	AFW pumps circuit breakers degraded.
80	External Environment	Operational	Driver	Inspection	I&C	HPI	1990	Failure to Run	Complete	It was determined that the common minimum flow path return line for the safety injection pumps to the refueling water storage tank was frozen. Previous actions to investigate problems with the freeze protection system were unsuccessful in preventing development of this condition. The two HPI pumps were declared inoperable with this return line frozen. A faulty ambient temperature switch for the RWST heat trace system prevented the heat trace from activating and was subsequently replaced. In addition, administrative controls did not sufficiently recognize the safety significance of flow through this line and the need to ensure flow capability.
81	Internal to Component	Design	Driver	Demand	Breaker	ESW	2000	Failure to Start	Almost Complete	Two ESW pumps failed to start due to their breakers failing to close. The breakers' prop spring bracket has slipped thus preventing proper interfacing between the prop and the prop pin.
82	Internal to Component	Design	Driver	Inspection	I&C	ESW	1982	Failure to Start	Partial	Open circuit breaker resulted in loss of two RHR service water pumps.
83	Internal to Component	Design	Pump	Inspection	Lubrication	HPI	1981	Failure to Run	Partial	Corrosion of HPI pump cooler heads. Improper material led to corrosion
84	Internal to Component	Environmental	Discharge	Demand	Valve	AFW	1988	Failure to Run	Partial	After automatic start, motor driven AFW pump swapped suction automatically to the nuclear service water system when a sustained low suction pressure condition was sensed, and raw water entered two steam generators. After the initial trip recovery, it was noted that AFW flow to steam generators had degraded following the suction swap. Inspections revealed that the cavitrol cages for these valves were clogged with shredded Asiatic clam shells.
85	Internal to Component	Environmental	Discharge	Demand	Valve	AFW	1988	Failure to Run	Partial	After automatic start, motor driven AFW pump swapped suction automatically to the nuclear service water system when a sustained low suction pressure condition was sensed, and raw water entered two steam generators. After the initial trip recovery, it was noted that AFW flow to steam generators had degraded following the suction swap. Inspections revealed that the cavitrol cages for these valves were clogged with shredded Asiatic clam shells.
86	Internal to Component	Environmental	Discharge	Test	Recirc	HPI	1991	Failure to Run	Partial	Something in HPI pump recirculation line was restricting flow. The piece later dislodged and no identification was made. Both SI pumps had inadequate recirculation flow.
87	Internal to Component	Environmental	Pump	Demand	Impeller/Wear Rings	ESW	1994	Failure to Run	Partial	Raw water pump currents stayed high after starting. The primary cause of these events was determined to be elevated sand content in the river, resulting in excessive sand accumulation around the suction area of the pumps.
88	Internal to Component	Environmental	Pump	Inspection	Impeller/Wear Rings	ESW	1990	Failure to Start	Partial	ESW pumps had reduced flow and discharge pressure. Marine growth in suction.
89	Internal to Component	Environmental	Pump	Inspection	Lubrication	HPI	1983	Failure to Run	Partial	Oysters and miscellaneous mollusks plugged HPI oil coolers. Two pumps were required to be shutdown due to rising lubricating oil temperatures.

Item	Proximate Cause	Coupling Factor	Segment	Discovery Method	Piece Part	System	Year	Failure Mode	Degree of Failure	Description
90	Internal to Component	Environmental	Pump	Inspection	Packing/Seals	ESW	1994	Failure to Run	Partial	Backup seal water regulators did not provide required flow during testing on two pumps. The third pump lost seal flow while operating. The cause was attributed to plugged lines.
91	Internal to Component	Environmental	Pump	Maintenance	Packing/Seals	ESW	1985	Failure to Run	Partial	First pump developed seal leak due to sand. Second pump had high bearing temperatures due to trash clogging cooling water lines.
92	Internal to Component	Environmental	Pump	Maintenance	Lubrication	HPI	1980	Failure to Run	Partial	HPI pump lube oil cooler with tube leak allowed water into oil reservoir.
93	Internal to Component	Environmental	Pump	Maintenance	Lubrication	HPI	1986	Failure to Run	Almost Complete	Clams/sludge fouling of lube oil cooler caused high temperature alarms on two HPI pumps.
94	Internal to Component	Environmental	Pump	Maintenance	Lubrication	HPI	1991	Failure to Run	Partial	HPI pump lube oil cooler leaks. Degraded tubes.
95	Internal to Component	Environmental	Pump	Test	Bearing	ESW	1992	Failure to Run	Partial	Abrasive particles present in ocean water produced accelerated wear of shaft bearing journals.
96	Internal to Component	Environmental	Pump	Test	Impeller/Wear Rings	HPI	1984	Failure to Run	Almost Complete	One HPI pump seized, the second would have seized if operated.
97	Internal to Component	Environmental	Pump	Test	Impeller/Wear Rings	ESW	1995	Failure to Start	Partial	Marine growth caused low flow and speed condition for two service water pumps
98	Internal to Component	Environmental	Pump	Test	Impeller/Wear Rings	ESW	1985	Failure to Run	Partial	ESW pumps failed to meet the minimum flow requirements of test. A rag was found in one impeller and a plastic bottle in the other.
99	Internal to Component	Environmental	Pump	Test	Impeller/Wear Rings	ESW	1982	Failure to Start	Partial	Essential service water pumps were declared inoperable, due to low pump head valves. The low pump heads were caused by excessive wear of pump impeller due to foreign material in the service water.
100	Internal to Component	Environmental	Pump	Test	Impeller/Wear Rings	ESW	1982	Failure to Run	Partial	Low ESW pump head valves were caused excessive wear of pump impeller due to foreign material in the service water.
101	Internal to Component	Environmental	Pump	Test	Impeller/Wear Rings	ESW	1993	Failure to Run	Partial	Essential service water pumps were declared inoperable, due to low pump head valves. The low pump heads were caused by excessive wear of pump impeller due to sand in the service water.
102	Internal to Component	Environmental	Pump	Test	Impeller/Wear Rings	ESW	1991	Failure to Run	Partial	ESW pumps failed to meet the minimum flow requirements of test. The cause of the failure is normal wearout of the pump impeller due to the high sand content of the water being pumped. Pump impeller lift was adjusted.
103	Internal to Component	Environmental	Pump	Test	Impeller/Wear Rings	ESW	1995	Failure to Start	Partial	Pumps failed performance test. Sand in water eroded pump internals. Pump lift was adjusted.
104	Internal to Component	Environmental	Pump	Test	Impeller/Wear Rings	ESW	1992	Failure to Start	Partial	ESW pumps had reduced flow and discharge pressure. Worn impellers/wearing rings. Cause determined to be normal wear and high sand content of river water.
105	Internal to Component	Environmental	Pump	Test	Impeller/Wear Rings	ESW	1994	Failure to Start	Partial	Degraded performance identified during testing. Sand in water was causing accelerated wear of the pump internals. Lift was adjusted for three pumps and one pump internals were replaced.
106	Internal to Component	Environmental	Pump	Test	Impeller/Wear Rings	ESW	1990	Failure to Run	Partial	ESW pump impeller lift out of adjustment.
107	Internal to Component	Environmental	Suction	Demand	Piping	ESW	1986	Failure to Start	Partial	RHR service water pumps failed flow testing due to blocked suction and abnormal wear of impellers.
108	Internal to Component	Environmental	Suction	Demand	Strainer	ESW	1980	Failure to Run	Partial	Foreign material was allowed to enter the suction of the charging pump service water pumps resulting in low flow conditions.

Item	Proximate Cause	Coupling Factor	Segment	Discovery Method	Piece Part	System	Year	Failure Mode	Degree of Failure	Description
109	Internal to Component	Environmental	Suction	Inspection	Strainer	ESW	1984	Failure to Run	Partial	Two RHR service water pumps had blown seals and sparks and smoke between the bearing housing and shaft. A piece of hard rubber valve liner was found in the pumps.
110	Internal to Component	Environmental	Suction	Test	Strainer	ESW	1990	Failure to Run	Partial	Essential service water pumps were declared inoperable, due to low pump head valves. The low pump heads were caused by suction blockage due to foreign material in the service water.
111	Internal to Component	Environmental	Suction	Test	Piping	ESW	1990	Failure to Start	Partial	ESW pumps failed flow testing. Foreign material blocked the suction.
112	Internal to Component	Environmental	Suction	Test	Strainer	ESW	1982	Failure to Run	Partial	Failures occurred on residual heat removal service water pumps. The pumps failed to meet flow and pressure requirements. Failure was due to debris lodging in pump impellers. Source of debris was maintenance activities, broken traveling water screens, and the inadvertent opening of a RHR minimum flow line which washed materials into suction pit.
113	Internal to Component	Maintenance	Discharge	Inspection	Check Valve	AFW	1990	Failure to Start	Almost Complete	Leakage past AFW check valves caused AFW pumps to become steam bound. Closed motor operated valve in line. Scheduled check valves for replacement next outage.
114	Internal to Component	Maintenance	Discharge	Test	Valve	HPI	1984	Failure to Start	Partial	CCP pump low flow rates due to inaccuracies in positioning the throttle valves.
115	Internal to Component	Maintenance	Driver	Demand	I&C	ESW	1991	Failure to Start	Partial	Two ESW pumps failed to start due to failed breakers. Inadequate maintenance.
116	Internal to Component	Maintenance	Driver	Demand	Breaker	RHR-B	1987	Failure to Start	Partial	RHR pump breakers failed to close when operated remotely from the control room. It was found that the latch roller bearings and the cam follower bearing (internal piece parts of the breaker) were not operating correctly. This prevented the trip latch assembly from resetting and allowing the breaker to close.
117	Internal to Component	Maintenance	Driver	Demand	Lubrication	HPI	1984	Failure to Run	Partial	Charging pump lube oil cooler fan motor trips on thermal overload. Probable cause: normal wear on motor resulting in increased friction replaced worn motor with spare. During routine inservice testing found that another charging pump lube oil cooler fan motor had a current imbalance. Probable cause: normal aging of motor insulation has resulted in a current imbalance.
118	Internal to Component	Maintenance	Driver	Inspection	Bearing	ESW	1981	Failure to Run	Partial	ESW motor to pump alignment problems. Bearings worn out.
119	Internal to Component	Maintenance	Driver	Inspection	Bearing	ESW	1985	Failure to Run	Partial	One service water pump motor upper bearing oil reservoir leaking from cover plate. Another service water pump motor upper oil cooler oil reservoir leaking.
120	Internal to Component	Maintenance	Driver	Inspection	Breaker	ESW	1996	Failure to Start	Partial	ESW pump breakers fail due to misalignment of the breaker mechanism and internals developed over the years of operation.
121	Internal to Component	Maintenance	Driver	Inspection	Packing/Seals	HPI	1988	Failure to Run	Almost Complete	Smoke was discovered coming from the speed increaser unit for a centrifugal charging pump. Investigation found the two gland seal retaining bolts inside the speed increaser lube oil pump backed out allowing the gland seal to loosen. The gland seal being loosened, caused reduced oil flow to the speed increaser internals and ultimate damage. Other CCPs were inspected, and the same gland seal bolts as on the first pump were found loosened. The cause of the bolts backing out was determined to be lack of a periodic adjustment of the gland seal bolts.
122	Internal to Component	Maintenance	Driver	Maintenance	Breaker	ESW	1985	Failure to Start	Partial	Two raw water pump breaker main wipes were out of adjustment.
123	Internal to Component	Maintenance	Driver	Maintenance	Breaker	HPI	1991	Failure to Start	Partial	HPI pump breakers failed due to a broken pawl, and a broken closing coil.

Item	Proximate Cause	Coupling Factor	Segment	Discovery Method	Piece Part	System	Year	Failure Mode	Degree of Failure	Description
124	Internal to Component	Maintenance	Driver	Maintenance	Breaker	AFW	1992	Failure to Start	Partial	With the unit in a refueling outage, following repairs to a motor driven auxiliary feedwater pump local/remote switch of the circuit breaker, personnel found that the switch contacts would not close. This failure rendered one of three auxiliary feedwater pumps inoperable. The cause of the failure appears to be due to dirty/corroded contacts on the switch.
125	Internal to Component	Maintenance	Driver	Maintenance	Breaker	SLC	1999	Failure to Start	Partial	SLC Pump Breakers Fail to pickup on degraded voltage test
126	Internal to Component	Maintenance	Driver	Test	Bearing	ESW	1985	Failure to Run	Partial	Service water pumps exhibited vibration. Attributed to normal wear.
127	Internal to Component	Maintenance	Driver	Test	Breaker	RHR-B	1997	Failure to Start	Partial	Breaker latch check switch failed on both pumps. Lack of lubrication.
128	Internal to Component	Maintenance	Driver	Test	Breaker	ESW	1998	Failure to Start	Partial	Two RHR service water pump breakers would not close due to dirty contacts in breakers.
129	Internal to Component	Maintenance	Driver	Test	Breaker	ESW	1998	Failure to Start	Partial	Service water pumps fail to start due to circuit breaker failures. Pump breakers failed to close due to failures of the charging spring/motor and closing spring motor.
130	Internal to Component	Maintenance	Driver	Test	Breaker	AFW	1997	Failure to Start	Almost Complete	The circuit breakers associated with the AFW Pumps failed to close as required. The root cause of the failure was the binding in the operating mechanism. The plunger apparently did not always complete its upward movement to close and latch the breaker, due to accumulated dirt and lubricants.
131	Internal to Component	Maintenance	Driver	Test	Breaker	RHR-B	1986	Failure to Start	Partial	RHR pump circuit breakers failed during a start for testing. Bend switch and binding mechanism. Attributed to inadequate maintenance.
132	Internal to Component	Maintenance	Pump	Demand	Casing	ESW	1998	Failure to Start	Partial	Two ESW pump started and ran, but would not develop sufficient pressure or flow rate. Exact cause not known for either failure, however, one pump was noted to have microbiological induced corrosion fouling on internal surfaces.
133	Internal to Component	Maintenance	Pump	Demand	Bearing	AFW	1984	Failure to Run	Partial	One ESW bearing failed and pump seized; second motor bearing failed.
134	Internal to Component	Maintenance	Pump	Demand	Packing/Seals	AFW	1998	Failure to Run	Partial	AFW MDP and TDPs failed due to incorrect packing installed.
135	Internal to Component	Maintenance	Pump	Inspection	Packing/Seals	ESW	1989	Failure to Run	Partial	ESW pump excessive packing leakage.
136	Internal to Component	Maintenance	Pump	Inspection	Casing	ESW	1986	Failure to Run	Partial	Cracked seal water and vent lines.
137	Internal to Component	Maintenance	Pump	Inspection	Bearing	ESW	1987	Failure to Run	Partial	Service water pumps had high shaft vibration. The excessive vibrations caused by worn bearings and shaft sleeves.
138	Internal to Component	Maintenance	Pump	Inspection	Packing/Seals	AFW	1990	Failure to Run	Partial	Both motor-driven aux. feedwater pumps had excessive packing leaks, due to worn packing.
139	Internal to Component	Maintenance	Pump	Inspection	Lubrication	RHR-B	1990	Failure to Run	Partial	Both pump motor oil coolers were leaking due to aging of components. The first case involved through wall corrosion and the pump was immediately removed from service. The second case was a packing leak.
140	Internal to Component	Maintenance	Pump	Inspection	Plunger/Cylinder	SLC	1989	Failure to Run	Partial	Standby Liquid Control pump seal was leaking excessively. The cause of this failure was normal wear of the plungers, packing, and head gaskets for the plungers (piece parts of the pump).
141	Internal to Component	Maintenance	Pump	Inspection	Packing/Seals	SLC	1989	Failure to Run	Partial	Standby Liquid Control pumps were observed to be leaking profusely at the packing. The failure of the packing was attributed to normal wear.

Item	Proximate Cause	Coupling Factor	Segment	Discovery Method	Piece Part	System	Year	Failure Mode	Degree of Failure	Description
142	Internal to Component	Maintenance	Pump	Inspection	Packing/Seals	SLC	1987	Failure to Run	Partial	Standby Liquid Control pumps were observed to be leaking excessively at the packing. The failure of the packing was attributed to normal wear. Packing adjusted.
143	Internal to Component	Maintenance	Pump	Inspection	Packing/Seals	ESW	1986	Failure to Run	Partial	Excessive packing leakage. Both events occurred after previous maintenance had been performed for the same problems.
144	Internal to Component	Maintenance	Pump	Inspection	Packing	AFW	1986	Failure to Run	Partial	The packing was worn on both the motor-driven and one turbine-driven aux. feedwater pump, causing high temperature on one packing gland, and excessive leaking on the other pump.
145	Internal to Component	Maintenance	Pump	Inspection	Bearing	SLC	1989	Failure to Run	Partial	Standby Liquid Control pumps lost oil while running. Loose fittings and lack of thread sealant.
146	Internal to Component	Maintenance	Pump	Inspection	Packing/Seals	SLC	1988	Failure to Run	Partial	Standby Liquid Control pumps were observed to be leaking excessively at the packing. The failure of the packing was attributed to normal wear. Packing replaced.
147	Internal to Component	Maintenance	Pump	Inspection	Casing	ESW	1988	Failure to Run	Partial	RHR service water pumps. Pump diffuser eroded on first pump and a through wall casing leak developed on the second.
148	Internal to Component	Maintenance	Pump	Inspection	Impeller/Wear Rings	ESW	1985	Failure to Run	Partial	Service water pumps were noted to have high vibrations and low discharge pressure. The cause of the failure is suspected to be binding.
149	Internal to Component	Maintenance	Pump	Maintenance	Bearing	ESW	1985	Failure to Run	Partial	High ESW pump vibration was caused by wearing of the upper bearings.
150	Internal to Component	Maintenance	Pump	Test	Impeller/Wear Rings	ESW	1986	Failure to Run	Partial	ESW pump performance decreased 15% and 8% respectively since last test. Pumps were replaced.
151	Internal to Component	Maintenance	Pump	Test	Impeller/Wear Rings	ESW	1994	Failure to Run	Partial	Two ESW pumps had internal deterioration, one of which was indicated by high vibration readings.
152	Internal to Component	Maintenance	Pump	Test	Impeller/Wear Rings	ESW	1990	Failure to Start	Partial	ESW impeller gaps too wide. Gaps adjusted.
153	Internal to Component	Maintenance	Pump	Test	Impeller/Wear Rings	HPI	1985	Failure to Start	Partial	The CCPs were tested and had low flow rates. The most probable cause is attributed to observed degradation of the pumps. The CCPs are subject to normal wear associated with their secondary duty of providing normal charging flow.
154	Internal to Component	Maintenance	Pump	Test	Impeller/Wear Rings	ESW	1984	Failure to Run	Partial	Containment spray raw water pumps failed flow tests. Aging and normal wear.
155	Internal to Component	Maintenance	Pump	Test	Impeller/Wear Rings	ESW	1988	Failure to Run	Partial	ESW pumps failed to meet the minimum flow requirements of test. The cause of the failure is normal wearout of the pump impeller due to brackish water corrosion.
156	Internal to Component	Maintenance	Pump	Test	Impeller/Wear Rings	ESW	1984	Failure to Run	Partial	Loss of Service Water pump due to wearout at end of life.
157	Internal to Component	Maintenance	Pump	Test	Impeller/Wear Rings	ESW	1987	Failure to Run	Partial	ESW pump low flow. Worn impellers.
158	Internal to Component	Maintenance	Pump	Test	Coupling	ESW	1987	Failure to Start	Almost Complete	Two ESW pumps had failed couplings. Cause attributed to abnormal stress.
159	Internal to Component	Maintenance	Pump	Test	Impeller/Wear Rings	ESW	1989	Failure to Start	Partial	ESW pumps had reduced flow and discharge pressure. Worn impellers/wearing rings.
160	Internal to Component	Maintenance	Pump	Test	Impeller/Wear Rings	ESW	1985	Failure to Run	Partial	The charging pump service water pumps degraded. Caused by expected wear of pump due to erosion and corrosion properties of the process fluid involved
161	Internal to Component	Maintenance	Pump	Test	Impeller/Wear Rings	ESW	1986	Failure to Run	Partial	ESW pumps had worn impellers and one had a plugged strainer.

Item	Proximate Cause	Coupling Factor	Segment	Discovery Method	Piece Part	System	Year	Failure Mode	Degree of Failure	Description
162	Internal to Component	Maintenance	Pump	Test	Packing/Seals	ESW	1981	Failure to Start	Partial	RHR service water pumps failed to meet flow requirements due to seal water leakage and pump wearout.
163	Internal to Component	Maintenance	Pump	Test	Impeller/Wear Rings	ESW	1991	Failure to Start	Partial	ESW pumps had reduced flow and discharge pressure. Worn impellers/wearing rings.
164	Internal to Component	Maintenance	Pump	Test	Impeller/Wear Rings	ESW	1992	Failure to Start	Partial	ESW pumps had reduced flow and discharge pressure. Worn impellers/wearing rings.
165	Internal to Component	Maintenance	Pump	Test	Impeller/Wear Rings	ESW	1982	Failure to Run	Partial	Loss of Service Water pump due to wearout at end of life.
166	Internal to Component	Maintenance	Pump	Test	Impeller/Wear Rings	ESW	1992	Failure to Start	Partial	ESW pumps had reduced flow and discharge pressure. Worn impellers/wearing rings. One pump also exhibited high vibration.
167	Internal to Component	Maintenance	Pump	Test	Impeller/Wear Rings	ESW	1994	Failure to Start	Partial	Two ESW pumps had low discharge pressure during testing. Each pump had worn internals and both pump internals were replaced.
168	Internal to Component	Maintenance	Pump	Test	Impeller/Wear Rings	ESW	1985	Failure to Run	Partial	ESW pumps failed due to worn internals.
169	Internal to Component	Maintenance	Pump	Test	Impeller/Wear Rings	ESW	1988	Failure to Start	Partial	Essential service water pumps were declared inoperable, due to low pump head valves. The low pump heads were caused by wear and aging of internals.
170	Internal to Component	Maintenance	Pump	Test	Impeller/Wear Rings	ESW	1984	Failure to Start	Partial	Essential service water pumps were declared inoperable, due to low pump head valves. The low pump heads were caused by wear and aging of internals.
171	Internal to Component	Maintenance	Pump	Test	Impeller/Wear Rings	ESW	1990	Failure to Run	Partial	ESW pumps had worn and cracked impellers. Aging and normal wear.
172	Internal to Component	Maintenance	Pump	Test	Impeller/Wear Rings	ESW	1998	Failure to Start	Partial	Two ESW pumps failed to develop adequate flow/pressure - pumps degraded.
173	Internal to Component	Maintenance	Pump	Test	Impeller/Wear Rings	ESW	1985	Failure to Start	Partial	ESW pumps had reduced flow and discharge pressure. Worn impellers/wearing rings.
174	Internal to Component	Maintenance	Pump	Test	Bearing	ESW	1985	Failure to Run	Partial	ESW pumps had reduced flow and discharge pressure. Worn impellers/wearing rings.
175	Internal to Component	Maintenance	Pump	Test	Impeller/Wear Rings	ESW	1990	Failure to Start	Partial	ESW pumps had reduced flow and discharge pressure. Worn impellers/wearing rings.
176	Internal to Component	Maintenance	Pump	Test	Shaft	ESW	1993	Failure to Run	Partial	Service water pumps were noted to have high vibrations and low discharge pressure. Uneven wear caused pump to be out of balance.
177	Internal to Component	Maintenance	Pump	Test	Impeller/Wear Rings	ESW	1985	Failure to Start	Partial	Emergency service water pumps discharge pressure below allowable limits. Causes were loose impellers, dropped impeller, and worn internals.
178	Internal to Component	Maintenance	Pump	Test	Impeller/Wear Rings	ESW	1985	Failure to Start	Partial	ESW pumps failed to meet the minimum flow requirements of test. The cause of the failure is normal wearout of the pump impeller due to the high sand content of the water being pumped. Pump impeller lift was adjusted.
179	Internal to Component	Maintenance	Pump	Test	Impeller/Wear Rings	ESW	1988	Failure to Start	Partial	ESW pumps had reduced flow and discharge pressure. Worn impellers/wearing rings.
180	Internal to Component	Maintenance	Pump	Test	Impeller/Wear Rings	ESW	1988	Failure to Start	Partial	Service water pumps were noted to have high vibrations and low discharge pressure. Uneven wear caused pump to be out of balance.
181	Internal to Component	Maintenance	Pump	Test	Impeller/Wear Rings	ESW	1983	Failure to Run	Partial	RHR Service Water pumps failed flow tests due to wearout and had to be rebuilt.

Item	Proximate Cause	Coupling Factor	Segment	Discovery Method	Piece Part	System	Year	Failure Mode	Degree of Failure	Description
182	Internal to Component	Maintenance	Pump	Test	Impeller/Wear Rings	RHR-B	1985	Failure to Start	Partial	The first pump failed to meet required flow rate. The second was drawing excessive amperage. Both conditions were attributed to worn internals.
183	Internal to Component	Maintenance	Pump	Test	Impeller/Wear Rings	HPI	1983	Failure to Start	Partial	SI pump and both CCPs failed to meet the minimum head curve requirements. The cause of pump head capacity degradation has been attributed to normal pump operation. The inability to balance flows has been attributed to the lower head capacity of the pumps.
184	Internal to Component	Maintenance	Pump	Test	Impeller/Wear Rings	ESW	1985	Failure to Run	Partial	Wear caused high ESW pump bearing temperatures, vibration, and low amperage/flow.
185	Internal to Component	Maintenance	Pump	Test	Impeller/Wear Rings	ESW	1981	Failure to Start	Partial	Loss of Service Water pump due to wearout at end of life.
186	Internal to Component	Maintenance	Pump	Test	Lubrication	SLC	1992	Failure to Run	Partial	Standby Liquid Control pumps lost oil while running. The gasket between the crankcase frame cap and the gear housing cover was worn.
187	Internal to Component	Maintenance	Pump	Test	Coupling	ESW	1990	Failure to Start	Partial	ESW pumps had reduced flow and discharge pressure. Worn impellers/wearing rings. Cause determined to be normal wear and high sand content of river water.
188	Internal to Component	Quality	Pump	Demand	Impeller/Wear Rings	AFW	1988	Failure to Run	Partial	Following a plant trip, it was discovered that the auxiliary feedwater pumps had internal damage. Some channel ring vanes had chips missing, and several parts were found in the SG auxiliary feedwater piping.
189	Operational/ Human Error	Design	Driver	Demand	I&C	ESW	1980	Failure to Start	Partial	Instrument isolation valve closed causing a low suction trip signal to two RHRSW pumps.
190	Operational/ Human Error	Design	Driver	Inspection	Breaker	ESW	1984	Failure to Start	Partial	During an attempt to perform preventive maintenance for unit one's RHR service water pumps, plant personnel mistakenly disconnected the motor leads for unit two's RHR service water pump.
191	Operational/ Human Error	Design	Driver	Test	Breaker	AFW	1985	Failure to Start	Complete	Both AFW pumps failed to start when tested, due to the circuit breakers not being racked in properly.
192	Operational/ Human Error	Design	Pump	Demand	Impeller/Wear Rings	AFW	1990	Failure to Run	Almost Complete	Due to a combination of management error and procedural deficiency, the turbine driven auxiliary feedwater pump was run deadheaded. The operation damaged the pump. When the pump was manually tripped, steam vented back into the suction line, caused another AFW pump to also trip, on a low suction pressure signal.
193	Operational/ Human Error	Design	Suction	Demand	Piping	RHR-P	1980	Failure to Run	Complete	The reactor vessel vent eductor was in service in preparation for refueling with RHR operating. A low flow alarm was received and low flow and low motor current were indicated. A second pump was started and became air-bound. Putting the vessel vent eductor system into service was the root cause of the incident.
194	Operational/ Human Error	Design	Suction	Demand	Piping	RHR-P	1985	Failure to Run	Complete	Swap over of RHR pumps resulted in both trains becoming inoperable due to air injection into the suction of the pumps. This required both pumps to be vented and required RCS level to be raised to prevent a possible recurrence of the vortex problem.
195	Operational/ Human Error	Design	Suction	Demand	Tank	AFW	1980	Failure to Run	Complete	Both emergency feedwater pumps lost feed pump suction. The emergency feedwater pump suction flashed to steam due to the feedwater train flashing and forcing hot water back through the startup and blowdown tanks and into the feedwater pump suction. To prevent this recurrence, the operating procedures have been changed to require isolating the startup and blowdown effluent as a source of emergency feedwater suction prior to increasing power.

Item	Proximate Cause	Coupling Factor	Segment	Discovery Method	Piece Part	System	Year	Failure Mode	Degree of Failure	Description
196	Operational/ Human Error	Design	Suction	Demand	Piping	RHR-P	1982	Failure to Run	Complete	Suction was lost to both RHR pumps. RHR flow was less than 3000 gpm and pump amps were fluctuating prior to taking corrective action. Each of these events appear to have been caused by a slow decrease in RCS level in conjunction with the vortex action at the pump suction.
197	Operational/ Human Error	Design	Suction	Demand	Piping	RHR-P	1984	Failure to Run	Almost Complete	On two occasions, RHR pumps cavitated due to low RCS level while draining the RCS.
198	Operational/ Human Error	Maintenance	Driver	Demand	Breaker	ESW	1988	Failure to Run	Partial	Service water pump high dropout over current protection devices were less than running current conditions and trip setpoints did not account for changing load conditions due to modified impellers. Three pump trips had occurred.
199	Operational/ Human Error	Maintenance	Driver	Demand	Breaker	ESW	1987	Failure to Start	Partial	One breaker failed to linkage alignment and second from loose relay connections. Inadequate maintenance.
200	Operational/ Human Error	Maintenance	Driver	Demand	Breaker	ESW	1993	Failure to Start	Partial	Operations personnel were attempting to swap the running service water pump with the idle service water pump. Personnel placed the control switch to start and the service water pump did not start. Breaker malfunction. Later, another service water pump failed to start because of the breaker.
201	Operational/ Human Error	Maintenance	Driver	Inspection	Bearing	RHR-P	1988	Failure to Run	Partial	Residual heat removal pump motor upper bearing housings were observed to be leaking oil. The cause of the failure was attributed to a lack of sealant being applied and gasket installed after the last maintenance was performed on the motor bearing housing.
202	Operational/ Human Error	Maintenance	Driver	Inspection	I&C	RHR-P	1992	Failure to Start	Complete	Both trains of RHR were rendered inoperable for two minutes, while performing an operational readiness test surveillance procedure. The surveillance procedure required that the one RHR train pump be placed in pull to lock and the other train heat exchanger flow control valve throttled to 30-40% open. The procedure directed the operators to perform operations that resulted in both trains of RHR being inoperable
203	Operational/ Human Error	Maintenance	Driver	Inspection	I&C	AFW	1990	Failure to Start	Complete	During testing one AFW pump was tested and other was tested without returning first to auto. Both pumps were unavailable at the same time. The procedure was the cause.
204	Operational/ Human Error	Maintenance	Driver	Inspection	Breaker	RHR-P	1981	Failure to Start	Complete	All RHR pumps de-energized to replace RHR Relief valve. T.S. allows this condition for 1 hour. Operated in the mode in excess of 5 hours.
205	Operational/ Human Error	Maintenance	Driver	Maintenance	Breaker	RHR-B	1991	Failure to Start	Partial	While performing preventive maintenance calibration check on the protective relays for a residual heat removal pump motor 4kv breaker, it was found that all overcurrent relays for two pumps were out of calibration
206	Operational/ Human Error	Maintenance	Driver	Maintenance	Breaker	RHR-B	1990	Failure to Start	Partial	RHR pump breaker overcurrent trips out of calibration.
207	Operational/ Human Error	Maintenance	Driver	Test	Motor	ESW	1994	Failure to Run	Partial	Leak test of the containment cooling service water pump vault watertight door revealed excessive leakage. Flooding and leakage past this door would make inoperable two of four containment cooling service water pumps. Procedural inadequacy was cited as the cause for the degraded door seals.
208	Operational/ Human Error	Maintenance	Driver	Test	I&C	ESW	1989	Failure to Start	Partial	Emergency equipment service water pump relays were not reset following a load shedding test 30 hours before.
209	Operational/ Human Error	Maintenance	Pump	Demand	Casing	AFW	1983	Failure to Run	Partial	During testing, the outboard bearing temperature was high on the turbine-driven AFW pump, due to improper balance drum clearances, caused by improper maintenance. The procedure will be modified and the balance drum clearance reset. While the unit was starting up, the motor-driven AFW pump outboard bearing temperature was high. Excessive thrust bearing clearance caused the balance drum to unbalance, causing the thrust bearing to overheat.

Item	Proximate Cause	Coupling Factor	Segment	Discovery Method	Piece Part	System	Year	Failure Mode	Degree of Failure	Description
210	Operational/ Human Error	Maintenance	Pump	Maintenance	Lubrication	HPI	1991	Failure to Run	Partial	Following an overhaul of the HPI pumps. Too much oil flow led to excessive oil leakage, which would have failed HPI pumps before end of mission.
211	Operational/ Human Error	Maintenance	Pump	Test	Packing/Seals	AFW	1996	Failure to Run	Partial	During the performance of Steam-Driven Emergency Feedwater Pump testing, sparks were observed emanating from the outboard mechanical seal area. The sparks appeared to be due to a mechanical interference within the mechanical seal assembly. The pump mechanical seal was disassembled and determined to have been improperly installed during the last refueling outage. The evaluation identified a mechanical seal design deficiency and inadequate corrective action for a previously identified event as the primary causes for this event. A contributing cause for this event was found to be inadequate predictive maintenance techniques. The electric AFW pump exhibited the same problem.
212	Operational/ Human Error	Maintenance	Pump	Test	Casing	RHR-P	1989	Failure to Start	Complete	Both loops of the residual heat removal system were declared inoperable due to gas binding of both RHR pumps. The gas binding was caused by entry of nitrogen gas into the reactor coolant system from accumulator. The root cause of this event has been attributed to personnel error. Personnel did not comply with the specific requirements in the accumulator discharge check valve full flow test procedure due to inattention to detail.
213	Operational/ Human Error	Maintenance	Suction	Demand	Piping	ESW	1996	Failure to Run	Complete	Both trains of both units charging pump service water pumps became air bound. Underwater diving maintenance activities on one units circulating water and service water lines was identified as the source of the air. The air entered the service water supply lines when a valve was opened in preparation for a Safety Injection logic test.
214	Operational/ Human Error	Maintenance	Suction	Demand	Piping	ESW	1996	Failure to Run	Complete	Both trains of both units charging pump service water pumps became air bound. Underwater diving maintenance activities on one units circulating water and service water lines was identified as the source of the air. The air entered the service water supply lines when a valve was opened in preparation for a Safety Injection logic test.
215	Operational/ Human Error	Maintenance	Suction	Inspection	Valve	SLC	1991	Failure to Start	Partial	SLC pumps were potentially inoperable during part of test due to valve lineup.
216	Operational/ Human Error	Maintenance	Suction	Maintenance	Piping	RHR-P	1982	Failure to Run	Complete	Shutdown cooling was lost due to nitrogen intrusion because of backflushing a filter in the purification system.
217	Operational/ Human Error	Maintenance	Suction	Maintenance	Strainer	HPI	1985	Failure to Run	Partial	Strainers found still installed in the suction piping of the high-pressure injection pumps was a condition not considered in the operating design. The strainers were found during maintenance to repair a slight flange leak. The strainers had been placed in the suction piping during construction and were to be in place during system flushing to prevent any debris from reaching the pumps. However, the strainers should have been removed after system flushing prior to functional testing
218	Operational/ Human Error	Operational	Discharge	Inspection	Valve	AFW	1994	Failure to Start	Complete	Following a trip, the AFW Pumps were secured and the discharge flow control valves for the Motor Driven Pumps were closed. Later, an operator discovered during a routine Control Board walkdown that the valves were closed. Subsequent investigation revealed the AFW system had not been placed in standby readiness per the operating procedure after the system was secured.
219	Operational/ Human Error	Operational	Discharge	Inspection	Valve	HPI	1987	Failure to Start	Almost Complete	While attempting to fill the safety injection accumulators, it was discovered that two of three SI pumps had been isolated from the high head injection flowpath.
220	Operational/ Human Error	Operational	Discharge	Inspection	Valve	HPI	1993	Failure to Run	Partial	One AFW pump failed due to incorrect procedure which allowed pump to be run without flow, other AFW pump was allowed to run past max flow rate. It is unclear whether these mistakes were due to inadequate procedures or staff errors, but it was assumed to be a failure to follow procedure.

Item	Proximate Cause	Coupling Factor	Segment	Discovery Method	Piece Part	System	Year	Failure Mode	Degree of Failure	Description
221	Operational/ Human Error	Operational	Driver	Demand	I&C	ESW	1981	Failure to Start	Partial	Alarm circuit breaker was de-energized resulting in a loss of two RHR service water pumps.
222	Operational/ Human Error	Operational	Driver	Demand	I&C	AFW	1983	Failure to Start	Complete	An operator incorrectly secured the diesel and steam driven AFW pumps, which prevented their restart on low SG level.
223	Operational/ Human Error	Operational	Driver	Inspection	I&C	HPI	1990	Failure to Start	Partial	Both safety injection pumps were in the pull-to-lock position. With the switches in pull-to-lock, the pumps would not have automatically started upon receipt of an initiating signal. This event was caused by cognitive personnel error by a utility licensed operator in failure to follow an approved procedure.
224	Operational/ Human Error	Operational	Driver	Inspection	Breaker	HPI	1989	Failure to Start	Partial	HPI Pump B not retested, then HPI Pump A removed from service.
225	Operational/ Human Error	Operational	Driver	Inspection	Breaker	HPI	1990	Failure to Start	Complete	By opening incorrect breaker, HPI pump tripped while others were unavailable.
226	Operational/ Human Error	Operational	Driver	Inspection	I&C	HPI	1992	Failure to Start	Almost Complete	Two charging pumps and one charging pump service water pump were removed from service simultaneously which is a condition not allowed by technical specifications.
227	Operational/ Human Error	Operational	Driver	Inspection	Breaker	HPI	1988	Failure to Start	Complete	HPI pumps not restored before mode change due to procedural inadequacy.
228	Operational/ Human Error	Operational	Driver	Inspection	Breaker	ESW	1981	Failure to Start	Almost Complete	Control breakers for two ESW pumps were open due to inadvertent operator action.
229	Operational/ Human Error	Operational	Driver	Inspection	I&C	HPI	1988	Failure to Start	Complete	With alternate CCP pump out-of-service, the remaining operable pump was erroneously placed in pull-to-lock.
230	Operational/ Human Error	Operational	Driver	Inspection	Breaker	CSS	1991	Failure to Start	Complete	CSR control power de-energized prior to mode change. Technical Specification violation. Inadequate procedure review.
231	Operational/ Human Error	Operational	Driver	Inspection	Breaker	HPI	1982	Failure to Start	Complete	During the draining of the reactor coolant system, both centrifugal charging pumps were rendered inoperable. The initial conditions in the draining procedure contained a confusing statement, which led to an erroneous assumption that both CCP breakers had to be racked out and tagged.
232	Operational/ Human Error	Operational	Driver	Inspection	I&C	RHR-P	1995	Failure to Start	Complete	The switches for the containment spray and recirculation pumps were in a trip pullout when the Technical Specifications and plant procedures required the pumps to be operable.
233	Operational/ Human Error	Operational	Driver	Test	I&C	ESW	1990	Failure to Start	Complete	An emergency service water pump failed to start and was declared inoperable. Further investigation determined that the failure of the pump to start was due to a tripped emergency engine shutdown device. Operations personnel performing the testing did not recognize the need to reset it prior to starting the pump. Examination of the other two ESW pumps revealed that their emergency shutdown devices were also in the tripped condition.
234	Operational/ Human Error	Operational	Pump	Inspection	Lubrication	HPI	1983	Failure to Start	Complete	A routine preventive maintenance (oil change) was mistakenly performed on the north charging pump instead of the south as scheduled. Since the south pump was previously cleared for this oil change, and the test pump was valved out, none of these three pumps were in service as required by tech specs for the approximately 20 minutes it took to change the oil in the north pump.
235	Operational/ Human Error	Operational	Pump	Maintenance	Lubrication	ESW	1993	Failure to Run	Partial	Low pressure RHR bearing oil level not maintained high enough when new smaller sightglass installed. Second event the sightglass was broken when adding oil.
236	Operational/ Human Error	Operational	Suction	Demand	Piping	ESW	1986	Failure to Run	Complete	Failure to properly vent and fill a newly installed pipe introduced air into the charging pump service water system.

Item	Proximate Cause	Coupling Factor	Segment	Discovery Method	Piece Part	System	Year	Failure Mode	Degree of Failure	Description
237	Operational/ Human Error	Operational	Suction	Demand	Piping	RHR-P	1984	Failure to Run	Complete	The control room operators started a second residual heat removal pump in preparation for removing the operating RHR pump from service. With both pumps running, flow became excessive for the half-loop condition causing cavitation and air binding of both pumps. To prevent recurrence the procedure which controls the operation of the RHR pumps has been changed to include specific instructions to stop the operating pump prior to starting the second pump while at half-loop.
238	Operational/ Human Error	Operational	Suction	Demand	Booster Pump	ESW	1980	Failure to Start	Partial	The service water RHR booster pump was de-energized during maintenance. The attempt to start service water pumps failed due to low suction pressure.
239	Operational/ Human Error	Operational	Suction	Demand	Piping	RHR-P	1980	Failure to Run	Complete	While attempting to increase RHR flow, the plant experienced a total loss of flow due to the pumps being air-bound. The pump was not vented when starting to increase flow. Operating procedures have been changed to have an operator present while changing flow in the RHR system. There have been losses of RHR flow in the past because the pumps were air-bound and methods are being investigated to improve the system design.
240	Operational/ Human Error	Operational	Suction	Demand	Piping	ESW	1988	Failure to Run	Complete	The procedure failed to adequately caution the operator to slowly fill a drained line. Rapid filling resulted in a loss of NPSH to the charging service water pumps.
241	Operational/ Human Error	Operational	Suction	Maintenance	Strainer	ESW	1986	Failure to Run	Complete	A service water strainer was placed in service without being vented resulting in air binding system and loss of charging pump service water pumps.
242	Operational/ Human Error	Operational	Suction	Test	Piping	ESW	1989	Failure to Run	Partial	Inadequate procedure led to air binding of operating ESW pumps.
243	Operational/ Human Error	Quality	Driver	Inspection	Breaker	ESW	1992	Failure to Start	Partial	The fit between an ESW pump breaker primary disconnects and the associated breaker cubicle stabs was inadequate. The poor fit between the disconnects and the stabs led to arcing in the breaker cubicle when the pump was started, resulting in a fire. Shortly after identifying the cause of the fire, the remaining ESW breakers, which had recently been replaced along with the failed breaker, as part of a design modification package, were found to be inadequate also.
244	Operational/ Human Error	Quality	Driver	Test	I&C	ESW	1982	Failure to Start	Partial	Two ESW pumps failed to start. One ESW pump failed to function as a result of loose wires on relay terminals in both pump logic schemes, a loose states link and an instantaneous contact found out of adjustment on the other pump logic scheme.
245	Other	Design	Driver	Demand	I&C	ESW	1981	Failure to Start	Partial	Attempt was made to place the a RHRSW subsystem into service for use in suppression pool cooling, the subsystems' pumps could not be started due to a pump suction header low pressure lockout signal from the header pressure switch. The threaded plug in the switch diaphragm housing became loose and allowed the diaphragm fluid to leak out and caused the switch to sense a low pressure.
246	Other	Design	Driver	Demand	Piping	HCI	1999	Failure to Start	Complete	Water entered the HCI and RCI steam supply lines, rendering both pumps inoperable. Failed reactor vessel instrumentation allowed water to overflow and fill the HCI/RCI steam lines. Pumps were unavailable.
247	Other	Design	Driver	Demand	I&C	ESW	1981	Failure to Start	Partial	Attempt was made to place the a RHRSW subsystem into service for use in suppression pool cooling, the subsystems' pumps could not be started due to a pump suction header low pressure lockout signal from the header pressure switch. The threaded plug in the switch diaphragm housing became loose and allowed the diaphragm fluid to leak out and caused the switch to sense a low pressure. This is a second event two months later.
248	Other	Design	Driver	Inspection	I&C	AFW	1983	Failure to Start	Partial	Both AFW pumps had to be rendered inoperable to allow repairs to actuation circuitry.

Item	Proximate Cause	Coupling Factor	Segment	Discovery Method	Piece Part	System	Year	Failure Mode	Degree of Failure	Description
249	Other	Design	Driver	Test	I&C	RHR-B	1982	Failure to Start	Partial	A functional test revealed a sliding link in control room panel open. Further investigation revealed a total of four links open. These links, left open, negated all autostart capability of 2 of 4 RHR pumps. It could not be determined why these four links were open.
250	Other	Design	Driver	Test	I&C	ESW	1992	Failure to Start	Partial	Valve position contacts prevented ESW pump circuit breakers from closing. Poor design resulted in water intrusion in the valve limit switch box.
251	Other	Design	Driver	Test	Breaker	SLC	1986	Failure to Start	Complete	During a test, both Squib Valve Detonators shorted after firing and the Control Power Transformer fuse blew causing the pump motor trip. This was caused by improper fuse coordination between the Control Power Transformer fuse and the Squib Valve Detonator fuses. The redundant system's Squib Valve was also fired during this test, without running the associated pump, and one of the Squib Valve Detonators shorted after firing. The same fuse coordination problem existed for both systems.
252	Other	Design	Suction	Demand	Valve	RHR-P	1984	Failure to Run	Complete	Both RHR pumps were unable to operate due to the introduction of air into the RHR system. The incident occurred during the drain down of the RCS, when the level of the RCS was being monitored via a standpipe off the centerline of one of the RCS loops. The isolation valve to which the standpipe was attached became clogged sometime during the drain down and falsely indicated above centerline when in fact the level was below the RHR suction line (below centerline).
253	Other	Design	Suction	Demand	Piping	ESW	1980	Failure to Run	Almost Complete	Air ingress exceeded the air removal capability of the constant vent valves. A design change was implemented to remove the air compressor cooling from the service water system.
254	Other	Design	Suction	Demand	Piping	RHR-P	1982	Failure to Run	Complete	With unit drained to centerline of the nozzles, suction to both RHR pumps was lost for 36 minutes. Suction to the RHR pumps was lost because of ambiguous reactor coolant system level indication while drained to centerline of the nozzles. The actual RCS level was lower than observed.
255	Other	Design	Suction	Demand	Piping	RHR-P	1987	Failure to Run	Complete	RHR flow was interrupted when both RHR trains became inoperable due to air bound RHR pumps. The loss of RCS inventory to the reactor coolant drain tank due to a leaking valve caused a decrease in RCS water level, vortexing in the pumps' suction line, and air entrainment in the RHR pumps.
256	Other	Design	Suction	Demand	Piping	HPI	1982	Failure to Start	Complete	Hydrogen from the suction dampener got into suction piping and failed both CCPs.
257	Other	Design	Suction	Demand	I&C	HPI	1997	Failure to Run	Partial	Letdown storage tank reference leg not full, which gave erroneous indication of sufficient tank level. One HPI pump severely damaged, other pump not as damaged, and could have run. The root cause was a combination of a design weakness of a common reference leg for the Letdown storage tank level instruments and a leaking instrument fitting due to an inadequate work practice.
258	Other	Design	Suction	Demand	Piping	RHR-P	1982	Failure to Run	Complete	RHR Suction lost due to erroneous RCS level while draining the RCS.
259	Other	Design	Suction	Test	I&C	AFW	1985	Failure to Run	Almost Complete	Testing of the turbine driven AFW pump resulted in a low suction trip of the motor driven pump. The turbine driven pump had a faulty governor. It was during the post maintenance test of turbine driven pump that speed oscillations occurred causing pressure oscillations in the suction of the motor driven pump that was in service. Foreign material in the suction gauge protectors resulted in the pressure sensors sensing only the low pressures and not the high pressures of the oscillations, so the motor driven pump tripped on low pressure.

Item	Proximate Cause	Coupling Factor	Segment	Discovery Method	Piece Part	System	Year	Failure Mode	Degree of Failure	Description
260	Other	Environmental	Driver	Inspection	Motor	ESW	1981	Failure to Run	Partial	The float guide failed in a RHRSW pump air valve and caused the valve to fail open and flood pump room.
261	Other	Environmental	Driver	Inspection	Motor	AFW	1990	Failure to Start	Partial	Both motor driven AFW pumps were sprayed when a service water pipe developed a through wall leak.
262	Other	Maintenance	Discharge	Demand	Valve	ESW	1980	Failure to Start	Partial	RHR service water pumps were started to put torus cooling in service. When these pumps would not deliver required discharge pressure, they were declared inoperable. The seal in an air release valve was bad, allowing a vent on the discharge line.
263	Other	Maintenance	Driver	Demand	Breaker	RHR-P	1987	Failure to Start	Complete	Two LPI pumps, when given a start signal, would not start. An ongoing investigation revealed the probable root cause of the event to be poor electrical contact of the breaker auxiliary stabs for the pumps.
264	Other	Maintenance	Driver	Demand	I&C	ESW	1982	Failure to Start	Complete	Following a reactor scram, an attempt to initiate suppression pool cooling revealed that both RHRSW loops were inoperable as neither loop's pumps could be started. Low suction header pressure lockout signals in each loop prevented starting each loop's pumps. Plugging of the sensing line to each loop's suction header pressure switch prevented both switches from sensing actual pressure, although a lack of operating fluid in one switch and an open power supply breaker to the other switch also would have prevented pumps from starting.
265	Other	Maintenance	Driver	Maintenance	Breaker	ESW	1984	Failure to Start	Partial	ESW pump breaker failures, broken screw, no lubrication, and a bent track
266	Other	Maintenance	Driver	Maintenance	Breaker	ESW	1982	Failure to Start	Partial	ESW pump circuit breakers found damaged. Defective arc chute and cracked secondary coupler.
267	Other	Maintenance	Driver	Test	Breaker	ESW	1984	Failure to Start	Partial	ESW pump breakers tripped due to failed voltage control devices.
268	Other	Maintenance	Driver	Test	Breaker	ESW	1984	Failure to Start	Partial	ESW pump breaker overcurrent trip devices tripping too low.
269	Other	Maintenance	Suction	Demand	Piping	RHR-P	1986	Failure to Run	Complete	SDC pumps cavitated due to lowering RCS level. Level indication was in error.
270	Other	Maintenance	Suction	Demand	Piping	RHR-P	1981	Failure to Run	Complete	Temporary coolant loop level indicator showed level slowly increasing over a period of days. The system was periodically drained to maintain 65 percent indicated level. A RHR pump lost suction on reduction of actual level. The second pump was started, and lost suction. Indication drift was due to evaporation of reference leg.
271	Other	Maintenance	Suction	Demand	Piping	RHR-P	1980	Failure to Run	Complete	A complete loss of RHR flow occurred while plant operators were increasing RHR heat exchanger flow by closing down on the heat exchanger bypass valve.
272	Other	Maintenance	Suction	Demand	Piping	RHR-P	1983	Failure to Run	Complete	The RHR pumps began to cavitate and eventually both pumps were stopped. The reactor vessel level gauge being used to provide an indication that the level was approaching the vessel flange level had been isolated (reactor coolant drain tank isolation valve had been closed during an attempt to reduce leakage). Additionally, procedures did not require visual monitoring of cavity level.
273	Other	Operational	Pump	Inspection	Bearing	ESW	1991	Failure to Run	Partial	Lube oil cooling water isolated during a test. Pumps continued to run with no cooling.
274	Unknown	Design	Suction	Demand	Piping	RHR-P	1983	Failure to Run	Complete	RHR pumps cavitated. Unable to repeat. Unknown cause.

Table A-2. Pump CCF event summary, sorted by coupling factor.

Item	Coupling Factor	Proximate Cause	Segment	Discovery Method	Piece Part	System	Year	Failure Mode	Degree of Failure	Description
1	Design	Design/ Construction/ Manufacture/ Installation Inadequacy	Discharge	Demand	Valve	AFW	1985	Failure to Start	Partial	Controller problems in the steam and diesel driven AFW pumps caused the pumps to trip on low suction pressure. The pump discharge flow controller valves were also not set properly after last maintenance. Low suction trips were due to design error.
2	Design	Design/ Construction/ Manufacture/ Installation Inadequacy	Discharge	Demand	Valve	AFW	1986	Failure to Start	Partial	Both the turbine driven and motor driven AFW pumps could not produce full flow because the cages in their discharge valve trapped debris and plugged.
3	Design	Design/ Construction/ Manufacture/ Installation Inadequacy	Driver	Demand	I&C	AFW	1981	Failure to Start	Almost Complete	Two AFW pumps failed to automatically start due to low suction pressure trips. A modification was installed to prevent this. This effect was discovered previously, but apparently had not been corrected prior to an attempt to start the pumps three weeks later.
4	Design	Design/ Construction/ Manufacture/ Installation Inadequacy	Driver	Demand	Lubrication	RHR-P	2000	Failure to Run	Complete	Both RHR/LPI pumps fail to run due to improper oil in system. High bearing temperatures occurred when the pumps were operated. This was due to the wrong lube oil being used, which had too high a viscosity. Inadequate vendor design information resulted in the higher viscosity oil being used and additional exacerbating problems such as insufficient bearing clearances.
5	Design	Design/ Construction/ Manufacture/ Installation Inadequacy	Driver	Demand	I&C	AFW	1997	Failure to Run	Partial	One actual AFW pump failure due to spurious electronic overspeed trip. Determined that all three pumps were susceptible to spurious overspeed trips.
6	Design	Design/ Construction/ Manufacture/ Installation Inadequacy	Driver	Demand	I&C	AFW	1981	Failure to Start	Almost Complete	A modification to the control instrumentation for two AFW pumps resulted in a backfeed situation such that when called upon to start, both pumps would not start.
7	Design	Design/ Construction/ Manufacture/ Installation Inadequacy	Driver	Inspection	Lubrication	HPI	2000	Failure to Run	Partial	CVC makeup oil pump motor too small for certain accidents.
8	Design	Design/ Construction/ Manufacture/ Installation Inadequacy	Driver	Inspection	I&C	AFW	1994	Failure to Start	Partial	Single failure would prevent auto initiation of AFW. Circuit design did not provide separation required by standards and code. The single failure identified was a short circuit across two conductors of the actuation relays associated with the initiation logic matrix.

Item	Coupling Factor	Proximate Cause	Segment	Discovery Method	Piece Part	System	Year	Failure Mode	Degree of Failure	Description
9	Design	Design/ Construction/ Manufacture/ Installation Inadequacy	Driver	Inspection	Supports	RHR-B	1986	Failure to Start	Partial	RHR motor internal supports were cracked due to stress and vibration. Design improvements were made.
10	Design	Design/ Construction/ Manufacture/ Installation Inadequacy	Driver	Maintenance	I&C	HPI	1996	Failure to Run	Partial	A lead was lifted in an emergency bus DC control circuit resulting in one charging pump tripping while running on the alternate power supply. Further investigation into this event revealed an anomaly, which could result in having no operating charging pumps. The cause of the event has been determined to be an error in the original design of the charging pump interlock logic. The anomaly would occur upon a loss of the DC control power to one emergency bus if 'C' charging pump was powered from the other bus.
11	Design	Design/ Construction/ Manufacture/ Installation Inadequacy	Driver	Maintenance	I&C	HPI	1996	Failure to Run	Partial	A lead was lifted in an emergency bus DC control circuit resulting in one charging pump tripping while running on the alternate power supply. Further investigation into this event revealed an anomaly, which could result in having no operating charging pumps. The cause of the event has been determined to be an error in the original design of the charging pump interlock logic. The anomaly would occur upon a loss of the DC control power to one emergency bus if 'C' charging pump was powered from the other bus.
12	Design	Design/ Construction/ Manufacture/ Installation Inadequacy	Driver	Test	I&C	AFW	1981	Failure to Start	Almost Complete	Two low suction pressure trips for the AFW pumps were mis-calibrated, which prevented the pumps from starting.
13	Design	Design/ Construction/ Manufacture/ Installation Inadequacy	Driver	Test	I&C	AFW	1992	Failure to Start	Complete	A modification design error (in 1983-1984) removed a start permissive interlock contact. At cold shutdown this de-energized the auxiliary lube oil pump, consequently, when one AFW pump was started it ran for 2.5 seconds and tripped on low oil pressure. Further investigation showed that both units AFW pumps would be affected in the same way. The design error combined with insufficient post modification testing led to this CCF event.
14	Design	Design/ Construction/ Manufacture/ Installation Inadequacy	Driver	Test	Breaker	HPI	1980	Failure to Start	Partial	Upon testing the safety injection pumps it was found that the 6900-v breakers would lock-out preventing pump start if they were given a close signal for >0.32 seconds when a trip condition existed. There is no indication to operations when this locked-out condition exists. The breaker appears to be available for service when it actually is not. The only means of clearing the condition is to remove and reinstall the fuses at the breaker or manually change the state of the relays.
15	Design	Design/ Construction/ Manufacture/ Installation Inadequacy	Pump	Demand	Impeller/Wear Rings	ESW	1981	Failure to Run	Complete	Both charging pump service water pumps failed. A carbon cap screw failed allowing the impeller of one pump to bind on the casing. The ensuing leakage shorted the motor windings of the other pump.

Item	Coupling Factor	Proximate Cause	Segment	Discovery Method	Piece Part	System	Year	Failure Mode	Degree of Failure	Description
16	Design	Design/ Construction/ Manufacture/ Installation Inadequacy	Pump	Demand	Impeller/Wear Rings	ESW	1996	Failure to Run	Partial	A Nuclear Service Water pump tripped on overcurrent after operating for approximately 20 minutes. Initial troubleshooting indicated that the pump was binding and disassembly was required to determine the cause. It was determined that the pump impeller thrust ring had become loose due to thrust ring retainer bolt failure, which allowed the impeller to slip on the shaft and resulted in pump binding and the overcurrent condition. The bolts failed due to corrosion. Similar bolt degradation was discovered on other service water pumps. The investigation results indicate the primary cause of the bolt failures was corrosion induced by galvanic coupling of the retainer bolting and other pump components.
17	Design	Design/ Construction/ Manufacture/ Installation Inadequacy	Pump	Demand	Impeller/Wear Rings	ESW	1986	Failure to Run	Partial	All four emergency service water pumps showed cavitation damage. Two of the pumps had minor damage and were placed back in service. Recirculation cavitation occurs at flows significantly less than design.
18	Design	Design/ Construction/ Manufacture/ Installation Inadequacy	Pump	Test	Shaft	AFW	1988	Failure to Run	Almost Complete	An auxiliary feedwater pump failed its performance test. Subsequent inspection of the pump internals revealed significant damage, including a split in the center shaft sleeve. The AFW pumps were susceptible to corrosion cracking of their bushings. A different material was needed for the bushings.
19	Design	Design/ Construction/ Manufacture/ Installation Inadequacy	Pump	Test	Coupling	ESW	1994	Failure to Start	Partial	Pump produced no flow when started. A shaft coupling failed. Material was determined to be brittle and have low impact properties. The coupling was replaced on all pumps with a type of material more suitable for this application.
20	Design	Design/ Construction/ Manufacture/ Installation Inadequacy	Pump	Test	Shaft	AFW	1988	Failure to Run	Partial	The AFW pumps were susceptible to corrosion cracking of their bushings. A different material was needed for the bushings.
21	Design	Design/ Construction/ Manufacture/ Installation Inadequacy	Suction	Demand	Piping	ESW	1981	Failure to Run	Complete	Increasing flow to chillers robs NPSH from charging service water pumps.
22	Design	Design/ Construction/ Manufacture/ Installation Inadequacy	Suction	Demand	Piping	ESW	1983	Failure to Run	Complete	Increased flow to chillers resulted in loss of NPSH to Charging Water Service Water pumps.
23	Design	Design/ Construction/ Manufacture/ Installation Inadequacy	Suction	Demand	Piping	ESW	1982	Failure to Run	Complete	The use of service water by the chillers can cause a loss of suction pressure to the charging pump service water pumps.

Item	Coupling Factor	Proximate Cause	Segment	Discovery Method	Piece Part	System	Year	Failure Mode	Degree of Failure	Description
24	Design	Design/ Construction/ Manufacture/ Installation Inadequacy	Suction	Demand	Piping	ESW	1982	Failure to Run	Complete	The use of service water by the chillers can cause a loss of suction pressure to the charging pump service water pumps.
25	Design	Design/ Construction/ Manufacture/ Installation Inadequacy	Suction	Demand	Piping	ESW	1981	Failure to Run	Complete	Increased flow to chillers resulted in loss of NPSH to Charging Water Service Water pumps.
26	Design	Design/ Construction/ Manufacture/ Installation Inadequacy	Suction	Demand	Piping	ESW	1982	Failure to Run	Complete	Increased flow to chillers resulted in loss of NPSH to Charging Water Service Water pumps.
27	Design	Design/ Construction/ Manufacture/ Installation Inadequacy	Suction	Demand	Piping	ESW	1983	Failure to Run	Almost Complete	Increased flow to chillers resulted in loss of NPSH to Charging Pump Service Water pumps.
28	Design	Design/ Construction/ Manufacture/ Installation Inadequacy	Suction	Demand	Piping	ESW	1982	Failure to Run	Complete	The use of service water by the chillers can cause a loss of suction pressure to the Charging Water Service Water pumps.
29	Design	Design/ Construction/ Manufacture/ Installation Inadequacy	Suction	Demand	Piping	ESW	1996	Failure to Start	Partial	Freezing of diesel generator service water piping in intake bay. Inadequate initial design.
30	Design	Design/ Construction/ Manufacture/ Installation Inadequacy	Suction	Demand	Piping	ESW	1982	Failure to Run	Almost Complete	Increased flow to chillers resulted in loss of NPSH to Charging Water Service Water pumps.
31	Design	Design/ Construction/ Manufacture/ Installation Inadequacy	Suction	Inspection	Piping	HPI	1991	Failure to Start	Partial	Ultrasonic examination of the chemical and volume control system suction piping was performed. These examinations revealed voids in the alternate boration line and the gravity feed line from the boric acid storage tank.
32	Design	Design/ Construction/ Manufacture/ Installation Inadequacy	Suction	Inspection	Piping	HPI	1988	Failure to Run	Partial	Ultrasonic examination of the chemical and volume control system suction piping was performed. These examinations revealed voids in the suction piping.

Item	Coupling Factor	Proximate Cause	Segment	Discovery Method	Piece Part	System	Year	Failure Mode	Degree of Failure	Description
33	Design	Design/ Construction/ Manufacture/ Installation Inadequacy	Suction	Inspection	Piping	HPI	1990	Failure to Start	Partial	A quantity of gas was found in the centrifugal charging pump suction header that exceeded the maximum allowed gas volume. It was subsequently determined that hydrogen gas had been coming out of solution on both units and accumulating in the suction piping as a probable result of gas stripping by the CCP miniflow orifices. In addition, entrainment of hydrogen bubbles from the volume control tank to the CCP suction pipe may be a contributor as well.
34	Design	Design/ Construction/ Manufacture/ Installation Inadequacy	Suction	Inspection	Piping	HPI	1988	Failure to Start	Partial	It was determined that various pipes of the safety injection system and chemical volume and control system collected or trapped gas which might affect the functions of these systems. There was a concern that the gas pockets may adversely effect pump operation. Voids were detected in some of the high head SI pump piping.
35	Design	Design/ Construction/ Manufacture/ Installation Inadequacy	Suction	Maintenance	Tank	ESW	1985	Failure to Run	Partial	An engineering evaluation revealed that ESW had been inoperable several times due to low NPSH. All three units were affected.
36	Design	Design/ Construction/ Manufacture/ Installation Inadequacy	Suction	Maintenance	Tank	ESW	1990	Failure to Run	Partial	An engineering evaluation revealed that ESW had been inoperable several times due to low NPSH. All three units were affected.
37	Design	Design/ Construction/ Manufacture/ Installation Inadequacy	Suction	Maintenance	Tank	ESW	1990	Failure to Run	Partial	An engineering evaluation revealed that ESW had been inoperable several times due to low NPSH. All three units were affected.
38	Design	Design/ Construction/ Manufacture/ Installation Inadequacy	Suction	Maintenance	Tank	ESW	1985	Failure to Run	Partial	An engineering evaluation revealed that ESW had been inoperable several times due to low NPSH. All three units were affected.
39	Design	Design/ Construction/ Manufacture/ Installation Inadequacy	Suction	Maintenance	Tank	ESW	1990	Failure to Run	Partial	An engineering evaluation revealed that ESW had been inoperable several times due to low NPSH. All three units were affected.
40	Design	Design/ Construction/ Manufacture/ Installation Inadequacy	Suction	Maintenance	Tank	ESW	1985	Failure to Run	Partial	An engineering evaluation revealed that ESW had been inoperable several times due to low NPSH. All three units were affected.

Item	Coupling Factor	Proximate Cause	Segment	Discovery Method	Piece Part	System	Year	Failure Mode	Degree of Failure	Description
41	Design	Design/ Construction/ Manufacture/ Installation Inadequacy	Suction	Test	Tank	SLC	1991	Failure to Run	Complete	During the performance of a special test on the available NPSH of the SLC pumps, the pumps began to cavitate unexpectedly. The SLC systems of both units were declared inoperable. The causes of this event are inadequate modification testing and an error in the original design calculations.
42	Design	Design/ Construction/ Manufacture/ Installation Inadequacy	Suction	Test	Tank	SLC	1991	Failure to Run	Complete	During the performance of a special test on Unit 1 to determine the available NPSH of the SLC pumps, the pumps began to cavitate unexpectedly. The SLC systems of both units were declared inoperable. The causes of this event are inadequate modification testing and an error in the original design calculations.
43	Design	Design/ Construction/ Manufacture/ Installation Inadequacy	Suction	Test	Piping	AFW	1999	Failure to Run	Partial	All AFW trains declared inoperable due to inadequate suction flow capability from the nuclear service water alternate source. Inadequate flow caused by corroded piping. Piping is undersized so there is little margin for piping degradation. Since this is 1 of 4 suction sources, the safety significance is limited.
44	Design	Design/ Construction/ Manufacture/ Installation Inadequacy	Suction	Test	Tank	ESW	1986	Failure to Run	Complete	Loss of prime in the condenser circulating water siphon flow system caused loss of low pressure service water pumps. Pumps lost suction during a test due to poor design.
45	Design	Design/ Construction/ Manufacture/ Installation Inadequacy	Suction	Test	Valve	ESW	1983	Failure to Start	Partial	Low discharge pressure was caused by insufficient suction pressure. Service water flow to parallel components was adjusted.
46	Design	External Environment	Discharge	Demand	Check Valve	AFW	1983	Failure to Start	Almost Complete	Hot water in the AFW pump casings caused the pumps to become vapor bound. The hot water was from leaking check valves upstream of the pumps. This event occurred once on the turbine driven pump and 5 times on the motor driven pump.
47	Design	External Environment	Discharge	Inspection	Piping	HPI	1994	Failure to Run	Partial	Due to a leaking socket weld in the common recirculation line, all three SI pumps were declared inoperable. The underlying cause of the leak was a crack in the socket weld in the common recirculation line, caused by pipe displacement from air entrainment and pump misalignment.
48	Design	External Environment	Pump	Inspection	Bearing	HPI	1991	Failure to Run	Almost Complete	Charging/safety pumps beyond operational limits. Damage was found to the thrust bearings. Air was introduced into this train of chilled water during modifications and testing being performed on the system. This air became trapped in high points of either, or both of, the supply and return chilled water lines to the charging pump. At the reduced flow rate, sufficient cooling was not available and oil temperature increased to the point where bearing damage occurred.
49	Design	Internal to Component	Driver	Demand	Breaker	ESW	2000	Failure to Start	Almost Complete	Two ESW pumps failed to start due to their breakers failing to close. The breakers' prop spring bracket has slipped thus preventing proper interfacing between the prop and the prop pin.
50	Design	Internal to Component	Driver	Inspection	I&C	ESW	1982	Failure to Start	Partial	Open circuit breaker resulted in loss of two RHR service water pumps.

Item	Coupling Factor	Proximate Cause	Segment	Discovery Method	Piece Part	System	Year	Failure Mode	Degree of Failure	Description
51	Design	Internal to Component	Pump	Inspection	Lubrication	HPI	1981	Failure to Run	Partial	Corrosion of HPI pump cooler heads. Improper material led to corrosion
52	Design	Operational/ Human Error	Driver	Demand	I&C	ESW	1980	Failure to Start	Partial	Instrument isolation valve closed causing a low suction trip signal to two RHRSW pumps.
53	Design	Operational/ Human Error	Driver	Inspection	Breaker	ESW	1984	Failure to Start	Partial	During an attempt to perform preventive maintenance for unit one's RHR service water pumps, plant personnel mistakenly disconnected the motor leads for unit two's RHR service water pump.
54	Design	Operational/ Human Error	Driver	Test	Breaker	AFW	1985	Failure to Start	Complete	Both AFW pumps failed to start when tested, due to the circuit breakers not being racked in properly.
55	Design	Operational/ Human Error	Pump	Demand	Impeller/Wear Rings	AFW	1990	Failure to Run	Almost Complete	Due to a combination of management error and procedural deficiency, the turbine driven auxiliary feedwater pump was run deadheaded. The operation damaged the pump. When the pump was manually tripped, steam vented back into the suction line, caused another AFW pump to also trip, on a low suction pressure signal.
56	Design	Operational/ Human Error	Suction	Demand	Piping	RHR-P	1982	Failure to Run	Complete	Suction was lost to both RHR pumps. RHR flow was less than 3000 gpm and pump amps were fluctuating prior to taking corrective action. Each of these events appear to have been caused by a slow decrease in RCS level in conjunction with the vortex action at the pump suction.
57	Design	Operational/ Human Error	Suction	Demand	Piping	RHR-P	1984	Failure to Run	Almost Complete	On two occasions, RHR pumps cavitated due to low RCS level while draining the RCS.
58	Design	Operational/ Human Error	Suction	Demand	Piping	RHR-P	1980	Failure to Run	Complete	The reactor vessel vent eductor was in service in preparation for refueling with RHR operating. A low flow alarm was received and low flow and low motor current were indicated. A second pump was started and became air-bound. Putting the vessel vent eductor system into service was the root cause of the incident.
59	Design	Operational/ Human Error	Suction	Demand	Tank	AFW	1980	Failure to Run	Complete	Both emergency feedwater pumps lost feed pump suction. The emergency feedwater pump suction flashed to steam due to the feedwater train flashing and forcing hot water back through the startup and blowdown tanks and into the feedwater pump suction. To prevent this recurrence, the operating procedures have been changed to require isolating the startup and blowdown effluent as a source of emergency feedwater suction prior to increasing power.
60	Design	Operational/ Human Error	Suction	Demand	Piping	RHR-P	1985	Failure to Run	Complete	Swap over of RHR pumps resulted in both trains becoming inoperable due to air injection into the suction of the pumps. This required both pumps to be vented and required RCS level to be raised to prevent a possible recurrence of the vortex problem.
61	Design	Other	Driver	Demand	Piping	HCI	1999	Failure to Start	Complete	Water entered the HCI and RCI steam supply lines, rendering both pumps inoperable. Failed reactor vessel instrumentation allowed water to overflow and fill the HCI/RCI steam lines. Pumps were unavailable.
62	Design	Other	Driver	Demand	I&C	ESW	1981	Failure to Start	Partial	Attempt was made to place the a RHRSW subsystem into service for use in suppression pool cooling, the subsystems' pumps could not be started due to a pump suction header low pressure lockout signal from the header pressure switch. The threaded plug in the switch diaphragm housing became loose and allowed the diaphragm fluid to leak out and caused the switch to sense a low pressure. This is a second event two months later.

Item	Coupling Factor	Proximate Cause	Segment	Discovery Method	Piece Part	System	Year	Failure Mode	Degree of Failure	Description
63	Design	Other	Driver	Demand	I&C	ESW	1981	Failure to Start	Partial	Attempt was made to place the RHRSW subsystem into service for use in suppression pool cooling, the subsystems' pumps could not be started due to a pump suction header low pressure lockout signal from the header pressure switch. The threaded plug in the switch diaphragm housing became loose and allowed the diaphragm fluid to leak out and caused the switch to sense a low pressure.
64	Design	Other	Driver	Inspection	I&C	AFW	1983	Failure to Start	Partial	Both AFW pumps had to be rendered inoperable to allow repairs to actuation circuitry.
65	Design	Other	Driver	Test	Breaker	SLC	1986	Failure to Start	Complete	During a test, both Squib Valve Detonators shorted after firing and the Control Power Transformer fuse blew causing the pump motor trip. This was caused by improper fuse coordination between the Control Power Transformer fuse and the Squib Valve Detonator fuses. The redundant system's Squib Valve was also fired during this test, without running the associated pump, and one of the Squib Valve Detonators shorted after firing. The same fuse coordination problem existed for both systems.
66	Design	Other	Driver	Test	I&C	ESW	1992	Failure to Start	Partial	Valve position contacts prevented ESW pump circuit breakers from closing. Poor design resulted in water intrusion in the valve limit switch box.
67	Design	Other	Driver	Test	I&C	RHR-B	1982	Failure to Start	Partial	A functional test revealed a sliding link in control room panel open. Further investigation revealed a total of four links open. These links, left open, negated all autostart capability of 2 of 4 RHR pumps. It could not be determined why these four links were open.
68	Design	Other	Suction	Demand	Piping	HPI	1982	Failure to Start	Complete	Hydrogen from the suction dampener got into suction piping and failed both CCPs.
69	Design	Other	Suction	Demand	I&C	HPI	1997	Failure to Run	Partial	Letdown storage tank reference leg not full, which gave erroneous indication of sufficient tank level. One HPI pump severely damaged, other pump not as damaged, and could have run. The root cause was a combination of a design weakness of a common reference leg for the Letdown storage tank level instruments and a leaking instrument fitting due to an inadequate work practice.
70	Design	Other	Suction	Demand	Piping	ESW	1980	Failure to Run	Almost Complete	Air ingress exceeded the air removal capability of the constant vent valves. A design change was implemented to remove the air compressor cooling from the service water system.
71	Design	Other	Suction	Demand	Piping	RHR-P	1982	Failure to Run	Complete	With unit drained to centerline of the nozzles, suction to both RHR pumps was lost for 36 minutes. Suction to the RHR pumps was lost because of ambiguous reactor coolant system level indication while drained to centerline of the nozzles. The actual RCS level was lower than observed.
72	Design	Other	Suction	Demand	Valve	RHR-P	1984	Failure to Run	Complete	Both RHR pumps were unable to operate due to the introduction of air into the RHR system. The incident occurred during the drain down of the RCS, when the level of the RCS was being monitored via a standpipe off the centerline of one of the RCS loops. The isolation valve to which the standpipe was attached became clogged sometime during the drain down and falsely indicated above centerline when in fact the level was below the RHR suction line (below centerline).
73	Design	Other	Suction	Demand	Piping	RHR-P	1987	Failure to Run	Complete	RHR flow was interrupted when both RHR trains became inoperable due to air bound RHR pumps. The loss of RCS inventory to the reactor coolant drain tank due to a leaking valve caused a decrease in RCS water level, vortexing in the pumps' suction line, and air entrainment in the RHR pumps.
74	Design	Other	Suction	Demand	Piping	RHR-P	1982	Failure to Run	Complete	RHR Suction lost due to erroneous RCS level while draining the RCS.

Item	Coupling Factor	Proximate Cause	Segment	Discovery Method	Piece Part	System	Year	Failure Mode	Degree of Failure	Description
75	Design	Other	Suction	Test	I&C	AFW	1985	Failure to Run	Almost Complete	Testing of the turbine driven AFW pump resulted in a low suction trip of the motor driven pump. The turbine driven pump had a faulty governor. It was during the post maintenance test of turbine driven pump that speed oscillations occurred causing pressure oscillations in the suction of the motor driven pump that was in service. Foreign material in the suction gauge protectors resulted in the pressure sensors sensing only the low pressures and not the high pressures of the oscillations, so the motor driven pump tripped on low pressure.
76	Design	Unknown	Suction	Demand	Piping	RHR-P	1983	Failure to Run	Complete	RHR pumps cavitated. Unable to repeat. Unknown cause.
77	Environmental	Design/ Construction/ Manufacture/ Installation Inadequacy	Driver	Inspection	Piping	HPI	2000	Failure to Run	Partial	Microbiologically induced corrosion leak on service water lines to two charging/HPI pump lube oil coolers.
78	Environmental	Design/ Construction/ Manufacture/ Installation Inadequacy	Pump	Demand	Impeller/Wear Rings	ESW	2000	Failure to Start	Almost Complete	Two of the River Water pumps tripped on overcurrent when they were attempted to be started. The trips were a result of physical contact between the impeller and the lower casing liner of the pumps. This condition was due to differential thermal expansion between the pump shaft and the pump casing as a result of an elevated seal injection water temperature. The elevated temperature was due to an abnormal configuration of the Filtered Water System (the backup seal water supply).
79	Environmental	Design/ Construction/ Manufacture/ Installation Inadequacy	Pump	Inspection	Lubrication	HPI	1995	Failure to Run	Partial	High lube oil temperatures were observed during HPI pump operation. Zinc particles from anode were discovered plugging the lube oil coolers. Accelerated corrosion was attributed to a corrosion inhibitor that was added to the system, which chemically interacted with the zinc.
80	Environmental	Design/ Construction/ Manufacture/ Installation Inadequacy	Pump	Test	Coupling	ESW	1987	Failure to Start	Partial	Test showed two ESW pumps failed. Pump shafts were corroded and found to be made of incorrect material.
81	Environmental	Design/ Construction/ Manufacture/ Installation Inadequacy	Suction	Inspection	Strainer	ESW	2000	Failure to Run	Partial	RHRSW Pumps Failed to Develop flow/pressure. Debris in intake structure. Requires modifications to the traveling Water Screen.
82	Environmental	External Environment	Discharge	Test	Recirc	HPI	1992	Failure to Run	Almost Complete	Safety Injection pumps were declared inoperable due to an observed declining trend in the pump's recirculation flow. The cause of the Safety Injection pump reduced recirculation flow is attributed to foreign material blockage within the associated minimum flow recirculation line flow orifice.
83	Environmental	External Environment	Driver	Demand	Motor	ESW	1985	Failure to Run	Partial	Two service water motors failed on demand as a result of cement dust contamination.
84	Environmental	External Environment	Driver	Demand	I&C	AFW	1984	Failure to Start	Complete	Both AFW pumps failed to start. The problem was traced to two relays (1 per pump). Examination of the relays revealed open circuiting and severe degradation of the insulation.

Item	Coupling Factor	Proximate Cause	Segment	Discovery Method	Piece Part	System	Year	Failure Mode	Degree of Failure	Description
85	Environmental	External Environment	Driver	Maintenance	Motor	ESW	1987	Failure to Start	Partial	During an extended service water bay flooding incident, one ESW pump was found grounded by testing, later two more pumps were found to be failed also.
86	Environmental	External Environment	Driver	Test	Bearing	RHR-B	1991	Failure to Run	Partial	Two LCI pumps were declared inoperable due to high motor vibration.
87	Environmental	External Environment	Pump	Inspection	Coupling	ESW	1993	Failure to Run	Partial	Entrained debris caused ESW pump shaft coupling to fail. Plant equipment did not prevent this debris from entering pump.
88	Environmental	External Environment	Pump	Inspection	Packing/Seals	RHR-P	1985	Failure to Start	Complete	Following a trip, water was found spraying from both low head safety injection pump wedge control rod seals. Both pumps were declared inoperable. Postulated failure on the seals was from a minor flow induced pressure transient.
89	Environmental	External Environment	Suction	Demand	Piping	HPI	1984	Failure to Start	Complete	Boron solidification in the suction and gas binding of pumps led to the failure of all three safety injection pumps. Flushing procedures inadequate.
90	Environmental	Internal to Component	Discharge	Demand	Valve	AFW	1988	Failure to Run	Partial	After automatic start, motor driven AFW pump swapped suction automatically to the nuclear service water system when a sustained low suction pressure condition was sensed, and raw water entered two steam generators. After the initial trip recovery, it was noted that AFW flow to steam generators had degraded following the suction swap. Inspections revealed that the cavitol cages for these valves were clogged with shredded Asiatic clam shells.
91	Environmental	Internal to Component	Discharge	Demand	Valve	AFW	1988	Failure to Run	Partial	After automatic start, motor driven AFW pump swapped suction automatically to the nuclear service water system when a sustained low suction pressure condition was sensed, and raw water entered two steam generators. After the initial trip recovery, it was noted that AFW flow to steam generators had degraded following the suction swap. Inspections revealed that the cavitol cages for these valves were clogged with shredded Asiatic clam shells.
92	Environmental	Internal to Component	Discharge	Test	Recirc	HPI	1991	Failure to Run	Partial	Something in HPI pump recirculation line was restricting flow. The piece later dislodged and no identification was made. Both SI pumps had inadequate recirculation flow.
93	Environmental	Internal to Component	Pump	Demand	Impeller/Wear Rings	ESW	1994	Failure to Run	Partial	Raw water pump currents stayed high after starting. The primary cause of these events was determined to be elevated sand content in the river, resulting in excessive sand accumulation around the suction area of the pumps.
94	Environmental	Internal to Component	Pump	Inspection	Impeller/Wear Rings	ESW	1990	Failure to Start	Partial	ESW pumps had reduced flow and discharge pressure. Marine growth in suction.
95	Environmental	Internal to Component	Pump	Inspection	Packing/Seals	ESW	1994	Failure to Run	Partial	Backup seal water regulators did not provide required flow during testing on two pumps. The third pump lost seal flow while operating. The cause was attributed to plugged lines.
96	Environmental	Internal to Component	Pump	Inspection	Lubrication	HPI	1983	Failure to Run	Partial	Oysters and miscellaneous mollusks plugged HPI oil coolers. Two pumps were required to be shutdown due to rising lubricating oil temperatures.
97	Environmental	Internal to Component	Pump	Maintenance	Lubrication	HPI	1980	Failure to Run	Partial	HPI pump lube oil cooler with tube leak allowed water into oil reservoir.
98	Environmental	Internal to Component	Pump	Maintenance	Lubrication	HPI	1986	Failure to Run	Almost Complete	Clams/sludge fouling of lube oil cooler caused high temperature alarms on two HPI pumps.
99	Environmental	Internal to Component	Pump	Maintenance	Lubrication	HPI	1991	Failure to Run	Partial	HPI pump lube oil cooler leaks. Degraded tubes.
100	Environmental	Internal to Component	Pump	Maintenance	Packing/Seals	ESW	1985	Failure to Run	Partial	First pump developed seal leak due to sand. Second pump had high bearing temperatures due to trash clogging cooling water lines.

Item	Coupling Factor	Proximate Cause	Segment	Discovery Method	Piece Part	System	Year	Failure Mode	Degree of Failure	Description
101	Environmental	Internal to Component	Pump	Test	Impeller/Wear Rings	ESW	1995	Failure to Start	Partial	Pumps failed performance test. Sand in water eroded pump internals. Pump lift was adjusted.
102	Environmental	Internal to Component	Pump	Test	Impeller/Wear Rings	ESW	1982	Failure to Start	Partial	Essential service water pumps were declared inoperable, due to low pump head valves. The low pump heads were caused by excessive wear of pump impeller due to foreign material in the service water.
103	Environmental	Internal to Component	Pump	Test	Impeller/Wear Rings	HPI	1984	Failure to Run	Almost Complete	One HPI pump seized, the second would have seized if operated.
104	Environmental	Internal to Component	Pump	Test	Impeller/Wear Rings	ESW	1982	Failure to Run	Partial	Low ESW pump head valves were caused excessive wear of pump impeller due to foreign material in the service water.
105	Environmental	Internal to Component	Pump	Test	Impeller/Wear Rings	ESW	1993	Failure to Run	Partial	Essential service water pumps were declared inoperable, due to low pump head valves. The low pump heads were caused by excessive wear of pump impeller due to sand in the service water.
106	Environmental	Internal to Component	Pump	Test	Impeller/Wear Rings	ESW	1992	Failure to Start	Partial	ESW pumps had reduced flow and discharge pressure. Worn impellers/wearing rings. Cause determined to be normal wear and high sand content of river water.
107	Environmental	Internal to Component	Pump	Test	Impeller/Wear Rings	ESW	1990	Failure to Run	Partial	ESW pump impeller lift out of adjustment.
108	Environmental	Internal to Component	Pump	Test	Bearing	ESW	1992	Failure to Run	Partial	Abrasive particles present in ocean water produced accelerated wear of shaft bearing journals.
109	Environmental	Internal to Component	Pump	Test	Impeller/Wear Rings	ESW	1995	Failure to Start	Partial	Marine growth caused low flow and speed condition for two service water pumps
110	Environmental	Internal to Component	Pump	Test	Impeller/Wear Rings	ESW	1994	Failure to Start	Partial	Degraded performance identified during testing. Sand in water was causing accelerated wear of the pump internals. Lift was adjusted for three pumps and one pump internals were replaced.
111	Environmental	Internal to Component	Pump	Test	Impeller/Wear Rings	ESW	1985	Failure to Run	Partial	ESW pumps failed to meet the minimum flow requirements of test. A rag was found in one impeller and a plastic bottle in the other.
112	Environmental	Internal to Component	Pump	Test	Impeller/Wear Rings	ESW	1991	Failure to Run	Partial	ESW pumps failed to meet the minimum flow requirements of test. The cause of the failure is normal wearout of the pump impeller due to the high sand content of the water being pumped. Pump impeller lift was adjusted.
113	Environmental	Internal to Component	Suction	Demand	Strainer	ESW	1980	Failure to Run	Partial	Foreign material was allowed to enter the suction of the charging pump service water pumps resulting in low flow conditions.
114	Environmental	Internal to Component	Suction	Demand	Piping	ESW	1986	Failure to Start	Partial	RHR service water pumps failed flow testing due to blocked suctions and abnormal wear of impellers.
115	Environmental	Internal to Component	Suction	Inspection	Strainer	ESW	1984	Failure to Run	Partial	Two RHR service water pumps had blown seals and sparks and smoke between the bearing housing and shaft. A piece of hard rubber valve liner was found in the pumps.
116	Environmental	Internal to Component	Suction	Test	Piping	ESW	1990	Failure to Start	Partial	ESW pumps failed flow testing. Foreign material blocked the suction.
117	Environmental	Internal to Component	Suction	Test	Strainer	ESW	1990	Failure to Run	Partial	Essential service water pumps were declared inoperable, due to low pump head valves. The low pump heads were caused by suction blockage due to foreign material in the service water.
118	Environmental	Internal to Component	Suction	Test	Strainer	ESW	1982	Failure to Run	Partial	Failures occurred on residual heat removal service water pumps. The pumps failed to meet flow and pressure requirements. Failure was due to debris lodging in pump impellers. Source of debris was maintenance activities, broken traveling water screens, and the inadvertent opening of a RHR minimum flow line which washed materials into suction pit.

Item	Coupling Factor	Proximate Cause	Segment	Discovery Method	Piece Part	System	Year	Failure Mode	Degree of Failure	Description
119	Environmental	Other	Driver	Inspection	Motor	AFW	1990	Failure to Start	Partial	Both motor driven AFW pumps were sprayed when a service water pipe developed a through wall leak.
120	Environmental	Other	Driver	Inspection	Motor	ESW	1981	Failure to Run	Partial	The float guide failed in a RHRSW pump air valve and caused the valve to fail open and flood pump room.
121	Maintenance	Design/Construction/Manufacture/Installation Inadequacy	Pump	Inspection	Packing/Seals	ESW	1997	Failure to Run	Partial	Both ESW pumps leaking greater than 4 gpm because of inappropriate material for packing and sleeve (nitronic 60).
122	Maintenance	Design/Construction/Manufacture/Installation Inadequacy	Pump	Test	Impeller/Wear Rings	ESW	1988	Failure to Start	Partial	Essential service water pumps were declared inoperable, due to low pump head valves. The low pump heads were caused by excessive wear of pump impeller due to foreign material in the service water.
123	Maintenance	Design/Construction/Manufacture/Installation Inadequacy	Pump	Test	Casing	ESW	1997	Failure to Run	Almost Complete	Both ESW pumps failed due to installation of wrong material for pump casing flanges by vendor during pump overhaul. The vendor overhauled the pumps without changing material. The plant returned the pumps to the warehouse also without verifying material.
124	Maintenance	Design/Construction/Manufacture/Installation Inadequacy	Suction	Demand	I&C	HPI	1997	Failure to Run	Complete	HPI pumps fail due to operation with inadequate suction head. Two pumps damaged due to operation with inadequate suction, but all three system pumps were unavailable due to the loss of the suction source. Suction source level instrumentation was the cause.
125	Maintenance	External Environment	Driver	Demand	Breaker	AFW	1990	Failure to Run	Partial	AFW pumps circuit breakers degraded.
126	Maintenance	Internal to Component	Discharge	Inspection	Check Valve	AFW	1990	Failure to Start	Almost Complete	Leakage past AFW check valves caused AFW pumps to become steam bound. Closed motor operated valve in line. Scheduled check valves for replacement next outage.
127	Maintenance	Internal to Component	Discharge	Test	Valve	HPI	1984	Failure to Start	Partial	CCP pump low flow rates due to inaccuracies in positioning the throttle valves.
128	Maintenance	Internal to Component	Driver	Demand	I&C	ESW	1991	Failure to Start	Partial	Two ESW pumps failed to start due to failed breakers. Inadequate maintenance.
129	Maintenance	Internal to Component	Driver	Demand	Lubrication	HPI	1984	Failure to Run	Partial	Charging pump lube oil cooler fan motor trips on thermal overload. Probable cause: normal wear on motor resulting in increased friction replaced worn motor with spare. During routine inservice testing found that another charging pump lube oil cooler fan motor had a current imbalance. Probable cause: normal aging of motor insulation has resulted in a current imbalance.
130	Maintenance	Internal to Component	Driver	Demand	Breaker	RHR-B	1987	Failure to Start	Partial	RHR pump breakers failed to close when operated remotely from the control room. It was found that the latch roller bearings and the cam follower bearing (internal piece parts of the breaker) were not operating correctly. This prevented the trip latch assembly from resetting and allowing the breaker to close.

Item	Coupling Factor	Proximate Cause	Segment	Discovery Method	Piece Part	System	Year	Failure Mode	Degree of Failure	Description
131	Maintenance	Internal to Component	Driver	Inspection	Packing/Seals	HPI	1988	Failure to Run	Almost Complete	Smoke was discovered coming from the speed increaser unit for a centrifugal charging pump. Investigation found the two gland seal retaining bolts inside the speed increaser lube oil pump backed out allowing the gland seal to loosen. The gland seal being loosened, caused reduced oil flow to the speed increaser internals and ultimate damage. Other CCPs were inspected, and the same gland seal bolts as on the first pump were found loosened. The cause of the bolts backing out was determined to be lack of a periodic adjustment of the gland seal bolts.
132	Maintenance	Internal to Component	Driver	Inspection	Bearing	ESW	1981	Failure to Run	Partial	ESW motor to pump alignment problems. Bearings worn out.
133	Maintenance	Internal to Component	Driver	Inspection	Breaker	ESW	1996	Failure to Start	Partial	ESW pump breakers fail due to misalignment of the breaker mechanism and internals developed over the years of operation.
134	Maintenance	Internal to Component	Driver	Inspection	Bearing	ESW	1985	Failure to Run	Partial	One service water pump motor upper bearing oil reservoir leaking from cover plate. Another service water pump motor upper oil cooler oil reservoir leaking.
135	Maintenance	Internal to Component	Driver	Maintenance	Breaker	ESW	1985	Failure to Start	Partial	Two raw water pump breaker main wipes were out of adjustment.
136	Maintenance	Internal to Component	Driver	Maintenance	Breaker	SLC	1999	Failure to Start	Partial	SLC Pump Breakers Fail to pickup on degraded voltage test
137	Maintenance	Internal to Component	Driver	Maintenance	Breaker	HPI	1991	Failure to Start	Partial	HPI pump breakers failed due to a broken pawl, and a broken closing coil.
138	Maintenance	Internal to Component	Driver	Maintenance	Breaker	AFW	1992	Failure to Start	Partial	With the unit in a refueling outage, following repairs to a motor driven auxiliary feedwater pump local/remote switch of the circuit breaker, personnel found that the switch contacts would not close. This failure rendered one of three auxiliary feedwater pumps inoperable. The cause of the failure appears to be due to dirty/corroded contacts on the switch.
139	Maintenance	Internal to Component	Driver	Test	Breaker	ESW	1998	Failure to Start	Partial	Two RHR service water pump breakers would not close due to dirty contacts in breakers.
140	Maintenance	Internal to Component	Driver	Test	Breaker	RHR-B	1997	Failure to Start	Partial	Breaker latch check switch failed on both pumps. Lack of lubrication.
141	Maintenance	Internal to Component	Driver	Test	Bearing	ESW	1985	Failure to Run	Partial	Service water pumps exhibited vibration. Attributed to normal wear.
142	Maintenance	Internal to Component	Driver	Test	Breaker	ESW	1998	Failure to Start	Partial	Service water pumps fail to start due to circuit breaker failures. Pump breakers failed to close due to failures of the charging spring/motor and closing spring motor.
143	Maintenance	Internal to Component	Driver	Test	Breaker	AFW	1997	Failure to Start	Almost Complete	The circuit breakers associated with the AFW Pumps failed to close as required. The root cause of the failure was the binding in the operating mechanism. The plunger apparently did not always complete its upward movement to close and latch the breaker, due to accumulated dirt and lubricants.
144	Maintenance	Internal to Component	Driver	Test	Breaker	RHR-B	1986	Failure to Start	Partial	RHR pump circuit breakers failed during a start for testing. Bend switch and binding mechanism. Attributed to inadequate maintenance.
145	Maintenance	Internal to Component	Pump	Demand	Bearing	AFW	1984	Failure to Run	Partial	One ESW bearing failed and pump seized; second motor bearing failed.
146	Maintenance	Internal to Component	Pump	Demand	Casing	ESW	1998	Failure to Start	Partial	Two ESW pump started and ran, but would not develop sufficient pressure or flow rate. Exact cause not known for either failure, however, one pump was noted to have microbiological induced corrosion fouling on internal surfaces.

Item	Coupling Factor	Proximate Cause	Segment	Discovery Method	Piece Part	System	Year	Failure Mode	Degree of Failure	Description
147	Maintenance	Internal to Component	Pump	Demand	Packing/Seals	AFW	1998	Failure to Run	Partial	AFW MDP and TDPs failed due to incorrect packing installed.
148	Maintenance	Internal to Component	Pump	Inspection	Bearing	ESW	1987	Failure to Run	Partial	Service water pumps had high shaft vibration. The excessive vibrations caused by worn bearings and shaft sleeves.
149	Maintenance	Internal to Component	Pump	Inspection	Packing/Seals	AFW	1990	Failure to Run	Partial	Both motor-driven aux. feedwater pumps had excessive packing leaks, due to worn packing.
150	Maintenance	Internal to Component	Pump	Inspection	Bearing	SLC	1989	Failure to Run	Partial	Standby Liquid Control pumps lost oil while running. Loose fittings and lack of thread sealant.
151	Maintenance	Internal to Component	Pump	Inspection	Casing	ESW	1986	Failure to Run	Partial	Cracked seal water and vent lines.
152	Maintenance	Internal to Component	Pump	Inspection	Packing/Seals	ESW	1989	Failure to Run	Partial	ESW pump excessive packing leakage.
153	Maintenance	Internal to Component	Pump	Inspection	Packing/Seals	ESW	1986	Failure to Run	Partial	Excessive packing leakage. Both events occurred after previous maintenance had been performed for the same problems.
154	Maintenance	Internal to Component	Pump	Inspection	Casing	ESW	1988	Failure to Run	Partial	RHR service water pumps. Pump diffuser eroded on first pump and a through wall casing leak developed on the second.
155	Maintenance	Internal to Component	Pump	Inspection	Lubrication	RHR-B	1990	Failure to Run	Partial	Both pump motor oil coolers were leaking due to aging of components. The first case involved through wall corrosion and the pump was immediately removed from service. The second case was a packing leak.
156	Maintenance	Internal to Component	Pump	Inspection	Packing	AFW	1986	Failure to Run	Partial	The packing was worn on both the motor-driven and one turbine-driven aux. feedwater pump, causing high temperature on one packing gland, and excessive leaking on the other pump.
157	Maintenance	Internal to Component	Pump	Inspection	Packing/Seals	SLC	1987	Failure to Run	Partial	Standby Liquid Control pumps were observed to be leaking excessively at the packing. The failure of the packing was attributed to normal wear. Packing adjusted.
158	Maintenance	Internal to Component	Pump	Inspection	Plunger/Cylinder	SLC	1989	Failure to Run	Partial	Standby Liquid Control pump seal was leaking excessively. The cause of this failure was normal wear of the plungers, packing, and head gaskets for the plungers (piece parts of the pump).
159	Maintenance	Internal to Component	Pump	Inspection	Packing/Seals	SLC	1988	Failure to Run	Partial	Standby Liquid Control pumps were observed to be leaking excessively at the packing. The failure of the packing was attributed to normal wear. Packing replaced.
160	Maintenance	Internal to Component	Pump	Inspection	Impeller/Wear Rings	ESW	1985	Failure to Run	Partial	Service water pumps were noted to have high vibrations and low discharge pressure. The cause of the failure is suspected to be binding.
161	Maintenance	Internal to Component	Pump	Inspection	Packing/Seals	SLC	1989	Failure to Run	Partial	Standby Liquid Control pumps were observed to be leaking profusely at the packing. The failure of the packing was attributed to normal wear.
162	Maintenance	Internal to Component	Pump	Maintenance	Bearing	ESW	1985	Failure to Run	Partial	High ESW pump vibration was caused by wearing of the upper bearings.
163	Maintenance	Internal to Component	Pump	Test	Impeller/Wear Rings	ESW	1985	Failure to Run	Partial	ESW pumps failed due to worn internals.
164	Maintenance	Internal to Component	Pump	Test	Impeller/Wear Rings	ESW	1984	Failure to Start	Partial	Essential service water pumps were declared inoperable, due to low pump head values. The low pump heads were caused by wear and aging of internals.
165	Maintenance	Internal to Component	Pump	Test	Coupling	ESW	1987	Failure to Start	Almost Complete	Two ESW pumps had failed couplings. Cause attributed to abnormal stress.

Item	Coupling Factor	Proximate Cause	Segment	Discovery Method	Piece Part	System	Year	Failure Mode	Degree of Failure	Description
166	Maintenance	Internal to Component	Pump	Test	Impeller/Wear Rings	ESW	1988	Failure to Start	Partial	Essential service water pumps were declared inoperable, due to low pump head valves. The low pump heads were caused by wear and aging of internals.
167	Maintenance	Internal to Component	Pump	Test	Impeller/Wear Rings	ESW	1982	Failure to Run	Partial	Loss of Service Water pump due to wearout at end of life.
168	Maintenance	Internal to Component	Pump	Test	Impeller/Wear Rings	ESW	1989	Failure to Start	Partial	ESW pumps had reduced flow and discharge pressure. Worn impellers/wearing rings.
169	Maintenance	Internal to Component	Pump	Test	Impeller/Wear Rings	HPI	1985	Failure to Start	Partial	The CCPs were tested and had low flow rates. The most probable cause is attributed to observed degradation of the pumps. The CCPs are subject to normal wear associated with their secondary duty of providing normal charging flow.
170	Maintenance	Internal to Component	Pump	Test	Impeller/Wear Rings	ESW	1994	Failure to Start	Partial	Two ESW pumps had low discharge pressure during testing. Each pump had worn internals and both pump internals were replaced.
171	Maintenance	Internal to Component	Pump	Test	Impeller/Wear Rings	RHR-B	1985	Failure to Start	Partial	The first pump failed to meet required flow rate. The second was drawing excessive amperage. Both conditions were attributed to worn internals.
172	Maintenance	Internal to Component	Pump	Test	Impeller/Wear Rings	ESW	1984	Failure to Run	Partial	Containment spray raw water pumps failed flow tests. Aging and normal wear.
173	Maintenance	Internal to Component	Pump	Test	Shaft	ESW	1993	Failure to Run	Partial	Service water pumps were noted to have high vibrations and low discharge pressure. Uneven wear caused pump to be out of balance.
174	Maintenance	Internal to Component	Pump	Test	Impeller/Wear Rings	ESW	1988	Failure to Start	Partial	Service water pumps were noted to have high vibrations and low discharge pressure. Uneven wear caused pump to be out of balance.
175	Maintenance	Internal to Component	Pump	Test	Impeller/Wear Rings	HPI	1983	Failure to Start	Partial	SI pump and both CCPs failed to meet the minimum head curve requirements. The cause of pump head capacity degradation has been attributed to normal pump operation. The inability to balance flows has been attributed to the lower head capacity of the pumps.
176	Maintenance	Internal to Component	Pump	Test	Impeller/Wear Rings	ESW	1990	Failure to Start	Partial	ESW impeller gaps too wide. Gaps adjusted.
177	Maintenance	Internal to Component	Pump	Test	Impeller/Wear Rings	ESW	1998	Failure to Start	Partial	Two ESW pumps failed to develop adequate flow/pressure - pumps degraded.
178	Maintenance	Internal to Component	Pump	Test	Lubrication	SLC	1992	Failure to Run	Partial	Standby Liquid Control pumps lost oil while running. The gasket between the crankcase frame cap and the gear housing cover was worn.
179	Maintenance	Internal to Component	Pump	Test	Coupling	ESW	1990	Failure to Start	Partial	ESW pumps had reduced flow and discharge pressure. Worn impellers/wearing rings. Cause determined to be normal wear and high sand content of river water.
180	Maintenance	Internal to Component	Pump	Test	Impeller/Wear Rings	ESW	1981	Failure to Start	Partial	Loss of Service Water pump due to wearout at end of life.
181	Maintenance	Internal to Component	Pump	Test	Impeller/Wear Rings	ESW	1985	Failure to Run	Partial	Wear caused high ESW pump bearing temperatures, vibration, and low amperage/flow.
182	Maintenance	Internal to Component	Pump	Test	Impeller/Wear Rings	ESW	1986	Failure to Run	Partial	ESW pump performance decreased 15% and 8% respectively since last test. Pumps were replaced.
183	Maintenance	Internal to Component	Pump	Test	Impeller/Wear Rings	ESW	1986	Failure to Run	Partial	ESW pumps had worn impellers and one had a plugged strainer.
184	Maintenance	Internal to Component	Pump	Test	Impeller/Wear Rings	ESW	1994	Failure to Run	Partial	Two ESW pumps had internal deterioration, one of which was indicated by high vibration readings.
185	Maintenance	Internal to Component	Pump	Test	Impeller/Wear Rings	ESW	1992	Failure to Start	Partial	ESW pumps had reduced flow and discharge pressure. Worn impellers/wearing rings. One pump also exhibited high vibration.

Item	Coupling Factor	Proximate Cause	Segment	Discovery Method	Piece Part	System	Year	Failure Mode	Degree of Failure	Description
186	Maintenance	Internal to Component	Pump	Test	Impeller/Wear Rings	ESW	1988	Failure to Run	Partial	ESW pumps failed to meet the minimum flow requirements of test. The cause of the failure is normal wearout of the pump impeller due to brackish water corrosion.
187	Maintenance	Internal to Component	Pump	Test	Impeller/Wear Rings	ESW	1987	Failure to Run	Partial	ESW pump low flow. Worn impellers.
188	Maintenance	Internal to Component	Pump	Test	Impeller/Wear Rings	ESW	1990	Failure to Run	Partial	ESW pumps had worn and cracked impellers. Aging and normal wear.
189	Maintenance	Internal to Component	Pump	Test	Impeller/Wear Rings	ESW	1985	Failure to Run	Partial	The charging pump service water pumps degraded. Caused by expected wear of pump due to erosion and corrosion properties of the process fluid involved
190	Maintenance	Internal to Component	Pump	Test	Packing/Seals	ESW	1981	Failure to Start	Partial	RHR service water pumps failed to meet flow requirements due to seal water leakage and pump wearout.
191	Maintenance	Internal to Component	Pump	Test	Impeller/Wear Rings	ESW	1991	Failure to Start	Partial	ESW pumps had reduced flow and discharge pressure. Worn impellers/wearing rings.
192	Maintenance	Internal to Component	Pump	Test	Impeller/Wear Rings	ESW	1992	Failure to Start	Partial	ESW pumps had reduced flow and discharge pressure. Worn impellers/wearing rings.
193	Maintenance	Internal to Component	Pump	Test	Impeller/Wear Rings	ESW	1984	Failure to Run	Partial	Loss of Service Water pump due to wearout at end of life.
194	Maintenance	Internal to Component	Pump	Test	Impeller/Wear Rings	ESW	1988	Failure to Start	Partial	ESW pumps had reduced flow and discharge pressure. Worn impellers/wearing rings.
195	Maintenance	Internal to Component	Pump	Test	Impeller/Wear Rings	ESW	1985	Failure to Start	Partial	Emergency service water pumps discharge pressure below allowable limits. Causes were loose impellers, dropped impeller, and worn internals.
196	Maintenance	Internal to Component	Pump	Test	Bearing	ESW	1985	Failure to Run	Partial	ESW pumps had reduced flow and discharge pressure. Worn impellers/wearing rings.
197	Maintenance	Internal to Component	Pump	Test	Impeller/Wear Rings	ESW	1983	Failure to Run	Partial	RHR Service Water pumps failed flow tests due to wearout and had to be rebuilt.
198	Maintenance	Internal to Component	Pump	Test	Impeller/Wear Rings	ESW	1990	Failure to Start	Partial	ESW pumps had reduced flow and discharge pressure. Worn impellers/wearing rings.
199	Maintenance	Internal to Component	Pump	Test	Impeller/Wear Rings	ESW	1985	Failure to Start	Partial	ESW pumps had reduced flow and discharge pressure. Worn impellers/wearing rings.
200	Maintenance	Internal to Component	Pump	Test	Impeller/Wear Rings	ESW	1985	Failure to Start	Partial	ESW pumps failed to meet the minimum flow requirements of test. The cause of the failure is normal wearout of the pump impeller due to the high sand content of the water being pumped. Pump impeller lift was adjusted.
201	Maintenance	Operational/ Human Error	Driver	Demand	Breaker	ESW	1993	Failure to Start	Partial	Operations personnel were attempting to swap the running service water pump with the idle service water pump. Personnel placed the control switch to start and the service water pump did not start. Breaker malfunction. Later, another service water pump failed to start because of the breaker.
202	Maintenance	Operational/ Human Error	Driver	Demand	Breaker	ESW	1988	Failure to Run	Partial	Service water pump high dropout over current protection devices were less than running current conditions and trip setpoints did not account for changing load conditions due to modified impellers. Three pump trips had occurred.
203	Maintenance	Operational/ Human Error	Driver	Demand	Breaker	ESW	1987	Failure to Start	Partial	One breaker failed to linkage alignment and second from loose relay connections. Inadequate maintenance.
204	Maintenance	Operational/ Human Error	Driver	Inspection	Breaker	RHR-P	1981	Failure to Start	Complete	All RHR pumps de-energized to replace RHR Relief valve. T.S. allows this condition for 1 hour. Operated in the mode in excess of 5 hours.

Item	Coupling Factor	Proximate Cause	Segment	Discovery Method	Piece Part	System	Year	Failure Mode	Degree of Failure	Description
205	Maintenance	Operational/ Human Error	Driver	Inspection	I&C	RHR-P	1992	Failure to Start	Complete	Both trains of RHR were rendered inoperable for two minutes, while performing an operational readiness test surveillance procedure. The surveillance procedure required that the one RHR train pump be placed in pull to lock and the other train heat exchanger flow control valve throttled to 30-40% open. The procedure directed the operators to perform operations that resulted in both trains of RHR being inoperable
206	Maintenance	Operational/ Human Error	Driver	Inspection	Bearing	RHR-P	1988	Failure to Run	Partial	Residual heat removal pump motor upper bearing housings were observed to be leaking oil. The cause of the failure was attributed to a lack of sealant being applied and gasket installed after the last maintenance was performed on the motor bearing housing.
207	Maintenance	Operational/ Human Error	Driver	Inspection	I&C	AFW	1990	Failure to Start	Complete	During testing one AFW pump was tested and other was tested without returning first to auto. Both pumps were unavailable at the same time. The procedure was the cause.
208	Maintenance	Operational/ Human Error	Driver	Maintenance	Breaker	RHR-B	1990	Failure to Start	Partial	RHR pump breaker overcurrent trips out of calibration.
209	Maintenance	Operational/ Human Error	Driver	Maintenance	Breaker	RHR-B	1991	Failure to Start	Partial	While performing preventive maintenance calibration check on the protective relays for a residual heat removal pump motor 4kv breaker, it was found that all overcurrent relays for two pumps were out of calibration
210	Maintenance	Operational/ Human Error	Driver	Test	I&C	ESW	1989	Failure to Start	Partial	Emergency equipment service water pump relays were not reset following a load shedding test 30 hours before.
211	Maintenance	Operational/ Human Error	Driver	Test	Motor	ESW	1994	Failure to Run	Partial	Leak test of the containment cooling service water pump vault watertight door revealed excessive leakage. Flooding and leakage past this door would make inoperable two of four containment cooling service water pumps. Procedural inadequacy was cited as the cause for the degraded door seals.
212	Maintenance	Operational/ Human Error	Pump	Demand	Casing	AFW	1983	Failure to Run	Partial	During testing, the outboard bearing temperature was high on the turbine-driven AFW pump, due to improper balance drum clearances, caused by improper maintenance. The procedure will be modified and the balance drum clearance reset. While the unit was starting up, the motor-driven AFW pump outboard bearing temperature was high. Excessive thrust bearing clearance caused the balance drum to unbalance, causing the thrust bearing to overheat.
213	Maintenance	Operational/ Human Error	Pump	Maintenance	Lubrication	HPI	1991	Failure to Run	Partial	Following an overhaul of the HPI pumps. Too much oil flow led to excessive oil leakage, which would have failed HPI pumps before end of mission.
214	Maintenance	Operational/ Human Error	Pump	Test	Casing	RHR-P	1989	Failure to Start	Complete	Both loops of the residual heat removal system were declared inoperable due to gas binding of both RHR pumps. The gas binding was caused by entry of nitrogen gas into the reactor coolant system from accumulator. The root cause of this event has been attributed to personnel error. Personnel did not comply with the specific requirements in the accumulator discharge check valve full flow test procedure due to inattention to detail.
215	Maintenance	Operational/ Human Error	Pump	Test	Packing/Seals	AFW	1996	Failure to Run	Partial	During the performance of Steam-Driven Emergency Feedwater Pump testing, sparks were observed emanating from the outboard mechanical seal area. The sparks appeared to be due to a mechanical interference within the mechanical seal assembly. The pump mechanical seal was disassembled and determined to have been improperly installed during the last refueling outage. The evaluation identified a mechanical seal design deficiency and inadequate corrective action for a previously identified event as the primary causes for this event. A contributing cause for this event was found to be inadequate predictive maintenance techniques. The electric AFW pump exhibited the same problem.

Item	Coupling Factor	Proximate Cause	Segment	Discovery Method	Piece Part	System	Year	Failure Mode	Degree of Failure	Description
216	Maintenance	Operational/ Human Error	Suction	Demand	Piping	ESW	1996	Failure to Run	Complete	Both trains of both units charging pump service water pumps became air bound. Underwater diving maintenance activities on one units circulating water and service water lines was identified as the source of the air. The air entered the service water supply lines when a valve was opened in preparation for a Safety Injection logic test.
217	Maintenance	Operational/ Human Error	Suction	Demand	Piping	ESW	1996	Failure to Run	Complete	Both trains of both units charging pump service water pumps became air bound. Underwater diving maintenance activities on one units circulating water and service water lines was identified as the source of the air. The air entered the service water supply lines when a valve was opened in preparation for a Safety Injection logic test.
218	Maintenance	Operational/ Human Error	Suction	Inspection	Valve	SLC	1991	Failure to Start	Partial	SLC pumps were potentially inoperable during part of test due to valve lineup.
219	Maintenance	Operational/ Human Error	Suction	Maintenance	Strainer	HPI	1985	Failure to Run	Partial	Strainers found still installed in the suction piping of the high-pressure injection pumps was a condition not considered in the operating design. The strainers were found during maintenance to repair a slight flange leak. The strainers had been placed in the suction piping during construction and were to be in place during system flushing to prevent any debris from reaching the pumps. However, the strainers should have been removed after system flushing prior to functional testing
220	Maintenance	Operational/ Human Error	Suction	Maintenance	Piping	RHR-P	1982	Failure to Run	Complete	Shutdown cooling was lost due to nitrogen intrusion because of backflushing a filter in the purification system.
221	Maintenance	Other	Discharge	Demand	Valve	ESW	1980	Failure to Start	Partial	RHR service water pumps were started to put torus cooling in service. When these pumps would not deliver required discharge pressure, they were declared inoperable. The seal in an air release valve was bad, allowing a vent on the discharge line.
222	Maintenance	Other	Driver	Demand	I&C	ESW	1982	Failure to Start	Complete	Following a reactor scram, an attempt to initiate suppression pool cooling revealed that both RHRSW loops were inoperable as neither loop's pumps could be started. Low suction header pressure lockout signals in each loop prevented starting each loop's pumps. Plugging of the sensing line to each loop's suction header pressure switch prevented both switches from sensing actual pressure, although a lack of operating fluid in one switch and an open power supply breaker to the other switch also would have prevented pumps from starting.
223	Maintenance	Other	Driver	Demand	Breaker	RHR-P	1987	Failure to Start	Complete	Two LPI pumps, when given a start signal, would not start. An ongoing investigation revealed the probable root cause of the event to be poor electrical contact of the breaker auxiliary stabs for the pumps.
224	Maintenance	Other	Driver	Maintenance	Breaker	ESW	1984	Failure to Start	Partial	ESW pump breaker failures, broken screw, no lubrication, and a bent track
225	Maintenance	Other	Driver	Maintenance	Breaker	ESW	1982	Failure to Start	Partial	ESW pump circuit breakers found damaged. Defective arc chute and cracked secondary coupler.
226	Maintenance	Other	Driver	Test	Breaker	ESW	1984	Failure to Start	Partial	ESW pump breakers tripped due to failed voltage control devices.
227	Maintenance	Other	Driver	Test	Breaker	ESW	1984	Failure to Start	Partial	ESW pump breaker overcurrent trip devices tripping too low.
228	Maintenance	Other	Suction	Demand	Piping	RHR-P	1980	Failure to Run	Complete	A complete loss of RHR flow occurred while plant operators were increasing RHR heat exchanger flow by closing down on the heat exchanger bypass valve.

Item	Coupling Factor	Proximate Cause	Segment	Discovery Method	Piece Part	System	Year	Failure Mode	Degree of Failure	Description
229	Maintenance	Other	Suction	Demand	Piping	RHR-P	1981	Failure to Run	Complete	Temporary coolant loop level indicator showed level slowly increasing over a period of days. The system was periodically drained to maintain 65 percent indicated level. A RHR pump lost suction on reduction of actual level. The second pump was started, and lost suction. Indication drift was due to evaporation of reference leg.
230	Maintenance	Other	Suction	Demand	Piping	RHR-P	1986	Failure to Run	Complete	SDC pumps cavitated due to lowering RCS level. Level indication was in error.
231	Maintenance	Other	Suction	Demand	Piping	RHR-P	1983	Failure to Run	Complete	The RHR pumps began to cavitate and eventually both pumps were stopped. The reactor vessel level gauge being used to provide an indication that the level was approaching the vessel flange level had been isolated (reactor coolant drain tank isolation valve had been closed during an attempt to reduce leakage). Additionally, procedures did not require visual monitoring of cavity level.
232	Operational	Design/ Construction/ Manufacture/ Installation Inadequacy	Discharge	Test	Check Valve	ESW	1999	Failure to Run	Partial	Two ESW pumps had low flow due to interaction with the two other pumps when all four pumps were running.
233	Operational	External Environment	Driver	Inspection	I&C	HPI	1990	Failure to Run	Complete	It was determined that the common minimum flow path return line for the safety injection pumps to the refueling water storage tank was frozen. Previous actions to investigate problems with the freeze protection system were unsuccessful in preventing development of this condition. The two HPI pumps were declared inoperable with this return line frozen. A faulty ambient temperature switch for the RWST heat trace system prevented the heat trace from activating and was subsequently replaced. In addition, administrative controls did not sufficiently recognize the safety significance of flow through this line and the need to ensure flow capability.
234	Operational	Operational/ Human Error	Discharge	Inspection	Valve	HPI	1987	Failure to Start	Almost Complete	While attempting to fill the safety injection accumulators, it was discovered that two of three SI pumps had been isolated from the high head injection flowpath.
235	Operational	Operational/ Human Error	Discharge	Inspection	Valve	HPI	1993	Failure to Run	Partial	One AFW pump failed due to incorrect procedure which allowed pump to be run without flow, other AFW pump was allowed to run past max flow rate. It is unclear whether these mistakes were due to inadequate procedures or staff errors, but it was assumed to be a failure to follow procedure.
236	Operational	Operational/ Human Error	Discharge	Inspection	Valve	AFW	1994	Failure to Start	Complete	Following a trip, the AFW Pumps were secured and the discharge flow control valves for the Motor Driven Pumps were closed. Later, an operator discovered during a routine Control Board walkdown that the valves were closed. Subsequent investigation revealed the AFW system had not been placed in standby readiness per the operating procedure after the system was secured.
237	Operational	Operational/ Human Error	Driver	Demand	I&C	ESW	1981	Failure to Start	Partial	Alarm circuit breaker was de-energized resulting in a loss of two RHR service water pumps.
238	Operational	Operational/ Human Error	Driver	Demand	I&C	AFW	1983	Failure to Start	Complete	An operator incorrectly secured the diesel and steam driven AFW pumps, which prevented their restart on low SG level.
239	Operational	Operational/ Human Error	Driver	Inspection	I&C	HPI	1988	Failure to Start	Complete	With alternate CCP pump out-of-service, the remaining operable pump was erroneously placed in pull-to-lock.
240	Operational	Operational/ Human Error	Driver	Inspection	I&C	RHR-P	1995	Failure to Start	Complete	The switches for the containment spray and recirculation pumps were in a trip pullout when the Technical Specifications and plant procedures required the pumps to be operable.

Item	Coupling Factor	Proximate Cause	Segment	Discovery Method	Piece Part	System	Year	Failure Mode	Degree of Failure	Description
241	Operational	Operational/ Human Error	Driver	Inspection	Breaker	ESW	1981	Failure to Start	Almost Complete	Control breakers for two ESW pumps were open due to inadvertent operator action.
242	Operational	Operational/ Human Error	Driver	Inspection	Breaker	HPI	1988	Failure to Start	Complete	HPI pumps not restored before mode change due to procedural inadequacy.
243	Operational	Operational/ Human Error	Driver	Inspection	I&C	HPI	1992	Failure to Start	Almost Complete	Two charging pumps and one charging pump service water pump were removed from service simultaneously which is a condition not allowed by technical specifications.
244	Operational	Operational/ Human Error	Driver	Inspection	I&C	HPI	1990	Failure to Start	Partial	Both safety injection pumps were in the pull-to-lock position. With the switches in pull-to-lock, the pumps would not have automatically started upon receipt of an initiating signal. This event was caused by cognitive personnel error by a utility licensed operator in failure to follow an approved procedure.
245	Operational	Operational/ Human Error	Driver	Inspection	Breaker	HPI	1982	Failure to Start	Complete	During the draining of the reactor coolant system, both centrifugal charging pumps were rendered inoperable. The initial conditions in the draining procedure contained a confusing statement, which led to an erroneous assumption that both CCP breakers had to be racked out and tagged.
246	Operational	Operational/ Human Error	Driver	Inspection	Breaker	HPI	1989	Failure to Start	Partial	HPI Pump B not retested, then HPI Pump A removed from service.
247	Operational	Operational/ Human Error	Driver	Inspection	Breaker	HPI	1990	Failure to Start	Complete	By opening incorrect breaker, HPI pump tripped while others were unavailable.
248	Operational	Operational/ Human Error	Driver	Inspection	Breaker	CSS	1991	Failure to Start	Complete	CSR control power de-energized prior to mode change. Technical Specification violation. Inadequate procedure review.
249	Operational	Operational/ Human Error	Driver	Test	I&C	ESW	1990	Failure to Start	Complete	An emergency service water pump failed to start and was declared inoperable. Further investigation determined that the failure of the pump to start was due to a tripped emergency engine shutdown device. Operations personnel performing the testing did not recognize the need to reset it prior to starting the pump. Examination of the other two ESW pumps revealed that their emergency shutdown devices were also in the tripped condition.
250	Operational	Operational/ Human Error	Pump	Inspection	Lubrication	HPI	1983	Failure to Start	Complete	A routine preventive maintenance (oil change) was mistakenly performed on the north charging pump instead of the south as scheduled. Since the south pump was previously cleared for this oil change, and the test pump was valved out, none of these three pumps were in service as required by tech specs for the approximately 20 minutes it took to change the oil in the north pump.
251	Operational	Operational/ Human Error	Pump	Maintenance	Lubrication	ESW	1993	Failure to Run	Partial	Low pressure RHR bearing oil level not maintained high enough when new smaller sightglass installed. Second event the sightglass was broken when adding oil.
252	Operational	Operational/ Human Error	Suction	Demand	Piping	RHR-P	1980	Failure to Run	Complete	While attempting to increase RHR flow, the plant experienced a total loss of flow due to the pumps being air-bound. The pump was not vented when starting to increase flow. Operating procedures have been changed to have an operator present while changing flow in the RHR system. There have been losses of RHR flow in the past because the pumps were air-bound and methods are being investigated to improve the system design.
253	Operational	Operational/ Human Error	Suction	Demand	Piping	ESW	1986	Failure to Run	Complete	Failure to properly vent and fill a newly installed pipe introduced air into the charging pump service water system.

Item	Coupling Factor	Proximate Cause	Segment	Discovery Method	Piece Part	System	Year	Failure Mode	Degree of Failure	Description
254	Operational	Operational/ Human Error	Suction	Demand	Piping	RHR-P	1984	Failure to Run	Complete	The control room operators started a second residual heat removal pump in preparation for removing the operating RHR pump from service. With both pumps running, flow became excessive for the half-loop condition causing cavitation and air binding of both pumps. To prevent recurrence the procedure which controls the operation of the RHR pumps has been changed to include specific instructions to stop the operating pump prior to starting the second pump while at half-loop.
255	Operational	Operational/ Human Error	Suction	Demand	Booster Pump	ESW	1980	Failure to Start	Partial	The service water RHR booster pump was de-energized during maintenance. The attempt to start service water pumps failed due to low suction pressure.
256	Operational	Operational/ Human Error	Suction	Demand	Piping	ESW	1988	Failure to Run	Complete	The procedure failed to adequately caution the operator to slowly fill a drained line. Rapid filling resulted in a loss of NPSH to the charging service water pumps.
257	Operational	Operational/ Human Error	Suction	Maintenance	Strainer	ESW	1986	Failure to Run	Complete	A service water strainer was placed in service without being vented resulting in air binding system and loss of charging pump service water pumps.
258	Operational	Operational/ Human Error	Suction	Test	Piping	ESW	1989	Failure to Run	Partial	Inadequate procedure led to air binding of operating ESW pumps.
259	Operational	Other	Pump	Inspection	Bearing	ESW	1991	Failure to Run	Partial	Lube oil cooling water isolated during a test. Pumps continued to run with no cooling.
260	Quality	Design/ Construction/ Manufacture/ Installation Inadequacy	Driver	Demand	Motor	ESW	1987	Failure to Start	Partial	ESW pump motors tripped on overcurrent. The overcurrent trip was due to a ground and a short on the pump motor.
261	Quality	Design/ Construction/ Manufacture/ Installation Inadequacy	Driver	Demand	Breaker	ESW	1996	Failure to Start	Partial	Two RHRSW pumps fail to start due to breaker failures. Wrong contacts were installed. Design called for contacts to have a minimum current interrupt rating of 6 amps; contacts installed (that subsequently failed) had current interrupt rating of only 2.2 amps.
262	Quality	Design/ Construction/ Manufacture/ Installation Inadequacy	Driver	Demand	I&C	AFW	1989	Failure to Start	Complete	Both motor driven auxiliary feedwater pumps failed to start when the operator tried to start them manually. While preparing a design change, the designer failed to review all the unit specific documentation associated with the motor-driven AFW pump wiring and made the erroneous assumption that both units switchgear compartment internal wiring was identical. In fact, the wiring for each unit was different. Consequently, when the design change was installed, it was installed in accordance with the erroneous design. The wiring discrepancy was corrected and the motor-driven AFW pumps were tested and returned to service.
263	Quality	Design/ Construction/ Manufacture/ Installation Inadequacy	Driver	Test	Breaker	LCS	1980	Failure to Start	Complete	Relay extra contacts left connected during construction, prevented Core Spray pump start with emergency diesel generator breakers racked out.

Item	Coupling Factor	Proximate Cause	Segment	Discovery Method	Piece Part	System	Year	Failure Mode	Degree of Failure	Description
264	Quality	Design/ Construction/ Manufacture/ Installation Inadequacy	Driver	Test	I&C	AFW	1980	Failure to Start	Complete	During surveillance testing, neither motor-driven AFW pump would start. The pump control circuit was found with autostart defeat switches labeled backwards, causing all autostarts except the low-low steam generator level to be defeated. The labels were corrected and the links were closed. The original installation error was the result of an inadequate design change process that did not require sufficient verification and testing of the modification.
265	Quality	Design/ Construction/ Manufacture/ Installation Inadequacy	Pump	Demand	Impeller/Wear Rings	ESW	1988	Failure to Run	Partial	ESW pumps drawing excessive current. Carbon steel snap rings corroded allowing impeller to come in contact with casing. The third pump, although not exhibiting abnormal current, had similar corrosion
266	Quality	Design/ Construction/ Manufacture/ Installation Inadequacy	Pump	Demand	Impeller/Wear Rings	ESW	1996	Failure to Run	Partial	A Nuclear Service Water pump tripped on overcurrent after operating for approximately 20 minutes. Initial troubleshooting indicated that the pump was binding and disassembly was required to determine the cause. It was determined that the pump impeller thrust ring had become loose due to thrust ring retainer bolt failure, which allowed the impeller to slip on the shaft and resulted in pump binding and the overcurrent condition. The bolts failed due to corrosion. Similar bolt degradation was discovered on other service water pumps. The investigation results indicate the primary cause of the bolt failures was corrosion induced by galvanic coupling of the retainer bolting and other pump components.
267	Quality	Design/ Construction/ Manufacture/ Installation Inadequacy	Pump	Inspection	Casing	AFW	1983	Failure to Run	Partial	Two AFW pumps thrust tolerance was out of specification. These events were caused by improperly installed balancing drum parts. One turbine driven and one motor driven pump was involved.
268	Quality	Design/ Construction/ Manufacture/ Installation Inadequacy	Pump	Inspection	Casing	HPI	1987	Failure to Run	Partial	During inspection of a centrifugal charging pump, a portion of the stainless steel cladding on the inside surface of the pump casing exhibited corrosion. Corrosion of the pump casing was through the stainless steel cladding into the carbon steel base material. Inspection of the other CCP revealed similar corrosion. The cause of this event was a manufacturing deficiency. Corrosion observed at the pump casing discharge nozzle was attributed to a cladding breakthrough during final machining. Corrosion observed at the pump casing inlet end was attributed to either over-machining of the cladding or inadequate overlay of two adjacent weld beads.
269	Quality	Design/ Construction/ Manufacture/ Installation Inadequacy	Pump	Test	Impeller/Wear Rings	ESW	1986	Failure to Start	Partial	Testing of the service water system disclosed that the performance of the three service water pumps was below requirements. The condition is the result of both an inadequate system design and the installation of replacement impellers, which were not modified by the vendor to improve performance, as were the original impellers.
270	Quality	Design/ Construction/ Manufacture/ Installation Inadequacy	Suction	Demand	Piping	ESW	1984	Failure to Start	Partial	Both RHR service water pumps tripped as a result of inadequate venting of suction header resulting from poor orientation of the vent line.

Item	Coupling Factor	Proximate Cause	Segment	Discovery Method	Piece Part	System	Year	Failure Mode	Degree of Failure	Description
271	Quality	Design/ Construction/ Manufacture/ Installation Inadequacy	Suction	Inspection	Piping	HPI	1988	Failure to Run	Partial	Vortex breakers had not been installed in the containment emergency sumps. Vortex breakers are required to be installed in the containment emergency sumps to prevent the formation of vortices which could adversely affect performance of safety injection pumps during the safety injection and containment spray systems were declared inoperable.
272	Quality	Internal to Component	Pump	Demand	Impeller/Wear Rings	AFW	1988	Failure to Run	Partial	Following a plant trip, it was discovered that the auxiliary feedwater pumps had internal damage. Some channel ring vanes had chips missing, and several parts were found in the SG auxiliary feedwater piping.
273	Quality	Operational/ Human Error	Driver	Inspection	Breaker	ESW	1992	Failure to Start	Partial	The fit between an ESW pump breaker primary disconnects and the associated breaker cubicle stabs was inadequate. The poor fit between the disconnects and the stabs led to arcing in the breaker cubicle when the pump was started, resulting in a fire. Shortly after identifying the cause of the fire, the remaining ESW breakers, which had recently been replaced along with the failed breaker, as part of a design modification package, were found to be inadequate also.
274	Quality	Operational/ Human Error	Driver	Test	I&C	ESW	1982	Failure to Start	Partial	Two ESW pumps failed to start. One ESW pump failed to function as a result of loose wires on relay terminals in both pump logic schemes, a loose states link and an instantaneous contact found out of adjustment on the other pump logic scheme.

Table A-3. Pump CCF events, sorted by the method of discovery.

Item	Discovery Method	Coupling Factor	Proximate Cause	Segment	Piece Part	System	Year	Failure Mode	Degree of Failure	Description
1	Demand	Design	Design/ Construction/ Manufacture/ Installation Inadequacy	Discharge	Valve	AFW	1985	Failure to Start	Partial	Controller problems in the steam and diesel driven AFW pumps caused the pumps to trip on low suction pressure. The pump discharge flow controller valves were also not set properly after last maintenance. Low suction trips were due to design error.
2	Demand	Design	Design/ Construction/ Manufacture/ Installation Inadequacy	Discharge	Valve	AFW	1986	Failure to Start	Partial	Both the turbine driven and motor driven AFW pumps could not produce full flow because the cages in their discharge valve trapped debris and plugged.
3	Demand	Design	Design/ Construction/ Manufacture/ Installation Inadequacy	Driver	I&C	AFW	1981	Failure to Start	Almost Complete	A modification to the control instrumentation for two AFW pumps resulted in a backfeed situation such that when called upon to start, both pumps would not start.
4	Demand	Design	Design/ Construction/ Manufacture/ Installation Inadequacy	Driver	I&C	AFW	1981	Failure to Start	Almost Complete	Two AFW pumps failed to automatically start due to low suction pressure trips. A modification was installed to prevent this. This effect was discovered previously, but apparently had not been corrected prior to an attempt to start the pumps three weeks later.
5	Demand	Design	Design/ Construction/ Manufacture/ Installation Inadequacy	Driver	I&C	AFW	1997	Failure to Run	Partial	One actual AFW pump failure due to spurious electronic overspeed trip. Determined that all three pumps were susceptible to spurious overspeed trips.
6	Demand	Design	Design/ Construction/ Manufacture/ Installation Inadequacy	Driver	Lubrication	RHR-P	2000	Failure to Run	Complete	Both RHR/LPI pumps fail to run due to improper oil in system. High bearing temperatures occurred when the pumps were operated. This was due to the wrong lube oil being used, which had too high a viscosity. Inadequate vendor design information resulted in the higher viscosity oil being used and additional exacerbating problems such as insufficient bearing clearances.
7	Demand	Design	Design/ Construction/ Manufacture/ Installation Inadequacy	Pump	Impeller/Wear Rings	ESW	1981	Failure to Run	Complete	Both charging pump service water pumps failed. A carbon cap screw failed allowing the impeller of one pump to bind on the casing. The ensuing leakage shorted the motor windings of the other pump.
8	Demand	Design	Design/ Construction/ Manufacture/ Installation Inadequacy	Pump	Impeller/Wear Rings	ESW	1986	Failure to Run	Partial	All four emergency service water pumps showed cavitation damage. Two of the pumps had minor damage and were placed back in service. Recirculation cavitation occurs at flows significantly less than design.

Item	Discovery Method	Coupling Factor	Proximate Cause	Segment	Piece Part	System	Year	Failure Mode	Degree of Failure	Description
9	Demand	Design	Design/ Construction/ Manufacture/ Installation Inadequacy	Pump	Impeller/Wear Rings	ESW	1986	Failure to Run	Partial	A Nuclear Service Water pump tripped on overcurrent after operating for approximately 20 minutes. Initial troubleshooting indicated that the pump was binding and disassembly was required to determine the cause. It was determined that the pump impeller thrust ring had become loose due to thrust ring retainer bolt failure, which allowed the impeller to slip on the shaft and resulted in pump binding and the overcurrent condition. The bolts failed due to corrosion. Similar bolt degradation was discovered on other service water pumps. The investigation results indicate the primary cause of the bolt failures was corrosion induced by galvanic coupling of the retainer bolting and other pump components.
10	Demand	Design	Design/ Construction/ Manufacture/ Installation Inadequacy	Suction	Piping	ESW	1983	Failure to Run	Almost Complete	Increased flow to chillers resulted in loss of NPSH to Charging Pump Service Water pumps.
11	Demand	Design	Design/ Construction/ Manufacture/ Installation Inadequacy	Suction	Piping	ESW	1982	Failure to Run	Almost Complete	Increased flow to chillers resulted in loss of NPSH to Charging Water Service Water pumps.
12	Demand	Design	Design/ Construction/ Manufacture/ Installation Inadequacy	Suction	Piping	ESW	1983	Failure to Run	Complete	Increased flow to chillers resulted in loss of NPSH to Charging Water Service Water pumps.
13	Demand	Design	Design/ Construction/ Manufacture/ Installation Inadequacy	Suction	Piping	ESW	1982	Failure to Run	Complete	The use of service water by the chillers can cause a loss of suction pressure to the charging pump service water pumps.
14	Demand	Design	Design/ Construction/ Manufacture/ Installation Inadequacy	Suction	Piping	ESW	1982	Failure to Run	Complete	The use of service water by the chillers can cause a loss of suction pressure to the charging pump service water pumps.
15	Demand	Design	Design/ Construction/ Manufacture/ Installation Inadequacy	Suction	Piping	ESW	1981	Failure to Run	Complete	Increased flow to chillers resulted in loss of NPSH to Charging Water Service Water pumps.
16	Demand	Design	Design/ Construction/ Manufacture/ Installation Inadequacy	Suction	Piping	ESW	1981	Failure to Run	Complete	Increasing flow to chillers robs NPSH from charging service water pumps.

Item	Discovery Method	Coupling Factor	Proximate Cause	Segment	Piece Part	System	Year	Failure Mode	Degree of Failure	Description
17	Demand	Design	Design/ Construction/ Manufacture/ Installation Inadequacy	Suction	Piping	ESW	1982	Failure to Run	Complete	The use of service water by the chillers can cause a loss of suction pressure to the Charging Water Service Water pumps.
18	Demand	Design	Design/ Construction/ Manufacture/ Installation Inadequacy	Suction	Piping	ESW	1982	Failure to Run	Complete	Increased flow to chillers resulted in loss of NPSH to Charging Water Service Water pumps.
19	Demand	Design	Design/ Construction/ Manufacture/ Installation Inadequacy	Suction	Piping	ESW	1996	Failure to Start	Partial	Freezing of diesel generator service water piping in intake bay. Inadequate initial design.
20	Demand	Design	External Environment	Discharge	Check Valve	AFW	1983	Failure to Start	Almost Complete	Hot water in the AFW pump casings caused the pumps to become vapor bound. The hot water was from leaking check valves upstream of the pumps. This event occurred once on the turbine driven pump and 5 times on the motor driven pump.
21	Demand	Design	Internal to Component	Driver	Breaker	ESW	2000	Failure to Start	Almost Complete	Two ESW pumps failed to start due to their breakers failing to close. The breakers' prop spring bracket has slipped thus preventing proper interfacing between the prop and the prop pin.
22	Demand	Design	Operational/ Human Error	Driver	I&C	ESW	1980	Failure to Start	Partial	Instrument isolation valve closed causing a low suction trip signal to two RHRSW pumps.
23	Demand	Design	Operational/ Human Error	Pump	Impeller/Wear Rings	AFW	1990	Failure to Run	Almost Complete	Due to a combination of management error and procedural deficiency, the turbine driven auxiliary feedwater pump was run deadheaded. The operation damaged the pump. When the pump was manually tripped, steam vented back into the suction line, caused another AFW pump to also trip, on a low suction pressure signal.
24	Demand	Design	Operational/ Human Error	Suction	Tank	AFW	1980	Failure to Run	Complete	Both emergency feedwater pumps lost feed pump suction. The emergency feedwater pump suction flashed to steam due to the feedwater train flashing and forcing hot water back through the startup and blowdown tanks and into the feedwater pump suction. To prevent this recurrence, the operating procedures have been changed to require isolating the startup and blowdown effluent as a source of emergency feedwater suction prior to increasing power.
25	Demand	Design	Operational/ Human Error	Suction	Piping	RHR-P	1982	Failure to Run	Complete	Suction was lost to both RHR pumps. RHR flow was less than 3000 gpm and pump amps were fluctuating prior to taking corrective action. Each of these events appear to have been caused by a slow decrease in RCS level in conjunction with the vortex action at the pump suction.
26	Demand	Design	Operational/ Human Error	Suction	Piping	RHR-P	1984	Failure to Run	Almost Complete	On two occasions, RHR pumps cavitated due to low RCS level while draining the RCS.
27	Demand	Design	Operational/ Human Error	Suction	Piping	RHR-P	1980	Failure to Run	Complete	The reactor vessel vent eductor was in service in preparation for refueling with RHR operating. A low flow alarm was received and low flow and low motor current were indicated. A second pump was started and became air-bound. Putting the vessel vent eductor system into service was the root cause of the incident.

Item	Discovery Method	Coupling Factor	Proximate Cause	Segment	Piece Part	System	Year	Failure Mode	Degree of Failure	Description
28	Demand	Design	Operational/ Human Error	Suction	Piping	RHR-P	1985	Failure to Run	Complete	Swap over of RHR pumps resulted in both trains becoming inoperable due to air injection into the suction of the pumps. This required both pumps to be vented and required RCS level to be raised to prevent a possible recurrence of the vortex problem.
29	Demand	Design	Other	Driver	I&C	ESW	1981	Failure to Start	Partial	Attempt was made to place the a RHRSW subsystem into service for use in suppression pool cooling, the subsystems' pumps could not be started due to a pump suction header low pressure lockout signal from the header pressure switch. The threaded plug in the switch diaphragm housing became loose and allowed the diaphragm fluid to leak out and caused the switch to sense a low pressure.
30	Demand	Design	Other	Driver	Piping	HCI	1999	Failure to Start	Complete	Water entered the HCI and RCI steam supply lines, rendering both pumps inoperable. Failed reactor vessel instrumentation allowed water to overflow and fill the HCI/RCI steam lines. Pumps were unavailable.
31	Demand	Design	Other	Driver	I&C	ESW	1981	Failure to Start	Partial	Attempt was made to place the a RHRSW subsystem into service for use in suppression pool cooling, the subsystems' pumps could not be started due to a pump suction header low pressure lockout signal from the header pressure switch. The threaded plug in the switch diaphragm housing became loose and allowed the diaphragm fluid to leak out and caused the switch to sense a low pressure. This is a second event two months later.
32	Demand	Design	Other	Suction	Valve	RHR-P	1984	Failure to Run	Complete	Both RHR pumps were unable to operate due to the introduction of air into the RHR system. The incident occurred during the drain down of the RCS, when the level of the RCS was being monitored via a standpipe off the centerline of one of the RCS loops. The isolation valve to which the standpipe was attached became clogged sometime during the drain down and falsely indicated above centerline when in fact the level was below the RHR suction line (below centerline).
33	Demand	Design	Other	Suction	Piping	RHR-P	1987	Failure to Run	Complete	RHR flow was interrupted when both RHR trains became inoperable due to air bound RHR pumps. The loss of RCS inventory to the reactor coolant drain tank due to a leaking valve caused a decrease in RCS water level, vortexing in the pumps' suction line, and air entrainment in the RHR pumps.
34	Demand	Design	Other	Suction	Piping	RHR-P	1982	Failure to Run	Complete	With unit drained to centerline of the nozzles, suction to both RHR pumps was lost for 36 minutes. Suction to the RHR pumps was lost because of ambiguous reactor coolant system level indication while drained to centerline of the nozzles. The actual RCS level was lower than observed.
35	Demand	Design	Other	Suction	Piping	RHR-P	1982	Failure to Run	Complete	RHR Suction lost due to erroneous RCS level while draining the RCS.
36	Demand	Design	Other	Suction	Piping	ESW	1980	Failure to Run	Almost Complete	Air ingress exceeded the air removal capability of the constant vent valves. A design change was implemented to remove the air compressor cooling from the service water system.
37	Demand	Design	Other	Suction	I&C	HPI	1997	Failure to Run	Partial	Letdown storage tank reference leg not full, which gave erroneous indication of sufficient tank level. One HPI pump severely damaged, other pump not as damaged, and could have run. The root cause was a combination of a design weakness of a common reference leg for the Letdown storage tank level instruments and a leaking instrument fitting due to an inadequate work practice.
38	Demand	Design	Other	Suction	Piping	HPI	1982	Failure to Start	Complete	Hydrogen from the suction dampener got into suction piping and failed both CCPs.
39	Demand	Design	Unknown	Suction	Piping	RHR-P	1983	Failure to Run	Complete	RHR pumps cavitated. Unable to repeat. Unknown cause.

Item	Discovery Method	Coupling Factor	Proximate Cause	Segment	Piece Part	System	Year	Failure Mode	Degree of Failure	Description
40	Demand	Environmental	Design/Construction/Manufacture/Installation Inadequacy	Pump	Impeller/Wear Rings	ESW	2000	Failure to Start	Almost Complete	Two of the River Water pumps tripped on overcurrent when they were attempted to be started. The trips were a result of physical contact between the impeller and the lower casing liner of the pumps. This condition was due to differential thermal expansion between the pump shaft and the pump casing as a result of an elevated seal injection water temperature. The elevated temperature was due to an abnormal configuration of the Filtered Water System (the backup seal water supply).
41	Demand	Environmental	External Environment	Driver	Motor	ESW	1985	Failure to Run	Partial	Two service water motors failed on demand as a result of cement dust contamination.
42	Demand	Environmental	External Environment	Driver	I&C	AFW	1984	Failure to Start	Complete	Both AFW pumps failed to start. The problem was traced to two relays (1 per pump). Examination of the relays revealed open circuiting and severe degradation of the insulation.
43	Demand	Environmental	External Environment	Suction	Piping	HPI	1984	Failure to Start	Complete	Boron solidification in the suction and gas binding of pumps led to the failure of all three safety injection pumps. Flushing procedures inadequate.
44	Demand	Environmental	Internal to Component	Discharge	Valve	AFW	1988	Failure to Run	Partial	After automatic start, motor driven AFW pump swapped suction automatically to the nuclear service water system when a sustained low suction pressure condition was sensed, and raw water entered two steam generators. After the initial trip recovery, it was noted that AFW flow to steam generators had degraded following the suction swap. Inspections revealed that the cavitrol cages for these valves were clogged with shredded Asiatic clam shells.
45	Demand	Environmental	Internal to Component	Discharge	Valve	AFW	1988	Failure to Run	Partial	After automatic start, motor driven AFW pump swapped suction automatically to the nuclear service water system when a sustained low suction pressure condition was sensed, and raw water entered two steam generators. After the initial trip recovery, it was noted that AFW flow to steam generators had degraded following the suction swap. Inspections revealed that the cavitrol cages for these valves were clogged with shredded Asiatic clam shells.
46	Demand	Environmental	Internal to Component	Pump	Impeller/Wear Rings	ESW	1994	Failure to Run	Partial	Raw water pump currents stayed high after starting. The primary cause of these events was determined to be elevated sand content in the river, resulting in excessive sand accumulation around the suction area of the pumps.
47	Demand	Environmental	Internal to Component	Suction	Strainer	ESW	1980	Failure to Run	Partial	Foreign material was allowed to enter the suction of the charging pump service water pumps resulting in low flow conditions.
48	Demand	Environmental	Internal to Component	Suction	Piping	ESW	1986	Failure to Start	Partial	RHR service water pumps failed flow testing due to blocked suctions and abnormal wear of impellers.
49	Demand	Maintenance	Design/Construction/Manufacture/Installation Inadequacy	Suction	I&C	HPI	1997	Failure to Run	Complete	HPI pumps fail due to operation with inadequate suction head. Two pumps damaged due to operation with inadequate suction, but all three system pumps were unavailable due to the loss of the suction source. Suction source level instrumentation was the cause.
50	Demand	Maintenance	External Environment	Driver	Breaker	AFW	1990	Failure to Run	Partial	AFW pumps circuit breakers degraded.
51	Demand	Maintenance	Internal to Component	Driver	Breaker	RHR-B	1987	Failure to Start	Partial	RHR pump breakers failed to close when operated remotely from the control room. It was found that the latch roller bearings and the cam follower bearing (internal piece parts of the breaker) were not operating correctly. This prevented the trip latch assembly from resetting and allowing the breaker to close.

Item	Discovery Method	Coupling Factor	Proximate Cause	Segment	Piece Part	System	Year	Failure Mode	Degree of Failure	Description
52	Demand	Maintenance	Internal to Component	Driver	I&C	ESW	1991	Failure to Start	Partial	Two ESW pumps failed to start due to failed breakers. Inadequate maintenance.
53	Demand	Maintenance	Internal to Component	Driver	Lubrication	HPI	1984	Failure to Run	Partial	Charging pump lube oil cooler fan motor trips on thermal overload. Probable cause: normal wear on motor resulting in increased friction replaced worn motor with spare. During routine inservice testing found that another charging pump lube oil cooler fan motor had a current imbalance. Probable cause: normal aging of motor insulation has resulted in a current imbalance.
54	Demand	Maintenance	Internal to Component	Pump	Casing	ESW	1998	Failure to Start	Partial	Two ESW pump started and ran, but would not develop sufficient pressure or flow rate. Exact cause not known for either failure, however, one pump was noted to have microbiological induced corrosion fouling on internal surfaces.
55	Demand	Maintenance	Internal to Component	Pump	Bearing	AFW	1984	Failure to Run	Partial	One ESW bearing failed and pump seized; second motor bearing failed.
56	Demand	Maintenance	Internal to Component	Pump	Packing/Seals	AFW	1998	Failure to Run	Partial	AFW MDP and TDPs failed due to incorrect packing installed.
57	Demand	Maintenance	Operational/ Human Error	Driver	Breaker	ESW	1993	Failure to Start	Partial	Operations personnel were attempting to swap the running service water pump with the idle service water pump. Personnel placed the control switch to start and the service water pump did not start. Breaker malfunction. Later, another service water pump failed to start because of the breaker.
58	Demand	Maintenance	Operational/ Human Error	Driver	Breaker	ESW	1987	Failure to Start	Partial	One breaker failed to linkage alignment and second from loose relay connections. Inadequate maintenance.
59	Demand	Maintenance	Operational/ Human Error	Driver	Breaker	ESW	1988	Failure to Run	Partial	Service water pump high dropout over current protection devices were less than running current conditions and trip setpoints did not account for changing load conditions due to modified impellers. Three pump trips had occurred.
60	Demand	Maintenance	Operational/ Human Error	Pump	Casing	AFW	1983	Failure to Run	Partial	During testing, the outboard bearing temperature was high on the turbine-driven AFW pump, due to improper balance drum clearances, caused by improper maintenance. The procedure will be modified and the balance drum clearance reset. While the unit was starting up, the motor-driven AFW pump outboard bearing temperature was high. Excessive thrust bearing clearance caused the balance drum to unbalance, causing the thrust bearing to overheat.
61	Demand	Maintenance	Operational/ Human Error	Suction	Piping	ESW	1996	Failure to Run	Complete	Both trains of both units charging pump service water pumps became air bound. Underwater diving maintenance activities on one units circulating water and service water lines was identified as the source of the air. The air entered the service water supply lines when a valve was opened in preparation for a Safety Injection logic test.
62	Demand	Maintenance	Operational/ Human Error	Suction	Piping	ESW	1996	Failure to Run	Complete	Both trains of both units charging pump service water pumps became air bound. Underwater diving maintenance activities on one units circulating water and service water lines was identified as the source of the air. The air entered the service water supply lines when a valve was opened in preparation for a Safety Injection logic test.
63	Demand	Maintenance	Other	Discharge	Valve	ESW	1980	Failure to Start	Partial	RHR service water pumps were started to put torus cooling in service. When these pumps would not deliver required discharge pressure, they were declared inoperable. The seal in an air release valve was bad, allowing a vent on the discharge line.
64	Demand	Maintenance	Other	Driver	Breaker	RHR-P	1987	Failure to Start	Complete	Two LPI pumps, when given a start signal, would not start. An ongoing investigation revealed the probable root cause of the event to be poor electrical contact of the breaker auxiliary stabs for the pumps.

Item	Discovery Method	Coupling Factor	Proximate Cause	Segment	Piece Part	System	Year	Failure Mode	Degree of Failure	Description
65	Demand	Maintenance	Other	Driver	I&C	ESW	1982	Failure to Start	Complete	Following a reactor scram, an attempt to initiate suppression pool cooling revealed that both RHRSW loops were inoperable as neither loop's pumps could be started. Low suction header pressure lockout signals in each loop prevented starting each loop's pumps. Plugging of the sensing line to each loop's suction header pressure switch prevented both switches from sensing actual pressure, although a lack of operating fluid in one switch and an open power supply breaker to the other switch also would have prevented pumps from starting.
66	Demand	Maintenance	Other	Suction	Piping	RHR-P	1981	Failure to Run	Complete	Temporary coolant loop level indicator showed level slowly increasing over a period of days. The system was periodically drained to maintain 65 percent indicated level. A RHR pump lost suction on reduction of actual level. The second pump was started, and lost suction. Indication drift was due to evaporation of reference leg.
67	Demand	Maintenance	Other	Suction	Piping	RHR-P	1980	Failure to Run	Complete	A complete loss of RHR flow occurred while plant operators were increasing RHR heat exchanger flow by closing down on the heat exchanger bypass valve.
68	Demand	Maintenance	Other	Suction	Piping	RHR-P	1983	Failure to Run	Complete	The RHR pumps began to cavitate and eventually both pumps were stopped. The reactor vessel level gauge being used to provide an indication that the level was approaching the vessel flange level had been isolated (reactor coolant drain tank isolation valve had been closed during an attempt to reduce leakage). Additionally, procedures did not require visual monitoring of cavity level.
69	Demand	Maintenance	Other	Suction	Piping	RHR-P	1986	Failure to Run	Complete	SDC pumps cavitated due to lowering RCS level. Level indication was in error.
70	Demand	Operational	Operational/ Human Error	Driver	I&C	AFW	1983	Failure to Start	Complete	An operator incorrectly secured the diesel and steam driven AFW pumps, which prevented their restart on low SG level.
71	Demand	Operational	Operational/ Human Error	Driver	I&C	ESW	1981	Failure to Start	Partial	Alarm circuit breaker was de-energized resulting in a loss of two RHR service water pumps.
72	Demand	Operational	Operational/ Human Error	Suction	Piping	ESW	1988	Failure to Run	Complete	The procedure failed to adequately caution the operator to slowly fill a drained line. Rapid filling resulted in a loss of NPSH to the charging service water pumps.
73	Demand	Operational	Operational/ Human Error	Suction	Piping	RHR-P	1980	Failure to Run	Complete	While attempting to increase RHR flow, the plant experienced a total loss of flow due to the pumps being air-bound. The pump was not vented when starting to increase flow. Operating procedures have been changed to have an operator present while changing flow in the RHR system. There have been losses of RHR flow in the past because the pumps were air-bound and methods are being investigated to improve the system design.
74	Demand	Operational	Operational/ Human Error	Suction	Piping	ESW	1986	Failure to Run	Complete	Failure to properly vent and fill a newly installed pipe introduced air into the charging pump service water system.
75	Demand	Operational	Operational/ Human Error	Suction	Booster Pump	ESW	1980	Failure to Start	Partial	The service water RHR booster pump was de-energized during maintenance. The attempt to start service water pumps failed due to low suction pressure.
76	Demand	Operational	Operational/ Human Error	Suction	Piping	RHR-P	1984	Failure to Run	Complete	The control room operators started a second residual heat removal pump in preparation for removing the operating RHR pump from service. With both pumps running, flow became excessive for the half-loop condition causing cavitation and air binding of both pumps. To prevent recurrence the procedure which controls the operation of the RHR pumps has been changed to include specific instructions to stop the operating pump prior to starting the second pump while at half-loop.

Item	Discovery Method	Coupling Factor	Proximate Cause	Segment	Piece Part	System	Year	Failure Mode	Degree of Failure	Description
77	Demand	Quality	Design/ Construction/ Manufacture/ Installation Inadequacy	Driver	I&C	AFW	1989	Failure to Start	Complete	Both motor driven auxiliary feedwater pumps failed to start when the operator tried to start them manually. While preparing a design change, the designer failed to review all the unit specific documentation associated with the motor-driven AFW pump wiring and made the erroneous assumption that both units switchgear compartment internal wiring was identical. In fact, the wiring for each unit was different. Consequently, when the design change was installed, it was installed in accordance with the erroneous design. The wiring discrepancy was corrected and the motor-driven AFW pumps were tested and returned to service.
78	Demand	Quality	Design/ Construction/ Manufacture/ Installation Inadequacy	Driver	Breaker	ESW	1996	Failure to Start	Partial	Two RHRSW pumps fail to start due to breaker failures. Wrong contacts were installed. Design called for contacts to have a minimum current interrupt rating of 6 amps; contacts installed (that subsequently failed) had current interrupt rating of only 2.2 amps.
79	Demand	Quality	Design/ Construction/ Manufacture/ Installation Inadequacy	Driver	Motor	ESW	1987	Failure to Start	Partial	ESW pump motors tripped on overcurrent. The overcurrent trip was due to a ground and a short on the pump motor.
80	Demand	Quality	Design/ Construction/ Manufacture/ Installation Inadequacy	Pump	Impeller/Wear Rings	ESW	1996	Failure to Run	Partial	A Nuclear Service Water pump tripped on overcurrent after operating for approximately 20 minutes. Initial troubleshooting indicated that the pump was binding and disassembly was required to determine the cause. It was determined that the pump impeller thrust ring had become loose due to thrust ring retainer bolt failure, which allowed the impeller to slip on the shaft and resulted in pump binding and the overcurrent condition. The bolts failed due to corrosion. Similar bolt degradation was discovered on other service water pumps. The investigation results indicate the primary cause of the bolt failures was corrosion induced by galvanic coupling of the retainer bolting and other pump components.
81	Demand	Quality	Design/ Construction/ Manufacture/ Installation Inadequacy	Pump	Impeller/Wear Rings	ESW	1988	Failure to Run	Partial	ESW pumps drawing excessive current. Carbon steel snap rings corroded allowing impeller to come in contact with casing. The third pump, although not exhibiting abnormal current, had similar corrosion
82	Demand	Quality	Design/ Construction/ Manufacture/ Installation Inadequacy	Suction	Piping	ESW	1984	Failure to Start	Partial	Both RHR service water pumps tripped as a result of inadequate venting of suction header resulting from poor orientation of the vent line.
83	Demand	Quality	Internal to Component	Pump	Impeller/Wear Rings	AFW	1988	Failure to Run	Partial	Following a plant trip, it was discovered that the auxiliary feedwater pumps had internal damage. Some channel ring vanes had chips missing, and several parts were found in the SG auxiliary feedwater piping.
84	Inspection	Design	Design/ Construction/ Manufacture/ Installation Inadequacy	Driver	Lubrication	HPI	2000	Failure to Run	Partial	CVC makeup oil pump motor too small for certain accidents.

Item	Discovery Method	Coupling Factor	Proximate Cause	Segment	Piece Part	System	Year	Failure Mode	Degree of Failure	Description
85	Inspection	Design	Design/ Construction/ Manufacture/ Installation Inadequacy	Driver	I&C	AFW	1994	Failure to Start	Partial	Single failure would prevent auto initiation of AFW. Circuit design did not provide separation required by standards and code. The single failure identified was a short circuit across two conductors of the actuation relays associated with the initiation logic matrix.
86	Inspection	Design	Design/ Construction/ Manufacture/ Installation Inadequacy	Driver	Supports	RHR-B	1986	Failure to Start	Partial	RHR motor internal supports were cracked due to stress and vibration. Design improvements were made.
87	Inspection	Design	Design/ Construction/ Manufacture/ Installation Inadequacy	Suction	Piping	HPI	1990	Failure to Start	Partial	A quantity of gas was found in the centrifugal charging pump suction header that exceeded the maximum allowed gas volume. It was subsequently determined that hydrogen gas had been coming out of solution on both units and accumulating in the suction piping as a probable result of gas stripping by the CCP miniflow orifices. In addition, entrainment of hydrogen bubbles from the volume control tank to the CCP suction pipe may be a contributor as well.
88	Inspection	Design	Design/ Construction/ Manufacture/ Installation Inadequacy	Suction	Piping	HPI	1988	Failure to Run	Partial	Ultrasonic examination of the chemical and volume control system suction piping was performed. These examinations revealed voids in the suction piping.
89	Inspection	Design	Design/ Construction/ Manufacture/ Installation Inadequacy	Suction	Piping	HPI	1988	Failure to Start	Partial	It was determined that various pipes of the safety injection system and chemical volume and control system collected or trapped gas which might affect the functions of these systems. There was a concern that the gas pockets may adversely effect pump operation. Voids were detected in some of the high head SI pump piping.
90	Inspection	Design	Design/ Construction/ Manufacture/ Installation Inadequacy	Suction	Piping	HPI	1991	Failure to Start	Partial	Ultrasonic examination of the chemical and volume control system suction piping was performed. These examinations revealed voids in the alternate boration line and the gravity feed line from the boric acid storage tank.
91	Inspection	Design	External Environment	Discharge	Piping	HPI	1994	Failure to Run	Partial	Due to a leaking socket weld in the common recirculation line, all three SI pumps were declared inoperable. The underlying cause of the leak was a crack in the socket weld in the common recirculation line, caused by pipe displacement from air entrainment and pump misalignment.
92	Inspection	Design	External Environment	Pump	Bearing	HPI	1991	Failure to Run	Almost Complete	Charging/safety pumps beyond operational limits. Damage was found to the thrust bearings. Air was introduced into this train of chilled water during modifications and testing being performed on the system. This air became trapped in high points of either, or both of, the supply and return chilled water lines to the charging pump. At the reduced flow rate, sufficient cooling was not available and oil temperature increased to the point where bearing damage occurred.
93	Inspection	Design	Internal to Component	Driver	I&C	ESW	1982	Failure to Start	Partial	Open circuit breaker resulted in loss of two RHR service water pumps.
94	Inspection	Design	Internal to Component	Pump	Lubrication	HPI	1981	Failure to Run	Partial	Corrosion of HPI pump cooler heads. Improper material led to corrosion

Item	Discovery Method	Coupling Factor	Proximate Cause	Segment	Piece Part	System	Year	Failure Mode	Degree of Failure	Description
95	Inspection	Design	Operational/ Human Error	Driver	Breaker	ESW	1984	Failure to Start	Partial	During an attempt to perform preventive maintenance for unit one's RHR service water pumps, plant personnel mistakenly disconnected the motor leads for unit two's RHR service water pump.
96	Inspection	Design	Other	Driver	I&C	AFW	1983	Failure to Start	Partial	Both AFW pumps had to be rendered inoperable to allow repairs to actuation circuitry.
97	Inspection	Environmental	Design/ Construction/ Manufacture/ Installation Inadequacy	Driver	Piping	HPI	2000	Failure to Run	Partial	Microbiologically induced corrosion leak on service water lines to two charging/HPI pump lube oil coolers.
98	Inspection	Environmental	Design/ Construction/ Manufacture/ Installation Inadequacy	Pump	Lubrication	HPI	1995	Failure to Run	Partial	High lube oil temperatures were observed during HPI pump operation. Zinc particles from anode were discovered plugging the lube oil coolers. Accelerated corrosion was attributed to a corrosion inhibitor that was added to the system, which chemically interacted with the zinc.
99	Inspection	Environmental	Design/ Construction/ Manufacture/ Installation Inadequacy	Suction	Strainer	ESW	2000	Failure to Run	Partial	RHR SW Pumps Failed to Develop flow/pressure. Debris in intake structure. Requires modifications to the traveling Water Screen.
100	Inspection	Environmental	External Environment	Pump	Coupling	ESW	1993	Failure to Run	Partial	Entrained debris caused ESW pump shaft coupling to fail. Plant equipment did not prevent this debris from entering pump.
101	Inspection	Environmental	External Environment	Pump	Packing/Seals	RHR-P	1985	Failure to Start	Complete	Following a trip, water was found spraying from both low head safety injection pump wedge control rod seals. Both pumps were declared inoperable. Postulated failure on the seals was from a minor flow induced pressure transient.
102	Inspection	Environmental	Internal to Component	Pump	Packing/Seals	ESW	1994	Failure to Run	Partial	Backup seal water regulators did not provide required flow during testing on two pumps. The third pump lost seal flow while operating. The cause was attributed to plugged lines.
103	Inspection	Environmental	Internal to Component	Pump	Lubrication	HPI	1983	Failure to Run	Partial	Oysters and miscellaneous mollusks plugged HPI oil coolers. Two pumps were required to be shutdown due to rising lubricating oil temperatures.
104	Inspection	Environmental	Internal to Component	Pump	Impeller/Wear Rings	ESW	1990	Failure to Start	Partial	ESW pumps had reduced flow and discharge pressure. Marine growth in suction.
105	Inspection	Environmental	Internal to Component	Suction	Strainer	ESW	1984	Failure to Run	Partial	Two RHR service water pumps had blown seals and sparks and smoke between the bearing housing and shaft. A piece of hard rubber valve liner was found in the pumps.
106	Inspection	Environmental	Other	Driver	Motor	ESW	1981	Failure to Run	Partial	The float guide failed in a RHR SW pump air valve and caused the valve to fail open and flood pump room.
107	Inspection	Environmental	Other	Driver	Motor	AFW	1990	Failure to Start	Partial	Both motor driven AFW pumps were sprayed when a service water pipe developed a through wall leak.
108	Inspection	Maintenance	Design/ Construction/ Manufacture/ Installation Inadequacy	Pump	Packing/Seals	ESW	1997	Failure to Run	Partial	Both ESW pumps leaking greater than 4 gpm because of inappropriate material for packing and sleeve (nitronic 60).

Item	Discovery Method	Coupling Factor	Proximate Cause	Segment	Piece Part	System	Year	Failure Mode	Degree of Failure	Description
109	Inspection	Maintenance	Internal to Component	Discharge	Check Valve	AFW	1990	Failure to Start	Almost Complete	Leakage past AFW check valves caused AFW pumps to become steam bound. Closed motor operated valve in line. Scheduled check valves for replacement next outage.
110	Inspection	Maintenance	Internal to Component	Driver	Breaker	ESW	1996	Failure to Start	Partial	ESW pump breakers fail due to misalignment of the breaker mechanism and internals developed over the years of operation.
111	Inspection	Maintenance	Internal to Component	Driver	Bearing	ESW	1985	Failure to Run	Partial	One service water pump motor upper bearing oil reservoir leaking from cover plate. Another service water pump motor upper oil cooler oil reservoir leaking.
112	Inspection	Maintenance	Internal to Component	Driver	Packing/Seals	HPI	1988	Failure to Run	Almost Complete	Smoke was discovered coming from the speed increaser unit for a centrifugal charging pump. Investigation found the two gland seal retaining bolts inside the speed increaser lube oil pump backed out allowing the gland seal to loosen. The gland seal being loosened, caused reduced oil flow to the speed increaser internals and ultimate damage. Other CCPs were inspected, and the same gland seal bolts as on the first pump were found loosened. The cause of the bolts backing out was determined to be lack of a periodic adjustment of the gland seal bolts.
113	Inspection	Maintenance	Internal to Component	Driver	Bearing	ESW	1981	Failure to Run	Partial	ESW motor to pump alignment problems. Bearings worn out.
114	Inspection	Maintenance	Internal to Component	Pump	Bearing	ESW	1987	Failure to Run	Partial	Service water pumps had high shaft vibration. The excessive vibrations caused by worn bearings and shaft sleeves.
115	Inspection	Maintenance	Internal to Component	Pump	Casing	ESW	1986	Failure to Run	Partial	Cracked seal water and vent lines.
116	Inspection	Maintenance	Internal to Component	Pump	Packing/Seals	ESW	1989	Failure to Run	Partial	ESW pump excessive packing leakage.
117	Inspection	Maintenance	Internal to Component	Pump	Impeller/Wear Rings	ESW	1985	Failure to Run	Partial	Service water pumps were noted to have high vibrations and low discharge pressure. The cause of the failure is suspected to be binding.
118	Inspection	Maintenance	Internal to Component	Pump	Packing/Seals	SLC	1988	Failure to Run	Partial	Standby Liquid Control pumps were observed to be leaking excessively at the packing. The failure of the packing was attributed to normal wear. Packing replaced.
119	Inspection	Maintenance	Internal to Component	Pump	Bearing	SLC	1989	Failure to Run	Partial	Standby Liquid Control pumps lost oil while running. Loose fittings and lack of thread sealant.
120	Inspection	Maintenance	Internal to Component	Pump	Lubrication	RHR-B	1990	Failure to Run	Partial	Both pump motor oil coolers were leaking due to aging of components. The first case involved through wall corrosion and the pump was immediately removed from service. The second case was a packing leak.
121	Inspection	Maintenance	Internal to Component	Pump	Casing	ESW	1988	Failure to Run	Partial	RHR service water pumps. Pump diffuser eroded on first pump and a through wall casing leak developed on the second.
122	Inspection	Maintenance	Internal to Component	Pump	Packing/Seals	SLC	1987	Failure to Run	Partial	Standby Liquid Control pumps were observed to be leaking excessively at the packing. The failure of the packing was attributed to normal wear. Packing adjusted.
123	Inspection	Maintenance	Internal to Component	Pump	Plunger/Cylinder	SLC	1989	Failure to Run	Partial	Standby Liquid Control pump seal was leaking excessively. The cause of this failure was normal wear of the plungers, packing, and head gaskets for the plungers (piece parts of the pump).
124	Inspection	Maintenance	Internal to Component	Pump	Packing/Seals	SLC	1989	Failure to Run	Partial	Standby Liquid Control pumps were observed to be leaking profusely at the packing. The failure of the packing was attributed to normal wear.
125	Inspection	Maintenance	Internal to Component	Pump	Packing	AFW	1986	Failure to Run	Partial	The packing was worn on both the motor-driven and one turbine-driven aux. feedwater pump, causing high temperature on one packing gland, and excessive leaking on the other pump.

Item	Discovery Method	Coupling Factor	Proximate Cause	Segment	Piece Part	System	Year	Failure Mode	Degree of Failure	Description
126	Inspection	Maintenance	Internal to Component	Pump	Packing/Seals	ESW	1986	Failure to Run	Partial	Excessive packing leakage. Both events occurred after previous maintenance had been performed for the same problems.
127	Inspection	Maintenance	Internal to Component	Pump	Packing/Seals	AFW	1990	Failure to Run	Partial	Both motor-driven aux. feedwater pumps had excessive packing leaks, due to worn packing.
128	Inspection	Maintenance	Operational/ Human Error	Driver	I&C	AFW	1990	Failure to Start	Complete	During testing one AFW pump was tested and other was tested without returning first to auto. Both pumps were unavailable at the same time. The procedure was the cause.
129	Inspection	Maintenance	Operational/ Human Error	Driver	Breaker	RHR-P	1981	Failure to Start	Complete	All RHR pumps de-energized to replace RHR Relief valve. T.S. allows this condition for 1 hour. Operated in the mode in excess of 5 hours.
130	Inspection	Maintenance	Operational/ Human Error	Driver	I&C	RHR-P	1992	Failure to Start	Complete	Both trains of RHR were rendered inoperable for two minutes, while performing an operational readiness test surveillance procedure. The surveillance procedure required that the one RHR train pump be placed in pull to lock and the other train heat exchanger flow control valve throttled to 30-40% open. The procedure directed the operators to perform operations that resulted in both trains of RHR being inoperable
131	Inspection	Maintenance	Operational/ Human Error	Driver	Bearing	RHR-P	1988	Failure to Run	Partial	Residual heat removal pump motor upper bearing housings were observed to be leaking oil. The cause of the failure was attributed to a lack of sealant being applied and gasket installed after the last maintenance was performed on the motor bearing housing.
132	Inspection	Maintenance	Operational/ Human Error	Suction	Valve	SLC	1991	Failure to Start	Partial	SLC pumps were potentially inoperable during part of test due to valve lineup.
133	Inspection	Operational	External Environment	Driver	I&C	HPI	1990	Failure to Run	Complete	It was determined that the common minimum flow path return line for the safety injection pumps to the refueling water storage tank was frozen. Previous actions to investigate problems with the freeze protection system were unsuccessful in preventing development of this condition. The two HPI pumps were declared inoperable with this return line frozen. A faulty ambient temperature switch for the RWST heat trace system prevented the heat trace from activating and was subsequently replaced. In addition, administrative controls did not sufficiently recognize the safety significance of flow through this line and the need to ensure flow capability.
134	Inspection	Operational	Operational/ Human Error	Discharge	Valve	HPI	1987	Failure to Start	Almost Complete	While attempting to fill the safety injection accumulators, it was discovered that two of three SI pumps had been isolated from the high head injection flowpath.
135	Inspection	Operational	Operational/ Human Error	Discharge	Valve	HPI	1993	Failure to Run	Partial	One AFW pump failed due to incorrect procedure which allowed pump to be run without flow, other AFW pump was allowed to run past max flow rate. It is unclear whether these mistakes were due to inadequate procedures or staff errors, but it was assumed to be a failure to follow procedure.
136	Inspection	Operational	Operational/ Human Error	Discharge	Valve	AFW	1994	Failure to Start	Complete	Following a trip, the AFW Pumps were secured and the discharge flow control valves for the Motor Driven Pumps were closed. Later, an operator discovered during a routine Control Board walkdown that the valves were closed. Subsequent investigation revealed the AFW system had not been placed in standby readiness per the operating procedure after the system was secured.
137	Inspection	Operational	Operational/ Human Error	Driver	I&C	HPI	1990	Failure to Start	Partial	Both safety injection pumps were in the pull-to-lock position. With the switches in pull-to-lock, the pumps would not have automatically started upon receipt of an initiating signal. This event was caused by cognitive personnel error by a utility licensed operator in failure to follow an approved procedure.
138	Inspection	Operational	Operational/ Human Error	Driver	Breaker	CSS	1991	Failure to Start	Complete	CSR control power de-energized prior to mode change. Technical Specification violation. Inadequate procedure review.

Item	Discovery Method	Coupling Factor	Proximate Cause	Segment	Piece Part	System	Year	Failure Mode	Degree of Failure	Description
139	Inspection	Operational	Operational/ Human Error	Driver	Breaker	HPI	1988	Failure to Start	Complete	HPI pumps not restored before mode change due to procedural inadequacy.
140	Inspection	Operational	Operational/ Human Error	Driver	Breaker	HPI	1989	Failure to Start	Partial	HPI Pump B not retested, then HPI Pump A removed from service.
141	Inspection	Operational	Operational/ Human Error	Driver	I&C	RHR-P	1995	Failure to Start	Complete	The switches for the containment spray and recirculation pumps were in a trip pullout when the Technical Specifications and plant procedures required the pumps to be operable.
142	Inspection	Operational	Operational/ Human Error	Driver	Breaker	ESW	1981	Failure to Start	Almost Complete	Control breakers for two ESW pumps were open due to inadvertent operator action.
143	Inspection	Operational	Operational/ Human Error	Driver	I&C	HPI	1992	Failure to Start	Almost Complete	Two charging pumps and one charging pump service water pump were removed from service simultaneously which is a condition not allowed by technical specifications.
144	Inspection	Operational	Operational/ Human Error	Driver	Breaker	HPI	1990	Failure to Start	Complete	By opening incorrect breaker, HPI pump tripped while others were unavailable.
145	Inspection	Operational	Operational/ Human Error	Driver	I&C	HPI	1988	Failure to Start	Complete	With alternate CCP pump out-of-service, the remaining operable pump was erroneously placed in pull-to-lock.
146	Inspection	Operational	Operational/ Human Error	Driver	Breaker	HPI	1982	Failure to Start	Complete	During the draining of the reactor coolant system, both centrifugal charging pumps were rendered inoperable. The initial conditions in the draining procedure contained a confusing statement, which led to an erroneous assumption that both CCP breakers had to be racked out and tagged.
147	Inspection	Operational	Operational/ Human Error	Pump	Lubrication	HPI	1983	Failure to Start	Complete	A routine preventive maintenance (oil change) was mistakenly performed on the north charging pump instead of the south as scheduled. Since the south pump was previously cleared for this oil change, and the test pump was valved out, none of these three pumps were in service as required by tech specs for the approximately 20 minutes it took to change the oil in the north pump.
148	Inspection	Operational	Other	Pump	Bearing	ESW	1991	Failure to Run	Partial	Lube oil cooling water isolated during a test. Pumps continued to run with no cooling.
149	Inspection	Quality	Design/ Construction/ Manufacture/ Installation Inadequacy	Pump	Casing	AFW	1983	Failure to Run	Partial	Two AFW pumps thrust tolerance was out of specification. These events were caused by improperly installed balancing drum parts. One turbine driven and one motor driven pump was involved.
150	Inspection	Quality	Design/ Construction/ Manufacture/ Installation Inadequacy	Pump	Casing	HPI	1987	Failure to Run	Partial	During inspection of a centrifugal charging pump, a portion of the stainless steel cladding on the inside surface of the pump casing exhibited corrosion. Corrosion of the pump casing was through the stainless steel cladding into the carbon steel base material. Inspection of the other CCP revealed similar corrosion. The cause of this event was a manufacturing deficiency. Corrosion observed at the pump casing discharge nozzle was attributed to a cladding breakthrough during final machining. Corrosion observed at the pump casing inlet end was attributed to either over-machining of the cladding or inadequate overlay of two adjacent weld beads.
151	Inspection	Quality	Design/ Construction/ Manufacture/ Installation Inadequacy	Suction	Piping	HPI	1988	Failure to Run	Partial	Vortex breakers had not been installed in the containment emergency sumps. Vortex breakers are required to be installed in the containment emergency sumps to prevent the formation of vortices which could adversely affect performance of safety injection pumps during the safety injection and containment spray systems were declared inoperable.

Item	Discovery Method	Coupling Factor	Proximate Cause	Segment	Piece Part	System	Year	Failure Mode	Degree of Failure	Description
152	Inspection	Quality	Operational/ Human Error	Driver	Breaker	ESW	1992	Failure to Start	Partial	The fit between an ESW pump breaker primary disconnects and the associated breaker cubicle stabs was inadequate. The poor fit between the disconnects and the stabs led to arcing in the breaker cubicle when the pump was started, resulting in a fire. Shortly after identifying the cause of the fire, the remaining ESW breakers, which had recently been replaced along with the failed breaker, as part of a design modification package, were found to be inadequate also.
153	Maintenance	Design	Design/ Construction/ Manufacture/ Installation Inadequacy	Driver	I&C	HPI	1996	Failure to Run	Partial	A lead was lifted in an emergency bus DC control circuit resulting in one charging pump tripping while running on the alternate power supply. Further investigation into this event revealed an anomaly, which could result in having no operating charging pumps. The cause of the event has been determined to be an error in the original design of the charging pump interlock logic. The anomaly would occur upon a loss of the DC control power to one emergency bus if 'C' charging pump was powered from the other bus.
154	Maintenance	Design	Design/ Construction/ Manufacture/ Installation Inadequacy	Driver	I&C	HPI	1996	Failure to Run	Partial	A lead was lifted in an emergency bus DC control circuit resulting in one charging pump tripping while running on the alternate power supply. Further investigation into this event revealed an anomaly, which could result in having no operating charging pumps. The cause of the event has been determined to be an error in the original design of the charging pump interlock logic. The anomaly would occur upon a loss of the DC control power to one emergency bus if 'C' charging pump was powered from the other bus.
155	Maintenance	Design	Design/ Construction/ Manufacture/ Installation Inadequacy	Suction	Tank	ESW	1985	Failure to Run	Partial	An engineering evaluation revealed that ESW had been inoperable several times due to low NPSH. All three units were affected.
156	Maintenance	Design	Design/ Construction/ Manufacture/ Installation Inadequacy	Suction	Tank	ESW	1990	Failure to Run	Partial	An engineering evaluation revealed that ESW had been inoperable several times due to low NPSH. All three units were affected.
157	Maintenance	Design	Design/ Construction/ Manufacture/ Installation Inadequacy	Suction	Tank	ESW	1990	Failure to Run	Partial	An engineering evaluation revealed that ESW had been inoperable several times due to low NPSH. All three units were affected.
158	Maintenance	Design	Design/ Construction/ Manufacture/ Installation Inadequacy	Suction	Tank	ESW	1985	Failure to Run	Partial	An engineering evaluation revealed that ESW had been inoperable several times due to low NPSH. All three units were affected.
159	Maintenance	Design	Design/ Construction/ Manufacture/ Installation Inadequacy	Suction	Tank	ESW	1985	Failure to Run	Partial	An engineering evaluation revealed that ESW had been inoperable several times due to low NPSH. All three units were affected.

Item	Discovery Method	Coupling Factor	Proximate Cause	Segment	Piece Part	System	Year	Failure Mode	Degree of Failure	Description
160	Maintenance	Design	Design/ Construction/ Manufacture/ Installation Inadequacy	Suction	Tank	ESW	1990	Failure to Run	Partial	An engineering evaluation revealed that ESW had been inoperable several times due to low NPSH. All three units were affected.
161	Maintenance	Environmental	External Environment	Driver	Motor	ESW	1987	Failure to Start	Partial	During an extended service water bay flooding incident, one ESW pump was found grounded by testing, later two more pumps were found to be failed also.
162	Maintenance	Environmental	Internal to Component	Pump	Packing/Seals	ESW	1985	Failure to Run	Partial	First pump developed seal leak due to sand. Second pump had high bearing temperatures due to trash clogging cooling water lines.
163	Maintenance	Environmental	Internal to Component	Pump	Lubrication	HPI	1986	Failure to Run	Almost Complete	Clams/sludge fouling of lube oil cooler caused high temperature alarms on two HPI pumps.
164	Maintenance	Environmental	Internal to Component	Pump	Lubrication	HPI	1991	Failure to Run	Partial	HPI pump lube oil cooler leaks. Degraded tubes.
165	Maintenance	Environmental	Internal to Component	Pump	Lubrication	HPI	1980	Failure to Run	Partial	HPI pump lube oil cooler with tube leak allowed water into oil reservoir.
166	Maintenance	Maintenance	Internal to Component	Driver	Breaker	ESW	1985	Failure to Start	Partial	Two raw water pump breaker main wipes were out of adjustment.
167	Maintenance	Maintenance	Internal to Component	Driver	Breaker	HPI	1991	Failure to Start	Partial	HPI pump breakers failed due to a broken pawl, and a broken closing coil.
168	Maintenance	Maintenance	Internal to Component	Driver	Breaker	SLC	1999	Failure to Start	Partial	SLC Pump Breakers Fail to pickup on degraded voltage test
169	Maintenance	Maintenance	Internal to Component	Driver	Breaker	AFW	1992	Failure to Start	Partial	With the unit in a refueling outage, following repairs to a motor driven auxiliary feedwater pump local/remote switch of the circuit breaker, personnel found that the switch contacts would not close. This failure rendered one of three auxiliary feedwater pumps inoperable. The cause of the failure appears to be due to dirty/corroded contacts on the switch.
170	Maintenance	Maintenance	Internal to Component	Pump	Bearing	ESW	1985	Failure to Run	Partial	High ESW pump vibration was caused by wearing of the upper bearings.
171	Maintenance	Maintenance	Operational/ Human Error	Driver	Breaker	RHR-B	1990	Failure to Start	Partial	RHR pump breaker overcurrent trips out of calibration.
172	Maintenance	Maintenance	Operational/ Human Error	Driver	Breaker	RHR-B	1991	Failure to Start	Partial	While performing preventive maintenance calibration check on the protective relays for a residual heat removal pump motor 4kv breaker, it was found that all overcurrent relays for two pumps were out of calibration
173	Maintenance	Maintenance	Operational/ Human Error	Pump	Lubrication	HPI	1991	Failure to Run	Partial	Following an overhaul of the HPI pumps. Too much oil flow led to excessive oil leakage, which would have failed HPI pumps before end of mission.
174	Maintenance	Maintenance	Operational/ Human Error	Suction	Piping	RHR-P	1982	Failure to Run	Complete	Shutdown cooling was lost due to nitrogen intrusion because of backflushing a filter in the purification system.
175	Maintenance	Maintenance	Operational/ Human Error	Suction	Strainer	HPI	1985	Failure to Run	Partial	Strainers found still installed in the suction piping of the high-pressure injection pumps was a condition not considered in the operating design. The strainers were found during maintenance to repair a slight flange leak. The strainers had been placed in the suction piping during construction and were to be in place during system flushing to prevent any debris from reaching the pumps. However, the strainers should have been removed after system flushing prior to functional testing

Item	Discovery Method	Coupling Factor	Proximate Cause	Segment	Piece Part	System	Year	Failure Mode	Degree of Failure	Description
176	Maintenance	Maintenance	Other	Driver	Breaker	ESW	1982	Failure to Start	Partial	ESW pump circuit breakers found damaged. Defective arc chute and cracked secondary coupler.
177	Maintenance	Maintenance	Other	Driver	Breaker	ESW	1984	Failure to Start	Partial	ESW pump breaker failures, broken screw, no lubrication, and a bent track
178	Maintenance	Operational	Operational/ Human Error	Pump	Lubrication	ESW	1993	Failure to Run	Partial	Low pressure RHR bearing oil level not maintained high enough when new smaller sightglass installed. Second event the sightglass was broken when adding oil.
179	Maintenance	Operational	Operational/ Human Error	Suction	Strainer	ESW	1986	Failure to Run	Complete	A service water strainer was placed in service without being vented resulting in air binding system and loss of charging pump service water pumps.
180	Test	Design	Design/ Construction/ Manufacture/ Installation Inadequacy	Driver	Breaker	HPI	1980	Failure to Start	Partial	Upon testing the safety injection pumps it was found that the 6900-v breakers would lock-out preventing pump start if they were given a close signal for >0.32 seconds when a trip condition existed. There is no indication to operations when this locked-out condition exists. The breaker appears to be available for service when it actually is not. The only means of clearing the condition is to remove and reinstall the fuses at the breaker or manually change the state of the relays.
181	Test	Design	Design/ Construction/ Manufacture/ Installation Inadequacy	Driver	I&C	AFW	1981	Failure to Start	Almost Complete	Two low suction pressure trips for the AFW pumps were mis-calibrated, which prevented the pumps from starting.
182	Test	Design	Design/ Construction/ Manufacture/ Installation Inadequacy	Driver	I&C	AFW	1992	Failure to Start	Complete	A modification design error (in 1983-1984) removed a start permissive interlock contact. At cold shutdown this de-energized the auxiliary lube oil pump, consequently, when one AFW pump was started it ran for 2.5 seconds and tripped on low oil pressure. Further investigation showed that both units AFW pumps would be affected in the same way. The design error combined with insufficient post modification testing led to this CCF event.
183	Test	Design	Design/ Construction/ Manufacture/ Installation Inadequacy	Pump	Shaft	AFW	1988	Failure to Run	Partial	The AFW pumps were susceptible to corrosion cracking of their bushings. A different material was needed for the bushings.
184	Test	Design	Design/ Construction/ Manufacture/ Installation Inadequacy	Pump	Coupling	ESW	1994	Failure to Start	Partial	Pump produced no flow when started. A shaft coupling failed. Material was determined to be brittle and have low impact properties. The coupling was replaced on all pumps with a type of material more suitable for this application.
185	Test	Design	Design/ Construction/ Manufacture/ Installation Inadequacy	Pump	Shaft	AFW	1988	Failure to Run	Almost Complete	An auxiliary feedwater pump failed its performance test. Subsequent inspection of the pump internals revealed significant damage, including a split in the center shaft sleeve. The AFW pumps were susceptible to corrosion cracking of their bushings. A different material was needed for the bushings.
186	Test	Design	Design/ Construction/ Manufacture/ Installation Inadequacy	Suction	Piping	AFW	1999	Failure to Run	Partial	All AFW trains declared inoperable due to inadequate suction flow capability from the nuclear service water alternate source. Inadequate flow caused by corroded piping. Piping is undersized so there is little margin for piping degradation. Since this is 1 of 4 suction sources, the safety significance is limited.

Item	Discovery Method	Coupling Factor	Proximate Cause	Segment	Piece Part	System	Year	Failure Mode	Degree of Failure	Description
187	Test	Design	Design/ Construction/ Manufacture/ Installation Inadequacy	Suction	Valve	ESW	1983	Failure to Start	Partial	Low discharge pressure was caused by insufficient suction pressure. Service water flow to parallel components was adjusted.
188	Test	Design	Design/ Construction/ Manufacture/ Installation Inadequacy	Suction	Tank	SLC	1991	Failure to Run	Complete	During the performance of a special test on the available NPSH of the SLC pumps, the pumps began to cavitate unexpectedly. The SLC systems of both units were declared inoperable. The causes of this event are inadequate modification testing and an error in the original design calculations.
189	Test	Design	Design/ Construction/ Manufacture/ Installation Inadequacy	Suction	Tank	SLC	1991	Failure to Run	Complete	During the performance of a special test on Unit 1 to determine the available NPSH of the SLC pumps, the pumps began to cavitate unexpectedly. The SLC systems of both units were declared inoperable. The causes of this event are inadequate modification testing and an error in the original design calculations.
190	Test	Design	Design/ Construction/ Manufacture/ Installation Inadequacy	Suction	Tank	ESW	1986	Failure to Run	Complete	Loss of prime in the condenser circulating water siphon flow system caused loss of low pressure service water pumps. Pumps lost suction during a test due to poor design.
191	Test	Design	Operational/ Human Error	Driver	Breaker	AFW	1985	Failure to Start	Complete	Both AFW pumps failed to start when tested, due to the circuit breakers not being racked in properly.
192	Test	Design	Other	Driver	I&C	RHR-B	1982	Failure to Start	Partial	A functional test revealed a sliding link in control room panel open. Further investigation revealed a total of four links open. These links, left open, negated all autostart capability of 2 of 4 RHR pumps. It could not be determined why these four links were open.
193	Test	Design	Other	Driver	I&C	ESW	1992	Failure to Start	Partial	Valve position contacts prevented ESW pump circuit breakers from closing. Poor design resulted in water intrusion in the valve limit switch box.
194	Test	Design	Other	Driver	Breaker	SLC	1986	Failure to Start	Complete	During a test, both Squib Valve Detonators shorted after firing and the Control Power Transformer fuse blew causing the pump motor trip. This was caused by improper fuse coordination between the Control Power Transformer fuse and the Squib Valve Detonator fuses. The redundant system's Squib Valve was also fired during this test, without running the associated pump, and one of the Squib Valve Detonators shorted after firing. The same fuse coordination problem existed for both systems.
195	Test	Design	Other	Suction	I&C	AFW	1985	Failure to Run	Almost Complete	Testing of the turbine driven AFW pump resulted in a low suction trip of the motor driven pump. The turbine driven pump had a faulty governor. It was during the post maintenance test of turbine driven pump that speed oscillations occurred causing pressure oscillations in the suction of the motor driven pump that was in service. Foreign material in the suction gauge protectors resulted in the pressure sensors sensing only the low pressures and not the high pressures of the oscillations, so the motor driven pump tripped on low pressure.
196	Test	Environmental	Design/ Construction/ Manufacture/ Installation Inadequacy	Pump	Coupling	ESW	1987	Failure to Start	Partial	Test showed two ESW pumps failed. Pump shafts were corroded and found to be made of incorrect material.

Item	Discovery Method	Coupling Factor	Proximate Cause	Segment	Piece Part	System	Year	Failure Mode	Degree of Failure	Description
197	Test	Environmental	External Environment	Discharge	Recirc	HPI	1992	Failure to Run	Almost Complete	Safety Injection pumps were declared inoperable due to an observed declining trend in the pump's recirculation flow. The cause of the Safety Injection pump reduced recirculation flow is attributed to foreign material blockage within the associated minimum flow recirculation line flow orifice.
198	Test	Environmental	External Environment	Driver	Bearing	RHR-B	1991	Failure to Run	Partial	Two LCI pumps were declared inoperable due to high motor vibration.
199	Test	Environmental	Internal to Component	Discharge	Recirc	HPI	1991	Failure to Run	Partial	Something in HPI pump recirculation line was restricting flow. The piece later dislodged and no identification was made. Both SI pumps had inadequate recirculation flow.
200	Test	Environmental	Internal to Component	Pump	Impeller/Wear Rings	ESW	1982	Failure to Run	Partial	Low ESW pump head values were caused excessive wear of pump impeller due to foreign material in the service water.
201	Test	Environmental	Internal to Component	Pump	Impeller/Wear Rings	ESW	1991	Failure to Run	Partial	ESW pumps failed to meet the minimum flow requirements of test. The cause of the failure is normal wearout of the pump impeller due to the high sand content of the water being pumped. Pump impeller lift was adjusted.
202	Test	Environmental	Internal to Component	Pump	Impeller/Wear Rings	ESW	1992	Failure to Start	Partial	ESW pumps had reduced flow and discharge pressure. Worn impellers/wearing rings. Cause determined to be normal wear and high sand content of river water.
203	Test	Environmental	Internal to Component	Pump	Impeller/Wear Rings	ESW	1995	Failure to Start	Partial	Marine growth caused low flow and speed condition for two service water pumps
204	Test	Environmental	Internal to Component	Pump	Impeller/Wear Rings	ESW	1993	Failure to Run	Partial	Essential service water pumps were declared inoperable, due to low pump head values. The low pump heads were caused by excessive wear of pump impeller due to sand in the service water.
205	Test	Environmental	Internal to Component	Pump	Impeller/Wear Rings	ESW	1985	Failure to Run	Partial	ESW pumps failed to meet the minimum flow requirements of test. A rag was found in one impeller and a plastic bottle in the other.
206	Test	Environmental	Internal to Component	Pump	Impeller/Wear Rings	ESW	1982	Failure to Start	Partial	Essential service water pumps were declared inoperable, due to low pump head valves. The low pump heads were caused by excessive wear of pump impeller due to foreign material in the service water.
207	Test	Environmental	Internal to Component	Pump	Impeller/Wear Rings	ESW	1995	Failure to Start	Partial	Pumps failed performance test. Sand in water eroded pump internals. Pump lift was adjusted.
208	Test	Environmental	Internal to Component	Pump	Impeller/Wear Rings	HPI	1984	Failure to Run	Almost Complete	One HPI pump seized, the second would have seized if operated.
209	Test	Environmental	Internal to Component	Pump	Impeller/Wear Rings	ESW	1994	Failure to Start	Partial	Degraded performance identified during testing. Sand in water was causing accelerated wear of the pump internals. Lift was adjusted for three pumps and one pump internals were replaced.
210	Test	Environmental	Internal to Component	Pump	Bearing	ESW	1992	Failure to Run	Partial	Abrasive particles present in ocean water produced accelerated wear of shaft bearing journals.
211	Test	Environmental	Internal to Component	Pump	Impeller/Wear Rings	ESW	1990	Failure to Run	Partial	ESW pump impeller lift out of adjustment.
212	Test	Environmental	Internal to Component	Suction	Strainer	ESW	1990	Failure to Run	Partial	Essential service water pumps were declared inoperable, due to low pump head valves. The low pump heads were caused by suction blockage due to foreign material in the service water.
213	Test	Environmental	Internal to Component	Suction	Piping	ESW	1990	Failure to Start	Partial	ESW pumps failed flow testing. Foreign material blocked the suction.

Item	Discovery Method	Coupling Factor	Proximate Cause	Segment	Piece Part	System	Year	Failure Mode	Degree of Failure	Description
214	Test	Environmental	Internal to Component	Suction	Strainer	ESW	1982	Failure to Run	Partial	Failures occurred on residual heat removal service water pumps. The pumps failed to meet flow and pressure requirements. Failure was due to debris lodging in pump impellers. Source of debris was maintenance activities, broken traveling water screens, and the inadvertent opening of a RHR minimum flow line which washed materials into suction pit.
215	Test	Maintenance	Design/Construction/Manufacture/Installation/Inadequacy	Pump	Casing	ESW	1997	Failure to Run	Almost Complete	Both ESW pumps failed due to installation of wrong material for pump casing flanges by vendor during pump overhaul. The vendor overhauled the pumps without changing material. The plant returned the pumps to the warehouse also without verifying material.
216	Test	Maintenance	Design/Construction/Manufacture/Installation/Inadequacy	Pump	Impeller/Wear Rings	ESW	1988	Failure to Start	Partial	Essential service water pumps were declared inoperable, due to low pump head valves. The low pump heads were caused by excessive wear of pump impeller due to foreign material in the service water.
217	Test	Maintenance	Internal to Component	Discharge	Valve	HPI	1984	Failure to Start	Partial	OCP pump low flow rates due to inaccuracies in positioning the throttle valves.
218	Test	Maintenance	Internal to Component	Driver	Breaker	RHR-B	1997	Failure to Start	Partial	Breaker latch check switch failed on both pumps. Lack of lubrication.
219	Test	Maintenance	Internal to Component	Driver	Breaker	AFW	1997	Failure to Start	Almost Complete	The circuit breakers associated with the AFW Pumps failed to close as required. The root cause of the failure was the binding in the operating mechanism. The plunger apparently did not always complete its upward movement to close and latch the breaker, due to accumulated dirt and lubricants.
220	Test	Maintenance	Internal to Component	Driver	Breaker	ESW	1998	Failure to Start	Partial	Service water pumps fail to start due to circuit breaker failures. Pump breakers failed to close due to failures of the charging spring/motor and closing spring motor.
221	Test	Maintenance	Internal to Component	Driver	Breaker	RHR-B	1986	Failure to Start	Partial	RHR pump circuit breakers failed during a start for testing. Bend switch and binding mechanism. Attributed to inadequate maintenance.
222	Test	Maintenance	Internal to Component	Driver	Breaker	ESW	1998	Failure to Start	Partial	Two RHR service water pump breakers would not close due to dirty contacts in breakers.
223	Test	Maintenance	Internal to Component	Driver	Bearing	ESW	1985	Failure to Run	Partial	Service water pumps exhibited vibration. Attributed to normal wear.
224	Test	Maintenance	Internal to Component	Pump	Impeller/Wear Rings	ESW	1998	Failure to Start	Partial	Two ESW pumps failed to develop adequate flow/pressure - pumps degraded.
225	Test	Maintenance	Internal to Component	Pump	Lubrication	SLC	1992	Failure to Run	Partial	Standby Liquid Control pumps lost oil while running. The gasket between the crankcase frame cap and the gear housing cover was worn.
226	Test	Maintenance	Internal to Component	Pump	Impeller/Wear Rings	ESW	1985	Failure to Start	Partial	Emergency service water pumps discharge pressure below allowable limits. Causes were loose impellers, dropped impeller, and worn internals.
227	Test	Maintenance	Internal to Component	Pump	Impeller/Wear Rings	ESW	1992	Failure to Start	Partial	ESW pumps had reduced flow and discharge pressure. Worn impellers/wearing rings. One pump also exhibited high vibration.
228	Test	Maintenance	Internal to Component	Pump	Coupling	ESW	1987	Failure to Start	Almost Complete	Two ESW pumps had failed couplings. Cause attributed to abnormal stress.
229	Test	Maintenance	Internal to Component	Pump	Coupling	ESW	1990	Failure to Start	Partial	ESW pumps had reduced flow and discharge pressure. Worn impellers/wearing rings. Cause determined to be normal wear and high sand content of river water.

Item	Discovery Method	Coupling Factor	Proximate Cause	Segment	Piece Part	System	Year	Failure Mode	Degree of Failure	Description
230	Test	Maintenance	Internal to Component	Pump	Impeller/Wear Rings	ESW	1982	Failure to Run	Partial	Loss of Service Water pump due to wearout at end of life.
231	Test	Maintenance	Internal to Component	Pump	Impeller/Wear Rings	RHR-B	1985	Failure to Start	Partial	The first pump failed to meet required flow rate. The second was drawing excessive amperage. Both conditions were attributed to worn internals.
232	Test	Maintenance	Internal to Component	Pump	Impeller/Wear Rings	ESW	1983	Failure to Run	Partial	RHR Service Water pumps failed flow tests due to wearout and had to be rebuilt.
233	Test	Maintenance	Internal to Component	Pump	Impeller/Wear Rings	ESW	1988	Failure to Start	Partial	Service water pumps were noted to have high vibrations and low discharge pressure. Uneven wear caused pump to be out of balance.
234	Test	Maintenance	Internal to Component	Pump	Impeller/Wear Rings	ESW	1994	Failure to Start	Partial	Two ESW pumps had low discharge pressure during testing. Each pump had worn internals and both pump internals were replaced.
235	Test	Maintenance	Internal to Component	Pump	Impeller/Wear Rings	ESW	1985	Failure to Start	Partial	ESW pumps failed to meet the minimum flow requirements of test. The cause of the failure is normal wearout of the pump impeller due to the high sand content of the water being pumped. Pump impeller lift was adjusted.
236	Test	Maintenance	Internal to Component	Pump	Impeller/Wear Rings	ESW	1992	Failure to Start	Partial	ESW pumps had reduced flow and discharge pressure. Worn impellers/wearing rings.
237	Test	Maintenance	Internal to Component	Pump	Impeller/Wear Rings	ESW	1985	Failure to Run	Partial	ESW pumps failed due to worn internals.
238	Test	Maintenance	Internal to Component	Pump	Impeller/Wear Rings	ESW	1990	Failure to Start	Partial	ESW pumps had reduced flow and discharge pressure. Worn impellers/wearing rings.
239	Test	Maintenance	Internal to Component	Pump	Bearing	ESW	1985	Failure to Run	Partial	ESW pumps had reduced flow and discharge pressure. Worn impellers/wearing rings.
240	Test	Maintenance	Internal to Component	Pump	Impeller/Wear Rings	ESW	1985	Failure to Start	Partial	ESW pumps had reduced flow and discharge pressure. Worn impellers/wearing rings.
241	Test	Maintenance	Internal to Component	Pump	Shaft	ESW	1993	Failure to Run	Partial	Service water pumps were noted to have high vibrations and low discharge pressure. Uneven wear caused pump to be out of balance.
242	Test	Maintenance	Internal to Component	Pump	Impeller/Wear Rings	ESW	1988	Failure to Start	Partial	Essential service water pumps were declared inoperable, due to low pump head valves. The low pump heads were caused by wear and aging of internals.
243	Test	Maintenance	Internal to Component	Pump	Impeller/Wear Rings	ESW	1984	Failure to Start	Partial	Essential service water pumps were declared inoperable, due to low pump head valves. The low pump heads were caused by wear and aging of internals.
244	Test	Maintenance	Internal to Component	Pump	Impeller/Wear Rings	ESW	1988	Failure to Start	Partial	ESW pumps had reduced flow and discharge pressure. Worn impellers/wearing rings.
245	Test	Maintenance	Internal to Component	Pump	Impeller/Wear Rings	ESW	1990	Failure to Start	Partial	ESW impeller gaps too wide. Gaps adjusted.
246	Test	Maintenance	Internal to Component	Pump	Impeller/Wear Rings	ESW	1981	Failure to Start	Partial	Loss of Service Water pump due to wearout at end of life.
247	Test	Maintenance	Internal to Component	Pump	Impeller/Wear Rings	ESW	1985	Failure to Run	Partial	Wear caused high ESW pump bearing temperatures, vibration, and low amperage/flow.
248	Test	Maintenance	Internal to Component	Pump	Impeller/Wear Rings	ESW	1986	Failure to Run	Partial	ESW pump performance decreased 15% and 8% respectively since last test. Pumps were replaced.
249	Test	Maintenance	Internal to Component	Pump	Impeller/Wear Rings	ESW	1984	Failure to Run	Partial	Loss of Service Water pump due to wearout at end of life.

Item	Discovery Method	Coupling Factor	Proximate Cause	Segment	Piece Part	System	Year	Failure Mode	Degree of Failure	Description
250	Test	Maintenance	Internal to Component	Pump	Impeller/Wear Rings	HPI	1985	Failure to Start	Partial	The CCPs were tested and had low flow rates. The most probable cause is attributed to observed degradation of the pumps. The CCPs are subject to normal wear associated with their secondary duty of providing normal charging flow.
251	Test	Maintenance	Internal to Component	Pump	Impeller/Wear Rings	HPI	1983	Failure to Start	Partial	SI pump and both CCPs failed to meet the minimum head curve requirements. The cause of pump head capacity degradation has been attributed to normal pump operation. The inability to balance flows has been attributed to the lower head capacity of the pumps.
252	Test	Maintenance	Internal to Component	Pump	Impeller/Wear Rings	ESW	1991	Failure to Start	Partial	ESW pumps had reduced flow and discharge pressure. Worn impellers/wearing rings.
253	Test	Maintenance	Internal to Component	Pump	Impeller/Wear Rings	ESW	1984	Failure to Run	Partial	Containment spray raw water pumps failed flow tests. Aging and normal wear.
254	Test	Maintenance	Internal to Component	Pump	Impeller/Wear Rings	ESW	1988	Failure to Run	Partial	ESW pumps failed to meet the minimum flow requirements of test. The cause of the failure is normal wearout of the pump impeller due to brackish water corrosion.
255	Test	Maintenance	Internal to Component	Pump	Impeller/Wear Rings	ESW	1989	Failure to Start	Partial	ESW pumps had reduced flow and discharge pressure. Worn impellers/wearing rings.
256	Test	Maintenance	Internal to Component	Pump	Impeller/Wear Rings	ESW	1987	Failure to Run	Partial	ESW pump low flow. Worn impellers.
257	Test	Maintenance	Internal to Component	Pump	Impeller/Wear Rings	ESW	1990	Failure to Run	Partial	ESW pumps had worn and cracked impellers. Aging and normal wear.
258	Test	Maintenance	Internal to Component	Pump	Impeller/Wear Rings	ESW	1985	Failure to Run	Partial	The charging pump service water pumps degraded. Caused by expected wear of pump due to erosion and corrosion properties of the process fluid involved
259	Test	Maintenance	Internal to Component	Pump	Impeller/Wear Rings	ESW	1986	Failure to Run	Partial	ESW pumps had worn impellers and one had a plugged strainer.
260	Test	Maintenance	Internal to Component	Pump	Packing/Seals	ESW	1981	Failure to Start	Partial	RHR service water pumps failed to meet flow requirements due to seal water leakage and pump wearout.
261	Test	Maintenance	Internal to Component	Pump	Impeller/Wear Rings	ESW	1994	Failure to Run	Partial	Two ESW pumps had internal deterioration, one of which was indicated by high vibration readings.
262	Test	Maintenance	Operational/ Human Error	Driver	I&C	ESW	1989	Failure to Start	Partial	Emergency equipment service water pump relays were not reset following a load shedding test 30 hours before.
263	Test	Maintenance	Operational/ Human Error	Driver	Motor	ESW	1994	Failure to Run	Partial	Leak test of the containment cooling service water pump vault watertight door revealed excessive leakage. Flooding and leakage past this door would make inoperable two of four containment cooling service water pumps. Procedural inadequacy was cited as the cause for the degraded door seals.
264	Test	Maintenance	Operational/ Human Error	Pump	Casing	RHR-P	1989	Failure to Start	Complete	Both loops of the residual heat removal system were declared inoperable due to gas binding of both RHR pumps. The gas binding was caused by entry of nitrogen gas into the reactor coolant system from accumulator. The root cause of this event has been attributed to personnel error. Personnel did not comply with the specific requirements in the accumulator discharge check valve full flow test procedure due to inattention to detail.

Item	Discovery Method	Coupling Factor	Proximate Cause	Segment	Piece Part	System	Year	Failure Mode	Degree of Failure	Description
265	Test	Maintenance	Operational/ Human Error	Pump	Packing/Seals	AFW	1996	Failure to Run	Partial	During the performance of Steam-Driven Emergency Feedwater Pump testing, sparks were observed emanating from the outboard mechanical seal area. The sparks appeared to be due to a mechanical interference within the mechanical seal assembly. The pump mechanical seal was disassembled and determined to have been improperly installed during the last refueling outage. The evaluation identified a mechanical seal design deficiency and inadequate corrective action for a previously identified event as the primary causes for this event. A contributing cause for this event was found to be inadequate predictive maintenance techniques. The electric AFW pump exhibited the same problem.
266	Test	Maintenance	Other	Driver	Breaker	ESW	1984	Failure to Start	Partial	ESW pump breakers tripped due to failed voltage control devices.
267	Test	Maintenance	Other	Driver	Breaker	ESW	1984	Failure to Start	Partial	ESW pump breaker overcurrent trip devices tripping too low.
268	Test	Operational	Design/ Construction/ Manufacture/ Installation Inadequacy	Discharge	Check Valve	ESW	1999	Failure to Run	Partial	Two ESW pumps had low flow due to interaction with the two other pumps when all four pumps were running.
269	Test	Operational	Operational/ Human Error	Driver	I&C	ESW	1990	Failure to Start	Complete	An emergency service water pump failed to start and was declared inoperable. Further investigation determined that the failure of the pump to start was due to a tripped emergency engine shutdown device. Operations personnel performing the testing did not recognize the need to reset it prior to starting the pump. Examination of the other two ESW pumps revealed that their emergency shutdown devices were also in the tripped condition.
270	Test	Operational	Operational/ Human Error	Suction	Piping	ESW	1989	Failure to Run	Partial	Inadequate procedure led to air binding of operating ESW pumps.
271	Test	Quality	Design/ Construction/ Manufacture/ Installation Inadequacy	Driver	Breaker	LCS	1980	Failure to Start	Complete	Relay extra contacts left connected during construction, prevented Core Spray pump start with emergency diesel generator breakers racked out.
272	Test	Quality	Design/ Construction/ Manufacture/ Installation Inadequacy	Driver	I&C	AFW	1980	Failure to Start	Complete	During surveillance testing, neither motor-driven AFW pump would start. The pump control circuit was found with autostart defeat switches labeled backwards, causing all autostarts except the low-low steam generator level to be defeated. The labels were corrected and the links were closed. The original installation error was the result of an inadequate design change process that did not require sufficient verification and testing of the modification.
273	Test	Quality	Design/ Construction/ Manufacture/ Installation Inadequacy	Pump	Impeller/Wear Rings	ESW	1986	Failure to Start	Partial	Testing of the service water system disclosed that the performance of the three service water pumps was below requirements. The condition is the result of both an inadequate system design and the installation of replacement impellers, which were not modified by the vendor to improve performance, as were the original impellers.
274	Test	Quality	Operational/ Human Error	Driver	I&C	ESW	1982	Failure to Start	Partial	Two ESW pumps failed to start. One ESW pump failed to function as a result of loose wires on relay terminals in both pump logic schemes, a loose states link and an instantaneous contact found out of adjustment on the other pump logic scheme.

Appendix A

Appendix B
Pump Data Summary by Segment

Appendix B

Pump Data Summary by Segment

This appendix is a summary of the data evaluated in the common-cause failure (CCF) data collection effort for pumps. This appendix supports the charts in Chapter 4. The table is sorted alphabetically, by the first four columns.

Appendix B

Table B-1. Pump CCF event summary, sorted by segment..... 3

Table B-1. Pump CCF event summary, sorted by segment.

Item	Segment	Proximate Cause	Discovery Method	Piece Part	Coupling Factor	System	Year	Failure Mode	Degree of Failure	Description
1	Discharge	Design/ Construction/ Manufacture/ Installation Inadequacy	Demand	Valve	Design	AFW	1986	Failure to Start	Partial	Both the turbine driven and motor driven AFW pumps could not produce full flow because the cages in their discharge valve trapped debris and plugged.
2	Discharge	Design/ Construction/ Manufacture/ Installation Inadequacy	Demand	Valve	Design	AFW	1985	Failure to Start	Partial	Controller problems in the steam and diesel driven AFW pumps caused the pumps to trip on low suction pressure. The pump discharge flow controller valves were also not set properly after last maintenance. Low suction trips were due to design error.
3	Discharge	Design/ Construction/ Manufacture/ Installation Inadequacy	Test	Check Valve	Operational	ESW	1999	Failure to Run	Partial	Two ESW pumps had low flow due to interaction with the two other pumps when all four pumps were running.
4	Discharge	External Environment	Demand	Check Valve	Design	AFW	1983	Failure to Start	Almost Complete	Hot water in the AFW pump casings caused the pumps to become vapor bound. The hot water was from leaking check valves upstream of the pumps. This event occurred once on the turbine driven pump and 5 times on the motor driven pump.
5	Discharge	External Environment	Inspection	Piping	Design	HPI	1994	Failure to Run	Partial	Due to a leaking socket weld in the common recirculation line, all three SI pumps were declared inoperable. The underlying cause of the leak was a crack in the socket weld in the common recirculation line, caused by pipe displacement from air entrainment and pump misalignment.
6	Discharge	External Environment	Test	Recirc	Environmental	HPI	1992	Failure to Run	Almost Complete	Safety Injection pumps were declared inoperable due to an observed declining trend in the pump's recirculation flow. The cause of the Safety Injection pump reduced recirculation flow is attributed to foreign material blockage within the associated minimum flow recirculation line flow orifice.
7	Discharge	Internal to Component	Demand	Valve	Environmental	AFW	1988	Failure to Run	Partial	After automatic start, motor driven AFW pump swapped suction automatically to the nuclear service water system when a sustained low suction pressure condition was sensed, and raw water entered two steam generators. After the initial trip recovery, it was noted that AFW flow to steam generators had degraded following the suction swap. Inspections revealed that the cavitol cages for these valves were clogged with shredded Asiatic clam shells.
8	Discharge	Internal to Component	Demand	Valve	Environmental	AFW	1988	Failure to Run	Partial	After automatic start, motor driven AFW pump swapped suction automatically to the nuclear service water system when a sustained low suction pressure condition was sensed, and raw water entered two steam generators. After the initial trip recovery, it was noted that AFW flow to steam generators had degraded following the suction swap. Inspections revealed that the cavitol cages for these valves were clogged with shredded Asiatic clam shells.
9	Discharge	Internal to Component	Inspection	Check Valve	Maintenance	AFW	1990	Failure to Start	Almost Complete	Leakage past AFW check valves caused AFW pumps to become steam bound. Closed motor operated valve in line. Scheduled check valves for replacement next outage.
10	Discharge	Internal to Component	Test	Recirc	Environmental	HPI	1991	Failure to Run	Partial	Something in HPI pump recirculation line was restricting flow. The piece later dislodged and no identification was made. Both SI pumps had inadequate recirculation flow.

Item	Segment	Proximate Cause	Discovery Method	Piece Part	Coupling Factor	System	Year	Failure Mode	Degree of Failure	Description
11	Discharge	Internal to Component	Test	Valve	Maintenance	HPI	1984	Failure to Start	Partial	CCP pump low flow rates due to inaccuracies in positioning the throttle valves.
12	Discharge	Operational/ Human Error	Inspection	Valve	Operational	HPI	1987	Failure to Start	Almost Complete	While attempting to fill the safety injection accumulators, it was discovered that two of three SI pumps had been isolated from the high head injection flowpath.
13	Discharge	Operational/ Human Error	Inspection	Valve	Operational	HPI	1993	Failure to Run	Partial	One AFW pump failed due to incorrect procedure which allowed pump to be run without flow, other AFW pump was allowed to run past max flow rate. It is unclear whether these mistakes were due to inadequate procedures or staff errors, but it was assumed to be a failure to follow procedure.
14	Discharge	Operational/ Human Error	Inspection	Valve	Operational	AFW	1994	Failure to Start	Complete	Following a trip, the AFW Pumps were secured and the discharge flow control valves for the Motor Driven Pumps were closed. Later, an operator discovered during a routine Control Board walkdown that the valves were closed. Subsequent investigation revealed the AFW system had not been placed in standby readiness per the operating procedure after the system was secured.
15	Discharge	Other	Demand	Valve	Maintenance	ESW	1980	Failure to Start	Partial	RHR service water pumps were started to put torus cooling in service. When these pumps would not deliver required discharge pressure, they were declared inoperable. The seal in an air release valve was bad, allowing a vent on the discharge line.
16	Driver	Design/ Construction/ Manufacture/ Installation Inadequacy	Demand	Breaker	Quality	ESW	1996	Failure to Start	Partial	Two RHRSW pumps fail to start due to breaker failures. Wrong contacts were installed. Design called for contacts to have a minimum current interrupt rating of 6 amps; contacts installed (that subsequently failed) had current interrupt rating of only 2.2 amps.
17	Driver	Design/ Construction/ Manufacture/ Installation Inadequacy	Demand	I&C	Design	AFW	1997	Failure to Run	Partial	One actual AFW pump failure due to spurious electronic overspeed trip. Determined that all three pumps were susceptible to spurious overspeed trips.
18	Driver	Design/ Construction/ Manufacture/ Installation Inadequacy	Demand	I&C	Design	AFW	1981	Failure to Start	Almost Complete	A modification to the control instrumentation for two AFW pumps resulted in a backfeed situation such that when called upon to start, both pumps would not start.
19	Driver	Design/ Construction/ Manufacture/ Installation Inadequacy	Demand	I&C	Design	AFW	1981	Failure to Start	Almost Complete	Two AFW pumps failed to automatically start due to low suction pressure trips. A modification was installed to prevent this. This effect was discovered previously, but apparently had not been corrected prior to an attempt to start the pumps three weeks later.
20	Driver	Design/ Construction/ Manufacture/ Installation Inadequacy	Demand	I&C	Quality	AFW	1989	Failure to Start	Complete	Both motor driven auxiliary feedwater pumps failed to start when the operator tried to start them manually. While preparing a design change, the designer failed to review all the unit specific documentation associated with the motor-driven AFW pump wiring and made the erroneous assumption that both units switchgear compartment internal wiring was identical. In fact, the wiring for each unit was different. Consequently, when the design change was installed, it was installed in accordance with the erroneous design. The wiring discrepancy was corrected and the motor-driven AFW pumps were tested and returned to service.

Item	Segment	Proximate Cause	Discovery Method	Piece Part	Coupling Factor	System	Year	Failure Mode	Degree of Failure	Description
21	Driver	Design/ Construction/ Manufacture/ Installation Inadequacy	Demand	Lubrication	Design	RHR-P	2000	Failure to Run	Complete	Both RHR/LPI pumps fail to run due to improper oil in system. High bearing temperatures occurred when the pumps were operated. This was due to the wrong lube oil being used, which had too high a viscosity. Inadequate vendor design information resulted in the higher viscosity oil being used and additional exacerbating problems such as insufficient bearing clearances.
22	Driver	Design/ Construction/ Manufacture/ Installation Inadequacy	Demand	Motor	Quality	ESW	1987	Failure to Start	Partial	ESW pump motors tripped on overcurrent. The overcurrent trip was due to a ground and a short on the pump motor.
23	Driver	Design/ Construction/ Manufacture/ Installation Inadequacy	Inspection	I&C	Design	AFW	1994	Failure to Start	Partial	Single failure would prevent auto initiation of AFW. Circuit design did not provide separation required by standards and code. The single failure identified was a short circuit across two conductors of the actuation relays associated with the initiation logic matrix.
24	Driver	Design/ Construction/ Manufacture/ Installation Inadequacy	Inspection	Lubrication	Design	HPI	2000	Failure to Run	Partial	CVC makeup oil pump motor too small for certain accidents.
25	Driver	Design/ Construction/ Manufacture/ Installation Inadequacy	Inspection	Piping	Environmental	HPI	2000	Failure to Run	Partial	Microbiologically induced corrosion leak on service water lines to two charging/HPI pump lube oil coolers.
26	Driver	Design/ Construction/ Manufacture/ Installation Inadequacy	Inspection	Supports	Design	RHR-B	1986	Failure to Start	Partial	RHR motor internal supports were cracked due to stress and vibration. Design improvements were made.
27	Driver	Design/ Construction/ Manufacture/ Installation Inadequacy	Maintenance	I&C	Design	HPI	1996	Failure to Run	Partial	A lead was lifted in an emergency bus DC control circuit resulting in one charging pump tripping while running on the alternate power supply. Further investigation into this event revealed an anomaly, which could result in having no operating charging pumps. The cause of the event has been determined to be an error in the original design of the charging pump interlock logic. The anomaly would occur upon a loss of the DC control power to one emergency bus if 'C' charging pump was powered from the other bus.
28	Driver	Design/ Construction/ Manufacture/ Installation Inadequacy	Maintenance	I&C	Design	HPI	1996	Failure to Run	Partial	A lead was lifted in an emergency bus DC control circuit resulting in one charging pump tripping while running on the alternate power supply. Further investigation into this event revealed an anomaly, which could result in having no operating charging pumps. The cause of the event has been determined to be an error in the original design of the charging pump interlock logic. The anomaly would occur upon a loss of the DC control power to one emergency bus if 'C' charging pump was powered from the other bus.

Item	Segment	Proximate Cause	Discovery Method	Piece Part	Coupling Factor	System	Year	Failure Mode	Degree of Failure	Description
29	Driver	Design/ Construction/ Manufacture/ Installation Inadequacy	Test	Breaker	Quality	LCS	1980	Failure to Start	Complete	Relay extra contacts left connected during construction, prevented Core Spray pump start with emergency diesel generator breakers racked out.
30	Driver	Design/ Construction/ Manufacture/ Installation Inadequacy	Test	Breaker	Design	HPI	1980	Failure to Start	Partial	Upon testing the safety injection pumps it was found that the 6900-v breakers would lock-out preventing pump start if they were given a close signal for >0.32 seconds when a trip condition existed. There is no indication to operations when this locked-out condition exists. The breaker appears to be available for service when it actually is not. The only means of clearing the condition is to remove and reinstall the fuses at the breaker or manually change the state of the relays.
31	Driver	Design/ Construction/ Manufacture/ Installation Inadequacy	Test	I&C	Quality	AFW	1980	Failure to Start	Complete	During surveillance testing, neither motor-driven AFW pump would start. The pump control circuit was found with autostart defeat switches labeled backwards, causing all autostarts except the low-low steam generator level to be defeated. The labels were corrected and the links were closed. The original installation error was the result of an inadequate design change process that did not require sufficient verification and testing of the modification.
32	Driver	Design/ Construction/ Manufacture/ Installation Inadequacy	Test	I&C	Design	AFW	1992	Failure to Start	Complete	A modification design error (in 1983-1984) removed a start permissive interlock contact. At cold shutdown this de-energized the auxiliary lube oil pump, consequently, when one AFW pump was started it ran for 2.5 seconds and tripped on low oil pressure. Further investigation showed that both units AFW pumps would be affected in the same way. The design error combined with insufficient post modification testing led to this CCF event.
33	Driver	Design/ Construction/ Manufacture/ Installation Inadequacy	Test	I&C	Design	AFW	1981	Failure to Start	Almost Complete	Two low suction pressure trips for the AFW pumps were mis-calibrated, which prevented the pumps from starting.
34	Driver	External Environment	Demand	Breaker	Maintenance	AFW	1990	Failure to Run	Partial	AFW pumps circuit breakers degraded.
35	Driver	External Environment	Demand	I&C	Environmental	AFW	1984	Failure to Start	Complete	Both AFW pumps failed to start. The problem was traced to two relays (1 per pump). Examination of the relays revealed open circuiting and severe degradation of the insulation.
36	Driver	External Environment	Demand	Motor	Environmental	ESW	1985	Failure to Run	Partial	Two service water motors failed on demand as a result of cement dust contamination.
37	Driver	External Environment	Inspection	I&C	Operational	HPI	1990	Failure to Run	Complete	It was determined that the common minimum flow path return line for the safety injection pumps to the refueling water storage tank was frozen. Previous actions to investigate problems with the freeze protection system were unsuccessful in preventing development of this condition. The two HPI pumps were declared inoperable with this return line frozen. A faulty ambient temperature switch for the RWST heat trace system prevented the heat trace from activating and was subsequently replaced. In addition, administrative controls did not sufficiently recognize the safety significance of flow through this line and the need to ensure flow capability.
38	Driver	External Environment	Maintenance	Motor	Environmental	ESW	1987	Failure to Start	Partial	During an extended service water bay flooding incident, one ESW pump was found grounded by testing, later two more pumps were found to be failed also.

Item	Segment	Proximate Cause	Discovery Method	Piece Part	Coupling Factor	System	Year	Failure Mode	Degree of Failure	Description
39	Driver	External Environment	Test	Bearing	Environmental	RHR-B	1991	Failure to Run	Partial	Two LCI pumps were declared inoperable due to high motor vibration.
40	Driver	Internal to Component	Demand	Breaker	Design	ESW	2000	Failure to Start	Almost Complete	Two ESW pumps failed to start due to their breakers failing to close. The breakers' prop spring bracket has slipped thus preventing proper interfacing between the prop and the prop pin.
41	Driver	Internal to Component	Demand	Breaker	Maintenance	RHR-B	1987	Failure to Start	Partial	RHR pump breakers failed to close when operated remotely from the control room. It was found that the latch roller bearings and the cam follower bearing (internal piece parts of the breaker) were not operating correctly. This prevented the trip latch assembly from resetting and allowing the breaker to close.
42	Driver	Internal to Component	Demand	I&C	Maintenance	ESW	1991	Failure to Start	Partial	Two ESW pumps failed to start due to failed breakers. Inadequate maintenance.
43	Driver	Internal to Component	Demand	Lubrication	Maintenance	HPI	1984	Failure to Run	Partial	Charging pump lube oil cooler fan motor trips on thermal overload. Probable cause: normal wear on motor resulting in increased friction replaced worn motor with spare. During routine inservice testing found that another charging pump lube oil cooler fan motor had a current imbalance. Probable cause: normal aging of motor insulation has resulted in a current imbalance.
44	Driver	Internal to Component	Inspection	Bearing	Maintenance	ESW	1985	Failure to Run	Partial	One service water pump motor upper bearing oil reservoir leaking from cover plate. Another service water pump motor upper oil cooler oil reservoir leaking.
45	Driver	Internal to Component	Inspection	Bearing	Maintenance	ESW	1981	Failure to Run	Partial	ESW motor to pump alignment problems. Bearings worn out.
46	Driver	Internal to Component	Inspection	Breaker	Maintenance	ESW	1996	Failure to Start	Partial	ESW pump breakers fail due to misalignment of the breaker mechanism and internals developed over the years of operation.
47	Driver	Internal to Component	Inspection	I&C	Design	ESW	1982	Failure to Start	Partial	Open circuit breaker resulted in loss of two RHR service water pumps.
48	Driver	Internal to Component	Inspection	Packing/Seals	Maintenance	HPI	1988	Failure to Run	Almost Complete	Smoke was discovered coming from the speed increaser unit for a centrifugal charging pump. Investigation found the two gland seal retaining bolts inside the speed increaser lube oil pump backed out allowing the gland seal to loosen. The gland seal being loosened, caused reduced oil flow to the speed increaser internals and ultimate damage. Other CCPs were inspected, and the same gland seal bolts as on the first pump were found loosened. The cause of the bolts backing out was determined to be lack of a periodic adjustment of the gland seal bolts.
49	Driver	Internal to Component	Maintenance	Breaker	Maintenance	HPI	1991	Failure to Start	Partial	HPI pump breakers failed due to a broken pawl, and a broken closing coil.
50	Driver	Internal to Component	Maintenance	Breaker	Maintenance	SLC	1999	Failure to Start	Partial	SLC Pump Breakers Fail to pickup on degraded voltage test
51	Driver	Internal to Component	Maintenance	Breaker	Maintenance	ESW	1985	Failure to Start	Partial	Two raw water pump breaker main wipes were out of adjustment.
52	Driver	Internal to Component	Maintenance	Breaker	Maintenance	AFW	1992	Failure to Start	Partial	With the unit in a refueling outage, following repairs to a motor driven auxiliary feedwater pump local/remote switch of the circuit breaker, personnel found that the switch contacts would not close. This failure rendered one of three auxiliary feedwater pumps inoperable. The cause of the failure appears to be due to dirty/corroded contacts on the switch.
53	Driver	Internal to Component	Test	Bearing	Maintenance	ESW	1985	Failure to Run	Partial	Service water pumps exhibited vibration. Attributed to normal wear.

Item	Segment	Proximate Cause	Discovery Method	Piece Part	Coupling Factor	System	Year	Failure Mode	Degree of Failure	Description
54	Driver	Internal to Component	Test	Breaker	Maintenance	RHR-B	1986	Failure to Start	Partial	RHR pump circuit breakers failed during a start for testing. Bend switch and binding mechanism. Attributed to inadequate maintenance.
55	Driver	Internal to Component	Test	Breaker	Maintenance	ESW	1998	Failure to Start	Partial	Two RHR service water pump breakers would not close due to dirty contacts in breakers.
56	Driver	Internal to Component	Test	Breaker	Maintenance	RHR-B	1997	Failure to Start	Partial	Breaker latch check switch failed on both pumps. Lack of lubrication.
57	Driver	Internal to Component	Test	Breaker	Maintenance	AFW	1997	Failure to Start	Almost Complete	The circuit breakers associated with the AFW Pumps failed to close as required. The root cause of the failure was the binding in the operating mechanism. The plunger apparently did not always complete its upward movement to close and latch the breaker, due to accumulated dirt and lubricants.
58	Driver	Internal to Component	Test	Breaker	Maintenance	ESW	1998	Failure to Start	Partial	Service water pumps fail to start due to circuit breaker failures. Pump breakers failed to close due to failures of the charging spring/motor and closing spring motor.
59	Driver	Operational/ Human Error	Demand	Breaker	Maintenance	ESW	1993	Failure to Start	Partial	Operations personnel were attempting to swap the running service water pump with the idle service water pump. Personnel placed the control switch to start and the service water pump did not start. Breaker malfunction. Later, another service water pump failed to start because of the breaker.
60	Driver	Operational/ Human Error	Demand	Breaker	Maintenance	ESW	1988	Failure to Run	Partial	Service water pump high dropout over current protection devices were less than running current conditions and trip setpoints did not account for changing load conditions due to modified impellers. Three pump trips had occurred.
61	Driver	Operational/ Human Error	Demand	Breaker	Maintenance	ESW	1987	Failure to Start	Partial	One breaker failed to linkage alignment and second from loose relay connections. Inadequate maintenance.
62	Driver	Operational/ Human Error	Demand	I&C	Operational	AFW	1983	Failure to Start	Complete	An operator incorrectly secured the diesel and steam driven AFW pumps, which prevented their restart on low SG level.
63	Driver	Operational/ Human Error	Demand	I&C	Operational	ESW	1981	Failure to Start	Partial	Alarm circuit breaker was de-energized resulting in a loss of two RHR service water pumps.
64	Driver	Operational/ Human Error	Demand	I&C	Design	ESW	1980	Failure to Start	Partial	Instrument isolation valve closed causing a low suction trip signal to two RHRSW pumps.
65	Driver	Operational/ Human Error	Inspection	Bearing	Maintenance	RHR-P	1988	Failure to Run	Partial	Residual heat removal pump motor upper bearing housings were observed to be leaking oil. The cause of the failure was attributed to a lack of sealant being applied and gasket installed after the last maintenance was performed on the motor bearing housing.
66	Driver	Operational/ Human Error	Inspection	Breaker	Operational	HPI	1982	Failure to Start	Complete	During the draining of the reactor coolant system, both centrifugal charging pumps were rendered inoperable. The initial conditions in the draining procedure contained a confusing statement, which led to an erroneous assumption that both CCP breakers had to be racked out and tagged.
67	Driver	Operational/ Human Error	Inspection	Breaker	Design	ESW	1984	Failure to Start	Partial	During an attempt to perform preventive maintenance for unit one's RHR service water pumps, plant personnel mistakenly disconnected the motor leads for unit two's RHR service water pump.
68	Driver	Operational/ Human Error	Inspection	Breaker	Quality	ESW	1992	Failure to Start	Partial	The fit between an ESW pump breaker primary disconnects and the associated breaker cubicle stabs was inadequate. The poor fit between the disconnects and the stabs led to arcing in the breaker cubicle when the pump was started, resulting in a fire. Shortly after identifying the cause of the fire, the remaining ESW breakers, which had recently been replaced along with the failed breaker, as part of a design modification package, were found to be inadequate also.

Item	Segment	Proximate Cause	Discovery Method	Piece Part	Coupling Factor	System	Year	Failure Mode	Degree of Failure	Description
69	Driver	Operational/ Human Error	Inspection	Breaker	Operational	CSS	1991	Failure to Start	Complete	CSR control power de-energized prior to mode change. Technical Specification violation. Inadequate procedure review.
70	Driver	Operational/ Human Error	Inspection	Breaker	Operational	ESW	1981	Failure to Start	Almost Complete	Control breakers for two ESW pumps were open due to inadvertent operator action.
71	Driver	Operational/ Human Error	Inspection	Breaker	Maintenance	RHR-P	1981	Failure to Start	Complete	All RHR pumps de-energized to replace RHR Relief valve. T.S. allows this condition for 1 hour. Operated in the mode in excess of 5 hours.
72	Driver	Operational/ Human Error	Inspection	Breaker	Operational	HPI	1988	Failure to Start	Complete	HPI pumps not restored before mode change due to procedural inadequacy.
73	Driver	Operational/ Human Error	Inspection	Breaker	Operational	HPI	1990	Failure to Start	Complete	By opening incorrect breaker, HPI pump tripped while others were unavailable.
74	Driver	Operational/ Human Error	Inspection	Breaker	Operational	HPI	1989	Failure to Start	Partial	HPI Pump B not retested, then HPI Pump A removed from service.
75	Driver	Operational/ Human Error	Inspection	I&C	Maintenance	RHR-P	1992	Failure to Start	Complete	Both trains of RHR were rendered inoperable for two minutes, while performing an operational readiness test surveillance procedure. The surveillance procedure required that the one RHR train pump be placed in pull to lock and the other train heat exchanger flow control valve throttled to 30-40% open. The procedure directed the operators to perform operations that resulted in both trains of RHR being inoperable
76	Driver	Operational/ Human Error	Inspection	I&C	Operational	HPI	1988	Failure to Start	Complete	With alternate CCP pump out-of-service, the remaining operable pump was erroneously placed in pull-to-lock.
77	Driver	Operational/ Human Error	Inspection	I&C	Operational	HPI	1992	Failure to Start	Almost Complete	Two charging pumps and one charging pump service water pump were removed from service simultaneously which is a condition not allowed by technical specifications.
78	Driver	Operational/ Human Error	Inspection	I&C	Operational	RHR-P	1995	Failure to Start	Complete	The switches for the containment spray and recirculation pumps were in a trip pullout when the Technical Specifications and plant procedures required the pumps to be operable.
79	Driver	Operational/ Human Error	Inspection	I&C	Operational	HPI	1990	Failure to Start	Partial	Both safety injection pumps were in the pull-to-lock position. With the switches in pull-to-lock, the pumps would not have automatically started upon receipt of an initiating signal. This event was caused by cognitive personnel error by a utility licensed operator in failure to follow an approved procedure.
80	Driver	Operational/ Human Error	Inspection	I&C	Maintenance	AFW	1990	Failure to Start	Complete	During testing one AFW pump was tested and other was tested without returning first to auto. Both pumps were unavailable at the same time. The procedure was the cause.
81	Driver	Operational/ Human Error	Maintenance	Breaker	Maintenance	RHR-B	1991	Failure to Start	Partial	While performing preventive maintenance calibration check on the protective relays for a residual heat removal pump motor 4kv breaker, it was found that all overcurrent relays for two pumps were out of calibration
82	Driver	Operational/ Human Error	Maintenance	Breaker	Maintenance	RHR-B	1990	Failure to Start	Partial	RHR pump breaker overcurrent trips out of calibration.
83	Driver	Operational/ Human Error	Test	Breaker	Design	AFW	1985	Failure to Start	Complete	Both AFW pumps failed to start when tested, due to the circuit breakers not being racked in properly.
84	Driver	Operational/ Human Error	Test	I&C	Maintenance	ESW	1989	Failure to Start	Partial	Emergency equipment service water pump relays were not reset following a load shedding test 30 hours before.
85	Driver	Operational/ Human Error	Test	I&C	Quality	ESW	1982	Failure to Start	Partial	Two ESW pumps failed to start. One ESW pump failed to function as a result of loose wires on relay terminals in both pump logic schemes, a loose states link and an instantaneous contact found out of adjustment on the other pump logic scheme.

Item	Segment	Proximate Cause	Discovery Method	Piece Part	Coupling Factor	System	Year	Failure Mode	Degree of Failure	Description
86	Driver	Operational/ Human Error	Test	L&C	Operational	ESW	1990	Failure to Start	Complete	An emergency service water pump failed to start and was declared inoperable. Further investigation determined that the failure of the pump to start was due to a tripped emergency engine shutdown device. Operations personnel performing the testing did not recognize the need to reset it prior to starting the pump. Examination of the other two ESW pumps revealed that their emergency shutdown devices were also in the tripped condition.
87	Driver	Operational/ Human Error	Test	Motor	Maintenance	ESW	1994	Failure to Run	Partial	Leak test of the containment cooling service water pump vault watertight door revealed excessive leakage. Flooding and leakage past this door would make inoperable two of four containment cooling service water pumps. Procedural inadequacy was cited as the cause for the degraded door seals.
88	Driver	Other	Demand	Breaker	Maintenance	RHR-P	1987	Failure to Start	Complete	Two LPI pumps, when given a start signal, would not start. An ongoing investigation revealed the probable root cause of the event to be poor electrical contact of the breaker auxiliary stabs for the pumps.
89	Driver	Other	Demand	L&C	Maintenance	ESW	1982	Failure to Start	Complete	Following a reactor scram, an attempt to initiate suppression pool cooling revealed that both RHRSW loops were inoperable as neither loop's pumps could be started. Low suction header pressure lockout signals in each loop prevented starting each loop's pumps. Plugging of the sensing line to each loop's suction header pressure switch prevented both switches from sensing actual pressure, although a lack of operating fluid in one switch and an open power supply breaker to the other switch also would have prevented pumps from starting.
90	Driver	Other	Demand	L&C	Design	ESW	1981	Failure to Start	Partial	Attempt was made to place the a RHRSW subsystem into service for use in suppression pool cooling, the subsystems' pumps could not be started due to a pump suction header low pressure lockout signal from the header pressure switch. The threaded plug in the switch diaphragm housing became loose and allowed the diaphragm fluid to leak out and caused the switch to sense a low pressure. This is a second event two months later.
91	Driver	Other	Demand	L&C	Design	ESW	1981	Failure to Start	Partial	Attempt was made to place the a RHRSW subsystem into service for use in suppression pool cooling, the subsystems' pumps could not be started due to a pump suction header low pressure lockout signal from the header pressure switch. The threaded plug in the switch diaphragm housing became loose and allowed the diaphragm fluid to leak out and caused the switch to sense a low pressure.
92	Driver	Other	Demand	Piping	Design	HCI	1999	Failure to Start	Complete	Water entered the HCI and RCI steam supply lines, rendering both pumps inoperable. Failed reactor vessel instrumentation allowed water to overflow and fill the HCI/RCI steam lines. Pumps were unavailable.
93	Driver	Other	Inspection	L&C	Design	AFW	1983	Failure to Start	Partial	Both AFW pumps had to be rendered inoperable to allow repairs to actuation circuitry.
94	Driver	Other	Inspection	Motor	Environmental	ESW	1981	Failure to Run	Partial	The float guide failed in a RHRSW pump air valve and caused the valve to fail open and flood pump room.
95	Driver	Other	Inspection	Motor	Environmental	AFW	1990	Failure to Start	Partial	Both motor driven AFW pumps were sprayed when a service water pipe developed a through wall leak.
96	Driver	Other	Maintenance	Breaker	Maintenance	ESW	1984	Failure to Start	Partial	ESW pump breaker failures, broken screw, no lubrication, and a bent track
97	Driver	Other	Maintenance	Breaker	Maintenance	ESW	1982	Failure to Start	Partial	ESW pump circuit breakers found damaged. Defective arc chute and cracked secondary coupler.

Item	Segment	Proximate Cause	Discovery Method	Piece Part	Coupling Factor	System	Year	Failure Mode	Degree of Failure	Description
98	Driver	Other	Test	Breaker	Design	SLC	1986	Failure to Start	Complete	During a test, both Squib Valve Detonators shorted after firing and the Control Power Transformer fuse blew causing the pump motor trip. This was caused by improper fuse coordination between the Control Power Transformer fuse and the Squib Valve Detonator fuses. The redundant system's Squib Valve was also fired during this test, without running the associated pump, and one of the Squib Valve Detonators shorted after firing. The same fuse coordination problem existed for both systems.
99	Driver	Other	Test	Breaker	Maintenance	ESW	1984	Failure to Start	Partial	ESW pump breaker overcurrent trip devices tripping too low.
100	Driver	Other	Test	Breaker	Maintenance	ESW	1984	Failure to Start	Partial	ESW pump breakers tripped due to failed voltage control devices.
101	Driver	Other	Test	I&C	Design	RHR-B	1982	Failure to Start	Partial	A functional test revealed a sliding link in control room panel open. Further investigation revealed a total of four links open. These links, left open, negated all autostart capability of 2 of 4 RHR pumps. It could not be determined why these four links were open.
102	Driver	Other	Test	I&C	Design	ESW	1992	Failure to Start	Partial	Valve position contacts prevented ESW pump circuit breakers from closing. Poor design resulted in water intrusion in the valve limit switch box.
103	Pump	Design/ Construction/ Manufacture/ Installation Inadequacy	Demand	Impeller/Wear Rings	Environmental	ESW	2000	Failure to Start	Almost Complete	Two of the River Water pumps tripped on overcurrent when they were attempted to be started. The trips were a result of physical contact between the impeller and the lower casing liner of the pumps. This condition was due to differential thermal expansion between the pump shaft and the pump casing as a result of an elevated seal injection water temperature. The elevated temperature was due to an abnormal configuration of the Filtered Water System (the backup seal water supply).
104	Pump	Design/ Construction/ Manufacture/ Installation Inadequacy	Demand	Impeller/Wear Rings	Design	ESW	1981	Failure to Run	Complete	Both charging pump service water pumps failed. A carbon cap screw failed allowing the impeller of one pump to bind on the casing. The ensuing leakage shorted the motor windings of the other pump.
105	Pump	Design/ Construction/ Manufacture/ Installation Inadequacy	Demand	Impeller/Wear Rings	Quality	ESW	1988	Failure to Run	Partial	ESW pumps drawing excessive current. Carbon steel snap rings corroded allowing impeller to come in contact with casing. The third pump, although not exhibiting abnormal current, had similar corrosion
106	Pump	Design/ Construction/ Manufacture/ Installation Inadequacy	Demand	Impeller/Wear Rings	Design	ESW	1996	Failure to Run	Partial	A Nuclear Service Water pump tripped on overcurrent after operating for approximately 20 minutes. Initial troubleshooting indicated that the pump was binding and disassembly was required to determine the cause. It was determined that the pump impeller thrust ring had become loose due to thrust ring retainer bolt failure, which allowed the impeller to slip on the shaft and resulted in pump binding and the overcurrent condition. The bolts failed due to corrosion. Similar bolt degradation was discovered on other service water pumps. The investigation results indicate the primary cause of the bolt failures was corrosion induced by galvanic coupling of the retainer bolting and other pump components.

Item	Segment	Proximate Cause	Discovery Method	Piece Part	Coupling Factor	System	Year	Failure Mode	Degree of Failure	Description
107	Pump	Design/ Construction/ Manufacture/ Installation Inadequacy	Demand	Impeller/Wear Rings	Quality	ESW	1996	Failure to Run	Partial	A Nuclear Service Water pump tripped on overcurrent after operating for approximately 20 minutes. Initial troubleshooting indicated that the pump was binding and disassembly was required to determine the cause. It was determined that the pump impeller thrust ring had become loose due to thrust ring retainer bolt failure, which allowed the impeller to slip on the shaft and resulted in pump binding and the overcurrent condition. The bolts failed due to corrosion. Similar bolt degradation was discovered on other service water pumps. The investigation results indicate the primary cause of the bolt failures was corrosion induced by galvanic coupling of the retainer bolting and other pump components.
108	Pump	Design/ Construction/ Manufacture/ Installation Inadequacy	Demand	Impeller/Wear Rings	Design	ESW	1986	Failure to Run	Partial	All four emergency service water pumps showed cavitation damage. Two of the pumps had minor damage and were placed back in service. Recirculation cavitation occurs at flows significantly less than design.
109	Pump	Design/ Construction/ Manufacture/ Installation Inadequacy	Inspection	Casing	Quality	HPI	1987	Failure to Run	Partial	During inspection of a centrifugal charging pump, a portion of the stainless steel cladding on the inside surface of the pump casing exhibited corrosion. Corrosion of the pump casing was through the stainless steel cladding into the carbon steel base material. Inspection of the other CCP revealed similar corrosion. The cause of this event was a manufacturing deficiency. Corrosion observed at the pump casing discharge nozzle was attributed to a cladding breakthrough during final machining. Corrosion observed at the pump casing inlet end was attributed to either over-machining of the cladding or inadequate overlay of two adjacent weld beads.
110	Pump	Design/ Construction/ Manufacture/ Installation Inadequacy	Inspection	Casing	Quality	AFW	1983	Failure to Run	Partial	Two AFW pumps thrust tolerance was out of specification. These events were caused by improperly installed balancing drum parts. One turbine driven and one motor driven pump was involved.
111	Pump	Design/ Construction/ Manufacture/ Installation Inadequacy	Inspection	Lubrication	Environmental	HPI	1995	Failure to Run	Partial	High lube oil temperatures were observed during HPI pump operation. Zinc particles from anode were discovered plugging the lube oil coolers. Accelerated corrosion was attributed to a corrosion inhibitor that was added to the system, which chemically interacted with the zinc.
112	Pump	Design/ Construction/ Manufacture/ Installation Inadequacy	Inspection	Packing/Seals	Maintenance	ESW	1997	Failure to Run	Partial	Both ESW pumps leaking greater than 4 gpm because of inappropriate material for packing and sleeve (nitronic 60).
113	Pump	Design/ Construction/ Manufacture/ Installation Inadequacy	Test	Casing	Maintenance	ESW	1997	Failure to Run	Almost Complete	Both ESW pumps failed due to installation of wrong material for pump casing flanges by vendor during pump overhaul. The vendor overhauled the pumps without changing material. The plant returned the pumps to the warehouse also without verifying material.

Item	Segment	Proximate Cause	Discovery Method	Piece Part	Coupling Factor	System	Year	Failure Mode	Degree of Failure	Description
114	Pump	Design/ Construction/ Manufacture/ Installation Inadequacy	Test	Coupling	Environmental	ESW	1987	Failure to Start	Partial	Test showed two ESW pumps failed. Pump shafts were corroded and found to be made of incorrect material.
115	Pump	Design/ Construction/ Manufacture/ Installation Inadequacy	Test	Coupling	Design	ESW	1994	Failure to Start	Partial	Pump produced no flow when started. A shaft coupling failed. Material was determined to be brittle and have low impact properties. The coupling was replaced on all pumps with a type of material more suitable for this application.
116	Pump	Design/ Construction/ Manufacture/ Installation Inadequacy	Test	Impeller/Wear Rings	Maintenance	ESW	1988	Failure to Start	Partial	Essential service water pumps were declared inoperable, due to low pump head valves. The low pump heads were caused by excessive wear of pump impeller due to foreign material in the service water.
117	Pump	Design/ Construction/ Manufacture/ Installation Inadequacy	Test	Impeller/Wear Rings	Quality	ESW	1986	Failure to Start	Partial	Testing of the service water system disclosed that the performance of the three service water pumps was below requirements. The condition is the result of both an inadequate system design and the installation of replacement impellers, which were not modified by the vendor to improve performance, as were the original impellers.
118	Pump	Design/ Construction/ Manufacture/ Installation Inadequacy	Test	Shaft	Design	AFW	1988	Failure to Run	Almost Complete	An auxiliary feedwater pump failed its performance test. Subsequent inspection of the pump internals revealed significant damage, including a split in the center shaft sleeve. The AFW pumps were susceptible to corrosion cracking of their bushings. A different material was needed for the bushings.
119	Pump	Design/ Construction/ Manufacture/ Installation Inadequacy	Test	Shaft	Design	AFW	1988	Failure to Run	Partial	The AFW pumps were susceptible to corrosion cracking of their bushings. A different material was needed for the bushings.
120	Pump	External Environment	Inspection	Bearing	Design	HPI	1991	Failure to Run	Almost Complete	Charging/safety pumps beyond operational limits. Damage was found to the thrust bearings. Air was introduced into this train of chilled water during modifications and testing being performed on the system. This air became trapped in high points of either, or both of, the supply and return chilled water lines to the charging pump. At the reduced flow rate, sufficient cooling was not available and oil temperature increased to the point where bearing damage occurred.
121	Pump	External Environment	Inspection	Coupling	Environmental	ESW	1993	Failure to Run	Partial	Entrained debris caused ESW pump shaft coupling to fail. Plant equipment did not prevent this debris from entering pump.
122	Pump	External Environment	Inspection	Packing/Seals	Environmental	RHR-P	1985	Failure to Start	Complete	Following a trip, water was found spraying from both low head safety injection pump wedge control rod seals. Both pumps were declared inoperable. Postulated failure on the seals was from a minor flow induced pressure transient.
123	Pump	Internal to Component	Demand	Bearing	Maintenance	AFW	1984	Failure to Run	Partial	One ESW bearing failed and pump seized; second motor bearing failed.

Item	Segment	Proximate Cause	Discovery Method	Piece Part	Coupling Factor	System	Year	Failure Mode	Degree of Failure	Description
124	Pump	Internal to Component	Demand	Casing	Maintenance	ESW	1998	Failure to Start	Partial	Two ESW pump started and ran, but would not develop sufficient pressure or flow rate. Exact cause not known for either failure, however, one pump was noted to have microbiological induced corrosion fouling on internal surfaces.
125	Pump	Internal to Component	Demand	Impeller/Wear Rings	Environmental	ESW	1994	Failure to Run	Partial	Raw water pump currents stayed high after starting. The primary cause of these events was determined to be elevated sand content in the river, resulting in excessive sand accumulation around the suction area of the pumps.
126	Pump	Internal to Component	Demand	Impeller/Wear Rings	Quality	AFW	1988	Failure to Run	Partial	Following a plant trip, it was discovered that the auxiliary feedwater pumps had internal damage. Some channel ring vanes had chips missing, and several parts were found in the SG auxiliary feedwater piping.
127	Pump	Internal to Component	Demand	Packing/Seals	Maintenance	AFW	1998	Failure to Run	Partial	AFW MDP and TDPs failed due to incorrect packing installed.
128	Pump	Internal to Component	Inspection	Bearing	Maintenance	SLC	1989	Failure to Run	Partial	Standby Liquid Control pumps lost oil while running. Loose fittings and lack of thread sealant.
129	Pump	Internal to Component	Inspection	Bearing	Maintenance	ESW	1987	Failure to Run	Partial	Service water pumps had high shaft vibration. The excessive vibrations caused by worn bearings and shaft sleeves.
130	Pump	Internal to Component	Inspection	Casing	Maintenance	ESW	1988	Failure to Run	Partial	RHR service water pumps. Pump diffuser eroded on first pump and a through wall casing leak developed on the second.
131	Pump	Internal to Component	Inspection	Casing	Maintenance	ESW	1986	Failure to Run	Partial	Cracked seal water and vent lines.
132	Pump	Internal to Component	Inspection	Impeller/Wear Rings	Environmental	ESW	1990	Failure to Start	Partial	ESW pumps had reduced flow and discharge pressure. Marine growth in suction.
133	Pump	Internal to Component	Inspection	Impeller/Wear Rings	Maintenance	ESW	1985	Failure to Run	Partial	Service water pumps were noted to have high vibrations and low discharge pressure. The cause of the failure is suspected to be binding.
134	Pump	Internal to Component	Inspection	Lubrication	Environmental	HPI	1983	Failure to Run	Partial	Oysters and miscellaneous mollusks plugged HPI oil coolers. Two pumps were required to be shutdown due to rising lubricating oil temperatures.
135	Pump	Internal to Component	Inspection	Lubrication	Design	HPI	1981	Failure to Run	Partial	Corrosion of HPI pump cooler heads. Improper material led to corrosion
136	Pump	Internal to Component	Inspection	Lubrication	Maintenance	RHR-B	1990	Failure to Run	Partial	Both pump motor oil coolers were leaking due to aging of components. The first case involved through wall corrosion and the pump was immediately removed from service. The second case was a packing leak.
137	Pump	Internal to Component	Inspection	Packing	Maintenance	AFW	1986	Failure to Run	Partial	The packing was worn on both the motor-driven and one turbine-driven aux. feedwater pump, causing high temperature on one packing gland, and excessive leaking on the other pump.
138	Pump	Internal to Component	Inspection	Packing/Seals	Maintenance	SLC	1989	Failure to Run	Partial	Standby Liquid Control pumps were observed to be leaking profusely at the packing. The failure of the packing was attributed to normal wear.
139	Pump	Internal to Component	Inspection	Packing/Seals	Maintenance	SLC	1987	Failure to Run	Partial	Standby Liquid Control pumps were observed to be leaking excessively at the packing. The failure of the packing was attributed to normal wear. Packing adjusted.
140	Pump	Internal to Component	Inspection	Packing/Seals	Maintenance	AFW	1990	Failure to Run	Partial	Both motor-driven aux. feedwater pumps had excessive packing leaks, due to worn packing.
141	Pump	Internal to Component	Inspection	Packing/Seals	Environmental	ESW	1994	Failure to Run	Partial	Backup seal water regulators did not provide required flow during testing on two pumps. The third pump lost seal flow while operating. The cause was attributed to plugged lines.

Item	Segment	Proximate Cause	Discovery Method	Piece Part	Coupling Factor	System	Year	Failure Mode	Degree of Failure	Description
142	Pump	Internal to Component	Inspection	Packing/Seals	Maintenance	ESW	1986	Failure to Run	Partial	Excessive packing leakage. Both events occurred after previous maintenance had been performed for the same problems.
143	Pump	Internal to Component	Inspection	Packing/Seals	Maintenance	ESW	1989	Failure to Run	Partial	ESW pump excessive packing leakage.
144	Pump	Internal to Component	Inspection	Packing/Seals	Maintenance	SLC	1988	Failure to Run	Partial	Standby Liquid Control pumps were observed to be leaking excessively at the packing. The failure of the packing was attributed to normal wear. Packing replaced.
145	Pump	Internal to Component	Inspection	Plunger/Cylinder	Maintenance	SLC	1989	Failure to Run	Partial	Standby Liquid Control pump seal was leaking excessively. The cause of this failure was normal wear of the plungers, packing, and head gaskets for the plungers (piece parts of the pump).
146	Pump	Internal to Component	Maintenance	Bearing	Maintenance	ESW	1985	Failure to Run	Partial	High ESW pump vibration was caused by wearing of the upper bearings.
147	Pump	Internal to Component	Maintenance	Lubrication	Environmental	HPI	1991	Failure to Run	Partial	HPI pump lube oil cooler leaks. Degraded tubes.
148	Pump	Internal to Component	Maintenance	Lubrication	Environmental	HPI	1986	Failure to Run	Almost Complete	Clams/sludge fouling of lube oil cooler caused high temperature alarms on two HPI pumps.
149	Pump	Internal to Component	Maintenance	Lubrication	Environmental	HPI	1980	Failure to Run	Partial	HPI pump lube oil cooler with tube leak allowed water into oil reservoir.
150	Pump	Internal to Component	Maintenance	Packing/Seals	Environmental	ESW	1985	Failure to Run	Partial	First pump developed seal leak due to sand. Second pump had high bearing temperatures due to trash clogging cooling water lines.
151	Pump	Internal to Component	Test	Bearing	Environmental	ESW	1992	Failure to Run	Partial	Abrasive particles present in ocean water produced accelerated wear of shaft bearing journals.
152	Pump	Internal to Component	Test	Bearing	Maintenance	ESW	1985	Failure to Run	Partial	ESW pumps had reduced flow and discharge pressure. Worn impellers/wearing rings.
153	Pump	Internal to Component	Test	Coupling	Maintenance	ESW	1987	Failure to Start	Almost Complete	Two ESW pumps had failed couplings. Cause attributed to abnormal stress.
154	Pump	Internal to Component	Test	Coupling	Maintenance	ESW	1990	Failure to Start	Partial	ESW pumps had reduced flow and discharge pressure. Worn impellers/wearing rings. Cause determined to be normal wear and high sand content of river water.
155	Pump	Internal to Component	Test	Impeller/Wear Rings	Maintenance	ESW	1992	Failure to Start	Partial	ESW pumps had reduced flow and discharge pressure. Worn impellers/wearing rings.
156	Pump	Internal to Component	Test	Impeller/Wear Rings	Maintenance	ESW	1991	Failure to Start	Partial	ESW pumps had reduced flow and discharge pressure. Worn impellers/wearing rings.
157	Pump	Internal to Component	Test	Impeller/Wear Rings	Maintenance	ESW	1986	Failure to Run	Partial	ESW pumps had worn impellers and one had a plugged strainer.
158	Pump	Internal to Component	Test	Impeller/Wear Rings	Maintenance	ESW	1985	Failure to Run	Partial	The charging pump service water pumps degraded. Caused by expected wear of pump due to erosion and corrosion properties of the process fluid involved
159	Pump	Internal to Component	Test	Impeller/Wear Rings	Maintenance	ESW	1985	Failure to Start	Partial	Emergency service water pumps discharge pressure below allowable limits. Causes were loose impellers, dropped impeller, and worn internals.
160	Pump	Internal to Component	Test	Impeller/Wear Rings	Maintenance	ESW	1984	Failure to Run	Partial	Containment spray raw water pumps failed flow tests. Aging and normal wear.
161	Pump	Internal to Component	Test	Impeller/Wear Rings	Maintenance	ESW	1990	Failure to Run	Partial	ESW pumps had worn and cracked impellers. Aging and normal wear.

Item	Segment	Proximate Cause	Discovery Method	Piece Part	Coupling Factor	System	Year	Failure Mode	Degree of Failure	Description
162	Pump	Internal to Component	Test	Impeller/Wear Rings	Maintenance	ESW	1987	Failure to Run	Partial	ESW pump low flow. Worn impellers.
163	Pump	Internal to Component	Test	Impeller/Wear Rings	Maintenance	ESW	1988	Failure to Run	Partial	ESW pumps failed to meet the minimum flow requirements of test. The cause of the failure is normal wearout of the pump impeller due to brackish water corrosion.
164	Pump	Internal to Component	Test	Impeller/Wear Rings	Maintenance	ESW	1990	Failure to Start	Partial	ESW impeller gaps too wide. Gaps adjusted.
165	Pump	Internal to Component	Test	Impeller/Wear Rings	Maintenance	ESW	1994	Failure to Run	Partial	Two ESW pumps had internal deterioration, one of which was indicated by high vibration readings.
166	Pump	Internal to Component	Test	Impeller/Wear Rings	Maintenance	ESW	1992	Failure to Start	Partial	ESW pumps had reduced flow and discharge pressure. Worn impellers/wearing rings. One pump also exhibited high vibration.
167	Pump	Internal to Component	Test	Impeller/Wear Rings	Environmental	ESW	1991	Failure to Run	Partial	ESW pumps failed to meet the minimum flow requirements of test. The cause of the failure is normal wearout of the pump impeller due to the high sand content of the water being pumped. Pump impeller lift was adjusted.
168	Pump	Internal to Component	Test	Impeller/Wear Rings	Environmental	ESW	1982	Failure to Start	Partial	Essential service water pumps were declared inoperable, due to low pump head valves. The low pump heads were caused by excessive wear of pump impeller due to foreign material in the service water.
169	Pump	Internal to Component	Test	Impeller/Wear Rings	Maintenance	ESW	1984	Failure to Run	Partial	Loss of Service Water pump due to wearout at end of life.
170	Pump	Internal to Component	Test	Impeller/Wear Rings	Maintenance	ESW	1986	Failure to Run	Partial	ESW pump performance decreased 15% and 8% respectively since last test. Pumps were replaced.
171	Pump	Internal to Component	Test	Impeller/Wear Rings	Maintenance	ESW	1985	Failure to Run	Partial	Wear caused high ESW pump bearing temperatures, vibration, and low amperage/flow.
172	Pump	Internal to Component	Test	Impeller/Wear Rings	Maintenance	ESW	1981	Failure to Start	Partial	Loss of Service Water pump due to wearout at end of life.
173	Pump	Internal to Component	Test	Impeller/Wear Rings	Maintenance	ESW	1990	Failure to Start	Partial	ESW pumps had reduced flow and discharge pressure. Worn impellers/wearing rings.
174	Pump	Internal to Component	Test	Impeller/Wear Rings	Environmental	ESW	1990	Failure to Run	Partial	ESW pump impeller lift out of adjustment.
175	Pump	Internal to Component	Test	Impeller/Wear Rings	Maintenance	ESW	1985	Failure to Start	Partial	ESW pumps had reduced flow and discharge pressure. Worn impellers/wearing rings.
176	Pump	Internal to Component	Test	Impeller/Wear Rings	Maintenance	ESW	1998	Failure to Start	Partial	Two ESW pumps failed to develop adequate flow/pressure - pumps degraded.
177	Pump	Internal to Component	Test	Impeller/Wear Rings	Environmental	HPI	1984	Failure to Run	Almost Complete	One HPI pump seized, the second would have seized if operated.
178	Pump	Internal to Component	Test	Impeller/Wear Rings	Environmental	ESW	1993	Failure to Run	Partial	Essential service water pumps were declared inoperable, due to low pump head valves. The low pump heads were caused by excessive wear of pump impeller due to sand in the service water.
179	Pump	Internal to Component	Test	Impeller/Wear Rings	Maintenance	ESW	1985	Failure to Start	Partial	ESW pumps failed to meet the minimum flow requirements of test. The cause of the failure is normal wearout of the pump impeller due to the high sand content of the water being pumped. Pump impeller lift was adjusted.
180	Pump	Internal to Component	Test	Impeller/Wear Rings	Maintenance	ESW	1982	Failure to Run	Partial	Loss of Service Water pump due to wearout at end of life.

Item	Segment	Proximate Cause	Discovery Method	Piece Part	Coupling Factor	System	Year	Failure Mode	Degree of Failure	Description
181	Pump	Internal to Component	Test	Impeller/Wear Rings	Maintenance	ESW	1988	Failure to Start	Partial	Service water pumps were noted to have high vibrations and low discharge pressure. Uneven wear caused pump to be out of balance.
182	Pump	Internal to Component	Test	Impeller/Wear Rings	Maintenance	ESW	1988	Failure to Start	Partial	ESW pumps had reduced flow and discharge pressure. Worn impellers/wearing rings.
183	Pump	Internal to Component	Test	Impeller/Wear Rings	Maintenance	HPI	1983	Failure to Start	Partial	SI pump and both CCPs failed to meet the minimum head curve requirements. The cause of pump head capacity degradation has been attributed to normal pump operation. The inability to balance flows has been attributed to the lower head capacity of the pumps.
184	Pump	Internal to Component	Test	Impeller/Wear Rings	Maintenance	RHR-B	1985	Failure to Start	Partial	The first pump failed to meet required flow rate. The second was drawing excessive amperage. Both conditions were attributed to worn internals.
185	Pump	Internal to Component	Test	Impeller/Wear Rings	Environmental	ESW	1995	Failure to Start	Partial	Pumps failed performance test. Sand in water eroded pump internals. Pump lift was adjusted.
186	Pump	Internal to Component	Test	Impeller/Wear Rings	Maintenance	ESW	1983	Failure to Run	Partial	RHR Service Water pumps failed flow tests due to wearout and had to be rebuilt.
187	Pump	Internal to Component	Test	Impeller/Wear Rings	Environmental	ESW	1994	Failure to Start	Partial	Degraded performance identified during testing. Sand in water was causing accelerated wear of the pump internals. Lift was adjusted for three pumps and one pump internals were replaced.
188	Pump	Internal to Component	Test	Impeller/Wear Rings	Maintenance	ESW	1989	Failure to Start	Partial	ESW pumps had reduced flow and discharge pressure. Worn impellers/wearing rings.
189	Pump	Internal to Component	Test	Impeller/Wear Rings	Maintenance	ESW	1994	Failure to Start	Partial	Two ESW pumps had low discharge pressure during testing. Each pump had worn internals and both pump internals were replaced.
190	Pump	Internal to Component	Test	Impeller/Wear Rings	Maintenance	HPI	1985	Failure to Start	Partial	The CCPs were tested and had low flow rates. The most probable cause is attributed to observed degradation of the pumps. The CCPs are subject to normal wear associated with their secondary duty of providing normal charging flow.
191	Pump	Internal to Component	Test	Impeller/Wear Rings	Environmental	ESW	1985	Failure to Run	Partial	ESW pumps failed to meet the minimum flow requirements of test. A rag was found in one impeller and a plastic bottle in the other.
192	Pump	Internal to Component	Test	Impeller/Wear Rings	Maintenance	ESW	1985	Failure to Run	Partial	ESW pumps failed due to worn internals.
193	Pump	Internal to Component	Test	Impeller/Wear Rings	Environmental	ESW	1982	Failure to Run	Partial	Low ESW pump head values were caused excessive wear of pump impeller due to foreign material in the service water.
194	Pump	Internal to Component	Test	Impeller/Wear Rings	Maintenance	ESW	1988	Failure to Start	Partial	Essential service water pumps were declared inoperable, due to low pump head valves. The low pump heads were caused by wear and aging of internals.
195	Pump	Internal to Component	Test	Impeller/Wear Rings	Maintenance	ESW	1984	Failure to Start	Partial	Essential service water pumps were declared inoperable, due to low pump head valves. The low pump heads were caused by wear and aging of internals.
196	Pump	Internal to Component	Test	Impeller/Wear Rings	Environmental	ESW	1995	Failure to Start	Partial	Marine growth caused low flow and speed condition for two service water pumps
197	Pump	Internal to Component	Test	Impeller/Wear Rings	Environmental	ESW	1992	Failure to Start	Partial	ESW pumps had reduced flow and discharge pressure. Worn impellers/wearing rings. Cause determined to be normal wear and high sand content of river water.
198	Pump	Internal to Component	Test	Lubrication	Maintenance	SLC	1992	Failure to Run	Partial	Standby Liquid Control pumps lost oil while running. The gasket between the crankcase frame cap and the gear housing cover was worn.
199	Pump	Internal to Component	Test	Packing/Seals	Maintenance	ESW	1981	Failure to Start	Partial	RHR service water pumps failed to meet flow requirements due to seal water leakage and pump wearout.

Item	Segment	Proximate Cause	Discovery Method	Piece Part	Coupling Factor	System	Year	Failure Mode	Degree of Failure	Description
200	Pump	Internal to Component	Test	Shaft	Maintenance	ESW	1993	Failure to Run	Partial	Service water pumps were noted to have high vibrations and low discharge pressure. Uneven wear caused pump to be out of balance.
201	Pump	Operational/ Human Error	Demand	Casing	Maintenance	AFW	1983	Failure to Run	Partial	During testing, the outboard bearing temperature was high on the turbine-driven AFW pump, due to improper balance drum clearances, caused by improper maintenance. The procedure will be modified and the balance drum clearance reset. While the unit was starting up, the motor-driven AFW pump outboard bearing temperature was high. Excessive thrust bearing clearance caused the balance drum to unbalance, causing the thrust bearing to overheat.
202	Pump	Operational/ Human Error	Demand	Impeller/Wear Rings	Design	AFW	1990	Failure to Run	Almost Complete	Due to a combination of management error and procedural deficiency, the turbine driven auxiliary feedwater pump was run deadheaded. The operation damaged the pump. When the pump was manually tripped, steam vented back into the suction line, caused another AFW pump to also trip, on a low suction pressure signal.
203	Pump	Operational/ Human Error	Inspection	Lubrication	Operational	HPI	1983	Failure to Start	Complete	A routine preventive maintenance (oil change) was mistakenly performed on the north charging pump instead of the south as scheduled. Since the south pump was previously cleared for this oil change, and the test pump was valved out, none of these three pumps were in service as required by tech specs for the approximately 20 minutes it took to change the oil in the north pump.
204	Pump	Operational/ Human Error	Maintenance	Lubrication	Maintenance	HPI	1991	Failure to Run	Partial	Following an overhaul of the HPI pumps. Too much oil flow led to excessive oil leakage, which would have failed HPI pumps before end of mission.
205	Pump	Operational/ Human Error	Maintenance	Lubrication	Operational	ESW	1993	Failure to Run	Partial	Low pressure RHR bearing oil level not maintained high enough when new smaller sightglass installed. Second event the sightglass was broken when adding oil.
206	Pump	Operational/ Human Error	Test	Casing	Maintenance	RHR-P	1989	Failure to Start	Complete	Both loops of the residual heat removal system were declared inoperable due to gas binding of both RHR pumps. The gas binding was caused by entry of nitrogen gas into the reactor coolant system from accumulator. The root cause of this event has been attributed to personnel error. Personnel did not comply with the specific requirements in the accumulator discharge check valve full flow test procedure due to inattention to detail.
207	Pump	Operational/ Human Error	Test	Packing/Seals	Maintenance	AFW	1996	Failure to Run	Partial	During the performance of Steam-Driven Emergency Feedwater Pump testing, sparks were observed emanating from the outboard mechanical seal area. The sparks appeared to be due to a mechanical interference within the mechanical seal assembly. The pump mechanical seal was disassembled and determined to have been improperly installed during the last refueling outage. The evaluation identified a mechanical seal design deficiency and inadequate corrective action for a previously identified event as the primary causes for this event. A contributing cause for this event was found to be inadequate predictive maintenance techniques. The electric AFW pump exhibited the same problem.
208	Pump	Other	Inspection	Bearing	Operational	ESW	1991	Failure to Run	Partial	Lube oil cooling water isolated during a test. Pumps continued to run with no cooling.
209	Suction	Design/ Construction/ Manufacture/ Installation Inadequacy	Demand	I&C	Maintenance	HPI	1997	Failure to Run	Complete	HPI pumps fail due to operation with inadequate suction head. Two pumps damaged due to operation with inadequate suction, but all three system pumps were unavailable due to the loss of the suction source. Suction source level instrumentation was the cause.

Item	Segment	Proximate Cause	Discovery Method	Piece Part	Coupling Factor	System	Year	Failure Mode	Degree of Failure	Description
210	Suction	Design/ Construction/ Manufacture/ Installation Inadequacy	Demand	Piping	Design	ESW	1996	Failure to Start	Partial	Freezing of diesel generator service water piping in intake bay. Inadequate initial design.
211	Suction	Design/ Construction/ Manufacture/ Installation Inadequacy	Demand	Piping	Design	ESW	1981	Failure to Run	Complete	Increased flow to chillers resulted in loss of NPSH to Charging Water Service Water pumps.
212	Suction	Design/ Construction/ Manufacture/ Installation Inadequacy	Demand	Piping	Design	ESW	1981	Failure to Run	Complete	Increasing flow to chillers robs NPSH from charging service water pumps.
213	Suction	Design/ Construction/ Manufacture/ Installation Inadequacy	Demand	Piping	Design	ESW	1983	Failure to Run	Complete	Increased flow to chillers resulted in loss of NPSH to Charging Water Service Water pumps.
214	Suction	Design/ Construction/ Manufacture/ Installation Inadequacy	Demand	Piping	Design	ESW	1982	Failure to Run	Complete	The use of service water by the chillers can cause a loss of suction pressure to the Charging Water Service Water pumps.
215	Suction	Design/ Construction/ Manufacture/ Installation Inadequacy	Demand	Piping	Design	ESW	1982	Failure to Run	Complete	The use of service water by the chillers can cause a loss of suction pressure to the charging pump service water pumps.
216	Suction	Design/ Construction/ Manufacture/ Installation Inadequacy	Demand	Piping	Design	ESW	1982	Failure to Run	Almost Complete	Increased flow to chillers resulted in loss of NPSH to Charging Water Service Water pumps.
217	Suction	Design/ Construction/ Manufacture/ Installation Inadequacy	Demand	Piping	Design	ESW	1982	Failure to Run	Complete	Increased flow to chillers resulted in loss of NPSH to Charging Water Service Water pumps.
218	Suction	Design/ Construction/ Manufacture/ Installation Inadequacy	Demand	Piping	Design	ESW	1982	Failure to Run	Complete	The use of service water by the chillers can cause a loss of suction pressure to the charging pump service water pumps.

Item	Segment	Proximate Cause	Discovery Method	Piece Part	Coupling Factor	System	Year	Failure Mode	Degree of Failure	Description
219	Suction	Design/ Construction/ Manufacture/ Installation Inadequacy	Demand	Piping	Design	ESW	1983	Failure to Run	Almost Complete	Increased flow to chillers resulted in loss of NPSH to Charging Pump Service Water pumps.
220	Suction	Design/ Construction/ Manufacture/ Installation Inadequacy	Demand	Piping	Quality	ESW	1984	Failure to Start	Partial	Both RHR service water pumps tripped as a result of inadequate venting of suction header resulting from poor orientation of the vent line.
221	Suction	Design/ Construction/ Manufacture/ Installation Inadequacy	Inspection	Piping	Design	HPI	1991	Failure to Start	Partial	Ultrasonic examination of the chemical and volume control system suction piping was performed. These examinations revealed voids in the alternate boration line and the gravity feed line from the boric acid storage tank.
222	Suction	Design/ Construction/ Manufacture/ Installation Inadequacy	Inspection	Piping	Design	HPI	1988	Failure to Run	Partial	Ultrasonic examination of the chemical and volume control system suction piping was performed. These examinations revealed voids in the suction piping.
223	Suction	Design/ Construction/ Manufacture/ Installation Inadequacy	Inspection	Piping	Design	HPI	1988	Failure to Start	Partial	It was determined that various pipes of the safety injection system and chemical volume and control system collected or trapped gas which might affect the functions of these systems. There was a concern that the gas pockets may adversely effect pump operation. Voids were detected in some of the high head SI pump piping.
224	Suction	Design/ Construction/ Manufacture/ Installation Inadequacy	Inspection	Piping	Quality	HPI	1988	Failure to Run	Partial	Vortex breakers had not been installed in the containment emergency sumps. Vortex breakers are required to be installed in the containment emergency sumps to prevent the formation of vortices which could adversely affect performance of safety injection pumps during the safety injection and containment spray systems were declared inoperable.
225	Suction	Design/ Construction/ Manufacture/ Installation Inadequacy	Inspection	Piping	Design	HPI	1990	Failure to Start	Partial	A quantity of gas was found in the centrifugal charging pump suction header that exceeded the maximum allowed gas volume. It was subsequently determined that hydrogen gas had been coming out of solution on both units and accumulating in the suction piping as a probable result of gas stripping by the CCP miniflow orifices. In addition, entrainment of hydrogen bubbles from the volume control tank to the CCP suction pipe may be a contributor as well.
226	Suction	Design/ Construction/ Manufacture/ Installation Inadequacy	Inspection	Strainer	Environmental	ESW	2000	Failure to Run	Partial	RHR SW Pumps Failed to Develop flow/pressure. Debris in intake structure. Requires modifications to the traveling Water Screen.

Item	Segment	Proximate Cause	Discovery Method	Piece Part	Coupling Factor	System	Year	Failure Mode	Degree of Failure	Description
227	Suction	Design/ Construction/ Manufacture/ Installation Inadequacy	Maintenance	Tank	Design	ESW	1985	Failure to Run	Partial	An engineering evaluation revealed that ESW had been inoperable several times due to low NPSH. All three units were affected.
228	Suction	Design/ Construction/ Manufacture/ Installation Inadequacy	Maintenance	Tank	Design	ESW	1985	Failure to Run	Partial	An engineering evaluation revealed that ESW had been inoperable several times due to low NPSH. All three units were affected.
229	Suction	Design/ Construction/ Manufacture/ Installation Inadequacy	Maintenance	Tank	Design	ESW	1990	Failure to Run	Partial	An engineering evaluation revealed that ESW had been inoperable several times due to low NPSH. All three units were affected.
230	Suction	Design/ Construction/ Manufacture/ Installation Inadequacy	Maintenance	Tank	Design	ESW	1990	Failure to Run	Partial	An engineering evaluation revealed that ESW had been inoperable several times due to low NPSH. All three units were affected.
231	Suction	Design/ Construction/ Manufacture/ Installation Inadequacy	Maintenance	Tank	Design	ESW	1985	Failure to Run	Partial	An engineering evaluation revealed that ESW had been inoperable several times due to low NPSH. All three units were affected.
232	Suction	Design/ Construction/ Manufacture/ Installation Inadequacy	Maintenance	Tank	Design	ESW	1990	Failure to Run	Partial	An engineering evaluation revealed that ESW had been inoperable several times due to low NPSH. All three units were affected.
233	Suction	Design/ Construction/ Manufacture/ Installation Inadequacy	Test	Piping	Design	AFW	1999	Failure to Run	Partial	All AFW trains declared inoperable due to inadequate suction flow capability from the nuclear service water alternate source. Inadequate flow caused by corroded piping. Piping is undersized so there is little margin for piping degradation. Since this is 1 of 4 suction sources, the safety significance is limited.
234	Suction	Design/ Construction/ Manufacture/ Installation Inadequacy	Test	Tank	Design	ESW	1986	Failure to Run	Complete	Loss of prime in the condenser circulating water siphon flow system caused loss of low pressure service water pumps. Pumps lost suction during a test due to poor design.
235	Suction	Design/ Construction/ Manufacture/ Installation Inadequacy	Test	Tank	Design	SLC	1991	Failure to Run	Complete	During the performance of a special test on Unit 1 to determine the available NPSH of the SLC pumps, the pumps began to cavitate unexpectedly. The SLC systems of both units were declared inoperable. The causes of this event are inadequate modification testing and an error in the original design calculations.

Item	Segment	Proximate Cause	Discovery Method	Piece Part	Coupling Factor	System	Year	Failure Mode	Degree of Failure	Description
236	Suction	Design/ Construction/ Manufacture/ Installation Inadequacy	Test	Tank	Design	SLC	1991	Failure to Run	Complete	During the performance of a special test on the available NPSH of the SLC pumps, the pumps began to cavitate unexpectedly. The SLC systems of both units were declared inoperable. The causes of this event are inadequate modification testing and an error in the original design calculations.
237	Suction	Design/ Construction/ Manufacture/ Installation Inadequacy	Test	Valve	Design	ESW	1983	Failure to Start	Partial	Low discharge pressure was caused by insufficient suction pressure. Service water flow to parallel components was adjusted.
238	Suction	External Environment	Demand	Piping	Environmental	HPI	1984	Failure to Start	Complete	Boron solidification in the suction and gas binding of pumps led to the failure of all three safety injection pumps. Flushing procedures inadequate.
239	Suction	Internal to Component	Demand	Piping	Environmental	ESW	1986	Failure to Start	Partial	RHR service water pumps failed flow testing due to blocked suction and abnormal wear of impellers.
240	Suction	Internal to Component	Demand	Strainer	Environmental	ESW	1980	Failure to Run	Partial	Foreign material was allowed to enter the suction of the charging pump service water pumps resulting in low flow conditions.
241	Suction	Internal to Component	Inspection	Strainer	Environmental	ESW	1984	Failure to Run	Partial	Two RHR service water pumps had blown seals and sparks and smoke between the bearing housing and shaft. A piece of hard rubber valve liner was found in the pumps.
242	Suction	Internal to Component	Test	Piping	Environmental	ESW	1990	Failure to Start	Partial	ESW pumps failed flow testing. Foreign material blocked the suction.
243	Suction	Internal to Component	Test	Strainer	Environmental	ESW	1990	Failure to Run	Partial	Essential service water pumps were declared inoperable, due to low pump head valves. The low pump heads were caused by suction blockage due to foreign material in the service water.
244	Suction	Internal to Component	Test	Strainer	Environmental	ESW	1982	Failure to Run	Partial	Failures occurred on residual heat removal service water pumps. The pumps failed to meet flow and pressure requirements. Failure was due to debris lodging in pump impellers. Source of debris was maintenance activities, broken traveling water screens, and the inadvertent opening of a RHR minimum flow line which washed materials into suction pit.
245	Suction	Operational/ Human Error	Demand	Booster Pump	Operational	ESW	1980	Failure to Start	Partial	The service water RHR booster pump was de-energized during maintenance. The attempt to start service water pumps failed due to low suction pressure.
246	Suction	Operational/ Human Error	Demand	Piping	Design	RHR-P	1984	Failure to Run	Almost Complete	On two occasions, RHR pumps cavitated due to low RCS level while draining the RCS.
247	Suction	Operational/ Human Error	Demand	Piping	Design	RHR-P	1985	Failure to Run	Complete	Swap over of RHR pumps resulted in both trains becoming inoperable due to air injection into the suction of the pumps. This required both pumps to be vented and required RCS level to be raised to prevent a possible recurrence of the vortex problem.
248	Suction	Operational/ Human Error	Demand	Piping	Operational	RHR-P	1980	Failure to Run	Complete	While attempting to increase RHR flow, the plant experienced a total loss of flow due to the pumps being air-bound. The pump was not vented when starting to increase flow. Operating procedures have been changed to have an operator present while changing flow in the RHR system. There have been losses of RHR flow in the past because the pumps were air-bound and methods are being investigated to improve the system design.

Item	Segment	Proximate Cause	Discovery Method	Piece Part	Coupling Factor	System	Year	Failure Mode	Degree of Failure	Description
249	Suction	Operational/ Human Error	Demand	Piping	Operational	RHR-P	1984	Failure to Run	Complete	The control room operators started a second residual heat removal pump in preparation for removing the operating RHR pump from service. With both pumps running, flow became excessive for the half-loop condition causing cavitation and air binding of both pumps. To prevent recurrence the procedure which controls the operation of the RHR pumps has been changed to include specific instructions to stop the operating pump prior to starting the second pump while at half-loop.
250	Suction	Operational/ Human Error	Demand	Piping	Maintenance	ESW	1996	Failure to Run	Complete	Both trains of both units charging pump service water pumps became air bound. Underwater diving maintenance activities on one units circulating water and service water lines was identified as the source of the air. The air entered the service water supply lines when a valve was opened in preparation for a Safety Injection logic test.
251	Suction	Operational/ Human Error	Demand	Piping	Operational	ESW	1988	Failure to Run	Complete	The procedure failed to adequately caution the operator to slowly fill a drained line. Rapid filling resulted in a loss of NPSH to the charging service water pumps.
252	Suction	Operational/ Human Error	Demand	Piping	Maintenance	ESW	1996	Failure to Run	Complete	Both trains of both units charging pump service water pumps became air bound. Underwater diving maintenance activities on one units circulating water and service water lines was identified as the source of the air. The air entered the service water supply lines when a valve was opened in preparation for a Safety Injection logic test.
253	Suction	Operational/ Human Error	Demand	Piping	Operational	ESW	1986	Failure to Run	Complete	Failure to properly vent and fill a newly installed pipe introduced air into the charging pump service water system.
254	Suction	Operational/ Human Error	Demand	Piping	Design	RHR-P	1980	Failure to Run	Complete	The reactor vessel vent eductor was in service in preparation for refueling with RHR operating. A low flow alarm was received and low flow and low motor current were indicated. A second pump was started and became air-bound. Putting the vessel vent eductor system into service was the root cause of the incident.
255	Suction	Operational/ Human Error	Demand	Piping	Design	RHR-P	1982	Failure to Run	Complete	Suction was lost to both RHR pumps. RHR flow was less than 3000 gpm and pump amps were fluctuating prior to taking corrective action. Each of these events appear to have been caused by a slow decrease in RCS level in conjunction with the vortex action at the pump suction.
256	Suction	Operational/ Human Error	Demand	Tank	Design	AFW	1980	Failure to Run	Complete	Both emergency feedwater pumps lost feed pump suction. The emergency feedwater pump suction flashed to steam due to the feedwater train flashing and forcing hot water back through the startup and blowdown tanks and into the feedwater pump suction. To prevent this recurrence, the operating procedures have been changed to require isolating the startup and blowdown effluent as a source of emergency feedwater suction prior to increasing power.
257	Suction	Operational/ Human Error	Inspection	Valve	Maintenance	SLC	1991	Failure to Start	Partial	SLC pumps were potentially inoperable during part of test due to valve lineup.
258	Suction	Operational/ Human Error	Maintenance	Piping	Maintenance	RHR-P	1982	Failure to Run	Complete	Shutdown cooling was lost due to nitrogen intrusion because of backflushing a filter in the purification system.
259	Suction	Operational/ Human Error	Maintenance	Strainer	Operational	ESW	1986	Failure to Run	Complete	A service water strainer was placed in service without being vented resulting in air binding system and loss of charging pump service water pumps.
260	Suction	Operational/ Human Error	Maintenance	Strainer	Maintenance	HPI	1985	Failure to Run	Partial	Strainers found still installed in the suction piping of the high-pressure injection pumps was a condition not considered in the operating design. The strainers were found during maintenance to repair a slight flange leak. The strainers had been placed in the suction piping during construction and were to be in place during system flushing to prevent any debris from reaching the pumps. However, the strainers should have been removed after system flushing prior to functional testing.

Item	Segment	Proximate Cause	Discovery Method	Piece Part	Coupling Factor	System	Year	Failure Mode	Degree of Failure	Description
261	Suction	Operational/ Human Error	Test	Piping	Operational	ESW	1989	Failure to Run	Partial	Inadequate procedure led to air binding of operating ESW pumps.
262	Suction	Other	Demand	L&C	Design	HPI	1997	Failure to Run	Partial	Letdown storage tank reference leg not full, which gave erroneous indication of sufficient tank level. One HPI pump severely damaged, other pump not as damaged, and could have run. The root cause was a combination of a design weakness of a common reference leg for the Letdown storage tank level instruments and a leaking instrument fitting due to an inadequate work practice.
263	Suction	Other	Demand	Piping	Design	HPI	1982	Failure to Start	Complete	Hydrogen from the suction dampener got into suction piping and failed both CCPs.
264	Suction	Other	Demand	Piping	Maintenance	RHR-P	1986	Failure to Run	Complete	SDC pumps cavitated due to lowering RCS level. Level indication was in error.
265	Suction	Other	Demand	Piping	Design	ESW	1980	Failure to Run	Almost Complete	Air ingress exceeded the air removal capability of the constant vent valves. A design change was implemented to remove the air compressor cooling from the service water system.
266	Suction	Other	Demand	Piping	Maintenance	RHR-P	1983	Failure to Run	Complete	The RHR pumps began to cavitate and eventually both pumps were stopped. The reactor vessel level gauge being used to provide an indication that the level was approaching the vessel flange level had been isolated (reactor coolant drain tank isolation valve had been closed during an attempt to reduce leakage). Additionally, procedures did not require visual monitoring of cavity level.
267	Suction	Other	Demand	Piping	Design	RHR-P	1982	Failure to Run	Complete	RHR Suction lost due to erroneous RCS level while draining the RCS.
268	Suction	Other	Demand	Piping	Design	RHR-P	1982	Failure to Run	Complete	With unit drained to centerline of the nozzles, suction to both RHR pumps was lost for 36 minutes. Suction to the RHR pumps was lost because of ambiguous reactor coolant system level indication while drained to centerline of the nozzles. The actual RCS level was lower than observed.
269	Suction	Other	Demand	Piping	Maintenance	RHR-P	1981	Failure to Run	Complete	Temporary coolant loop level indicator showed level slowly increasing over a period of days. The system was periodically drained to maintain 65 percent indicated level. A RHR pump lost suction on reduction of actual level. The second pump was started, and lost suction. Indication drift was due to evaporation of reference leg.
270	Suction	Other	Demand	Piping	Maintenance	RHR-P	1980	Failure to Run	Complete	A complete loss of RHR flow occurred while plant operators were increasing RHR heat exchanger flow by closing down on the heat exchanger bypass valve.
271	Suction	Other	Demand	Piping	Design	RHR-P	1987	Failure to Run	Complete	RHR flow was interrupted when both RHR trains became inoperable due to air bound RHR pumps. The loss of RCS inventory to the reactor coolant drain tank due to a leaking valve caused a decrease in RCS water level, vortexing in the pumps' suction line, and air entrainment in the RHR pumps.
272	Suction	Other	Demand	Valve	Design	RHR-P	1984	Failure to Run	Complete	Both RHR pumps were unable to operate due to the introduction of air into the RHR system. The incident occurred during the drain down of the RCS, when the level of the RCS was being monitored via a standpipe off the centerline of one of the RCS loops. The isolation valve to which the standpipe was attached became clogged sometime during the drain down and falsely indicated above centerline when in fact the level was below the RHR suction line (below centerline).

Item	Segment	Proximate Cause	Discovery Method	Piece Part	Coupling Factor	System	Year	Failure Mode	Degree of Failure	Description
273	Suction	Other	Test	I&C	Design	AFW	1985	Failure to Run	Almost Complete	Testing of the turbine driven AFW pump resulted in a low suction trip of the motor driven pump. The turbine driven pump had a faulty governor. It was during the post maintenance test of turbine driven pump that speed oscillations occurred causing pressure oscillations in the suction of the motor driven pump that was in service. Foreign material in the suction gauge protectors resulted in the pressure sensors sensing only the low pressures and not the high pressures of the oscillations, so the motor driven pump tripped on low pressure.
274	Suction	Unknown	Demand	Piping	Design	RHR-P	1983	Failure to Run	Complete	RHR pumps cavitated. Unable to repeat. Unknown cause.

Appendix C
Pump CCF Data Summary by System

Appendix C

Pump CCF Data Summary by System

This appendix is a summary of the data evaluated in the common-cause failure (CCF) data collection effort for pumps. This appendix supports the charts in Chapter 5. The table is sorted alphabetically, by the first four columns.

Appendix C

Table C-1. Pump CCF event summary, by system..... 3

Table C-1. Pump CCF event summary, by system.

Item	System	Segment	Piece Part	Discovery Method	Coupling Factor	Proximate Cause	Year	Failure Mode	Degree of Failure	Description
1	AFW	Discharge	Check Valve	Demand	Design	External Environment	1983	Failure to Start	Almost Complete	Hot water in the AFW pump casings caused the pumps to become vapor bound. The hot water was from leaking check valves upstream of the pumps. This event occurred once on the turbine driven pump and 5 times on the motor driven pump.
2	AFW	Discharge	Check Valve	Inspection	Maintenance	Internal to Component	1990	Failure to Start	Almost Complete	Leakage past AFW check valves caused AFW pumps to become steam bound. Closed motor operated valve in line. Scheduled check valves for replacement next outage.
3	AFW	Discharge	Valve	Demand	Design	Design/ Construction/ Manufacture/ Installation Inadequacy	1985	Failure to Start	Partial	Controller problems in the steam and diesel driven AFW pumps caused the pumps to trip on low suction pressure. The pump discharge flow controller valves were also not set properly after last maintenance. Low suction trips were due to design error.
4	AFW	Discharge	Valve	Demand	Design	Design/ Construction/ Manufacture/ Installation Inadequacy	1986	Failure to Start	Partial	Both the turbine driven and motor driven AFW pumps could not produce full flow because the cages in their discharge valve trapped debris and plugged.
5	AFW	Discharge	Valve	Demand	Environmental	Internal to Component	1988	Failure to Run	Partial	After automatic start, motor driven AFW pump swapped suction automatically to the nuclear service water system when a sustained low suction pressure condition was sensed, and raw water entered two steam generators. After the initial trip recovery, it was noted that AFW flow to steam generators had degraded following the suction swap. Inspections revealed that the cavitol cages for these valves were clogged with shredded Asiatic clam shells.
6	AFW	Discharge	Valve	Demand	Environmental	Internal to Component	1988	Failure to Run	Partial	After automatic start, motor driven AFW pump swapped suction automatically to the nuclear service water system when a sustained low suction pressure condition was sensed, and raw water entered two steam generators. After the initial trip recovery, it was noted that AFW flow to steam generators had degraded following the suction swap. Inspections revealed that the cavitol cages for these valves were clogged with shredded Asiatic clam shells.
7	AFW	Discharge	Valve	Inspection	Operational	Operational/ Human Error	1994	Failure to Start	Complete	Following a trip, the AFW Pumps were secured and the discharge flow control valves for the Motor Driven Pumps were closed. Later, an operator discovered during a routine Control Board walkdown that the valves were closed. Subsequent investigation revealed the AFW system had not been placed in standby readiness per the operating procedure after the system was secured.
8	AFW	Driver	Breaker	Demand	Maintenance	External Environment	1990	Failure to Run	Partial	AFW pumps circuit breakers degraded.
9	AFW	Driver	Breaker	Maintenance	Maintenance	Internal to Component	1992	Failure to Start	Partial	With the unit in a refueling outage, following repairs to a motor driven auxiliary feedwater pump local/remote switch of the circuit breaker, personnel found that the switch contacts would not close. This failure rendered one of three auxiliary feedwater pumps inoperable. The cause of the failure appears to be due to dirty/corroded contacts on the switch.
10	AFW	Driver	Breaker	Test	Maintenance	Internal to Component	1997	Failure to Start	Almost Complete	The circuit breakers associated with the AFW Pumps failed to close as required. The root cause of the failure was the binding in the operating mechanism. The plunger apparently did not always complete its upward movement to close and latch the breaker, due to accumulated dirt and lubricants.

Item	System	Segment	Piece Part	Discovery Method	Coupling Factor	Proximate Cause	Year	Failure Mode	Degree of Failure	Description
11	AFW	Driver	Breaker	Test	Design	Operational/ Human Error	1985	Failure to Start	Complete	Both AFW pumps failed to start when tested, due to the circuit breakers not being racked in properly.
12	AFW	Driver	I&C	Demand	Design	Design/ Construction/ Manufacture/ Installation Inadequacy	1981	Failure to Start	Almost Complete	Two AFW pumps failed to automatically start due to low suction pressure trips. A modification was installed to prevent this. This effect was discovered previously, but apparently had not been corrected prior to an attempt to start the pumps three weeks later.
13	AFW	Driver	I&C	Demand	Design	Design/ Construction/ Manufacture/ Installation Inadequacy	1997	Failure to Run	Partial	One actual AFW pump failure due to spurious electronic overspeed trip. Determined that all three pumps were susceptible to spurious overspeed trips.
14	AFW	Driver	I&C	Demand	Quality	Design/ Construction/ Manufacture/ Installation Inadequacy	1989	Failure to Start	Complete	Both motor driven auxiliary feedwater pumps failed to start when the operator tried to start them manually. While preparing a design change, the designer failed to review all the unit specific documentation associated with the motor-driven AFW pump wiring and made the erroneous assumption that both units switchgear compartment internal wiring was identical. In fact, the wiring for each unit was different. Consequently, when the design change was installed, it was installed in accordance with the erroneous design. The wiring discrepancy was corrected and the motor-driven AFW pumps were tested and returned to service.
15	AFW	Driver	I&C	Demand	Design	Design/ Construction/ Manufacture/ Installation Inadequacy	1981	Failure to Start	Almost Complete	A modification to the control instrumentation for two AFW pumps resulted in a backfeed situation such that when called upon to start, both pumps would not start.
16	AFW	Driver	I&C	Demand	Operational	Operational/ Human Error	1983	Failure to Start	Complete	An operator incorrectly secured the diesel and steam driven AFW pumps, which prevented their restart on low SG level.
17	AFW	Driver	I&C	Demand	Environmental	External Environment	1984	Failure to Start	Complete	Both AFW pumps failed to start. The problem was traced to two relays (1 per pump). Examination of the relays revealed open circuiting and severe degradation of the insulation.
18	AFW	Driver	I&C	Inspection	Design	Other	1983	Failure to Start	Partial	Both AFW pumps had to be rendered inoperable to allow repairs to actuation circuitry.
19	AFW	Driver	I&C	Inspection	Design	Design/ Construction/ Manufacture/ Installation Inadequacy	1994	Failure to Start	Partial	Single failure would prevent auto initiation of AFW. Circuit design did not provide separation required by standards and code. The single failure identified was a short circuit across two conductors of the actuation relays associated with the initiation logic matrix.
20	AFW	Driver	I&C	Inspection	Maintenance	Operational/ Human Error	1990	Failure to Start	Complete	During testing one AFW pump was tested and other was tested without returning first to auto. Both pumps were unavailable at the same time. The procedure was the cause.
21	AFW	Driver	I&C	Test	Design	Design/ Construction/ Manufacture/ Installation Inadequacy	1981	Failure to Start	Almost Complete	Two low suction pressure trips for the AFW pumps were mis-calibrated, which prevented the pumps from starting.

Item	System	Segment	Piece Part	Discovery Method	Coupling Factor	Proximate Cause	Year	Failure Mode	Degree of Failure	Description
22	AFW	Driver	I&C	Test	Design	Design/ Construction/ Manufacture/ Installation Inadequacy	1992	Failure to Start	Complete	A modification design error (in 1983-1984) removed a start permissive interlock contact. At cold shutdown this de-energized the auxiliary lube oil pump, consequently, when one AFW pump was started it ran for 2.5 seconds and tripped on low oil pressure. Further investigation showed that both units AFW pumps would be affected in the same way. The design error combined with insufficient post modification testing led to this CCF event.
23	AFW	Driver	I&C	Test	Quality	Design/ Construction/ Manufacture/ Installation Inadequacy	1980	Failure to Start	Complete	During surveillance testing, neither motor-driven AFW pump would start. The pump control circuit was found with autostart defeat switches labeled backwards, causing all autostarts except the low-low steam generator level to be defeated. The labels were corrected and the links were closed. The original installation error was the result of an inadequate design change process that did not require sufficient verification and testing of the modification.
24	AFW	Driver	Motor	Inspection	Environmental	Other	1990	Failure to Start	Partial	Both motor driven AFW pumps were sprayed when a service water pipe developed a through wall leak.
25	AFW	Pump	Bearing	Demand	Maintenance	Internal to Component	1984	Failure to Run	Partial	One ESW bearing failed and pump seized; second motor bearing failed.
26	AFW	Pump	Casing	Demand	Maintenance	Operational/ Human Error	1983	Failure to Run	Partial	During testing, the outboard bearing temperature was high on the turbine-driven AFW pump, due to improper balance drum clearances, caused by improper maintenance. The procedure will be modified and the balance drum clearance reset. While the unit was starting up, the motor-driven AFW pump outboard bearing temperature was high. Excessive thrust bearing clearance caused the balance drum to unbalance, causing the thrust bearing to overheat.
27	AFW	Pump	Casing	Inspection	Quality	Design/ Construction/ Manufacture/ Installation Inadequacy	1983	Failure to Run	Partial	Two AFW pumps thrust tolerance was out of specification. These events were caused by improperly installed balancing drum parts. One turbine driven and one motor driven pump was involved.
28	AFW	Pump	Impeller/Wear Rings	Demand	Quality	Internal to Component	1988	Failure to Run	Partial	Following a plant trip, it was discovered that the auxiliary feedwater pumps had internal damage. Some channel ring vanes had chips missing, and several parts were found in the SG auxiliary feedwater piping.
29	AFW	Pump	Impeller/Wear Rings	Demand	Design	Operational/ Human Error	1990	Failure to Run	Almost Complete	Due to a combination of management error and procedural deficiency, the turbine driven auxiliary feedwater pump was run deadheaded. The operation damaged the pump. When the pump was manually tripped, steam vented back into the suction line, caused another AFW pump to also trip, on a low suction pressure signal.
30	AFW	Pump	Packing	Inspection	Maintenance	Internal to Component	1986	Failure to Run	Partial	The packing was worn on both the motor-driven and one turbine-driven aux. feedwater pump, causing high temperature on one packing gland, and excessive leaking on the other pump.
31	AFW	Pump	Packing/Seals	Demand	Maintenance	Internal to Component	1998	Failure to Run	Partial	AFW MDP and TDPs failed due to incorrect packing installed.
32	AFW	Pump	Packing/Seals	Inspection	Maintenance	Internal to Component	1990	Failure to Run	Partial	Both motor-driven aux. feedwater pumps had excessive packing leaks, due to worn packing.

Item	System	Segment	Piece Part	Discovery Method	Coupling Factor	Proximate Cause	Year	Failure Mode	Degree of Failure	Description
33	AFW	Pump	Packing/Seals	Test	Maintenance	Operational/ Human Error	1996	Failure to Run	Partial	During the performance of Steam-Driven Emergency Feedwater Pump testing, sparks were observed emanating from the outboard mechanical seal area. The sparks appeared to be due to a mechanical interference within the mechanical seal assembly. The pump mechanical seal was disassembled and determined to have been improperly installed during the last refueling outage. The evaluation identified a mechanical seal design deficiency and inadequate corrective action for a previously identified event as the primary causes for this event. A contributing cause for this event was found to be inadequate predictive maintenance techniques. The electric AFW pump exhibited the same problem.
34	AFW	Pump	Shaft	Test	Design	Design/ Construction/ Manufacture/ Installation Inadequacy	1988	Failure to Run	Almost Complete	An auxiliary feedwater pump failed its performance test. Subsequent inspection of the pump internals revealed significant damage, including a split in the center shaft sleeve. The AFW pumps were susceptible to corrosion cracking of their bushings. A different material was needed for the bushings.
35	AFW	Pump	Shaft	Test	Design	Design/ Construction/ Manufacture/ Installation Inadequacy	1988	Failure to Run	Partial	The AFW pumps were susceptible to corrosion cracking of their bushings. A different material was needed for the bushings.
36	AFW	Suction	I&C	Test	Design	Other	1985	Failure to Run	Almost Complete	Testing of the turbine driven AFW pump resulted in a low suction trip of the motor driven pump. The turbine driven pump had a faulty governor. It was during the post maintenance test of turbine driven pump that speed oscillations occurred causing pressure oscillations in the suction of the motor driven pump that was in service. Foreign material in the suction gauge protectors resulted in the pressure sensors sensing only the low pressures and not the high pressures of the oscillations, so the motor driven pump tripped on low pressure.
37	AFW	Suction	Piping	Test	Design	Design/ Construction/ Manufacture/ Installation Inadequacy	1999	Failure to Run	Partial	All AFW trains declared inoperable due to inadequate suction flow capability from the nuclear service water alternate source. Inadequate flow caused by corroded piping. Piping is undersized so there is little margin for piping degradation. Since this is 1 of 4 suction sources, the safety significance is limited.
38	AFW	Suction	Tank	Demand	Design	Operational/ Human Error	1980	Failure to Run	Complete	Both emergency feedwater pumps lost feed pump suction. The emergency feedwater pump suction flashed to steam due to the feedwater train flashing and forcing hot water back through the startup and blowdown tanks and into the feedwater pump suction. To prevent this recurrence, the operating procedures have been changed to require isolating the startup and blowdown effluent as a source of emergency feedwater suction prior to increasing power.
39	CSS	Driver	Breaker	Inspection	Operational	Operational/ Human Error	1991	Failure to Start	Complete	CSR control power de-energized prior to mode change. Technical Specification violation. Inadequate procedure review.
40	ESW	Discharge	Check Valve	Test	Operational	Design/ Construction/ Manufacture/ Installation Inadequacy	1999	Failure to Run	Partial	Two ESW pumps had low flow due to interaction with the two other pumps when all four pumps were running.
41	ESW	Discharge	Valve	Demand	Maintenance	Other	1980	Failure to Start	Partial	RHR service water pumps were started to put torus cooling in service. When these pumps would not deliver required discharge pressure, they were declared inoperable. The seal in an air release valve was bad, allowing a vent on the discharge line.

Item	System	Segment	Piece Part	Discovery Method	Coupling Factor	Proximate Cause	Year	Failure Mode	Degree of Failure	Description
42	ESW	Driver	Bearing	Inspection	Maintenance	Internal to Component	1985	Failure to Run	Partial	One service water pump motor upper bearing oil reservoir leaking from cover plate. Another service water pump motor upper oil cooler oil reservoir leaking.
43	ESW	Driver	Bearing	Inspection	Maintenance	Internal to Component	1981	Failure to Run	Partial	ESW motor to pump alignment problems. Bearings worn out.
44	ESW	Driver	Bearing	Test	Maintenance	Internal to Component	1985	Failure to Run	Partial	Service water pumps exhibited vibration. Attributed to normal wear.
45	ESW	Driver	Breaker	Demand	Maintenance	Operational/ Human Error	1993	Failure to Start	Partial	Operations personnel were attempting to swap the running service water pump with the idle service water pump. Personnel placed the control switch to start and the service water pump did not start. Breaker malfunction. Later, another service water pump failed to start because of the breaker.
46	ESW	Driver	Breaker	Demand	Design	Internal to Component	2000	Failure to Start	Almost Complete	Two ESW pumps failed to start due to their breakers failing to close. The breakers' prop spring bracket has slipped thus preventing proper interfacing between the prop and the prop pin.
47	ESW	Driver	Breaker	Demand	Maintenance	Operational/ Human Error	1987	Failure to Start	Partial	One breaker failed to linkage alignment and second from loose relay connections. Inadequate maintenance.
48	ESW	Driver	Breaker	Demand	Maintenance	Operational/ Human Error	1988	Failure to Run	Partial	Service water pump high dropout over current protection devices were less than running current conditions and trip setpoints did not account for changing load conditions due to modified impellers. Three pump trips had occurred.
49	ESW	Driver	Breaker	Demand	Quality	Design/ Construction/ Manufacture/ Installation Inadequacy	1996	Failure to Start	Partial	Two RHRSW pumps fail to start due to breaker failures. Wrong contacts were installed. Design called for contacts to have a minimum current interrupt rating of 6 amps; contacts installed (that subsequently failed) had current interrupt rating of only 2.2 amps.
50	ESW	Driver	Breaker	Inspection	Quality	Operational/ Human Error	1992	Failure to Start	Partial	The fit between an ESW pump breaker primary disconnects and the associated breaker cubicle stabs was inadequate. The poor fit between the disconnects and the stabs led to arcing in the breaker cubicle when the pump was started, resulting in a fire. Shortly after identifying the cause of the fire, the remaining ESW breakers, which had recently been replaced along with the failed breaker, as part of a design modification package, were found to be inadequate also.
51	ESW	Driver	Breaker	Inspection	Operational	Operational/ Human Error	1981	Failure to Start	Almost Complete	Control breakers for two ESW pumps were open due to inadvertent operator action.
52	ESW	Driver	Breaker	Inspection	Maintenance	Internal to Component	1996	Failure to Start	Partial	ESW pump breakers fail due to misalignment of the breaker mechanism and internals developed over the years of operation.
53	ESW	Driver	Breaker	Inspection	Design	Operational/ Human Error.	1984	Failure to Start	Partial	During an attempt to perform preventive maintenance for unit one's RHR service water pumps, plant personnel mistakenly disconnected the motor leads for unit two's RHR service water pump.
54	ESW	Driver	Breaker	Maintenance	Maintenance	Other	1984	Failure to Start	Partial	ESW pump breaker failures, broken screw, no lubrication, and a bent track
55	ESW	Driver	Breaker	Maintenance	Maintenance	Internal to Component	1985	Failure to Start	Partial	Two raw water pump breaker main wipes were out of adjustment.
56	ESW	Driver	Breaker	Maintenance	Maintenance	Other	1982	Failure to Start	Partial	ESW pump circuit breakers found damaged. Defective arc chute and cracked secondary coupler.

Item	System	Segment	Piece Part	Discovery Method	Coupling Factor	Proximate Cause	Year	Failure Mode	Degree of Failure	Description
57	ESW	Driver	Breaker	Test	Maintenance	Internal to Component	1998	Failure to Start	Partial	Two RHR service water pump breakers would not close due to dirty contacts in breakers.
58	ESW	Driver	Breaker	Test	Maintenance	Internal to Component	1998	Failure to Start	Partial	Service water pumps fail to start due to circuit breaker failures. Pump breakers failed to close due to failures of the charging spring/motor and closing spring motor.
59	ESW	Driver	Breaker	Test	Maintenance	Other	1984	Failure to Start	Partial	ESW pump breaker overcurrent trip devices tripping too low.
60	ESW	Driver	Breaker	Test	Maintenance	Other	1984	Failure to Start	Partial	ESW pump breakers tripped due to failed voltage control devices.
61	ESW	Driver	I&C	Demand	Design	Other	1981	Failure to Start	Partial	Attempt was made to place the a RHRSW subsystem into service for use in suppression pool cooling, the subsystems' pumps could not be started due to a pump suction header low pressure lockout signal from the header pressure switch. The threaded plug in the switch diaphragm housing became loose and allowed the diaphragm fluid to leak out and caused the switch to sense a low pressure. This is a second event two months later.
62	ESW	Driver	I&C	Demand	Maintenance	Other	1982	Failure to Start	Complete	Following a reactor scram, an attempt to initiate suppression pool cooling revealed that both RHRSW loops were inoperable as neither loop's pumps could be started. Low suction header pressure lockout signals in each loop prevented starting each loop's pumps. Plugging of the sensing line to each loop's suction header pressure switch prevented both switches from sensing actual pressure, although a lack of operating fluid in one switch and an open power supply breaker to the other switch also would have prevented pumps from starting.
63	ESW	Driver	I&C	Demand	Operational	Operational/ Human Error	1981	Failure to Start	Partial	Alarm circuit breaker was de-energized resulting in a loss of two RHR service water pumps.
64	ESW	Driver	I&C	Demand	Design	Other	1981	Failure to Start	Partial	Attempt was made to place the a RHRSW subsystem into service for use in suppression pool cooling, the subsystems' pumps could not be started due to a pump suction header low pressure lockout signal from the header pressure switch. The threaded plug in the switch diaphragm housing became loose and allowed the diaphragm fluid to leak out and caused the switch to sense a low pressure.
65	ESW	Driver	I&C	Demand	Design	Operational/ Human Error	1980	Failure to Start	Partial	Instrument isolation valve closed causing a low suction trip signal to two RHRSW pumps.
66	ESW	Driver	I&C	Demand	Maintenance	Internal to Component	1991	Failure to Start	Partial	Two ESW pumps failed to start due to failed breakers. Inadequate maintenance.
67	ESW	Driver	I&C	Inspection	Design	Internal to Component	1982	Failure to Start	Partial	Open circuit breaker resulted in loss of two RHR service water pumps.
68	ESW	Driver	I&C	Test	Design	Other	1992	Failure to Start	Partial	Valve position contacts prevented ESW pump circuit breakers from closing. Poor design resulted in water intrusion in the valve limit switch box.
69	ESW	Driver	I&C	Test	Operational	Operational/ Human Error	1990	Failure to Start	Complete	An emergency service water pump failed to start and was declared inoperable. Further investigation determined that the failure of the pump to start was due to a tripped emergency engine shutdown device. Operations personnel performing the testing did not recognize the need to reset it prior to starting the pump. Examination of the other two ESW pumps revealed that their emergency shutdown devices were also in the tripped condition.
70	ESW	Driver	I&C	Test	Quality	Operational/ Human Error	1982	Failure to Start	Partial	Two ESW pumps failed to start. One ESW pump failed to function as a result of loose wires on relay terminals in both pump logic schemes, a loose states link and an instantaneous contact found out of adjustment on the other pump logic scheme.

Item	System	Segment	Piece Part	Discovery Method	Coupling Factor	Proximate Cause	Year	Failure Mode	Degree of Failure	Description
71	ESW	Driver	I&C	Test	Maintenance	Operational/ Human Error	1989	Failure to Start	Partial	Emergency equipment service water pump relays were not reset following a load shedding test 30 hours before.
72	ESW	Driver	Motor	Demand	Quality	Design/ Construction/ Manufacture/ Installation Inadequacy	1987	Failure to Start	Partial	ESW pump motors tripped on overcurrent. The overcurrent trip was due to a ground and a short on the pump motor.
73	ESW	Driver	Motor	Demand	Environmental	External Environment	1985	Failure to Run	Partial	Two service water motors failed on demand as a result of cement dust contamination.
74	ESW	Driver	Motor	Inspection	Environmental	Other	1981	Failure to Run	Partial	The float guide failed in a RHRSW pump air valve and caused the valve to fail open and flood pump room.
75	ESW	Driver	Motor	Maintenance	Environmental	External Environment	1987	Failure to Start	Partial	During an extended service water bay flooding incident, one ESW pump was found grounded by testing, later two more pumps were found to be failed also.
76	ESW	Driver	Motor	Test	Maintenance	Operational/ Human Error	1994	Failure to Run	Partial	Leak test of the containment cooling service water pump vault watertight door revealed excessive leakage. Flooding and leakage past this door would make inoperable two of four containment cooling service water pumps. Procedural inadequacy was cited as the cause for the degraded door seals.
77	ESW	Pump	Bearing	Inspection	Operational	Other	1991	Failure to Run	Partial	Lube oil cooling water isolated during a test. Pumps continued to run with no cooling.
78	ESW	Pump	Bearing	Inspection	Maintenance	Internal to Component	1987	Failure to Run	Partial	Service water pumps had high shaft vibration. The excessive vibrations caused by worn bearings and shaft sleeves.
79	ESW	Pump	Bearing	Maintenance	Maintenance	Internal to Component	1985	Failure to Run	Partial	High ESW pump vibration was caused by wearing of the upper bearings.
80	ESW	Pump	Bearing	Test	Maintenance	Internal to Component	1985	Failure to Run	Partial	ESW pumps had reduced flow and discharge pressure. Worn impellers/wearing rings.
81	ESW	Pump	Bearing	Test	Environmental	Internal to Component	1992	Failure to Run	Partial	Abrasive particles present in ocean water produced accelerated wear of shaft bearing journals.
82	ESW	Pump	Casing	Demand	Maintenance	Internal to Component	1998	Failure to Start	Partial	Two ESW pump started and ran, but would not develop sufficient pressure or flow rate. Exact cause not known for either failure, however, one pump was noted to have microbiological induced corrosion fouling on internal surfaces.
83	ESW	Pump	Casing	Inspection	Maintenance	Internal to Component	1988	Failure to Run	Partial	RHR service water pumps. Pump diffuser eroded on first pump and a through wall casing leak developed on the second.
84	ESW	Pump	Casing	Inspection	Maintenance	Internal to Component	1986	Failure to Run	Partial	Cracked seal water and vent lines.
85	ESW	Pump	Casing	Test	Maintenance	Design/ Construction/ Manufacture/ Installation Inadequacy	1997	Failure to Run	Almost Complete	Both ESW pumps failed due to installation of wrong material for pump casing flanges by vendor during pump overhaul. The vendor overhauled the pumps without changing material. The plant returned the pumps to the warehouse also without verifying material.
86	ESW	Pump	Coupling	Inspection	Environmental	External Environment	1993	Failure to Run	Partial	Entrained debris caused ESW pump shaft coupling to fail. Plant equipment did not prevent this debris from entering pump.

Item	System	Segment	Piece Part	Discovery Method	Coupling Factor	Proximate Cause	Year	Failure Mode	Degree of Failure	Description
87	ESW	Pump	Coupling	Test	Environmental	Design/ Construction/ Manufacture/ Installation Inadequacy	1987	Failure to Start	Partial	Test showed two ESW pumps failed. Pump shafts were corroded and found to be made of incorrect material.
88	ESW	Pump	Coupling	Test	Design	Design/ Construction/ Manufacture/ Installation Inadequacy	1994	Failure to Start	Partial	Pump produced no flow when started. A shaft coupling failed. Material was determined to be brittle and have low impact properties. The coupling was replaced on all pumps with a type of material more suitable for this application.
89	ESW	Pump	Coupling	Test	Maintenance	Internal to Component	1990	Failure to Start	Partial	ESW pumps had reduced flow and discharge pressure. Worn impellers/wearing rings. Cause determined to be normal wear and high sand content of river water.
90	ESW	Pump	Coupling	Test	Maintenance	Internal to Component	1987	Failure to Start	Almost Complete	Two ESW pumps had failed couplings. Cause attributed to abnormal stress.
91	ESW	Pump	Impeller/Wear Rings	Demand	Design	Design/ Construction/ Manufacture/ Installation Inadequacy	1996	Failure to Run	Partial	A Nuclear Service Water pump tripped on overcurrent after operating for approximately 20 minutes. Initial troubleshooting indicated that the pump was binding and disassembly was required to determine the cause. It was determined that the pump impeller thrust ring had become loose due to thrust ring retainer bolt failure, which allowed the impeller to slip on the shaft and resulted in pump binding and the overcurrent condition. The bolts failed due to corrosion. Similar bolt degradation was discovered on other service water pumps. The investigation results indicate the primary cause of the bolt failures was corrosion induced by galvanic coupling of the retainer bolting and other pump components.
92	ESW	Pump	Impeller/Wear Rings	Demand	Quality	Design/ Construction/ Manufacture/ Installation Inadequacy	1988	Failure to Run	Partial	ESW pumps drawing excessive current. Carbon steel snap rings corroded allowing impeller to come in contact with casing. The third pump, although not exhibiting abnormal current, had similar corrosion
93	ESW	Pump	Impeller/Wear Rings	Demand	Environmental	Internal to Component	1994	Failure to Run	Partial	Raw water pump currents stayed high after starting. The primary cause of these events was determined to be elevated sand content in the river, resulting in excessive sand accumulation around the suction area of the pumps.
94	ESW	Pump	Impeller/Wear Rings	Demand	Quality	Design/ Construction/ Manufacture/ Installation Inadequacy	1996	Failure to Run	Partial	A Nuclear Service Water pump tripped on overcurrent after operating for approximately 20 minutes. Initial troubleshooting indicated that the pump was binding and disassembly was required to determine the cause. It was determined that the pump impeller thrust ring had become loose due to thrust ring retainer bolt failure, which allowed the impeller to slip on the shaft and resulted in pump binding and the overcurrent condition. The bolts failed due to corrosion. Similar bolt degradation was discovered on other service water pumps. The investigation results indicate the primary cause of the bolt failures was corrosion induced by galvanic coupling of the retainer bolting and other pump components.
95	ESW	Pump	Impeller/Wear Rings	Demand	Environmental	Design/ Construction/ Manufacture/ Installation Inadequacy	2000	Failure to Start	Almost Complete	Two of the River Water pumps tripped on overcurrent when they were attempted to be started. The trips were a result of physical contact between the impeller and the lower casing liner of the pumps. This condition was due to differential thermal expansion between the pump shaft and the pump casing as a result of an elevated seal injection water temperature. The elevated temperature was due to an abnormal configuration of the Filtered Water System (the backup seal water supply).

Item	System	Segment	Piece Part	Discovery Method	Coupling Factor	Proximate Cause	Year	Failure Mode	Degree of Failure	Description
96	ESW	Pump	Impeller/Wear Rings	Demand	Design	Design/Construction/Manufacture/Installation Inadequacy	1981	Failure to Run	Complete	Both charging pump service water pumps failed. A carbon cap screw failed allowing the impeller of one pump to bind on the casing. The ensuing leakage shorted the motor windings of the other pump.
97	ESW	Pump	Impeller/Wear Rings	Demand	Design	Design/Construction/Manufacture/Installation Inadequacy	1986	Failure to Run	Partial	All four emergency service water pumps showed cavitation damage. Two of the pumps had minor damage and were placed back in service. Recirculation cavitation occurs at flows significantly less than design.
98	ESW	Pump	Impeller/Wear Rings	Inspection	Environmental	Internal to Component	1990	Failure to Start	Partial	ESW pumps had reduced flow and discharge pressure. Marine growth in suction.
99	ESW	Pump	Impeller/Wear Rings	Inspection	Maintenance	Internal to Component	1985	Failure to Run	Partial	Service water pumps were noted to have high vibrations and low discharge pressure. The cause of the failure is suspected to be binding.
100	ESW	Pump	Impeller/Wear Rings	Test	Maintenance	Internal to Component	1994	Failure to Start	Partial	Two ESW pumps had low discharge pressure during testing. Each pump had worn internals and both pump internals were replaced.
101	ESW	Pump	Impeller/Wear Rings	Test	Maintenance	Internal to Component	1987	Failure to Run	Partial	ESW pump low flow. Worn impellers.
102	ESW	Pump	Impeller/Wear Rings	Test	Maintenance	Internal to Component	1990	Failure to Start	Partial	ESW pumps had reduced flow and discharge pressure. Worn impellers/wearing rings.
103	ESW	Pump	Impeller/Wear Rings	Test	Maintenance	Internal to Component	1989	Failure to Start	Partial	ESW pumps had reduced flow and discharge pressure. Worn impellers/wearing rings.
104	ESW	Pump	Impeller/Wear Rings	Test	Maintenance	Internal to Component	1988	Failure to Start	Partial	Service water pumps were noted to have high vibrations and low discharge pressure. Uneven wear caused pump to be out of balance.
105	ESW	Pump	Impeller/Wear Rings	Test	Maintenance	Internal to Component	1988	Failure to Run	Partial	ESW pumps failed to meet the minimum flow requirements of test. The cause of the failure is normal wearout of the pump impeller due to brackish water corrosion.
106	ESW	Pump	Impeller/Wear Rings	Test	Environmental	Internal to Component	1991	Failure to Run	Partial	ESW pumps failed to meet the minimum flow requirements of test. The cause of the failure is normal wearout of the pump impeller due to the high sand content of the water being pumped. Pump impeller lift was adjusted.
107	ESW	Pump	Impeller/Wear Rings	Test	Maintenance	Internal to Component	1988	Failure to Start	Partial	Essential service water pumps were declared inoperable, due to low pump head valves. The low pump heads were caused by wear and aging of internals.
108	ESW	Pump	Impeller/Wear Rings	Test	Maintenance	Internal to Component	1990	Failure to Run	Partial	ESW pumps had worn and cracked impellers. Aging and normal wear.
109	ESW	Pump	Impeller/Wear Rings	Test	Maintenance	Internal to Component	1991	Failure to Start	Partial	ESW pumps had reduced flow and discharge pressure. Worn impellers/wearing rings.
110	ESW	Pump	Impeller/Wear Rings	Test	Maintenance	Internal to Component	1990	Failure to Start	Partial	ESW impeller gaps too wide. Gaps adjusted.
111	ESW	Pump	Impeller/Wear Rings	Test	Maintenance	Internal to Component	1985	Failure to Run	Partial	ESW pumps failed due to worn internals.
112	ESW	Pump	Impeller/Wear Rings	Test	Environmental	Internal to Component	1982	Failure to Start	Partial	Essential service water pumps were declared inoperable, due to low pump head valves. The low pump heads were caused by excessive wear of pump impeller due to foreign material in the service water.

Item	System	Segment	Piece Part	Discovery Method	Coupling Factor	Proximate Cause	Year	Failure Mode	Degree of Failure	Description
113	ESW	Pump	Impeller/Wear Rings	Test	Maintenance	Internal to Component	1988	Failure to Start	Partial	ESW pumps had reduced flow and discharge pressure. Worn impellers/wearing rings.
114	ESW	Pump	Impeller/Wear Rings	Test	Environmental	Internal to Component	1985	Failure to Run	Partial	ESW pumps failed to meet the minimum flow requirements of test. A rag was found in one impeller and a plastic bottle in the other.
115	ESW	Pump	Impeller/Wear Rings	Test	Maintenance	Internal to Component	1985	Failure to Start	Partial	ESW pumps had reduced flow and discharge pressure. Worn impellers/wearing rings.
116	ESW	Pump	Impeller/Wear Rings	Test	Maintenance	Internal to Component	1992	Failure to Start	Partial	ESW pumps had reduced flow and discharge pressure. Worn impellers/wearing rings. One pump also exhibited high vibration.
117	ESW	Pump	Impeller/Wear Rings	Test	Environmental	Internal to Component	1990	Failure to Run	Partial	ESW pump impeller lift out of adjustment.
118	ESW	Pump	Impeller/Wear Rings	Test	Quality	Design/Construction/Manufacture/Installation Inadequacy	1986	Failure to Start	Partial	Testing of the service water system disclosed that the performance of the three service water pumps was below requirements. The condition is the result of both an inadequate system design and the installation of replacement impellers, which were not modified by the vendor to improve performance, as were the original impellers.
119	ESW	Pump	Impeller/Wear Rings	Test	Maintenance	Internal to Component	1985	Failure to Run	Partial	The charging pump service water pumps degraded. Caused by expected wear of pump due to erosion and corrosion properties of the process fluid involved
120	ESW	Pump	Impeller/Wear Rings	Test	Environmental	Internal to Component	1995	Failure to Start	Partial	Pumps failed performance test. Sand in water eroded pump internals. Pump lift was adjusted.
121	ESW	Pump	Impeller/Wear Rings	Test	Maintenance	Internal to Component	1998	Failure to Start	Partial	Two ESW pumps failed to develop adequate flow/pressure - pumps degraded.
122	ESW	Pump	Impeller/Wear Rings	Test	Environmental	Internal to Component	1994	Failure to Start	Partial	Degraded performance identified during testing. Sand in water was causing accelerated wear of the pump internals. Lift was adjusted for three pumps and one pump internals were replaced.
123	ESW	Pump	Impeller/Wear Rings	Test	Environmental	Internal to Component	1993	Failure to Run	Partial	Essential service water pumps were declared inoperable, due to low pump head values. The low pump heads were caused by excessive wear of pump impeller due to sand in the service water.
124	ESW	Pump	Impeller/Wear Rings	Test	Environmental	Internal to Component	1992	Failure to Start	Partial	ESW pumps had reduced flow and discharge pressure. Worn impellers/wearing rings. Cause determined to be normal wear and high sand content of river water.
125	ESW	Pump	Impeller/Wear Rings	Test	Maintenance	Internal to Component	1985	Failure to Run	Partial	Wear caused high ESW pump bearing temperatures, vibration, and low amperage/flow.
126	ESW	Pump	Impeller/Wear Rings	Test	Maintenance	Internal to Component	1984	Failure to Run	Partial	Loss of Service Water pump due to wearout at end of life.
127	ESW	Pump	Impeller/Wear Rings	Test	Maintenance	Internal to Component	1985	Failure to Start	Partial	Emergency service water pumps discharge pressure below allowable limits. Causes were loose impellers, dropped impeller, and worn internals.
128	ESW	Pump	Impeller/Wear Rings	Test	Maintenance	Internal to Component	1981	Failure to Start	Partial	Loss of Service Water pump due to wearout at end of life.
129	ESW	Pump	Impeller/Wear Rings	Test	Maintenance	Internal to Component	1985	Failure to Start	Partial	ESW pumps failed to meet the minimum flow requirements of test. The cause of the failure is normal wearout of the pump impeller due to the high sand content of the water being pumped. Pump impeller lift was adjusted.
130	ESW	Pump	Impeller/Wear Rings	Test	Maintenance	Internal to Component	1982	Failure to Run	Partial	Loss of Service Water pump due to wearout at end of life.

Item	System	Segment	Piece Part	Discovery Method	Coupling Factor	Proximate Cause	Year	Failure Mode	Degree of Failure	Description
131	ESW	Pump	Impeller/Wear Rings	Test	Environmental	Internal to Component	1982	Failure to Run	Partial	Low ESW pump head values were caused excessive wear of pump impeller due to foreign material in the service water.
132	ESW	Pump	Impeller/Wear Rings	Test	Maintenance	Internal to Component	1984	Failure to Run	Partial	Containment spray raw water pumps failed flow tests. Aging and normal wear.
133	ESW	Pump	Impeller/Wear Rings	Test	Maintenance	Design/ Construction/ Manufacture/ Installation Inadequacy	1988	Failure to Start	Partial	Essential service water pumps were declared inoperable, due to low pump head valves. The low pump heads were caused by excessive wear of pump impeller due to foreign material in the service water.
134	ESW	Pump	Impeller/Wear Rings	Test	Maintenance	Internal to Component	1986	Failure to Run	Partial	ESW pump performance decreased 15% and 8% respectively since last test. Pumps were replaced.
135	ESW	Pump	Impeller/Wear Rings	Test	Maintenance	Internal to Component	1986	Failure to Run	Partial	ESW pumps had worn impellers and one had a plugged strainer.
136	ESW	Pump	Impeller/Wear Rings	Test	Environmental	Internal to Component	1995	Failure to Start	Partial	Marine growth caused low flow and speed condition for two service water pumps
137	ESW	Pump	Impeller/Wear Rings	Test	Maintenance	Internal to Component	1992	Failure to Start	Partial	ESW pumps had reduced flow and discharge pressure. Worn impellers/wearing rings.
138	ESW	Pump	Impeller/Wear Rings	Test	Maintenance	Internal to Component	1994	Failure to Run	Partial	Two ESW pumps had internal deterioration, one of which was indicated by high vibration readings.
139	ESW	Pump	Impeller/Wear Rings	Test	Maintenance	Internal to Component	1984	Failure to Start	Partial	Essential service water pumps were declared inoperable, due to low pump head values. The low pump heads were caused by wear and aging of internals.
140	ESW	Pump	Impeller/Wear Rings	Test	Maintenance	Internal to Component	1983	Failure to Run	Partial	RHR Service Water pumps failed flow tests due to wearout and had to be rebuilt.
141	ESW	Pump	Lubrication	Maintenance	Operational	Operational/ Human Error	1993	Failure to Run	Partial	Low pressure RHR bearing oil level not maintained high enough when new smaller sightglass installed. Second event the sightglass was broken when adding oil.
142	ESW	Pump	Packing/Seals	Inspection	Maintenance	Internal to Component	1986	Failure to Run	Partial	Excessive packing leakage. Both events occurred after previous maintenance had been performed for the same problems.
143	ESW	Pump	Packing/Seals	Inspection	Maintenance	Design/ Construction/ Manufacture/ Installation Inadequacy	1997	Failure to Run	Partial	Both ESW pumps leaking greater than 4 gpm because of inappropriate material for packing and sleeve (nitronic 60).
144	ESW	Pump	Packing/Seals	Inspection	Environmental	Internal to Component	1994	Failure to Run	Partial	Backup seal water regulators did not provide required flow during testing on two pumps. The third pump lost seal flow while operating. The cause was attributed to plugged lines.
145	ESW	Pump	Packing/Seals	Inspection	Maintenance	Internal to Component	1989	Failure to Run	Partial	ESW pump excessive packing leakage.
146	ESW	Pump	Packing/Seals	Maintenance	Environmental	Internal to Component	1985	Failure to Run	Partial	First pump developed seal leak due to sand. Second pump had high bearing temperatures due to trash clogging cooling water lines.
147	ESW	Pump	Packing/Seals	Test	Maintenance	Internal to Component	1981	Failure to Start	Partial	RHR service water pumps failed to meet flow requirements due to seal water leakage and pump wearout.
148	ESW	Pump	Shaft	Test	Maintenance	Internal to Component	1993	Failure to Run	Partial	Service water pumps were noted to have high vibrations and low discharge pressure. Uneven wear caused pump to be out of balance.

Item	System	Segment	Piece Part	Discovery Method	Coupling Factor	Proximate Cause	Year	Failure Mode	Degree of Failure	Description
149	ESW	Suction	Booster Pump	Demand	Operational	Operational/ Human Error	1980	Failure to Start	Partial	The service water RHR booster pump was de-energized during maintenance. The attempt to start service water pumps failed due to low suction pressure.
150	ESW	Suction	Piping	Demand	Design	Design/ Construction/ Manufacture/ Installation Inadequacy	1996	Failure to Start	Partial	Freezing of diesel generator service water piping in intake bay. Inadequate initial design.
151	ESW	Suction	Piping	Demand	Design	Design/ Construction/ Manufacture/ Installation Inadequacy	1982	Failure to Run	Complete	Increased flow to chillers resulted in loss of NPSH to Charging Water Service Water pumps.
152	ESW	Suction	Piping	Demand	Design	Design/ Construction/ Manufacture/ Installation Inadequacy	1981	Failure to Run	Complete	Increased flow to chillers resulted in loss of NPSH to Charging Water Service Water pumps.
153	ESW	Suction	Piping	Demand	Design	Design/ Construction/ Manufacture/ Installation Inadequacy	1982	Failure to Run	Almost Complete	Increased flow to chillers resulted in loss of NPSH to Charging Water Service Water pumps.
154	ESW	Suction	Piping	Demand	Maintenance	Operational/ Human Error	1996	Failure to Run	Complete	Both trains of both units charging pump service water pumps became air bound. Underwater diving maintenance activities on one units circulating water and service water lines was identified as the source of the air. The air entered the service water supply lines when a valve was opened in preparation for a Safety Injection logic test.
155	ESW	Suction	Piping	Demand	Design	Other	1980	Failure to Run	Almost Complete	Air ingress exceeded the air removal capability of the constant vent valves. A design change was implemented to remove the air compressor cooling from the service water system.
156	ESW	Suction	Piping	Demand	Design	Design/ Construction/ Manufacture/ Installation Inadequacy	1983	Failure to Run	Almost Complete	Increased flow to chillers resulted in loss of NPSH to Charging Pump Service Water pumps.
157	ESW	Suction	Piping	Demand	Quality	Design/ Construction/ Manufacture/ Installation Inadequacy	1984	Failure to Start	Partial	Both RHR service water pumps tripped as a result of inadequate venting of suction header resulting from poor orientation of the vent line.
158	ESW	Suction	Piping	Demand	Maintenance	Operational/ Human Error	1996	Failure to Run	Complete	Both trains of both units charging pump service water pumps became air bound. Underwater diving maintenance activities on one units circulating water and service water lines was identified as the source of the air. The air entered the service water supply lines when a valve was opened in preparation for a Safety Injection logic test.

Item	System	Segment	Piece Part	Discovery Method	Coupling Factor	Proximate Cause	Year	Failure Mode	Degree of Failure	Description
159	ESW	Suction	Piping	Demand	Design	Design/ Construction/ Manufacture/ Installation Inadequacy	1983	Failure to Run	Complete	Increased flow to chillers resulted in loss of NPSH to Charging Water Service Water pumps.
160	ESW	Suction	Piping	Demand	Design	Design/ Construction/ Manufacture/ Installation Inadequacy	1982	Failure to Run	Complete	The use of service water by the chillers can cause a loss of suction pressure to the Charging Water Service Water pumps.
161	ESW	Suction	Piping	Demand	Operational	Operational/ Human Error	1988	Failure to Run	Complete	The procedure failed to adequately caution the operator to slowly fill a drained line. Rapid filling resulted in a loss of NPSH to the charging service water pumps.
162	ESW	Suction	Piping	Demand	Environmental	Internal to Component	1986	Failure to Start	Partial	RHR service water pumps failed flow testing due to blocked suctions and abnormal wear of impellers.
163	ESW	Suction	Piping	Demand	Design	Design/ Construction/ Manufacture/ Installation Inadequacy	1981	Failure to Run	Complete	Increasing flow to chillers robs NPSH from charging service water pumps.
164	ESW	Suction	Piping	Demand	Operational	Operational/ Human Error	1986	Failure to Run	Complete	Failure to properly vent and fill a newly installed pipe introduced air into the charging pump service water system.
165	ESW	Suction	Piping	Demand	Design	Design/ Construction/ Manufacture/ Installation Inadequacy	1982	Failure to Run	Complete	The use of service water by the chillers can cause a loss of suction pressure to the charging pump service water pumps.
166	ESW	Suction	Piping	Demand	Design	Design/ Construction/ Manufacture/ Installation Inadequacy	1982	Failure to Run	Complete	The use of service water by the chillers can cause a loss of suction pressure to the charging pump service water pumps.
167	ESW	Suction	Piping	Test	Operational	Operational/ Human Error	1989	Failure to Run	Partial	Inadequate procedure led to air binding of operating ESW pumps.
168	ESW	Suction	Piping	Test	Environmental	Internal to Component	1990	Failure to Start	Partial	ESW pumps failed flow testing. Foreign material blocked the suction.
169	ESW	Suction	Strainer	Demand	Environmental	Internal to Component	1980	Failure to Run	Partial	Foreign material was allowed to enter the suction of the charging pump service water pumps resulting in low flow conditions.
170	ESW	Suction	Strainer	Inspection	Environmental	Internal to Component	1984	Failure to Run	Partial	Two RHR service water pumps had blown seals and sparks and smoke between the bearing housing and shaft. A piece of hard rubber valve liner was found in the pumps.
171	ESW	Suction	Strainer	Inspection	Environmental	Design/ Construction/ Manufacture/ Installation Inadequacy	2000	Failure to Run	Partial	RHRSW Pumps Failed to Develop flow/pressure. Debris in intake structure. Requires modifications to the traveling Water Screen.

Item	System	Segment	Piece Part	Discovery Method	Coupling Factor	Proximate Cause	Year	Failure Mode	Degree of Failure	Description
172	ESW	Suction	Strainer	Maintenance	Operational	Operational/ Human Error	1986	Failure to Run	Complete	A service water strainer was placed in service without being vented resulting in air binding system and loss of charging pump service water pumps.
173	ESW	Suction	Strainer	Test	Environmental	Internal to Component	1982	Failure to Run	Partial	Failures occurred on residual heat removal service water pumps. The pumps failed to meet flow and pressure requirements. Failure was due to debris lodging in pump impellers. Source of debris was maintenance activities, broken traveling water screens, and the inadvertent opening of a RHR minimum flow line which washed materials into suction pit.
174	ESW	Suction	Strainer	Test	Environmental	Internal to Component	1990	Failure to Run	Partial	Essential service water pumps were declared inoperable, due to low pump head valves. The low pump heads were caused by suction blockage due to foreign material in the service water.
175	ESW	Suction	Tank	Maintenance	Design	Design/ Construction/ Manufacture/ Installation Inadequacy	1985	Failure to Run	Partial	An engineering evaluation revealed that ESW had been inoperable several times due to low NPSH. All three units were affected.
176	ESW	Suction	Tank	Maintenance	Design	Design/ Construction/ Manufacture/ Installation Inadequacy	1990	Failure to Run	Partial	An engineering evaluation revealed that ESW had been inoperable several times due to low NPSH. All three units were affected.
177	ESW	Suction	Tank	Maintenance	Design	Design/ Construction/ Manufacture/ Installation Inadequacy	1985	Failure to Run	Partial	An engineering evaluation revealed that ESW had been inoperable several times due to low NPSH. All three units were affected.
178	ESW	Suction	Tank	Maintenance	Design	Design/ Construction/ Manufacture/ Installation Inadequacy	1990	Failure to Run	Partial	An engineering evaluation revealed that ESW had been inoperable several times due to low NPSH. All three units were affected.
179	ESW	Suction	Tank	Maintenance	Design	Design/ Construction/ Manufacture/ Installation Inadequacy	1990	Failure to Run	Partial	An engineering evaluation revealed that ESW had been inoperable several times due to low NPSH. All three units were affected.
180	ESW	Suction	Tank	Maintenance	Design	Design/ Construction/ Manufacture/ Installation Inadequacy	1985	Failure to Run	Partial	An engineering evaluation revealed that ESW had been inoperable several times due to low NPSH. All three units were affected.
181	ESW	Suction	Tank	Test	Design	Design/ Construction/ Manufacture/ Installation Inadequacy	1986	Failure to Run	Complete	Loss of prime in the condenser circulating water siphon flow system caused loss of low pressure service water pumps. Pumps lost suction during a test due to poor design.

Item	System	Segment	Piece Part	Discovery Method	Coupling Factor	Proximate Cause	Year	Failure Mode	Degree of Failure	Description
182	ESW	Suction	Valve	Test	Design	Design/ Construction/ Manufacture/ Installation Inadequacy	1983	Failure to Start	Partial	Low discharge pressure was caused by insufficient suction pressure. Service water flow to parallel components was adjusted.
183	HCI	Driver	Piping	Demand	Design	Other	1999	Failure to Start	Complete	Water entered the HCI and RCI steam supply lines, rendering both pumps inoperable. Failed reactor vessel instrumentation allowed water to overflow and fill the HCI/RCI steam lines. Pumps were unavailable.
184	HPI	Discharge	Piping	Inspection	Design	External Environment	1994	Failure to Run	Partial	Due to a leaking socket weld in the common recirculation line, all three SI pumps were declared inoperable. The underlying cause of the leak was a crack in the socket weld in the common recirculation line, caused by pipe displacement from air entrainment and pump misalignment.
185	HPI	Discharge	Recirc	Test	Environmental	Internal to Component	1991	Failure to Run	Partial	Something in HPI pump recirculation line was restricting flow. The piece later dislodged and no identification was made. Both SI pumps had inadequate recirculation flow.
186	HPI	Discharge	Recirc	Test	Environmental	External Environment	1992	Failure to Run	Almost Complete	Safety Injection pumps were declared inoperable due to an observed declining trend in the pump's recirculation flow. The cause of the Safety Injection pump reduced recirculation flow is attributed to foreign material blockage within the associated minimum flow recirculation line flow orifice.
187	HPI	Discharge	Valve	Inspection	Operational	Operational/ Human Error	1987	Failure to Start	Almost Complete	While attempting to fill the safety injection accumulators, it was discovered that two of three SI pumps had been isolated from the high head injection flowpath.
188	HPI	Discharge	Valve	Inspection	Operational	Operational/ Human Error	1993	Failure to Run	Partial	One AFW pump failed due to incorrect procedure which allowed pump to be run without flow, other AFW pump was allowed to run past max flow rate. It is unclear whether these mistakes were due to inadequate procedures or staff errors, but it was assumed to be a failure to follow procedure.
189	HPI	Discharge	Valve	Test	Maintenance	Internal to Component	1984	Failure to Start	Partial	CCP pump low flow rates due to inaccuracies in positioning the throttle valves.
190	HPI	Driver	Breaker	Inspection	Operational	Operational/ Human Error	1982	Failure to Start	Complete	During the draining of the reactor coolant system, both centrifugal charging pumps were rendered inoperable. The initial conditions in the draining procedure contained a confusing statement, which led to an erroneous assumption that both CCP breakers had to be racked out and tagged.
191	HPI	Driver	Breaker	Inspection	Operational	Operational/ Human Error	1989	Failure to Start	Partial	HPI Pump B not retested, then HPI Pump A removed from service.
192	HPI	Driver	Breaker	Inspection	Operational	Operational/ Human Error	1988	Failure to Start	Complete	HPI pumps not restored before mode change due to procedural inadequacy.
193	HPI	Driver	Breaker	Inspection	Operational	Operational/ Human Error	1990	Failure to Start	Complete	By opening incorrect breaker, HPI pump tripped while others were unavailable.
194	HPI	Driver	Breaker	Maintenance	Maintenance	Internal to Component	1991	Failure to Start	Partial	HPI pump breakers failed due to a broken pawl, and a broken closing coil.
195	HPI	Driver	Breaker	Test	Design	Design/ Construction/ Manufacture/ Installation Inadequacy	1980	Failure to Start	Partial	Upon testing the safety injection pumps it was found that the 6900-v breakers would lock-out preventing pump start if they were given a close signal for >0.32 seconds when a trip condition existed. There is no indication to operations when this locked-out condition exists. The breaker appears to be available for service when it actually is not. The only means of clearing the condition is to remove and reinstall the fuses at the breaker or manually change the state of the relays.

Item	System	Segment	Piece Part	Discovery Method	Coupling Factor	Proximate Cause	Year	Failure Mode	Degree of Failure	Description
196	HPI	Driver	L&C	Inspection	Operational	External Environment	1990	Failure to Run	Complete	It was determined that the common minimum flow path return line for the safety injection pumps to the refueling water storage tank was frozen. Previous actions to investigate problems with the freeze protection system were unsuccessful in preventing development of this condition. The two HPI pumps were declared inoperable with this return line frozen. A faulty ambient temperature switch for the RWST heat trace system prevented the heat trace from activating and was subsequently replaced. In addition, administrative controls did not sufficiently recognize the safety significance of flow through this line and the need to ensure flow capability.
197	HPI	Driver	L&C	Inspection	Operational	Operational/ Human Error	1990	Failure to Start	Partial	Both safety injection pumps were in the pull-to-lock position. With the switches in pull-to-lock, the pumps would not have automatically started upon receipt of an initiating signal. This event was caused by cognitive personnel error by a utility licensed operator in failure to follow an approved procedure.
198	HPI	Driver	L&C	Inspection	Operational	Operational/ Human Error	1992	Failure to Start	Almost Complete	Two charging pumps and one charging pump service water pump were removed from service simultaneously which is a condition not allowed by technical specifications.
199	HPI	Driver	L&C	Inspection	Operational	Operational/ Human Error	1988	Failure to Start	Complete	With alternate CCP pump out-of-service, the remaining operable pump was erroneously placed in pull-to-lock.
200	HPI	Driver	L&C	Maintenance	Design	Design/ Construction/ Manufacture/ Installation Inadequacy	1996	Failure to Run	Partial	A lead was lifted in an emergency bus DC control circuit resulting in one charging pump tripping while running on the alternate power supply. Further investigation into this event revealed an anomaly, which could result in having no operating charging pumps. The cause of the event has been determined to be an error in the original design of the charging pump interlock logic. The anomaly would occur upon a loss of the DC control power to one emergency bus if 'C' charging pump was powered from the other bus.
201	HPI	Driver	L&C	Maintenance	Design	Design/ Construction/ Manufacture/ Installation Inadequacy	1996	Failure to Run	Partial	A lead was lifted in an emergency bus DC control circuit resulting in one charging pump tripping while running on the alternate power supply. Further investigation into this event revealed an anomaly, which could result in having no operating charging pumps. The cause of the event has been determined to be an error in the original design of the charging pump interlock logic. The anomaly would occur upon a loss of the DC control power to one emergency bus if 'C' charging pump was powered from the other bus.
202	HPI	Driver	Lubrication	Demand	Maintenance	Internal to Component	1984	Failure to Run	Partial	Charging pump lube oil cooler fan motor trips on thermal overload. Probable cause: normal wear on motor resulting in increased friction replaced worn motor with spare. During routine inservice testing found that another charging pump lube oil cooler fan motor had a current imbalance. Probable cause: normal aging of motor insulation has resulted in a current imbalance.
203	HPI	Driver	Lubrication	Inspection	Design	Design/ Construction/ Manufacture/ Installation Inadequacy	2000	Failure to Run	Partial	CVC makeup oil pump motor too small for certain accidents.
204	HPI	Driver	Packing/Seals	Inspection	Maintenance	Internal to Component	1988	Failure to Run	Almost Complete	Smoke was discovered coming from the speed increaser unit for a centrifugal charging pump. Investigation found the two gland seal retaining bolts inside the speed increaser lube oil pump backed out allowing the gland seal to loosen. The gland seal being loosened caused reduced oil flow to the speed increaser internals and ultimate damage. Other CCPs were inspected, and the same gland seal bolts as on the first pump were found loosened. The cause of the bolts backing out was determined to be lack of a periodic adjustment of the gland seal bolts.

Item	System	Segment	Piece Part	Discovery Method	Coupling Factor	Proximate Cause	Year	Failure Mode	Degree of Failure	Description
205	HPI	Driver	Piping	Inspection	Environmental	Design/ Construction/ Manufacture/ Installation Inadequacy	2000	Failure to Run	Partial	Microbiologically induced corrosion leak on service water lines to two charging/HPI pump lube oil coolers.
206	HPI	Pump	Bearing	Inspection	Design	External Environment	1991	Failure to Run	Almost Complete	Charging/safety pumps beyond operational limits. Damage was found to the thrust bearings. Air was introduced into this train of chilled water during modifications and testing being performed on the system. This air became trapped in high points of either, or both of, the supply and return chilled water lines to the charging pump. At the reduced flow rate, sufficient cooling was not available and oil temperature increased to the point where bearing damage occurred.
207	HPI	Pump	Casing	Inspection	Quality	Design/ Construction/ Manufacture/ Installation Inadequacy	1987	Failure to Run	Partial	During inspection of a centrifugal charging pump, a portion of the stainless steel cladding on the inside surface of the pump casing exhibited corrosion. Corrosion of the pump casing was through the stainless steel cladding into the carbon steel base material. Inspection of the other CCP revealed similar corrosion. The cause of this event was a manufacturing deficiency. Corrosion observed at the pump casing discharge nozzle was attributed to a cladding breakthrough during final machining. Corrosion observed at the pump casing inlet end was attributed to either over-machining of the cladding or inadequate overlay of two adjacent weld beads.
208	HPI	Pump	Impeller/Wear Rings	Test	Environmental	Internal to Component	1984	Failure to Run	Almost Complete	One HPI pump seized, the second would have seized if operated.
209	HPI	Pump	Impeller/Wear Rings	Test	Maintenance	Internal to Component	1983	Failure to Start	Partial	SI pump and both CCPs failed to meet the minimum head curve requirements. The cause of pump head capacity degradation has been attributed to normal pump operation. The inability to balance flows has been attributed to the lower head capacity of the pumps.
210	HPI	Pump	Impeller/Wear Rings	Test	Maintenance	Internal to Component	1985	Failure to Start	Partial	The CCPs were tested and had low flow rates. The most probable cause is attributed to observed degradation of the pumps. The CCPs are subject to normal wear associated with their secondary duty of providing normal charging flow.
211	HPI	Pump	Lubrication	Inspection	Design	Internal to Component	1981	Failure to Run	Partial	Corrosion of HPI pump cooler heads. Improper material led to corrosion
212	HPI	Pump	Lubrication	Inspection	Operational	Operational/ Human Error	1983	Failure to Start	Complete	A routine preventive maintenance (oil change) was mistakenly performed on the north charging pump instead of the south as scheduled. Since the south pump was previously cleared for this oil change, and the test pump was valved out, none of these three pumps were in service as required by tech specs for the approximately 20 minutes it took to change the oil in the north pump.
213	HPI	Pump	Lubrication	Inspection	Environmental	Design/ Construction/ Manufacture/ Installation Inadequacy	1995	Failure to Run	Partial	High lube oil temperatures were observed during HPI pump operation. Zinc particles from anode were discovered plugging the lube oil coolers. Accelerated corrosion was attributed to a corrosion inhibitor that was added to the system, which chemically interacted with the zinc.
214	HPI	Pump	Lubrication	Inspection	Environmental	Internal to Component	1983	Failure to Run	Partial	Oysters and miscellaneous mollusks plugged HPI oil coolers. Two pumps were required to be shutdown due to rising lubricating oil temperatures.
215	HPI	Pump	Lubrication	Maintenance	Environmental	Internal to Component	1991	Failure to Run	Partial	HPI pump lube oil cooler leaks. Degraded tubes.

Item	System	Segment	Piece Part	Discovery Method	Coupling Factor	Proximate Cause	Year	Failure Mode	Degree of Failure	Description
216	HPI	Pump	Lubrication	Maintenance	Maintenance	Operational/ Human Error	1991	Failure to Run	Partial	Following an overhaul of the HPI pumps. Too much oil flow led to excessive oil leakage, which would have failed HPI pumps before end of mission.
217	HPI	Pump	Lubrication	Maintenance	Environmental	Internal to Component	1980	Failure to Run	Partial	HPI pump lube oil cooler with tube leak allowed water into oil reservoir.
218	HPI	Pump	Lubrication	Maintenance	Environmental	Internal to Component	1986	Failure to Run	Almost Complete	Clams/sludge fouling of lube oil cooler caused high temperature alarms on two HPI pumps.
219	HPI	Suction	I&C	Demand	Maintenance	Design/ Construction/ Manufacture/ Installation Inadequacy	1997	Failure to Run	Complete	HPI pumps fail due to operation with inadequate suction head. Two pumps damaged due to operation with inadequate suction, but all three system pumps were unavailable due to the loss of the suction source. Suction source level instrumentation was the cause.
220	HPI	Suction	I&C	Demand	Design	Other	1997	Failure to Run	Partial	Letdown storage tank reference leg not full, which gave erroneous indication of sufficient tank level. One HPI pump severely damaged, other pump not as damaged, and could have run. The root cause was a combination of a design weakness of a common reference leg for the Letdown storage tank level instruments and a leaking instrument fitting due to an inadequate work practice.
221	HPI	Suction	Piping	Demand	Environmental	External Environment	1984	Failure to Start	Complete	Boron solidification in the suction and gas binding of pumps led to the failure of all three safety injection pumps. Flushing procedures inadequate.
222	HPI	Suction	Piping	Demand	Design	Other	1982	Failure to Start	Complete	Hydrogen from the suction dampener got into suction piping and failed both CCPs.
223	HPI	Suction	Piping	Inspection	Design	Design/ Construction/ Manufacture/ Installation Inadequacy	1991	Failure to Start	Partial	Ultrasonic examination of the chemical and volume control system suction piping was performed. These examinations revealed voids in the alternate boration line and the gravity feed line from the boric acid storage tank.
224	HPI	Suction	Piping	Inspection	Quality	Design/ Construction/ Manufacture/ Installation Inadequacy	1988	Failure to Run	Partial	Vortex breakers had not been installed in the containment emergency sumps. Vortex breakers are required to be installed in the containment emergency sumps to prevent the formation of vortices which could adversely affect performance of safety injection pumps during the safety injection and containment spray systems were declared inoperable.
225	HPI	Suction	Piping	Inspection	Design	Design/ Construction/ Manufacture/ Installation Inadequacy	1988	Failure to Start	Partial	It was determined that various pipes of the safety injection system and chemical volume and control system collected or trapped gas which might affect the functions of these systems. There was a concern that the gas pockets may adversely effect pump operation. Voids were detected in some of the high head SI pump piping.
226	HPI	Suction	Piping	Inspection	Design	Design/ Construction/ Manufacture/ Installation Inadequacy	1990	Failure to Start	Partial	A quantity of gas was found in the centrifugal charging pump suction header that exceeded the maximum allowed gas volume. It was subsequently determined that hydrogen gas had been coming out of solution on both units and accumulating in the suction piping as a probable result of gas stripping by the CCP miniflow orifices. In addition, entrainment of hydrogen bubbles from the volume control tank to the CCP suction pipe may be a contributor as well.

Item	System	Segment	Piece Part	Discovery Method	Coupling Factor	Proximate Cause	Year	Failure Mode	Degree of Failure	Description
227	HPI	Suction	Piping	Inspection	Design	Design/ Construction/ Manufacture/ Installation Inadequacy	1988	Failure to Run	Partial	Ultrasonic examination of the chemical and volume control system suction piping was performed. These examinations revealed voids in the suction piping.
228	HPI	Suction	Strainer	Maintenance	Maintenance	Operational/ Human Error	1985	Failure to Run	Partial	Strainers found still installed in the suction piping of the high-pressure injection pumps was a condition not considered in the operating design. The strainers were found during maintenance to repair a slight flange leak. The strainers had been placed in the suction piping during construction and were to be in place during system flushing to prevent any debris from reaching the pumps. However, the strainers should have been removed after system flushing prior to functional testing
229	LCS	Driver	Breaker	Test	Quality	Design/ Construction/ Manufacture/ Installation Inadequacy	1980	Failure to Start	Complete	Relay extra contacts left connected during construction, prevented Core Spray pump start with emergency diesel generator breakers racked out.
230	RHR-B	Driver	Bearing	Test	Environmental	External Environment	1991	Failure to Run	Partial	Two LCI pumps were declared inoperable due to high motor vibration.
231	RHR-B	Driver	Breaker	Demand	Maintenance	Internal to Component	1987	Failure to Start	Partial	RHR pump breakers failed to close when operated remotely from the control room. It was found that the latch roller bearings and the cam follower bearing (internal piece parts of the breaker) were not operating correctly. This prevented the trip latch assembly from resetting and allowing the breaker to close.
232	RHR-B	Driver	Breaker	Maintenance	Maintenance	Operational/ Human Error	1990	Failure to Start	Partial	RHR pump breaker overcurrent trips out of calibration.
233	RHR-B	Driver	Breaker	Maintenance	Maintenance	Operational/ Human Error	1991	Failure to Start	Partial	While performing preventive maintenance calibration check on the protective relays for a residual heat removal pump motor 4kv breaker, it was found that all overcurrent relays for two pumps were out of calibration
234	RHR-B	Driver	Breaker	Test	Maintenance	Internal to Component	1997	Failure to Start	Partial	Breaker latch check switch failed on both pumps. Lack of lubrication.
235	RHR-B	Driver	Breaker	Test	Maintenance	Internal to Component	1986	Failure to Start	Partial	RHR pump circuit breakers failed during a start for testing. Bend switch and binding mechanism. Attributed to inadequate maintenance.
236	RHR-B	Driver	I&C	Test	Design	Other	1982	Failure to Start	Partial	A functional test revealed a sliding link in control room panel open. Further investigation revealed a total of four links open. These links, left open, negated all autostart capability of 2 of 4 RHR pumps. It could not be determined why these four links were open.
237	RHR-B	Driver	Supports	Inspection	Design	Design/ Construction/ Manufacture/ Installation Inadequacy	1986	Failure to Start	Partial	RHR motor internal supports were cracked due to stress and vibration. Design improvements were made.
238	RHR-B	Pump	Impeller/Wear Rings	Test	Maintenance	Internal to Component	1985	Failure to Start	Partial	The first pump failed to meet required flow rate. The second was drawing excessive amperage. Both conditions were attributed to worn internals.
239	RHR-B	Pump	Lubrication	Inspection	Maintenance	Internal to Component	1990	Failure to Run	Partial	Both pump motor oil coolers were leaking due to aging of components. The first case involved through wall corrosion and the pump was immediately removed from service. The second case was a packing leak.

Item	System	Segment	Piece Part	Discovery Method	Coupling Factor	Proximate Cause	Year	Failure Mode	Degree of Failure	Description
240	RHR-P	Driver	Bearing	Inspection	Maintenance	Operational/ Human Error	1988	Failure to Run	Partial	Residual heat removal pump motor upper bearing housings were observed to be leaking oil. The cause of the failure was attributed to a lack of sealant being applied and gasket installed after the last maintenance was performed on the motor bearing housing.
241	RHR-P	Driver	Breaker	Demand	Maintenance	Other	1987	Failure to Start	Complete	Two LPI pumps, when given a start signal, would not start. An ongoing investigation revealed the probable root cause of the event to be poor electrical contact of the breaker auxiliary stabs for the pumps.
242	RHR-P	Driver	Breaker	Inspection	Maintenance	Operational/ Human Error	1981	Failure to Start	Complete	All RHR pumps de-energized to replace RHR Relief valve. T.S. allows this condition for 1 hour. Operated in the mode in excess of 5 hours.
243	RHR-P	Driver	I&C	Inspection	Maintenance	Operational/ Human Error	1992	Failure to Start	Complete	Both trains of RHR were rendered inoperable for two minutes, while performing an operational readiness test surveillance procedure. The surveillance procedure required that the one RHR train pump be placed in pull to lock and the other train heat exchanger flow control valve throttled to 30-40% open. The procedure directed the operators to perform operations that resulted in both trains of RHR being inoperable
244	RHR-P	Driver	I&C	Inspection	Operational	Operational/ Human Error	1995	Failure to Start	Complete	The switches for the containment spray and recirculation pumps were in a trip pullout when the Technical Specifications and plant procedures required the pumps to be operable.
245	RHR-P	Driver	Lubrication	Demand	Design	Design/ Construction/ Manufacture/ Installation Inadequacy	2000	Failure to Run	Complete	Both RHR/LPI pumps fail to run due to improper oil in system. High bearing temperatures occurred when the pumps were operated. This was due to the wrong lube oil being used, which had too high a viscosity. Inadequate vendor design information resulted in the higher viscosity oil being used and additional exacerbating problems such as insufficient bearing clearances.
246	RHR-P	Pump	Casing	Test	Maintenance	Operational/ Human Error	1989	Failure to Start	Complete	Both loops of the residual heat removal system were declared inoperable due to gas binding of both RHR pumps. The gas binding was caused by entry of nitrogen gas into the reactor coolant system from accumulator. The root cause of this event has been attributed to personnel error. Personnel did not comply with the specific requirements in the accumulator discharge check valve full flow test procedure due to inattention to detail.
247	RHR-P	Pump	Packing/Seals	Inspection	Environmental	External Environment	1985	Failure to Start	Complete	Following a trip, water was found spraying from both low head safety injection pump wedge control rod seals. Both pumps were declared inoperable. Postulated failure on the seals was from a minor flow induced pressure transient.
248	RHR-P	Suction	Piping	Demand	Design	Other	1982	Failure to Run	Complete	RHR Suction lost due to erroneous RCS level while draining the RCS.
249	RHR-P	Suction	Piping	Demand	Operational	Operational/ Human Error	1984	Failure to Run	Complete	The control room operators started a second residual heat removal pump in preparation for removing the operating RHR pump from service. With both pumps running, flow became excessive for the half-loop condition causing cavitation and air binding of both pumps. To prevent recurrence the procedure which controls the operation of the RHR pumps has been changed to include specific instructions to stop the operating pump prior to starting the second pump while at half-loop.
250	RHR-P	Suction	Piping	Demand	Design	Unknown	1983	Failure to Run	Complete	RHR pumps cavitated. Unable to repeat. Unknown cause.
251	RHR-P	Suction	Piping	Demand	Maintenance	Other	1986	Failure to Run	Complete	SDC pumps cavitated due to lowering RCS level. Level indication was in error.
252	RHR-P	Suction	Piping	Demand	Design	Other	1987	Failure to Run	Complete	RHR flow was interrupted when both RHR trains became inoperable due to air bound RHR pumps. The loss of RCS inventory to the reactor coolant drain tank due to a leaking valve caused a decrease in RCS water level, vortexing in the pumps' suction line, and air entrainment in the RHR pumps.

Item	System	Segment	Piece Part	Discovery Method	Coupling Factor	Proximate Cause	Year	Failure Mode	Degree of Failure	Description
253	RHR-P	Suction	Piping	Demand	Design	Operational/ Human Error	1984	Failure to Run	Almost Complete	On two occasions, RHR pumps cavitated due to low RCS level while draining the RCS.
254	RHR-P	Suction	Piping	Demand	Design	Operational/ Human Error	1985	Failure to Run	Complete	Swap over of RHR pumps resulted in both trains becoming inoperable due to air injection into the suction of the pumps. This required both pumps to be vented and required RCS level to be raised to prevent a possible recurrence of the vortex problem.
255	RHR-P	Suction	Piping	Demand	Maintenance	Other	1983	Failure to Run	Complete	The RHR pumps began to cavitate and eventually both pumps were stopped. The reactor vessel level gauge being used to provide an indication that the level was approaching the vessel flange level had been isolated (reactor coolant drain tank isolation valve had been closed during an attempt to reduce leakage). Additionally, procedures did not require visual monitoring of cavity level.
256	RHR-P	Suction	Piping	Demand	Design	Operational/ Human Error	1982	Failure to Run	Complete	Suction was lost to both RHR pumps. RHR flow was less than 3000 gpm and pump amps were fluctuating prior to taking corrective action. Each of these events appear to have been caused by a slow decrease in RCS level in conjunction with the vortex action at the pump suction.
257	RHR-P	Suction	Piping	Demand	Maintenance	Other	1981	Failure to Run	Complete	Temporary coolant loop level indicator showed level slowly increasing over a period of days. The system was periodically drained to maintain 65 percent indicated level. A RHR pump lost suction on reduction of actual level. The second pump was started, and lost suction. Indication drift was due to evaporation of reference leg.
258	RHR-P	Suction	Piping	Demand	Maintenance	Other	1980	Failure to Run	Complete	A complete loss of RHR flow occurred while plant operators were increasing RHR heat exchanger flow by closing down on the heat exchanger bypass valve.
259	RHR-P	Suction	Piping	Demand	Design	Operational/ Human Error	1980	Failure to Run	Complete	The reactor vessel vent eductor was in service in preparation for refueling with RHR operating. A low flow alarm was received and low flow and low motor current were indicated. A second pump was started and became air-bound. Putting the vessel vent eductor system into service was the root cause of the incident.
260	RHR-P	Suction	Piping	Demand	Operational	Operational/ Human Error	1980	Failure to Run	Complete	While attempting to increase RHR flow, the plant experienced a total loss of flow due to the pumps being air-bound. The pump was not vented when starting to increase flow. Operating procedures have been changed to have an operator present while changing flow in the RHR system. There have been losses of RHR flow in the past because the pumps were air-bound and methods are being investigated to improve the system design.
261	RHR-P	Suction	Piping	Demand	Design	Other	1982	Failure to Run	Complete	With unit drained to centerline of the nozzles, suction to both RHR pumps was lost for 36 minutes. Suction to the RHR pumps was lost because of ambiguous reactor coolant system level indication while drained to centerline of the nozzles. The actual RCS level was lower than observed.
262	RHR-P	Suction	Piping	Maintenance	Maintenance	Operational/ Human Error	1982	Failure to Run	Complete	Shutdown cooling was lost due to nitrogen intrusion because of backflushing a filter in the purification system.
263	RHR-P	Suction	Valve	Demand	Design	Other	1984	Failure to Run	Complete	Both RHR pumps were unable to operate due to the introduction of air into the RHR system. The incident occurred during the drain down of the RCS, when the level of the RCS was being monitored via a standpipe off the centerline of one of the RCS loops. The isolation valve to which the standpipe was attached became clogged sometime during the drain down and falsely indicated above centerline when in fact the level was below the RHR section line (below centerline).
264	SLC	Driver	Breaker	Maintenance	Maintenance	Internal to Component	1999	Failure to Start	Partial	SLC Pump Breakers Fail to pickup on degraded voltage test

Item	System	Segment	Piece Part	Discovery Method	Coupling Factor	Proximate Cause	Year	Failure Mode	Degree of Failure	Description
265	SLC	Driver	Breaker	Test	Design	Other	1986	Failure to Start	Complete	During a test, both Squib Valve Detonators shorted after firing and the Control Power Transformer fuse blew causing the pump motor trip. This was caused by improper fuse coordination between the Control Power Transformer fuse and the Squib Valve Detonator fuses. The redundant system's Squib Valve was also fired during this test, without running the associated pump, and one of the Squib Valve Detonators shorted after firing. The same fuse coordination problem existed for both systems.
266	SLC	Pump	Bearing	Inspection	Maintenance	Internal to Component	1989	Failure to Run	Partial	Standby Liquid Control pumps lost oil while running. Loose fittings and lack of thread sealant.
267	SLC	Pump	Lubrication	Test	Maintenance	Internal to Component	1992	Failure to Run	Partial	Standby Liquid Control pumps lost oil while running. The gasket between the crankcase frame cap and the gear housing cover was worn.
268	SLC	Pump	Packing/Seals	Inspection	Maintenance	Internal to Component	1988	Failure to Run	Partial	Standby Liquid Control pumps were observed to be leaking excessively at the packing. The failure of the packing was attributed to normal wear. Packing replaced.
269	SLC	Pump	Packing/Seals	Inspection	Maintenance	Internal to Component	1987	Failure to Run	Partial	Standby Liquid Control pumps were observed to be leaking excessively at the packing. The failure of the packing was attributed to normal wear. Packing adjusted.
270	SLC	Pump	Packing/Seals	Inspection	Maintenance	Internal to Component	1989	Failure to Run	Partial	Standby Liquid Control pumps were observed to be leaking profusely at the packing. The failure of the packing was attributed to normal wear.
271	SLC	Pump	Plunger/Cylinder	Inspection	Maintenance	Internal to Component	1989	Failure to Run	Partial	Standby Liquid Control pump seal was leaking excessively. The cause of this failure was normal wear of the plungers, packing, and head gaskets for the plungers (piece parts of the pump).
272	SLC	Suction	Tank	Test	Design	Design/ Construction/ Manufacture/ Installation Inadequacy	1991	Failure to Run	Complete	During the performance of a special test on Unit 1 to determine the available NPSH of the SLC pumps, the pumps began to cavitate unexpectedly. The SLC systems of both units were declared inoperable. The causes of this event are inadequate modification testing and an error in the original design calculations.
273	SLC	Suction	Tank	Test	Design	Design/ Construction/ Manufacture/ Installation Inadequacy	1991	Failure to Run	Complete	During the performance of a special test on the available NPSH of the SLC pumps, the pumps began to cavitate unexpectedly. The SLC systems of both units were declared inoperable. The causes of this event are inadequate modification testing and an error in the original design calculations.
274	SLC	Suction	Valve	Inspection	Maintenance	Operational/ Human Error	1991	Failure to Start	Partial	SLC pumps were potentially inoperable during part of test due to valve lineup.

NRC FORM 335 (2-89) NRCM 1102, 3201. 3202	U.S. NUCLEAR REGULATORY COMMISSION	1. REPORT NUMBER (Assigned by NRC, Add Vol., Supp., Rev., and Addendum Numbers, if any.) NUREG/CR-6819, Vol. 3 INEEL/EXT-99-00613				
BIBLIOGRAPHIC DATA SHEET (See Instructions on the reverse)		3. DATE REPORT PUBLISHED				
2. TITLE AND SUBTITLE Common-Cause Failure Event Insights Volume 3: Pumps		<table border="1" style="width: 100%;"> <tr> <td style="width: 50%; text-align: center;">MONTH</td> <td style="width: 50%; text-align: center;">YEAR</td> </tr> <tr> <td style="text-align: center;">May</td> <td style="text-align: center;">2003</td> </tr> </table>	MONTH	YEAR	May	2003
MONTH	YEAR					
May	2003					
5. AUTHOR(S) T. E. Wierman (INEEL), D.M. Rasmuson (U.S. NRC), N.B. Stockton (INEEL)		4. FIN OR GRANT NUMBER Y6194				
8. PERFORMING ORGANIZATION - NAME AND ADDRESS (If NRC, provide Division, Office or Region, U.S. Nuclear Regulatory Commission, and mailing address; if contractor, provide name and mailing address.) Idaho National Engineering and Environmental Laboratory Risk & Reliability Assessment Department P.O. Box 1625 Idaho Falls, ID 83415-3850		6. TYPE OF REPORT Technical				
9. SPONSORING ORGANIZATION - NAME AND ADDRESS (If NRC, type "Same as above"; If contractor, provide NRC Division, Office or Region, U.S. Nuclear Regulatory Commission, and mailing address.) Division of Risk Analysis and Applications Office of Nuclear Regulatory Research U.S. Nuclear Regulatory Commission Washington, DC 20555-0001		7. PERIOD COVERED (Inclusive Dates) 01/01/1980 - 12/31/2000				
10. SUPPLEMENTARY NOTES T.R. Wolf, NRC Project Manager						
11. ABSTRACT (200 words or less) This report documents a study performed on the set of common-cause failures (CCF) of pumps from 1980 to 2000. The data studied here were derived from the NRC CCF database, which is based on US commercial nuclear power plant event data. This report is the result of an in-depth review of the pump CCF data and presents several insights about the pump CCF data. The objective of this document is to look beyond the CCF parameter estimates that can be obtained from the CCF data to gain further understanding of why CCF events occur and what measures may be taken to prevent, or at least mitigate the effect of, pump CCF events. This report presents quantitative presentation of the pump CCF data and discussion of some engineering aspects of the pump events.						
12. KEY WORDS/DESCRIPTORS (List words or phrases that will assist researchers in locating the report.) Insights, Common Cause Failure, CCF database, probabilistic risk assessments, pumps, motor-driven pumps, turbine-driven pumps, Auxiliary Feedwater System, AFW, Containment Spray Recirculation, CSR, Emergency Service Water, ESW, High Pressure Coolant Injection, HCI, High Pressure Safety Injection, HPI, Residual Heat Removal, RHR, Low Pressure Core Spray, LCS, Reactor Core Isolation Cooling, RCI, Shutdown Cooling, SDC, Standby Liquid Control, SLC	13. AVAILABILITY STATEMENT Unlimited					
14. SECURITY CLASSIFICATION (This page) Unclassified (This report) Unclassified		15. NUMBER OF PAGES				
16. PRICE						

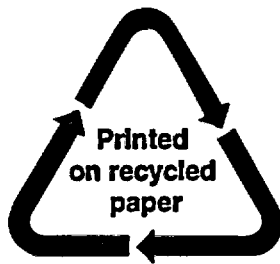

Federal Recycling Program

**UNITED STATES
NUCLEAR REGULATORY COMMISSION
WASHINGTON, DC 20555-0001**

OFFICIAL BUSINESS