

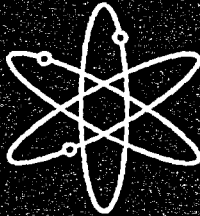

# Design of Erosion Protection for Long-Term Stabilization



## Final Report



U.S. Nuclear Regulatory Commission  
Office of Nuclear Material Safety and Safeguards  
Washington, DC 20555-0001



## AVAILABILITY OF REFERENCE MATERIALS IN NRC PUBLICATIONS

### NRC Reference Material

As of November 1999, you may electronically access NUREG-series publications and other NRC records at NRC's Public Electronic Reading Room at <http://www.nrc.gov/reading-rm.html>. Publicly released records include, to name a few, NUREG-series publications; *Federal Register* notices; applicant, licensee, and vendor documents and correspondence, NRC correspondence and internal memoranda, bulletins and information notices; inspection and investigative reports; licensee event reports; and Commission papers and their attachments.

NRC publications in the NUREG series, NRC regulations, and *Title 10, Energy*, in the Code of *Federal Regulations* may also be purchased from one of these two sources

- 1 The Superintendent of Documents  
U.S. Government Printing Office  
Mail Stop SSOP  
Washington, DC 20402-0001  
Internet: [bookstore.gpo.gov](http://bookstore.gpo.gov)  
Telephone 202-512-1800  
Fax: 202-512-2250
- 2 The National Technical Information Service  
Springfield, VA 22161-0002  
[www.ntis.gov](http://www.ntis.gov)  
1-800-553-6847 or, locally, 703-605-6000

A single copy of each NRC draft report for comment is available free, to the extent of supply, upon written request as follows.

Address Office of the Chief Information Officer,  
Reproduction and Distribution  
Services Section  
U.S. Nuclear Regulatory Commission  
Washington, DC 20555-0001  
E-mail: [DISTRIBUTION@nrc.gov](mailto:DISTRIBUTION@nrc.gov)  
Facsimile: 301-415-2289

Some publications in the NUREG series that are posted at NRC's Web site address <http://www.nrc.gov/reading-rm/doc-collections/nuregs> are updated periodically and may differ from the last printed version. Although references to material found on a Web site bear the date the material was accessed, the material available on the date cited may subsequently be removed from the site

### Non-NRC Reference Material

Documents available from public and special technical libraries include all open literature items, such as books, journal articles, and transactions, *Federal Register* notices, Federal and State legislation, and congressional reports. Such documents as theses, dissertations, foreign reports and translations, and non-NRC conference proceedings may be purchased from their sponsoring organization

Copies of industry codes and standards used in a substantive manner in the NRC regulatory process are maintained at—

The NRC Technical Library  
Two White Flint North  
11545 Rockville Pike  
Rockville, MD 20852-2738

These standards are available in the library for reference use by the public. Codes and standards are usually copyrighted and may be purchased from the originating organization or, if they are American National Standards, from—

American National Standards Institute  
11 West 42<sup>nd</sup> Street  
New York, NY 10036-8002  
[www.ansi.org](http://www.ansi.org)  
212-642-4900

Legally binding regulatory requirements are stated only in laws, NRC regulations; licenses, including technical specifications; or orders, not in NUREG-series publications. The views expressed in contractor-prepared publications in this series are not necessarily those of the NRC

The NUREG series comprises (1) technical and administrative reports and books prepared by the staff (NUREG-XXXX) or agency contractors (NUREG/CR-XXXX), (2) proceedings of conferences (NUREG/CP-XXXX), (3) reports resulting from international agreements (NUREG/IA-XXXX), (4) brochures (NUREG/BR-XXXX), and (5) compilations of legal decisions and orders of the Commission and Atomic and Safety Licensing Boards and of Directors' decisions under Section 2.206 of NRC's regulations (NUREG-0750)

---

---

# Design of Erosion Protection for Long-Term Stabilization

## Final Report

---

---

Manuscript Completed: August 2002

Date Published: September 2002

Prepared by:  
T.L. Johnson

Division of Fuel Cycle Safety and Safeguards  
Office of Nuclear Material Safety and Safeguards  
U.S. Nuclear Regulatory Commission  
Washington, DC 20555-0001



---

**NUREG-1623 has been reproduced  
from the best available copy.**

---



## ABSTRACT

This report presents a series of methods, guidelines, and procedures that are considered by the staff to be acceptable for designing erosion protection at uranium mill tailings sites in accordance with the requirements of 10 CFR Part 40, Appendix A (Title II sites) and 40 CFR Part 192 (Title I sites). These procedures are intended to assist licensees and applicants in developing erosion protection designs that will prevent radioactive releases due to erosion. Guidance is presented for the

design of soil covers, slopes and swales; sacrificial soil out slopes; and rock riprap for slopes, channels, aprons, outlets, and stream banks. Guidance is also presented for methods to determine sediment yield and for acceptable construction specifications. These recommended procedures are based upon the available literature, numerous laboratory testing programs, and extensive field experience.

# CONTENTS

	<i>Page</i>
<b>ABSTRACT</b> .....	iii
<b>EXECUTIVE SUMMARY</b> .....	ix
<b>ACKNOWLEDGMENTS</b> .....	xi
<b>1 INTRODUCTION</b> .....	1
<b>2 DISCUSSION</b> .....	5
2.1 <u>Design Objectives</u> .....	6
2.1.1 Tailings Releases Due to Erosion .....	6
2.1.2 Long-Term Stability .....	7
2.1.3 Design for Minimal Maintenance .....	7
2.1.4 Radon Release Limits .....	7
2.2 <u>Design Considerations</u> .....	8
2.2.1 Selection of Design Flood and Precipitation Event .....	8
2.2.1.1 Use of Statistically-Derived Floods .....	9
2.2.1.2 Use of PMF .....	10
2.2.2 Gully Erosion .....	11
2.2.3 Flow Concentrations and Drainage Network Development .....	12
2.2.4 Effectiveness of Vegetative Covers .....	12
2.2.5 Use of Permissible Velocity and Tractive Force Methods .....	13
2.2.6 Rock Durability .....	14
<b>3 REGULATORY CONSIDERATIONS</b> .....	15
3.1 <u>General Information Submittals</u> .....	17
3.2 <u>Cover Design Criteria</u> .....	17
3.2.1 Design of Stable Soil Covers for Top Slopes .....	17
3.2.2 Design of Swales on Unprotected Soil Slopes .....	18
3.2.3 Design of Stable Slopes Using Combinations of Soil Covers for Top Slopes and Rock Covers for Side Slopes .....	18
3.2.4 Design of Sacrificial Slopes .....	19
3.3 <u>Rock Cover Design Criteria</u> .....	19
3.3.1 Top and Side Slopes .....	19
3.3.2 Aprons / Diversion Channels / Ditch Outlets .....	20
3.3.3 Design of Rock Covers to Resist Flooding by Nearby Streams .....	20
3.3.4 Rock Durability .....	20
3.3.5 Rock Placement .....	21
<b>4 REFERENCES</b> .....	22

## CONTENTS (continued)

*Page*

### Appendices

A	Design of Soil Covers .....	A-i
B	Method For Determining Sacrificial Slope Requirements .....	B-i
C	Procedures For Determining If a 1000-Year Design Is Not Reasonably Achievable .....	C-i
D	Procedures For Designing Riprap Erosion Protection .....	D-i
E	Sediment Yield .....	E-i
F	Rock Placement Procedures for Erosion Protection .....	F-i

### Figures

B-1	Damage caused by gullyng .....	B-2
B-2	Damage caused by gullyng .....	B-3
B-3	Flume used in gully studies .....	B-5
B-4	Three types of embankment geometry .....	B-6
B-5	Schematic of typical waste impoundment .....	B-7
B-6	Photograph of launching riprap flume test .....	B-9
B-7	Plan and profile view of rock launching application .....	B-19
D-1	Flume test for determining riprap failure flows .....	D-2
D-2	Sandstone ruin near Blanding, Utah .....	D-27
D-3	Sandstone ruin near Durango, Colorado .....	D-27

## CONTENTS (continued)

	<i>Page</i>
E-1 Example of sheet and rill erosion .....	E-18
E-2 Example of rill and gully erosion .....	E-20
E-3 Alluvial fan deposit in a diversion channel .....	E-22
F-1 Poorly placed riprap .....	F-13
F-2 Marginally placed riprap .....	F-14
F-3 Marginally placed riprap .....	F-14
F-4 Well-placed riprap .....	F-15
F-5 Well-placed riprap in diversion channel .....	F-16

### Tables

D-1 Scoring Criteria for Determining Rock Quality .....	D-30
E-1 Long-term sediment yield calculated by the flow-duration sediment-rating curve method .....	E-5
E-2 Power equations for total bed sediment discharge in sand- and fine-gravel-bed streams .....	E-7
E-3 Range of parameters for the Simons-Li-Fullerton method .....	E-9
E-4 Settling velocities in mm/s .....	E-13
E-5 Example of sub-watershed characteristics .....	E-16
E-6 Sediment yield calculations by sub-watersheds and tributaries .....	E-17
F-1 Quality and gradation tests .....	F-3
F-2 Scoring criteria for determining rock quality. ....	F-4
F-3 Riprap gradation .....	F-6
F-4 Bedding gradation .....	F-7

## EXECUTIVE SUMMARY

In designing erosion protection for uranium mill tailings sites, licensees and applicants must meet the requirements of 10 CFR Part 40, Appendix A for Title II (active) sites and 40 CFR Part 192 for Title I (inactive) sites. These criteria establish broad design objectives for long-term protection of uranium mill tailings and specific design objectives considered to be applicable to the design of erosion protection. These objectives include: (1) preventing radioactive releases due to erosion; (2) providing long-term stability; (3) designing for minimal maintenance; and (4) meeting radon release limits.

In meeting the design objectives established by the regulations and standards, the design of erosion protection can be significantly affected by several natural phenomena and should take into consideration the following: (1) selection of an appropriate design basis flood or rainfall event; (2) control of gully initiation and gully development; (3) the occurrence of flow concentrations and drainage network development; (4) the questionable effectiveness of vegetation in arid areas; (5) appropriate use of permissible velocity and tractive force methods; and (6) long-term durability of rock erosion protection.

Erosion protection designs are acceptable if licensees and applicants can demonstrate that the requirements of 10 CFR Part 40, Appendix A and 40 CFR Part 192 are met. This guidance describes technical analyses and design approaches that will be used by the staff in its reviews and are acceptable in demonstrating compliance with these regulations and standards. Acceptable design options include: (1) designing soil covers and soil slopes to be stable; (2) designing combinations of stable soil slopes and rock-protected slopes; (3) designing

rock-protected slopes; (4) designing soil slopes that permit controlled gullying or gullying of limited extent; and (5) designing slopes that do not meet primary long-term stability requirements, but can be justified as alternatives that provide equivalent protection in accordance with applicable regulations. There may also be other acceptable design options that are developed by licensees; such designs will be considered by the staff on a case-by-case basis.

Design methods for the aforementioned options have been developed by the NRC staff and are included in this document. Each method is discussed in detail, and a technical basis is provided, including appropriate references. Specific design and calculation procedures for implementing each option are also provided, including illustrative examples. General recommendations are discussed, along with any limitations that are inherent in the calculation methods or in the design assumptions.

This document is intended to provide guidance in designing erosion protection; it has not been developed to provide guidance in other areas, such as groundwater protection or radon barrier design. However, the design of erosion protection is closely linked to the performance of the design in other areas, such as infiltration and slope-stability. An overall systems approach is needed in completing a total reclamation plan.

Appendix A provides guidance on the design of soil covers. Specific methods are discussed for designing stable soil slopes and swales.

Appendix B provides guidance on the design of soil slopes that permit gullying of limited extent. Specific methods are provided to

design sacrificial soil outslopes where no tailings are placed directly under the soil cover. This method can be used when licensees can justify that designing for 1,000 years is not reasonably achievable.

Appendix C discusses general documentation procedures that should be followed in justifying that designing for 1,000 years is not reasonably achievable.

Appendix D provides guidance on the design of rock riprap erosion protection. Specific procedures are discussed for designing riprap for top and side slopes, diversion channels, aprons and channel outlets, and the banks of large streams. Procedures are also provided

for evaluating the quality of riprap to be used as erosion protection and for oversizing of marginal-quality rock.

Appendix E provides guidance for estimating sediment yield from drainage areas and slopes that discharge to drainage channels. Procedures are provided to determine the amounts and fate of sediment that could deposit in the drainage system and potentially reduce flow capacity.

Appendix F provides examples of acceptable construction specifications for rock testing and placement.

## ACKNOWLEDGMENTS

The NRC staff gratefully acknowledges the significant contribution made to this report by the staff at Colorado State University. Specific detailed design procedures were developed by Dr. Steven R. Abt, Dr. Pierre Julien, and Christopher Thorton.

## ABBREVIATIONS

ACE	U.S. Army Corps of Engineers
ASCE	American Society of Civil Engineers
ASTM	American Society of Testing & Materials
AWRA	American Water Resources Association
BTP	Branch Technical Position
CFR	Code of Federal Regulations
DOI	U.S. Department of the Interior
EPA	U.S. Environmental Protection Agency
FSTP	Final Staff Technical Position
HEC	Hydrologic Engineering Center
MPV	Maximum Permissible Velocities
MUSLE	Modified Universal Soil Loss Equation
NRC	U.S. Nuclear Regulatory Commission
ORNL	Oak Ridge National Laboratory
OWDC	Office of Water Data Coordination
PMF	Probable Maximum Flood
PMP	Probable Maximum Precipitation
QA/QC	Quality Assurance/Quality Control
RUSLE	Revised Universal Soil Loss Equation
SCS	Soil Conservation Service
SDMP	Site Decommissioning Management Plan
SPF	Standard Project Flood
UMTRCA	Uranium Mill Tailings Radiation Control Act
USBR	U.S. Bureau of Reclamation
USDA	U.S. Department of Agriculture
USDOT	U.S. Department of Transportation
USGS	U.S. Geological Survey
USLE	Universal Soil Loss Equation
WES	U.S. Army Engineer Waterways Experiment Station



# DESIGN OF EROSION PROTECTION FOR LONG-TERM STABILIZATION

## 1 INTRODUCTION

In 1990, the staff published its Final Staff Technical Position (FSTP), "Design of Erosion Protection Covers for Stabilization of Uranium Mill Tailings Sites." This FSTP provided extensive criteria for the design of soil and rock covers to be used at uranium mill tailings sites. Public comments were received, and the staff incorporated those comments in the FSTP, as applicable. During the past ten years, the staff has sponsored extensive research and technical assistance to improve many of the design approaches recommended in the FSTP. In addition, significant experience has been gained through the actual construction of about 20 uranium mill sites in the Title I and Title II programs.

The purpose of this document is to update the FSTP and provide design guidance based on the best technical approaches currently available for long-term stabilization for a period of 200 to 1,000 years. The guidance is written specifically for reclamation of uranium mill sites, but the staff considers that it can be used for any application where long-term stability for similar time periods is required. For the stabilization of low-level waste, using the requirements of 10 CFR 61, this guidance can be used to design hydraulic structures and erosion protection for the required stability period of 500 years. For the stabilization of sites currently listed in the Site Decommissioning Management Plan (SDMP), some of the requirements of 10 CFR Part 40 have been adopted, and this guidance can be used to meet a suggested stabilization period of approximately 1,000 years. For convenience, this document repeatedly refers to uranium mills and the design criteria of 10 CFR Part 40, Appendix A; however, the design criteria can be applied in most cases where the required stability periods are similar.

This document attempts to provide a balanced approach to tailings and/or waste management, considering that designing erosion protection to be stable for 1,000 years is a problem that has not been previously addressed in the engineering community. There will always be some question regarding the appropriateness of any procedure to provide adequate engineering designs for long time periods. Very little data are available in the technical literature to provide guidance in designing for long-term stability. Much of the information that is available has been developed by technical assistance contractors, where the efforts were funded by the Nuclear Regulatory Commission (NRC) staff. This guidance attempts to use this information wherever possible, and to adapt standard engineering practice in similar areas, such as channel design, to the design of protective covers.

### 1.1 Regulatory Basis

Criteria and standards for environmental protection may be found in the Uranium Mill Tailings Radiation Control Act (UMTRCA) of 1978 (PL 95-604) and 10 CFR Section 20.106, "Radioactivity in Effluents to Unrestricted Areas." In 1983, the U. S. Environmental Protection Agency (EPA) established standards (40 CFR Part 192) for the final stabilization of uranium mill tailings for inactive (Title I) and active (Title II) sites. In 1980, the United States Nuclear Regulatory Commission (NRC) promulgated regulations (10 CFR Part 40, Appendix A) for active sites and later

revised Appendix A to conform to the standards in 40 CFR Part 192. These standards and regulations establish the criteria to be met in providing long-term stabilization.

These regulations also prescribe criteria for control of tailings. For the purpose of this guidance, control of tailings is defined as providing an adequate design to protect against exposure or erosion of the tailings. To help licensees and applicants meet Federal guidelines, this document provides design practices that the NRC staff has found acceptable for providing such protection for 200 to 1,000 years and focuses principally on the design of tailings covers to provide that protection.

## 1.2 Technical Considerations

Presently, very little information exists on designing covers to remain effective for 1,000 years. Numerous examples can be cited where covers for protection of tailings embankments and other applications have experienced significant erosion over relatively short periods (less than 50 years). Experience with reclamation of coal-mining projects, for example, indicates that it is usually necessary to provide relatively flat slopes to maintain overall site stability (Wells and Jercinovic, 1983).

Because of the basic lack of long-term experience and technical information in this area, this guidance attempts to adapt standard hydraulic design methods and empirical data to the design of erosion protection covers. The design methods discussed here are based either on: (1) the use of documented hydraulic procedures that are generally applicable in any area of hydraulic design; (2) the use of procedures developed by technical assistance contractors specifically for long-term stability applications; or (3) procedures that have actually been used for stabilization at various uranium mill sites in the Title I and Title II programs.

Methods exist for providing stable channel sections and are widely used to design drainage channels that do not erode when subjected to design flood flows. The staff considers that the hydraulic design principles and practices associated with channel design are generally appropriate for designing stable slopes that will not erode; these principles have been used in the development of the design criteria presented in this document.

Channel design procedures were selected because, in reality, a slope can be treated as nothing more than a wide channel. These procedures are widely used and based on the concept of providing channel sections that will not erode when subjected to design flows. These channel design methods typically produce relatively flat slopes, which would appear to produce conservative designs. However, it should be recognized that channel design relies on maintenance to assure that the channel section remains in its design configuration. The regulations and standards do not permit maintenance to be performed to achieve the required stability period. However, channel design procedures have been verified by the actual field performance of agricultural drainage channels, and there is reasonable assurance that providing a stable slope (designed in accordance with stable channel procedures) will serve its intended function without maintenance. Hence, a balancing of design verification vs. the lack of maintenance results in the use of a balanced approach in designing erosion protection covers to last for 1,000 years without reliance on routine maintenance.

The staff recognized the limited availability of applied design and evaluation procedures for assessing the stability of waste material covers. Since the publication of the FSTP (NRC, 1990), the NRC staff has supported the development of several new design and evaluation procedures: estimating gully intrusion into reclaimed impoundments; sizing of rock in transition aprons at the toe of embankments; assessing rock durability; allowing sandstone materials to be considered for erosion protection; and estimating rock launching requirements. From these studies, guidance has been developed that assists the staff and designers in providing a more comprehensive evaluation of long-term stability.

To analyze the susceptibility of the release of waste materials to gully erosion, Pauley (1993) and Abt et al. (1995a, 1995b) performed a series of flume and field studies to quantify the maximum depth of gully incision, width of gully, and locations of the maximum incision. These studies resulted in a comprehensive procedure that allows the designer to determine the extent of erosion that may occur in relation to the waste materials and to provide a cover design that will insure cover and waste material stability.

In 1994, Abt et al. investigated the potential of using sandstone materials for erosion protection in arid and semiarid regions. The study included the sampling and testing of sandstone materials from 16 archaeological sites throughout the western U.S. and assessing the long-term stability of sandstone. The findings indicated: (1) that sandstone materials have been documented to remain effective for over 1,000 years in arid and semiarid regions; (2) that some sandstone materials can meet the NRC rock durability standards; (3) certain durability testing yields questionable results for rock durability evaluations; and (4) that sandstones may be considered for erosion protection in regions where higher quality rock is not available.

One method investigated to protect against gully incision was to launch stone from the cover into the incision. Abt et al. (1997) reported the findings of a series of pilot laboratory tests in which criteria were developed for sizing the rock and the rock cover thickness to launch and adequately armor the incision. Another study presented design guidance for sizing stone placed at the transitional toe of an embankment (Abt et al., 1998).

Other investigations have included the development of procedures for estimating drainage areas on steep uniform slopes (Abt et al., 1995c) and runoff from compound slopes (Thornton et al., 1997). Methods have also been developed for sizing riprap in steep channels often associated with reclamation sites (Johnson and Abt, 1998). These efforts represent a portion of the technology that has been recently developed to enhance the design and evaluation process for stabilizing waste sites.

### 1.3 Procedural Considerations

This document makes no attempt to limit engineering judgment and practical experience from consideration in developing a reclamation design. Although the guidance may not specifically address a particular design option, the use of such options is not precluded. The guidance generally recommends a method or reference for determining a particular design parameter; however, these recommendations are not intended to preclude the use of other methods, if such methods can be reasonably justified. It is important to understand that this guidance only discusses several of many

possible design methods and criteria that are acceptable to the staff in meeting long-term stability requirements.

It is important to understand that the criteria and guidance presented in this document are not requirements. Any licensee or designer has the option of using other design approaches. Simply because the staff has not developed or recommended other design approaches for long-term stability does not mean that such approaches do not exist. The staff encourages designers to use their technical resources to develop and discover alternate design approaches to tailings stabilization. The staff welcomes the opportunity to meet with designers and to discuss these alternate approaches.

This guidance updates and replaces the FSTP (in its entirety) and the Branch Technical Position WM-8201, "Hydrologic Design Criteria for Tailings Retention Systems," with regard to long-term stabilization. However, it should be noted that some portions of WM-8201 remain applicable, particularly with regard to operational aspects of tailings dam design. Those operational aspects have not been incorporated into this guidance.

## 2 DISCUSSION

In determining the level of protection needed to stabilize uranium mill tailings, the NRC staff has developed procedures that conform to standard engineering practice and that provide for flexibility and engineering judgment. Most important, the design procedures are developed so that the requirements of 40 CFR Part 192 and 10 CFR Part 40, Appendix A, are met. Any perception of a lack of flexibility in these procedures may be based on an incorrect perception that the criteria in this document are requirements. The staff believes that a wide range of options and design approaches can be developed using the design criteria provided. For example, this document provides criteria for a wide range of soil types, soil grain sizes, and soil cohesion. An infinite number of combinations of cover strategies can be developed using the criteria and methods in this document. Only a few of these options were developed in detail.

During the development of tailings reclamation standards and regulations, the argument concerning the relative risks of tailings reclamation failure was addressed many times by the NRC staff and other agencies. EPA (1983), for example, has stated;

"The radiation hazard from tailings lasts for many hundreds of thousands of years, and some nonradioactive toxic chemicals persist indefinitely. The hazard from uranium tailings therefore must be viewed in two ways. In themselves, the tailings pose a present hazard to human health. Beyond this immediate, but generally limited, health threat, the tailings are vulnerable to human misuse and to dispersal by natural forces for an essentially indefinite period. In the long run, this threat of expanded, indefinite contamination overshadows the present dangers to public health. The Congressional report accompanying the Act expressed the view that the methods used for remedial actions should not be effective for only a short time. It stated: 'The committee believes that uranium mill tailings should be treated . . . in accordance with the substantial hazard they will present until long after existing institutions can be expected to last in their present forms,' and that 'The Committee does not want to visit this problem again with additional aid. The remedial action must be done right the first time.' (H. R. Rep. No. 1480, 95th Cong., 2nd Sess., Pt. I, p. 17, and Pt. II, p. 40 (1978).)

We consider the single most-important goal of control to be effective isolation and stabilization of tailings for as long a period of time as is reasonably feasible, because tailings will remain hazardous for hundreds of thousands of years . . ."

Based on the documented conclusions reached by Congress, EPA, and the NRC staff, it is apparent that the risks associated with tailings are not insignificant. Rather, tailings present a threat to public health and safety, particularly when viewed as a long-term problem. Standards and regulations have been promulgated to control this long-term problem. It has been concluded and documented that the risks are significant enough to warrant a design that will last for a period of 1,000 years, without the need for maintenance. This guidance merely documents acceptable ways to meet the stated requirements. It is not the intention of the staff to revisit the basis for these requirements in this guidance. However, the staff is aware of other technical viewpoints. Various distinguished

technical experts have presented arguments that indicate that the risks from tailings are not great, when compared with dangerous activities in life. A basis may exist for modifying the standards and regulations, but until that is done, the staff is not in a position to do anything other than ensuring that these requirements are met.

The selection of many input parameters to various models can sometimes be subjective and will need to be based largely on engineering judgment. This guidance generally recommends a method or a reference for determining a particular design parameter; however, these recommendations are not intended to preclude the use of other methods, if such methods can be reasonably justified. Where there are large ranges in the value of a particular parameter, or where a parameter cannot be well-defined, or is not well-known, guidance is provided in the NRC Management Position (NRC, 1989):

"In evaluating the magnitude of a design basis event or the acceptability of particular design criteria, reasonable ranges and distributions of parameters should be used. For well-known or accepted parameters with narrow empirical distributions or very narrow ranges, expected values should be used as appropriate. For less-well-known parameters, such as those estimated based on little empirical data or with broad distributions, conservative values should be chosen from within the observed distributions or estimated range. Extreme values should not be used. In any case, there should be a reasonable and defensible technical basis for the choice of a design basis event or design criteria."

The staff intends to accept reasonable values of input parameters where licensees and applicants can justify their use. Otherwise, reasonably conservative values will be needed.

## 2.1 Design Objectives

This guidance is based on several major design objectives for long-term stabilization of uranium mill tailings that are established in 40 CFR Part 192 for Title I sites and in 10 CFR Part 40, Appendix A, for Title II sites. These objectives can be summarized as follows: (1) prevent radioactive releases caused by wind and water erosion; (2) provide long-term stability; (3) require minimal maintenance to assure performance; and (4) provide sufficient protection to limit radioactive releases.

### 2.1.1 Tailings Releases Due to Erosion

Criteria for minimizing dispersion of radioactive tailings, with emphasis placed on isolation of tailings and protection against natural phenomena, are established in 40 CFR Part 192 and 10 CFR Part 40, Appendix A. Specifically, 40 CFR 192.02 and 10 CFR Part 40, Appendix A, Criterion 6, require that control methods be designed to limit radioactive tailings releases to specified levels.

The NRC staff has concluded that prevention of releases due to erosion was an important consideration in the development of both 40 CFR Part 192 and 10 CFR Part 40, Appendix A. Therefore, it becomes very important to assess the forces associated with surface water erosion, to

design flood protection measures for appropriately severe flood conditions, and to minimize the potential for erosion and release of radioactive materials.

### 2.1.2 Long-Term Stability

As required by 40 CFR 192.02 and 10 CFR Part 40, Appendix A, Criterion 6, stabilization designs must provide reasonable assurance of control of radiological hazards for a 1,000-year period, to the extent practicable, but in any case, for a minimum 200-year period. The NRC staff has concluded that the risks from tailings can be accommodated by a design standard that requires that there be reasonable assurance that the tailings remain stable for a period of 1,000 (or at least 200) years, preferably with reliance placed on passive controls (such as earth and rock covers), rather than routine maintenance.

### 2.1.3 Design for Minimal Maintenance

Criteria for tailings stabilization with minimal reliance placed on active maintenance, are established in 40 CFR Part 192 and 10 CFR Part 40, Appendix A, Criteria 1 and 12. Criterion 1 of 10 CFR Part 40, Appendix A specifically states that: "Tailings should be disposed of in a manner [such] that no active maintenance is required to preserve conditions of the site." Criterion 12 states that: "The final disposition of tailings or wastes at milling sites should be such that ongoing active maintenance is not necessary to preserve isolation."

It is evident that remedial action designs are intended to last for a long time, without the need for active maintenance. Therefore, in accordance with regulatory requirements, the NRC staff has concluded that the goal of any design for long-term stabilization should be to provide overall site stability for very long time periods, with no reliance placed on active maintenance.

For the purposes of this guidance, active maintenance is defined as any maintenance that is needed to assure that the design will meet specified longevity requirements. Such maintenance includes even minor maintenance, such as the addition of soil to small rills and gullies. The question that must be answered is whether the longevity is dependent on the maintenance. If it is necessary to repair gullies, for example, to prevent their growth and ultimate erosion into tailings, then that maintenance is considered to be active maintenance.

### 2.1.4 Radon Release Limits

Titles 40 CFR 192.02 and 10 CFR Part 40, Appendix A, require that earthen covers be placed over tailings at the end of milling operations to limit releases of radon-222 to not more than an average of 20 picocuries per square meter per second (pCi/m s), when averaged over the entire surface of the disposal site and over at least a one-year period, for the control period of 200 to 1,000 years. Before placement of the cover, radon release rates are calculated in designing the protective covers and barriers for uranium mill tailings. Additionally, recent regulations promulgated under the Clean Air Act require that release rates be directly measured following placement of the protective barriers.

Depending on the selected design configuration, it could be argued that some gullying and exposure of tailings would be permissible under this portion of the regulations. It should be emphasized, however, that if tailings are exposed and eroded, the extent of exposure, erosion, and spread of contamination would be very difficult to assess, thus making a determination of radiological releases very difficult. This also inevitably would lead to a loss of control, as previously defined. EPA standards and NRC regulations require that the disposal strategy be designed to maintain control for 1,000 years. Further, such exposure would not seem to meet other portions of the regulations, which suggest that long-term stability and isolation of tailings are primary goals. Therefore, the NRC staff has concluded that tailings erosion should be controlled and that exposure of tailings should be prevented to the extent practicable by the design of the protective cover.

## 2.2 Design Considerations

Several long-term stability investigations (Nelson et al., 1983; Young et al., 1982; Lindsey et al., 1982; and Beedlow, 1984) have verified EPA's conclusion that the most disruptive natural phenomena affecting long-term stabilization are likely to be wind and water erosion. These authors also discuss important considerations that must be factored into the overall reclamation plan. The staff has concluded that the considerations that will have the most impact on the design of erosion protection include: (1) selection of a proper design flood or precipitation event; (2) analysis of long-term erosion caused by gullying; (3) effects of flow concentrations and drainage network development, if a stable slope is not provided; (4) the questionable effectiveness of vegetated covers in many arid areas; (5) design approaches using the concept of permissible velocity; and (6) rock durability and capability to resist weathering effects.

### 2.2.1 Selection of Design Flood and Precipitation Event

As previously discussed, the most disruptive natural phenomena affecting long-term tailings stabilization are likely to be wind erosion and water erosion. These studies have also indicated that wind and water erosion can be mitigated by a cover of reasonable thickness and that the design of the protective cover will normally be controlled by the precipitation or flood event. Therefore, the selection of the design flood event assumes major importance in the overall reclamation plan.

In general engineering practice, selection of a design flood event must take into consideration the level of risk associated with that event. However, level of risk is difficult to quantify and is very site-specific. In setting the standards contained in 40 CFR Part 192, the Environmental Protection Agency (EPA) has attempted to quantify the risks associated with uranium mill tailings by requiring that control and stabilization will ensure, to the extent reasonably achievable, an effective life of 1,000 years, and in any case, at least 200 years. EPA has stated (EPA, 1983)

"... tailings are vulnerable to human misuse and to dispersal by natural forces for an essentially indefinite period. In the long run, this threat of expanded, indefinite contamination overshadows the present dangers to public health."

It is apparent to the NRC staff that the standards were established because there are substantial long-term risks that must be considered from the standpoint of public health and safety. EPA further



concluded that the risks from tailings could be accommodated by a design standard that requires that there be reasonable assurance that the tailings remain stable for a period of 1,000 years, with reliance placed on passive controls (such as earth and rock covers), rather than routine maintenance.

Based on several reviews of remedial action plans, the NRC staff has found that the regulations and standards may be subject to different interpretations, especially with regard to computation and development of the design flood. The NRC staff has reviewed design flood computations using both statistical data and deterministic data. In general, use of statistical data to produce flood estimates has been found to be less appropriate than deterministic computations.

#### 2.2.1.1 Use of Statistically-Derived Floods

Design floods are sometimes identified in terms of a recurrence interval, based on the probability of occurrence. The probability of occurrence is the probability that the flood will be equaled or exceeded in a given year and is equal to the inverse of the recurrence interval. For example, a 100-year flood has a probability of occurrence of 1/100, or 0.01 for any particular year.

One misconception that often occurs is equating the design period with the recurrence period of the design flood. It is often assumed that a 1,000-year flood would be the appropriate flood to assure stability for a 1,000-year design period. However, a 1,000-year flood has a probability of occurrence of about 63 percent during a 1,000-year period. The probability of such a flood not occurring would thus be about 37 percent. The return period of a flood for a given probability of nonconcurrency can also be calculated. For example, for a 1,000-year design and a 90 percent probability of nonconcurrency, the design flood would have a recurrence interval of approximately 10,000 years. Without discussing what probability constitutes reasonable assurance, it is clear that a design flood for a 1,000-year design life must have a return period of many thousands of years.

Furthermore, extrapolation of limited site-specific data bases of 100 years or less (which is the case for most, if not all, uranium mill sites) is not likely to produce meaningful estimates of floods with recurrence intervals of 1,000 years or more. The accuracy of flood data deteriorates for probabilities more rare than those defined by the period of record. This is due to the sampling error of the statistics from the data and the fact that the basic underlying distribution of flood data is not known exactly, especially for rare flood events.

Other procedures for estimating floods on a watershed can sometimes be used for evaluating rare flood flows. A comparison between flood and storm records at nearby hydrologically-similar watersheds will often expand the data base and aid in evaluating flood frequencies for a given watershed. The shorter the flood record and the more unusual a given flood event, the greater will be the need for such comparisons.

Paleoflood data may also be used to expand the data base associated with rare floods. Paleoflood hydrology is the study of past or ancient floods preserved in stream channels. Paleoflood data may be useful in providing estimates of the largest floods that have occurred in a river basin. Some floods leave distinctive deposits and landforms in and along stream channels, as well as botanic evidence. Slack-water deposits and flood-bar deposits are often used to estimate past flood levels.

In determining the reliability of various flood estimates, the NRC staff has used data on historic maximum flood flows in the United States (Crippen and Bue, 1977). In that publication, selected historic maximum flood discharges are plotted vs. drainage area, and then enveloped, based on regionalization of the flood data.

Examination of these data for several tailings sites has indicated that 1,000-year and 10,000-year discharges (calculated by extrapolation of historic data using standard statistical techniques) may be underestimated when additional data from nearby or adjoining watersheds are added to the data base. If one makes the assumption that the regionalized data are representative of the stream in question, some of the flood discharges may be grossly underestimated. Based on historical data, flood flows significantly greater than the extrapolated 1,000-year or 10,000-year flood flows, for example, have occurred many times in nearby drainage basins, sometimes on basins much smaller than the one in question. Based on qualitative comparisons of the data, it is very unlikely that flood flows of such recurrence intervals would be exceeded many times. One may conclude that the flood flow data bases available for many streams are not truly representative and that statistically-derived floods are generally inappropriate for designing for very long time periods.

#### 2.2.1.2 Use of PMF

An event that is commonly used for design purposes is the Probable Maximum Flood (PMF), which is based on the occurrence of the Probable Maximum Precipitation (PMP) over appropriate parts of a watershed. The PMF is defined (U.S. Army Corps of Engineers, 1966) as the hypothetical flood (peak discharge, volume, and hydrograph shape) that is considered to be the most severe reasonably possible, based on comprehensive hydrometeorological application of the PMP and other hydrologic factors favorable for maximum flood runoff, such as sequential storms and snowmelt. The PMP is the estimated depth of rainfall for a given duration, drainage area, and time of year for which there is virtually no risk of exceedance. The PMP approaches and approximates the maximum rainfall that is physically possible within the limits of contemporary hydrometeorological knowledge and techniques. The estimation of a PMP is based on the concept that there is a limit to the amount of water that an atmospheric column can hold. Because the PMF is based on limitations imposed in part by site-specific meteorological capacities, the PMF represents a limiting value and removes uncertainties associated with extrapolation of limited data bases to extremely long time periods. In view of these uncertainties, the NRC staff concludes that it is reasonable and prudent to use the PMF as the design flood, where reasonable assurance of non-exceedance for a time period of 1,000 years is desired.

However, it should be understood that estimating the PMF requires considerable judgment and experience. The degree of conservatism to be applied in estimating a PMF is often subject to considerable differences in interpretation, especially with regard to reasonable or appropriate values of model input parameters. The NRC staff has concluded that the intent of the regulations and standards will be met if certain conservatisms are considered in accounting for the limited quantitative data base currently available to document long-term degradation. Additional guidance and information are provided in the NRC Management Position (NRC, 1989) regarding selection of appropriate and reasonable design parameters where there is a limited data base, or where design parameters are not well-known.

In accordance with the guidance provided in Appendix C, other flood and precipitation events may be used for 1,000-year designs, if proper justification is provided showing reasonable assurance of non-exceedance during the 1,000-year design period. If a design period of less than 1,000 years (but at least 200 years) is used, events less severe than the PMF and PMP may also be used. In order to justify such lesser events, it must be shown that: (1) designing for the PMF and PMP is impracticable; (2) the design event is the most severe that can be practicably designed for; and (3) the design will be effective for at least 200 years. In addressing the third point, the minimum flood event that the staff will accept is the Standard Project Flood (SPF), as defined and discussed by the ACE (ACE, 1964), or the maximum regional flood of record (transposed to the site on a discharge per unit drainage area basis or based on paleoflood data), whichever is greater. In general, the SPF will have a magnitude of approximately 40 to 60 percent of the PMF (ACE, 1964). In areas where specific procedures for estimating a SPF have not been derived, the staff will accept 50 percent of a PMF as representing a SPF. Regional floods of record may be determined using references such as Crippen and Bue (1977).

It should be emphasized that the flood of record is often a substantial percentage (60 to 90 percent) of the PMF in many areas of the United States. If such a flow rate is applied in the design procedures, the resulting differences in soil cover slope or rock size are usually insignificant, because the calculation procedures to determine flow velocities are usually more sensitive to the magnitude of the slope than to the magnitude of the flood event.

### 2.2.2 Gully Erosion

A serious threat to stability at any given site is likely to be gully erosion resulting from concentration of runoff from local precipitation. To ensure long-term stability, it is important to control localized erosion and the formation of rills and gullies. Research performed for the NRC staff (Nelson et al., 1983) has demonstrated that if localized erosion and gullying occurs, damage to unprotected soil covers may occur rapidly, probably in a time period shorter than 200 years. Additionally, since gully development occurs more rapidly on immature surfaces (reclaimed impoundments are relatively recent additions to the normal landscape), it should be assumed that the reclaimed cover is more vulnerable to gully erosion than in-situ materials (Nelson et al., 1983). Therefore, a proposed cover design should ensure that stable slopes that minimize the potential for gully erosion are provided.

Gully erosion differs somewhat from other design considerations because gully growth and erosion will be cumulative and progressive with succeeding storms. Over a long period of time, the cumulative effects of smaller, more frequent flood events could exceed the effects of larger, less frequent events. All these events combined could erode an unstable slope in a manner that could expose or release tailings to the environment, before a stable slope is formed.

The NRC staff, therefore, considers that the best method for providing long-term stability is to provide permanent, stable slopes that prevent gully initiation during the occurrence of a single, very large, design event. By designing for such a large single event, it is expected that smaller, continual, and more frequent events will have little or no cumulative impact on stability, due to the overall flat slopes or large rock sizes necessitated by designing for the rare event.

### 2.2.3 Flow Concentrations and Drainage Network Development

It is unlikely that evenly-distributed sheet flow will occur from the top to the bottom of a slope. The flow concentration could be initiated by differential settlement of the cover or waste material, abnormal wind erosion, and/or random flow processes. Studies (Oak Ridge National Laboratory, 1987) performed for the NRC staff have indicated that areas of flow concentration will develop randomly even on carefully-placed and compacted slopes, due to normal flow processes and flow spreading. Such flow concentrations can result in the formation of rills and gullies, and eventually, a complete drainage network can be expected to form on unstable slopes (Schumm and Mosley, 1973; Ritter, 1978). Network development and the tendency of rills and streams to widen, deepen, extend their length, and capture other rills and streams are discussed by Ritter (1978) and by Shelton (1966).

Recognizing that drainage network development will eventually occur on unstable slopes, the NRC staff concludes that it is necessary to provide slopes that are flat enough or sufficiently protected to prevent the formation of extensive rills and gullies. Such slopes should be capable of providing protection against tailings exposure, assuming the development of a complete drainage network and the occurrences of many rainfall events to be expected over the design life of the cover system. Such phenomena should be considered and evaluated in the design of sacrificial slopes, as discussed in Appendix B.

It is expected that a significant increase in the drainage area could occur on an unstable slope over a long period of time. For that reason, any slopes that are designed to permit controlled gullying should be designed using a larger drainage area that would be initially expected. If a slope is designed to be stable, no significant increases in drainage area should be expected. However, it should be emphasized that only very gentle slopes may be assumed to be stable.

### 2.2.4 Effectiveness of Vegetative Covers

Vegetative covers reduce the potential for erosion because they protect the surface from raindrop impact, reduce the amount of water available for runoff because of evapotranspiration, and increase the surface roughness, which, in turn, decreases runoff velocity. Plant roots also help bind the soil and keep it in place. Evapotranspiration also reduces infiltration of water into the tailings.

Based on the results of several studies (Nelson et al., 1983; Lindsey et al., 1982; and Beedlow, 1982), it is unlikely that a vegetative cover for long-term erosion protection can be effective on steep embankment slopes in some arid portions of the western United States, where the natural vegetation cover is less than about 30 to 50 percent. However, self-sustaining vegetation may provide some amount of long-term stabilization in some semiarid to humid climates, provided that the slopes are sufficiently flat.

Several other studies (Beedlow, 1982; Voorhees, 1983; and Temple, 1987), indicate that significant erosion protection is afforded by vegetation only when the climate is capable of supporting a relatively dense growth of grasses. In general, semi-arid climates where only certain types of shrubs and forbs grow readily do not provide adequate vegetative cover. Many of the uranium mills are

located in these semi-arid sections of the western United States, where sustaining a vegetative cover over a long period of time may be questionable. Therefore, if licensees wish to take credit for vegetation, they need to substantiate that a vegetative cover will be sufficiently dense to be effective in minimizing erosion.

If revegetation is considered at any site, it should be based on the most current research and current practices in the site area. The vegetation species should be indigenous to the area, and provisions should be made to enhance growth during the initial growing season. Sufficient top soil should be placed over the radon cover, since the radon cover is usually compacted cohesive soil that may not be favorable for plant growth. Studies should be conducted to determine the capability of the vegetation to survive over long periods of time. Local experts should be consulted to determine appropriate vegetation species for a particular area and the local soil type. Other considerations, such as vegetation succession, droughts, and extreme climatic conditions should be evaluated to assess the ability of the vegetation to survive over long periods of time. Based on research performed for the NRC staff (Nelson et al., 1983), it is unlikely that the density of a vegetation cover will substantially exceed the density of naturally-occurring vegetation.

#### 2.2.5 Use of Permissible Velocity and Tractive Force Methods

Two methods are generally used for designing stable channels. These are the permissible velocity method and the tractive force (shear stress) method. Flow in an open channel is extremely complex and is influenced by many variables. Therefore, both of these methods should be considered in designing a stable channel.

The use of the method of permissible velocity has widespread use in the design of stable channels to prevent erosion. Such methods are well-documented by Chow (1959) and others in determining the maximum mean velocity that a particular channel section can withstand. Unfortunately, this method is sometimes misused to design a stable slope, because the method was intended to apply principally to irrigation and drainage channels, where flow depths are usually greater.

In an open channel, flow velocities vary vertically along the channel section. Generally, the maximum velocity occurs just below the free surface. The velocity decreases with depth, reaching a minimum value near the channel bottom. Consequently, the permissible velocity along the channel bottom is much less than the maximum mean velocities. In designing stable slopes and in considering flow on tailings pile slopes, the flow will generally be only several inches deep, and the flow velocity affecting the slope will be essentially equivalent to the velocity occurring along the top surface of flow. Therefore, the maximum permissible design velocity for shallow flows must be less than for flows occurring at greater depths. Chow (1959) provides reduction factors for the permissible velocity, based on the flow depth. It can be seen that the permissible velocity decreases noticeably at lower depths of flow. If Chow's data are extrapolated to a flow depth of several inches, the recommended reduction in permissible velocity is about 50 percent.

For the design of unprotected soil slopes with shallow flow depths, the staff recommends the use of the tractive force (or shear stress) method. In this method, the tractive force produced by the

flow is compared to the allowable tractive forces of the soil. Since the allowable tractive force is not dependent on the depth of flow, methods exist where this value can be directly determined or computed. Such methods are discussed by Temple et al. (1987) and in more general terms by Chow (1959). The calculated tractive force produced by the flow is easily computed, after the depth of flow has been determined. Further discussion and examples may be found in Appendix A.

For the design of vegetated (grassed) slopes, the staff recommends that the permissible velocity method be used to verify the adequacy of the design. In using this method, the selection of appropriate maximum permissible velocities and Manning's "n" values are of utmost importance. The staff recommends that guidance provided by Chow be used to determine these parameters. Chow provides recommended maximum permissible velocities for various types and densities of grass covers. The staff recommends that "n" values and permissible velocities for low vegetative retardance be used for design and that the permissible velocity also be further reduced for shallow flow depths, as previously discussed. Further discussion and examples may be found in Appendix A.

#### 2.2.6 Rock Durability

Because tailings and their covers must remain stable for long periods of time, cover protection such as rock must also survive natural weathering for that length of time. Considerable engineering judgment is necessary to develop rational engineering design alternatives when weathering of rock materials is a major consideration. Any rational design method to determine the size and thickness of cover protection should include the durability and weathering characteristics of the material over time.

The technical basis for using rock for long time periods is well developed. Jahns (1982) points out that many kinds of rocks are relatively resistant to weathering. Most of these more resistant rock types have long been used as construction materials, in monuments, or for decorative purposes, with varying degrees of success (Abt et al., 1994). However, it must be recognized that there are limitations associated with procedures that are used to assess rock performance for a 1,000-year period.

Determining the quality of riprap needed for long-term protection and stability can therefore be a somewhat difficult and subjective task. Very little design guidance is available to assess the degree of oversizing needed for a particular rock type to survive for long periods, based on its physical properties.

In assessing the long-term durability of erosion protection, the NRC staff has relied on the results of durability tests performed at several uranium mill sites and on information and analyses developed by technical assistance contractors, which provide methods for assessing rock oversizing requirements to meet long-term stability criteria. These procedures have also considered actual field data from several sites and have been modified to provide flexibility to meet construction requirements. These procedures are based on methods that have been demonstrated to be successful in actual construction practice.

### 3 REGULATORY CONSIDERATIONS

In accordance with 40 CFR 192, Subparts A, B, and C, and 10 CFR Part 40, Appendix A, the design of protective covers should provide reasonable assurance of long-term stability. The design should provide for control of tailings for 1,000 years, if reasonably achievable, but, in any case, for at least 200 years, without reliance on active maintenance.

Several methods are suggested by the staff for designing unprotected soil covers or soil covers with some vegetation, to prevent the development and inhibit the growth of gullies. These methods, illustrated in Appendix A to this guidance, are based on staff licensing and review experience and applicable hydraulic engineering principles. The computational procedures outlined in Appendix A were developed based on NRC staff experience with damage to erosion-protection structures during the occurrence of relatively minor storm events. Of necessity, these procedures attempt to account for the limited quantitative data base available to document long-term degradation and the questionable ability of vegetated soil covers to be effective in arid areas. Reasonable and conservative engineering judgment has been used, after evaluating the results of the various methods, to decide on the best estimate of the stable slope. In addition, methods are presented for the design of sacrificial soil slopes (Appendix B), for evaluation of feasibility of covers (Appendix C), for the design of riprap (Appendix D), for estimating site sediment yield (Appendix E), and for placing riprap (Appendix F).

The aforementioned design procedures are concerned only with surface water erosion. The additional soil cover needed to account for wind erosion or sheet erosion needs to be factored into the soil cover design. Procedures discussed by Nelson et al. (1986) may be used to determine the additional cover requirements.

In designing a protective cover, there are many options and design combinations that may be used. There are, in fact, an infinite number and variety of designs, and their selection will depend on site-specific conditions and phenomena. In general, however, cover designs fall into several broad categories. Based on NRC licensing experience with Title I and Title II sites, various options are normally employed to design cover systems:

- Option 1 Soil covers designed to be stable for 1,000 years.
- Option 2 Combinations of soil covers on the top slopes and rock-protected soil covers on the side slopes, both designed to be stable for 1,000 years.
- Option 3 Soil covers totally protected by a layer of rock riprap on both the top and side slopes.
- Option 4 Sacrificial soil covers designed to permit controlled erosion.
- Option 5 Designs that do not meet the stated requirement of 10 CFR Part 40, and are considered as alternatives that achieve equivalent protection.

The preferred options to design a cover system are Options 1, 2, and 3; such designs will be stable and will be effective for a 1,000-year period. Option 4 is not considered to be a preferred design option; this option should be used only when detailed justification can be provided to demonstrate that designing for time periods greater than 200 years is not reasonably achievable.

Option 1 can generally be implemented only for very short slope lengths, or where significant credit can be given for vegetation. Discussion of unprotected stable soil covers may be found in Section 3.2.1; design guidance may be found in Appendix A.

Option 2 may be implemented if Option 1 is impractical due to pile height, size, or topography. In these cases, combinations of stable soil covers over flatter areas and rock-protected soil covers over steeper areas should be considered as possibilities in meeting the 1,000-year stability requirement. Discussion of combination covers may be found in Section 3.2.2. Design guidance may be found in Appendix A (for soil top slopes) and in Appendix D (for rock-protected side slopes).

Option 3 may be implemented in those cases where rock riprap is available. The placement of riprap protected covers is considered by the NRC staff to be the most effective method of assuring long-term stability. Discussion of riprap cover design is provided in Section 3.3. Design guidance may be found in Appendix D.

Option 4 may be implemented if providing combined stable soil top slopes and/or rock-protected side slopes is not practicable or is excessively costly. In such cases, sacrificial side slopes that permit controlled erosion may be acceptable, provided that the tailings will not be exposed or eroded. In general, this option should be considered only when tailings are not placed directly under the soil slope. The staff considers that such designs should be adopted only when licensees can provide detailed justification that designing for a 1,000-year stability period is not reasonably achievable and that designing for a 200-year period is the only reasonably achievable design option. Discussion of sacrificial side slopes, where tailings are not placed under embankment out slopes, may be found in Section 3.2.4; design guidance may be found in Appendix B. Discussion of the detailed justification needed to demonstrate that other designs are not reasonably achievable may be found in Appendix C.

Option 5 may be implemented in those cases where designing for a 200-year stability period is not reasonably achievable. If active maintenance, for example, is proposed as an alternative to the designs suggested above, such an approach will be found acceptable if the following criteria are met:

- (1) The maintenance approach must achieve an equivalent level of stabilization and containment and protection of public health, safety, and the environment;
- (2) The licensee must demonstrate a site specific need for the use of active maintenance and an economic benefit; and
- (3) The licensee must provide funding for the maintenance by increasing the amount of the required surety.



### 3.1 General Information Submittals

For the reclamation design selected, the following engineering data, information, and analyses should be provided for NRC staff review:

- a. Drainage areas of principal watercourses and drainage features
- b. Drainage basin characteristics, including soil types and characteristics, vegetative cover, local topography, flood plains, morphometry, and surficial and bedrock geology
- c. Maps and/or aerial photographs showing the site location and the upstream drainage areas
- d. Site geomorphological characteristics, including slopes, gradients, and processes
- e. Drawings and photographs of site features
- f. Location, depth, and dimensions of tailings and proposed cover, including results of subsurface explorations
- g. Physical and engineering properties of the proposed cover and radon suppression cover, tailings, and foundation materials, including results of laboratory and field tests, including dispersivity and permeability data of the radon cover
- h. Radiological parameters, including activity and emanating coefficient of contaminated material
- i. As applicable, pertinent construction records of the tailings retention system, including as-built drawings, construction QA/QC tests, construction problems encountered, any alterations or modifications that were necessary, and the history of needed maintenance and repair
- j. Principal design assumptions, calculations, and analyses for the design, including hydrologic and hydraulic analyses and models

### 3.2 Cover Design Criteria

The following are specific design considerations and criteria for developing cover designs.

#### 3.2.1 Design of Stable Soil Covers for Top Slopes

In general, it is expected that soil covers will be practical only on the flatter top slopes of a reclaimed impoundment. Exceptions may occur to this generalization, where slope lengths are very short, where significant credit can be given for vegetation (such as in the eastern United States, where good grass covers can be established); where rocky soils are available to increase average soil particle

size, and thus increase stability; or where some gullying of sacrificial slopes is acceptable. As discussed in Appendix A, in situations where licensees can substantiate that vegetation will be self-sustaining and sufficiently dense to reduce erosion potential, procedures such as those presented in Appendix A may be used to evaluate the design of the vegetated cover. It is unlikely that soil covers alone will be capable of providing long-term stability on slopes steeper than a few percent in the semi-arid western United States. Therefore, it will usually be necessary to provide stable soil slopes on the top and rock-protected (or sacrificial) slopes on the steeper sides of a reclaimed pile.

Soil slopes of a reclaimed tailings impoundment should be designed to be stable and thus inhibit the initiation, development, and growth of gullies. The slopes should be designed for an occurrence of the most severe precipitation event reasonably expected during the design life; because of the problems associated with extrapolating limited data bases using statistical methods, the staff concludes that use of the PMP/PMF will provide an acceptable design basis. The slope design should also consider the effects of flow concentrations and drainage network development, because such phenomena cannot be realistically discounted, even on perfectly-constructed slopes (Schumm and Mosley, 1973; Ritter, 1978). Specifically, soil covers are acceptable if they are designed to be stable and if the shear stresses and flow velocities produced by concentrated runoff from design-basis flood events are less than the allowable shear stresses and velocities of the soils. Appendix A provides additional discussion and methods for designing stable soil covers.

In addition to having a slope that is shown by analyses to be stable, the soil cover should be designed to be thick enough so that there is reasonable assurance that tailings will not be exposed and that radiological criteria will be met, considering the combined effects of wind erosion, sheet erosion, and minor rill and gully erosion. Acceptable methods of analysis are provided by Nelson et al. (1986) for computing the additional soil cover needed to protect against wind erosion and sheet erosion; such methods include the Modified Universal Soil Loss Equation (for sheet erosion and minor rill erosion) and the Chepil Equation (for wind erosion).

For any locations on the tailings pile where the required criteria cannot be met using soil covers alone (such as the steeper side slopes), use of rock riprap will provide an acceptable design. Guidance for design of rock covers is provided in Appendix D.

### 3.2.2 Design of Swales on Unprotected Soil Slopes

In some cases, it may be possible to direct concentrated surface runoff over unprotected soil covers, using very flat ditches or swales. The NRC staff recommends that both the tractive force and permissible velocity methods be used to determine the size and maximum slope of such swales. The design of swales using these methods is relatively straightforward, and design guidance is presented in Appendix A.

### 3.2.3 Design of Stable Slopes Using Combinations of Soil Covers for Top Slopes and Rock Covers for Side Slopes

In most cases where slope lengths are relatively long and where vegetation cannot be shown to be effective, the stable soil cover required over a large area of tailings may need to be so flat that

it is not economically feasible to construct. In those cases, it may be acceptable to use combinations of soil covers and rock covers to provide the necessary protection. A hypothetical example of such a design may be to provide soil slopes of 0.5 percent on the top of a 300-foot-long pile for the first 250 ft and 20 percent riprap-protected side slopes for the remaining 50 ft. If such a composite design is implemented, methods discussed in Appendix A may be used to design the stable top slopes; methods discussed in Appendix D may be used to estimate the side slope rock requirements.

### 3.2.4 Design of Sacrificial Slopes

The design of soil slopes that permit gullying of limited extent may also be acceptable if the total soil cover provided will prevent the release of radioactive materials. The basis for such designs is that more stable levels and slopes will eventually be formed during the selected design life, but the amount of cover material provided will prevent gully intrusion into the tailings.

If tailings or waste materials are not placed directly under the soil cover outslopes, the construction of such sacrificial soil outslopes may provide an acceptable design. In such cases, the outslope may erode, but sufficient cover protection will be provided so that tailings will not be exposed or eroded during the design life. Guidance for designing sacrificial outslopes is presented in Appendix B.

In general, the design procedures discussed in Appendix B are intended to apply for only a 200-year period, or less. Due to the lack of an extensive data base associated with gully erosion, sacrificial soil slopes that are expected to erode should be used only when the 1,000-year stability criterion cannot be reasonably met. In using this approach, licensees should clearly justify and document with pertinent analyses that designing for a 1,000-year stability period is not reasonably achievable and that the resulting design will be effective for a minimum of 200 years. A step-by-step procedure for providing such justification may be found in Appendix C.

## 3.3 Rock Cover Design Criteria

All portions of a reclaimed tailings impoundment should be designed to resist the effects of local intense precipitation. In many cases, where it is not feasible to provide unprotected soil covers or where vegetation is not likely to be effective, a rock riprap layer may be necessary to provide the required protection. The rock may be needed to protect: (1) the top and side slopes; (2) aprons, diversion channels, and channel outlets; and (3) other design features from the effects of offsite flooding. In arid portions of the western United States, where the effectiveness of vegetation may be questionable, the use of a rock cover of acceptable durability is considered by the NRC staff to be the preferred method for satisfying the long-term stability requirements of 40 CFR Part 192 and 10 CFR Part 40, Appendix A.

### 3.3.1 Top and Side Slopes

The design of rock riprap for the top and side slopes of a tailings pile is simple and relatively straightforward. Acceptable analytical methods for designing a rock cover to resist erosion and

prevent gullying on the top and side slopes of a remediated embankment may be found in Appendix D.

### 3.3.2 Aprons / Diversion Channels / Ditch Outlets

Erosion protection for those locations where man-made stabilized slopes and channels meet natural slopes and channels should be designed to prevent headcutting and/or lateral erosion into the tailings. Flow velocities produced by runoff on man-made slopes could also cause erosion of the natural soils just beyond the toe of the stabilized slope, particularly if the slopes are steep. It is necessary, therefore, to provide a transition section that serves to reduce velocities to non-erosive levels. These flatter transition sections, normally called aprons, also need to be designed to prevent upstream headcutting by existing gullies in the area of the pile toe. The apron or transition area may be designed using design procedures similar to these for other engineered slopes. Guidance for designing aprons and toes may be found in Appendix D. Acceptable methods for designing erosion protection of channel outlets may also be found in Appendix D.

In addition, the channels should be designed to store or flush the expected volume of sediment that will enter the channels over a 1000-year period. Methods for analyzing sediment yield may be found in Appendix E.

### 3.3.3 Design of Rock Covers to Resist Flooding by Nearby Streams

The slopes of a reclaimed tailings pile or waste disposal facility should be protected from the effects of flooding of nearby watercourses. If the pile is located near a large stream, and if floods impinge on the pile slopes with erosive velocities, rock riprap erosion protection should be provided to resist the stream velocities and shear stresses produced by such flood events.

Regulatory Guide 1.59, "Design Basis Floods for Nuclear Power Plants," provides guidance for the determination of peak flood flows for large streams. HEC-2 (ACE, 1976) may be used to compute water surface profiles and local velocities. Guidance for the design of riprap for river and channel banks is discussed by Walters (1982), the ACE (1970), and Nelson et al. (1986).

### 3.3.4 Rock Durability

Frequently, situations arise where it may be necessary to use marginal-quality rock for erosion protection. These situations may arise in areas of the western United States where many uranium mill sites are located. Where rock riprap is proposed for erosion protection, investigations should be conducted to identify sources of available rock within a reasonable distance of the site. The suitability of these rocks as protective covers should then be assessed by laboratory tests, to determine the physical characteristics of the rocks. Several durability tests, such as those listed in Appendix D, should be performed to determine if the rock is suitable for use as riprap.

Where rock of good quality is reasonably available, the riprap design should incorporate this rock. In those cases where only rock of marginal quality is reasonably available, increases in the average rock size and riprap layer thickness may be necessary. An acceptable procedure for evaluating rock quality and for using marginal-quality rock may be found in Appendix D. If rock

does not meet the minimum quality ratings established in the scoring procedure in Appendix D, it will generally not be acceptable. However, the use of such rock will be considered on a case-by-case basis, if no other rock is available, or if no other design options are reasonably feasible. In particular, marginal-quality rock may be suitable in arid climates.

### 3.3.5 Rock Placement

It has been the experience of the NRC staff that it may be difficult to achieve proper placement of riprap layers, particularly when the rock sizes are large relative to the layer thickness. It is relatively easy to adequately place a 12-inch layer of 2-inch rocks, for example, but it is much more difficult to place a 12-inch layer of 8-inch rocks.

The proper placement of rock riprap in ditches and on embankment slopes is important to dissipate the energy associated with flowing water and thus prevent erosion that could lead to gullying and exposure of contaminated material. In general, such proper placement is created by providing a relatively uniform thickness of rock at the specified gradation. Examples of testing procedures and construction specifications that have actually produced acceptable placement of riprap at various sites are presented in Appendix F.

#### 4 REFERENCES

- American Meteorological Society (AMS), *Glossary of Meteorology*, Boston, MA, 1959.
- Atomic Energy Act of 1954, as amended, Public Law 83-703.
- Beedlow, P. A., "Designing Vegetation Covers for Long-Term Stabilization of Uranium Mill Tailings," NUREG/CR-3674 (PNL-4986), U.S. Nuclear Regulatory Commission, Washington, DC, 1984.
- Beedlow, P. A., McShane, M. C. and Cadwell, L. L., "Revegetation/Rock Cover for Stabilization of Inactive Uranium Mill Tailings Disposal Sites: A Status Report," PNL-4328, UMT-0210, Pacific Northwest Laboratory, Richland, WA, 1982.
- Chow, V. T., *Open-Channel Hydraulics*, McGraw-Hill Book Company, Inc., New York, NY, 1959.
- Copeland, O. L., "Land Use and Ecological Factors in Relation to Sediment Yields," Proceedings, Federal Inter-Agency Sedimentation Conference, U. S. Department of Agriculture (USDA), Washington, DC, 1963.
- Crippen, J. R. and Bue, C. D., "Maximum Floodflows in the Conterminous United States," U.S. Geological Survey Water Supply Paper 1887, Washington, DC, 1977.
- Jahns, R. H., "Weathering and Long-Term Durability of Rock Masses," Appendix to Long-Term Survivability of Riprap for Armoring Uranium Mill Tailings and Covers: A Literature Review, NUREG/CR-2642 (PNL-4225), U.S. Nuclear Regulatory Commission, Washington, DC, 1982.
- Johnson, T. L. and Abt, S. R., "Design of Channel Riprap Using Overtopping Flow Methods." Proceedings of the First Federal Interagency Hydrologic Modeling Conference, Las Vegas, NV, April 19-23, 1998.
- Lindsey, C. G., Long, L. W. and Begej, C. W., "Long-Term Survivability of Riprap for Armoring Uranium Mill Tailings and Covers: Literature Review," NUREG/CR-2642 (PNL-4225), U.S. Nuclear Regulatory Commission, Washington, DC, 1982.
- Nelson, J. D., Volpe, R. L., Wardwell, R. E., Schumm, S. H., and Staub, W. P., "Design Considerations for Long-Term Stabilization of Uranium Mill Tailings Impoundments," NUREG/CR-3397 (ORNL-5979), U.S. Nuclear Regulatory Commission, Washington, DC, 1983.
- Nelson, J. D., Abt, S. R., Volpe, R. L., vanZyl, D., Hinkle, N. E., and Staub, W. P., "Methodologies for Evaluating Long-Term Stabilization Designs of Uranium Mill Tailing Impoundments," NUREG/CR-4620, 1986.

Oak Ridge National Laboratory (ORNL), "Development of Riprap Design Criteria by Riprap Testing in Flumes, Phase I," NUREG/CR-4651, May 1987.

Office of Water Data Coordination (OWDC), "Feasibility of Assigning a Probability to the Probable Maximum Flood," June 1986.

Ritter, D. F., **Process Geomorphology**, William C. Brown Co., Dubuque, IA, 1978.

Schumm, S. A., and Mosley, M. P., Editors, **Slope Morphology**, Dowden, Hutchinson and Ross, Inc., Stroudsburg, PA, 1973.

Shelton, J. S., **Geology Illustrated**, W. H. Freeman and Co., San Francisco, CA, 1966.

Temple, D. M., Robinson, K. M., Ahring, R. M., and Davis, A. G., U.S. Department of Agriculture (USDA), "Stability Design of Grass-Lined Open Channels," Agriculture Handbook Number 667, 1987.

Uranium Mill Tailings Radiation Control Act of 1978, PL 95-604, 1978.

U. S. Army Corps of Engineers, Hydrologic Engineering Center, "Water Surface Profiles, HEC-2," continuously updated and revised.

U.S. Army Corps of Engineers, "Standard Project Flood Determinations, EM 1110-2-1411, March 1952 (reprinted June 1964).

U.S. Army Corps of Engineers, "Policies and Procedures Pertaining to Determination of Spillway Capacities and Freeboard Allowances for Dams," EC 1110-2-27, August 1966.

U.S. Army Corps of Engineers, "Hydraulic Design of Flood Control Channels," EM 1110-2-1601, Office of the Chief of Engineers, Washington, DC, 1970.

U.S. Nuclear Regulatory Commission (NRC), Regulatory Guide 1.59, "Design Basis Floods for Nuclear Power Plants, 1979.

U.S. Nuclear Regulatory Commission, "Standard Review Plan for UMTRCA Title I Mill Tailings Remedial Action Plans," October 1985.

U.S. Nuclear Regulatory Commission, "Technical Position on Information Needs to Demonstrate Compliance with EPA's Proposed Groundwater Protection Standards in 40 CFR Part 192, Subparts A-C," June 1988.

U.S. Nuclear Regulatory Commission, "Staff Technical Position on Testing and Inspection Plans During Construction of DOE's Remedial Action at Inactive Uranium Mill Tailings Sites," Revision 2, January 1989.

- U.S. Nuclear Regulatory Commission, Regulatory Guide 3.64, "Calculation of Radon Flux Attenuation by Earthen Uranium Mill Tailings Covers," June 1989.
- U.S. Nuclear Regulatory Commission, "Uranium Mill Tailings Management Position," 1989.
- U.S. Nuclear Regulatory Commission, "Hydrologic Design Criteria for Tailings Retention Systems," Staff Technical Position WM-8201, Uranium Recovery Licensing Branch, Washington, DC, 1982.
- U.S. Nuclear Regulatory Commission, Final Staff Technical Position (FSTP) "Design of Erosion Protection Covers for Stabilization of Uranium Mill Tailings Sites," August 1990.
- Voorhees, L. D. Sale, M. J., Webb, J. W., and Mulholland, P. J., "Guidance for Disposal of Uranium Mill Tailings: Long-Term Stabilization of Earthen Cover Materials," NUREG/CR-3199, ORNL/TM-8685, Oak Ridge National Laboratory, Oak Ridge, TN, 1983.
- Walters, W. H., "Rock Riprap Design Methods and Their Applicability to Long-Term Protection of Uranium Mill Tailings Impoundments," NUREG/CR-2684 (PNL-4252), U.S. Nuclear Regulatory Commission, Washington, DC, 1982.
- Wells, S. G., and Jercinovic, D. E., "Applications of Geomorphology to Surface Coal-Mining Reclamation, Northwestern New Mexico," Chaco Canyon Country, American Geomorphological Field Group, 1983.
- Young, J. K., Long, L. W. and Reils, J. W., "Environmental Factors Affecting Long-Term Stabilization of Radon Suppression Covers for Uranium Mill Tailings," NUREG/CR-2564 (PNL-4193), U.S. Nuclear Regulatory Commission, Washington, DC, 1982.



**APPENDIX A**  
**DESIGN OF SOIL COVERS**

**CONTENTS**

	<i>Page</i>
<b>1 INTRODUCTION</b> .....	A-1
<b>2 DESIGN OF UNPROTECTED SOIL COVERS</b> .....	A-1
2.1 <u>Technical Basis</u> .....	A-1
2.1.1 Horton/NRC Method .....	A-1
2.1.2 Permissible Velocity Method .....	A-3
2.2 <u>Procedures</u> .....	A-4
2.2.1 Unprotected Soil Cover .....	A-4
2.2.2 Vegetated Soil Cover .....	A-5
2.3 <u>Recommendations</u> .....	A-6
2.4 <u>Examples of Procedure Application</u> .....	A-6
2.4.1 Stable Slope of an Unprotected Soil .....	A-6
2.4.2 Stable Slope of a Vegetated Soil Cover .....	A-7
2.4.3 Stable Slope of a Rocky Soil .....	A-8
2.5 <u>Limitations</u> .....	A-9
<b>3 DESIGN OF UNPROTECTED SOIL SWALES</b> .....	A-10
3.1 <u>Technical Basis</u> .....	A-10
3.2 <u>Design Procedure</u> .....	A-10
3.3 <u>Recommendations</u> .....	A-10
3.4 <u>Example of Procedure Application</u> .....	A-11
3.5 <u>Limitations</u> .....	A-12
<b>4 REFERENCES</b> .....	A-12

## APPENDIX A

### SECTION 1

#### DESIGN OF SOIL COVERS

##### 1 INTRODUCTION

Because regulations require that tailings remain stable for very long periods, and because of the limited amount of performance data available for soil slopes, it is necessary to exercise caution in their design. Such designs should be based on the premises that: (1) unconcentrated sheet flow is not a realistic assumption, and there will always be some random flow spreading and/or flow concentrations as flow progresses down embankment side slopes; (2) phenomena such as differential settlement and wind erosion can cause uneven surfaces that provide pockets for erosion and preferential flow paths to occur on a slope; and (3) freezing/thawing of the soil cover can cause deterioration and damage (e.g., frost heave) to slopes, thus producing areas prone to the formation of concentrated flow.

The management position developed by the U. S. Nuclear Regulatory Commission (NRC) staff (NRC, 1989) provides guidance in the selection of the design flood and the level of conservatism needed in designing tailings covers. In general, the position calls for use of reasonable conservatism in those areas that are not well-understood; however, extremely conservative values of design parameters are not to be used. In those areas where the phenomena are well-understood or where the range of design parameters is relatively narrow, typical or average values may be used in design. For the design of soil covers, there are several design parameters that are not well-understood, such as flow concentrations, long-term effectiveness of vegetation as erosion protection, allowable stresses or velocities, roughness of the cover when flow depths are small, and other miscellaneous problems that could occur over a period of 1000 years.

The NRC staff has therefore concluded that the slope of a soil cover should be one that is stable and will: (1) minimize the potential for development and growth of a gully over a long period of time, assuming that flow concentrations occur; and (2) prevent the erosion of tailings due to gullying.

##### 2 DESIGN OF UNPROTECTED SOIL COVERS

###### 2.1 Technical Basis

###### 2.1.1 Horton/NRC Method

Horton (1945) determined that an area immune to erosion existed adjacent to a watershed divide. The distance from the watershed divide to the point down the slope at which erosion will occur was termed the critical distance,  $x_c$ . At this point the eroding force becomes equal to the soil resistance. The following expression was developed by Horton to determine the critical distance:

$$x_c = \frac{65 R^{5/3}}{q_s n f(S)^{5/3}} \quad (A-1)$$

where:

$x_c$  = critical distance, in ft

$q_s$  = runoff intensity, in inches/hour, corresponding to the computed time of concentration

$n$  = roughness factor

$R$  = soil resistance, lb/ft<sup>2</sup>

$f(S)$  = slope function =  $\frac{\sin x}{\tan^3 x}$

where:

$x$  = slope angle in degrees, measured from horizontal

If the following substitutions are made, the stable slope ( $S_s$ ) can be determined:

$S_s = \sin x = \tan x$ , for small values of slope;

$t = R$  = allowable shear stress (pounds per square foot);

$P = q_s$  = design precipitation intensity (inches/hour); and

$L = x_c$  = slope length (ft).

A flow concentration factor ( $F$ ) is used in the equation to account for imperfections in the slope and is multiplied by the rainfall intensity.

Therefore,

$$S_s^{7/6} = \frac{65(t)^{5/3}}{P L F n} \quad (A-2)$$

Equation A-2 may also be derived by simultaneous solution of the Manning Equation, the peak shear stress formula, and the Rational Formula.

Use of equation A-2 allows direct solution of the value of the stable slope necessary to prevent the initiation of gullyng. The slope thus determined represents the maximum slope that can be

provided to minimize the potential for gully initiation due to the occurrence of one single intense rainfall event, and thus should also minimize erosion due to a series of less intense storms to be expected over a period of 200 to 1000 years.

Temple et al. (1987) and Chow (1959) discuss methods for determining allowable shear stresses and recommend that the shear stress method be applied to design a stable section. The shear stress method is often used to assess the size and slope of channels needed to maintain stability. Data are available to estimate permissible shear stresses for various types of soils (Temple et al., 1987).

It is expected that the use of this method will result in relatively flat slopes for achieving long-term stability. Basic hydraulic design principles indicate that the resulting slopes are likely to be flat enough to achieve subcritical flow, even if small rills and channels are formed on the embankment slope. The staff concludes that the resulting subcritical flow regimes that are formed will generally not result in severe erosion of a tailings cover, even if a gully is formed, based on an examination of standard bed load equations and sediment transport models (Chow, 1959; Fullerton, 1983).

#### 2.1.2 Permissible Velocity Method

Use of the permissible velocity method is discussed in detail by Chow (1959). The method is widely used to design stable channel sections, both for cohesive and non-cohesive soils. However, there is a potential for misuse when applying this method to design stable slopes or any application other than channel design. If properly applied, there is no reason for rejecting its use. The most common misuse is the failure to reduce the permissible velocity if the depth of flow is relatively shallow (less than 3 ft). As stated by Chow:

"When other conditions are the same, a deeper channel will convey water at a higher mean velocity without erosion than a shallower one. This is probably because the scouring is caused primarily by the bottom velocities and, for the same mean velocity, the bottom velocities are greater in the shallower channel. . ."

It can be seen that reductions to the permissible mean channel velocity are needed to reflect the velocities that are to be used for slope designs, where the depths of flow are shallow. Chow has published correction factors, based on the depth of flow. Abt and Hogan (1990) have determined that such corrections are appropriate, based on an examination of the original data and based on hydraulic theory.

Additionally, based on examination of data from the Soil Conservation Service (SCS, 1984), the staff recommends that the maximum permissible velocity for grassed covers and channels be limited to about 2½ to 3 ft per second. This limit is necessary because no credit may be taken for active maintenance in designing for long-term stability. Further, SCS data suggest that maximum permissible velocities for most vegetation species, other than thick grasses, should be in this range.

## 2.2 Procedures

Procedures have been developed to (a) design a stable unprotected soil cover (or vegetated soil cover with no credit given for vegetation) using the allowable shear stress method, as modified and developed in the Horton/NRC Method and (b) design a stable vegetated section using the permissible velocity method for areas where vegetation can be effective. These procedures provide two acceptable methods for designing stable covers. It is recognized that in many cases, specific values of parameters may be difficult to justify. In those cases where licensees can justify values of individual parameters that depart from the values given by suggested references, the resulting designs will be considered on a case-by-case basis.

### 2.2.1 Unprotected Soil Cover

Step-by-step procedures for implementing the allowable shear stress method for an unprotected soil cover are presented below:

- Step 1. Determine maximum allowable shear stress for bare soil using procedures developed by Temple et al. (1987). The staff considers Temple's method to be an accurate method for determining shear stresses because it is related to the Unified Soil Classification System and can be applied for specific soil types and degrees of cohesiveness. In general, the Temple procedure for determining allowable shear stress is based primarily on the soil particle size and the soil cohesiveness. The amount of resistance for granular non-cohesive soils, including rocky soils, is principally a function of the  $D_{75}$  grain size, where the allowable tractive force is equal to  $0.4 \times D_{75}$  (Temple et al., 1987). For granular soils, the increase in shear resistance due to cohesiveness is minimal. For cohesive soils where the particle size is smaller, the amount of resistance is principally a function of the soil cohesiveness and not the particle size.
- Step 2. Determine slope and slope length to be considered, as developed in the preliminary reclamation design.
- Step 3. Determine flow concentration factor (F). Documentation of the occurrence of flow concentrations and the ability of an individual rock or soil particle to resist given flow rates is discussed further by Abt et al. (1987). The actual value of F will depend on several factors, including grading practices during cover construction, cover slope, and potential for differential settlement. The staff recommends a default value of 3, for most soil slopes; other values may be used, if properly justified.
- Step 4. Estimate Manning's "n" value using general procedures given by Temple et al. (1987); by Nelson et al. (1986); or by Chow (1959).
- Step 5. Determine the rainfall intensity using the procedures given by Nelson et al. (1986) and determine the peak runoff rate using the Rational Formula.

Step 6. Solve for stable slope, using the Horton/NRC equation. If the computed slope is different from that assumed, return to Step 2 with new values of slope and/or slope length.

### 2.2.2 Vegetated Soil Cover

Step 1. Maximum permissible velocities (MPVs) should be estimated using data developed by the U.S. Soil Conservation Service (SCS, 1984); or by Nelson et al., 1986). Based on these data, maximum MPVs should generally range from about 2½ to 3½ ft per second for any vegetation other than dense grasses. These velocities need to be further reduced, as discussed in Step 6.

Step 2. Determine slope and slope length.

Step 3. Determine flow concentration (F). See Step 3 in Section 2.2.1, above for additional information.

Step 4. Estimate Manning's "n" value using procedures recommended by Chow (1959, Table 7.6) for very low vegetal retardance (Fig. 7.14).

Step 5. Determine rainfall intensity and runoff rate using procedures discussed in Step 5 in Section 2.2.1.

Step 6. Determine the flow depth (y) by solving the Manning Equation for normal depth on a one-foot-wide strip. This equation can be solved directly in this case using the following derivation:

$$y^{5/3} = Qn / (1.486 S^{1/2}). \quad (A-3)$$

Step 7. Determine the permissible velocity for the slope, based on the computed depth of flow. Chow has developed correction factors that may be applied to determine the permissible velocity. The permissible velocity is multiplied by the following correction factors, depending on the depth of flow.

<u>Depth of Flow (ft)</u>	<u>Correction Factor</u>
3.0 or greater	1.0
1.9	0.9
1.0	0.8
0.65	0.7
0.4	0.6
0.25 or less	0.5

Step 8. For the assumed one-foot-wide strip, determine the actual flow velocity ( $V_a$ ) by dividing the discharge by the flow depth:

$$V_a = Q/y. \quad (A-4)$$

If this velocity is greater than the permissible velocity computed in Step 7, return to Step 2 with new values of slope and/or slope length.

### 2.3 Recommendations

Recommendations are discussed in Section 2.2, for various steps of the design procedure. Particular attention should be given to determining allowable shear stress values and permissible velocities, since these parameters are likely to be the most sensitive parameters in the calculations.

### 2.4 Examples of Procedure Application

#### 2.4.1 Stable Slope of an Unprotected Soil Cover

For a site located in northwest New Mexico with a slope length of 1,000 ft, the stable slope of an unprotected soil cover may be computed using the allowable shear stress method.

Step 1. The allowable shear stress is estimated using methods given by Temple et al. (1987). For a clay soil having a void ratio (e) of 0.5 and a plasticity index of 15, the allowable shear stress ( $t_a$ ) is computed using:

$$t_a = t_{ab} C_e^2, \quad (A-5)$$

where  $t_a$  = basic allowable shear stress (pounds per square foot),

$C_e$  = void ratio correction factor,

$$C_e = 1.38 - (0.373)(e) = 1.38 - (0.373)(.5) = 1.19 \quad (A-6)$$

$t_{ab}$  = 0.0966 (from Table 3.3, Temple (1987)),

$$t_a = (0.0966)(1.19)^2 = 0.14 \text{ lb/ft}^2.$$

Step 2. The slope length is assumed to be 1,000 ft. The slope magnitude is assumed to be 0.002.

Step 3. The flow concentration factor is assumed to be 3, assuming that uniform grading will be done during construction and that differential settlement has been shown to be insignificant.

Step 4. Manning's "n" value is estimated using Chow (1959). For a uniform weathered earth section (using normal values),

$$n = 0.025$$

Step 5. The rainfall intensity is estimated using the procedures given by Nelson et al. (1986). It is assumed that the intensity has been calculated to be 40 inches/hour, using this reference.

Step 6. The stable slope may be computed using the aforementioned NRC derivation of the Horton Equation:

$$(S_s)^{7/6} = (65)(.14)^{5/3} / (40)(1000)(3)(0.025) \quad (A-7)$$

$$S_s = 0.002 \text{ ft/ft.}$$

Since the stable slope is equal to the assumed slope, the design is acceptable.

#### 2.4.2 Stable Slope of a Vegetated Soil Cover

Step 1. The maximum permissible velocity (MPV) is estimated using SCS (1984) to be 3.0 ft per second, representing marginal vegetation cover, other than thick grasses.

Step 2. The slope length is assumed to be 1,000 ft and the slope is assumed to be .003

Step 3. F is assumed to be 3.

Step 4. Using Chow's (1959) relationships (Figs. 7-14) for very low vegetal retardance, a velocity equal to the MPV of 3, and an assumed depth of flow of 1.0 ft, VR is calculated to be 3 where (R = 1) and "n" is estimated to be .028.

Step 5. Rainfall intensity is assumed to have been calculated to be 40 inches/hr.

Q is computed using the Rational Formula:

$$Q = Fci A = (3)(1.0)(40)(1000)/43560$$

$$Q = 2.75 \text{ cfs/ft}$$

Step 6. The flow depth (y) is computed by



$$y^{5/3} = \frac{Qn}{1.4865^{1/2}}$$

$$y^{5/3} = \frac{(2.75)(.028)}{(1.486)(.003)^{1/2}}$$

$$y = 0.96 \text{ ft}$$

Step 7. For a depth of flow of 0.96 ft, the reduction factor is computed to be about 0.80. The permissible velocity for this depth of flow is

$$\text{MPV} = (0.80)(3.0) = 2.4 \text{ ft/sec}$$

Step 8. The actual flow velocity ( $V_a$ ) is

$$V_a = \frac{Q}{y} = 2.75/0.96$$

$$V_a = 2.86 \text{ ft/sec}$$

Since the actual velocity is greater than the permissible velocity, return to Step 2 with new values of slope.

#### 2.4.3 Stable Slope of a Rocky Soil Cover

It is proposed that a rocky soil will be provided to closely simulate naturally-occurring desert armor and desert pavement at a site in the semi-arid southwestern United States. Based on grain-size analysis, the rocky soil is found to have a  $D_{75}$  particle size of 1.0 inches. The rock in the soil also meets the minimum durability criteria given in Appendix D.

Step 1. The allowable shear stress is estimated using the procedures discussed by Temple et al. (1987):

$$t = 0.4 \times D_{75} \tag{A-12}$$

where  $D_{75}$  is the particle size in inches for which 75 percent is finer.

$$t = 0.4 (1.0) = 0.4 \text{ lb/ft}^2 \tag{A-13}$$

- Step 2. The slope length is assumed to be 1000 ft.
- Step 3. The flow concentration factor (F) is assumed to be 3.
- Step 4. Manning's "n" value is estimated to be 0.03, using typical values from Chow for rocky sections.
- Step 5. The rainfall intensity is assumed to be 40 inches/hour.
- Step 6. Using the Horton/NRC equation:

$$S_s^{7/6} = \frac{65 (t)^{5/3}}{P L F n} \quad (\text{A-14})$$

$$S_s^{7/6} = \frac{65 (0.4)^{5/3}}{(40)(1000)(3)(0.03)} \quad (\text{A-15})$$

$$S_s = 0.009$$

It should be noted that other procedures may be used to determine slope requirements for rocky soils, including the Safety Factors Method or the Corps of Engineers Method. The selection of the Horton/NRC Method is based on ease of calculation for this illustrative example. If the Safety Factors Method is used, for example, other input parameters can be easily derived and substituted into the equations.

## 2.5 Limitations

The procedure has been developed to assess the slope requirements for sheet flow on plane slopes, and assumes only minor channeling, gullying, or rilling. Such assumptions, while considered reasonable, may or may not represent actual conditions that are expected to occur. For example, it is possible that more severe flow concentrations could occur or that vegetation would not provide any significant protection in very arid areas. Conversely, it is possible that less severe flow concentrations would occur and that more credit could be given for vegetation. Therefore, the NRC staff concludes that the Horton Method provides a reasonable method for assuring that adequate protection will be provided for earthen covers over tailings, such that applicable criteria and regulations are met. Absolute protection against erosion is not provided by this or any other method; rather, the slope requirements computed in accordance with this method provide a broadly acceptable generic method for assuring tailings control, as defined above. The staff considers that the design parameters are within reasonable ranges, and that use of this equation will result in relatively flat slopes that will produce subcritical flow where channeling occurs.

The procedures discussed above are not applicable to dispersive soils, since such soils tend to be very unstable. Particular attention should be given to the selection of soil types, and dispersive soils should not be used.

### 3 DESIGN OF UNPROTECTED SOIL SWALES

In many cases, it may be desirable to limit slope lengths by constructing swales or interceptor ditches directly over tailings. These situations are extremely critical design cases for soil covers, since flow will be concentrated.

#### 3.1 Technical Basis

The design of unprotected soil swales is similar to the design of soil covers, except that the flow is concentrated, rather than sheet flow. The basis for the selection of the slope and shape of a swale is to prevent the occurrence of shear stresses that exceed the allowable shear stresses of the soil.

Swales provide a unique opportunity to use rocky soils. The use of rocky soils is a primary method to increase the allowable shear stress. The rock in the soil, however, should be of good quality and meet the minimum rock quality criteria given in Appendix D.

#### 3.2 Design Procedure

The procedures for the design of an unprotected swale are iterative in nature, but are relatively straightforward. Procedures exist to determine every critical design parameter. Following is a step-by-step procedure:

- Step 1. Assume a channel slope (S) and cross-section.
- Step 2. Determine the design flow rate (Q) using procedures discussed by Nelson et al. (1986).
- Step 3. Determine normal depth (y) in the swale, using Manning's Equation. For a swale of variable depth, y is the maximum depth in the cross-section.
- Step 4. Determine peak shear stress, equal to  $WyS$ , where  $W = 62.4$  pounds per cubic foot.
- Step 5. Determine allowable shear stress. (See Example 2.4.1, above.)
- Step 6. Compare the values of allowable and computed shear stress. If the computed stress exceeds the allowable, return to Step 1 with flatter values of slope or a larger cross-section, or both. It should be noted that rock-protected swales can also be provided. Procedures for the design of rock protection are discussed in Appendix D.

#### 3.3 Recommendations

The staff suggests that the following recommendations be implemented in the computational procedure, for most cases at typical uranium mill sites in the western United States:

1. Channel slopes should be as flat as practicable. Side slopes of swales should also be as flat as practicable. In fact, if the swale is placed perpendicular to the slope of the cover, critical forces may be produced by overland flow down the side slopes of the swale, and rock protection may be necessary to prevent erosion of the side slopes.
2. The peak flow rate should be determined similarly to the peak flow rates for any small drainage area. Guidance is given by Nelson et al. (1986).
3. In computing normal depth, Manning's "n" values appropriate for earth channels should be used. Guidance for selection of "n" values is provided by Chow (1959).
4. The shear force should be computed based on the peak shear stress (usually where the depth of flow is greatest), not the average shear stress, in the channel.
5. The allowable shear stress may be computed using procedures given by Temple et al. (1987) or by Chow (1959).

#### 3.4 Example of Procedure Application

It is proposed that an unprotected trapezoidal earth swale be constructed directly over tailings. The maximum drainage area (A) to the swale is 20 acres.

Step 1. As a first trial, assume the following:

The bottom width of the section is 25 ft, and the side slopes are 1V on 10H.

The bottom slope is 0.001.

Step 2. Using the Rational Formula (Nelson et al. 1986); a peak rainfall intensity of 40 inches/hour, computed using the same reference; and a runoff coefficient of 1.0, the design discharge (Q) is:

$$Q = CiA = (1.0) (40) (20) = 800 \text{ cfs.} \quad (\text{A-16})$$

Step 3. Solving the Manning Equation by trial and error with:

$$\begin{aligned} Q &= 800 \\ n &= 0.025 \\ S &= 0.001 \end{aligned}$$

Normal depth (y) = 3.81 ft.

Step 4. The maximum shear force (t) is computed by:

$$t = WyS = (62.4) (3.81) (0.001) = 0.24 \text{ lb/ft}^2. \quad (\text{A-17})$$

- Step 5. The allowable shear force is estimated to be  $0.1 \text{ lb/ft}^2$ , using procedures similar to those discussed in Section 2.4.
- Step 6. Since the shear force produced is larger than the allowable, return to Step 1 with new values of channel slope or channel cross-section, or both.

### 3.5 Limitations

This procedure assumes that the channel will be uniform in slope and in cross-section, throughout its entire length. If this is not the case, it may be necessary to perform backwater calculations to compute depths of flow in various portions of the channel. Such calculations can complicate this method of channel design. However, backwater calculations should be used where the slope or the cross-section changes, since normal depth is not likely to occur along the entire length of such a channel.

Care should be exercised in the alignment and layout of the swale to assure that shear forces produced on the side slopes do not exceed the allowable shear forces. For example, if a swale is constructed to intercept flows perpendicularly to the slope, excessive forces may be produced on the side slopes. Separate computations will be needed to determine the maximum shear stresses on the channel side slopes and the need for riprap protection.

## 4 REFERENCES

- Abt, S. R., Khattak, M. S., Nelson, J. D., Ruff, J. F., Shaikh, A., Wittler, R. J., Lee, D. W., and Hinkle, N. E., "Development of Riprap Design Criteria by Riprap Testing in Flumes: Phase I," NUREG/CR-4651, 1987.
- Abt, S. R., and Hogan, S. A., "Corrections of Permissible Velocity for Depth: A Review," 1990.
- Chow, V. T., **Open-Channel Hydraulics**, McGraw-Hill Book Company, Inc., New York, NY, 1959.
- Fullerton, W. T., "Water and Sediment Routing from Complex Watersheds and Example Application to Surface Mining," (MULTSED), Colorado State University, 1983.
- Horton, R. E., "Erosional Development of Streams and Their Drainage Basins: Hydrophysical Approach to Quantitative Morphology," *Geol. Soc. America Bull*, Vol. 56, pp. 275-370, 1945.
- Nelson, J. D., Abt, S. R., Volpe, R. L., van Zyl, D., Hinkle, N. E., and Staub, W. P., "Methodologies for Evaluating Long-Term Stabilization Designs of Uranium Mill Tailing Impoundments," NUREG/CR-4620, 1986.

SCS, "Engineering Field Manual." U.S. Department of Agriculture, Soil Conservation Service, 1984.

Temple et al., U.S. Department of Agriculture (USDA), "Stability Design of Grass-Lined Open Channels," Agricultural Handbook Number 667, 1987.

U.S. Nuclear Regulatory Commission (NRC), "Uranium Mill Tailings Management Position," 1989.

## APPENDIX B

# METHOD FOR DETERMINING SACRIFICIAL SLOPE REQUIREMENTS

## CONTENTS

	<i>Page</i>
<b>1 INTRODUCTION</b> .....	B-1
<b>2 TECHNICAL BASIS</b> .....	B-1
<b>3 PROCEDURES</b> .....	B-8
<b>4 RECOMMENDATIONS</b> .....	B-14
<b>5 EXAMPLE OF PROCEDURE APPLICATION</b> .....	B-14
<b>6 COMPUTER APPLICATION</b> .....	B-18
<b>7 LIMITATIONS</b> .....	B-20
<b>8 REFERENCES</b> .....	B-20

## APPENDIX B

### METHOD FOR DETERMINING SACRIFICIAL SLOPE REQUIREMENTS

#### 1 INTRODUCTION

In many cases where tailings extend over a large area, slope lengths may be so long that extremely gentle slopes will be needed to provide long-term stability. Such gentle slopes may necessitate the use of very large amounts of soil, such that some of these slopes (with no tailings directly under them) may extend greatly beyond the edge of the tailings pile.

In such cases, licensees may be able to demonstrate that it is impractical to provide stability for 1,000 years and may choose to show that stability for less than 1,000 years, but for at least 200 years, is a more cost-effective option. Such a design may incorporate tailings embankment "out slopes," where there are no tailings directly under the soil cover. Such slopes, designed for less than the 1,000-year stability period, may be acceptable if properly justified by the licensee.

It should be emphasized that the staff considers that a 200-year sacrificial slope design should be used only in a limited number of cases and only when a design life of 1,000 years cannot be reasonably achieved. However, it should not be assumed that the design period should immediately jump from 1,000 to 200 years. The staff concludes that the selection of a design period should proceed in a stepwise fashion, with consideration given to intermediate design periods from 200-1,000 years. In determining a minimum design, a 200-year sacrificial slope design, as presented below, may be used. However, such a design has a considerable amount of uncertainty associated with its use, due to its development by extrapolation of a relatively limited data base. Therefore, the staff considers that the procedure should be used only after other reclamation designs have been considered. The staff considers that the procedures for justifying a design period of less than 1,000 years, as discussed in Appendix C, should be carefully followed to document that a 200-year sacrificial slope design is the best design that can be reasonably provided.

#### 2 TECHNICAL BASIS

The long-term gully erosion process has the potential to destabilize an earthen embankment or soil cover constructed to prevent waste material release to the environment. Figures B-1 and B-2 present photographs of earthen embankments damaged by gulying. It was apparent to the staff that little criteria were available that assisted the designer in predicting the potential impacts of gulying processes to long-term stability of the waste material. The NRC thereby supported a series of studies to expand the knowledge base on the potential impacts of gullies on reclaimed impoundments and provide guidance for assuring the long-term stability of the waste.

In 1985, Falk et al. conducted a pilot study in an attempt to develop a procedure to predict the maximum depth a gully may incise into a tailing slope as a function of time. Falk characterized 16 reclaimed mine and/or overburden sites in Colorado and Wyoming that demonstrated incision



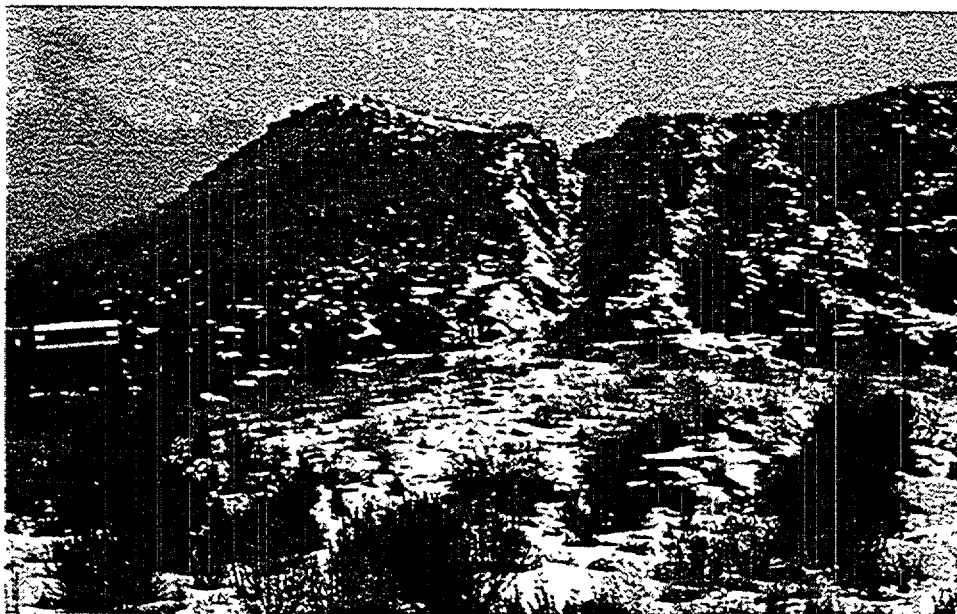

Figure B-1. Damage caused by gullying.



**Figure B-2.** Damage caused by gullying.

on the side slope and in some cases extended into the top slope areas. Field measurements included gully length, slope length, pile height, pile age, maximum gully depth, and width, tributary drainage area, vegetative cover and soil composition. From these data, Falk et al. attempted to formulate a procedure for estimating the maximum depth of incision, width of gully, and location of the maximum incision from the crest. The estimation procedure had a limited application but indicated that an estimation procedure could potentially be developed.

Pauley (1993) performed a series of flume studies in which near prototype soil embankments were constructed simulating a reclaimed waste impoundment. Figure B-3 presents a photograph of the flume used in the study. A series of rainfall and subsequent runoff events were conducted resulting in gully incision into the embankment. The gully processes were documented as a function of rainfall duration and volume, soil type, embankment slope and the maximum depth of incision. The results of the study indicated that the gully incision depth was a function of the clay content of the soil, volume of runoff to the gully, and the embankment height (Abt et al. 1994). The gully processes observed by Pauley and later documented by Abt et al. (1995b) in the flume study closely paralleled those observed in the field by Falk (1985) and others.

In an attempt to expand the Falk et al. (1985) data base, Abt et al. (1995a) conducted a study in which 11 field sites that demonstrated gully on reclaimed impoundments were located, characterized, measured, and sampled in the Colorado and Wyoming region and each gully was characterized (Falk et al. 1985).

The information presented by Falk et al. (1985), Pauley (1993) and Abt et al. (1995a) was consolidated into a composite data base as reported by Abt et al. (1995b). A comprehensive procedure was presented to estimate the maximum depth of gully incision, top width of the gully, and location of the maximum incision from the crest. The procedure allows the designer to determine gully depths and to predict the location of maximum gully incision.

A review of existing waste and tailing reclamation designs in conjunction with extensive site experience indicates that three primary embankment/cover configurations are commonly proposed. The three embankment configurations or types have been proposed or constructed as presented in Figure B-4. It is important to recognize that although each embankment type is similar along the main embankment face, the top slope, and subsequent potential tributary drainage, significantly impact the maximum depth of gully incision,  $D_{max}$ , that may intrude into the main slope. Therefore, a different procedure was developed to estimate the potential tributary drainage area and volume of runoff for each embankment type.

An empirical gully incision estimation procedure is presented as a function of the embankment/cover geometry, hydrologic parameters, soil composition, and the design life. It is anticipated that the estimation procedure will provide the user the maximum depth of gully incision, the approximate location of the maximum depth of incision along the embankment slope, and the approximate top width of the gully at the point of maximum incision as schematically presented in Figure B-5. The user will need to insure that the gully incision does not expose the waste/tailings materials.

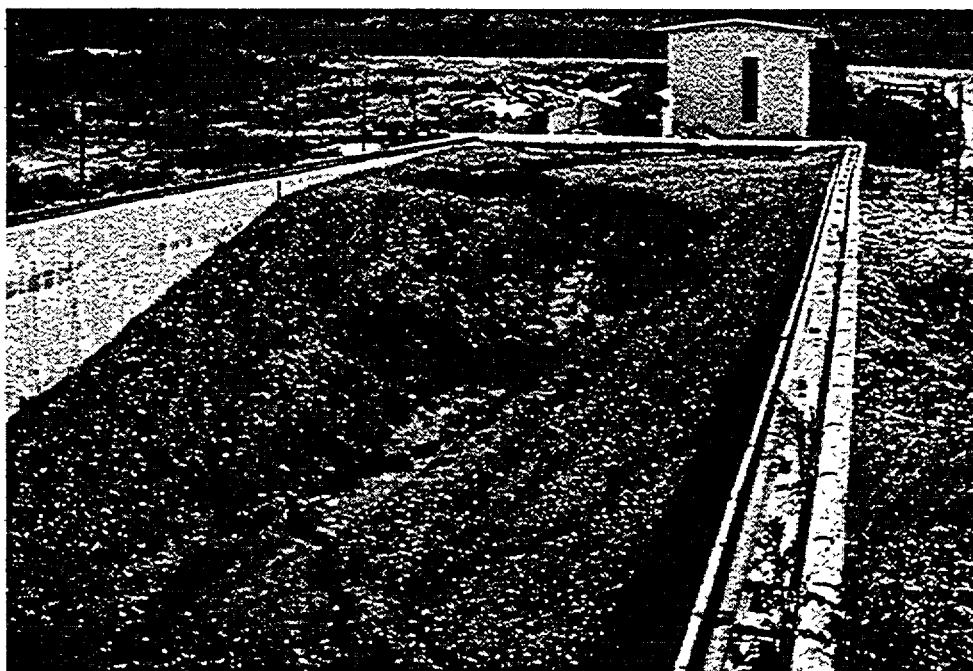

**Figure B-3.** Flume used by Pauley (1993).

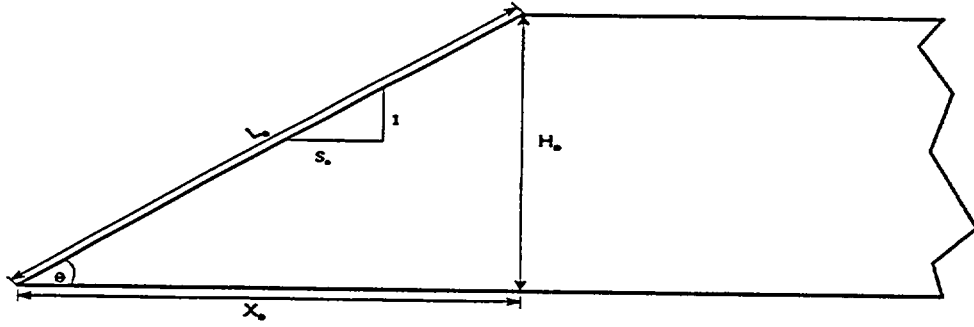

Type 1 Embankment

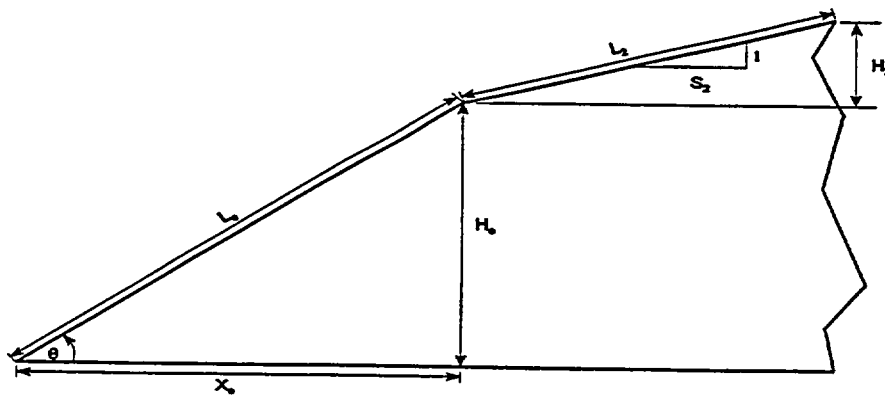

Type 2 Embankment

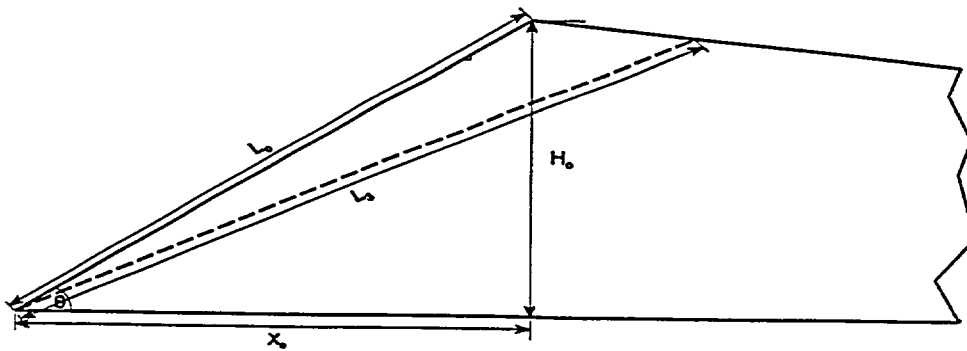

Type 3 Embankment

Figure B-4. Three types of embankment geometry.

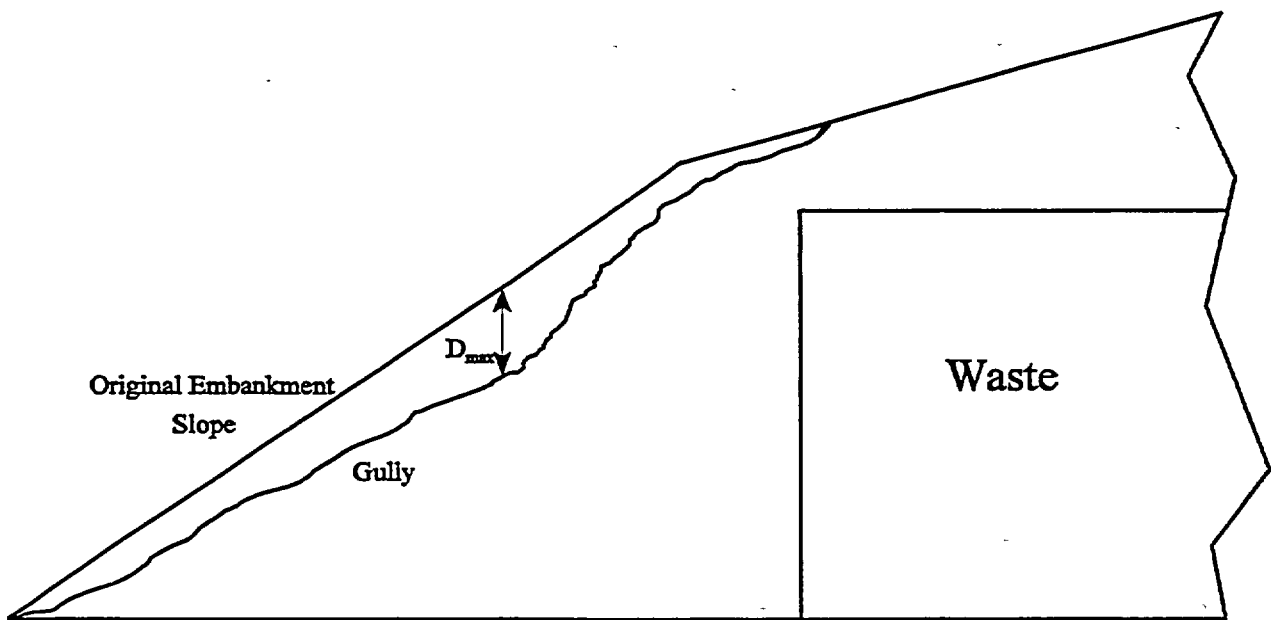

Figure B-5. Schematic of typical waste impoundment.

Staff review indicates that locating the depth of maximum gully incision is the most unpredictable part of the design procedure. The field data and flume data cannot be relied on totally to adequately describe the gully profile along the length of the slope. For example, the procedure may predict that the maximum gully depth will be 20 ft and will occur 500 ft from the embankment crest. However, not reflected in the design procedure is the possibility that the same gully could be 19 ft deep at the crest. The gully profile data available and staff experience suggest that gully depths approaching the maximum gully depth could occur near the crest. Thus, until more data are available, the staff recommends that the location of maximum gulying be assumed to occur near the crest of the slope. In addition, because of the need for significant data extrapolation, the staff suggests that this procedure be used to determine sacrificial slope requirements for a 200-year period.

In situations where increasing the set back distance of waste with respect to the embankment crest is not feasible, the concept of embankment stabilization utilizing launching riprap may be examined. Abt et al. (1997) presents a preliminary approach to the stabilization technique. Figure B-6 presents a photograph of a laboratory simulation of embankment stabilization using launching riprap. Based upon the findings of the pilot test series, a set of preliminary guidelines and a design procedure is outlined by Abt et al. (1997). The procedure presented represents the pilot test series and its application has not been tested and verified under field or near prototype conditions. It is recommended that the procedures outlined by Abt et al. (1997) be applied with a high degree of engineering judgement.

### 3 PROCEDURES

A procedure has been developed to estimate the effects of gulying over time. The following steps outline the estimation procedure.

- Step 1. Determine the embankment design life as outlined in Appendix A. Stability of the embankment must be insured for periods ranging from 200 to 1,000 years.
- Step 2. Select the embankment type (Type 1, Type 2, or Type 3) and determine values of the appropriate design variables.  
  
Embankment/cover variables applicable to all three types of embankments include the embankment height ( $H_o$ ) (m), slope length ( $L_o$ ) (m), slope angle ( $\theta$ ) (degrees), and horizontal distance from the embankment toe to the crest ( $X_o$ ) (m) as presented in Figure B-4.
- Step 3. Determine the embankment/cover soil composition, expressed as a percentage of the sands, silts, and clays. Discriminating thresholds for gully intrusion potential for embankments are segmented into soils with clay content less than 15 percent, clay content between 15 and 50 percent, and clay content greater than 50 percent.
- Step 4. Determine the average annual precipitation ( $P$ ), expressed in meters, for the embankment site. Estimates of precipitation can be obtained from U.S. Weather Bureau isohyetal maps, local climatological data, or other appropriate means.

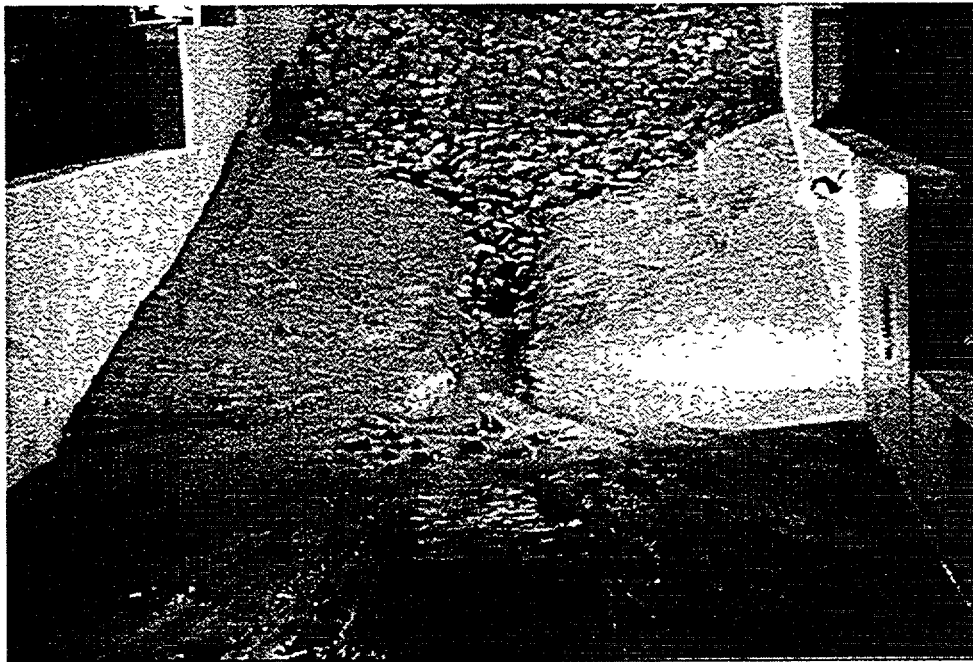

Figure B-6. Photograph of launching riprap flume test.



- Step 5. Determine the drainage area tributary to the embankment to estimate the volume of runoff to which an embankment will be exposed in its design life. For embankments without external drainage basins, the tributary drainage area that forms on the face of the embankment will determine the total volume of runoff (Abt, Thornton, and Johnson, 1995b). The tributary drainage area that forms on the embankment face is a unique function of the type of embankment being evaluated.

#### Type 1 Embankment

The tributary drainage area for a Type 1 embankment may be estimated by

$$A = 0.276 * [L_o * \text{Cos}(\theta)]^{1.636} \quad (\text{B-1})$$

where: A = tributary drainage area (m<sup>2</sup>)  
L<sub>o</sub> = original embankment length (m)  
θ = slope angle in degrees computed as Tan<sup>-1</sup>(S<sub>o</sub>)

#### Type 2 Embankment

The tributary drainage area for a Type 2 embankment is computed by summing the embankment face length (L<sub>o</sub>) and the embankment top length (L<sub>2</sub>). The resulting length (L<sub>t</sub>) is then entered in Equation B-1 as:

$$A = 0.276 * [L_t * \text{Cos}(\theta)]^{1.636} \quad (\text{B-2})$$

where: A = tributary drainage area (m<sup>2</sup>)  
L<sub>t</sub> = total length of embankment  
θ = slope angle in degrees computed as Tan<sup>-1</sup>(S<sub>o</sub>)

#### Type 3 Embankment

The tributary drainage area for a Type 3 embankment can be estimated using Equation B-1; however, an effective embankment length (L<sub>3</sub>) must be determined. Flume and field observations indicate that a gully forming on a Type 3 embankment can extend past the crest and into the adverse slope. When this condition occurs, the effective length of the embankment is increased. To provide an estimate of the tributary drainage area at any point in time, the value of the effective embankment length is determined by estimating the final gully bottom slope. Abt et al. (1995b) reported that the gully bottom slope may be estimated as

$$S_b = [1.008 * S_o] - 0.063 \quad (\text{B-3})$$

where:  $S_b$  = gully bottom slope (rise/run)  
 $S_o$  = original embankment slope (rise/run)

The effective embankment length can then be computed as:

$$L_3 = 1.175 * L_o \quad (B-4)$$

where  $L_o$  and  $L_3$  are expressed in meters. The tributary drainage area can then be computed using Equation B-1 where  $L_3$  is substituted for  $L_o$ .

In situations where the embankment toe is exposed to runoff that develops on a tributary drainage area external to the embankment, the supplemental area ( $A_x$ ) is added to the drainage area value computed using Equation B-1.

Step 6. The total depth of precipitation to which the site may be exposed to over the design life needs to be determined. In Step 1, the design life of the embankment was estimated. The average annual precipitation for the project site was then estimated based on Step 4. The expected depth of precipitation, in meters, is then calculated as:

$$D_t = \text{Average Precipitation Depth (m)} * \text{Design Life (years)} \quad (B-5)$$

Step 7. The runoff to rainfall ratio,  $R_r$ , is needed to convert the potential depth of precipitation for the embankment design life to potential runoff tributary to the developing gully. The U.S. Geological Survey (USGS) developed a runoff map method (Gebert et al., 1989) to determine the average annual runoff expected from any location in the United States. The USGS map provides the user the annual depth of runoff from a site specific location. The ratio of the runoff to rainfall is computed by dividing the runoff depth derived from Gebert et al. by the average annual precipitation for the appropriate locale. The average runoff-ratio using the USGS Average Annual Runoff Method is 0.127. The runoff-rainfall ratio of 0.127 provides a reasonable estimate for the arid and semi-arid regions of the western United States.

Step 8. The cumulative volume of runoff ( $V_r$ ) tributary to the embankment toe, in cubic meters, is calculated as:

$$V_r = D_t * R_r * A \quad (B-6)$$

where  $A$  is the tributary drainage area, expressed in square meters, as determined in Step 5. It is acknowledged that a single storm event will significantly impact the development of the gully. Abt et al. (1995a) indicates that the total volume of runoff can serve as a predictor of the ultimate dimensions (i.e., maximum depth, width, etc.)

of the gully. The volume of runoff tributary to the gully for the embankment design life is the primary element reflecting the analysis period.

Step 9. The maximum depth of gully incision ( $D_{max}$ ) can be estimated as a function of the cumulative volume of runoff,  $V_r$ , the embankment height,  $H_o$ , the embankment slope length,  $L_o$ ,  $L_2$ , or  $L_3$ , the embankment slope, and the clay content of the soil composition. A gully factor,  $G_f$ , was developed from the analysis described by Abt et al. (1994) for varying clay content of the proposed construction material. The gully factor is defined as:

$$G_f = \frac{D_{max}}{L_i * S_o} \quad (B-7)$$

where  $L_i$  is  $L_o$ ,  $L_2$ , or  $L_3$  as applicable and the embankment slope  $S_o$ , is  $H_o/X_o$ . The gully factor is computed as:

Clay content < 15%:

$$G_f = \frac{D_{max}}{L_o * S} = \frac{1}{2.25 + \left( 0.789 * \frac{V_r}{H_o^3} \right)^{-0.55}} \quad (B-8)$$

Clay content > 15%, < 50%:

$$G_f = \frac{D_{max}}{L_o * S} = \frac{1}{2.80 + \left( 0.197 * \frac{V_r}{H_o^3} \right)^{-0.70}} \quad (B-9)$$

Clay content > 50%:

$$G_f = \frac{D_{max}}{L_o * S} = \frac{1}{3.55 + \left( 0.76 * \frac{V_r}{H_o^3} \right)^{-0.85}} \quad (B-10)$$

Step 10. The maximum depth of gully incision expected on the embankment slope may then be estimated as:

$$D_{\max} = G_f * L_i * S \quad (\text{B-11})$$

where  $D_{\max}$  is in meters.

Step 11. After the value of  $D_{\max}$  is determined, the top width of the gully at the deepest incision can be calculated as:

$$W = \left( \frac{D_{\max}}{0.61} \right)^{1.149} \quad (\text{B-12})$$

where:  $W$  = top width of gully (m)  
 $D_{\max}$  = depth of deepest gully incision (m)

Step 12. In some applications, it is important to estimate the location of the maximum gully incision to evaluate the stability of the embankment or the potential to penetrate into the waste storage area. The location of the maximum depth of incision, measured down slope from the crest, may be determined as:

$$D_t = 0.713 * \left( \frac{(V_r * S)}{L_i^3} \right)^{-0.415} \quad (\text{B-13})$$

where:  $D_t$  = location of  $D_{\max}$   
 $V_r$  = cumulative volume of runoff ( $\text{m}^3$ )  
 $S_o$  = original embankment slope (rise/run)  
 $L_o$  = original embankment length (m)

Step 13. To provide a conservative estimate of the possible damage caused to an earthen embankment by a migrating gully, it is assumed that the maximum depth of gully intrusion occurs at the crest of the embankment. The embankment material is then assumed to erode, at the angle of repose of the embankment material, up slope of  $D_{\max}$ . The set back distance of the waste material is determined for each of the three types of embankments by assuming the embankment erodes at the angle of repose.

Step 14. If altering the set back distance is not feasible, protection may be examined utilizing launching riprap. A detailed explanation of the launching riprap application is

presented by Abt et al. (1997). The following preliminary guidelines should be followed in a launching riprap application:

- The minimum riprap size should be determined using accepted riprap sizing criteria for overtopping flow. A minimum median stone size ( $D_{50}$ ) of 9 cm was found to work well in flume studies.
- The protective riprap layer should have adequate volume to provide slope coverage under maximum expected gully conditions. A layer thickness of approximately  $3 D_{50}$  is recommended, depending on the volume requirements and the length of the riprap layer.

#### 4 RECOMMENDATIONS

The stable slope should be determined using the procedures presented in Appendix A. Appropriately conservative values of input parameters should be used in the computation. Additional refinements can be made after the analysis of the sacrificial slope requirements.

In analyzing Type 2 Embankments, the top slope of the cover should be much flatter (less than or equal to 5%) than the slope of the embankment face. The gully would likely occur far upstream from the crest if the top slope were steep. The following example is presented to outline the stability assessment procedure, not to promote or compare any embankment types.

#### 5 EXAMPLE OF PROCEDURE APPLICATION

The following example is used to outline the procedure of stability analysis of a Type 2 Embankment. Type 2 Embankments, presented in Figure B-4, are identified by an embankment slope that transitions into a flatter top slope. Embankments constructed with Type 2 geometry are evaluated by superimposing the total length of the embankment,  $L_t$ , on the slope of the embankment face.

Step 1. Design Life

An embankment design life of 200 years will be evaluated.

Step 2. Embankment Geometry

Once the embankment type is determined, the initial design variables are required. It will be assumed that the embankment has the following physical dimensions:

$H_o$ = embankment height	= 9 meters
$L_o$ = embankment slope length	= 55 meters
$S_o$ = embankment slope	= 0.15 rise/run
$L_2$ = top embankment length	= 100 meters
$S_2$ = top embankment slope	= 0.05 rise/run

Step 3. Soil Composition

It is assumed that a soil analysis has been conducted and that the embankment material is composed of 13 percent clay by volume, and has an angle of repose of 34 degrees.

Step 4. Precipitation

Local climatological data indicate an average annual precipitation of 0.20 meters for the site.

Step 5. Potential Tributary Drainage Area

The total potential tributary drainage area for a Type 2 Embankment is determined by computing the total embankment length as shown below

$$L_t = L_o + L_2 \quad (B-14)$$

where:  $L_t$  = total embankment length (m)

$L_o$  = length of embankment face (m)

$L_2$  = length of embankment top slope (m)

The value determined for the total embankment length is then combined with the slope of the embankment face and entered into Equation B-2 as shown below

$$A = 0.276 * \{155 \text{ meters} * \cos(8.53)\}^{1.636} \quad (B-15)$$
$$A = 1038 \text{ meters}^2$$

Therefore, the total potential tributary drainage area for the Type 2 Embankment is 1038 square meters. It is assumed that there is no additional drainage area external to the embankment.

Step 6. Potential Depth of Precipitation

The first step in computing the total runoff volume for the site is to determine the potential depth of precipitation,  $D_p$ , that the site will be exposed to during the design life. As described in Step 6, the total depth of precipitation is the product of the average annual precipitation and the design life. Therefore,

$$D_t = 0.20 \text{ meters/year} * 200 \text{ years}$$

$$D_t = 40.0 \text{ meters of precipitation} \quad (\text{B-16})$$

and a potential depth of precipitation of 40.0 meters is computed.

**Step 7. Runoff to Rainfall Ratio**

A value of 0.13 is assumed as the average runoff to rainfall ratio,  $R_r$ , for the embankment area.

**Step 8.** The cumulative volume of runoff,  $V_r$ , is defined as the product of the potential depth of precipitation,  $D_t$ , the runoff to rainfall ratio,  $R_r$ , and the potential tributary area,  $A_t$ . Substituting the values of  $D_t$ ,  $R_r$  and  $A_t$  obtained above into Equation B-6 yields

$$V_r = 40.0 \text{ meters} * 0.13 * 1038 \text{ meters}^2$$

$$V_r = 5,400 \text{ meters}^3 \quad (\text{B-17})$$

Therefore, the embankment slope will drain approximately 5,400 cubic meters of runoff during the 200 year design life.

**Step 9. Determination of Gully Factor**

The gully factor,  $G_f$ , for the embankment should be determined as outlined in Step 9. A clay content of 13 percent in the embankment material requires that Equation B-8 be used to calculate the gully factor. Substituting values for  $H_o$  and  $V_r$  into Equation B-8 gives

$$G_f = \frac{1}{2.25 + \left[ 0.789 * \left\{ \frac{5,399.97 \text{ meters}^3}{(9.0 \text{ meters})^3} \right\} \right]^{-0.55}} \quad (\text{B-18})$$

$$G_f = 0.380$$

**Step 10. Maximum Depth of Gully Incision**

A gully factor of 0.380 is entered into Equation B-8 to determine the maximum depth of gully incision as follows

$$D_{\max} = 0.380 * 55.0 \text{ meters} * 0.15$$

$$D_{\max} = 3.14 \text{ meters} \quad (\text{B-19})$$

Thus, after a 200 year period, a gully incision 3.14 meters deep would be expected on the face of the embankment.

Step 11. Gully Top Width

Equation B-12 presents an empirical relationship that can be used to predict gully top width,  $W$ , as a function of maximum gully incision,  $D_{\max}$ . Substituting the value of 3.14 meters computed for  $D_{\max}$  into Equation B-12 gives

$$W = \left( \frac{3.14 \text{ meters}}{0.61} \right)^{1.149}$$

$$W = 6.57 \text{ meters} \quad (\text{B-20})$$

therefore, 6.57 meters would be the estimated gully width at the point of deepest gully incision.

Step 12. Location of Maximum Depth

Equation B-13 presents an empirical relation predicting the location of  $D_{\max}$  as a function of the total volume of runoff, embankment length, and embankment slope. Substituting the values determined above into Equation B-13 gives

$$D_1 = 0.713 * \left\{ \frac{(5,399.97 \text{ meters}^3 * 0.15)}{(55 \text{ meters})^3} \right\}^{-0.415}$$

$$D_1 = 6.50 \quad (\text{B-21})$$

which represents the number of  $D_{\max}$ 's down slope from the crest the deepest incision is expected to occur. To determine the location in meters, multiply the value determined for  $D_1$  by that determined for  $D_{\max}$ . For this example the deepest incision point will occur approximately 20.4 meters down slope from the embankment crest.

Summarizing the results obtained above yields



$$D_{\max} = 3.14 \text{ meters,}$$

$$W = 6.57 \text{ meters}$$

$$D_1 = 20.4 \text{ meters}$$

However, for long-term stability applications, the location of  $D_{\max}$  should be assumed to be at the crest of the slope.

**Step 13. Set Back Distance**

For conservatism, the maximum depth of incision is assumed to occur at the crest of the embankment and the material is assumed to erode at the angle of repose ( $34^\circ$  for this example) upstream of the crest. For the conditions of this example, the set back distance would be 4.66 meters up slope from the crest of the embankment. Therefore, tailings should be located a minimum horizontal distance of 4.66 meters up slope and a vertical distance of 4.71 meters down from the embankment crest.

**Step 14. Rock Launching Application**

If providing adequate setback distance is not feasible, embankment stabilization with launching rock may be considered. For details and a preliminary application procedure, see Abt et al. (1997). The findings discussed by Abt et al. (1997) should be adapted to each specific site with engineering judgement. In general, a volume of rock should be provided to cover the collapsed slope with a rock layer of 1.5 times the  $D_{50}$  size, considering the depth of gully intrusion and the length. It is recommended that the required  $D_{50}$  size be specifically determined for a collapsed slope of 1V to 2H. Figure B-7 presents a schematic of the rock launching application concept.

The results of the example outlined above can then be checked with the original design of the soil cover, as described in Appendix A. Engineering judgment then determines if the design is adequate to provide the level of protection necessary throughout the design life.

## **6 COMPUTER APPLICATION**

To aid in the analysis of the stability assessment, a computer program has been developed. The Windows™ application provides an automated method of evaluating the stability procedure described above (Thornton, 1996). The program is available from the U.S. Nuclear Regulatory

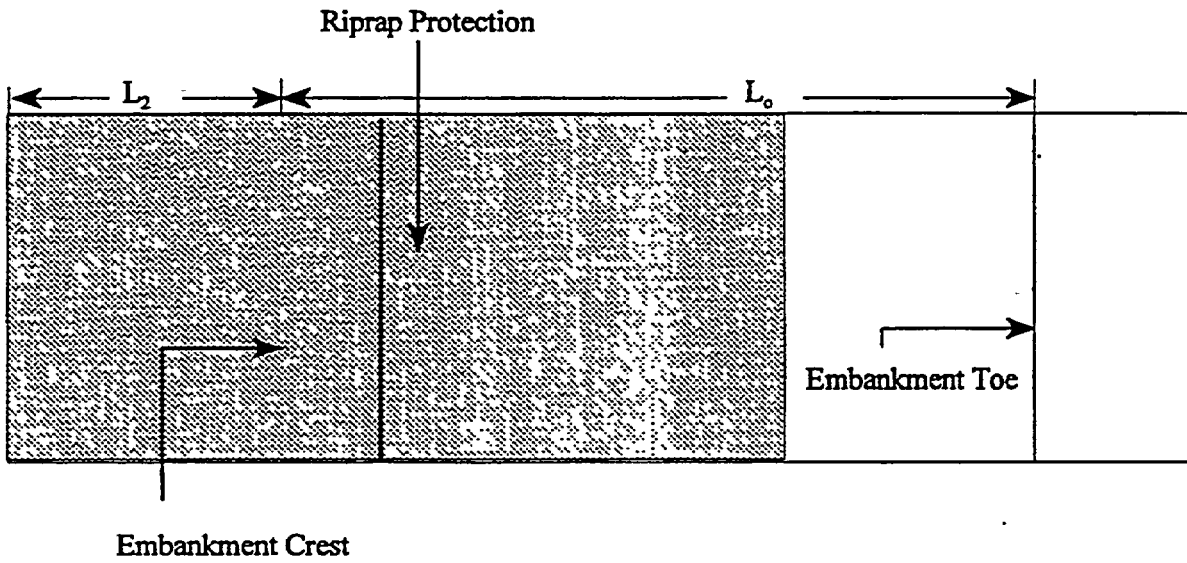

Plan View

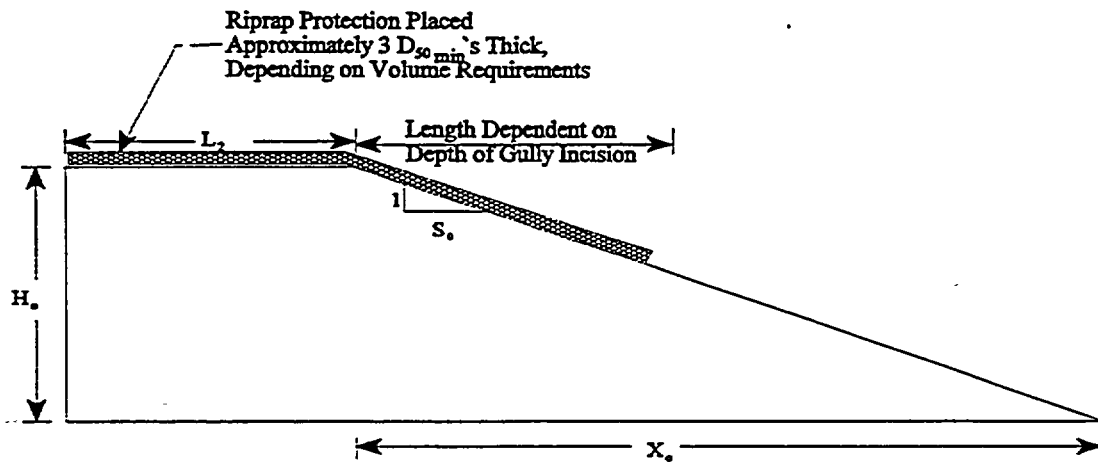

Profile View

Figure B-7. Plan and profile view of rock launching application.

Commission in both 16 and 32 bit formats. Program disks and user manuals can be provided upon request. After comments have been received on this guidance, it is expected that the program will be made available on the NRC web site.

## 7 LIMITATIONS

This method of analysis is considered to represent an approximate method of analyzing setback and sacrificial slope requirements. It should be emphasized that the gully intrusion method has been developed by extrapolating empirical data, which could lead to significant errors in the determination of gully depths and transitional slopes. Because of the possible errors associated with extrapolating such a limited data base, the staff expects that additional monitoring of the slope will be needed following closure of a sacrificial slope design with a design life of only 200 years. Licensees and applicants will be expected to conduct additional monitoring of the slope to assure that the design is performing as expected. If deviations are found, the licensee may be required to redesign and revise the sacrificial slope.

## 8 REFERENCES

- Abt, S. R., Pauley, C. J., Hogan, S. A., and Johnson, T. L., "Gully Potential in Soil-Covered Uranium Waste Impoundments." *J. of Energy Engineering, ASCE*, Vol. 120, No. 2, pp. 51-66, August, 1994.
- Abt, S. R., Thornton, C. I., Batka, J. H., and Lipscomb, C. M., "Investigation of Gully Stabilization Methods with Launching Stone: Pilot Laboratory Tests." Prepared for the U.S. Nuclear Regulatory Commission, Washington, DC, February, 1997.
- Abt, S. R., Thornton, C. I., and Johnson, T. L., "Estimating Drainage Area on Steep Uniform Slopes." *AWRA Water Resources Bulletin*, 31(1), pp. 53-58, February, 1995b.
- Abt, S. R., Thornton, C. I., Hogan, S. A., Pauley, C. J., and Watson, C. C., "Methodologies for Design of Soil Covers: Gully Intrusion into Reclaimed Slopes." Report prepared for the U.S. Nuclear Regulatory Commission, NMSS, Washington, DC, August, 1995a.
- Gebert, W. A., Graczyk, D. J. and Drug, W. R., "Average Annual Runoff in the United States, 1951-1980." *Hydrologic Investigations Atlas* published by the U.S. Geological Survey, Reston, VA, 1989.
- Thornton, C. I. and Abt, S. R., "Gully Prediction Program Users Manual." Prepared for the U.S. Nuclear Regulatory Commission, Washington, DC, October, 1995.

**APPENDIX C**

**PROCEDURES FOR DETERMINING IF A 1000-YEAR DESIGN  
IS NOT REASONABLY ACHIEVABLE**

## APPENDIX C

### PROCEDURES FOR DETERMINING IF A 1000-YEAR DESIGN IS NOT REASONABLY ACHIEVABLE

A tailings pile must be designed to remain stable for 1000 years, unless it can be shown that designing for 1000 years is not reasonably achievable. One aspect of demonstrating that a design is not reasonably achievable is total cost. If it can be demonstrated that a 1000-year design is not practicable because of excessive costs, a licensee or applicant can design for a shorter time period, in accordance with applicable regulations and standards. In no case, however, can the stability period be less than 200 years.

In order to justify that providing an erosion protection cover for a 1,000-year period is not reasonably achievable, the following step-by-step procedure is suggested:

- Step 1. Identify several designs and design configurations that would meet the 1000-year stability criterion. Such designs should include, as a minimum, soil covers with stable slopes, combinations of soil and rock covers, and rock-protected soil covers. Alternative designs may also include vegetated slopes, if it can be shown that vegetation will be dense and self-sustaining over a long period of time.
- Step 2. Identify the least costly of several rock sources that could be used with the designs identified in Step 1. The sources should be evaluated based on cost, rock size availability, and durability.
- Step 3. Determine the costs associated with the least costly design that will be capable of meeting the 1000-year stability criterion. Costs, including transportation costs, should be broken down by unit cost and total cost in the following categories:
  1. Soil covers and/or rock erosion protection for top of pile
  2. Soil covers and/or rock erosion protection for sides of pile
  3. Rock erosion protection for aprons/toes, as necessary
  4. Rock erosion protection for drainage and diversion channels
  5. Rock erosion protection for banks of large adjacent streams
  6. Earthwork and miscellaneous features needed specifically for erosion protection (for example, diversion dikes)
- Step 4. Compute the total cost of the project for meeting the 1000-year stability criterion, as compared to the cost of designing for stability periods of less than 1000 years. In

order to determine if the costs of providing such protection are clearly excessive, the following minimum criteria are suggested:

1. The total project cost for the 1,000-year design significantly exceeds the average total project cost for other similar sites, assuming that information on other sites is available,
2. The cost of providing erosion protection (a soil cover, a soil and rock cover, or a total rock cover) for the 1,000-year design, as a percentage of the total project cost, is significantly greater than the average percentage cost for other similar sites, and
3. A significant savings results from using the less expensive design.

Step 5.

As applicable, determine the magnitude of the flood and the percentage of the design flood (Probable Maximum Flood/Probable Maximum Precipitation, for example) that a less expensive design will withstand. The analyses should assume designs and computational methods similar to the designs and computational methods employed in Step 1, and should assume that the less costly erosion protection will be used.

A plot should be developed to graphically show the relationship of costs vs. the percentage of the design flood event that can be withstood. If a well-defined "break point" exists in the graph, where the costs increase dramatically as a result of increasing the flood discharge, this "break point" may provide a reasonable basis for determining an appropriate flood magnitude for design.

Step 6.

Demonstrate that applicable standards and regulations are met by the "reduced" design. Information and analyses that should be provided include the following:

1. Drawings, cross-sections, and supporting hydraulic calculations for each design analyzed, including any other general information requirements, as discussed in Section 3.1
2. Backup calculations that provide the bases for the cost estimates
3. Supporting hydraulic calculations
4. Supporting logic and bases that document that the design selected meets applicable longevity criteria

## APPENDIX D

### PROCEDURES FOR DESIGNING RIPRAP EROSION PROTECTION

#### CONTENTS

	<i>Page</i>
<b>1 INTRODUCTION</b> .....	D-1
<b>2 RIPRAP DESIGN FOR TOP AND SIDE SLOPES</b> .....	D-1
2.1 Technical Basis .....	D-1
2.1.1 Filter Requirements .....	D-3
2.1.2 Riprap Layer Thickness .....	D-4
2.2 Design Procedures .....	D-4
2.2.1 Design Procedure Using Safety Factors and Stephenson Methods .....	D-4
2.2.2 Design Procedure Using Abt/Johnson Method .....	D-6
2.3 Recommendations .....	D-6
2.4 Example of Procedure Application .....	D-6
2.4.1 Safety Factors and Stephenson Method .....	D-6
2.4.2 Abt and Johnson Method .....	D-8
2.5 Limitations .....	D-8
<b>3 RIPRAP DESIGN FOR DIVERSION CHANNELS</b> .....	D-9
3.1 Technical Basis .....	D-9
3.2 Design Procedures .....	D-9
3.2.1 Normal Channel Designs .....	D-9
3.2.2 Design for Inflow from Natural Gullies .....	D-10
3.2.3 Other Design Considerations .....	D-11
3.2.3.1 Hydraulic Jumps .....	D-11
3.2.3.2 Channel Bends .....	D-11
3.2.4 Specific Design Procedure .....	D-11
3.3 Recommendations .....	D-13
3.4 Example of Procedure Application .....	D-13
3.5 Limitations .....	D-15
<b>4 RIPRAP DESIGN FOR APRONS AND DIVERSION CHANNEL OUTLETS</b> .	D-15
4.1 Technical Basis .....	D-15
4.2 Design Procedures .....	D-16
4.3 Recommendations .....	D-17
4.4 Example of Procedure Application .....	D-17
4.5 Limitations .....	D-19

<b>5</b>	<b>RIPRAP DESIGN FOR PROTECTION FROM FLOODING FROM NEARBY STREAMS</b>	<b>D-19</b>
5.1	Technical Basis	D-19
5.2	Design Procedure	D-19
5.3	Recommendations	D-20
5.4	Example of Procedure Application	D-20
5.5	Limitations	D-21
5.6	Launching Erosion Protection	D-21
	5.6.1 Applications	D-22
	5.6.2 Design Considerations	D-22
<b>6.</b>	<b>RIPRAP SIZING AT TOE OF EMBANKMENT SLOPES</b>	<b>D-23</b>
6.1	Technical Basis	D-23
6.2	Design Procedure	D-24
6.3	Recommendations	D-24
6.4	Example of Procedure Application	D-25
<b>7</b>	<b>OVERSIZING OF MARGINAL-QUALITY EROSION PROTECTION</b>	<b>D-26</b>
7.1	Technical Basis	D-26
7.2	Design Procedures	D-28
	7.2.1 Procedures for Assessing Rock Quality	D-28
	7.2.2 Oversizing Criteria	D-28
	7.2.3 Guidelines for Using Sandstone Materials	D-31
7.3	Recommendations	D-32
7.4	Example of Procedure Application	D-33
7.5	Limitations	D-34
<b>8</b>	<b>REFERENCES</b>	<b>D-35</b>



## APPENDIX D

### PROCEDURES FOR DESIGNING RIPRAP EROSION PROTECTION

#### 1 INTRODUCTION

To minimize the potential for initiation of gulying and erosion damage on steep slopes, it is often necessary to provide rock riprap erosion protection. Because vegetation alone is often not effective, and because natural steep slopes are common on small watersheds, riprap is often needed to provide the required protection. At a typical reclaimed tailings site, riprap may be needed to protect: (1) top and side slopes; (2) diversion channels; (3) aprons and diversion channel outlets; and (4) banks of larger rivers and/or areas of the reclaimed side slopes where floods impinge. Procedures for designing riprap erosion protection for each of these areas are given in Sections 2 through 6, following. In addition, procedures are presented in Section 6 for evaluating and oversizing marginal-quality rock to meet longevity requirements.

#### 2 RIPRAP DESIGN FOR TOP AND SIDE SLOPES

The principal objective in determining the riprap requirements for stabilized top slopes and side slopes of embankments is to provide a design that meets long-term stability requirements. Since the most disruptive event for these designs is likely to be gully erosion, it is important to provide a rock layer that will minimize the potential for gully erosion, which, once started, may worsen and continue unchecked.

##### 2.1 Technical Basis

To better understand the phenomena and mechanisms affecting the design of riprap to prevent erosion by overtopping flows, the U. S. Nuclear Regulatory Commission (NRC) staff sponsored extensive technical assistance efforts. As a result of these efforts, it was determined that existing methods can be adapted to design erosion protection for these situations.

The reports and information developed by Nelson et al. (1983, 1986) and by Abt et al. (1988) provide the technical bases for the design of riprap for a reclaimed tailings pile. Abt et al. (1988) conducted a series of flume tests as portrayed in Figure D-1, and developed a family of curves relating failure flow rates to median stone diameter ( $D_{50}$ ). These studies have verified that the Safety Factors Method may be used for riprap design on relatively flat slopes and that the Stephenson Method may be used for riprap design on steeper slopes.

The staff has further concluded that some conservatism is appropriately provided by the Stephenson Method and the Safety Factors Method, to account for actual field conditions. These methods are generally based on flow rates that produce rock movement, and since the failure flow rates are greater than flow rates that produce rock movement, the staff accepts the use of the Stephenson Method for slopes of 10 percent or greater and the Safety Factors Method for slopes of less than 10 percent.

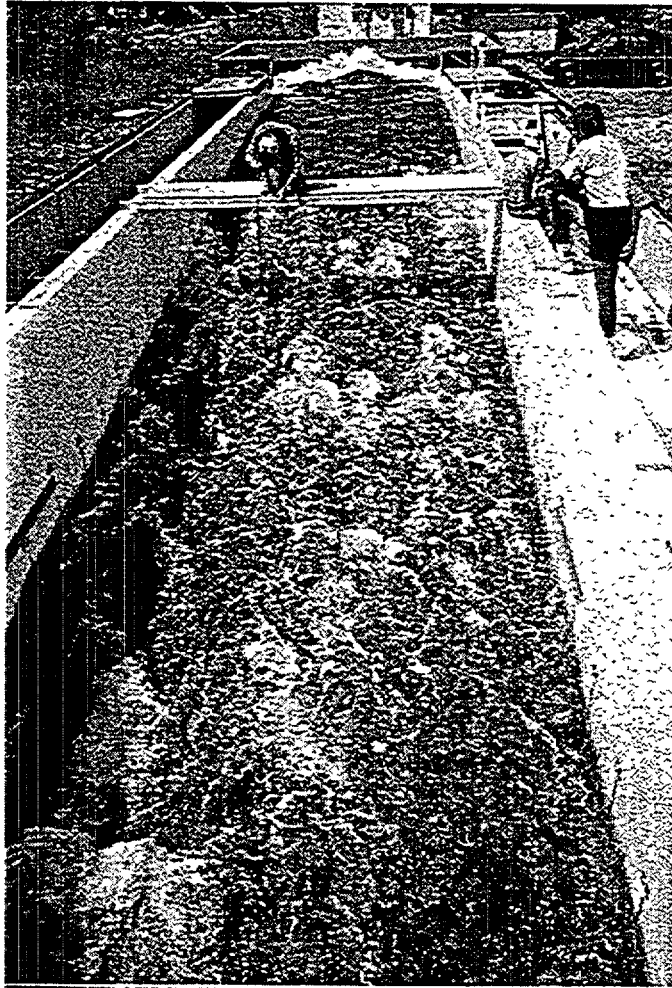

**Figure D-1.** Flume test for determining riprap failure flows.

Rock mulches (rock layers where the average rock size is relatively small) may provide a practical solution for stabilization of slopes and channels at many sites. The procedures for designing such rock layers are identical to those mentioned in the preceding paragraph. Studies by Abt et al. (1988) have indicated that a rock/soil matrix (riprap layer with the rock voids filled with soil) has similar stability characteristics as the riprap layer, alone. The staff, therefore, accepts the use of a rock mulch, a rock/soil matrix, or a rocky soil. The design of a rock mulch or a rock/soil matrix should be based on the  $D_{50}$  rock size and should follow the procedures given in Appendix D; the designs are similar because there is no clear-cut distinction between a riprap layer and a layer of rock mulch. The design of a rocky soil cover should be based on the  $D_{75}$  particle size and should follow the procedures given in Appendix A; the design follows the procedure for a soil cover, because the layer is predominantly soil, rather than rock.

Abt and Johnson (1991) utilized the data from the Abt et al. (1988) flume studies and developed a comprehensive riprap design procedure for overtopping flow conditions. The Abt and Johnson procedure provides guidance for sizing angular-shaped riprap placed on slopes of up to 80 percent. From the flume tests, they developed an expression that determined the median rock size ( $D_{50}$ ) of the riprap layer as a function of the embankment slope and the unit discharge. Abt and Johnson recommended that the minimum rock layer thickness be about  $2 \cdot D_{50}$ s. As necessary, a flow concentration factor may be integrated into the design.

### 2.1.1 Filter Requirements

It is generally recommended that a filter or bedding layer comprised of well-graded rock material be placed on the cover or in locations where rock riprap is to be placed for erosion protection. Locations recommended for filter placement include impoundment side slopes, toes of slopes, transition areas, diversion ditches and channels, stilling areas, and flow impact areas. The purpose of the filter is to bed the riprap and prevent stone penetration into the cover and/or radon barrier, prevent soil erosion from flow at the stone/soil interface, and to prevent the pooling of precipitation and/or tributary runoff from infiltrating into the cover and waste materials. Filter sizing criteria are presented in NUREG/CR-4620 (Nelson, 1986).

The staff recognizes that the bedding layer for a typical reclaimed mill does not serve the same classic purpose as a filter for prevention of piping of fines from the underlying soil. In many cases, there is no hydraulic gradient to cause piping. In such cases, it is recommended that an analysis be performed to determine the need for a filter when median stone sizes of 2 inches or less are to be placed on flat slopes (2% or less) in arid regions. Assuming that there is no potential for piping of fines and the interstitial flow velocities are insufficient to transport soil particles, a filter layer may not be needed. Interstitial velocities should be based on the flow derived from the probable maximum precipitation and subsequent probable maximum flood condition.

To determine the interstitial flow velocity,  $v_i$ , at the soil/rock interface, the Leps (1973) procedure may be employed, as presented in NUREG/CR-4620 as

$$V_v = Wm^{0.5} i^{0.54}$$

where  $V_v$  is the average velocity of water (inches/sec) in the voids of the rockfill,  $W$  is an empirical constant for a specific riprap or rock mulch material,  $m$  is the hydraulic mean radius and  $i$  is the hydraulic gradient. The appropriate coefficients are presented in NUREG/CR-4620. A procedure for estimating flow through rock materials is presented by Abt et al. (1991).

When the computed interstitial velocity is less than 0.5 ft per second, a filter may not be needed. When velocities are between 0.5 and 1.0 ft per second, the need for a filter layer will be dependent upon the type of soil material placed at the interface. A filter should be provided when velocities are 1.0 ft per second or greater.

### 2.1.2 Riprap Layer Thickness

The minimum layer thickness should be such that all stones are contained with the riprap layer thickness to provide maximum resistance against erosive forces. The layer should not be less than 1.5 times the mean stone diameter ( $D_{50}$ ) or the  $D_{100}$ , whichever is greater (ACE, 1994). The thickness previously determined should be increased by 50 percent when the riprap is placed under water.

Care should be taken to select a layer thickness when placing median stone sizes of less than or equal to 3-inches. Minimum layer thicknesses may be dictated by standard rock placement practices, indicating that riprap layers less than 6-inches thick may be difficult to place.

## 2.2 Design Procedures

### 2.2.1 Design Procedure Using Safety Factors and Stephenson Methods

A step-by-step procedure for designing riprap for the top and side slopes of a reclaimed pile is presented below:

- Step 1. Determine the drainage areas for both the top slope and the side slope. These drainage areas are normally computed on a unit-width basis.
- Step 2. Determine time of concentration ( $t_c$ ).

The  $t_c$  can be a difficult parameter to estimate in the design of a rock layer. Based on a review of the various methods for calculating  $t_c$ , the NRC staff concludes that a method such as the Kirpich method, as discussed by Nelson et al. (1986), should be used. The  $t_c$  may be calculated using the formula:

$$t_c = (11.9L^3/H)^{.385} \quad (D-1)$$

where: L = drainage length (in miles)

H = elevation difference (in ft)

**Step 3. Determine Probable Maximum Precipitation (PMP) and PMP Intensities Corresponding to the Time of Concentration**

Techniques for PMP determinations have been developed for the entire United States, primarily by the National Oceanographic and Atmospheric Administration, in the form of hydrometeorological reports for specific regions. These techniques are commonly accepted and provide straightforward procedures for assessing rainfall potential, with minimal variability. Acceptable methods for determining the total magnitude of the PMP and various PMP intensities for specific times of concentration are given by Nelson et al. (1986).

**Step 4. Calculate Peak Flow Rate**

The Rational Formula, as discussed by Nelson et al. (1986), may be used to calculate peak flow rates for these small drainage areas. Other methods that are more precise are also acceptable; the Rational Formula was chosen for its simplicity and ease of computation.

**Step 5. Determine Rock Size**

Using the peak flow rate calculated in Step 4, the required  $D_{50}$  may be determined. Studies performed for the NRC staff (Abt et al., 1988) have indicated that the Safety Factors Method is more applicable for designing rock for slopes less than 10 percent and that the Stephenson Method is more applicable for slopes greater than 10 percent. Other methods may also be used, if properly justified.

**Step 6. Determine Filter Requirements**

- a. For riprap placed on the impoundment side slopes, transitions, diversion ditches and channels, or areas requiring erosion protection, procedures outlined in NUREG/CR-4620 should be employed to determine the filter size/gradation.
- b. For riprap or riprap mulch with a  $D_{50}$  of 2 inches or less and placed on flat areas (i.e., top slopes), a through-flow analysis should be performed to estimate the velocity at the rock/soil interface (as indicated in Section 2.1.1). If the velocity is less than 0.5 ft per second, a filter will not be needed in arid areas when the potential for piping of fines is minimal.

## Step 7. Determine Riprap Layer Thickness

In accordance with Section 2.1.2, the layer thickness should be a minimum of 1.5 times the  $D_{50}$  determined in Step 5 or equal to the  $D_{100}$ , whichever is greater.

### 2.2.2 Design Procedure Using Abt/Johnson Method

Based on flume studies performed at Colorado State University, a simple method for rock sizing on top and side slopes was developed by Abt and Johnson (1991) (See Equation D-7). The staff considers that this method may be used for riprap design, if the following conditions are met:

- 1) The PMP/PMF is used
- 2) The rock is angular
- 3) The rock has a specific gravity  $\gamma_s \geq 2.65$
- 4) The rock thickness will be at least 2 times the  $D_{50}$  size
- 5) The licensee will adopt a testing and inspection program similar to the program provided in Appendix F, with regard to rock placement and verification procedures.

### 2.3 Recommendations

Since it is likely that clogging of the riprap voids will occur over a long period of time, it is suggested that no credit be taken for flow through the riprap voids. Even if the voids become clogged, it is unlikely that stability will be affected, as indicated by tests performed by Abt et al. (1987).

If rounded rather than angular rock is used, some increase in the average rock size may be necessary, since the rock will not be as stable. Computational models, such as the Safety Factors Method, provide stability coefficients for different angles of repose of the material. The need for oversizing of rounded rock is further discussed by Abt et al. (1987) and Abt and Johnson (1991).

### 2.4 Example of Procedure Application

#### 2.4.1 Safety Factors and Stephenson Method

Determine the riprap requirements for a tailings pile top slope with a length of 1,000 ft and a slope of 0.02 and for the side slope with an additional length of 250 ft and a slope of 0.2 (20 percent).

Step 1. The drainage areas for the top slope (A1) and the side slope (A2) on a unit-width basis are computed as follows:

$$A1 = (1000) (1) / 43560 = 0.023 \text{ acres} \quad (D-2)$$

$$A2 = (1000 + 250) (1) / 43560 = 0.029 \text{ acres} \quad (D-3)$$

Step 2. The  $t_c$ s are individually computed for the top and side slopes, using the Kirpich Method.

$$t_c = [(11.9)(L)^3/H]^{.385} \quad (D-4)$$

For L = 1,000 ft and H = 20 ft,

$$t_c = 0.12 \text{ hours} = 7.2 \text{ minutes for the top slope}$$

For L = 250 ft and H = 50 ft,

$$t_c = 1.0 \text{ minute for the side slope.}$$

Therefore, the total  $t_c$  for the side slope is equal to 7.2 + 1.0, or 8.2 minutes.

Step 3. The rainfall intensity is determined using procedures discussed by Nelson et al. (1986), based on a 7.2-minute PMP of 4.2 inches for the top slope and an 8.2-minute PMP of approximately 4.5 inches for the side slope. These incremental PMPs are based on a one-hour PMP of 8.0 inches for northwestern New Mexico and were derived using procedures discussed by Nelson et al. (1986).

Rainfall intensities, for use in the Rational Formula, are computed as follows:

$$i_1 = (60)(4.2)/7.2 = 35 \text{ inches/hr for the top slope}$$

$$i_2 = (60)(4.5)/8.2 = 33 \text{ inches/hr for the side slope.}$$

Step 4. Assuming a runoff coefficient (C) of 0.8, the peak flow rates are calculated using the Rational Formula, as follows:

$$Q1 = (0.8)(35)(0.029) = 0.64 \text{ cfs/ft, for the top slope, and} \quad (D-5)$$

$$Q2 = (0.8) (33) (0.029) = 0.77 \text{ cfs/ft, for the side slope.} \quad (D-6)$$

Step 5. Using the Safety Factors Method, the required rock size for the pile top slope is calculated to be:

$$D_{50} = 0.6 \text{ inches.}$$

Using the Stephenson Method, the required rock size for the side slopes is calculated to be:

$$D_{50} = 3.1 \text{ inches.}$$

#### 2.4.2 Abt and Johnson Method

Using the same site parameters presented in Section 2.4.1, the Abt and Johnson Method yield the following rock size:

##### Top Slope

$$\begin{aligned} D_{50} &= 5.23 (0.02)^{0.43} (0.64)^{0.56} \\ &= 5.23 (0.19)(0.78) \\ &= 0.78 \text{ inches} \end{aligned}$$

##### Side Slope

$$\begin{aligned} D_{50} &= 5.23 (0.20)^{0.43} (0.77)^{0.56} \\ &= 5.23 (0.50) (0.86) \\ &= 2.25 \text{ inches} \end{aligned}$$

It is assumed that the flow concentration is 1.0.

#### 2.5 Limitations

The use of the aforementioned procedures is widely applicable. The Stephenson Method is an empirical approach and is not applicable to gentle slopes. The Safety Factors Method is conservative for steep slopes. Other methods may also be used, if properly justified.

The Abt and Johnson procedure should be limited to slopes of 50 percent or less. The method assumes that the rock meets the guidelines for rock angularity and specific gravity presented in Section 2.2.2.



### 3 RIPRAP DESIGN FOR DIVERSION CHANNELS

#### 3.1 Technical Basis

The Safety Factors Method or other shear stress methods are generally accepted as reliable methods for determining riprap requirements for channels. These methods are based on a comparison of the stresses exerted by the flood flows and the allowable stress permitted by the rock size. Documented methods are readily available for determining flow depths and Manning's "n" values.

#### 3.2 Design Procedures

##### 3.2.1 Normal Channel Designs

In designing the riprap for a diversion channel where there are no particularly difficult erosion considerations, the design of the erosion protection is relatively straightforward.

1. The Safety Factors Method or other shear stress methods may be used to determine the riprap requirements.
2. The peak shear stress should be used for design purposes and can be determined by substituting the value of the maximum depth of flow ( $y$ ) in the shear stress equations, instead of the hydraulic radius ( $R$ ). The resulting equation,  $t = WyS$ , provides a very simple analytical method for determining shear stress produced.
3. Another acceptable method for sizing riprap, particularly in steep channels, was developed by Johnson and Abt (1998) and may be used if the guidelines in Section 2.2.2 are met.
4. Flow through the riprap voids should be ignored. Over a long period of time, it is likely that the rock voids will be filled with sediments, debris, and organic material.
5. The Manning's "n" value may be determined using a variety of methods, depending on the slope of the channel and the depth of flow. For relatively flat channels where the depth of flow exceeds the average size of the riprap, the U.S. Army Corps of Engineers (ACE) relationships may be used (ACE, 1991). For relatively steep slopes or for those instances where the depth of flow is not large relative to the rock size, the "n" value should be computed in accordance with the recommendations of Abt et al. (1987). Abt found the "n" value was directly related to the slope and the riprap size, when the relative depth of flow was small.
6. Rainfall and rainfall intensities may be derived using procedures discussed by Nelson et al. (1986).
7. Times of concentration may be computed using the Kirpich Method, as discussed by Nelson et al. (1986).

8. The depth of flow in the channel may be calculated by solving the Manning Equation for the normal depth (Chow, 1959), if the channel is relatively uniform in cross-section and there are no changes in the bottom slope. If there are cross-section changes or changes in bottom slope, models such as HEC-2 (ACE) or other gradually-varied flow models, should be used to determine the depth of flow and slope of the energy grade line.

### 3.2.2 Design for Inflow from Natural Gullies

There have been several cases where proposed diversion ditches have been provided to divert flood flows around a reclaimed tailings pile, and in several locations, the ditches receive direct inflow from several existing gullies. Particular care must be taken in such instances to avoid damage to the ditches in the general area where the natural gullies discharge into the diversion ditches. This occurs in many cases where diversion channels are constructed generally perpendicular to the natural slope. The diversion channel may be constructed on a flatter slope than the slope of the natural gullies that will discharge into it, and the velocities in the natural gully are higher than the riprapped diversion channel can withstand.

The following guidelines should be used when designing channel riprap to resist velocities from incoming gullies:

1. The riprap in the immediate area where the natural gully discharges into the diversion channel should be designed for the peak velocities and shear forces that occur in the natural gully. This may be very important if the gully is significantly steeper than the proposed diversion channel. Unless a transition area is provided, assuming that the flow in the gully will spread and/or dissipate upon contact with the diversion ditch riprap may not be a valid assumption. The peak shear stress ( $t$ ) for design purposes can be determined by calculating the normal depth in the gully and calculating the peak shear stress using  $t = WyS$ , where  $W = 62.4$  pounds per cubic foot,  $y$  is the normal depth of flow in the natural gully (in feet), and  $S$  is the slope of the natural gully. The Safety Factors Method, for example, may also be used. The rock size in the diversion channel should be checked to ensure that it is sufficient to resist the flow velocities down the channel side slope. Construction of a transitional rock apron at the confluence, with the rock extending upstream into the gully, is often used.
2. To determine normal depth in the natural gully, the assumed gully cross-section should be one that currently exists, unless there is a potential for a more critical configuration to develop over a period of time. An example of this development would be the gradual vertical erosion of a gully that could narrow the cross-section or steepen the side slopes of an existing cross-section. A pre-constructed transitional rock apron may be used to widen the area and decrease incoming velocities where flows enter the channel.
3. It may be necessary to provide riprap to the computed depth of scour in the natural gully at the point where the natural gully meets the top of the slope of the diversion channel. This scour depth may be estimated using procedures of the U. S. Department of Transportation (USDOT) (see Abt et al., 1996) or using geomorphic analyses. It is

recommended that the thickness of the rock layer at this location not be less than the depth of any natural gullies in the area, taking into consideration the relative drainage areas of the gullies.

4. In addition to the larger natural gullies that discharge into the diversion channel, smaller flow concentrations could form at other points along the diversion channel. It is possible, particularly if the inflow slopes are steep, that smaller gullies could be formed at other locations and may generate more erosive forces than the rock in the diversion channel is capable of withstanding. Geomorphic or geologic evidence provides a reasonable guide regarding the possible formation of other smaller gullies. The rock size on the side slope may be checked using the Abt/Johnson Method.
5. The larger rock, as determined using the considerations previously discussed, may also need to be placed on the bottom and opposite bank of the diversion channel. This is necessitated by turbulence caused by energy dissipation in the channel and on the banks of the channel. Depending on the size of the channel, sediment accumulations may cause flows to be directed toward the opposite bank of the channel.

### 3.2.3 Other Design Considerations

#### 3.2.3.1 Hydraulic Jumps

There may be channel designs where steep slopes (supercritical flow) transition abruptly to flatter slopes (subcritical flow). The resulting hydraulic jump that may occur should be accounted for in the design of the erosion protection. In general, designers should locate the jumps and provide additional erosion protection in those locations. ACE's Hydraulic Design Reservoir Outlet Works (ACE, 1980) discusses hydraulic jumps and provides procedures for calculating incoming velocities, sequent depths, and other design parameters for stilling basins and energy dissipation areas. Riprap sizes in the area of the jump should be increased about 50% to account for the increase in shear stress due to the turbulence (ACE, 1980).

#### 3.2.3.2 Channel Bends

In those cases where channel curvature is present, shear forces can be significantly increased on the outside of the channel bend. It is sometimes necessary to increase the riprap size in those locations. Guidance for increasing the shear forces and riprap size in bends is provided by the Soil Conservation Service (1977). Procedures are presented for various values of channel width and radius of curvature ratios.

### 3.2.4 Specific Design Procedure

The design of riprap for diversion channels is relatively straightforward. The following step-by-step procedure is suggested:

- Step 1. Determine Time of Concentration

The time of concentration should be determined using a velocity-based method. For steep drainage areas, it is likely that overland flows will channelize relatively quickly; thus, the velocities that occur in these gullies and channels should be used to estimate the total time of concentration for the basin. The channel hydraulics method of the U.S. Bureau of Reclamation (USBR, 1977) is suggested for use in such cases. The Kirpich Method or other methods may also be used.

**Step 2. Determine Rainfall Intensities of the Design Storm**

Determine the total PMP and various PMP intensities (corresponding to the time of concentration) using procedures such as those discussed by Nelson et al. (1986).

**Step 3. Determine Design Flow Rate**

Depending on the complexity, size, and shape of the drainage basin, several methods may be used to calculate the peak flow rate to be used for designing the riprap protection. The Rational Formula may be used for small basins with very little shape irregularity. The triangular unit hydrograph method (USBR, 1977) may be used for somewhat larger basins with no significant shape irregularities. HEC-1 (ACE) should be used if the basins are large or if it is necessary to route inflows from several irregularly-shaped basins.

Regardless of the method selected, it is important to select appropriate values of infiltration and runoff in determining the peak flow rate. This will necessitate the use of reasonably conservative values of infiltration. It will also necessitate the use of reasonably high antecedent moisture conditions and critical placement of peak rainfall values in the storm sequence.

The NRC staff considers that reasonably conservative values of design parameters are necessary to account for flood events that have actually occurred in various areas where tailings sites are located. Although it is not possible to exactly predict the moisture conditions of the drainage basin soils or the distribution of rainfall within a given storm event, the magnitude of historic flood events can provide some guidance in the selection of design parameters. For example, a flood with a magnitude of 2630 cfs occurred on a 200-acre drainage basin (approximately 8400 cfs per square mile) in southwestern Utah (Crippen and Bue, 1977). It can be seen that very high values of rainfall intensity and very low values of infiltration were necessary to produce such a flood, regardless of the shape of the drainage basin.

**Step 4. Calculate Riprap Size Required**

- a. Assume a trial rock size  $D_{50}$ .
- b. Calculate Manning's "n" value using either (1) the method discussed by Abt et al. (1987) and Abt et al. (1991) if the channel slope is steep and the depth of flow is

small relative to the assumed  $D_{50}$  or (2) using the ACE method (ACE, 1991), if the slope is mild and the depth of flow is large, relative to the assumed  $D_{50}$ .

- c. Calculate normal depth using Manning's equation (Chow, 1959) if the channel cross-section and slope are uniform. Otherwise, a standard-step backwater model, such as HEC-2 (ACE) should be used to determine flow depths and velocities.
- d. Compute the peak shear stress produced in the channel. The peak shear stress for a typical V-shaped or trapezoidal channel will be produced at the point where the depth of flow is the greatest. This depth should be used to compute the design shear stress.
- e. Compute the rock size necessary to resist the design shear stress. Return to (a) if the computed  $D_{50}$  is significantly different from the assumed  $D_{50}$ .

For trapezoidal channels, the Johnson and Abt Method (1998) may be used. The flow rate per unit width can be calculated by dividing the total discharge by the bottom width of the channel.

### 3.3 Recommendations

Recommendations for each design area are discussed in the design procedures. As stated, the rock in the channels should be designed for the peak shear stress (rather than the average shear stress) produced. Manning's "n" values should be determined based on the relative depth of flow in the channel.

In many cases where natural gullies discharge into diversion ditches, it may be necessary to assess the potential for possible clogging of the ditch due to sediment and debris. In cases where the inflow slopes are greater than the ditch slopes, it is possible that the natural gully will be capable of moving large material that the diversion ditch cannot flush out. If the larger material cannot be flushed by the ditch flows, the capacity of the ditch may be compromised, resulting in possible overtopping of the ditch. The following recommendations should be followed in such cases.

1. Diversion ditches should be designed to be self-cleaning.
2. If a ditch cannot be designed to be self-cleaning, it should be designed to contain the sediment/debris that will be deposited in the ditch during the design life. Justification may also be provided to show that there is little or no debris/sediment to be transported. It may also be possible to show that the configuration of the deposits in the ditch will have no adverse effects on either the flow capacity or the stability of the ditch. Analytical methods related to sediment analysis may be found in Appendix E.

### 3.4 Example of Procedure Application

A 15-foot wide trapezoidal channel with 1V on 5H side slopes will be constructed on a 5-percent slope and will carry a discharge of 1000 cfs. Determine the riprap requirements.

Step 1. Assume a trial  $D_{50}$  equal to 2.0 ft (24 inches).

Step 2. Compute Manning's "n" value.

Since the slope is relatively steep, the flow depth is likely to be small relative to the riprap size. Therefore, the "n" value should be computed in accordance with the recommendations of Abt et al. (1988).

Using the equation from Abt et al. (1988)

$$\begin{aligned}n &= 0.0456 (24 \times 0.05)^{.159} \\n &= 0.047.\end{aligned}\tag{D-8}$$

Step 3. Determine normal depth (y).

By trial and error for the trapezoidal channel, with

$n = .047$ ;  $Q = 1000$  cfs; and  $S = 0.05$ ,

$y = 3.0$  ft.

Step 4. Compute the actual shear stress produced.

Using the Safety Factors Method or the simple equation,  $t = WyS$ , which closely approximates the Safety Factors Equation for computing shear stress,

$$t = (62.4) (3.0) (0.05) = 9.36 \text{ lb/ft}^2.\tag{D-9}$$

Step 5. Compute the required rock size.

Using an equation of the ACE (ACE, 1991),

$$t = a(w_s - w_w) (D_{50})\tag{D-10}$$

where:  $a = 0.04$

$W_s =$  unit weight of rock, in  $\text{lb/ft}^3$ , and  $S$

$W_w =$  unit weight of water =  $62.4 \text{ lb/ft}^3$

Based on an assumed stone weight of 165 pounds per cubic foot,

$$t = 4.1 D_{50}\tag{D-11}$$

The required size for the channel bottom rock is calculated to be:

$$D_{50} = t / 4.1 \quad (D-12)$$

$$D_{50} = 9.36 / 4.1 = 2.3 \text{ ft} = 28 \text{ inches.}$$

For the side slopes of the channel, a correction factor is necessary (ACE, 1994), resulting in an increase in rock size.

Since the required rock size (2.3 ft) is greater than the rock size assumed (2.0 ft), another iteration with a larger  $D_{50}$  will be necessary.

Using the Johnson and Abt Method (1998), a riprap size of 16.5 inches is computed, assuming all of the flow is confined to the 15-foot bottom width of the channel.

### 3.5 Limitations

Some design procedures may require several iterations before an agreement can be reached between the assumed and computed rock size. In some cases where the slope is very steep and discharges are very large, a balance may never be able to be reached, indicating that the slope or discharge is so great that riprap protection cannot be feasibly provided. For very steep slopes, use of the Johnson and Abt Method, discussed previously, may be considered in sizing riprap for channels.

## 4 RIPRAP DESIGN FOR APRONS AND DIVERSION CHANNEL OUTLETS

It is usually necessary to direct the flow from a man-made diversion channel into a naturally-occurring gully or stream channel or to discharge the flow onto natural ground at a point where the channel intersects the natural ground surface. In such cases, it is necessary to assure that the flood flows are safely conveyed into the natural environment, without causing erosion and eventual damage to the reclaimed tailings or tailings cover.

### 4.1 Technical Basis

Several methods exist to design riprap erosion protection to prevent erosion of natural soils and soil channels. These methods can be adapted to predict erosive forces that will exist at the outlets of man-made channels and to properly design aprons, toes, and energy dissipation areas. The ACE, for example, has wide experience in designing spillways and reservoir outlet works. Additional rock protection at outlets is almost always recommended to prevent erosion and damage to structures.

## 4.2 Design Procedures

The use of any particular procedure depends on the type of erosion problem to be prevented. In general, the cases most often encountered will be: (1) normal daylight designs where the diversion channel intersects a relatively flat natural slope; or (2) designs where severe gullying has occurred, or will occur, if adequate precautions are not taken.

The typical design case requires that a rock-protected outlet section be provided to reduce flow velocities to a level that can be accommodated by the natural earth section that will receive the flows. In addition, a rock toe is normally provided to protect the ditch outlet against possible future headcutting of any potential gully that could be randomly formed downstream of the outlet. In general, three principal options are available:

1. The outlet section may be sized (widened) such that the shear force produced in the earth section immediately downstream of the rock section is less than the maximum permissible shear force that the earth can withstand.
2. The rock toe to be provided at the outlet should be keyed into competent bedrock, whenever reasonably possible.
3. The toe should be placed to a depth corresponding to the maximum gully depth to be expected. Geomorphic/geologic factors should be considered in the estimation of the maximum depth of gullying to be expected, and scour depths in the natural channel should be computed. Typical toe treatment details are provided in EM 1110-2-1601 (ACE, 1994) and are recommended for determining toe configurations. Scour depths in some natural channels may be estimated using the procedures presented by Abt et al. (1996) as adopted by the U.S. Department of Transportation in Hydrologic Engineering Circular 14. Scour can be computed using the culvert outlet scour approach to determine the expected depth of incision. The depth of scour is a function of the discharge, hydraulic radius, bed material gradation, time of scour, and coefficients for slope. The general equation for estimating scour depth is

$$\frac{d_s}{R_h} = C_s \frac{\alpha}{\sigma^{1/3}} \left( \frac{Q}{g^{1/2} R_h^{5/2}} \right)^\beta \left( \frac{t}{316} \right)^\theta \quad (\text{D-13})$$

where  $D_s$  is the depth of scour;  $R_h$  is the hydraulic radius,  $Q$  is the channel discharge;  $t$  is the time flow in minutes;  $g$  is the acceleration of gravity;  $\alpha$ ,  $\beta$ ,  $\theta$  are coefficients;  $\sigma$  is a material gradation coefficient; and  $C_s$  is the coefficient for slope. The length and width of scour can be estimated in a similar manner. Equation D-13 assumes that little or no replacement of scoured material occurs during the duration of the flood. In many natural channels, extensive replacement by bed load movement occurs, and the resulting scour depth is reduced.



If bedrock exists at a substantial depth, and it is not reasonably feasible to extend the toe depth to this elevation, the toe should be designed to collapse and be sufficiently stable to prevent additional headward gully erosion. In some cases, observations of natural gullies in the area provide an indication of the minimum depth of scour. In addition, another option may be to place the outlet a sufficient distance away from the stabilized tailings so that the tailings will not be affected during the design lifetime, even if some erosion occurs.

The rock size needed for the toe is generally much larger than the rock size for the channel. The rock size is determined by first assuming a configuration for the rock slope as the apron collapses into the scoured area. In general, the slope of the collapsed rock apron should be assumed to be about 1V on 2H (ACE, 1994). For the assumed slope, the rock size is computed by assuming that the PMF flows directly down that slope. For many applications, the rock size thus computed is very large and may not be readily available. If it is necessary to reduce the rock size, it may be possible to engineer a pre-formed rock slope, extending vertically to the expected depth of scour, that has a milder slope than the previously-assumed collapsed slope. In cases where a natural gully exists, it may be possible to construct a wider area that reduces velocities during the transition into the natural gully.

It is also important that an adequate volume of rock be provided to properly armor the collapsed slope. If a pre-formed section and riprap layer are not provided, the dimensions of the toe should be based on the volume of rock required to cover the collapsed slope to a rock depth of about 1 1/2 times the average rock size. General guidance on toe configurations is provided by ACE (1994).

#### 4.3 Recommendations

In general, the bottom elevation of the rock toe at the outlet of a channel or the downstream of an apron should always be placed at an elevation equivalent to the maximum expected depth of scour. Otherwise, the rock toe will be subject to undermining, and damage to the ditch or apron could occur. In many cases, geomorphic (gully headcutting) considerations dictate the maximum depth of erosion.

#### 4.4 Example of Procedure Application

A steep rock-lined channel will discharge a peak flood discharge of 880 cfs from the top of a remediated tailings pile. The channel will have a width of 22 ft and a slope of 10 percent and will discharge into a naturally-occurring gully consisting of uniform sand. The channel will be lined with riprap having a  $D_{50}$  of 15 inches. Determine the toe requirements, assuming the channel is to discharge into the natural gully. Assume flow will extend for 18 hours and the gradation (coefficient of uniformity) is 2.8.

Step 1. Determine depth of scour and dimensions of the scour hole in the natural gully.

For the assumed channel section, flow rate, and flow area, the procedures of the Abt et al. (1996) may be followed, and the depth of scour (D), the width of scour (W), and the length of scour (L) can be computed as follows:

From Section 4.2.1 and Abt et al. (1996),

$$d_s = R_h C_s \frac{\alpha}{\sigma^{1/3}} \left( \frac{Q}{g^{1/2} R_h^{5/2}} \right)^\beta \left( \frac{t}{316} \right)^\theta \quad (\text{D-14})$$

$$\begin{aligned} C_s &= 1.12, \\ \alpha &= 2.27, \\ \beta &= 0.39, \text{ and} \\ \theta &= 0.06 \end{aligned}$$

$$\begin{aligned} \sigma^{1/3} &= (2.8)^{1/3} = 1.41, \\ Q &= 880, t = 18 \text{ hrs} \end{aligned}$$

$R_h = 2.9 \text{ ft} =$  approximate flow depth for rectangular channel

Therefore:

$$\begin{aligned} &= 2.9 (1.12) \left( \frac{2.27}{1.41} \right) \left( \frac{880}{(32.2)^{1/2} (2.9)^{5/2}} \right)^{0.39} \left( \frac{18 \times 60}{316} \right)^{0.06} \\ &= 14.3 \text{ ft.} \end{aligned} \quad (\text{D-15})$$

Similar computations can be made to compute the width and length of scour.

Step 2. Determine toe configuration.

The toe configuration may be evaluated using ACEEM 1110-2-1601 (1994). Using the figures given in Plates 37 and 38, the minimum thicknesses and general configuration of the toe area are determined, using the dimensions derived in Step 1.

Step 3. Determine rock size and volume needed.

The rock size may be determined using design procedures developed by Abt and Johnson (1998).

The rock size of 15 inches for the channel was computed using the equation:

$$D_{50} = 5.23 q^{0.56} S^{0.43}$$

where:  $q = 880/22$   
 $S = 1/10 = 0.1$

For an assumed collapsed slope of 1V on 2H, the required rock size is computed as follows:

$$q = 880/22 = 40 \text{ cfs/ft}$$

$$S = 1/2 = 0.5$$

$$D_{50} = 30 \text{ inches}$$

The volume of rock needed in the toe is computed by multiplying the length of the collapsed slope by the layer thickness needed.

#### 4.5 Limitations

The scour depths, slopes, and designs developed using the aforementioned procedures should always be verified by careful analysis of site-specific geomorphic variables. Adjustments may need to be made to the design, based on geomorphic considerations.

### 5 RIPRAP DESIGN FOR PROTECTION FROM FLOODING FROM NEARBY STREAMS

#### 5.1 Technical Basis

Design of riprap for the stream banks of channels is well-established and is relatively simple. The ACE and other Federal agencies have developed procedures for designing such protection.

#### 5.2 Design Procedure

The following procedure may be used for the determination of riprap requirements for the banks of major streams or the side slopes of reclaimed tailings piles, where floods impinge.

Step 1. Determine peak flow rate.

Depending on the size of the stream, various methods may be used to determine peak flow rates. For large streams, the procedures discussed in Regulatory Guide 1.59 (NRC, 1979) may be used.

Step 2. Determine depth (y) and velocity (V) of flow and the slope of the energy grade line (S) at the location where riprap will be provided.

In general, HEC-2 (ACE) provides an acceptable computational model for estimating these design parameters.

Step 3. Determine peak shear stress.

Step 4. Determine the riprap size needed to resist the computed shear stress, with corrections made for the side slope, bends, and other forces.

### 5.3 Recommendations

Because of the possibility of variability of depth and slope between adjacent cross-sections in a flow profile, the use of average values of these parameters should also be considered. Several adjacent sections should be examined, and engineering judgment and site-specific considerations should be used to estimate these design parameters.

### 5.4 Example of Procedure Application

It is proposed that riprap will be placed on the 1V on 2H side slope of a natural stream. Determine the riprap size required, given the parameters discussed in the following steps:

Step 1. The peak flow in a stream with a drainage area of 200 square miles is calculated using HEC-1 (ACE) to be 200,000 cfs.

Step 2. Using HEC-2 (ACE), the following design variables are computed at the location in question:

y = depth of flow = 10.2 ft

S = slope of energy grade line = 0.008

V = velocity of flow = 15 ft/sec.

Step 3. Using the simple relationship,  $t = WyS$ , the peak shear stress is calculated to be:

$$t = (62.4) (10.2) (0.008) \quad (D-16)$$

t = 5.09 pounds per square foot.

Step 4. The riprap size is calculated to be:

$$D_{50} = t / 4.1 = 5.09 / 4.1 = 1.24 \text{ ft.} \quad (\text{D-17})$$

For a 1V on 2H side slope, a correction factor of 0.72 is found using ACE procedures (1991). The corrected riprap size is found to be:

$$D_{50} = 1.24 / 0.72$$

$$D_{50} = 1.7 \text{ ft.}$$

The Safety Factors Method or ACE procedures may also be used. This method was selected for simplicity.

The toe of the riprap slope should be designed in accordance with procedures of the ACE (1994) or Abt et al. (1998), with regard to toe width, thickness, length, and general configuration. Potential scour depths should be estimated, and the riprap toe should extend to that depth.

## 5.5 Limitations

Use of this procedure relies heavily on the computational model used to calculate flow depth and slope. Calculation of depth and slope are usually sensitive to small changes in "n" values, expansion or contraction coefficients, and length between sections.

## 5.6 Launching Erosion Protection

In many cases, a waste disposal impoundment may be situated adjacent to a stream, river, or diversion system in which lateral bank instability may result in channel migration and bank erosion. In some cases, it is possible to armor the channel toe and/or bank to resist the erosion processes. However, situations occur in which slope armor may not be practical. The U.S. Army Corps of Engineers (ACE) has developed the concept of a windrow revetment. A windrow revetment consists of rock placed on the top of bank, or floodplain, surface landward from the existing bankline at a pre-determined location, beyond which additional erosion is to be prevented (Biedenharn et al., 1997). As the channel migrates into the windrow, stone fills the eroded area and is "launched" along the bank face to the toe of the slope. Eventually, the launched stone armors the toe and bank, thereby providing erosion protection and reducing or eliminating the erosion processes.

Guidance for the installation of windrowed or trench stone placed on the top outer bank of a migrating stream/river is limited. Riprap stones may be sized using Safety Factors (or methods discussed by Biedenharn et al.) to resist the outer bank velocity expected at the bank toe in the channel. Rock may be placed along the top bank via two methods:

**Windrow:** Riprap may be windrowed along the top bank. The outermost edge of the rock should be set back from the bank crest approximately three to five feet to prevent premature collapse into the migrating channel. The bank slope should be covered with a uniform rock layer approximately  $D_{100}$  in thickness.

**Trench Rock:** In some instances, it may be advantageous to excavate a trench parallel to the bank line, offset three to five feet from the outer bank edge. The trench should be at least eight to ten feet wide and compatible with available excavation equipment. The trench depth should be designed to store a sufficient volume such that as the bank collapses into the migrating channel, the bank slope is covered with a uniform rock layer of at least  $D_{100}$  in thickness.

### 5.6.1 Applications

Windrow revetment may be appropriate for emergency situations, when time is limited for detailed design, when high river stages and velocities prevent normal construction operations, or when the rate of channel migration prevents normal construction operations. The site conditions, availability of materials, and equipment and labor, in practice dictate the design, which must be performed concurrently with mobilization of resources and the beginning of construction. The approach is to quickly feed a resistant material into the stream at the most critical points, continuing the operation until the crisis passes.

### 5.6.2 Design Considerations

The design of windrow revetment requires that a geotechnical analysis be performed to determine if the risk of mass bank failure during or after launching is acceptable, although it is impossible to obtain the same degree of geotechnical safety with windrow revetment as with more conventional methods. Based on laboratory studies conducted at the U.S. Army Waterways Experiment Station, a rectangular shape for the windrow was found to be the best windrow shape. This shape supplies an initial surge of stone which counters the thinning effect of the scour in the toe zone of the forming revetment. The remaining portion of the windrow then provides a ready supply of stone to produce a uniform paving. However, this shape does require the excavation of a trench for placement of the stone along the top bank. The second best windrow shape is trapezoidal. It has advantages over the rectangular shape in that no trench is needed to contain the windrow stone. The trapezoidal shape supplies a steady supply of stone similar to the rectangular shape. The triangular shape is the least desirable shape. The triangular shape supplies more stone initially, but the quantity of stone diminishes as the windrow is undercut.

The velocity and characteristics of the stream dictate the size of stone used to form the windrow revetment. The stone must be large enough to resist being transported by the stream. The stone may be sized in accordance with the guidelines presented in ACE EM-1110-2-1601 (1994) or by methods discussed by Biedenharn et al. A well graded mass of rock should be provided to ensure that the revetment does not fail from leaching of the underlying bank material.

## 6 RIPRAP SIZING AT TOE OF EMBANKMENT SLOPES

Rock toes, or toe basins, are often placed at the base of sloped embankments to: stabilize and/or anchor rock placed on the side slope; serve as a toe drainage channel, serve as an impact basin and provide for energy dissipation from tributary flow; provide erosion protection at the toe; transition flow from the side slope to adjacent properties; and/or provide gully intrusion protection to the embankment. Therefore, proper rock sizing is an imperative element of the design process to meet the project stability requirements.

### 6.1 Technical Basis

Rock sizing procedures have been developed by the U.S. Bureau of Reclamation (USBR) for stilling basins founded, based on the work of Berry (1948) and as presented by the Department of the Interior (DOI, 1978). The procedure estimates the median stone size as a function of localized bottom velocity ( $V_b$ ) at the location where the flow transitions onto a stone-filled basin. If the bottom velocity cannot be determined, the local average velocity may be substituted where the local average velocity can be determined using the U.S. Army Corps of Engineers procedures (ACE, 1994). Campbell (1966) presented a velocity-based riprap design procedure for stone placed in stilling basins. Both the USBR and Campbell rock sizing procedures were developed to dissipate energy and provide a stable toe as flow transitioned onto a rock basin or apron. These procedures are difficult to apply for relatively small rock requirements (less than 0.3 m) and yield conservative rock sizes.

To better understand the phenomena and mechanisms affecting the design of riprap to prevent erosion by overtopping flow as it transitions from the side slope to the embankment toe and/or apron, the U.S. Nuclear Regulatory Commission staff sponsored technical assistance efforts. As a result of these efforts, an alternative method of sizing the median stone size ( $D_{50}$ ) for riprap placed at the toe of the slope was developed.

Abt et al. (1998) empirically derived an equation to compute the median stone size for riprap used to prevent erosion from flow transitioning off an embankment side slope onto the toe region. The relationship is expressed in English units as

$$D_{50} = 10.46 * S^{0.43} * (C_f * q_d)^{0.56} \quad (D-18)$$

where:  $D_{50}$  = the median stone diameter in inches,

$S$  = the embankment side slope in decimal form,

$C_f$  = the flow concentration factor,

$q_d$  = the design unit discharge in cubic ft per second.

Equation D-14 can be expressed in SI units as

$$D_{50} = 100.5 * S^{0.43} * (C_f * q_d)^{0.56} \quad (D-19)$$

where  $D_{50}$  is expressed in mm and  $q_d$  is in  $m^3/s/m$ . The riprap should be placed on an appropriately sized bedding material.

## 6.2 Design Procedure

A simplified step-by-step procedure for designing a riprap apron or basin placed at the toe of the slope of a waste or uranium tailings embankment is presented as follows:

- Step 1. Determine the design tributary unit discharge ( $q_d$ ) expected to transition from the embankment side slope onto the toe apron. Runoff should be based upon the Probable Maximum Flood (PMF) and Probable Maximum Precipitation (PMP) as presented in Section D2.2.
- Step 2. Determine the embankment side slope,  $S$ , in decimal form immediately upstream to the transition area near the toe.
- Step 3. Determine the flow concentration factor,  $C_f$ , to be applied. Based on the studies performed, a factor of 2 to 3 is recommended (Abt et al., 1991).
- Step 4. The median rock size of the riprap apron or basin can be computed by entering the design unit discharge, embankment side slope, and flow concentration factor into Equation D-18 for English units. It should be noted that the methods by DOI and Campbell yield conservative median stone sizes and may also be used for sizing the riprap apron and/or basin.

## 6.3 Recommendations

The NRC staff considers the stone sizing procedures by DOI (1978), Campbell (1966), and Abt et al. (1998) to be acceptable for sizing riprap for toe aprons and basins. It is important that appropriate filters/bedding be placed to support the riprap and provide good drainage. Also, the apron/basin rock should extend from the toe outward a minimum of 15 median rock sizes (Robinson et al., 1998). Angular stones should be used for riprap apron/basin applications. The rock should be placed at a thickness of about  $3-D_{50}$ s. Volume requirements, based on the depth of scour (see Section D.4) or depth of gully intrusion, should also be factored into the design. The procedures discussed in Section D.4 may also be used to estimate rock sizes and volumes.



#### 6.4 Example of Procedure Application

The design of the toe riprap is controlled, in this example, by the flow that exits the rock apron and discharges into a natural gully. The rock must be large enough and the toe must have sufficient volume to launch into the gully and stabilize the entire gully cross-section. If the flow discharges onto relatively flat ground with little or no potential for gully intrusion, this design procedure is not needed. In such a case, the rock size for the toe only needs to be about 50% larger than the side slope rock to account for turbulence as the flow transitions from a steep to a milder slope.

For this example, the designer must determine the median stone size requirements for a riprap apron to be placed at the toe of a uranium mill tailings slope to transition flow from the side slope to an adjacent natural tributary drainage. The embankment side slope is 20% with a design unit discharge of 0.7 cubic ft per second.

- Step 1. The tributary design unit discharge is 0.7 cfs/ft.
- Step 2. The side slope expressed in decimal form is 0.20.
- Step 3. The flow concentration is determined to be 3, assuming that flow from the apron enters a natural gully.
- Step 4. Inputting the variables determined in steps 1-3 into Equation D-14 (Abt et al., 1998) yields a median stone size as:

$$D_{50} = 10.46 * (0.20)^{0.43} * (3.0 * 0.70)^{0.56} \quad (D-20)$$

$$D_{50} = 10.46 * 0.50 * 1.52$$

$$D_{50} = 7.95 \text{ inches or approximately } 8 \text{ inches} = 0.66 \text{ ft.}$$

- Step 5. The apron should extend a minimum distance of  $15 \cdot D_{50}$ s from the toe. Therefore,

$$\text{Minimum apron length} = 15 * 0.66 \text{ ft.} = 10 \text{ ft.}$$

The apron length may need to be larger if the depth of scour is unusually large. The need for additional rock volume should be assessed.

- Step 6. The thickness of the apron should be about  $3 \cdot D_{50}$ s thick. Therefore, the

$$\text{Apron thickness} = 3 * 0.66 \text{ ft.} = 2 \text{ ft.}$$

## 7 OVERSIZING OF MARGINAL-QUALITY EROSION PROTECTION

### 7.1 Technical Basis

The ability of some rock to survive without significant degradation for long time periods is well-documented by archaeological and historic evidence (Lindsey et al. , 1982). However, very little information is available to quantitatively assess the quality of rock needed to survive for long periods, based on its physical properties.

In assessing the long-term durability of erosion protection materials, the NRC staff has relied principally on the results of durability tests at several sites and on information, analyses, and methodology presented in NUREG/CR-4620 (Nelson et al., 1986) and on previous NRC guidance. Staff review of actual field data from several tailings sites has indicated that the methodology may not be sufficiently flexible to allow the use of "borderline" quality rock, where a particular type of rock fails to meet minimum qualifications for placement in a specific zone, but fails to qualify by only a small amount. This may be very important, since the selection of a particular rock type and rock size depends on its quality, where it will be placed on the embankment, and the climate of the site.

Based on an examination of the actual field performance of various types and quality of rock (Esmiol, 1967), the NRC staff considers it important to determine rock properties with a petrographic examination. The case history data indicated that the single most important factor in rock deterioration was the presence of smectites and expanding lattice clay minerals. Therefore, if a petrographic examination indicates the presence of such minerals (or minerals that may weather to expansive clays), the rock will not be suitable for long-term applications.

In the arid and semi-arid regions of the United States, high quality rock materials may not be immediately available for erosion protection. When these conditions prevail, sandstone materials may be considered. The NRC supported a study by Abt et al. (1994) to evaluate the potential long-term durability of sandstone materials for use at waste impoundments. The investigation included a comprehensive review of the literature on the degradation of sandstone, examination of archaeological data (petroglyphs and ruins in sandstone materials), examination of matched photographs taken over long periods (approximately 100 years), and testing of rock (sandstone, basalt, tuff and limestone) samples to determine their quality and expected long-term durability.

The Abt et al. investigation determined that some sandstones materials are available that meet or exceed minimum rock quality durability standards for use as erosion control. Abt et al. (1994) also reported that sandstone materials have remained relatively stable at petroglyph and ruin sites for periods of about 1,000 years, as shown in Figure D-2 and Figure D-3. Further, photographic comparisons illustrated that sandstone boulders exposed to river environments have remained stable after 100 years of documentation. The study concluded sandstone materials may be considered for erosion control in infrequently saturated areas with good drainage conditions, that a thorough petrographic examination is necessary to identify poor material characteristics (i.e., calcite bonding agents, etc.), and that the tensile test may not be a good indicator of rock quality/durability for sandstone materials.



**Figure D-2.** Sandstone ruin near Blanding, Utah.

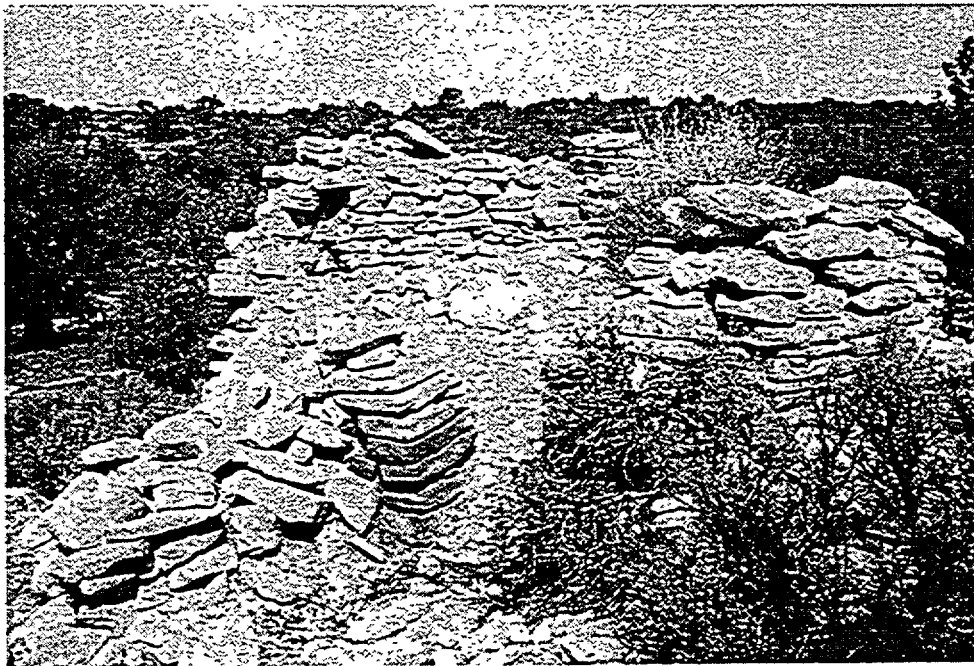

**Figure D-3.** Sandstone ruin near Durango, Colorado.

Based upon the results of this study in conjunction with staff field experience, the staff will consider the use of sandstones for erosion control applications. Additional information concerning the use of sandstone materials is presented in Section 7.2.3.

## 7.2 Design Procedures

Design procedures and criteria have been developed by the NRC staff for use in selecting and evaluating rock for use as riprap to survive long time periods. The methods are considered to be flexible enough to accommodate a wide range of rock types and a wide range of rock quality for use in various long-term stability applications.

The first step in the design process is to determine the quality of the rock, based on its physical properties. The second step is to determine the amount of oversizing needed, if the rock is not of good quality. Various combinations of good-quality rock and oversized marginal-quality rock may also be considered in the design, if necessary.

### 7.2.1 Procedures for Assessing Rock Quality

The suitability of rock to be used as a protective cover should be assessed by laboratory tests to determine the physical characteristics of the rocks. Several durability tests should be performed to classify the rock as being of poor, fair (intermediate), or good quality. For each rock source under consideration, the quality ratings should be based on the results of about three to five different durability test methods for initial screening and about five test methods for final sizing of the rock(s) selected for inclusion in the design. Procedures for determining the rock quality and determining a rock quality "score" are developed in Table D1.

### 7.2.2 Oversizing Criteria

Oversizing criteria vary, depending on the location where the rock will be placed. Areas that are frequently saturated are generally more vulnerable to weathering than occasionally saturated areas where freeze/thaw and wet/dry cycles occur less frequently. The amount of oversizing to be applied will also depend on where the rock will be placed and its importance to the overall performance of the reclamation design. For the purposes of rock oversizing, the following criteria have been developed:

1. Critical Areas. These areas include, as a minimum, frequently-saturated areas, all channels, poorly-drained toes and aprons, control structures, and energy dissipation areas.  

<u>Rating</u>	
80-100	- No Oversizing Needed
65-80	- Oversize using factor of (80-Rating), expressed as the percent increase in rock diameter. For example, a rock with a rating of 70 will require oversizing of 10 percent. (See example of procedure application, given in Section 6.4).
Less than 65	- Reject

2. Non-Critical Areas. These areas include occasionally-saturated areas, top slopes, side slopes, and well-drained toes and aprons.

Rating

- |              |   |  |
|--------------|---|--|
| 80-100       | - | No Oversizing Needed   |
| 50-80        | - | Oversize using factor of (80-Rating), expressed as the percent increase in rock diameter |
| Less than 50 | - | Reject   |

**Table D-1. Scoring criteria for determining rock quality.**

Laboratory Test	Weighting Factor			Score										
	Lime-stone	Sand-stone	Igneous	10	9	8	7	6	5	4	3	2	1	0
				Good			Fair				Poor			
Sp. Gravity	12	6	9	2.75	2.70	2.65	2.60	2.55	2.50	2.45	2.40	2.35	2.40	2.25
Absorption, %	13	5	2	.10	.30	.50	.67	.83	1.0	1.5	2.0	2.5	3.0	3.5
Sodium Sulfate, %	4	3	11	1.0	3.0	5.0	6.7	8.3	10.0	12.5	15.0	20.0	25.0	30.0
L/A Abrasion (100 revs). %	1	8	1	1.0	3.0	5.0	6.7	8.3	10.0	12.5	15.0	20.0	25.0	30.0
Schmidt Hammer	11	13	3	70	65	60	54	47	40	32	24	16	8	0

1. Scores were derived from Tables 6.2, 6.5, and 6.7 of NUREG/CR-2642 - "Long-Term Survivability of Riprap for Armoring Uranium Mill Tailings and Covers: A Literature Review," 1982.
2. Weighting Factors are derived from Table 7 of "Petrographic Investigations of Rock Durability and Comparisons of Various Test Procedures," by G. W. DuPuy, Engineering Geology, July 1965. Weighing factors are based on inverse of ranking of test methods for each rock type. Other tests may be used; weighing factors for these tests may be derived using Table 7, by counting upward from the bottom of the table.
3. Test methods should be standardized, if a standard test is available and should be those used in NUREG/CR-2642, so that proper correlations can be made.

### 7.2.3 Guidelines for Using Sandstone Materials

The staff will consider using sandstone materials for erosion control applications at waste disposal sites. However, only sandstones of relatively good quality will be accepted. The staff suggests that specific procedures for construction, quality assurance and quality control (QA/QC), and material testing be followed. Specific recommendations include the following:

1. Potential sandstone materials to be used for erosion control should be assessed using the rock quality evaluation procedures presented in Section 7.2.1. The score should be at least 50.
2. Based on the petrographic analysis, the sandstone should have the following physical and chemical properties that will resist long-term physical and chemical weathering under both dry and saturated conditions:
  - The sandstones should be fine-grained sand cemented with quartz. (Quartz is an inert silica mineral highly resistant to weathering. Weathering or alteration of quartz mineralization is a very slow process.) Carbonate mineralized sandstones may be present, but the climate should be such that the predominant dry weather results in high evaporation rates and limited rock saturation. Climatic conditions should also result in high pH, which should not affect the rock calcite mineralization.
  - Close visual inspection should indicate that the rock porosity is relatively low (fine grained, well-cemented with few fractures and no joint pores or rusts); therefore, the effects of interstitial freeze-thaw are low or insignificant.
  - Vertical or horizontal joints, fractures, seams or parting of the rock blocks, which tend to induce ice wedging, should be relatively insignificant.
  - The boulders should be sufficiently large even if breakage occurs due to excavation/handling. Larger boulders with calcite-cemented joints, could split in half from additional handling but would still have large effective sizes.
  - The sandstone rock should be derived from massive bedded formations where boulders with any significant type of bedding are in the minority within the stockpiles of boulders. Those bedding planes which do not have silt or clay lamination, (mostly observed as cross bedding with short lateral extent), should be uniformly cemented and show minimal signs of deterioration on weathered or desert varnished surfaces. Schmidt hammer tests that are normal and parallel to the bedding planes should show there is no decrease in strength associated with these features from the massive unbedded portions.
3. Field procedures should include a rock monitoring plan. Aspects that should be incorporated as part of these procedures are:

- A licensed professional geologist should be selected to make quality determinations and to label "satisfactory" sandstones.
- The rocks selected for placement should be visually inspected for consistency in grain size, porosity, cementing and durability. The rocks should not contain joints or planes of weakness with a spacing of less than the required  $D_{50}$  and should be predominantly angular and blocky in shape. As necessary, devices such as a Schmidt hammer, geologist hammer and magnifying lens should be utilized in the selection process. The general selection process should be carefully documented, (e.g., with a videotape where appropriate).
- All "unsatisfactory" rocks will be identified and separated from the "satisfactory" rocks. (This operation should be reasonably achievable if the sizes are large).
- The geologist should train QA/QC personnel to assist in the inspection/selection procedures. The training of the QA/QC inspector will include selection of unfractured boulders, identifying uncracked seams, and checking for particle shapes to assure they meet the maximum and minimum dimensions criteria. The rock monitoring plan can be enhanced by using Schmidt Hammer tests throughout rock selection and placement. Schmidt Hammer data of "satisfactory" sandstone rocks should indicate that the "R" value of these rocks ranges from 40 to 48. For example, sandstone rocks passing field visual inspection and having "R" values higher than 40 may be considered suitable.
- Videotape and/or photographs will be provided to document rock selection, testing (if required), hauling and placement.

### 7.3 Recommendations

Based on the performance histories of various rock types and the overall intent of achieving long-term stability, the following recommendations should be considered in assessing rock quality and determining riprap requirements for a particular design.

1. The rock that is to be used should first be qualitatively rated at least "fair" in a petrographic examination conducted by a geologist or engineer experienced in petrographic analysis. See NUREG/CR-4620, Table 6.4, for general guidance on qualitative petrographic ratings. In addition, if a rock contains smectites or expanding lattice clay minerals, it will not be acceptable. Also, if a rock type contains minerals that will weather to clays, this rock type will not be acceptable.
2. An occasionally-saturated area is defined as an area with underlying filter blankets and slopes that provide good drainage and are steep enough to preclude ponding, considering differential settlement, and are located well above normal groundwater levels; otherwise, the area is classified as frequently-saturated. Natural channels and relatively flat man-made diversion channels should be classified as frequently-saturated. Generally, any toe or apron located below grade should be



classified as frequently-saturated; such toes and aprons are considered to be poorly-drained in most cases.

3. Using the scoring criteria given in Table D-1, the results of a durability test determines the score; this score is then multiplied by the weighting factor for the particular rock type. The final rating should be calculated as the percentage of the maximum possible score for all durability tests that were performed. See example of procedure application for additional guidance on determining final rating.
4. For final selection and oversizing, the rating may be based on the durability tests indicated in the scoring criteria. Not all of these tests must be performed to assess the rock quality. Other tests may also be substituted or added, as appropriate, depending on rock type and site-specific factors. The durability tests given in Table D-1 are not intended to be all-inclusive. They represent some of the more commonly-used tests or tests where data may be published or readily-available. Designers may wish to use other tests than those presented; such an approach is acceptable. Scoring criteria may be developed for other tests, using procedures and references recommended in Table D-1. Further, if a rock type barely fails to meet minimum criteria for placement in a particular area, with proper justification and documentation, it may be feasible to throw out the results of a test that may not be particularly applicable and substitute one or more tests with higher weighting factors, depending on the rock type or site location. In such cases, consideration should be given to performing several additional tests. The additional tests should be those that are among the most applicable tests for a specific rock type, as indicated by the highest weighting factors given in the scoring criteria for that rock type.
5. The percentage increase of oversizing should be applied to the diameter of the rock.
6. The oversizing calculations represent minimum increases. Rock sizes as large as practicable should be provided. (It is assumed, for example, that a 12-inch layer of 4-inch rock costs the same as a 12-inch layer of 6-inch rock.) The thickness of the rock layer should be based on the constructability of the layer, but should be at least  $1.5 \times D_{50}$ . Thicknesses of less than 4 inches may be difficult to construct, unless the rock size is relatively small.
7. Sandstone may be used in areas that require large rock sizes, but, in general, should not be used on the top slopes of a disposal cell where drainage may be poor.

#### 7.4 Example of Procedure Application

It is proposed that a sandstone rock source will be used. The rock has been rated "fair" in a petrographic examination. Representative test results are given. Compute the amount of oversizing necessary.

Using the scoring criteria in Table D-1, the following ratings are computed:

Lab Test	Result	Score	Weight	Score & Weight	Max. Score
Sp. Gr.	2.61	7	6	42	60
Absorp., %	1.22	4	5	20	50
Sod. Sulf., %	6.90	6	3	18	30
L.A. Abr., %	8.70	5	8	40	80
Sch. Ham.	51	6	13	78	130
Totals				198	350

The final rating is computed to be 198/350 or 57 percent. As discussed in Section 6.2, the rock is not suitable for use in frequently-saturated areas, but is suitable for use in occasionally-saturated areas, if oversized. The oversizing needed is equal to (80 - 57), or a 23 percent increase in rock diameter.

### 7.5 Limitations

The procedure previously presented is intended to provide an approximate quantitative method of assessing rock quality and rock durability. Although the procedure should provide rock of reasonable quality, additional data and studies are needed to establish performance histories of rock types that have a score of a specific magnitude. It should be emphasized that the procedure is only a more quantitative estimate of rock quality, based on USBR classification standards.

It should also be recognized that durability tests are not generally intended to determine if rock will actually deteriorate enough to adversely affect the stability of a reclaimed tailings pile for a design life of 200 to 1,000 years. These tests are primarily intended to determine acceptability of rock for various construction purposes for design lifetimes much shorter than 1,000 years. Therefore, although higher scores give a higher degree of confidence that significant deterioration will not occur, there is not complete assurance that deterioration will not occur. Further, typical construction projects rely on planned maintenance to correct deficiencies. It follows, then, that there is also less assurance that the oversizing methodology will actually result in rock that will only deteriorate a given amount in a specified time period. The amount of oversizing resulting from these calculations is based on the engineering judgment of the NRC staff, with the assistance of contractors. However, the staff considers that this methodology will provide reasonable assurance of the effectiveness of the rock over the design lifetime of the project.

## 8 REFERENCES

- Abt, S. R., Khattak, M. S., Nelson, J. D., Ruff, J. F., Shaikh, A., Wittler, R. J., Lee, D. W., and Hinkle, N. E., "Development of Riprap Design Criteria by Riprap Testing in Flumes: Phase I," NUREG/CR-4651, 1987.
- Abt, S. R., Khattak, M. S., Nelson, J. D., Ruff, J. F., Shaikh, A., Wittler, R. J., Lee, D. W., and Hinkle, N. E., "Development of Riprap Design Criteria by Riprap Testing in Flumes: Phase II," NUREG/CR-4651, Vol. 2, 1988.
- Abt, S. R. and Johnson, T. L., "Riprap Design for Overtopping Flow." J. of Hydr. Engr., ASCE, 117(8), pp. 959-972, August 1991.
- Abt, S. R., Johnson, T. L., Thornton, C. I., and Trabant, S. C., "Riprap Sizing at the Toe of Embankment Slopes." J. of Hydr. Engr., ASCE, in press, 1998.
- Abt, S. R., Peters, M. R., Thornton, C. I., Hogan, S. A., and Wilkerson, G. V., "Methodologies for Design of Soil Covers - Interim Report III: Gully Intrusion Into Reclaimed Slopes - Rock Durability Assessment." Report prepared for the U.S. Nuclear Regulatory Commission, NMSS, Washington, DC, November 1994.
- Abt, S. R., Ruff, J. F., and Wittler, R. J., "Estimating Flow Through Riprap." J. of Hydr. Engr., ASCE, 117(5), pp. 670-675, May 1991.
- Abt, S. R., Thompson, P. I., and Lewis, T. M., "Enhancement of the Culvert Outlet Scour Estimation Equations." Geometric and Other General Design Issues, Transportation Research Record, No. 1523, pp. 178-184, 1996.
- Abt, S. R., Wittler, R. J., Ruff, J. F., and Khattak, M. S., "Resistance to Flow over Riprap in Steep Channels." Water Resources Bulletin, AWRA, 24(6), pp. 1193-1200, December 1988
- Berry, N. K., "The Start of Bed Load Movement." Masters Thesis, University of Colorado, Boulder, CO, 1948.
- Biedenharn, D. S., Elliott, C. M. and Watson, C. C., "The WES Investigation and Streambank Stabilization Handbook." U.S. Army Corps of Engineers, Vicksburg, MS, October 1997.
- Campbell, F. B., "Hydraulic Design of Rock Riprap." Misc. Paper No. 2-777, Office of the Chief of Engineers, U.S. Army Waterways Experiment Station, Vicksburg, MS, 1966.
- Chow, V. T., **Open-Channel Hydraulics**, McGraw-Hill Book Company, Inc., New York, NY, 1959.
- Crippen, J. R. and Bue, C. D., "Maximum Flood Flows in the Conterminous United States," U.S. Geological Survey Water-Supply Paper 1887, Washington, DC, 1977.

- Department of the Interior (DOI), **Hydraulic Design of Stilling Basins and Energy Dissipators**, Engineering Monograph No. 25, U.S. Bureau of Reclamation, U.S. Department of the Interior, Washington, DC, 1978.
- DuPuy, G. W., "Petrographic Investigations of Rock Durability and Comparisons of Various Test Procedures," **Engineering Geology**, July 1965.
- Esmiol, E. E., "Rock as Upstream Slope Protection for Earth Dams - 149 Case Histories," U.S. Bureau of Reclamation, Report No. DD-3, September 1967.
- Johnson, T. L. and Abt, S. R., "Design of Channel Riprap Using Overtopping Flow Methods." Proceeding of the First Federal Interagency Hydrologic Modeling Conference, Las Vegas, NV, April 19-23, 1998.
- Leps, T. M., "Flow Through Rockfill." **Embankment Dam Engineering**, John Wiley and Sons, pp. 87-107, 1973.
- Lindsey, C. G., L. W. Long, and Gegej, C. W., "Long-Term Survivability of Riprap for Armoring Uranium Mill Tailings and Covers: A Literature Review, NUREG/CR-2642 (PNL-4225), U.S. Nuclear Regulatory Commission, Washington, DC, 1982.
- Nelson, J. D., Abt, S. R., Volpe, R. L., van Zyl, D., Hinkle, N. E. and Staub, W. P., "Methodologies for Evaluating Long-Term Stabilization Designs of Uranium Mill Tailings Impoundments." NUREG/CR-4620, U.S. Nuclear Regulatory Commission, Washington, DC, 1986.
- Nelson, J. D., Volpe, R. L. Wardwell, R. E., Schumm, S. A., Staub, W. P., "Design Considerations for Long-Term Stabilization of Uranium Mill Tailings Impoundments," NUREG/CR-3397 (ORNL-5979), U.S. Nuclear Regulatory Commission, Washington, DC, 1983.
- Nilsson, S., "Tensile Strength and Compressive Strength of Concrete Determined on the Same Cube," R.I.L.E.M. Bulletin 17, December 1962.
- Robinson, K. M., Rice, C. E., and Kadavy, K. C., "Design of Rock Chutes." Transactions of ASAE, in press, 1998.
- U.S. Army Corps of Engineers (ACE), Hydrologic Engineering Center, "Flood Hydrograph Package, HEC-1," continuously updated and revised.
- U.S. Army Corps of Engineers (ACE), Hydrologic Engineering Center, "Water Surface Profiles, HEC-2," continuously updated and revised.
- U.S. Army Corps of Engineers (ACE), "Hydraulic Design of Flood Control Channels," EM 1110-2-1601, Office of the Chief of Engineers, Washington, DC, 1994.

U.S. Army Corps of Engineers (ACE), "Hydraulic Design of Reservoir Outlet Works." EM1110-2-1602, Office of the Chief of Engineers, Washington, DC, 1980.

U.S. Bureau of Reclamation (USBR), **Design of Small Dams**, 1977.

U.S. Department of Transportation (USDOT), "Hydraulic Design of Energy Dissipators for Culverts and Channels," Hydraulic Engineering Circular No. 14, 1983.

U.S. Nuclear Regulatory Commission, Regulatory Guide 1.59, "Design Basis Floods for Nuclear Power Plants," 1979.

U.S. Nuclear Regulatory Commission (NRC), "Uranium Mill Tailings Management Position," 1989.

U.S. Soil Conservation Service, "Design of Open Channels." Technical Release 25, U.S. Department of Agriculture, Engineering Division, Washington, DC, 1977.

# APPENDIX E

## SEDIMENT YIELD

### CONTENTS

	<i>Page</i>
<b>1 INTRODUCTION</b> .....	E-1
<b>2 TECHNICAL BASIS</b> .....	E-1
2.1 <u>Sheet and Rill Erosion</u> .....	E-2
2.2 <u>Gully Erosion</u> .....	E-3
2.3 <u>Estimated Sediment Yield</u> .....	E-3
2.4 <u>Measured Sediment Yield</u> .....	E-4
2.5 <u>Trap Efficiency</u> .....	E-6
2.6 <u>Sediment Transport Capacity of a Channel</u> .....	E-6
<b>3 DESIGN AND ANALYSIS PROCEDURES</b> .....	E-8
3.1 <u>Sheet and Rill Erosion Procedure</u> .....	E-8
3.2 <u>Gully Erosion Procedure</u> .....	E-10
3.3 <u>Estimated Sediment Yield Procedure</u> .....	E-10
3.4 <u>Measured Sediment Yield Procedure</u> .....	E-11
3.5 <u>Trap Efficiency Procedure</u> .....	E-12
3.6 <u>Sediment Transport Capacity Procedure</u> .....	E-12
<b>4 RECOMMENDATIONS</b> .....	E-14
<b>5 EXAMPLE OF PROCEDURE APPLICATION</b> .....	E-14
5.1 <u>Example of Sheet and Rill Erosion Procedure</u> .....	E-15
5.2 <u>Example of Gully Erosion Procedure</u> .....	E-19
5.3 <u>Example of Estimated Sediment Yield Procedure</u> .....	E-19
5.4 <u>Example of Measured Sediment Yield Procedure</u> .....	E-21
5.5 <u>Example of Trap Efficiency Procedure</u> .....	E-21
5.6 <u>Example of Sediment Transport Capacity Procedure</u> .....	E-23
<b>6 LIMITATIONS, FIELD VERIFICATIONS AND     COMPUTER APPLICATIONS</b> .....	E-23
<b>7 REFERENCES</b> .....	E-26

## **APPENDIX E**

### **SEDIMENT YIELD**

#### **1 INTRODUCTION**

For the reclamation of many uranium mill tailings sites, sedimentation of diversion channels can be a significant problem. Many tailings impoundments were formed by building a dam across a natural stream channel and impounding tailings and water behind the dam. In the development of a reclamation plan for such sites, it is usually necessary to construct a diversion channel to re-route flood flows around the contaminated tailings. Because of slope and grade limitations, the diversion channel usually has a milder slope than the natural channel. If a decision is made to increase the channel slope to conform to natural grades, it is usually necessary to provide rock riprap to protect the channel against erosion. To avoid the need for erosion protection, diversion channels are generally constructed at relatively mild slopes and are likely to trap large sediment volumes.

In general, sediment deposition can be a significant problem in diversion channels when the slope of the diversion channel is less than the natural channel slope. It is usually necessary to provide sufficient slope and capacity in the diversion channel to flush or store the sediment that will enter the channel. In particular, enhanced design features may be necessary in areas where natural gullies and channels are intercepted by the diversion channel. Concentrated flows and high velocities could transport large quantities of sediment, and the size of the particles transported by the natural channel may be larger than the man-made diversion channel can effectively flush out.

For many sites, considerable amounts of sediment from the upland drainage area can be expected to enter diversion channels, for the following reasons:

- A. The upland drainage area has an average slope that is greater than that of the diversion channel in the reaches adjacent to the tailings embankment. Flow velocities in the diversion channels may not be as high as those occurring in the natural channel, resulting in sediment accumulation.
- B. The potential for gully development (and resulting high flow velocities) in the upland drainage area and subsequent transport of material into the diversion channel may be high. Flood flows moving towards the diversion channel will tend to concentrate in these gullies, increasing the potential for gully incision and transport of sediment.

These occurrences need to be carefully analyzed to determine if a diversion channel can be constructed to meet the requirements of 10 CFR Part 40, that do not allow credit to be taken for active maintenance to remove sediment.

#### **2 TECHNICAL BASIS**

To determine the acceptability of the diversion channel design, it is usually necessary to provide analyses to document that the diversion channel, with its relatively flat slope will be able

to safely store or flush out much of the sediment. Designers should be able to conclude that the slope of the channel is sufficient to transport much of the sediment load during small runoff events or that the channel is large enough to store the expected sediment load. Several factors need to be analyzed, including: 1) sheet and rill erosion; 2) gully erosion; 3) estimated sediment yield; 4) measured sediment yield; 5) trap efficiency, and 6) sediment transport capacity of channels. The following provides a brief technical discussion of these factors.

## 2.1 Sheet and Rill Erosion

Long-term estimates of average soil losses from sheet and rill erosion can be calculated using the Universal Soil-Loss Equation (USLE) from Wischmeier and Smith (1978), which determines the soil loss as a product of six major factors:

$$A = RKLSCP \quad (E-1)$$

where A is the soil loss per unit area, normally in tons per acre; R is the rainfall erosivity factor; K is the soil erodibility factor, usually in tons per acre; L is the field length factor, normalized to a plot length of 72.6 feet; S is the field slope factor, normalized to a field slope of 9%; C is the cropping-management factor, normalized to a tilled area with continuous fallow; and P is the conservation practice factor, normalized to straight-row farming up and down the slope.

The rainfall erodibility factor R can be evaluated for each storm from

$$R = .01 \sum EI \quad (E-2)$$

where

$$E = (916 + 331 \log I) \quad (E-3)$$

in which E is the kinetic energy in foot-tons per acre-inch and I is the rainfall intensity in inches per hour. Soil erosion losses from single storms strongly correlate with the maximum 30-minute rainfall intensity. On an annual basis, the annual rainfall erosion index in the United States may be determined using Wischmeier and Smith (1978). Using the values of R derived from this reference, average annual erosion losses may be calculated from Equation E-1.

The soil-erodibility factor K describes the inherent erodibility of the soil, expressed in the same units as the annual erosion loss in tons per acre. Numerous factors control the erodibility of cohesive soils such as grain size distribution, texture, permeability and organic content. The evaluation of K can be obtained from the nomograph proposed by Wischmeier et al. (1992) given the percentage of sand, the percentage of silt and fine sand, the percentage of organic matter, the soil structure, and the soil permeability. For each type of soil, approximate values of K can be determined, given the soil type and the percentage of organic matter.



The slope length-steepness factor LS is a topographic factor relating erosion losses from a field of given slope and length when compared with soil losses of a standard plot 72.6 ft long inclined at 9% slope. The LS values can be calculated from the runoff length  $l$  in ft and slope in ft/ft using

$$LS = \sqrt{l} (0.0076 + 0.53s + 7.6s^2) \quad (E-4)$$

The cropping-management factor C for bare soils is taken as a standard value equal to unity. The factor C accounts for soils under different cropping and management combinations such as different vegetation, canopy during growth stage, before and after harvesting, crop residues, mulching, fertilizing and crop sequence. Typical values of C are given by Wischmeier and Smith (1978) for undisturbed forest land; pasture, range and idle land; and construction slopes. Area-averaged values of C can be used when several vegetation types cover a given area.

The conservation practice factor P equals one for downslope rows. Typical values for contouring, strip cropping and terracing are given by Wischmeier (1972). Contour practices are most effective on slopes less than 12%, in which case, P can be as low as 0.5. Contouring does not reduce erosion losses at slopes exceeding 24%. Strip cropping and terracing can reduce erosion significantly on slopes less than 12%.

## 2.2 Gully Erosion

Gully erosion can be estimated from aerial photographs taken at different times and/or from field surveys. Two sets of aerial photographs can provide the areal extent of the headcut migration, and field surveys determine the vertical extent of the degradation. For instance, from aerial photographs in 1972 and 1997, one can determine that a 20-ft wide gully has migrated 300 ft. With field surveys showing an average 15 ft of depth, a total volume of 90,000 cubic ft of sediment has been scoured in 25 years. At 100 lb per cubic ft, this corresponds to an average rate of 180 tons of sediment per year.

## 2.3 Estimated Sediment Yield

The total amount of sheet, rill, and gully erosion in a watershed is known as the gross erosion. All eroded particles in a watershed, however, do not reach the outlet of the watershed. The gross erosion can be estimated from the procedures in Sections E-2.1 and E-2.2. Particles detached in bare upland areas are trapped in vegetated areas further downstream. Some material carried in natural streams deposit in the channels to cause channel aggradation, or is locally and temporarily trapped behind channel bedforms and point bars. The total amount of sediment which is delivered to the outlet of the watershed is known as the *sediment yield*.

The *sediment-delivery ratio* expresses the percentage of onsite eroded material that reaches a designated downstream location. The ratio between the sediment yield and the gross erosion in a watershed is called the sediment-delivery ratio. The efficiency of watershed channel network to

convey eroded material to the outlet depends on drainage area, watershed slope, drainage density, and runoff. It appears that the probability of entrapment of particles increases with the size of the drainage area. Therefore, the sediment-delivery ratio (SDR) decreases primarily with drainage area, as discussed by Boyce (1975).

#### 2.4 Measured Sediment Yield

The time variability of sediment concentration measurements in natural channels depends on many factors such as the location of the measurement, the magnitude of the flood, the source of water and sediments, and the seasonal watershed conditions prior to the flood. In general, the sediment concentration increases with discharge, although the sediment concentration at a given discharge may vary depending on the season, the source of sediment, and whether the discharge is increasing or decreasing. The sediment flux at a given point is given by the product of the sediment concentration by the point velocity. Since the flow velocity is maximum at the surface while the sediment concentration is maximum near the bed, the sediment flux must be integrated over the entire cross-sectional area to obtain the total sediment discharge  $Q_s$  passing through a given cross-section.

The *flux-averaged concentration*  $C_s$  is the ratio between the total sediment discharge  $Q_s$  and the total water discharge  $Q$ . On a daily basis, the *sediment load* is the amount of sediment passing a stream cross-section and is given by

$$Q_s = 0.0864 Q C_s \quad (\text{E-5})$$

where  $Q_s$  is the daily sediment load in metric tons per day;  $C_s$  is the flux-averaged concentration in mg/l; and  $Q$  is the daily discharge in cubic meters per second (the units of the constant are 0.0864 metric tons second liter per day  $\text{m}^3 \text{mg}$ ).

A *sediment-rating curve* is obtained by plotting the flux-averaged sediment concentration  $C_s$  as a function of  $Q$ . The analysis of data points usually gives a power relationship of the form:

$$C_s = aQ^b \quad (\text{E-6})$$

where  $a$  and  $b$  are coefficients usually obtained by regression analysis.

When water and sediment discharge measurements are available, the interannual sediment yield from a watershed can be obtained from the *flow-duration sediment-rating curve* method. The method illustrated in Table E-1 consists of dividing the flow duration curve in intervals, becoming increasingly small at higher discharges as shown in column 1. The duration percentage of each interval and the duration midpoint are reported in columns 2 and 3 respectively. The midpoint flow discharge in column 4 is then obtained from the flow duration curve, given the duration midpoint from column 3. From this discharge in column 4, the corresponding total sediment concentration

Table E-1. Long-term sediment yield calculated by the flow-duration sediment-rating curve method.

Interval P <sub>1</sub> - P <sub>2</sub> %	Duration Δp = P <sub>2</sub> - P <sub>1</sub> %	Midpoint (P <sub>1</sub> + P <sub>2</sub> )/2 %	Discharge Q <sub>i</sub> cfs	Q <sub>i</sub> x Δp cfs	Concentration mg/l C <sub>s</sub>	Sediment Yield Q <sub>i</sub> x Δp tons/year
(1)	(2)	(3)	(4)	(5)	(6)	(7)
0.00-0.02	0.02	0.01	58000	12	321	3324 †
0.02-0.1	0.08	0.06	52000	42	279	10363
0.1-0.5	0.4	0.3	43000	172	219	33632
0.5-1.5	1.0	1.0	33000	330	155	45670
1.5-5.0	3.5	3.25	21000	737	87	57094
5-15	10	10	10640	1064	36	34200
15-25	10	20	5475	548	15	7333
25-35	10	30	3484	348	9	2800
35-45	10	40	2435	244	5	1087
45-55	10	50	1839	184	4	657
55-65	10	60	1375	138	3	369
65-75	10	70	1030	103	1.8	166
75-85	10	80	765	76	1.2	82
85-95	10	90	547	55	0.8	39
95-98.5	3.5	96.75	397	14	0.5	6
TOTAL ANNUAL SEDIMENT YIELD:						197,000

$$\dagger Q_s \times \Delta p = 365.25 \frac{\text{days}}{\text{year}} \times 0.0864 \frac{\text{tons sec litre}}{\text{day m}^3 \text{mg}} \times$$

$$\frac{58000 \text{ ft}^3 \text{m}^3}{\text{sec } 35.32 \text{ ft}^3} \frac{321 \text{ mg}}{\text{litre}} \times \frac{0.02}{100} = 3324 \frac{\text{tons}}{\text{year}}$$

in column 6 is given from the sediment rating curve, or Equation 6. For each interval, the water yield in column 5 is calculated from multiplying columns 2 and 6. Likewise, the annual sediment yield in column 7 is calculated from Equation E-5 given  $\Delta p$ ,  $Q$  and  $C_s$  from columns 2, 4 and 6. The interannual total sediment yield is finally obtained from the sum of column 7.

## 2.5 Trap Efficiency

When sediment-laden water enters reservoirs, lakes, impoundments, and settling basins, the settling of sediment will cause aggradation of the bed. The trap efficiency is used to determine how much sediment is expected to settle in backwater areas. The trap efficiency is defined as the percentage of incoming sediment for a given size fraction (i) that will settle within a given reach. The trap efficiency can be calculated as follows:

$$T_{Ei} = 1 - e^{-\frac{Xw_i}{hV}} \quad (E-7)$$

where  $X$  is the reach length;  $w_i$  is the settling velocity for sediment fraction  $i$  from Table E-4;  $h$  is the mean flow depth; and  $V$  is the mean flow velocity. The exponent is dimensionless and any consistent system of units can be used in this equation.

The sediment load that settles within the reach is given by the product of the incoming sediment load and the trap efficiency. The outgoing sediment load is calculated by subtracting the settling load from the incoming load. The trap efficiency varies with sediment size through the settling velocity. Typically, the trap efficiency is approximately one for coarse sediment, e.g., gravels, and approaches zero for fine sediment, e.g., clays.

## 2.6 Sediment Transport Capacity of a Channel

Simons, Li, and Fullerton (1981) developed an efficient method of evaluating sediment discharge. The method is based on easy-to-apply power relationships that estimate sediment transport based on the flow depth  $h$  and velocity  $V$ . These power relationships were developed from a computer solution of the Meyer-Peter and Müller bedload transport equation and Einstein's integration of the suspended bed sediment discharge:

$$q_s = c_{s1} h^{c_{s2}} V^{c_{s3}} \quad (E-8)$$

The results of the total bed sediment discharge are presented in Table E-2. The large values of  $c_{s3}$  ( $3.3 < c_{s3} < 3.9$ ) show the high level of dependence of sediment transport rates on velocity. Depth has comparatively less influence ( $-0.34 < c_{s2} < 0.7$ ).

**Table E-2.** Power equations for total bed sediment discharge in sand- and fine-gravel-bed streams.

	$q_s = c_{S1} h^{c_{S2}} V^{c_{S3}}$							
	$D_{50}$ (mm)							
	0.1	0.25	0.5	1.0	2.0	3.0	4.0	5.0
Gr = 1.0 $c_{S1}$ $c_{S2}$ $c_{S3}$	$3.30 \times 10^{-5}$ 0.715 3.30	$1.42 \times 10^{-5}$ 0.495 3.61	$7.6 \times 10^{-6}$ 0.28 3.82	$5.62 \times 10^{-6}$ 0.06 3.93	$5.64 \times 10^{-6}$ -0.14 3.95	$6.32 \times 10^{-6}$ -0.24 3.92	$7.10 \times 10^{-6}$ -0.30 3.89	$7.78 \times 10^{-6}$ -0.34 3/87
Gr = 2.0 $c_{S1}$ $c_{S2}$ $c_{S3}$		$1.59 \times 10^{-5}$ 0.51 3.55	$9.8 \times 10^{-6}$ 0.33 3.73	$6.94 \times 10^{-6}$ 0.12 3.86	$6.32 \times 10^{-6}$ -0.09 3.91	$6.62 \times 10^{-6}$ -0.196 3.91	$6.94 \times 10^{-6}$ -0.27 3.90	
Gr = 3.0 $c_{S1}$ $c_{S2}$ $c_{S3}$			$1.21 \times 10^{-5}$ 0.36 3.66	$9.14 \times 10^{-6}$ 0.18 3.76	$7.44 \times 10^{-6}$ -0.02 3.86			
Gr = 4.0 $c_{S1}$ $c_{S2}$ $c_{S3}$				$1.05 \times 10^{-5}$ 0.21 3.71				

**Definitions:**  $q_s$ , unit sediment transport rate in ft<sup>2</sup>/s (unbulked); V, velocity in ft/s; h, depth in ft;  $G_r = 0.5 [(D_{84}/D_{50}) + (D_{50}/D_{16})]$  gradation coefficient.

For flow conditions within the range outlined in Table E-3, the regression equations should be accurate within 10%. The equations were obtained for steep sand- and gravel-bed channels under supercritical flow. They do not apply to cohesive material.

The equations assume that all sediment sizes are transported by the flow without armoring. The sediment concentration  $c_{mg/l}$  is calculated from

$$c_{mg/l} = 2.65 \times 10^6 \frac{q_s}{q} \quad (E-9)$$

where  $q_s$  is calculated from Equation E-8 and  $q = V_h$  is the unit discharge in  $ft^2/s$ .

### 3 DESIGN AND ANALYSIS PROCEDURES

The following procedures may be used to determine: 1) sheet and rill erosion; 2) gully erosion; 3) calculated sediment yield; 4) measured sediment yield; 5) trap efficiency, and 6) sediment transport capacity of channels.

#### 3.1 Sheet and Rill Erosion Procedure

The following sheet and rill erosion procedure based on the USLE may be used to determine soil erosion losses from upland erosion. If data are available, this approach should be supplemented with field measurements to properly calibrate and ascertain the accuracy of other procedures and/or computer models.

- Step A-1. Gather topographic, soil type and land use information. Subdivide the domain into sub-watersheds. For each sub-watershed, determine: drainage area, runoff length, average slope, soil type, percentage of canopy cover and ground cover and any particular method of soil conservation practice.
- Step A-2. Determine the mean annual rainfall erodibility factor R for the specific site location.
- Step A-3. Determine, for each sub-watershed, the soil erodibility factor K from soil samples.
- Step A-4. Determine the slope length-steepness factor LS from the runoff length and average slope.
- Step A-5. Determine the cropping-management factor C from the ground and canopy cover data.

Table E-3. Range of parameters for the Simons-Li-Fullerton method.

Parameter	Value range
Froude number	1 - 4
Velocity	6.5 - 26 ft/s
Manning coefficient n	0.015 - 0.025
Bed slope	0.005 - 0.040
Unit discharge	10 - 200 ft/s
Particle size	$D_{50} \geq 0.062$ mm $D_{50} \leq 15$ mm

- Step A-6. Determine the conservation practice, P.
- Step A-7. Multiply the factors from Steps A-2 to A-6 to calculate the mean specific annual soil erosion loss in tons per acre per year.
- Step A-8. Multiply the mean specific annual erosion loss from Step A-7 by the drainage area in acres for each sub-watershed to obtain the mean annual soil erosion loss from each sub-watershed.
- Step A-9. Multiply the mean annual soil erosion loss in Step A-8 by 1,000 years to determine the expected soil erosion loss in the next 1,000 years on each sub-watershed.

### 3.2 Gully Erosion Procedure

The following gully erosion procedure is recommended to determine soil erosion losses from gullies. The objective is to determine the gully erosion losses to be added to the sheet and rill erosion losses from Section 3.1 and thus determine the gross erosion.

- Step B-1. When available, gather two or more sets of aerial photographs and/or detailed topographic surveys in the areas where gullies have developed. Gather topographic, soil type and land use information. Determine how many gullies have developed on each sub-watershed defined in Section 3.1.
- Step B-2. Use the aerial photographs/field surveys to determine the areal extent of the headcut migration and use the field surveys to determine the vertical extent of the degradation that has taken place during that time period. For instance, from aerial photographs in 1972 and 1997, one can determine that a 20-ft wide gully has migrated 300 ft. With field surveys showing an average 15 ft of depth, a total volume of 90,000 cubic ft of sediment has been scoured in 25 years.
- Step B-3. Convert the volumetric values into equivalent tons of sediment, using about 100 lb per cubic foot, or 20 cubic ft per ton. Field measurements of mass density can be used to refine these calculations. Determine the number of tons per year lost to gully erosion.
- Step B-4. For each sub-watershed, determine the specific gully erosion loss in tons per acre per year.
- Step B-5. Unless there are factors limiting future gully erosion, multiply the gully erosion loss from Step B-3 by 1,000 to determine the expected gully erosion loss over the next millenium.

### 3.3 Estimated Sediment Yield Procedure



When field measurements are not available, the following estimated sediment yield procedure is recommended. The objective is to determine the sediment yield from the estimates of the gross erosion in Sections 3.1 and 3.2 and from the sediment-delivery ratio.

- Step C-1. For each sub-watershed, calculate the gross erosion loss from the sum of rill erosion losses in Section 3.1 and gully erosion losses in Section 3.2. The results are the specific gross erosion loss in tons per acre per year, calculated from Section 3.1, Step A-7 and Section 3.2, Step B-4). The gross annual erosion loss in tons per year is obtained by multiplying by the drainage area of each sub-watershed. The millenium gross erosion loss in tons is obtained after multiplying by 1,000 years.
- Step C-2. For each tributary or sub-watershed, determine the: 1) drainage area; and 2) millenium gross erosion in tons. This is done by summing up all the sub-watershed contributions of each tributary or sub-watershed.
- Step C-3. Calculate the sediment delivery ratio for each tributary from the tributary drainage areas.
- Step C-4. Calculate the sediment yield in tons per year for each tributary by multiplying the gross erosion in step C-2 by the sediment delivery ratio in step C-3.
- Step C-5. Convert the millenium sediment yield in tons from all tributaries to the diversion channel into volume (assuming approximately 20 cubic ft per ton). The *millenium volume ratio* is defined as the millenium sediment volume to the total volume of the diversion channel. In general, if the millenium volume ratio is less than 10%, the channel may be able to store the millenium sediment load without significantly altering the capacity of the diversion channel. However, a more detailed analysis of the effects of the spatial distribution of sediment on sediment transport capacity of the channel is indicated. If the slope of the diversion channel is comparable to that of the natural channel, procedures 3.4 and 3.6 are recommended. If the slope of the diversion channel is very flat compared to the natural channel, the trap efficiency procedure in Section 3.5 is recommended.

#### 3.4 Measured Sediment Yield Procedure

To document the adequacy of most diversion channels, an analysis of the sediment transport capacity is needed. The following procedure is based on discharge and sediment transport measurements in the diversion channel. When field measurements are not available, the trap efficiency procedure in Section 3.5 is recommended. The objective is to determine the sediment yield from field measurements.

- Step D-1. From discharge measurements, the flow-duration curve is established. The percentage of time that a given discharge is exceeded defines the flow-duration curve. This curve is written in tabular form as shown in Table E-1. Specifically, the percentage of time is shown in column 3 and the discharges are reported in column 4.

- Step D-2. A sediment-rating curve is developed from the measurements of flux-averaged concentration versus discharge on a log-log plot. A power relationship like equation E-1 can generally be plotted through the data and be used for the calculations. The values of sediment concentration corresponding to discharge values in column 4 of Table E-1 are reported in column 6 of Table E-1. Column 7 is completed from Equation E-5 and discharge and concentration values in columns 2, 4, and 6, respectively. One must carefully check the conversion factors throughout the calculations. An example is given as a footnote in Table E-1.
- Step D-3. The mean annual sediment yield in tons per year is determined from the sum of all numbers in column 7 of Table E-1. Multiply this number by 1,000 years to obtain the millenium sediment yield. Since this calculation is based on field measurements, this annual sediment yield is very important and should be determined whenever field measurements are available.

### 3.5 Trap Efficiency Procedure

When the slope of the diversion channel is small compared to that of the natural channel, or when no field data are available, the following trap efficiency procedure is recommended. The objective is to determine how much of the sediment yield will deposit in the diversion channel.

- Step E-1. Gather field information on the particle size distribution of the sediment delivered to the diversion channel. The purpose is to determine the percentage of sand, silt and clay in the sediment delivery.
- Step E-2. For each size fraction, determine the corresponding settling velocity  $\omega_i$ .
- Step E-3. Determine the unit discharge,  $q$ , by dividing the total flow discharge of a large event by the width of the diversion channel. Extreme events will have lower trap efficiency than smaller events. Also, determine the length,  $X$ , of the diversion channel.
- Step E-4. Calculate the trap efficiency from Equation E-7 for each size fraction. Multiply the trap efficiency for each size fraction by the fraction of material for each size fraction and sum the results. For instance, multiply the trap efficiency of sand by the fraction of sand in the sample and repeat the calculations for silt and clays. The result is a composite trap efficiency  $T_E$  that determines the fraction of the incoming sediment load that will deposit in the diversion channel.
- Step E-5. Multiply the millenium sediment yield in cubic feet by the composite trap efficiency to determine the volume of sediment that will deposit in the diversion channel in the next 1,000 years.

### 3.6 Sediment Transport Capacity Procedure

When the slope of a diversion channel is comparable to that of a natural channel, and when there are field data available to define the flow duration curve, the following sediment transport capacity procedure is recommended. The objective is to determine how much sediment a channel is capable of carrying.

Table E-4. Settling velocities in mm/s.

Class Name	Particle Diameter (mm)	$\omega_0$ at 10° C (mm/s)
<i>Cobble</i>		
Large	>128-256	1,357
Small	>64	>959
<i>Gravel</i>		
Very coarse	>32-64	678
Coarse	>16-32	479
Medium	>8-16	338
Fine	>4-8	237
Very Fine	>2-4	164
<i>Sand</i>		
Very coarse	>1-2	109
Coarse	>0.5-1	66.4
Medium	>0.25-0.5	31.3
Fine	>0.125-0.26	10.1
Very fine	>0.0625-0.125	2.66
<i>Silt</i>		
Coarse	>0.031-0.0625	0.67 <sup>a</sup>
Medium	>0.016-0.031	0.167 <sup>a</sup>
Fine	>0.008-0.016	0.042 <sup>a</sup>
Very fine	>0.004-0.008	0.010 <sup>a</sup>
<i>Clay</i>		
Clay	<0.002	<2.6x10 <sup>-3a</sup>

<sup>a</sup>Note that flocculation is possible.

- Step F-1. Gather field information on the particle size distribution of the sediment delivered to the diversion channel and also the particle size distribution of the bed material of the channel. The bed material of the channel should be sufficiently coarse, sand or gravel, to sustain the tractive force exerted by flowing water.
- Step F-2. For the range of flow conditions measured in the field, and for each discharge  $Q$ : determine the channel width  $W$  and unit discharge  $q$  ( $Q/W$ ); and estimate the flow depth  $h$  and mean flow velocity  $V$  from the Manning equation.
- Step F-3. For each discharge, calculate the sediment transport capacity using Equation E-8 and the corresponding sediment concentration in mg/l using Equation E-9.
- Step F-4. The values of sediment concentration in Step F-3 are substituted for the measured sediment concentration values in Table E-1, col. 6. The procedure in Section 3.4 is repeated with the sediment concentration values from Step F-3 and the corresponding calculation in column 7 represent the sediment transport capacity. The expected annual value of sediment transport capacity for this channel is then given by the sum of all numbers in Table E-1, col. 7.
- Step F-5. The sediment transport capacity of the channel over a period of 1,000 years is obtained after multiplying the annual expected value of the sediment transport capacity from Step F-4 by 1,000.

#### 4 RECOMMENDATIONS

The distribution of sediment from major tributaries to the diversion channel can be estimated at various locations along the channel by using the parameter  $X$  in Equation E-7 as the distance separating the given location and the tributary. The resulting distribution from major tributaries is approximately a decreasing exponential. On the other hand, the distribution of sediment from small sub-watersheds will generally take the shape of a conical alluvial fan. The characteristics of alluvial fans can generally be recognized from field surveys of the diversion channel and the column of sediment accumulated over a given period of time can be surveyed. This volume is indicative of the sediment yield to the diversion channel. The effects of sediment accumulation from major tributaries and sub-watersheds on velocity profiles, water surface profiles, and diversion channel overtopping should be analyzed to protect mill tailings against flooding. Further analysis and designs may be needed to reduce the erosion losses upstream of the diversion channel through settling basins, check dams, sub-watershed diversions and/or watershed protection measures.

#### 5 EXAMPLE OF PROCEDURE APPLICATION

Consider a site located near Grants in northwestern New Mexico. A diversion channel with a slope of 0.001 is proposed to route floods around a reclaimed tailings impoundment. The diversion channel is about 120 ft wide and receives sediment from many sub-watersheds and steep adjacent sideslopes. Estimate the sediment yield to the channel and the likely accumulation of sediment in the next 1,000 years.

## 5.1 Example of Sheet and Rill Erosion Procedure

- Step A-1. The main characteristics of the sub-watersheds should be listed, such as those given in Table E-5. The tributary locations are shown in Table E-6, col. 1, the sub-watershed areas are shown in Table E-5, col. 2, and the drainage areas of tributaries and sub-watersheds are reported in Table E-6, col. 3. The soils in the watershed contain 30% gravel, 10% sand, 20% silt, and 40% clays. There is no particular soil conservation practice on the sub-watersheds. Vegetation is rather sparse with grasses and junipers (see Figure E-1).
- Step A-2. The mean annual factor R near Grants, New Mexico, is about 25.
- Step A-3. The soil erodibility factor K for each sub-watershed is determined from soil samples. Representative samples show that the soils contain approximately 14% sand, 29% silt, and 57% clay. This is a clay soil, and the soil erodibility factor is approximately 0.25.
- Step A-4. The slope length-steepness factor LS is calculated from the runoff length and average slope. The values of LS are listed in Table E-6, col. 5 for each sub-watershed.
- Step A-5. The cropping-management factor C is determined from the ground and canopy cover data. The ground cover is most effective to protect against soil erosion and the type W is appropriate in this case. The values of C are listed in Table E-6, col. 6 for each sub-watershed.
- Step A-6. The conservation practice factor P is assumed to be 1 from field observations and the product of factors R, K, and P from steps A-2, A-3, and A-6 are listed in Table E-6, col. 4 for each sub-watershed.
- Step A-7. For each sub-watershed, the factors RKLSCP from columns 4, 5, and 6 in Table E-6 are multiplied to obtain the specific sheet and rill erosion loss in tons per acre per year.
- Step A-8. The result is multiplied by the drainage area in Table E-6, col. 3 to give the sheet and rill erosion annual erosion loss in tons per year, listed in col. 7 of Table E-6. (Note that there are 640 acres per square mile).

Table E-5. Example of sub-watershed characteristics.

Basin I. D.	Area (mi <sup>2</sup> )	Slope (%)	Length (ft)	Percent cover	
				Tree Canopy (5)	Ground (6)
(1)	(2)	(3)	(4)	(5)	(6)
1	0.0060	0.20	650	20	0
2	0.0125	8.85	1305	15	15
3	0.0760	7.26	3519	20	20
4	0.0335	3.50	2001	20	0
5	0.0261	12.04	1924	20	15
6	0.0709	8.91	2761	20	30
7	0.0472	6.56	2245	25	30
8	0.0905	8.83	3263	20	35
9	0.0099	7.67	1936	20	20
10	0.0365	11.58	1913	25	30
11	0.0311	9.23	2285	20	35
12	0.0340	10.44	2262	20	20
13	0.0152	15.45	1113	10	15
14	0.0196	20.09	1188	15	20
15	0.0365	17.36	1578	15	20
16	0.0110	19.23	397	10	20
TOTAL AREA (356 ac) = 0.557 mi <sup>2</sup>					

**Table E-6. Sediment yield calculations by sub-watersheds and tributaries.**

Tributary (1)	Sub-watershed (2)	Area (mi <sup>2</sup> ) (3)	RKP (4)	LS (5)	C (6)	Ax RKLSCP (tons/year) (7)	Gully Erosion (tons/year) (8)	Millenium Gross Erosion (tons) (9)	SDR (10)	Millenium Sediment yield (tons) (11)			
1	1	0.0060	6.25	0.22	0.40	2.1	0	2,120	0.63	229,100			
	2	0.0125	6.25	4.12	0.25	51.5	0	51,500					
	3	<u>0.0760</u>	6.25	5.10	0.20	310.1	0	<u>310,100</u>					
		0.0945						363,720					
2	4	0.0335	6.25	1.58	0.40	84.7	0	84,700	0.41	530,950			
	5	0.0261	6.25	7.96	0.25	208	0	207,800					
	6	0.0709	6.25	6.05	0.15	257	0	257,400					
	7	0.0472	6.25	3.56	0.15	101	0	100,800					
	8	0.0903	6.25	6.49	0.10	235	0	234,900					
	9	0.0099	6.25	4.09	0.20	32.4	0	32,400					
	10	0.0365	6.25	7.47	0.15	164	0	163,500					
	11	0.0311	6.25	5.8	0.10	72.1	0	72,100					
	12	<u>0.0340</u>	6.25	6.93	0.15	141	0	<u>141,400</u>					
		0.3797						1,295,000					
	3	13	<u>0.0152</u>	6.25	9.04	0.25	137	0			<u>137,400</u>	1.0	137,400
			0.0152								137,400		
4	14	<u>0.0196</u>	6.25	14.50	0.20	227	0	<u>227,400</u>	1.0	227,400			
		0.0196						227,400					
5	15	<u>0.0365</u>	6.25	13.05	0.20	381	9	<u>390,100</u>	0.84	327,700			
		0.0465						390,100					
6	16	<u>0.0110</u>	6.25	7.78	0.20	68.5	0	<u>68,500</u>	1.0	68,500			
		0.0110						68,500					
<b>Total Sediment Yield</b>										<b>1,521,000 tons</b>			



**Figure E-1.** Example of sheet and rill erosion.



Step A-9. Multiply the mean annual soil erosion loss in Step A-8 by 1,000 years to determine the expected soil erosion loss in the next 1,000 years on each sub-watershed.

## 5.2 Example of Gully Erosion Procedure

The gully erosion losses from the following procedure are added to the sheet and rill erosion losses from Section 3.2 to determine the gross erosion losses.

Step B-1. In this case only two small gullies started to develop at the base of the sub-watershed shown in Figure E-2.

Step B-2. In the past ten years, field investigations showed that the two gullies are approximately 3-ft wide, 2-ft deep, and 150-ft long. A total volume of 1,800 cubic ft of sediment has been scoured in ten years.

Step B-3. Convert the volumetric values into equivalent tons of sediment. One can use about 100 lb per cubic ft which corresponds to 20 cubic ft per ton. In this case, 1,800 cubic ft of sediment in 10 years corresponds to 9 tons per year lost to gully erosion. The values are listed in Table E-6, col. 8.

Step B-4. This gully erosion loss is very small compared to the sheet and rill erosion loss and can be neglected in this case.

## 5.3 Example of Estimated Sediment Yield Procedure

When field measurements are not available, the following estimated sediment yield procedure is recommended. The objective is to determine the sediment yield from the estimates of the gross erosion in Sections 3.1 and 3.2 and from the sediment-delivery ratio.

Step C-1. The gross annual erosion loss in tons per year is obtained from the sum of columns 7 and 8 in Table E-5 for each sub-watershed. After multiplying by 1,000, the millenium gross erosion loss in tons is determined and listed in Table E-6 col. 9.

Step C-2. The characteristics of each tributary to the diversion channel are then considered. For each tributary, the following characteristics are determined: 1) drainage area; and 2) millenium gross erosion in tons. This is done by summing up the contributions for each tributary and sub-watershed.

Step C-3. The sediment delivery ratio is calculated for each tributary from the tributary drainage area. The maximum value of the sediment delivery ratio is unity; values are listed in Table E-6, col. 10.

Step C-4. The sediment yield in tons per year is then calculated for each tributary by multiplying the millenium gross erosion in step C-2 by the sediment delivery ratio in step C-3. The sediment yield values are listed in Table E-6, col.11 and the bottom line sum is

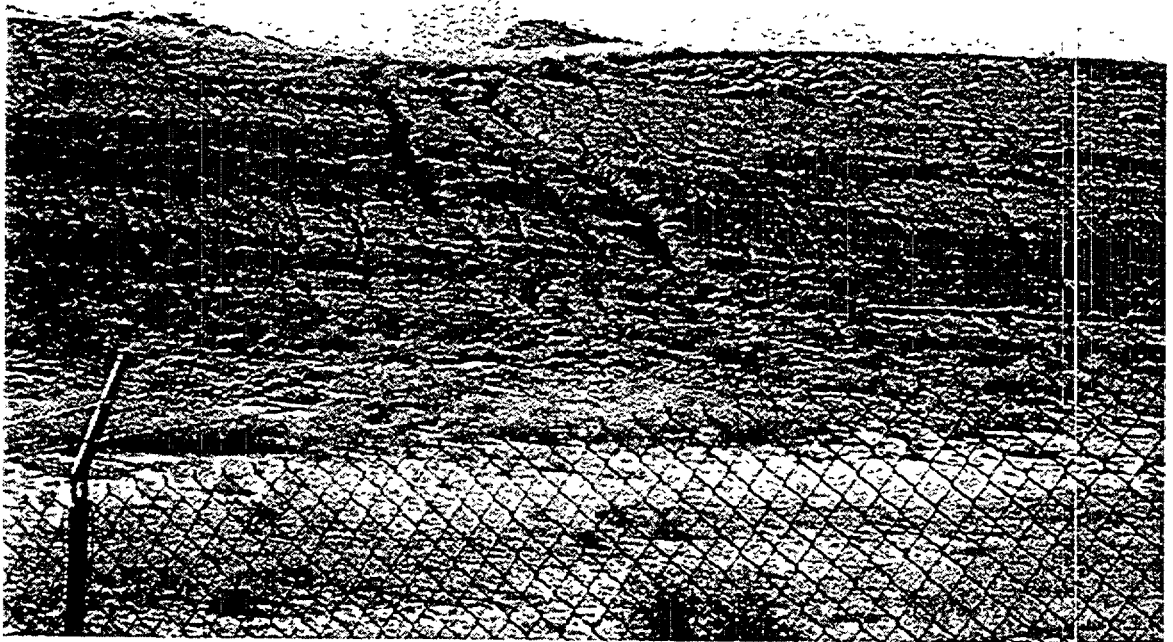

**Figure E-2.** Example of rill and gully erosion.

the total millenium sediment yield to the diversion channel. In this case, the millenium sediment yield is about 1.5 million tons of sediment.

Step C-5. The millenium sediment volume (assuming approximately 20 cubic ft per ton) is about 30 million cubic ft of sediment. The diversion channel is approximately 3,500 ft long, 140 ft wide and 12 ft high. The diversion channel volume is estimated at 5.9 million cubic ft. The *millenium volume ratio*, defined as the millenium sediment volume to the total volume of the diversion channel, is about 5 and far exceeds the recommended 10% ratio. The diversion channel is not appropriately designed to accommodate the sediment yield in the next 1,000 years without causing sedimentation problems, possible overtopping of berms and flow over the mill tailings during extreme events. A more detailed analysis of the sediment transport capacity of the channel is necessary. Since the slope of the diversion channel is very flat compared to that of the natural channel, the trap efficiency procedure E is recommended.

#### 5.4 Example of Measured Sediment Yield Procedure

This procedure is not used in this case because there are no field measurements available for discharge and sediment concentration to use the method. An example of this procedure is given in Table E-1 from the flow-duration curve in columns 3 and 4, and from the sediment-rating curve defined from columns 4 and 6. The calculation procedure follows from the explanations given in Section 2.4.

#### 5.5 Example of Trap Efficiency Procedure

Since the slope of the diversion channel at 0.001 is about 20 times smaller than that of the natural channel, and the millenium volume ratio exceeds 10%, the following trap efficiency procedure is recommended. The objective is to determine how much of the sediment yield will deposit in the diversion channel. The sediment supplied from steep sub-watersheds to flat diversion channels will deposit in the channel and form alluvial fans as shown in Figure E-3.

- Step E-1. Analyze sediment deposition by size fraction. In this case, the soils contain about 30% gravel, 10% sand, 20% silt and 40% clays.
- Step E-2. The corresponding settling velocity for each size fraction is determined to be 0.3 m/s for gravel, 0.03 m/s for sand, 0.00004 m/s for silt and 0.0026 mm/s for clay.
- Step E-3. The unit discharge is estimated as 30 cfs per foot, or 3 cms per meter during extreme flow events. The length of the diversion channel is 3000 ft, or 1,000 m, from point E where most of the sediment is supplied to the outlet.
- Step E-4. The trap efficiency from equation E-7 for each size fraction is essentially unity for gravel and sand and very low for silt and clay. Considering that the diversion channel will trap all gravels and sands but none of the silts and clays during major events, the

NUREG-1623

E-22



**Figure E-3.** Alluvial fan deposit in a diversion channel.

composite trap efficiency will be at least 40% of the incoming material during events. During smaller events, the diversion channel is likely to trap just about all size fractions and serve essentially as a settling basin. The *composite trap efficiency* will therefore vary between 40% during extreme events and 100% during very small events. Therefore, about 70% of the incoming sediment load is expected to deposit in the diversion channel.

Step E-5. The millenium sediment yield of 30 million cubic ft of sediment is multiplied by the composite trap efficiency of 70% to determine that about 20 million cubic ft of sediment, or about one million tons of sediment will deposit in the diversion channel in the next thousand years. This sediment is still about more than 3 times the total volume of the diversion channel and there will be a sedimentation problem. Alternatives that could be considered are: 1) diversion of runoff outside of the diversion channel; or 2) sediment retention basins in the upper watershed.

#### 5.6 Example of Sediment Transport Capacity Procedure

This procedure is not used in this case because there are no field measurements available for water discharge to use this method. Once flow discharge measurements are available, a flow-duration curve is developed. From measurements and values of channel width, flow depth and mean flow velocity at each discharge, one can proceed with the calculation of sediment transport capacity from Equation E-8, and sediment concentration from Equation E-9. After reporting the calculated values of concentration in column 6 of Table E-1, the procedure explained in Section 3.6 is followed to determine the expected sediment transport capacity of the channel for a period of 1,000 years. New channels can be designed by changing the slope and cross-section geometry of the diversion channel until the measured sediment yield meets the sediment transport capacity calculated by the above procedure.

### 6 LIMITATIONS, FIELD VERIFICATIONS AND COMPUTER APPLICATIONS

The Universal Soil Loss Equation (USLE) by Wischmeier and Smith (1978) gives long-term average values of sediment sources and yields. It can also be applied to single events. The Revised Universal Soil-Loss Equation (RUSLE) is a revised version of the USLE by Renard et al. (1993) and is comparable. The Modified Universal Soil-Loss Equation (MUSLE) is applicable for single events and provides sediment estimates from peak discharge (Williams, 1975; and Williams and Berndt, 1972). Other computer models like CREAMS (Foster et al., 1980) WEPP, MULTSED (Simons et al., 1980), CASC2D (Julien et al., 1995) are available and can be used, but calibration with field data is strongly recommended. Difficulties in applying extreme event models are: 1) that they tend to require extremely high sediment concentrations, for which they are not suited for, 2) in upland areas, it is usually erroneous to assume that only a few extreme events will yield sediment; and 3) the duration of rainfall events can also be important in pervious areas. Without proper calibration, computer models can yield results that are incorrect by several orders of magnitude. Therefore, any calibration of computer models with field data at the study site is needed to increase the credibility of the results.

Stream flow models like HEC-2 and HEC-6 can be used to model sediment transport in the diversion channels. It is important to calibrate the sediment transport algorithm with field data. It is also important to run the model under a variety of flow conditions, not only the extreme flood events, because large volumes of sediment may accumulate in the diversion channels during small rainstorms.

Field verifications can be provided from direct measurements of flow and sediment discharge in the diversion channel. In ephemeral streams, it is often possible to determine the accumulation of sediment in specific areas, e.g., the diversion channel. By measuring the sediment accumulation in the past ten years for instance, one can infer how much sediment may accumulate in the next 1,000 years. One can generally verify the approximate magnitude of the calculations using any model. Specifically, where the diversion channel intercepts sub-watersheds, the change in slope is significant, and alluvial fans can develop at the toe of the sub-watersheds. Monitoring the sediment accumulation in the alluvial fans can verify the approximate magnitude of the sediment accumulation in the diversion channel.

Some solutions attempt to solve the problem at the source by reducing erosion losses from upland areas. A review of the relative influence of the various terms of the Universal Soil-Loss Equation indicates that relatively little can be done to change the rainfall erosivity factor R or the soil erodibility factor K. In some cases, the addition of organic residues increases the infiltration rate and reduces soil erosion losses from sheet flow and surface runoff. The runoff length factor L can only be reduced by increasing the drainage density, in which case the surface erosion losses may be partially reduced at the expense of a faster drainage of surface waters resulting in an increased peak discharge and a greater sediment transport capacity in the channels.

One of the most effective methods to reduce surface erosion losses is to increase the vegetation cover which will significantly reduce the cropping management factor C. The presence of natural vegetation is most effective in reducing the detachment of soil particles induced by raindrop impact and also in stabilizing the soil in the root zone. The surface slope factor S can be reduced by terracing, although the cost of terracing may be prohibitive. Terraces significantly reduce soil erosion losses, through the practice factor P, in reducing runoff length and slope steepness besides increasing infiltration. In agricultural areas, reduction of soil losses can be obtained by contouring, strip cropping, mulching, residues and minimum tillage.

Upland sediment control structures are designed to trap sediment below eroded areas. Ponds and reservoirs are generally efficient in trapping coarse sediment, but are not effective in trapping very fine sediment. The sediment yield is reduced by settling of sediment particles in the reservoir and also by reducing the bed slope of the channel entering the reservoir.

Reducing channel erosion is also possible, but is usually expensive. Solution to local erosion problems can be economically feasible; however, the cost of bank stabilization methods for entire watersheds is prohibitive. Local bank erosion can be reduced by appropriate streambank protection methods such as vegetation, gabions, mattresses, trenches, soil cement, riprap, spurs, hardpoints, retards, dikes, jetties, fences, and drop structures. Increased channel roughness with fences and vegetation screens may also be effective in trapping coarse material and reducing the slope of natural

channels. Grassed waterways are effective on farmlands. Gully stabilization can usually be achieved by a combination of runoff reduction entering the gully, and vegetation to stabilize the gully surface. Drop spillways may be able to control the downstream bed elevation of eroding streams. These structures not only reduce the gradient, but also induce deposition of transported material in the ponded reach upstream.

## 7 REFERENCES

- Boyce, R., Sediment routing with sediment-delivery ratios, in **Present and Prospective Technology for Predicting Sediment Yields and Sources**, USDA-ARS-S-40, 1975, pp. 61-65.
- Brady, N. C., **The Nature and Properties of Soils**, 8th Edition, Macmillan, 1974.
- Foster, G. R., L. J. Lare, J. D. Nowlin, L. M. Lafler and R. A. Young, "CREAMS - A Field Scale Model for Chemicals, Runoff and Erosion from Agricultural Management Systems", USDA-SEA Conservation Report No. 26, 1980.
- Julien, P. Y., **Erosion and Sedimentation**, Cambridge University Press, 1995, 280 p.
- Julien, P. Y., B. Saghafian and F. L. Ogden, "Raster-based Hydrologic Modeling of Spatially Varied Surface Runoff," *Water Res. Bull.*, AWRA, 31(3): 523-536, 1995.
- Renard, K., D. K. McCool, D. K. Cooley, C. K. Mutchler and G. R. Foster, in "Predicting Soil Erosion by Water - A Guide to Conservation Planning Using the Revised Universal Soil Loss Equation" ARS Publication, 1993.
- Schwab, R. K., Frevert, T. W. Edminster, and K. K. Barnes, **Soil and Water Conservation Engineering**, Third Edition, Wiley, 1981.
- Simons, D. B., R. M. Li and W. T. Fullerton, "Users Manual - Multiple Watershed Model for Water and Sediment Routing from Mined Areas," Simons, Li and Associates, Inc., Fort Collins, Colorado, 1980.
- Simons, D. B., R. M. Li and W. T. Fullerton, Theoretically derived sediment transport equations for Pima County, Arizona. Prepared for Pima County DOT and Flood Control District, by Simons, Li and Associates, Inc., Fort Collins, Colorado, 1981.
- USDA-Water Erosion Prediction Project (WEPP), NSERL Report No. 11, July 1993. National Soil Erosion Research Laboratory, USDA-ARS-MWA 1196 Soil Building, West Lafayette, IN 47907-1196.
- Williams, J. R., Sediment Routing for Agricultural Watersheds, *Water Res. Bull.* 11(5): 965-974, 1975.



Williams, J. R. and H. D. Berndt, Sediment yield calculated with Universal Equation. J. Hyd. Div ASCE, 98(HY12): 2087-2098, 1972.

Wischmeier, W. H., Upslope erosion analysis, Chap. 15 in **Environmental Impact on Rivers**, Edited by H. W. Shen, 1972.

Wischmeier, W. H., C. B. Johnson, and B. V. Cross, A soil-erodibility nomograph for farmland and construction sites, Journal of Soil and Water Conservation, Vol. 26, No. 5., pp. 189-193, 1971.

Wischmeier, W. H. and D. D. Smith, Predicting rainfall erosion losses - a guide to conservation planning, USDA Agriculture Handbook No. 537, 1978.

## APPENDIX F

# ROCK PLACEMENT PROCEDURES FOR EROSION PROTECTION

## CONTENTS

	<i>Page</i>
<b>1 INTRODUCTION</b> .....	F-1
<b>2 GENERAL GUIDELINES FOR ROCK PLACEMENT</b> .....	F-1
<b>3 SAMPLE SPECIFICATIONS</b> .....	F-2
3.1 General .....	F-2
3.2 Products .....	F-2
3.2.1 General .....	F-2
3.2.2 Quality Requirements .....	F-3
3.2.3 Subcontractor-Proposed Sources .....	F-5
3.2.4 Gradation Requirements .....	F-5
3.2.5 Source Quality Control .....	F-7
3.3 Execution .....	F-8
3.3.1 Placement and Compaction .....	F-8
3.3.2 Tolerances .....	F-9
3.4 Materials Testing .....	F-10
3.4.1 Erosion Protection Materials Testing .....	F-10
3.4.2 Inspections .....	F-11
3.4.3 Erosion Protection .....	F-11
<b>4 EXAMPLE OF RIPRAP PLACEMENT</b> .....	F-12

## APPENDIX F

### ROCK PLACEMENT PROCEDURES FOR EROSION PROTECTION

#### 1 INTRODUCTION

Rock riprap is often an integral part of an erosion protection plan to assure the long-term stability of the waste material and cover system. Rock may be placed on top of the disposal cell, on the embankment side slope(s), in key trenches, on perimeter aprons, in diversion ditches and channels, in stilling areas, and on areas where erosion protection is essential to site stability. Improper placement of rock materials may result in the segregation of stones, variability in the rock layer thickness, rock penetration into the filter/bedding and/or radon barrier, or disruption of the soil/radon barrier cover. Therefore, it is essential that rock placement follow certain key guidelines and criteria.

#### 2 GENERAL GUIDELINES FOR ROCK PLACEMENT

The proper placement of rock riprap at any location on the impoundment site is necessary to dissipate the energy associated with flowing water and thus prevent erosion that could lead to gulying and exposure of contaminated material. In general, proper placement is created by providing a relatively uniform thickness of rock at a specified gradation. The following are general guidelines that should be used to achieve adequate placement of rock riprap layers:

- A. Riprap should be placed in a layer thickness that is at least 1.5 to 2 times the average rock size ( $D_{50}$ ). If care is used in placing the riprap layer, such as using specialized equipment or rearranging individual rocks by hand, a thickness of 1.5 times  $D_{50}$  is acceptable. A thickness of 2 times  $D_{50}$  generally results in better rock placement.
- B. Where the  $D_{50}$  size is eight inches or more, the placement procedures should include a certain amount of individual rock placement (using specialized equipment or hand labor) to ensure that proper thicknesses and areal coverage are achieved. Where the  $D_{50}$  size is less than 8 inches and the layer thickness exceeds two times the average rock size, dumping and spreading by heavy equipment will generally be the only procedures necessary to achieve adequate rock placement.
- C. After the start of construction of the riprap layer, a test section of the proper thickness and gradation should be constructed. This test section should be visually examined, and contractor personnel should become familiar with the visual properties of this section; that is, the acceptable section should be used as visual guidance of proper placement and should be used to evaluate future riprap placement. The test section should be tested to determine its gradation and rock weight/unit volume that will be achieved in future rock placement activities. Using the test section as a guide, gradation tests may be needed at any locations where the rock placement does not appear to be adequate, based on visual examinations, or if difficulties are experienced during rock production or placement.

### 3 SAMPLE SPECIFICATIONS

The following is an example of specifications that were used at several sites, and accepted by the staff. Specifications that are similar to these are acceptable to the staff. It should be noted that these specifications are only examples and any requirements imposed by these specifications represent construction requirements imposed on subcontractors by general contractors. These are not NRC requirements.

#### 3.1 General

This Specification Section describes the requirements for furnishing and placing rock riprap and granular aggregate materials for the construction of erosion protection covers, bedding layers, perimeter aprons, key trenches, gullies, and linings for permanent drainage ditches.

#### 3.2 Products

##### 3.2.1 General

- A. Material Sources: Erosion protection materials shall be obtained from approved sources. The subcontractor may propose sources other than those shown on the Subcontract Drawings. The basis for approval of erosion protection material sources is specified in Article 3.2.3 below.
- B. Approval of a source as a borrow area does not mean that all materials excavated will meet the requirements of this Specification. Processing or selective quarrying, or both, will generally be necessary to meet the gradation and quality requirements of this Section.
- C. The materials shall be below the background radioactive level and free from other contamination.
- D. Material shall be dense, sound, resistant to abrasion, and shall be free from cracks, seams, and other defects as shown in the petrographic examination and during field inspection, as per Article 3.2.3.B.1 below.
- E. The subcontractor may propose other sources of materials. The basis for approval of the Subcontractor-proposed sources shall be as specified in Article 3.2.3. The materials shall meet the requirements of this specification.
- F. Quality and Gradation Tests: For record purposes, the following tests will be performed.

**Table F-1. Quality and gradation tests.**

Test	Designation
Gradation	ASTM C117 ASTM C136
Specific Gravity (Saturated Surface Dry Basis)	ASTM C127
Absorption	ASTM C127
Sodium Sulfate Soundness	ASTM C88 (5 cycles)
Abrasion	ASTM C131 (100 revolutions)
Schmidt Rebound Hardness	ISRM Method
Petrographic Examination	ASTM C295

The frequency of tests shall be in accordance with Article 3.4.1.C for the total amount produced at each quarry regardless of number of types of materials produced.

**3.2.2 Quality Requirements**

- A. All riprap and bedding materials used shall meet the following requirements as tested by the Contractor:
  1. The tests specified in Table F-1 shall be taken at the frequency specified in 3.4.1.C for each material type. The score for each test is determined by multiplying the appropriate weighing factor by the score (0 to 10) based on the specific test results. The final score for each sample is the ratio of the sum of the individual test scores (five tests) to the maximum possible score, expressed as a percentage. To be acceptable, the final score must be no less than 80 percent for riprap and bedding material as presented in Table F-2.
  2. The Schmidt Rebound Hardness Test will be not required on the bedding material with a  $D_{50}$  smaller than 2-inches. The scoring for these materials will be based on the four remaining tests.
  3. If a combination of limestone, sandstone and igneous rock is found for a source, the source will be analyzed and percentages of each type of material used for calculating a score.

**Table F-2. Scoring criteria for determining rock quality.**

Laboratory Test	Weighting Factor			Score										
	Lime-stone	Sand-stone	Igneous	10	9	8	7	6	5	4	3	2	1	0
				Good			Fair				Poor			
Sp. Gravity	12	6	9	2.75	2.70	2.65	2.60	2.55	2.50	2.45	2.40	2.35	2.40	2.25
Absorption, %	13	5	2	.10	.30	.50	.67	.83	1.0	1.5	2.0	2.5	3.0	3.5
Sodium Sulfate, %	4	3	11	1	3	5	6.7	8.3	10	12.5	15	20	25	30
L/A Abrasion (100 revs), %	1	8	1	1	3	5	6.7	8.3	10	12.5	15	20	25	30
Schmidt Hammer	11	13	3	70	65	60	54	47	40	32	24	16	8	0

1. Scores were derived from Tables 6.2, 6.5, and 6.7 of NUREG/CR-2642 - "Long-Term Survivability of Riprap for Armoring Uranium Mill Tailings and Covers: A Literature Review," 1982.
2. Weighting Factors are derived from Table 7 of "Petrographic Investigations of Rock Durability and Comparisons of Various Test Procedures," by G. W. DuPuy, Engineering Geology, July 1965. Weighing factors are based on inverse of ranking of test methods for each rock type. Other tests may be used; weighting factors for these tests may be derived using Table 7, by counting upward from the bottom of the table.
3. Test methods should be standardized, if a standard test is available, and should be those used in NUREG/CR-2642, so that proper correlations can be made.

### 3.2.3 Subcontractor-Proposed Sources

A. The basis for approval of sources proposed by the Subcontractor shall be as follows:

1. A site inspection report will be prepared by an independent testing laboratory's engineering geologists, which will include, as a minimum, an evaluation of soundness, hardness, and durability for three samples representative of the proposed source. The evaluation of durability shall be based in part on petrographic examination of rock types available from the source. In addition, the material shall meet the quality requirements of Article 3.2.2.A above. Representativeness of samples shall be determined by the Contractor, based on precise location and source of sample taken in relation to the whole borrow area. The site inspection report shall include locations of all samples and methods of sampling.
2. The Subcontractor shall have a qualified laboratory perform the tests listed in Table F-1 on each sample (minimum of 3 samples) obtained from each proposed source. Special attention shall be given to ensure that the samples are representative of the proposed rock materials. Test samples shall be obtained from within the precise locations of rock deposits from which materials will be produced. To be approved as a source, the final score for each sample shall be obtained and evaluated as specified in Paragraph 2.2.A.1.

### 3.2.4 Gradation Requirements

A. Materials shall be reasonably well-graded within the following limits:

1. Riprap:
  - a. Gradation: Riprap materials shall be reasonably well-graded within the limits presented in Table F-3. The sizes are specified in terms of square openings of U.S. Standard Sieves or by the Nominal Sizes of the Materials. The Contractor reserves the right of inspection while the samples are being taken.
  - b. Maximum Size: No individual piece shall be greater than 90 percent of the riprap layer thickness.

Table F-3. Riprap gradation.

U. S. Standard Sieve Size (Nominal) (Square Openings)	Percent Passing (by weight)
Type A	
3-inch	100
2-inch	5-100
1-½ inch	0-42
¾ -inch	0-18
No. 4	0-5
Type B	
8-inch	100
5-inch	0-100
3-inch	0-36
2-inch	0-16
½-inch	0-5
Type C	
8-inch	100
6-inch	15-100
5-inch	0-55
3-inch	0-25
¾-inch	0-5
Type D	
18-inch	100
12-inch	10-65
10-inch	0-40
6-inch	0-20
1-½-inch	0-5
Type E	
42-inch	100
30-inch	25-100
24-inch	5-50
16-inch	0-25
4-inch	0-5



2. Bedding Material:

- a. Bedding material shall be obtained from borrow areas approved by the Contractor. The Subcontractor shall process the materials, as required, to meet the gradation requirements specified below.
- b. Gradation: Bedding material shall be reasonably well-graded within the following limits:

Table F-4. Bedding gradation.

U. S. Standard Sieve Size (Nominal) (Square Openings)	Percent Passing (by weight)
3 inch	100
1-½ inch	50 - 100
¾ inch	37 - 82
No. 4	20 - 50
No. 20	0 - 14
No. 100	0 - 5

3.2.5 Source Quality Control

- A. The materials shall be inspected and tested by the Subcontractor at the borrow area to ensure that they meet all requirements of this Specification. Gradation requirements will be tested by the Contractor at the placement location.
- B. The Subcontractor shall provide a trailer and equipment for rock testing at each source and a qualified engineering geologist to monitor materials acquisition and production to ensure that only materials acceptable under Article 3.2.1 as confirmed by the Contractor are processed. During excavation or blasting of materials, the Contractor will inspect the site to ensure that stripping and material selection procedures are adequate to prevent inclusion of deleterious materials in processed materials. The Contractor reserves the right to inspect and test the materials.
- C. The contractor will perform gradation tests for select bedding material and for each type of riprap. The tests will be performed in accordance with the requirements of ASTM C136. For the type of material where the total quantity is greater than 30,000 cubic yards, tests will be performed at a frequency of one test for each 10,000 cubic yards of material produced. For the type of materials, where the total quantity is less than 30,000 cubic yards, there will be at least four tests performed with an initial test and one test for every third (by volume) of the total material produced.

### 3.3 Execution

#### 3.3.1 Placement and Compaction

- A. Erosion protection materials shall be handled, loaded, transported, stockpiled, and placed in a manner that avoids nonconformance with specifications due to segregation and degradation, including materials moved to and from stockpiles.
- B. Subgrade preparation shall be as specified in Specifications.
- C. Where the required bedding material thickness is six inches or less, the bedding material shall be spread and compacted in one layer.
- D. Placing of material by methods that will tend to segregate particle sizes within the layer will not be permitted.
- E. Riprap material, up to a maximum nominal size of 12 inches, may be placed by end-dumping and may be spread by bull-dozers or other suitable equipment.
- F. Dumped riprap shall be placed to its full course thickness in one operation and in such a manner as to avoid displacing the bedding material. The larger stones shall be well-distributed throughout the mass. The finished riprap shall be free from pockets of small stones and clusters of larger stones. Placing stone by dumping into chutes or by similar methods likely to cause segregation of the various sizes will not be permitted. The desired distribution of the various sizes of stones throughout the mass shall be obtained by selective loading of the material at the quarry or other source, by controlled dumping of successive loads during final placing, or by other methods of placement that will produce the specified results. Rearranging of individual stones by mechanical equipment or by hand may be required to the extent necessary to obtain a well-keyed and reasonably well-graded distribution of stone sizes as specified above. Larger pieces of riprap may require individual placement by equipment. Hand arrangement will be required only to the extent necessary to secure acceptable results. Stones shall be selected and positioned so as to produce an essentially solid, densely placed face of rock with all stones firmly wedged in place. Any stones that are not firmly wedged shall be adjusted and additional selected stones inserted or existing stones replaced, so as to achieve a solid interlock.
- G. For riprap placed by clam-shell or similar equipment, hand arrangement will be required only to the extent necessary to secure the results specified herein. Stones shall be selected individually and positioned manually under experienced supervision so as to produce an essentially solid layer with all stones firmly wedged in place. Any stones that are not firmly wedged, in the opinion of the Contractor, shall be adjusted by crow-bars or similar tools and additional selected stones inserted, or existing stones replaced, so as to achieve solid interlock.

- H. Each layer of riprap shall be track-walked by two passes of a Caterpillar D6 bulldozer or equal unless otherwise approved by the Contractor. Riprap shall be spread in a manner that will achieve full coverage and a uniformly distributed well-keyed, densely-placed layer.
- I. Construction equipment other than spreading and compaction equipment shall not be allowed to move over the placed riprap material and bedding material layers except at equipment crossovers as designated by the Contractor. Fill materials shall be placed temporarily at equipment crossovers to prevent degradation of placed riprap materials. Each crossover shall be cleaned of all contaminating materials and approved by the Contractor before additional materials are placed in these areas. Other construction equipment may move over placed riprap and bedding layers. The Contractor may restrict such traffic to minimize damage to completed layers. Areas of riprap and bedding layers damaged by construction equipment shall be restored to meet the requirements of the Specifications.

### 3.3.2 Tolerances

- A. The material layers shall be placed generally to the limits and thicknesses shown on the Subcontract Drawings within the following tolerances:
  - 1. The top of the frost protection or bedding subgrade shall be within  $\pm 0.1$  foot of the design elevations.
  - 2. Top of bedding material shall be within  $\pm 0.1$  foot of the design elevations.
  - 3. The in-place thickness of riprap material shall be between 90 percent and 125 percent of the thickness shown.
  - 4. Local irregularities not exceeding the thickness limits above will be permitted provided that such irregularities do not form noticeable mounds, ridges, swales or depressions that in the opinion of the Contractor could cause concentrations of surface runoff or form ponds or gullies.
  - 5. The material placed meets the gradation requirements specified.

Riprap layer thickness will be directly measured on a specified grid to determine that minimum thickness requirements are met. A specified area is determined on top of the riprap layer. The rock within the grid is removed to the top of the bedding layer (when appropriate). A measurement device (i.e., tape measure) may be used to determine the distance from the top of the bedding to the top of the riprap layer.

- B. Materials segregated or not placed according to the above requirements shall be regraded or adjusted, or removed and replaced using appropriate equipment, to conform with the tolerances and limits given above.

- C. Materials not meeting the requirements of this Section shall be removed and placed with specified materials. Rejected materials shall be disposed of at designated disposal sites. Materials not meeting the grading requirements shall be reprocessed or discarded. The Contractor may require modification of the processing and grading operations to ensure that the specified grading requirements are met.
- D. During placement of riprap material and bedding material, the Contractor will perform a minimum of four gradation tests in accordance with Article 3.2.4 above. An initial sample shall be obtained and tested during the early stages of placement activities. Additional samples shall be obtained and tested when approximately one-third and two-thirds of the total volume of material has been placed, and a final sample shall be obtained and tested near completion of placement activities. If the total volume of material placed for riprap and bedding material is greater than 30,000 cubic yards, a gradation test shall be performed for each additional 10,000 cubic yards, or fraction thereof placed.

### 3.4 Materials Testing

#### 3.4.1 Erosion Protection Materials Testing

- A. The bedding material and each type of riprap shall be tested by a commercial testing laboratory during production in accordance with the following:

Specific Gravity (SSD)	ASTM C-127
Absorption	ASTM C-127
Soundness (5 cycles)	ASTM C-88
Abrasion (100 resolutions)	ASTM C-131
Schmidt Rebound Hardness	ISRM Method

The results shall be submitted for analysis and subsequent acceptance or rejection of the material represented by the test results, based on engineering calculations.

- B. Each type of riprap and bedding material shall be tested for gradation in accordance with ASTM C-117 and ASTM C-136, as applicable. Test results shall be in accordance with the Design Specifications.
- C. Bedding material and each type of riprap material shall be tested a minimum of four times. The materials shall be tested initially prior to the delivery of any materials to the site and at the beginning of placement. Thereafter, the testing shall be performed at a minimum frequency of one test for each 10,000 cubic yards or fraction thereof produced or placed. When the total volume is less than 30,000 cubic yards, the test

frequency shall be three tests for each type material when approximately one-third and two-thirds of the total volume of material has been produced or placed. A final set of durability tests shall be performed near completion of production for each type of material. A final gradation test shall be performed near completion of placement for each type of material. When representative bedding and riprap materials are considered under-sized for tests, sufficiently large parent material shall be obtained for testing, or these tests will not be utilized in the scoring process.

- D. At least one petrographic examination shall be made for each rock type used for erosion protection materials. Testing shall be performed in accordance with ASTM C-295-90. If a combination of limestone, sandstone, and igneous rock is found for a source, percentages of each type material shall be determined for scoring.

### 3.4.2 Inspections

Daily visual inspections shall be performed to verify that quality-related activities are performed in accordance with requirements. Daily visual inspections performed by qualified and certified inspection personnel shall be accomplished during execution of the various work activities to verify compliance to the above-listed criteria.

### 3.4.3 Erosion Protection

The excavation, production, stockpiling, transportation, placement, and compaction of the erosion protection materials shall receive adequate inspection to verify the following: 1) proper techniques are employed to prevent degradation of the material due to improper handling; 2) distribution is uniform; 3) voids are kept as minimal as possible; and 4) proper gradation is maintained. The inspection shall also verify the lift thickness. Inspection will be performed at the material source, as required, to verify compliance with the specification requirements. Riprap material shall be visually inspected to verify that the material is dense, sound rock, resistant to abrasion, and free from cemented cracks, seams, and other defects, as shown in the petrographic examination.

For placement control purposes, a 50' x 50' or larger, test area shall be constructed for each type of riprap using material meeting gradation and thickness requirements, as specified. This section will be used to show what material meeting specifications looks like after placement, and to calibrate "eyes" of inspectors and other interested persons. If properly constructed on the tailings embankment, the section can become part of the completed erosion protection.

#### **4 EXAMPLES OF RIPRAP PLACEMENT**

Proper placement of bedding and riprap materials is an important element in the long-term stability of the erosion protection system. An example of poorly-placed riprap is presented in Figure F-1. Examples of marginally-placed riprap are presented in Figures F-2 and F-3. Figures F-4 and F-5 present examples of well-placed riprap.

In Figure F-1, note the large areas where rock has not been placed. In Figures F-2 and F-3, note the relatively uneven surfaces and areas where some segregation has occurred. In Figures F-4 and F-5, note the uniform surfaces and the dense placement of rock.



**Figure F-1. Poorly-placed riprap.**

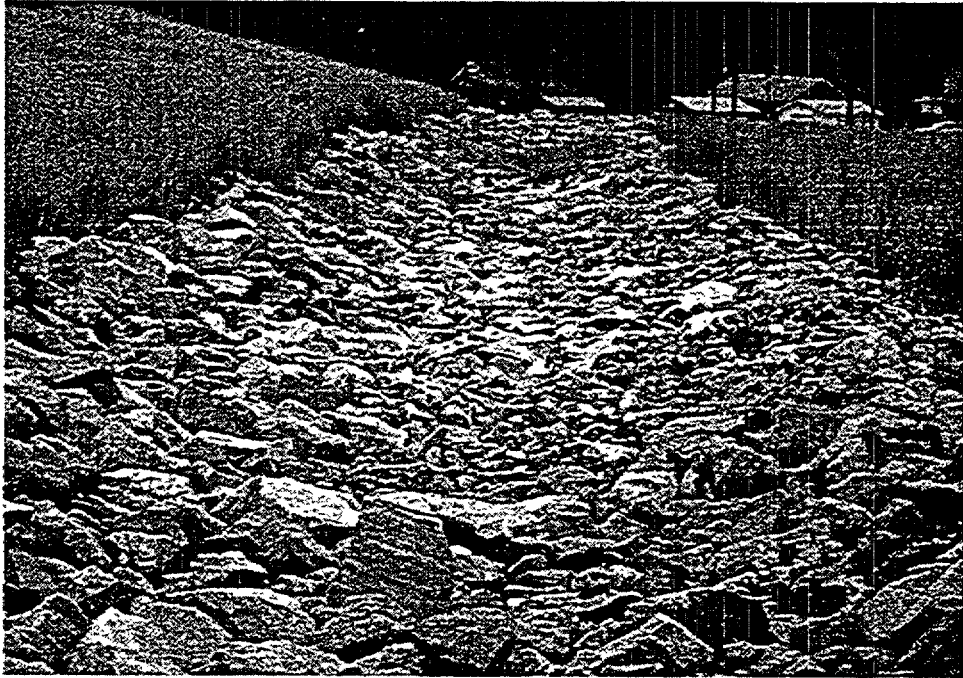
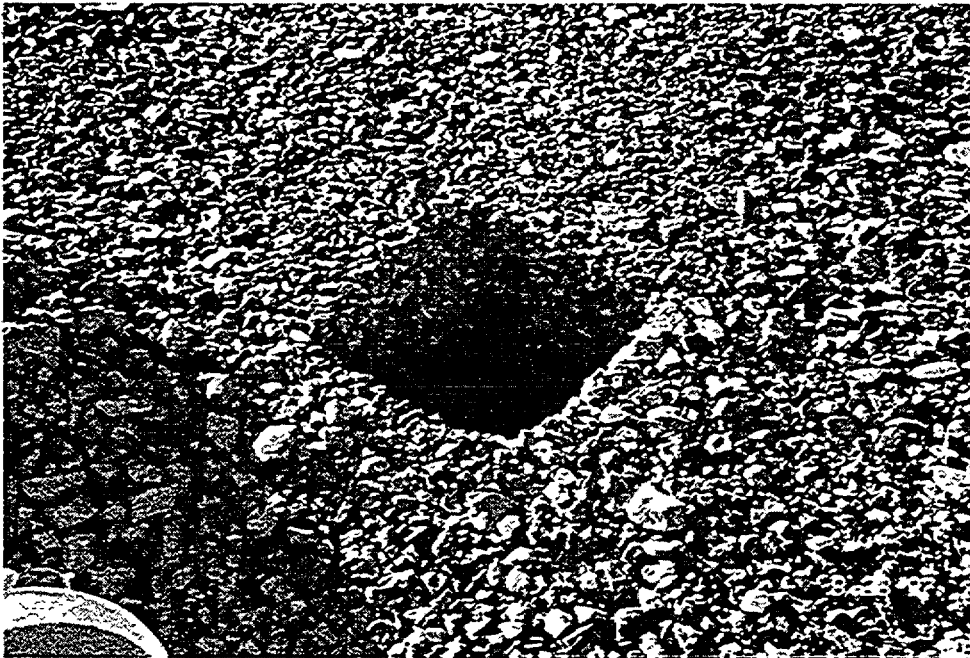

**Figure F-2. Marginally-placed riprap**



**Figure F-3. Marginally-placed riprap.**





**Figure F-4. Well-placed riprap  
(Testing area shown)**



Figure F-5. Well-placed riprap in diversion channel.

**BIBLIOGRAPHIC DATA SHEET**

(See instructions on the reverse)

1. REPORT NUMBER  
(Assigned by NRC, Add Vol., Supp., Rev.,  
and Addendum Numbers, if any.)

NUREG-1623

2. TITLE AND SUBTITLE

Design of Erosion Protection for Long-Term Stabilization

3. DATE REPORT PUBLISHED

MONTH	YEAR
September	2002

4. FIN OR GRANT NUMBER

5. AUTHOR(S)

T. L. Johnson

6. TYPE OF REPORT

Final

7. PERIOD COVERED (Inclusive Dates)

8. PERFORMING ORGANIZATION - NAME AND ADDRESS (If NRC, provide Division, Office or Region, U.S. Nuclear Regulatory Commission, and mailing address, if contractor, provide name and mailing address.)

Division of Fuel Cycle Safety and Safeguards  
Office of Nuclear Material Safety and Safeguards  
U. S. Nuclear Regulatory Commission  
Washington, DC 20555-0001

9. SPONSORING ORGANIZATION - NAME AND ADDRESS (If NRC, type "Same as above"; if contractor, provide NRC Division, Office or Region, U.S. Nuclear Regulatory Commission, and mailing address.)

Same as 8. Above

10. SUPPLEMENTARY NOTES

11. ABSTRACT (200 words or less)

This report provides methods that are acceptable to the NRC staff for the design of erosion protection for long-term stabilization and updates previous NRC guidance in this area. The design procedures are based on research and actual field data that were gathered over the past 15 years. This report is intended to apply to the design of erosion protection for uranium mill tailings sites, but can be used at other waste sites where erosional stability is required for similar time periods.

12. KEY WORDS/DESCRIPTORS (List words or phrases that will assist researchers in locating the report.)

Erosion Protection  
Design Guidance  
Riprap

13. AVAILABILITY STATEMENT

unlimited

14. SECURITY CLASSIFICATION

(This Page)

unclassified

(This Report)

unclassified

15. NUMBER OF PAGES

16. PRICE



Federal Recycling Program

**UNITED STATES  
NUCLEAR REGULATORY COMMISSION  
WASHINGTON, DC 20555-0001**

---

OFFICIAL BUSINESS  
PENALTY FOR PRIVATE USE, \$300