

# Comparison of US. Military and International Electromagnetic Compatibility Guidance

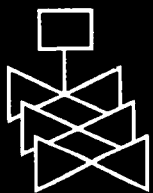

Draft Report for Comment

Oak Ridge National Laboratory

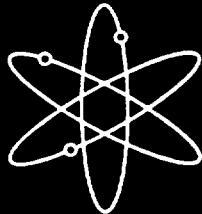

**U.S. Nuclear Regulatory Commission  
Office of Nuclear Regulatory Research  
Washington, DC 20555-0001**



## AVAILABILITY OF REFERENCE MATERIALS IN NRC PUBLICATIONS

### NRC Reference Material

As of November 1999, you may electronically access NUREG-series publications and other NRC records at NRC's Public Electronic Reading Room at <http://www.nrc.gov/reading-rm.html>. Publicly released records include, to name a few, NUREG-series publications; *Federal Register* notices; applicant, licensee, and vendor documents and correspondence; NRC correspondence and internal memoranda; bulletins and information notices; inspection and investigative reports; licensee event reports; and Commission papers and their attachments.

NRC publications in the NUREG series, NRC regulations, and *Title 10, Energy*, in the Code of *Federal Regulations* may also be purchased from one of these two sources.

1. The Superintendent of Documents  
U.S. Government Printing Office  
Mail Stop SSOP  
Washington, DC 20402-0001  
Internet: [bookstore.gpo.gov](http://bookstore.gpo.gov)  
Telephone: 202-512-1800  
Fax: 202-512-2250
2. The National Technical Information Service  
Springfield, VA 22161-0002  
[www.ntis.gov](http://www.ntis.gov)  
1-800-553-6847 or, locally, 703-605-6000

A single copy of each NRC draft report for comment is available free, to the extent of supply, upon written request as follows:

Address: Office of the Chief Information Officer,  
Reproduction and Distribution  
Services Section  
U.S. Nuclear Regulatory Commission  
Washington, DC 20555-0001  
E-mail: [DISTRIBUTION@nrc.gov](mailto:DISTRIBUTION@nrc.gov)  
Facsimile: 301-415-2289

Some publications in the NUREG series that are posted at NRC's Web site address <http://www.nrc.gov/reading-rm/doc-collections/nuregs> are updated periodically and may differ from the last printed version. Although references to material found on a Web site bear the date the material was accessed, the material available on the date cited may subsequently be removed from the site.

### Non-NRC Reference Material

Documents available from public and special technical libraries include all open literature items, such as books, journal articles, and transactions, *Federal Register* notices, Federal and State legislation, and congressional reports. Such documents as theses, dissertations, foreign reports and translations, and non-NRC conference proceedings may be purchased from their sponsoring organization.

Copies of industry codes and standards used in a substantive manner in the NRC regulatory process are maintained at—

The NRC Technical Library  
Two White Flint North  
11545 Rockville Pike  
Rockville, MD 20852-2738

These standards are available in the library for reference use by the public. Codes and standards are usually copyrighted and may be purchased from the originating organization or, if they are American National Standards, from—

American National Standards Institute  
11 West 42<sup>nd</sup> Street  
New York, NY 10036-8002  
[www.ansi.org](http://www.ansi.org)  
212-642-4900

Legally binding regulatory requirements are stated only in laws; NRC regulations; licenses, including technical specifications; or orders, not in NUREG-series publications. The views expressed in contractor-prepared publications in this series are not necessarily those of the NRC.

The NUREG series comprises (1) technical and administrative reports and books prepared by the staff (NUREG-XXXX) or agency contractors (NUREG/CR-XXXX), (2) proceedings of conferences (NUREG/CP-XXXX), (3) reports resulting from international agreements (NUREG/IA-XXXX), (4) brochures (NUREG/BR-XXXX), and (5) compilations of legal decisions and orders of the Commission and Atomic and Safety Licensing Boards and of Directors' decisions under Section 2.206 of NRC's regulations (NUREG-0750).

**DISCLAIMER:** This report was prepared as an account of work sponsored by an agency of the U.S. Government. Neither the U.S. Government nor any agency thereof, nor any employee, makes any warranty, expressed or implied, or assumes any legal liability or responsibility for any third party's use, or the results of such use, of any information, apparatus, product, or process disclosed in this publication, or represents that its use by such third party would not infringe privately owned rights.

---

---

# Comparison of U.S. Military and International Electromagnetic Compatibility Guidance

## Draft Report for Comment

---

---

Manuscript Completed: May 2002  
Date Published: July 2002

Prepared by:  
P.D. Ewing, ORNL,  
R.T. Wood, ORNL, and  
C.E. Antonescu, NRC

Oak Ridge National Laboratory  
Managed by UT-Battelle, LLC  
Oak Ridge, TN 37831-6370

C.E. Antonescu, NRC Project Manager

**Prepared for:**  
**Division of Engineering Technology**  
**Office of Nuclear Regulatory Research**  
**U.S. Nuclear Regulatory Commission**  
**Washington, DC 20555-0001**  
**NRC Job Code W6960**



## COMMENTING ON DRAFT REPORTS

Any interested party may submit comments on this report for consideration by the NRC staff. Comments may be accompanied by additional relevant information or supporting data. Please specify the report number **Draft NUREG/CR-6782** in your comments, and send them by the end of the 60 day comment period specified in the Federal Register notice announcing availability of this draft.

Chief, Rules and Directives Branch  
Mail Stop: T6-D59  
U.S. Nuclear Regulatory Commission  
Washington, DC 20555-0001

You may also provide comments at the NRC Web site:

<http://www.nrc.gov/public-involve/doc-comment/form.html>

For any questions about the material in this report, please contact:

Christina Antonescu  
Mail Stop T10-L1  
U.S. Nuclear Regulatory Commission  
Washington, DC 20555-0001  
Phone: (301) 415-6792  
E-mail: [ceal@nrc.gov](mailto:ceal@nrc.gov)

## ABSTRACT

The Oak Ridge National Laboratory (ORNL) has been engaged by the U.S. Nuclear Regulatory Commission (NRC) Office of Nuclear Regulatory Research to assist in developing the technical basis for regulatory guidance on electromagnetic interference (EMI) and radio-frequency interference (RFI) immunity and power surge withstand capability (SWC). Previous research has provided recommendations on electromagnetic compatibility (EMC) design and installation practices, endorsement of EMI/RFI immunity and SWC test criteria and test methods, and determination of ambient electromagnetic conditions at nuclear power plants. These recommendations have been incorporated into the technical basis for guidance in addressing EMI/RFI and power surges in safety-related instrumentation and control (I&C) systems in nuclear power plants.

The recommendations by the ORNL staff on test criteria, test methods, and operating envelopes were significantly influenced by the military standards issued by the U.S. Department of Defense (DOD). That is the case because until recently there were no comprehensive commercial standards that covered EMI/RFI immunity. The present research involves reviewing and assessing the commercial standards issued by the International Electrotechnical Commission (IEC) and endorsed by the European Union in the last few years. This document reports the results of a study performed by the ORNL staff comparing Regulatory Guide 1.180, the U.S. military standards, and international EMC guidance.

## CONTENTS

	Page
ABSTRACT.....	iii
FIGURES.....	vii
TABLES.....	ix
EXECUTIVE SUMMARY.....	xi
ACKNOWLEDGMENTS.....	xiii
ACRONYMS.....	xv
GLOSSARY.....	xvii
1 INTRODUCTION.....	1
2 RESULTS OF PREVIOUS RESEARCH EFFORTS.....	1
3 REVIEW OF MIL-STD-461E.....	3
4 OVERVIEW OF IEC 61000 TESTS AND ASSESSMENT APPROACH.....	4
4.1 IEC 61000 Emissions Test Methods.....	4
4.2 IEC 61000 Immunity Test Methods.....	4
4.3 Assessment Approach.....	5
5 COMPARISON OF EMISSIONS TESTS.....	5
5.1 Low-Frequency Emissions Tests.....	5
5.2 High-Frequency Emission.....	8
6 COMPARISON OF CONDUCTED SUSCEPTIBILITY TESTS.....	12
6.1 Conducted Susceptibility, Low Frequency—CS101 vs IEC 61000-4-13 and -4-16.....	12
6.1.1 Low-Frequency Conducted Susceptibility—Coverage.....	14
6.1.2 Low-Frequency Conducted Susceptibility—Methodology.....	14
6.1.3 Low-Frequency Conducted Susceptibility—Operating Envelopes.....	15
6.1.4 Low-Frequency Conducted Susceptibility—Findings.....	17
6.2 Conducted Susceptibility, High Frequency—CS114 vs IEC 61000-4-16 and -4-6.....	17
6.2.1 High-Frequency Conducted Susceptibility—Coverage.....	18
6.2.2 High-Frequency Conducted Susceptibility—Methodology.....	18
6.2.3 High-Frequency Conducted Susceptibility—Operating Envelopes.....	20
6.2.4 High-Frequency Conducted Susceptibility—Findings.....	20
6.3 Conducted Susceptibility, Impulse Excitation—CS115 vs IEC 61000-4-4.....	21
6.3.1 Impulse-Excitation Conducted Susceptibility—Coverage.....	22
6.3.2 Impulse-Excitation Conducted Susceptibility—Methodology.....	22
6.3.3 Impulse-Excitation Conducted Susceptibility—Operating Envelopes.....	25
6.3.4 Impulse-Excitation Conducted Susceptibility—Findings.....	26
6.4 Conducted Susceptibility, Damped Sinusoid—CS116 vs IEC 61000-4-12.....	26
6.4.1 Damped-Sinusoid Conducted Susceptibility—Coverage.....	26
6.4.2 Damped-Sinusoid Conducted Susceptibility—Methodology.....	26
6.4.3 Damped-Sinusoid Conducted Susceptibility—Operating Envelopes.....	28
6.4.4 Damped-Sinusoid Conducted Susceptibility—Findings.....	29

7	COMPARISON OF RADIATED SUSCEPTIBILITY TESTS .....	29
7.1	Radiated Susceptibility, Low Frequency—RS101 vs IEC 61000-4-8, -4-9 and -10 .....	30
7.1.1	Low-Frequency Radiated Susceptibility—Coverage .....	31
7.1.2	Low-Frequency Radiated Susceptibility—Methodology .....	31
7.1.3	Low-Frequency Radiated Susceptibility—Operating Envelopes .....	31
7.1.4	Low-Frequency Radiated Susceptibility—Findings .....	33
7.2	Radiated Susceptibility, High Frequency—RS103 vs IEC 61000-4-3 .....	34
7.2.1	High-Frequency Radiated Susceptibility—Coverage .....	34
7.2.2	High-Frequency Radiated Susceptibility—Methodology .....	35
7.2.3	High-Frequency Radiated Susceptibility—Operating Envelopes .....	35
7.2.4	High-Frequency Radiated Susceptibility—Findings .....	35
8	COMPARISON OF SWC TEST METHODS .....	36
8.1	Ring Wave—IEEE C62.41 vs IEC 61000-4-12 .....	36
8.2	Combination Wave—IEEE C62.41 vs IEC 61000-4-5 .....	37
8.3	Electrically Fast Transients/Bursts—IEEE C62.41 vs IEC 61000-4-4 .....	38
9	CONCLUSIONS .....	39
10	REFERENCES .....	40
	APPENDIX A. MIL-STD-461E CHANGES .....	43

## FIGURES

	Page
5.1 Low-frequency emissions coverage .....	6
5.2 CE101 operating envelope .....	7
5.3 RE101 operating envelope .....	7
5.4 High frequency emissions coverage .....	8
5.5 CE102 operating envelope .....	10
5.6 RE102 operating envelope .....	11
6.1 Conducted susceptibility frequency coverage .....	12
6.2 CS101 signal injection setup .....	14
6.3 Low-frequency susceptibility operating envelopes .....	17
6.4 IEC 61000-4-6 coupling and decoupling network .....	19
6.5 IEC 61000-4-6 signal injection setup .....	19
6.6 High-frequency conducted susceptibility operating envelopes .....	21
6.7 CS115 test signal .....	23
6.8 IEC 6100-4-4 electrically fast transients/bursts .....	23
6.9 Waveform of fast transient .....	24
6.10 IEC 61000-4-4 capacitive injection clamp .....	24
6.11 IEC 61000-4-4 coupling/decoupling network .....	24
6.12 Waveform of CS116 test signal .....	27
6.13 Waveform of the damped oscillatory wave .....	28
6.14 Damped sinusoid conducted susceptibility operating envelopes .....	29
7.1 Radiated susceptibility frequency coverage .....	30
7.2 Low-frequency radiated susceptibility operating envelopes .....	33
8.1 100-kHz ring wave .....	37
8.2 Combination wave, open-circuit voltage .....	37
8.3 Combination wave, short-circuit current .....	38



## TABLES

		Page
2.1	Recommended MIL-STD-461D test criteria.....	2
2.2	Representative power surge waveforms.....	2
4.1	IEC 61000-4 immunity test methods.....	4
5.1	Comparison of high-frequency conducted emissions test methods.....	9
5.2	Comparison of high-frequency radiated emissions test methods.....	9
5.3	IEC 61000-6-4 conducted emissions limits.....	11
5.4	IEC 61000-6-4 radiated emissions limits.....	11
6.1	IEC 6100-4-13 test classes.....	13
6.2	Guidelines for selecting levels associated with IEC 61000-4-16.....	13
6.3	Comparison of low-frequency conducted susceptibility tests.....	14
6.4	IEC 61000-4-13 operating envelope for 115-V system.....	15
6.5	IEC 61000-4-16 test levels for continuous disturbance.....	15
6.6	IEC 61000-4-16 test levels for short-duration disturbance.....	16
6.7	IEC 61000-4-16 test levels for conducted disturbance, 15 Hz to 150 kHz.....	16
6.8	Operating envelopes for IEC 61000-4 conducted susceptibility tests.....	16
6.9	Comparison of high-frequency conducted susceptibility tests.....	18
6.10	IEC 61000-4-6 test levels.....	20
6.11	IEC 61000-4-6 test classes.....	20
6.12	Comparison of switching-transients conducted susceptibility tests.....	22
6.13	IEC 61000-4-4 test classes.....	25
6.14	IEC 61000-4-4 test levels.....	25
6.15	Comparison of damped-sinusoid conducted susceptibility tests.....	27
6.16	IEC 61000-4-12 testing guidelines.....	28
6.17	IEC 61000-4-12 test levels.....	29
7.1	Comparison of low-frequency radiated susceptibility tests.....	31

7.2	IEC 61000-4-8 test classes .....	32
7.3	IEC 61000-4-9 and -4-10 test classes .....	32
7.4	IEC 61000-4-8 test levels for continuous field .....	33
7.5	Comparison of high-frequency radiated susceptibility tests .....	35
7.6	IEC 61000-4-3 test classes .....	36
7.7	IEC 61000-4-3 test levels .....	36
9.1	MIL-STD-461E and IEC 61000 test methods .....	39
9.2	Corresponding IEEE C62.41 and IEC 61000 test methods .....	39

## EXECUTIVE SUMMARY

Oak Ridge National Laboratory (ORNL) has been engaged by the U.S. Nuclear Regulatory Commission (NRC) Office of Nuclear Regulatory Research to perform confirmatory research associated with developing the technical basis for regulatory guidance to address electromagnetic interference (EMI), radio-frequency interference (RFI), and surge withstand capability (SWC) in safety-related instrumentation and control (I&C) systems. To date, ORNL staff have issued three technical reports, detailing their findings and recommendations, that have become the technical basis for Regulatory Guide (RG) 1.180, *Guidelines for Evaluating Electromagnetic and Radio-Frequency Interference in Safety-Related Instrumentation and Control Systems*. NUREG/CR-5941, *Technical Basis for Evaluating Electromagnetic and Radio-Frequency Interference in Safety-Related I&C Systems*, discusses the test criteria and associated test methods recommended for safety-related I&C systems to be installed in nuclear power plants (NPPs). NUREG/CR-6436, *Survey of Ambient Electromagnetic and Radio-Frequency Levels in Nuclear Power Plants*, reports on the measurement data collected at selected NPP sites and the resulting electromagnetic emission profiles. NUREG/CR-6431, *Recommended Electromagnetic Operating Envelopes for Safety-Related I&C Systems in Nuclear Power Plants*, presents recommendations for operating envelopes to augment the test criteria and test methods discussed in NUREG/CR-5941.

ORNL staff have also developed an additional document to address the vulnerability of equipment to conducted disturbances along interconnecting signal lines. NUREG/CR-5609, *Electromagnetic Compatibility Testing for Conducted Susceptibility Along Interconnecting Signal Lines*, presents recommendations and the associated technical basis for addressing the effects of conducted EMI/RFI along interconnecting signal lines in safety-related I&C systems. These new findings, along with the findings of this report, are expected to be included in the impending update of RG 1.180.

The previous recommendations by ORNL staff on test criteria, test methods, and operating envelopes were based on both commercial and military standards. The EMI/RFI recommendations were derived from the U.S. Department of Defense (DOD) Military Standard (MIL-STD) 461D, *Electromagnetic Emission and Susceptibility Requirement for the Control of Electromagnetic Interference*, and MIL-STD-462D, *Measurement of Electromagnetic Interference Characteristics*. The SWC recommendations are derived from Institute of Electrical and Electronics Engineers (IEEE) Std C62.41, *IEEE Recommended Practice on Surge Voltages in Low-Voltage AC Power Circuits*, and IEEE Std C62.45, *IEEE Guide on Surge Testing for Equipment Connected to Low-Voltage AC Power Circuits*. The MIL-STDs and IEEE Stds were selected because they represented the most comprehensive EMI/RFI immunity and SWC guidance available at the time of the initial reviews.

Since the original investigation, a series of comprehensive commercial EMI/RFI immunity standards have been issued by the International Electrotechnical Commission (IEC) and endorsed by the European Union through the European Committee for Electrotechnical Standardization (CENELEC). In addition, the U.S. DOD has issued MIL-STD-461E, *Requirements for the Control of Electromagnetic Interference Characteristics of Subsystems and Equipment*, to supersede MIL-STD-461D and MIL-STD-462D. The present research involves reviewing and assessing the commercial IEC 61000 standards and comparing them with the U.S. military and IEEE guidance on test methods and the RG 1.180 guidance on test criteria. It also includes a review of MIL-STD-461E. This report details the assessments, the comparisons, and subsequent findings by ORNL staff on the applicability of the IEC series of immunity standards for the NPP environment.

## **ACKNOWLEDGMENTS**

The authors wish to thank Christina Antonescu, JCN W6960 Project Manager, of the U.S. Nuclear Regulatory Commission Office of Nuclear Regulatory Research (RES) for her help in initiating, planning, and implementing this research effort. The authors would also like to thank John Calvert of RES Engineering Research Applications Branch for his support on the project.

## ACRONYMS

ANSI	American National Standards Institute
CDN	coupling/decoupling network
CE	conducted emissions
CENELEC	Comite European de Normalisation Electrotechnique (European Committee for Electrotechnical Standardization)
CISPR	Special Committee on Radio Interference
CS	conducted susceptibility
CW	continuous wave
DIESC	Defense/Industry E3 Standards Committee
DOD	Department of Defense
DTRA	Defense Threat Reduction Agency
EFT	electrical fast transient
EFT/B	electrically fast transient/burst
EM	electromagnetic
EMC	electromagnetic compatibility
EMI	electromagnetic interference
EUT	equipment under test
I&C	instrumentation and control
IEC	International Electrotechnical Commission
IEEE	Institute of Electrical and Electronics Engineers
I/O	input/output
ISM	industrial, scientific, medical
ITE	information technology equipment
JSC	Joint Spectrum Center
LISN	line impedance stabilization network
MAD	magnetic anomaly detection
MIL-STD	military standard
NASA	National Aeronautics and Space Administration
NEMA	National Electronics Manufacturers Association
NPP	nuclear power plant
NRC	U.S. Nuclear Regulatory Commission
ORNL	Oak Ridge National Laboratory
PC	personal computer
QP	quasi-peak
RE	radiated emissions
RES	Office of Nuclear Regulatory Research
RF	radio frequency
RFI	radio-frequency interference
RG	regulatory guide
RS	radiated susceptibility
SAE	Society of Automotive Engineers
SWC	surge withstand capability
TV	television
VCR	video cassette recorder

## GLOSSARY

A	ampere, unit of current
Ac	alternating current
Cm	centimeter— $10^{-2}$ meter, unit of length
DB	decibel—ten times the logarithm to base 10 of a ratio of two powers, or twenty times the logarithm to base 10 of a ratio of two voltages or currents
dB $\mu$ A	decibels referenced to one microampere, unit of conducted interference
dB $\mu$ V	decibels referenced to one microvolt, unit of conducted interference
dB $\mu$ V/m	decibels referenced to one microvolt per meter, unit of electric field strength
dBpT	decibels referenced to one picoTesla, unit of magnetic field strength
dc	direct current
F	frequency
GHz	gigahertz— $10^9$ Hertz
Hz	hertz—unit of frequency, one cycle per second
I(t)	instantaneous current at time t
I <sub>MAX</sub>	maximum current
I <sub>N</sub>	peak current at N <sup>th</sup> cycle
I <sub>p</sub>	peak current
kA	kiloamperes— $10^3$ A, unit of current
kHz	kilohertz— $10^3$ Hz
km	kilometer, $10^3$ meters, unit of length
kV	kilovolt— $10^3$ V, unit of voltage
ln	natural log
m	meter, unit of length
mA	milliAmpere— $10^{-3}$ A, unit of current
mm	millimeter— $10^{-3}$ meter, unit of length
MHz	megahertz— $10^6$ Hz
min	minute, unit of time
$\mu$ H	microhenry— $10^{-6}$ henry, unit of inductance
$\mu$ s	microsecond— $10^{-6}$ s
ns	nanosecond— $10^{-9}$ s
$\Omega$	ohm, unit of resistance
$\pi$	pi, 3.141415926...
PF	power factor
rms	root mean square—square root of the average square of an instantaneous magnitude
Q	damping factor
t	time
V	volt, unit of voltage
V(t)	instantaneous voltage at time t
V/m	volts per meter, unit of electric field strength
V <sub>p</sub>	peak voltage
W	Watt, unit of power

## 1. INTRODUCTION

Oak Ridge National Laboratory (ORNL) has been engaged by the U.S. Nuclear Regulatory Commission (NRC) Office of Nuclear Regulatory Research to perform confirmatory research associated with developing the technical basis for regulatory guidance to address electromagnetic interference (EMI), radio-frequency interference (RFI), and surge withstand capability (SWC) in safety-related instrumentation and control (I&C) systems. To date, ORNL staff have issued three technical reports, detailing their findings and recommendations, that have become the technical basis for Regulatory Guide (RG) 1.180, *Guidelines for Evaluating Electromagnetic and Radio-Frequency Interference in Safety-Related Instrumentation and Control Systems*.<sup>1</sup> NUREG/CR-5941, *Technical Basis for Evaluating Electromagnetic and Radio-Frequency Interference in Safety-Related I&C Systems*,<sup>2</sup> discusses the test criteria and associated test methods recommended for safety-related I&C systems to be installed in nuclear power plants (NPPs). NUREG/CR-6436, *Survey of Ambient Electromagnetic and Radio-Frequency Levels in Nuclear Power Plants*,<sup>3</sup> reports on the measurement data collected at selected NPP sites and the resulting electromagnetic emission profiles. NUREG/CR-6431, *Recommended Electromagnetic Operating Envelopes for Safety-Related I&C Systems in Nuclear Power Plants*,<sup>4</sup> presents recommendations for operating envelopes to augment the test criteria and test methods discussed in NUREG/CR-5941.

ORNL staff have also developed an additional document to address the vulnerability of equipment to conducted disturbances along interconnecting signal lines. NUREG/CR-5609, *Electromagnetic Compatibility Testing for Conducted Susceptibility Along Interconnecting Signal Lines*,<sup>5</sup> presents recommendations and the associated technical basis for addressing the effects of conducted EMI/RFI along interconnecting signal lines in safety-related I&C systems. These new findings, along with the findings of this report, are expected to be included in the impending update of RG 1.180.

The previous recommendations by ORNL staff include test criteria, test methods, and operating envelopes and were based on both commercial and military standards. The EMI/RFI recommendations were derived from the U.S. Department of Defense (DOD) Military Standard (MIL-STD) 461D, *Electromagnetic Emission and Susceptibility Requirement for the Control of Electromagnetic Interference*,<sup>6</sup> and MIL-STD-462D, *Measurement of Electromagnetic Interference Characteristics*.<sup>7</sup> The SWC recommendations were derived from Institute of Electrical and Electronics Engineers (IEEE) Std C62.41, *IEEE Recommended Practice on Surge Voltages in Low-Voltage AC Power Circuits*,<sup>8</sup> and IEEE Std C62.45, *IEEE Guide on Surge Testing for Equipment Connected to Low-Voltage AC Power Circuits*.<sup>9</sup> The MIL-STDs and IEEE standards were selected because they represented the most comprehensive EMI/RFI immunity and SWC guidance available at the time of the initial reviews. However, the recommended test criteria (e.g., operating envelopes) in RG 1.180 are tailored for nuclear power plant application based on the technical findings documented in the referenced NUREG/CRs.

Since the original investigation, a series of comprehensive commercial EMI/RFI immunity standards have been issued by the International Electrotechnical Commission (IEC) and endorsed by the European Union through the European Committee for Electrotechnical Standardization (CENELEC). In addition, the U.S. DOD has issued MIL-STD-461E, *Requirements for the Control of Electromagnetic Interference Characteristics of Subsystems and Equipment*,<sup>10</sup> to replace MIL-STD-461D and MIL-STD-462D. The present research involves reviewing and assessing the commercial IEC standards and comparing them with the U.S. military and IEEE guidance on methods and the RG 1.180 guidance on criteria. It also includes a review of MIL-STD-461E.

## 2. RESULTS OF PREVIOUS RESEARCH EFFORTS

The test criteria from MIL-STD-461D that were found to be applicable for evaluating the effects of EMI/RFI in safety-related I&C systems are listed in Table 2.1. The test criteria are specified by

alphanumeric codes: the first designation declares the criterion to be either radiated (R) or conducted (C), and the second designation specifies whether it covers emissions (E) or susceptibility (S). This alphabetic designation is followed by a numbering system that is specific to the particular test criterion.

**Table 2.1. Recommended MIL-STD-461D test criteria**

Criterion	Description
CE101	Conducted emissions, power leads, 30 Hz to 10 kHz
CE102	Conducted emissions, power leads, 10 kHz to 10 MHz
CS101	Conducted susceptibility, power leads, 30 Hz to 50 kHz
CS114	Conducted susceptibility, bulk cable injection, 10 kHz to 400 MHz
CS115	Conducted susceptibility, bulk cable injection, impulse excitation
CS116	Conducted susceptibility, damped sinusoidal transients, cables and power leads, 10 kHz to 100 MHz
RE101	Radiated emissions, magnetic field, 30 Hz to 100 kHz
RE102	Radiated emissions, electric field, 10 kHz to 1 GHz
RS101	Radiated susceptibility, magnetic field, 30 Hz to 100 kHz
RS103	Radiated susceptibility, electric field, 10 kHz to 1 GHz

C = conducted, E = emissions, R = radiated, and S = susceptibility.

Corresponding test methods in MIL-STD-462D are used to demonstrate compliance with the MIL-STD-461D test criteria. The purpose of the conducted emissions (CE) tests is to ensure that equipment connected to the power bus does not corrupt its power quality (i.e., introduce distortions in the voltage waveforms) or cause excess radiation from the power bus. The conducted susceptibility (CS) tests are intended to ensure that equipment performance will not be degraded in the event that distortions in the voltage waveforms and high-frequency conducted EMI/RFI are somehow introduced on the power bus and signal leads. The purpose of the radiated emissions (RE) tests is to control the magnetic-field and electric-field emissions from equipment and its associated cables. The radiated susceptibility (RS) tests are intended to ensure that equipment will operate without degradation in the presence of significant electromagnetic field levels.

The SWC practices described in IEEE Std C62.41 are recommended to control the occurrence of upsets in safety-related I&C equipment caused by power surges originating from two major sources: lightning effects (direct or indirect) and switching transients. The waveforms called out in IEEE Std C62.41-1991 are ring wave, combination wave, and electrically fast transients/bursts (EFT/B). Descriptions of the waveforms are provided in Table 2.2. The SWC test procedures are supplied in IEEE Std C62.45. Tests employing these waveforms are expected to provide reproducible results and are expected to provide a reasonable degree of assurance that problems associated with power surges are averted.

**Table 2.2. Representative power surge waveforms**

Parameter	Ring wave	Combination wave		EFT/B
Waveform	Open-circuit voltage	Open-circuit voltage	Short-circuit current	Pulses in 15-ms bursts
Rise time	0.5 $\mu$ s	1.2 $\mu$ s	8 $\mu$ s	5 ns
Duration	100 kHz ringing	50 $\mu$ s	20 $\mu$ s	50 ns

EFT/B = electrically fast transients/bursts.

Further discussion of the rationale for the selection of these EMI/RFI and SWC test criteria can be found in the published NUREG/CR reports.<sup>2-5</sup>



### 3. REVIEW OF MIL-STD-461E

MIL-STD-461E was issued on August 20, 1999 and supersedes MIL-STD-461D and MIL-STD-462D. It consolidates the two "D"-version documents into a single standard. The purpose of MIL-STD-461E is to establish the interface and associated verification requirements necessary for controlling the EMI/RFI characteristics of electronic and electrical equipment and subsystems. The document is concerned only with specifying technical requirements for controlling EMI/RFI (emissions and susceptibility) at the subsystem and equipment level. Application of the standard is best suited for items that have the following features: electronic enclosures that are no larger than an equipment rack, electrical interconnections that are discrete wiring harnesses between enclosures, and electrical power input derived from prime power sources. MIL-STD-461E is not intended to be directly applied to items such as modules located inside electronic enclosures or entire platforms. However, the principles in the standard may be useful as a basis for developing suitable requirements for these applications.

The test methods previously contained in MIL-STD-462D to verify compliance with the MIL-STD-461D test criteria have also been included in MIL-STD-461E. The stated interface requirements are considered necessary to provide reasonable confidence that a particular subsystem or piece of equipment complying with the requirements will function within designated design tolerances when operating in its intended electromagnetic environment. A committee consisting of representatives of the U.S. Army, Air Force, and Navy; other DOD agencies; and industry prepared the document.

MIL-STD-461E has two primary sections, the main body and the appendix. The main body contains the interface and verification requirements of the standard. Data collection requirements are also included. The appendix provides background information for the emissions and susceptibility test criteria and associated test methods described in the main body. This information includes rationale for requirements, guidance in applying the requirements, and lessons learned from platform and laboratory experience.

The changes and additions in MIL-STD-461E from MIL-STD-461D and MIL-STD-462D include the following:

- Equipment under test (EUT) hardware and software must now be representative of production units.
- Susceptibility scan rates have been revised.
- The frequency of measurement system test checks has been revised.
- CS101 applicability has been extended to 150 kHz.
- CS114 applicability has been recinded to 200 MHz.
- CS116 measurement procedures have been revised.
- RE101 requirement at 50 cm has been deleted.
- An alternate RS101 test using the Helmholtz coil has been added.
- RS103 added the use of a mode-tuned reverberation chamber above 200 MHz.
- Position of sensor during RS103 testing must be a minimum of 30 cm above ground plane.
- Some applicability designations for equipment installation location are changed.
- Military operating envelopes were modified for CS114, RE102, and RS101 tests.

A detailed listing of the changes incorporated into MIL-STD-461E is included in Appendix A. The source of the listing is Mr. John Zentner, Chairman of the Government/Industry MIL-STD-461/462 Working Group, from the U.S. Air Force, Wright Patterson Air Force Base, Ohio. The changes and additions included in MIL-STD-461E have no significant impact on the applicability of the MIL-STD test criteria and test methods to the NPP environment. They actually improve the functionality of the tests and should prove useful for the nuclear industry. Many of the MIL-STD-461D test criteria and MIL-STD-462D test methods remain totally intact. Hence, the ORNL staff recommend that MIL-STD-461E be endorsed as the most recently available information from the military services. Subsequently, the ensuing comparison of the MIL-STD and IEC tests will be based on the MIL-STD-461E test methods.

## 4. OVERVIEW OF IEC 61000 TESTS AND ASSESSMENT APPROACH

### 4.1 IEC 61000 Emissions Test Methods

The IEC 61000 test method deemed most useful for evaluating emissions (conducted and radiated) emanating from equipment is IEC 61000-6-4, *Electromagnetic Compatibility (EMC)—Emission Standard for Industrial Environments*.<sup>11</sup> The standard was prepared by the International Special Committee on Radio Interference (CISPR) and adopted by CENELEC, the European electromagnetic compatibility (EMC) body responsible for developing EMI/RFI standards to enforce the European Union EMC Directive. IEC 61000-6-4 is a generic standard and references product-family standards like CISPR 11, *Industrial, Scientific, and Medical (ISM) Radio-frequency Equipment—Electromagnetic Disturbance Characteristics—Limits and Methods of Measurement*,<sup>12</sup> CISPR-14-1, *Requirements for Household Appliances, Electric Tools and Similar Apparatus*,<sup>13</sup> CISPR 15, *Limits and Methods of Measurement of Radio Disturbance Characteristics of Electrical Lighting and Similar Equipment*,<sup>14</sup> and CISPR 22, *Information Technology Equipment—Radio Disturbance Characteristics—Limits and Methods of Measurement*.<sup>15</sup> IEC 61000-6-4 is deemed appropriate when a product-family standard does not exist for a particular application. It outlines generic test limits and calls out the test methods in CISPR 11.

### 4.2 IEC 61000 Immunity Test Methods

The IEC 61000-4 series of immunity standards, *Electromagnetic Compatibility—Testing and Measurement Techniques*, consists of 21 generic test methods developed to address upsets and malfunctions in electrical and electronic devices. A listing of the IEC 61000-4 test methods relevant for comparison with the MIL-STD test methods is shown in Table 4.1. IEC 61000-4-1<sup>16</sup> provides an overview of the individual immunity tests. IEC 61000-4-2<sup>17</sup> covers test methods for ensuring electrostatic discharge immunity (not an area of interest for this particular assessment). IEC 61000-4-3<sup>18</sup> covers test methods for evaluating the immunity of equipment to radiated electric fields in the radio-frequency range. The next two test methods are employed to evaluate the susceptibility of equipment to power surges and cover EFT/B (IEC 61000-4-4)<sup>19</sup> and switching and lightning transients (IEC 61000-4-5).<sup>20</sup> IEC 61000-4-6<sup>21</sup> covers test methods to prevent conducted EMI/RFI from coupling into equipment.

**Table 4.1. IEC 61000-4 immunity test methods**

Designation	Description
61000-4-1	Overview of Immunity Tests
61000-4-2	Electrostatic Discharge Immunity Test
61000-4-3	Radiated, Radio-Frequency, Electromagnetic Field Immunity Test
61000-4-4	Electrically Fast Transient/Burst Immunity Test
61000-4-5	Surge Immunity Test
61000-4-6	Immunity to Conducted Disturbances, Induced by Radio-Frequency Fields
61000-4-7	General Guide on Harmonics and Interharmonics Measurements and Instrumentation, for Power Supply Systems and Equipment Connected Thereto
61000-4-8	Power Frequency Magnetic Field Immunity Test
61000-4-9	Pulse Magnetic Field Immunity Test
61000-4-10	Damped Oscillatory Magnetic Field Immunity Test
61000-4-11	Voltage Dips, Short Interruptions, and Voltage Variations Immunity Tests
61000-4-12	Oscillatory Waves Immunity Tests
61000-4-13	Immunity to Harmonics and Interharmonics
61000-4-16	Test for Immunity to Conducted, Common Mode Disturbances in the Frequency Range 0 Hz to 150 kHz

IEC 61000-4-7<sup>22</sup> addresses both harmonics and interharmonics in power supply systems and equipment with a direct connection to them. The next three test methods provide guidance on ensuring immunity from various forms of magnetic fields: IEC 61000-4-8<sup>23</sup> covers magnetic fields at the power frequency,

IEC 61000-4-9<sup>24</sup> covers pulsed magnetic fields, and IEC 61000-4-10<sup>25</sup> covers damped oscillatory magnetic fields. IEC 61000-4-11<sup>26</sup> provides test methods to evaluate the response of equipment to voltage dips, short interruptions, and voltage variations. IEC 61000-4-12,<sup>27</sup> addresses power surges comprising oscillatory waves. IEC 61000-4-13,<sup>28</sup> covers harmonics and interharmonics. IEC 61000-4-16<sup>29</sup> covers conducted common-mode disturbances, such as those originating from power line currents and return leakage currents in the grounding system.

### 4.3 Assessment Approach

The remainder of this document provides detailed comparisons of the MIL-STD and IEC 61000 test methods conducted by the ORNL staff and is based primarily on a review of the actual standards. An additional document was found to be very helpful in conducting the comparisons. It is entitled *Engineering Practice Study: Results of Detailed Comparisons of Individual EMC Requirements and Test Procedures Delineated in Major National and International Commercial Standards with Military Standard MIL-STD-461E*.<sup>30</sup> The document was issued by the DOD on April 6, 2000, as EMCS Project Number 0178 and summarizes the five-year undertaking of the Defense/Industry E3 Standards Committee (DIESC) to harmonize the MIL-STDs and commercial standards. The goal of the committee was to coordinate DOD and industry efforts with regard to the use of military and industry EMI/RFI standards in government procurements. The DIESC was composed of both DOD and industry representatives. The industry participants included representatives from the Society of Automotive Engineers, the American National Standards Institute, IEEE, and the National Electronics Manufacturers Association. The DOD was represented by the Joint Spectrum Center (JSC), the Army, the Navy, and the Air Force. The Defense Threat Reduction Agency and National Aeronautics and Space Administration also participated. The essence of the findings by DIESC is that certain equipment for the military may be procured based on its compliance with commercial standards, but only after a risk assessment has been performed.

## 5. COMPARISON OF EMISSIONS TESTS

### 5.1 Low-Frequency Emissions Tests

Frequency coverage for the low-frequency emissions tests is shown in Fig. 5.1. CE101 is the designation given to the MIL-STD-461E test for low-frequency conducted emissions, and it covers the frequency range of 30 Hz to 10 kHz. The test is applicable to both ac and dc power leads. For ac applications, the test frequencies begin at the second harmonic of the EUT power frequency. The purpose of the MIL-STD-461E CE101 test is to control the effects of conducted emissions specific to the power buses of the platform. In particular, the MIL-STD-461E frequency range was selected because low-frequency interference effects in this range can limit the detection and processing of magnetic anomaly detection (MAD) and acoustic sensor systems. For military assignments, the test is applicable to submarines and aircraft and is not applicable to ground facilities. This is an application change from the discussions in MIL-STD-461C, where performance of the low-frequency conducted emissions test was required for military ground facilities applications. ORNL staff feel that the CE101 test should be retained because of its significance in controlling power quality.

RE101 is the designation given to the MIL-STD-461E test for radiated magnetic fields and covers the frequency range of 30 Hz to 100 kHz. The test is applicable for emissions from equipment and subsystem enclosures, as well as all interconnecting leads. The test does not apply at transmitter fundamental frequencies or to radiation from antennas. The purpose of the MIL-STD-461E RE101 test is to control magnetic fields resulting from the installation of the EUT in locations containing sensitive equipment. The MIL-STD-461E RE101 test is applicable to ships, submarines, and aircraft, but it does not include ground facilities. The need to limit the low-frequency magnetic field emissions is due to the close proximity of electronic and electrical systems installed on military platforms and the essentiality of low-frequency sensors and receiver systems. Guidance for this test in the NPP is

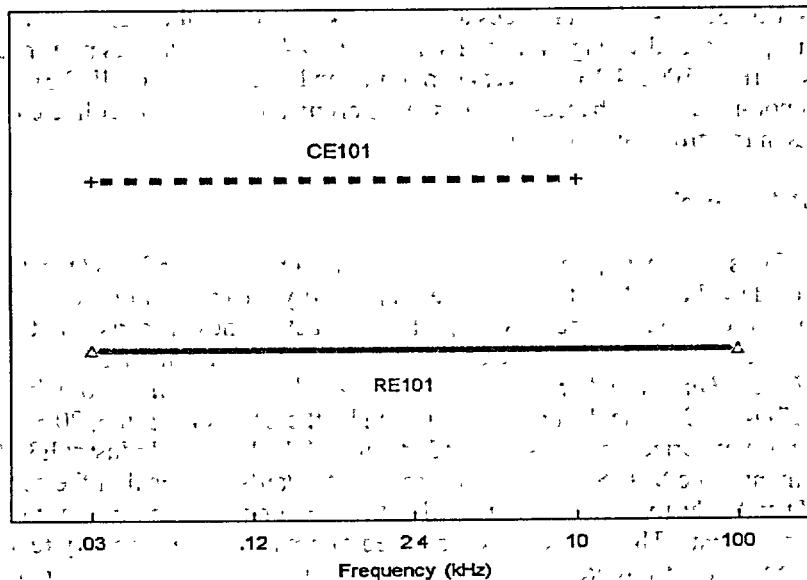

**Fig.5.1. Low-frequency emissions coverage.**

provided to address those cases where equipment may be installed in close proximity to other equipment that may be sensitive to magnetic fields. Equipment not intended to be installed in areas with other equipment sensitive to magnetic fields could be exempt from these tests.

An operating envelope for the MIL-STD-461E CE101 test is shown in Fig. 5 2. It is the same operating envelope as presented in RG 1.180 since there is no new guidance in MIL-STD-461E about ground facilities. An operating envelope comparable to the RG 1.180 operating envelope for the MIL-STD-461E RE101 test is shown in Fig. 5.3. RG 1.180 does not endorse the 50-cm measurement specification in MIL-STD-461D, and it has been dropped in MIL-STD-461E.

The CE101 test is considered optional in RG 1.180, and an exemption is offered if power quality controls are in place at the NPP. The RE101 test is also optional in RG 1.180, and an exemption is offered based on the proximity of scheduled safety-related I&C equipment to other equipment that is sensitive to magnetic fields. It is recommended that both of these exemptions be maintained.

There is no IEC 61000 test comparable to the RE101 test. This is to be expected, considering the military platforms where the RE101 test is applicable. There is typically no requirement in the industrial environment to place equipment items very close to each other, so this type of specification should not be considered critical for NPPs. There is no IEC 61000 test comparable to the CE101 test for the frequency range being covered. IEC 61000-3-2, *Limits for Harmonic Current Emissions (equipment input current  $\leq 16 A$  per phase)*,<sup>31</sup> and IEC 61000-3-4, *Limitation of Emission of Harmonic Currents in Low-voltage Power Supply Systems for Equipment with Rated Current Greater than 16 A*,<sup>32</sup> address power distortions at selected power frequency harmonics, but their frequency coverage is only 120 Hz to 2.4 kHz. This still leaves an uncovered frequency gap between 2.4 kHz and 10 kHz. If the NPP has power quality control, the power distortions of the types that are the subject of IEC 61000-3-2 and IEC 61000-3-4 will already have been addressed as elements of the power quality control procedures. Hence, it is not recommended that these tests be employed to replace the CE101 test.

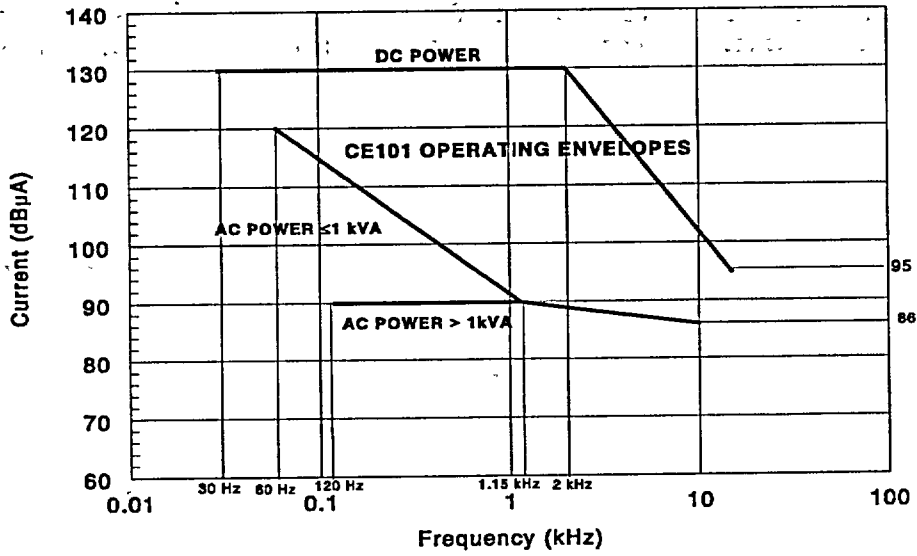

Fig. 5.2. CE101 operating envelope.

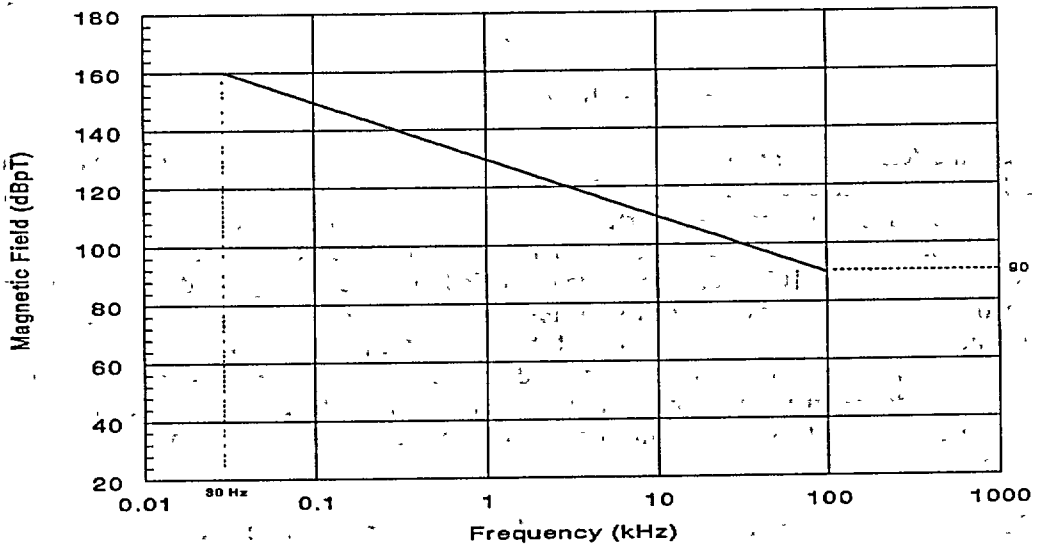

Fig. 5.3. RE101 operating envelope.

## 5.2 High-Frequency Emissions

Frequency coverage for the high-frequency emissions tests found to be relevant for comparison is shown in Fig. 5.4. These include the MIL-STD-461E CE102 and RE102 tests, the Federal Communications Commission (FCC) Part 15 test, and the IEC 61000-6-4 test that employs the CISPR 11 test methods. Both conducted and radiated emissions tests were examined simultaneously, as they tend to complement each other.

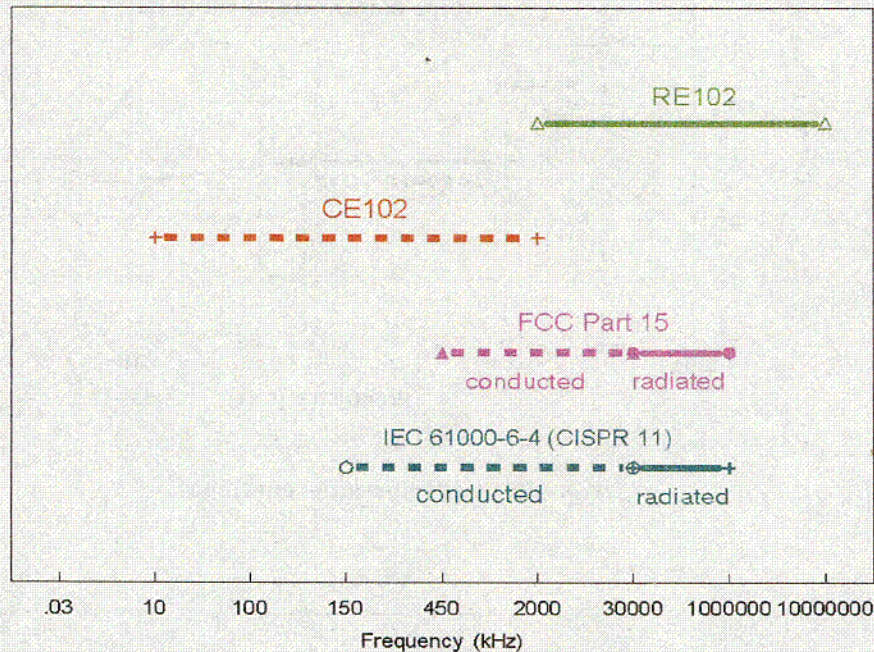

Fig. 5.4. High frequency emissions coverage.

CE102 is the designation given to the MIL-STD-461E test for high-frequency conducted emissions that typically covers the frequency range 10 kHz to 10 MHz. The purpose of the MIL-STD-461E CE102 test is to limit the amount of conducted interference on power leads. The test is applicable to ac and dc power leads, including grounds and neutrals, that obtain power from other sources that are not part of the EUT. The MIL-STD-461E CE102 test is applicable to all platforms, including ground facilities. The rationale for the lower-frequency portion of the CE102 test is to ensure that new equipment being installed does not corrupt the power quality (allowable voltage distortion) on the power buses present on the platform. At higher frequencies, the CE102 test serves as an additional control to the RE102 test on potential radiation from power leads that may couple into sensitive antenna-connected receivers. If antenna-connected receivers are not present on the platform at higher frequencies, the upper frequency of the requirement can be tailored.

RE102 is the designation given to the MIL-STD-461E test for radiated electric fields that typically covers the frequency range of 10 kHz to 1 GHz. The test is applicable to equipment and subsystem enclosures, as well as all interconnecting leads. The test does not apply at transmitter fundamental frequencies or to radiation from antennas. The MIL-STD-461E RE102 test is applicable to all platforms, including ground facilities. Frequency coverage for military ground facilities extends only from 2 MHz to 1 GHz. The basic intent is to protect sensitive receivers from interference coupled through the antennas associated with the receivers.

The CE102 test addresses voltage distortions (power quality) at the low end and extraneous conducted emissions at the high end. The low end of the RE102 frequency coverage (10 kHz to 2 MHz) addresses low-frequency radiated emissions controls related to the CE102 high-frequency conducted emissions controls and is not specified for military ground facilities. The RE102 test coverage for ground facilities in MIL-STD-461E is 2 MHz to 1 GHz. The rationale appears to be that radiated emissions testing is not required below 2 MHz because of presumed power quality control with the complementary application of the CE102 test. Extrapolating from the MIL-STD-461E rationale, the conducted and radiated emissions tests can be paired and the individual frequency ranges set to span the overall frequency range in complementary segments (i.e., CE102 from 10 kHz to 2 MHz and RE102 from 2 MHz to 1 GHz).

Since equipment manufactured in the United States and intended for sale in the United States has to be tested to FCC Part 15, it should also be given consideration. The Class A limits of FCC Part 15 provide conducted and radiated coverage from 450 kHz to 1 GHz. If safety-related I&C equipment has been certified as FCC Class A, it can be assumed that further testing is not needed in this frequency range. It is recommended that an exemption be granted to this effect if equipment has been FCC-tested. Also, it is recommended that an exemption be granted for the frequency range of 10 kHz to 450 kHz if the NPP has power quality control. Otherwise, the CE102 test should be performed from 10 kHz to 450 kHz.

IEC 61000-6-4, *Emission Standard for Industrial Environments*, addresses conducted emissions from 150 kHz to 30 MHz and radiated emissions from 30 MHz to 1 GHz. The test methodology follows the measurement practices described in CISPR 11. Comparisons of the high-frequency radiated test methods are given in Tables 5.1 and 5.2.

**Table 5.1. Comparison of high-frequency conducted emissions test methods**

Parameter	CE102	CISPR 11
Application	ac power leads dc power leads	ac power leads dc power leads
Frequency coverage	10 kHz to 2 MHz	150 kHz to 30 MHz
Methodology:		
Similarities	<ul style="list-style-type: none"> <li>– Measures voltage</li> <li>– Identical detector bandwidth</li> <li>– Power line resonance limitation</li> </ul>	<ul style="list-style-type: none"> <li>– Measures voltage</li> <li>– Identical detector bandwidth</li> <li>– Power line resonance limitation</li> </ul>
Differences	<ul style="list-style-type: none"> <li>– Uses peak detector</li> <li>– EUT sits on ground plane</li> <li>– Set up in normal configuration</li> </ul>	<ul style="list-style-type: none"> <li>– Uses quasi-peak and average detectors</li> <li>– EUT placed 80 cm above ground plane</li> </ul>

**Table 5.2. Comparison of high-frequency radiated emissions test methods**

Parameter	RE102	CISPR 11
Application	Equipment enclosures	Equipment enclosures
Frequency coverage	2 MHz to 2 GHz	30 MHz to 1 GHz
Methodology:		
Similarities	– Measures electric fields	– Measures electric fields
Differences	<ul style="list-style-type: none"> <li>– Rod antenna used from 2 MHz to 30 MHz</li> <li>– Biconical antenna used from 30 MHz to 200 MHz</li> <li>– Horn antenna used from 200 MHz to 1 GHz</li> <li>– Measurements made at 1 m</li> <li>– Measurements made in shielded enclosure</li> </ul>	<ul style="list-style-type: none"> <li>– Dipole antennas used from 30 MHz to 1 GHz</li> <li>– Measurements made at 3 m and 10 m</li> <li>– Measurements made at open area test site</li> </ul>

IEC 61000-3-2 and IEC 61000-3-4 address power distortions at selected power frequency harmonics, but their frequency coverage is only 120 Hz to 2.4 kHz. This still leaves an uncovered frequency gap between 2.4 kHz and 150 kHz. There are no IEC 61000 tests that address emissions in the 2.4-kHz to 150-kHz range. Because voltage distortions are the concern for the conducted emissions controls, the IEC 61000 tests are not sufficient, given the frequency gap, in the absence of power quality control. If the NPP has power quality control, the limits of IEC 61000-6-4 should be completely acceptable for emissions testing. Thus, the IEC option for emissions testing is only acceptable for equipment intended for installation at NPPs employing power quality control. It is recommended that an exemption be granted for the frequency range of 10 kHz to 150 kHz, given that there is power quality control in place. Otherwise, the CE102 test should be performed from 10 kHz to 150 kHz.

The operating envelopes for the CE102 and RE102 tests that are comparable to the operating envelopes in RG 1.180 are shown in Figs. 5.5 and 5.6. The only differences are modifications in the frequency coverage. Overlays of the IEC 61000-6-4 limits are included for comparison. Tables 5.3 and 5.4 show the values for the IEC 61000-6-4 limits.

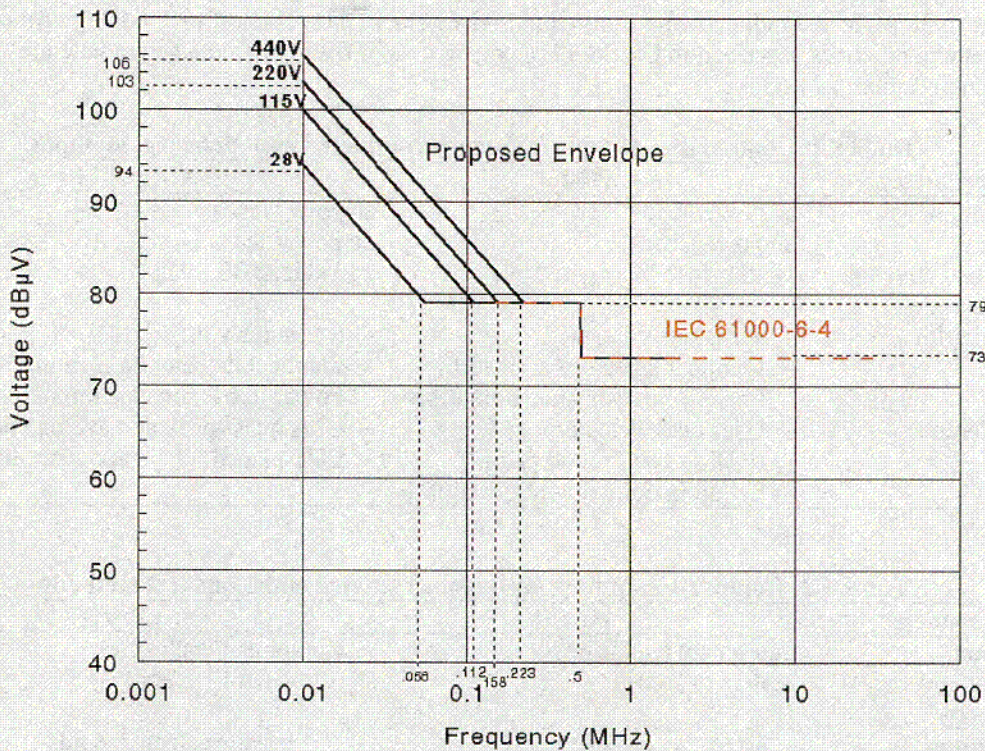

Fig. 5.5. CE102 operating envelope.



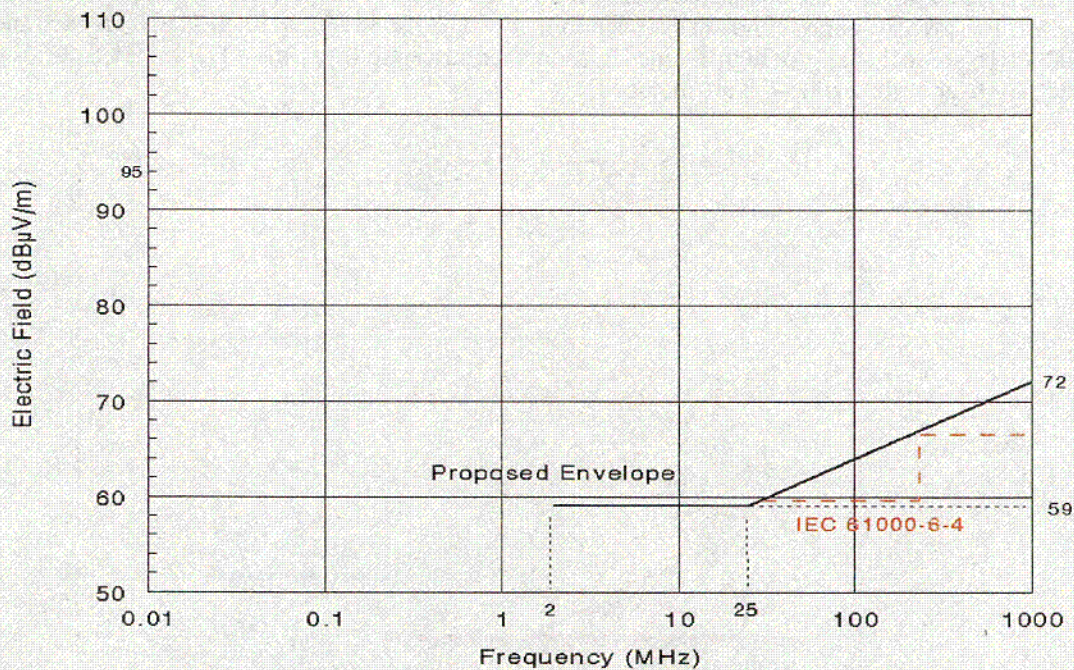

Fig. 5.6. RE102 operating envelope.

Table 5.3. IEC 61000-6-4 conducted emissions limits

Frequency range	Level (dBV)
150 kHz to 500 kHz	79 quasi-peak
	66 average
500 kHz to 5 MHz	73 quasi-peak
	60 average
5 MHz to 30 MHz	73 quasi-peak
	60 average

Table 5.4. IEC 61000-6-4 radiated emissions limits

Frequency range	Level (dBV/m)
30 MHz to 230 MHz	30 quasi-peak, measured at 30 m
230 MHz to 1 GHz	37 quasi-peak, measured at 30 m

## 6. COMPARISON OF CONDUCTED SUSCEPTIBILITY TESTS

Frequency coverage for the conducted susceptibility tests found to be relevant for comparison is shown in Fig. 6.1. For low-frequency conducted susceptibility, MIL-STD-461E CS101, IEC 61000-4-13, and IEC 61000-4-16 are included. For high-frequency conducted susceptibility, MIL-STD-461E CS114, IEC 61000-4-16, and IEC 61000-4-6 are included.

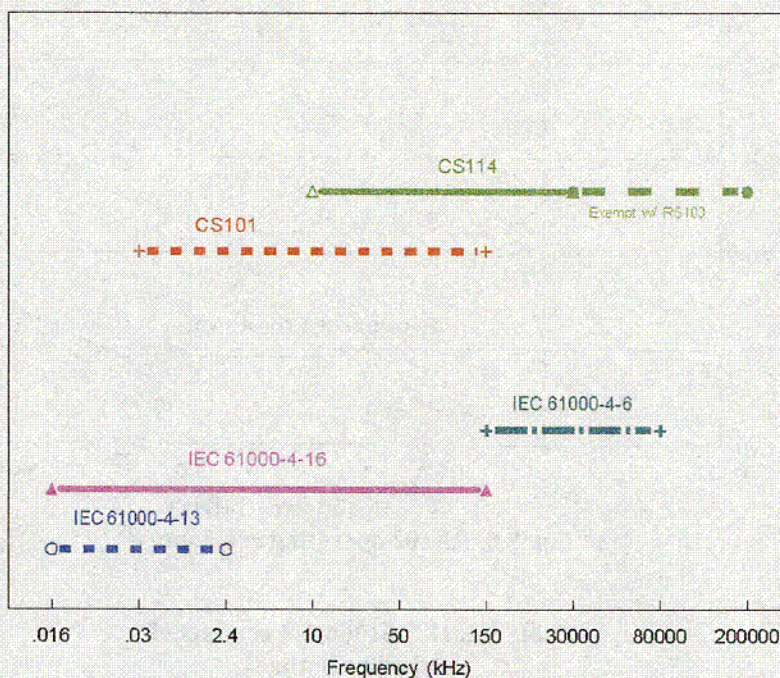

Fig. 6.1. Conducted susceptibility frequency coverage.

### 6.1 Conducted Susceptibility, Low Frequency—CS101 vs IEC 61000-4-13 and -4-16

The purpose of the low-frequency conducted susceptibility tests is to ensure that electrical/electronic equipment connected to low-voltage power mains is not susceptible to spurious frequencies and harmonics and interharmonics of the power frequency. The tests are applicable to both ac and dc input power leads, not including grounds and neutrals. For ac applications, the test frequencies begin at the second harmonic of the power frequency. CS101 is the designation given to the MIL-STD-461E test for low-frequency conducted susceptibility, and its commercial counterparts are IEC 61000-4-13 and IEC 61000-4-16.

The rationale for the MIL-STD-461E CS101 test is to ensure that equipment performance is not degraded from ripple voltages associated with allowable distortion of power source voltage waveforms. The required test signal is applicable on the basis that the concern is to develop a differential voltage across the power leads in the frequency range of 30 Hz to 150 kHz. Common-mode voltage evaluations are addressed by other susceptibility tests such as CS114 and RS103. The CS101 requirements can be tailored to more closely follow a particular power quality standard.

IEC 61000-4-13, *Electromagnetic Compatibility (EMC)—Immunity to Harmonics and Interharmonics*, was developed to assess the performance of covering electrical and electronic equipment when it is

subjected to conducted, differential-mode disturbances (harmonics and interharmonics) on low-voltage power mains. It applies to equipment that draws less than 16 A per phase. It does not apply to equipment operating on dc power. IEC 61000-4-13 divides equipment into three classes—1, 2, and 3—according to the environment in which it is expected to operate. The equipment classes are defined in Table 6.1.

**Table 6.1. IEC 6100-4-13 test classes**

Class	Description
1	Devices expected to operate with protected supplies, such as uninterruptible power supplies, filters, or surge capacitors
2	Devices connected to public networks or operating in a light industrial environment
3	Devices operating in a heavy industrial environment, i.e., an environment where a major part of the load is fed through converters, where welding machines are present, where large motors may be turned on and off frequently, or where loads vary rapidly

IEC 61000-4-16, *Electromagnetic Compatibility (EMC)—Test for Immunity to Conducted, Common Mode Disturbances in the Frequency Range 0 Hz to 150 kHz*, was developed to assess the performance of electrical and electronic equipment when it is subjected to conducted, common-mode disturbances in the frequency range of dc to 150 kHz on power supply, control, signal, and communication lines. It is intended to simulate conducted, common-mode disturbances such as those generated by power electronic equipment and originating from power line currents and return leakage currents in the grounding system. Table 6.2 shows the guidelines for selecting the test levels for specific environments.

**Table 6.2. Guidelines for selecting levels associated with IEC 61000-4-16**

Level	Description
1	<p><b>Well-protected environment.</b> The installation is characterized by the following attributes: (a) separation of the internal power supply network from the mains network, e.g., by dedicated isolation transformers; and (b) electronic equipment earthed to a dedicated earthing collector, connected to the earthing system (ground network) of the installation.</p> <p>A computer room may be representative of this environment.</p>
2	<p><b>Protected environment.</b> The installation is characterized by the following attributes: (a) direct connection to the low-voltage mains network; and (b) electronic equipment earthed to the earthing system of the installation.</p> <p>Control rooms or terminal rooms located in dedicated buildings of industrial plants and power plants may be representative of this environment.</p>
3	<p><b>Typical industrial environment.</b> The installation is characterized by the following attributes: (a) direct connection to the low-voltage or medium-voltage mains network; (b) electronic equipment earthed to the earthing system of the installation (ground network); and (c) use of power converters injecting stray currents into the ground network.</p> <p>Industrial installations and power plants may be representative of this environment.</p>
4	<p><b>Severe industrial environment.</b> The installation is characterized by the following attributes: (a) direct connection to the low-voltage or medium-voltage mains network; (b) electronic equipment connected to the earthing system of the installation (ground network) common to high-voltage equipment and systems; and (c) use of power converters injecting stray currents into the ground network.</p> <p>Open-air high-voltage substations, and the related power plant, may be representative of this environment.</p>
x	Special situations to be analyzed.

A comparison of CS101, IEC 61000-4-13, and IEC 61000-4-16 is shown in Table 6.3. Additional descriptions of how the parameters compare and of the findings from the comparison follow.

**Table 6.3. Comparison of low-frequency conducted susceptibility tests**

Parameter	CS101	IEC 61000-4-13	IEC 61000-4-16
Application	ac and dc power leads	Low-voltage ac power mains	ac and dc power leads
Frequency coverage	30 Hz to 150 kHz	16 Hz to 2.4 kHz	dc to 150 kHz
Methodology:			
Similarities	– Measures differential-mode voltage	– Measures differential-mode voltage	– Measures common-mode voltage
Differences	– Uses coupling transformer – Employs facility line power and LISN to block line noise	– Uses coupling/decoupling network – Uses dedicated power generator	– Uses coupling/decoupling network – Uses dedicated power generator

LISN = line impedance stabilization network.

### 6.1.1 Low-Frequency Conducted Susceptibility—Coverage

The CS101 test covers the continuous frequency range of 30 Hz to 150 kHz. The IEC 61000-4-13 test covers discrete harmonics up to the 40<sup>th</sup> harmonic of the power frequency (120 Hz to 2.4 kHz) and interharmonics from 16 Hz to 2.4 kHz. The IEC 61000-4-16 covers the frequency range of dc to 150 kHz.

### 6.1.2 Low-Frequency Conducted Susceptibility—Methodology

The CS101 test methodology injects the disturbance voltage onto power leads through a coupling transformer with its secondary connected in series (as shown in Fig. 6.2). A line impedance stabilization network (LISN) is placed between the power source and the coupling transformer. The setup is replicated for three-phase circuits, and each phase is then tested in sequence.

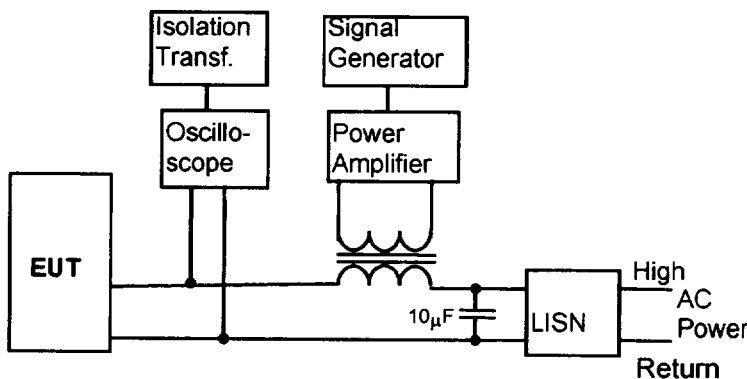

**Fig. 6.2. CS101 signal injection setup.**

The IEC 61000-4-13 and IEC 61000-4-16 tests use a dedicated power generator, which also supplies power to the EUT. The tests also employ miscellaneous test signal generators for the various frequency ranges. For three-phase equipment, all of the IEC 61000-4 tests are performed simultaneously on all three phases.

### 6.1.3 Low-Frequency Conducted Susceptibility—Operating Envelopes

In IEC 61000-4-13, operating envelopes are given only for Class 2 and 3 equipment. There is no operating envelope for Class 1 equipment. The Class 2 operating envelope appears to best suited for comparison to the CS101 operating envelope, since it covers the industrial environment. It is shown in Table 6.4. The IEC 61000-4-16 test levels to be applied at dc and the power line frequency are shown in Tables 6.5 and 6.6. The IEC 61000-4-16 test levels to be applied in the frequency range of 15 Hz to 150 kHz are shown in Table 6.7. Level 3 appears to be the best suited for comparison since it covers the typical industrial environment. A summary of the IEC 61000-4-16 test levels is given in Table 6.8. A comparison of the CS101 operating envelope recommended in RG 1.180 and the IEC 61000-4 operating envelopes is shown in Fig. 6.3.

**Table 6.4. IEC 61000-4-13 operating envelope for 115-V system**

Harmonic no. (n)	Class 2 (% of supply voltage)	Class 2 (voltage level)
2	3	3.5
3	8	9.2
4	1.5	1.7
5	8	9.2
6	n.a.	—
7	6.5	7.5
8	n.a.	—
9	2.5	2.9
10	n.a.	—
11	5	5.8
12	n.a.	—
13	4.5	5.2
15	n.a.	—
17	3	3.5
19	2	2.3
21	n.a.	—
23	2	2.3
25	2	2.3
27	n.a.	—
29	1.5	1.7
31	1.5	1.7
33	n.a.	—
35	1.5	1.7
37	1.5	1.7
39	n.a.	—

**Table 6.5 IEC 61000-4-16 test levels for continuous disturbance (dc and power line frequency)**

Level	Open circuit voltage V (rms)
1	1
2	3
3	10
4	30
x <sup>a</sup>	Special

<sup>a</sup>“x” is an open level. The level can be given in the product specification.

**Table 6.6. IEC 61000-4-16 test levels for short-duration disturbance (dc and power line frequency)**

Level	Open circuit voltage V (rms)
1	10
2	30
3	100
4	300
x <sup>a</sup>	Special

<sup>a</sup>“x” is an open level. The level can be given in the product specification.

**Table 6.7. IEC 61000-4-16 test levels for conducted disturbance, 15 Hz to 150 kHz**

Profile of the test voltage (open-circuit) V (rms)				
Level	15 Hz–150 Hz	150 Hz–1.5 kHz	1.5 kHz–15 kHz	15 kHz–150 kHz
1	1–0.1	0.1	0.1–1	1
2	3–0.3	0.3	0.3–3	3
3	10–1	1	1–10	10
4	30–3	3	3–30	30
x <sup>a</sup>	Special	Special	Special	Special

<sup>a</sup>“x” is an open level. The level can be given in the product specification.

**Table 6.8. Operating envelopes for IEC 61000-4 conducted susceptibility tests**

Disturbance	Selected level	Test level
dc and power line frequency, continuous disturbance	Level 3—typical industrial environment	10 Vrms
dc and power line frequency, short-duration disturbance	Level 3—typical industrial environment	100 Vrms
Conducted disturbance, 15 Hz to 150 kHz	Level 3—typical industrial environment	3–0.3 Vrms (15–150 Hz) 1 Vrms (150–1.5 kHz) 1–10 Vrms (1.5–15 kHz) 10 Vrms (15–150 kHz)

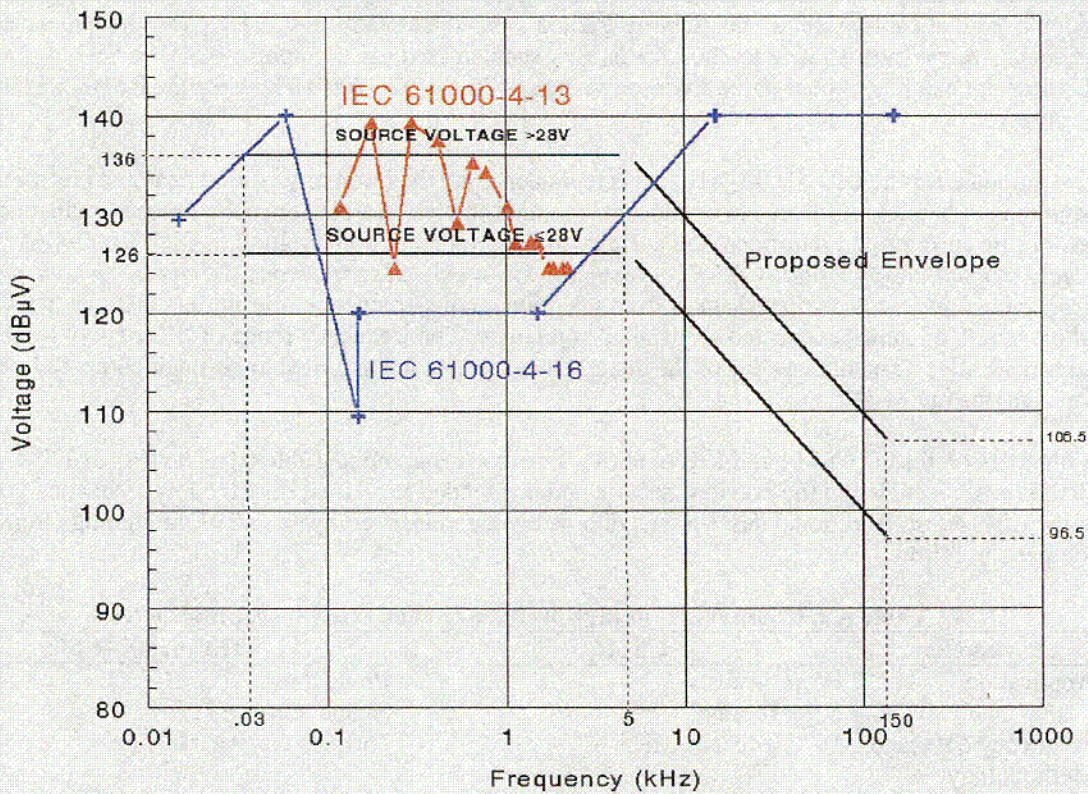

Fig. 6.3. Low-frequency susceptibility operating envelopes.

#### 6.1.4 Low-Frequency Conducted Susceptibility—Findings

The IEC 61000-4-13 and 61000-4-16 tests easily address the desired phenomena from the entire MIL-STD-461E CS101 test. Both differential and common mode disturbances are covered.

IEC 61000-4-13 and IEC 61000-4-16 uses a dedicated generator, which also supplies power to the EUT, whereas CS101 powers its EUT through an LISN. For three-phase equipment, all of the IEC 61000-4 tests are performed simultaneously on all three phases; this is in contrast with CS101 tests, in which the test signal is injected one phase at a time.

It is recommended that the IEC 61000-4-13 and IEC 61000-4-16 tests be accepted as a complementary test set to the MIL-STD-461E CS101 test.

#### 6.2 Conducted Susceptibility, High Frequency—CS114 vs IEC 61000-4-16 and -4-6

The purpose of the high-frequency conducted susceptibility tests is to simulate the currents that will be developed on equipment leads as a result of EMI/RFI generated by antenna transmissions. The tests are applicable to all interconnecting leads, including power leads of the EUT. CS114 is the designation given to the MIL-STD-461E test for high-frequency conducted susceptibility, and its commercial counterparts are IEC 61000-4-16 and IEC 61000-4-6.

The rationale for the MIL-STD-461E CS114 test is to simulate currents that will be developed on platform cabling from electromagnetic fields generated by antennas both on and off the platform. Because

of size constraints and available field patterns during radiated susceptibility testing, it has long been recognized that cabling cannot be properly excited to simulate platform effects at lower frequencies. The frequency range from 10 kHz to 200 MHz is now standardized for all applications. The CS114 requirement can be optional in the frequency range of 30 MHz to 200 MHz when the RS103 test is also performed.

The rationale for the IEC 61000-4-16 test is to demonstrate the immunity of electrical and electronic equipment when it is subjected to conducted, common-mode disturbances such as those originating from power line currents and return leakage currents in the grounding system. In turn, IEC 61000-4-6, *Electromagnetic Compatibility (EMC)—Immunity to Conducted Disturbances, Induced by Radio-Frequency Fields*, covers disturbances from intentional radio frequency transmitters that may act on the whole length of cables connected to installed equipment. The frequency range of IEC 61000-4-6 is 150 kHz to 80 MHz. The dimensions of the disturbed equipment are assumed to be small compared with the wavelengths involved.

A comparison for the CS114 and IEC 61000-4-6 methods is given in Table 6.9. The IEC 61000-4-16 method was discussed in the previous section and is intended to address only the low-frequency portion of the CS114 test. Additional descriptions of how the parameters compare and of the findings from the comparison follow.

**Table 6.9. Comparison of high-frequency conducted susceptibility tests**

Parameter	CS114	IEC 61000-4-6
Application	Power leads Signal leads	Power leads Signal leads
Frequency coverage	10 kHz to 200 MHz	150 kHz to 80 MHz
Methodology:		
Similarities	– Current induced into 100- $\Omega$ impedance	– Current induced into 100- $\Omega$ impedance
Differences	– Uses inductive injection probe – Monitors current – Utilizes square wave modulation – Cable length required to be similar to actual installation	– Injection through coupling and decoupling network – Injection through capacitive coupling clamp – Injection through current clamp – No current monitoring – Utilizes sinusoidal amplitude modulation – Specifies short cables
Operating envelopes	See Fig. 6.6	Class 3—140 dB $\mu$ V—power lead Class 3—134 dB $\mu$ V—signal lead See Fig. 6.6 for comparison

### 6.2.1 High-Frequency Conducted Susceptibility—Coverage

The CS114 test covers a frequency range of 10 kHz to 200 MHz. Equipment tested under the RS103 test may be exempted from application of this test in the frequency range of 30 MHz to 200 MHz. The IEC 61000-4-6 test covers the frequency range of 150 kHz to 80 MHz.

### 6.2.2 High-Frequency Conducted Susceptibility—Methodology

The IEC 61000-4-6 test uses three methods of injecting signals. The primary technique uses coupling and decoupling networks (CDNs) for injecting test signals and isolating auxiliary equipment. A diagram of a typical CDN is shown in Fig. 6.4. The second technique is a variation of the CDN approach—shielded



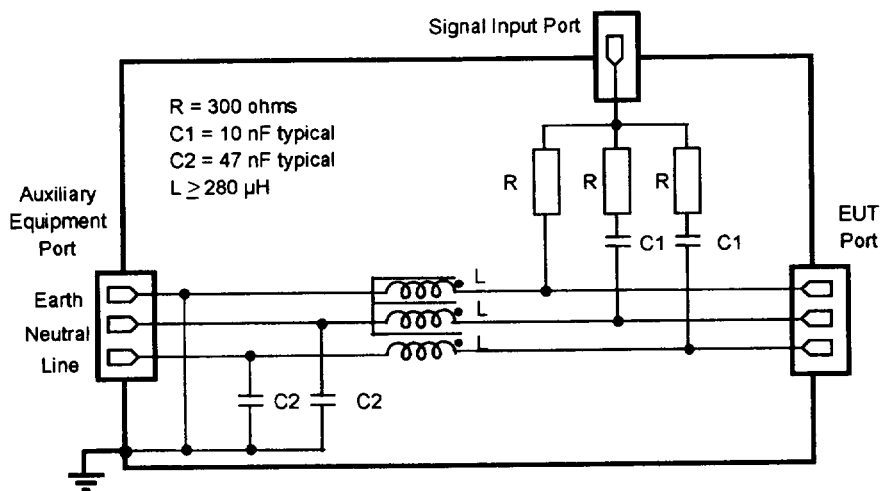
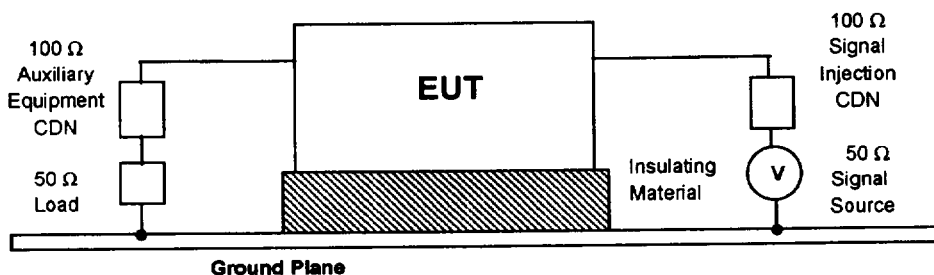

**Fig. 6.4. IEC 61000-4-6 coupling and decoupling network.**

cables are driven by direct injection on the shield with the decoupling network still in place. The third technique, bulk cable injection, uses an electromagnetic clamp.

The basic injection technique used by IEC 61000-4-6 is shown in Fig. 6.4. Cable interfaces are referenced to the ground plane through CDNs. The intent is to establish a 150-Ω impedance to the ground plane. IEC 61000-4-6 uses 1-kHz, 80%-amplitude modulation.

As shown in Fig. 6.5, the chassis of the EUT is electrically isolated from the ground plane. The arrangement is appropriate for commercial applications where there are no significant ground planes present. However, this arrangement is contrary to the general concepts used in MIL-STD-461E, where electronics enclosures are electrically bonded to the ground plane. The MIL-STD-461E arrangement simulates the installation in most military systems. The ground plane can play a role in the path of current flow, effectiveness of filters, and subsequent response of equipment.



**Fig. 6.5. IEC 61000-4-6 signal injection setup.**

The CS114 test setup drives signals onto cables through an inductive injection probe. Current is monitored as a 1-kHz square wave modulation signal is injected. The CS114 test's modulation tends to be more severe because it encompasses the basic aspects of amplitude modulation with the addition of a faster rise time and greater sidebands.

### 6.2.3 High-Frequency Conducted Susceptibility—Operating Envelopes

Test levels for the IEC 61000-4-6 test are shown in Table 6.10. The appropriate test level is selected in accordance with the intended environment. Table 6.11 shows three classes that provide general guidelines for the selection of the test level to be used for a particular location. The Class 3 test level for IEC 61000-4-6 appears to be best suited for comparison with the CS114 operating envelope recommended in RG 1.180, as it covers a typical industrial environment. The 140-dB $\mu$ V level shown in Table 6.10 appears to be suitable as an operating envelope for power leads and can be relaxed by ½ (6 dB) for signal leads.

**Table 6.10. IEC 61000-4-6 test levels**

Test level	Voltage level (dB $\mu$ V)
1	120
2	130
3	140
x <sup>a</sup>	Special

<sup>a</sup>X is an open level.

**Table 6.11. IEC 61000-4-6 test classes**

Class	Description
1	<b>Low-level electromagnetic radiation environment.</b> Levels typical of radio/television stations located at a distance of more than 1 km, and of low-power transceivers.
2	<b>Moderate electromagnetic radiation environment.</b> Low-power portable transceivers (typically less than 1-W rating) are in use, but with restrictions on use in close proximity to the equipment. A typical commercial environment.
3	<b>Severe electromagnetic radiation environment.</b> Portable transceivers (2-W and more) are in use relatively close to the equipment but at a distance of not less than 1 m. High-powered broadcast transmitters are in close proximity to the equipment, and industrial, scientific, medical equipment may be located close by. A typical industrial environment.
X	X is an open level that may be negotiated and specified in the dedicated equipment specifications or equipment standards.

A comparison of the operating envelopes is shown in Fig. 6.6. The IEC 61000-4-6 operating envelopes are converted from voltage units (dB $\mu$ V) to current units (dB $\mu$ A) for the comparison. Note that the 140-dB $\mu$ V level for IEC 61000-4-6 test converts to 97 dB $\mu$ A (i.e., the coupler impedance is 150  $\Omega$ ). The starting point for the CS114 operating envelope was the guidance for Army ground facilities (Curve #4). Upward adjustments were made to maintain the recognized 8-dB margin above plant EMI data levels.

### 6.2.4 High-Frequency Conducted Susceptibility—Findings

IEC 61000-4-6 addresses the currents generated by the coupling of radiated electromagnetic fields onto cabling and has similar high-frequency coverage to the MIL-STD-461E CS114 test if the RS103 exemption is invoked. The low-frequency portion of the CS114 frequency range is addressed by IEC 61000-4-16.

IEC 61000-4-6 uses 1-kHz, 80%-amplitude modulation, while CS114 uses 1-kHz square wave modulation. Square wave modulation tends to be considered more severe because of its faster rise time and greater sidebands.

The IEC 61000-4-6 test setup uses the ground plane only for grounding instrumentation and does not electrically bond the EUT enclosure to the ground plane, as is the case for the CS114 setup.

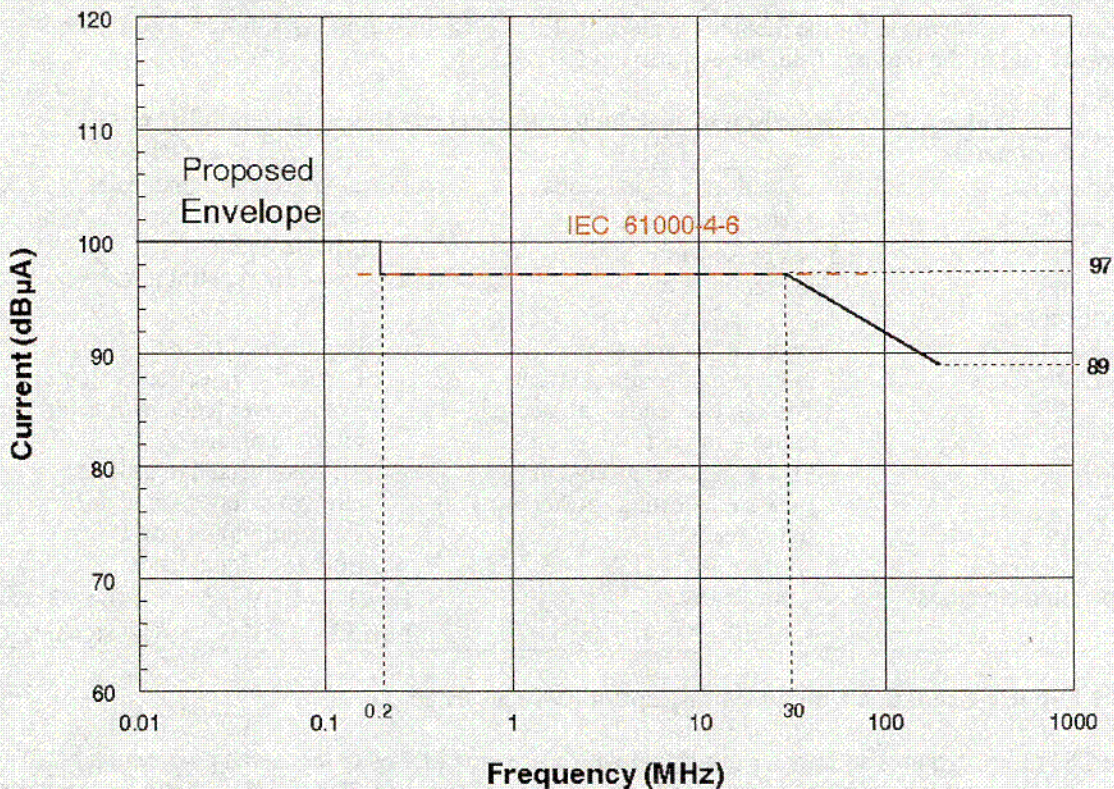

Fig. 6.6. High-frequency conducted susceptibility operating envelopes.

There are some minor differences, but it is recommended that the EC 61000-4 tests be accepted as a complementary test set to the MIL-STD-461E CS114 test, and that the mentioned exemptions be applied when employing the MIL-STD-461E tests.

### 6.3 Conducted Susceptibility, Impulse Excitation—CS115 vs IEC 61000-4-4

The purpose of the impulse-excitation conducted susceptibility tests is to evaluate the ability of the EUT to withstand impulse signals representing fast transients coupled onto the EUT through associated interconnecting cables. The objective of these tests is to protect equipment from fast rise- and fall-time transients that may be present because of internal and external switching functions. The impact of these switching functions on the surrounding environment is the generation of electromagnetic disturbances that could assault equipment directly and indirectly. Direct effects of these disturbances can occur through coupling into internal circuitry, coupling through the ac/dc power source, or equipment enclosure. Indirect effects can occur through coupling into signal and power leads. Internal switching transients usually result from switching inductive loads and relay chattering, whereas the main external switching disturbance is lightning. CS115 is the designation given to the MIL-STD-461E test for impulse excitations, and its commercial counterpart is IEC 61000-4-4.

IEC 61000-4-4, *Electromagnetic Compatibility (EMC)—Electrical Fast Transient/Burst Immunity Test*, assesses the performance of electrical and electronic equipment when it is subjected to a repetitive EFT/B on supply, control, and signal leads. It was developed to demonstrate the immunity of equipment and

systems when subjected to fast transient disturbances, such as those originating from switching inductive loads and relay contact bounce.

A summary comparison for the methods is given in Table 6.12. Descriptions of how the parameters compare and of the findings from the comparison follow.

**Table 6.12. Comparison of switching-transients conducted susceptibility tests**

Parameter	CS115	IEC 61000-4-4
Application	Power leads and signal leads	Power leads and signal leads
Criterion	<ul style="list-style-type: none"> <li>≤ 2 ns rise time</li> <li>≥ 30 ns pulse width</li> <li>30 Hz repetition rate</li> </ul>	<ul style="list-style-type: none"> <li>5-ns rise time</li> <li>50-ns pulse width</li> <li>2.5- to 5-kHz repetition rate</li> </ul>
Methodology:		
Similarities	– Impulse test signal	– Impulse test signal
Differences	<ul style="list-style-type: none"> <li>– Inductive injection (current)</li> <li>– Tests power leads with neutral/return removed</li> <li>– EUT bonded to ground plane</li> <li>– Bulk cable testing (power and signal leads)</li> </ul>	<ul style="list-style-type: none"> <li>– Capacitive injection (voltage)</li> <li>– Tests power leads with neutral/return in place</li> <li>– EUT connected to ground through safety ground wire</li> <li>– Tests individual power leads</li> <li>– Bulk test signal leads</li> </ul>
Operating envelopes	<ul style="list-style-type: none"> <li>5 A—power leads</li> <li>2.5 A—signal leads</li> </ul>	<ul style="list-style-type: none"> <li>Level 3—2 kV (~5.6 A)—power leads</li> <li>Level 3—1 kV (~2.8 A)—signal leads</li> </ul>

### 6.3.1 Impulse-Excitation Conducted Susceptibility—Coverage

The CS115 test requires an impulse test signal with a rise time of 2 ns or less and a pulse width of 30 ns or more. The impulse signal is to be applied at a 30-Hz repetition rate. The IEC 61000-4-4 test requires a test signal with a 5-ns rise time and a 50-ns pulse width. Its repetition rate can vary from 2.5 kHz to 5 kHz. Both tests require application for at least 1 min.

### 6.3.2 Impulse-Excitation Conducted Susceptibility—Methodology

The CS115 test drives an impulse signal onto both power cables and interconnecting signal and control cables using an inductive injection (current) probe. The CS115 test requires that power cables be tested with the neutral/return removed. The IEC 61000-4-4 test injects a signal onto individual power leads through a capacitor and onto interconnecting signal and control cables with a capacitive injection clamp. It is not required that power cables be tested with the neutral/return removed during the IEC 61000-4-4 test.

The CS115 test requires a 50-Ω signal source producing the trapezoidal pulse shown in Fig. 6.7. For power leads, the CS115 test uses LISNs for standardization of the power line impedance. The IEC 61000-4-4 test requires a signal source producing the double exponential pulse shown in Figs. 6.8 and 6.9. Conceptual illustrations of the capacitive coupling clamp and CDN used in the IEC 61000-4-4 test are shown in Figs. 6.10 and 6.11. Also, the IEC 61000-4-4 test setup uses the ground plane only for grounding instrumentation and does not electrically bond the EUT enclosure to the ground plane. In the case of the CS115 test, EUT enclosures are usually bonded to the ground plane to simulate platform installations.

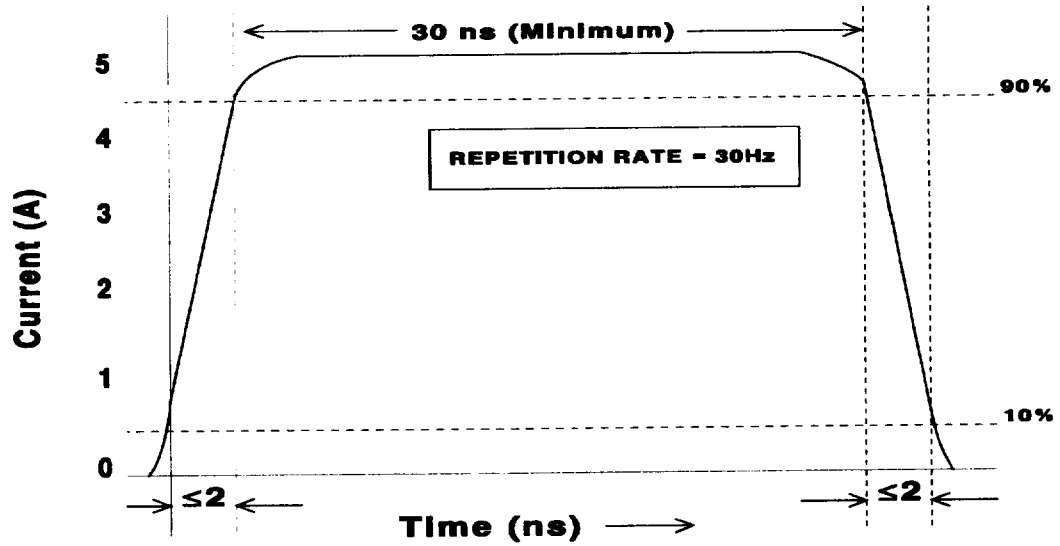

Fig. 6.7. CS115 test signal.

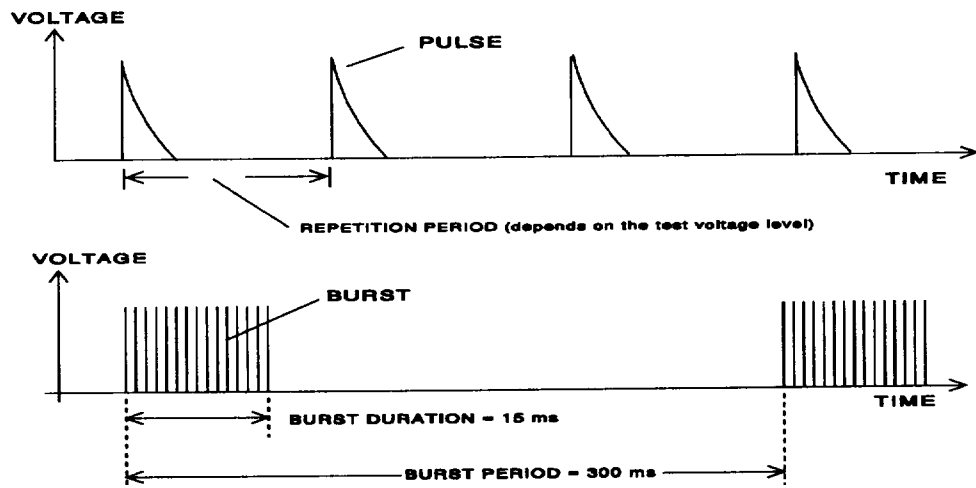

Fig. 6.8. IEC 6100-4-4 electrically fast transients/bursts.

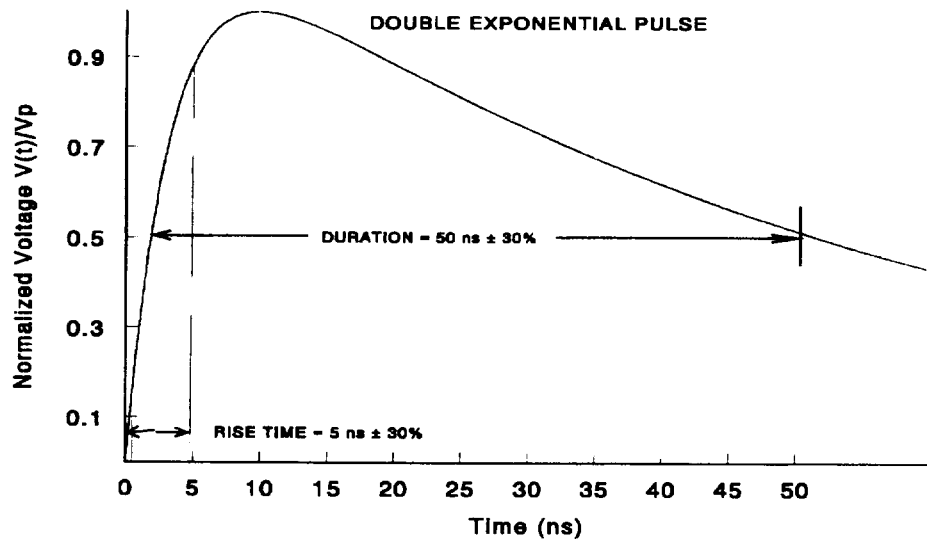

Fig. 6.9. Waveform of fast transient.

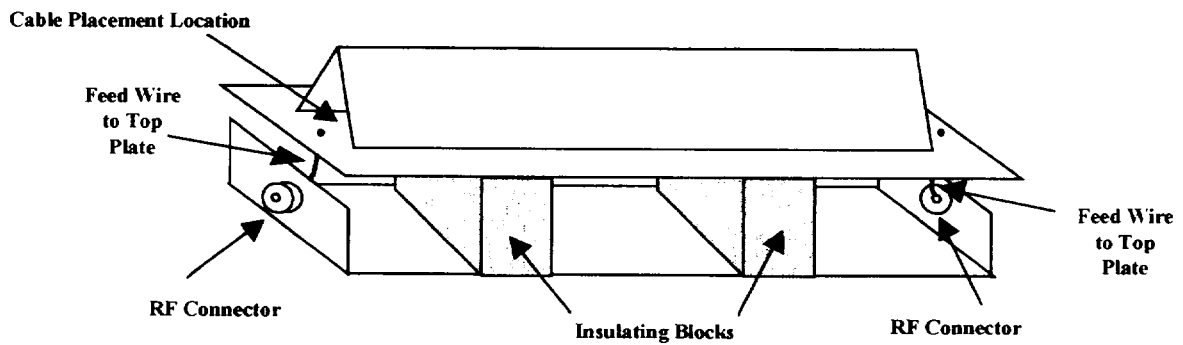

Fig. 6.10. IEC 61000-4-4 capacitive injection clamp.

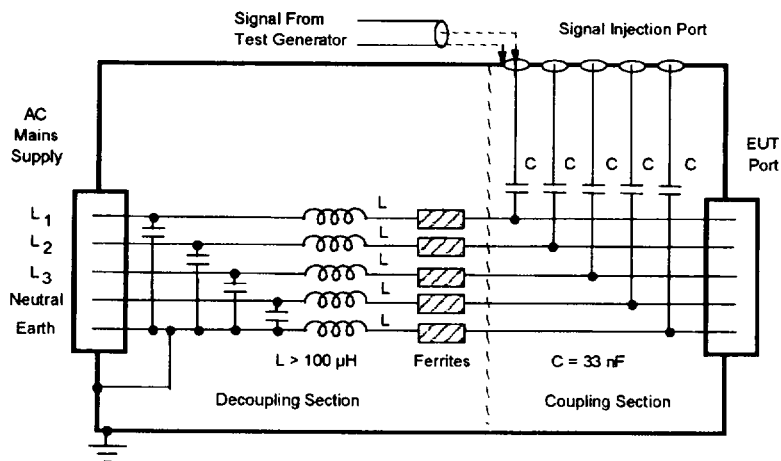

Fig. 6.11. IEC 61000-4-4 coupling/decoupling network.

### 6.3.3 Impulse-Excitation Conducted Susceptibility—Operating Envelopes

The EN 61000-4-4 test classes are based on the installation environment and correspond to specific withstand levels (envelopes). Five classes of installation environments are identified: *well-protected environment*, *protected environment*, *typical industrial environment*, *severe industrial environment*, and *special environment*. Table 6.13 lists the different classes and the corresponding explanations to be used as a guide in selecting the appropriate withstand level. The withstand levels are listed in Table 6.14.

**Table 6.13. IEC 61000-4-4 test classes**

Class	Description
1	<b>Well-protected environment.</b> The installation is characterized by the following attributes: (a) suppression of all EFT/B in the switched power supply and control circuits; (b) separation between power supply leads (ac and dc) and control and measurement circuits originating from other environments belonging to higher severity levels; and (c) shielded power supply cables with the shields connected to ground at both ends on the referenced ground of the installation, and power supply protection by filtering.
2	<b>Protected environment.</b> The installation is characterized by the following attributes: (a) partial suppression of EFT/B in the power supply and control circuits, which are switched only by relays (no contactors); (b) separation of all the circuits from other circuits associated with environments of higher severity levels; and (c) physical separation of unshielded power supply and control cables from signal and communication cables.
3	<b>Typical industrial environment.</b> The installation is characterized by the following attributes: (a) no suppression of EFT/B in the power supply and control circuits, which are switched only by relays (no contactors); (b) poor separation of the circuits from other circuits associated with environments of higher severity levels; (c) dedicated cables for power supply, control, signal, and communication leads; and (d) availability of a grounding system represented by conductive pipes, ground conductors in the cable trays (connected to protective ground system), and a ground mesh.
4	<b>Severe industrial environment.</b> The installation is characterized by the following attributes: (a) no suppression of EFT/B in the power supply and control and power circuits, which are switched by relays and contactors; (b) no separation of the industrial circuits from other circuits associated with environments of higher severity levels; (c) no separation between power supply, control, signal, and communication cables; and (d) use of multicore cables in common for control and signal leads.
X	Special situations to be analyzed.

**Table 6.14. IEC 61000-4-4 test levels**

Level	Power supply ports		Signal, data, and control ports	
	Voltage (kV)	Rep rate (kHz)	Voltage (kV)	Rep rate (kHz)
1	0.5	5	0.25	5
2	1	5	0.5	5
3	2	5	1	5
4	3	2.5	2	5
X	Special	Special	Special	Special

The CS115 operating envelope recommended in RG 1.180 is 5 A for power leads. The corresponding envelope recommended in NUREG/CR-5609 for signal leads is 2.5 A. The current level is generated in a test fixture corresponding to 500 V being developed across a 100- $\Omega$  loop impedance. Level 3 of IEC 61000-4-4 applies to a typical industrial environment. The corresponding withstand levels are 2 kV for power leads and 1 kV for signal leads. Converting these levels into current units yields operating envelopes of 5.6 A for power leads and 2.8 A for signal leads, respectively.

### **6.3.4 Impulse-Excitation Conducted Susceptibility—Findings**

The CS115 test uses an inductive injection probe for power leads, while the IEC 61000-4-4 test uses a capacitive injection clamp. For signal leads, the CS115 test again uses an inductive injection probe; the IEC 61000-4-4 test uses a CDN and injects a signal onto individual power leads through a capacitor. The CS115 test requires that power cables be tested with the neutral/return removed. It is not required that power cables be tested with the neutral/return removed during the IEC 61000-4-4 test.

The CS115 test requires, as the test signal, a fast trapezoidal pulse with a somewhat slow repetition rate. The IEC 61000-4-4 test requires a slightly slower double exponential pulse, with a faster repetition rate, as the test signal. It should be expected that the CS115 test will tend to excite more resonant frequencies because of the higher-frequency content of the test signal.

The IEC 61000-4-4 test setup uses the ground plane only for grounding instrumentation and does not electrically bond the EUT enclosure to the ground plane. The CS115 test requires that EUT enclosures be bonded to the ground plane to simulate platform installations.

While the methodologies for the two tests are substantially different, the applicable test levels for both are similar. When the units are converted, the 2-kV level for power leads for the IEC 61000-4-4 test corresponds to a 5.6-A test level. This is very close to the 5-A level specified for the CS115 test. The same is true for the signal-lead levels.

### **6.4 Conducted Susceptibility, Damped Sinusoid—CS116 vs IEC 61000-4-12**

The purpose of the damped-sinusoid conducted susceptibility tests is to evaluate the ability of the EUT to withstand damped sinusoidal transients coupled onto the associated interconnecting cables. The objective of these tests is to ensure the protection of equipment against external electromagnetic disturbances that can cause transients in the form of damped sinusoids, such as lightning and switching transients. CS116 is the designation given to the MIL-STD-461E test for damped sinusoidal transients, and its commercial counterpart is IEC 61000-4-12.

IEC 61000-4-12, *Electromagnetic Compatibility (EMC)—Oscillatory Waves Immunity Test*, was developed to assess the performance of electrical and electronic equipment when it is subjected to oscillatory waves occurring on power, control, and signal leads. The oscillatory waves are represented by bursts of repetitive damped oscillatory transients.

A summary comparison for the test methods is given in Table 6.15. Descriptions of how the parameters compare and of the findings from the comparison follow.

#### **6.4.1 Damped-Sinusoid Conducted Susceptibility—Coverage**

The CS116 test is expected to demonstrate compliance in the frequency range of 10 kHz to 100 MHz, in incremental steps (e.g., 0.01, 0.1, 1, 10, 30, and 100 MHz). The IEC 61000-4-12 test covers only the frequencies of 100 kHz and 1 MHz.

#### **6.4.2 Damped-Sinusoid Conducted Susceptibility—Methodology**

The test signal waveform for the CS116 test is shown in Fig. 6.12. A current injection probe is used to couple the test signal onto the interconnecting cables of the EUT. A transient generator is used to produce the test signal waveform and is calibrated on a known load using a 100- $\Omega$  calibration fixture. The injection is performed at either the calibration setting or the operating envelope level, depending on the impedance of the cable being tested. The power integrity is maintained by using LISNs.



**Table 6.15. Comparison of damped-sinusoid conducted susceptibility tests**

Parameter	CS116	IEC 61000-4-12
Application	Power leads and signal leads	Power leads and signal leads
Criterion	Oscillatory frequency range from 10 kHz to 100 MHz 15±5 damping factor	75-ns rise time 400-Hz repetition rate Burst duration > 2 ns
Methodology:		
Similarities	– Uses generator with 200-Ω internal impedance	– Uses generator with 200-Ω internal impedance
Differences	– Series injection using a current probe – Common mode coupling	– Parallel injection using a coupling and decoupling network – Common and differential mode coupling
Operating envelopes	See Fig. 6.14	Level 3—2 kV (~10 A)—power leads Level 3—1 kV (~5 A)—signal leads

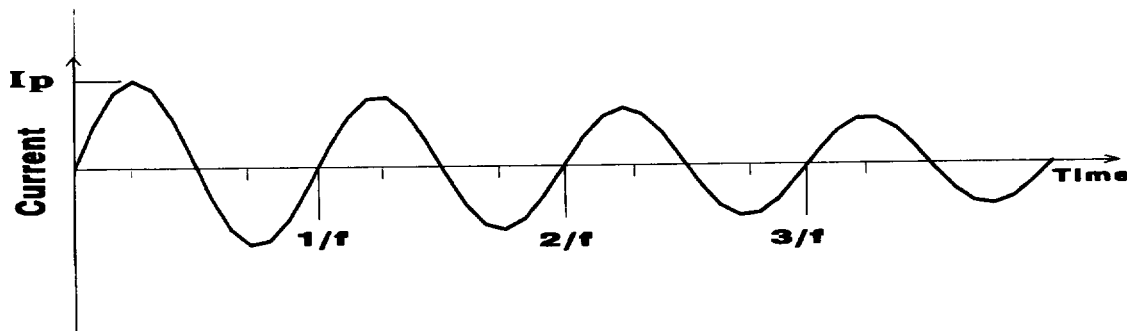

Notes: Normalized waveform:  $e^{-(\pi ft)Q} \sin(2\pi ft)$   
 where:  
 f = test frequency (Hz)  
 t = time (sec)  
 Q = damping factor,  $15 \pm 5$

Damping factor (Q) shall be determined as follows:

$$Q = \pi(N-1) / \ln(I_P/I_N)$$

where:  
 Q = damping factor  
 N = cycle number (i.e., N = 2, 3, 4, 5, ...)  
 I<sub>P</sub> = peak current at 1<sup>st</sup> cycle  
 I<sub>N</sub> = peak current at N<sup>th</sup> cycle  
 ln = natural log

**Fig. 6.12. Waveform of CS116 test signal.**

The relatively fast rise time, the decaying oscillatory waveform, the high repetition rate, and the duration of the burst are the most significant parameters of the IEC 61000-4-12 damped oscillatory wave test. The damped oscillatory wave has a 75-ns rise time, a 400-Hz repetition rate, and a burst duration of not less than 2 s. Figure 6.13 shows the waveform of the IEC 61000-4-12 damped oscillatory wave. IEC 61000-4-12 requires that a test generator with an internal impedance of 200  $\Omega$  be calibrated by conducting a short-circuit current measurement. Parallel injection is performed, by means of a CDN, to launch the damped oscillatory wave onto the interconnecting cables.

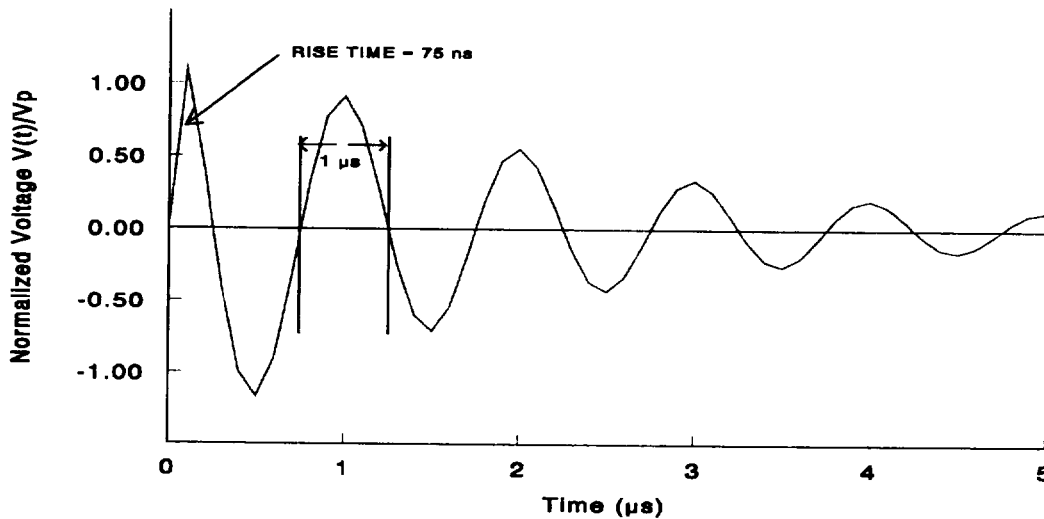

Fig. 6.13. Waveform of the damped oscillatory wave.

#### 6.4.3 Damped-Sinusoid Conducted Susceptibility—Operating Envelopes

The CS116 operating envelope recommended in RG 1.180 for power leads is a maximum of 10 A. The corresponding CS116 operating envelope for signal leads recommended in NUREG/CR-5609 is a maximum of 5 A. Guidelines for selecting the appropriate environment and withstand levels for the IEC 61000-4-12 test are given in Table 6.16 and Table 6.17. Level 3 appears to be the appropriate environment; it has a level of 2 kV. This would correspond to an operating envelope of 10 A when converted into units of current. The guidelines do not differentiate between levels for power and signal leads. However, it would not be prudent to place the same levels on both signal and power leads. So a rule of thumb is to reduce the operating envelope by 1/2 for signal leads. In this case, the power leads would have an operating envelope of 10 A, and the signal leads would have an operating envelope of 5 A. A comparison of the CS116 and IEC 61000-4-12 operating envelopes is shown in Fig. 6.14.

Table 6.16. IEC 61000-4-12 testing guidelines

Class	Description
1	Ports connected to cables running in a limited area of the control building.
2	Ports connected to cables of equipment in the control building and relay house. The equipment concerned is installed in the control building and relay house.
3	Ports connected to cables of equipment installed in the relay house. The equipment concerned is that installed in the relay house.
4	Not applicable to equipment for use in electrical plants, particularly high-voltage substations. Whenever this level seems to be necessary, proper mitigation methods should be adopted.
X	Special situations to be analyzed.

**Table 6.17. IEC 61000-4-12 test levels**

Level	Common mode (kV)
1	0.5
2	1.0
3	2.0
4	—
X <sup>a</sup>	X

<sup>a</sup>X is an open level.

**I<sub>max</sub> = 10 A for power leads**

**I<sub>max</sub> = 5 A for signal leads**

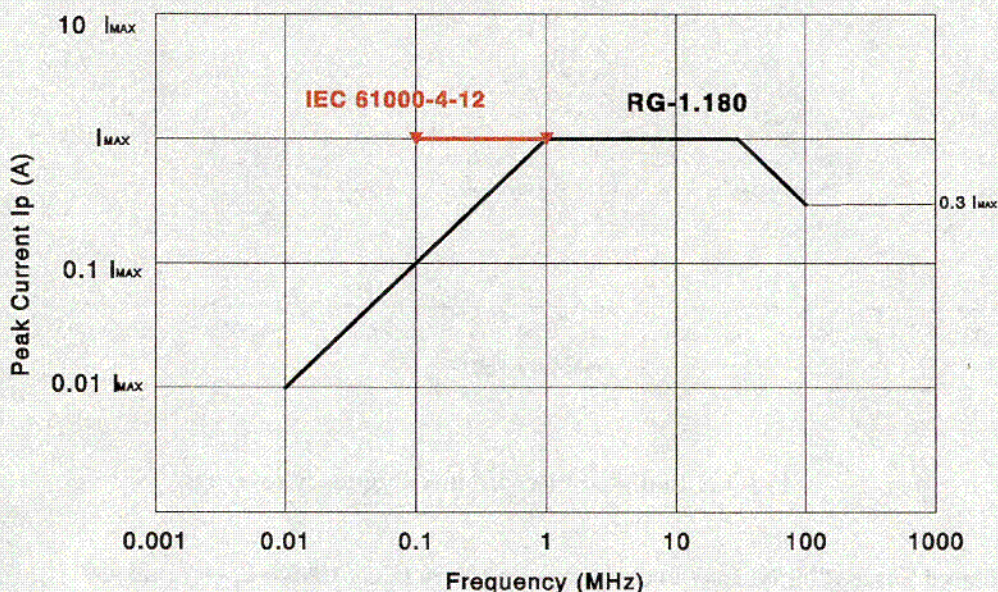

**Fig. 6.14. Damped sinusoid conducted susceptibility operating envelopes.**

#### 6.4.4 Damped-Sinusoid Conducted Susceptibility—Findings

A current injection (series) probe is used to couple the CS116 test signal onto the interconnecting cables of the EUT. Parallel injection is performed in the IEC 61000-4-12 test, by means of a CDN, to launch the damped oscillatory wave onto the interconnecting cables.

A transient generator is used to produce the CS116 test signal waveform and is calibrated on a known load using a 100-Ω calibration fixture. IEC 61000-4-12 that the transient generator be calibrated by conducting a short-circuit current measurement.

The operating envelopes for the CS116 test and IEC 61000-4-12 test are similar in level. The CS116 test has broader frequency coverage.

### 7. COMPARISON OF RADIATED SUSCEPTIBILITY TESTS

Frequency coverage for the radiated susceptibility tests found to be relevant for comparison is shown in Fig. 7.1. For low-frequency radiated susceptibility, MIL-STD-461E RS101, IEC 61000-4-8, IEC 61000-4-9, and IEC 61000-4-10 are included. For high-frequency conducted susceptibility, MIL-STD-461E RS103 and IEC 61000-4-3 are included.

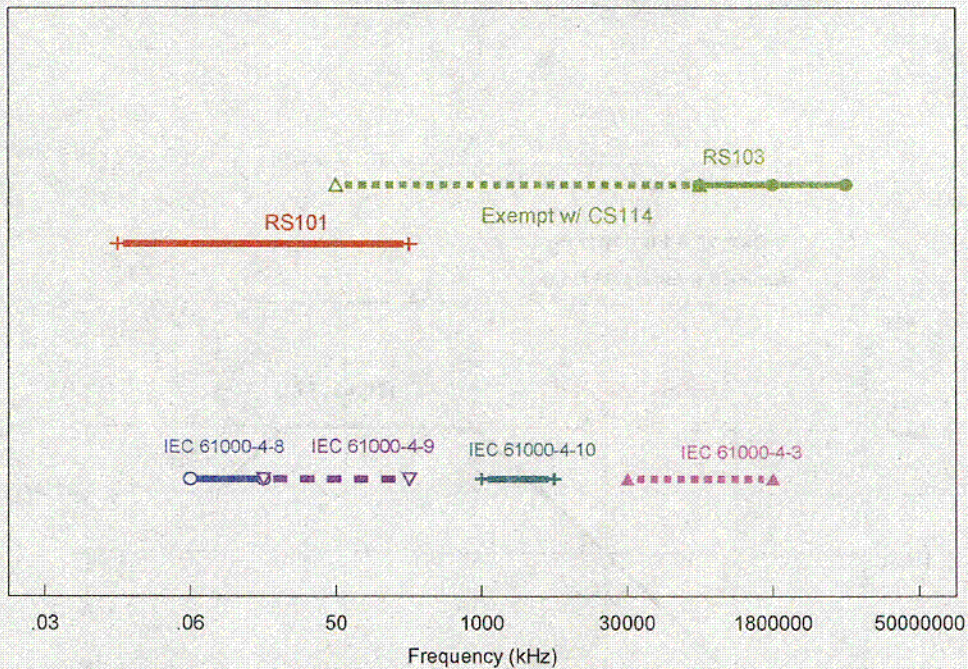

Fig. 7.1. Radiated susceptibility frequency coverage.

### 7.1 Radiated Susceptibility, Low Frequency—RS101 vs IEC 61000-4-8, -4-9 and -10

The low-frequency radiated susceptibility tests ensure that equipment and subsystems are not susceptible to radiated magnetic fields. Equipment that is not intended to be installed in areas with strong sources of magnetic fields (e.g., CRTs, motors, and cable bundles carrying high currents) could be exempt from these tests. The tests are applicable to equipment and subsystem enclosures and all interconnecting leads. The tests are not applicable for electromagnetic coupling via antennas. RS101 is the designation given to the MIL-STD-461E susceptibility test for radiated magnetic fields, and its commercial counterparts are IEC 61000-4-8, IEC 61000-4-9, and IEC 61000-4-10.

The primary rationale for the MIL-STD-461E RS101 test is to ensure that the performance of equipment potentially sensitive to low-frequency magnetic fields (e.g., sonar receivers) is not degraded. This is important on military platform where space is a premium, but is less of a factor in NPPs. An exemption can be offered based on the proximity to strong magnetic field emitters. In the case of safety-related I&C equipment, “proximity” can be easily be defined as an area within a radius (r) of 1 to 2 feet. The strength of magnetic fields emanating from a predominantly magnetic-field source (e.g., a loop antenna) will fall off as a function of  $1/r^3$  with distance. Hence, the levels will fall off drastically over the distance of just a few inches.

IEC 61000-4-8, *Electromagnetic Compatibility (EMC)—Power Frequency Magnetic Field Immunity Test*, relates to the immunity requirements of equipment to magnetic disturbances at the power frequency under typical operating conditions. IEC 61000-4-9, *Electromagnetic Compatibility (EMC)—Pulse Magnetic Field Immunity Test*, relates to the immunity of equipment to magnetic field pulses. IEC 61000-4-10,

*Electromagnetic Compatibility (EMC)—Damped Oscillatory Magnetic Field Immunity Test*, relates to the immunity requirements of equipment to damped oscillatory magnetic disturbances under typical operating conditions.

A comparison for the RS101, IEC 61000-4-8, IEC 61000-4-9, and IEC 61000-4-10 test methods is given in Table 7.1. Descriptions of how the parameters compare and of the findings from the comparison follow.

**Table 7.1. Comparison of low-frequency radiated susceptibility tests**

<b>Parameter</b>	<b>RS101</b>	<b>IEC 61000-4-8, -9, -10</b>
Application	Equipment enclosures	Equipment enclosures
Frequency coverage	30 Hz to 100 kHz	50 Hz, 60 Hz, 60 Hz to 50 kHz, 100 kHz, and 1 MHz
Methodology:		
Similarities	– Exposure to magnetic fields	– Exposure to magnetic fields
Differences	– Local exposure with small induction coils (multiple locations)	– Global exposure in large induction coil (entire enclosure)
Operating envelopes	See Fig. 7.2	See Fig. 7.2

### 7.1.1 Low-Frequency Radiated Susceptibility—Coverage

The RS101 test covers the frequency range of 30 Hz to 100 kHz. The IEC 61000-4-8 test covers only the power distribution frequencies at 50 Hz or 60 Hz. The IEC 61000-4-9 test provides pulses that cover the frequency range of 60 Hz to 50 kHz. The IEC 61000-4-10 test provides damped oscillatory magnetic fields at 100 kHz and at 1 MHz.

### 7.1.2 Low-Frequency Radiated Susceptibility—Methodology

The intent of the RS101 test and the IEC 61000-4 tests (-8, -9, and -10) are the same, i.e., to evaluate the performance of the EUT when it is subjected to radiated magnetic fields. However, the test methodologies are different. The methodology of the RS101 test produces local fields with a small coil and exposes multiple locations on the EUT to magnetic fields from a distance of 5 cm. The goal is to generate field leakage inside of the EUT. The RS101 test is conducted over the entire frequency range (30 Hz to 100 kHz). The IEC 61000-4-8, -9, and -10 tests assess the susceptibility of the EUT by immersing it in a magnetic field. The IEC 61000-4 tests are conducted at specific frequencies (50 Hz, 60 Hz, 60 Hz to 50 kHz, 100 kHz, and 1 MHz).

### 7.1.3 Low-Frequency Radiated Susceptibility—Operating Envelopes

Table 7.2 describes the classes of environments for the IEC 61000-4-8 test. The class that most closely resembles the NPP environment is Class 4. The continuous-field test level for Class 4 is 30 A/m, and the associated short-duration test level is 300 A/m.

Table 7.3 describes the classes of environment for the IEC 61000-4-9 and IEC 61000-4-10 tests. As with the IEC 61000-4-8 test, the class of environment for the IEC 61000-4-9 and IEC 61000-4-10 tests that most closely resembles the NPP environment is Class 4. The IEC 61000-4-9 test level for Class 4 is 300 A/m, and the IEC 61000-4-10 test level for Class 4 is 30 A/m.

A comparison of the RS101 operating envelope recommended in RG 1.180 and the IEC 61000-4 operating envelopes deemed suitable is shown in Fig. 7.2. The IEC 61000-4 test level units were converted from A/m to dBpT for the comparison. A summary of the IEC 61000-4 operating envelopes is given in Table 7.4.

**Table 7.2. IEC 61000-4-8 test classes**

<b>Class</b>	<b>Description</b>
1	Environmental level where sensitive devices using electron beams can be used. Monitors, electron microscopes, etc., are representative of these devices.
2	<b>Well-protected environment.</b> The environment is characterized by the following attributes: (1) absence of electrical equipment such as power transformers that may give rise to leakage fluxes; and (2) areas not subjected to the influence of high-voltage bus bars. Household, office, hospital protected areas far away from earth protection conductors, areas of industrial installations, and high-voltage substations may be representative of this environment.
3	<b>Protected environment.</b> The environment is characterized by the following attributes: (1) electrical equipment and cables that may give rise to leakage fluxes or magnetic fields; (2) proximity of earth conductors of protection systems; and (3) medium-voltage circuits and high-voltage bus bars far away (a few hundred meters) from the equipment concerned. Commercial areas, control buildings, fields of not heavy industrial plants, or computer rooms of high-voltage substations may be representative of this environment.
4	<b>Typical industrial environment.</b> The environment is characterized by the following attributes: (1) short branch power leads as bus bars, etc.; (2) high-power electrical equipment that may give rise to leakage fluxes; (3) ground conductors of protection systems; and (4) medium-voltage circuits and high-voltage bus bars at relative distances (a few tens of meters) from the equipment concerned. Fields of heavy industrial and power plants and the control rooms of high-voltage substations may be representative of this environment.
5	<b>Severe industrial environment.</b> The environment is characterized by the following attributes: (1) conductors, bus bars, or power leads carrying tens of kA; (2) ground conductors of the protection system; (3) proximity of medium-voltage and high-voltage bus bars; and (4) proximity of high-power electrical equipment. Switchyard areas of heavy industrial plants and power plants may be representative of this environment.
X	Special environment.

**Table 7.3. IEC 61000-4-9 and -4-10 test classes**

<b>Class</b>	<b>Description</b>
1	Test not applicable to this environment where sensitive devices using electron beams can be used (monitors, electron microscopes, etc. are representative of these devices).
2	<b>Well-protected environment.</b> Test not applicable to this environmental class because the areas concerned are not subjected to the influence of switching of high-voltage bus bars by isolators. Shielded areas of industrial installations and high-voltage substations may be representative of this environment.
3	<b>Protected environment.</b> The environment is characterized by medium-voltage circuits and high-voltage bus bars switched by isolators far away (a few hundred meters) from the equipment concerned. Computer rooms of high-voltage substations may be representative of this environment.
4	<b>Typical industrial environment.</b> The environment is characterized by medium-voltage circuits and high-voltage bus bars switched by isolators at relative distance (a few tens of meters) from the equipment concerned. Fields of heavy industrial and power plants and the control rooms of high-voltage substations may be representative of this environment.
5	<b>Severe industrial environment.</b> The environment is characterized by the following attributes: (1) proximity of medium-voltage and high-voltage bus bars switched by isolators and (2) proximity of high-power electrical equipment. Switchyard areas of heavy industrial plants and power plants may be representative of this environment.
X	Special environment.

**Table 7.4. IEC 61000-4-8 test levels for continuous field**

Test method	Selected class or level	Test level
IEC 61000-4-8	Continuous pulses: Class 4—typical industrial environment	30 A/m (152 dBpT)
	Short-duration pulses: Class 4—typical industrial environment	300 A/m (172 dBpT)
IEC 61000-4-9	Class 4—typical industrial environment	300 A/m (172 dBpT)
IEC 61000-4-10	Class 4—typical industrial environment	30 A/m (152 dBpT)

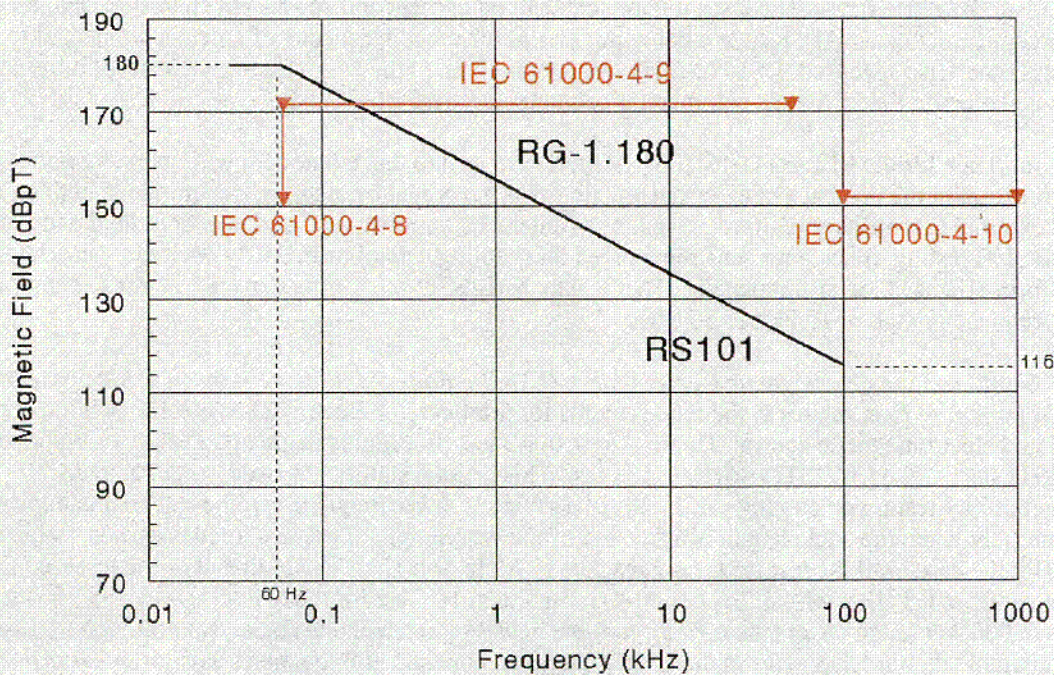

**Fig. 7.2. Low-frequency radiated susceptibility operating envelopes.**

#### 7.1.4 Low-Frequency Radiated Susceptibility—Findings

The IEC 61000-4-8, 61000-4-9, and 61000-4-10 tests cover the full gamut of magnetic field phenomena (power line frequency upsets, pulses, and damped sinusoidal oscillations) and appear to be comparable to the MIL-STD-461E RS101 test. The frequency coverage for the IEC 61000-4 tests is not as comprehensive, but the effects of interest for a NPP are covered. It is likely that the MIL-STD-461E RS101 coverage was set up to cover a suite of acoustic sensing devices, and so complete low-frequency coverage may not be significant in testing safety-related I&C equipment.

The methodologies for the RS101 test and IEC 61000-4 tests are different. The RS101 test is a proximity test, i.e., applying the magnetic fields to the EUT. The IEC 61000-4 tests are both immersion tests requiring the EUT to be placed in the center of a large induction coil.

The methodology of the RS101 test calls for producing local fields with a small coil and exposing multiple locations on the EUT. The small coil is typically positioned at a distance of 5 cm from the EUT.

It is recommended that the IEC 61000-4 tests be accepted as a complementary test set to the MIL-STD-461E RS101 test. The MIL-STD-461E RS101 test may not be of high value unless equipment is scheduled to be placed within inches of a known strong magnetic field emitter. Hence, an administrative measure of not placing equipment in the “proximity” of sources of strong magnetic fields might serve the same purpose.

## **7.2 Radiated Susceptibility, High Frequency—RS103 vs IEC 61000-4-3**

The high-frequency radiated susceptibility tests ensure that equipment and subsystems are not susceptible to radiated electric fields. The tests are applicable to equipment and subsystem enclosures and all interconnecting leads. The tests are not applicable at the tuned frequency of antenna-connected receivers, unless otherwise specified. RS103 is the designation given to the MIL-STD-461E susceptibility test for radiated electric fields, and its commercial counterpart is IEC 61000-4-3.

The rationale for the MIL-STD-461E RS103 test is to ensure that equipment will operate without degradation in the presence of electromagnetic fields generated by antenna transmissions both onboard and external to a military platform. Because of antenna size constraints and available field patterns during the RS103 testing, it has long been recognized that cabling cannot be properly excited to simulate platform effects at lower frequencies. That is why MIL-STD-461E offers an RS103 test exemption over the frequency range of 10 kHz to 30 MHz.

IEC 61000-4-3, *Electromagnetic Compatibility (EMC)—Radiated, Radio-Frequency, Electromagnetic Field Immunity Test*, relates to the requirements for immunity of electrical and electronic equipment to radiated electromagnetic energy. The IEC 61000-4-3 test procedures begin at 26 MHz, well above the 10-kHz start of the MIL-STD-461E RS103 test. This is not a significant issue, since radiated susceptibility testing on cabling is difficult to perform at lower frequencies. The test results improve immensely when the cable length is a fraction of the wavelength of the test frequency, and that is not usually the case until the test frequency reaches 10 MHz or higher. The high end of the test-frequency range ends at 1.8 GHz for the IEC 61000-4-3 test and at 10 GHz for the MIL-STD-461E RS103 test. The IEC 61000-4-3 range covers the operation of the new digital telephones being sold throughout Europe. Comparable digital telephones in the United States can operate at frequencies as high as 2.45 GHz. The 10-GHz upper-frequency bound for MIL-STD-461E is thus necessary to ensure that upsets and malfunctions are avoided in NPPs. A slightly lower frequency bound could be tolerated, but nothing less than 2.45 GHz would be acceptable.

A comparison for the RS103 and IEC 61000-4-3 test methods is given in Table 7.5. Descriptions of how the parameters compare and of the findings from the comparison follow.

### **7.2.1 High-Frequency Radiated Susceptibility—Coverage**

The MIL-STD-461E RS103 test covers the frequency range of 10 kHz to 10 GHz. However, equipment tested under the CS114 test may be exempted from application of this test in the frequency range of 10 kHz to 30 MHz.



**Table 7.5. Comparison of high-frequency radiated susceptibility tests**

<b>Parameter</b>	<b>RS103</b>	<b>IEC 61000-4-3</b>
Application	Equipment enclosures	Equipment enclosures
Frequency coverage	10 kHz to 1 GHz	26 MHz to 1 GHz
Methodology:		
Similarities	– Exposure to electric fields	– Exposure to electric fields
Differences	– Shielded or partially anechoic room	– Anechoic room
	– EUT exposure monitored by field probes	– Exposure levels determined with sensor grid without EUT
	– EUT grounded and bonded as in typical use	– EUT isolated from ground plane and grounded only through safety ground wire
	– No circularly polarized fields	– Circularly polarized fields allowed
	– Square wave modulation	– Sine wave modulation
	– Variable sweep rate through frequency bands	– Fixed sweep rate over entire frequency range
Operating envelopes	10 V/m	Level 3–10 V/m

The IEC 61000-4-3 test covers the frequency range of 26 MHz to 1 GHz, but it is normally applied only above 80 MHz. IEC 61000-4-6, the conducted susceptibility test, is typically used to evaluate the performance of equipment below 80 MHz.

### 7.2.2 High-Frequency Radiated Susceptibility—Methodology

There are differences in the test methods. The test area for the RS103 test can be either a shielded room or a partially anechoic room. The IEC 61000-4-3 test calls for an anechoic room for the test area. Monitoring of the electric fields in the test area is done with probes placed on the EUT during the RS103 test. For the IEC 61000-4-3 test, a sensor grid is established 1 to 3 m from the transmitting antenna, and the electric field levels are mapped out prior to running the test.

The RS103 test does not allow the use of circularly polarized antennas; the IEC 61000-4-3 test allows them. The RS103 test calls for square wave modulation with a 50% duty cycle, while the IEC 61000-4-3 test calls for sinusoidal wave modulation with an 80% duty cycle. The RS103 test calls for bonding the EUT to the ground plane, and the IEC 61000-3 test calls for grounding the EUT as in typical use (through the ground safety wire).

### 7.2.3 High-Frequency Radiated Susceptibility—Operating Envelopes

Table 7.6 describes the classes of environments outlined in the IEC 61000-4-3 test methodology, and Table 7.7 describes the associated test levels. Class 3 is the one that most closely resembles the NPP environment, and Level 3 is 10 V/m. The RS103 operating envelope recommended in RG 1.180 is 10 V/m.

### 7.2.4 High-Frequency Radiated Susceptibility—Findings

There are differences in the high-frequency test methodologies, but these differences are probably not substantial enough to make a significant difference in the test results. The operating envelopes are the same for both the RS103 test and the IEC 61000-4-3 test.

It is recommended that the IEC 61000-4-3 test be accepted as a complementary test set to the MIL-STD-461E RS103 and that the mentioned exemptions be applied in employing the tests. The MIL-STD-461E RS103 test is not a very good test at the lower frequencies, and the CS114 test is ultimately more

**Table 7.6. IEC 61000-4-3 test classes**

Class	Description
1	<b>Low-level electromagnetic radiation environment.</b> Levels typical of local radio/television stations located at more than 1 km, and transmitters/receivers of low power.
2	<b>Moderate electromagnetic radiation environment.</b> Low-power portable transceivers (typically less than 1-W rating) are in use, but with restrictions on use in close proximity to the equipment. A typical commercial environment.
3	<b>Severe electromagnetic radiation environment.</b> Portable transceivers (2-W rating or more) are in use relatively close to the equipment but not within less than 1 m. High-power broadcast transmitters are in close proximity to the equipment, and industrial-scientific-medical equipment may be located close by. A typical industrial environment.
X	Special environment.

**Table 7.7. IEC 61000-4-3 test levels**

Level	Electric field strength (V/m)
1	1
2	3
3	10
X <sup>a</sup>	Special

<sup>a</sup>X is an open level.

productive in that range. It is strongly suggested that the exemption be employed, along with the low-frequency exemption for IEC 61000-4-3.

At frequencies of above 1.8 GHz, it is suggested that the MIL-STD-461E RS103 test be performed when there is a concern about high-frequency transmitters being activated in an area with safety-related I&C equipment.

## 8. COMPARISON OF SWC TEST METHODS

### 8.1 Ring Wave—IEEE C62.41 vs IEC 61000-4-12

The ring wave simulates oscillatory surges of relatively high frequency on the leads of equipment and subsystems; it is represented by an open-circuit voltage waveform. The waveform is a 100-kHz sinusoid having an initial rise time of 0.5  $\mu$ s and continually decaying amplitude. A plot of the waveform is shown in Fig. 8.1. The rise time is defined as the time difference between the 10% and 90% amplitude points on the leading edge of the waveform. The amplitude of the waveform decays with each peak being 60% of the amplitude of the preceding peak of the opposite polarity.

The IEEE C62.41 and IEC 61000-4-12 methodologies for the ring wave test are essentially the same. However, the applications of the test methods differ. IEEE C62.41 is applicable to power leads only, while IEC 61000-4-12 is applicable to both signal and power leads.

The ring wave operating envelope,  $V_p$ , recommended in RG 1.180 is 3 kV. The suggested IEC 61000-4-12 operating envelope for an industrial environment (Level 3) is 2 kV for power leads and 1 kV for signal leads. The IEC 61000-4-12 operating envelope appears to be aligned with the intended environment, and it is recommended that the 2-kV level be adopted for the IEEE C62.41 test as well.

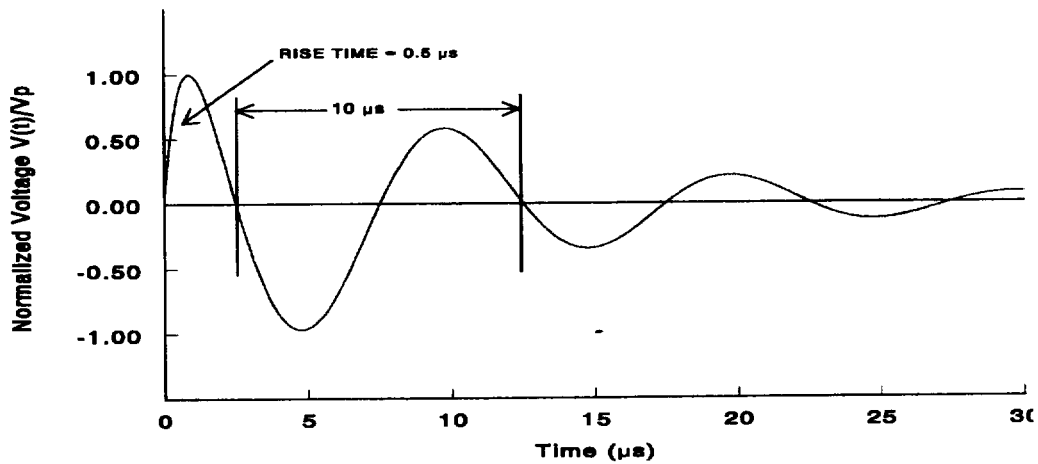

Fig. 8.1. 100-kHz ring wave.

### 8.2 Combination Wave—IEEE C62.41 vs IEC 61000-4-5

The combination wave involves two exponential waveforms, an open-circuit voltage and a short-circuit current. It is intended to represent direct lightning discharges, fuse operation, or capacitor switching on the ac power leads of equipment and subsystems. The open-circuit voltage waveform has a 1.2-μs rise time and an exponential decay with a duration (to 50% of initial peak level) of 50 μs. The short-circuit current waveform has an 8-μs rise time and a duration of 20 μs. Plots of the waveforms are shown in Figs. 8.2 and 8.3.

The rise time is defined as the time difference between the 10% and 90% amplitude points on the leading edge of the waveform. The duration is defined as the time between virtual origin and the time at the 50% amplitude point on the tail of the waveform. Virtual origin is the point where a straight line between the 30% and 90% points on the leading edge of the waveform intersects the  $V=0$  line for the open-circuit voltage and the  $I=0$  line for the short-circuit current.

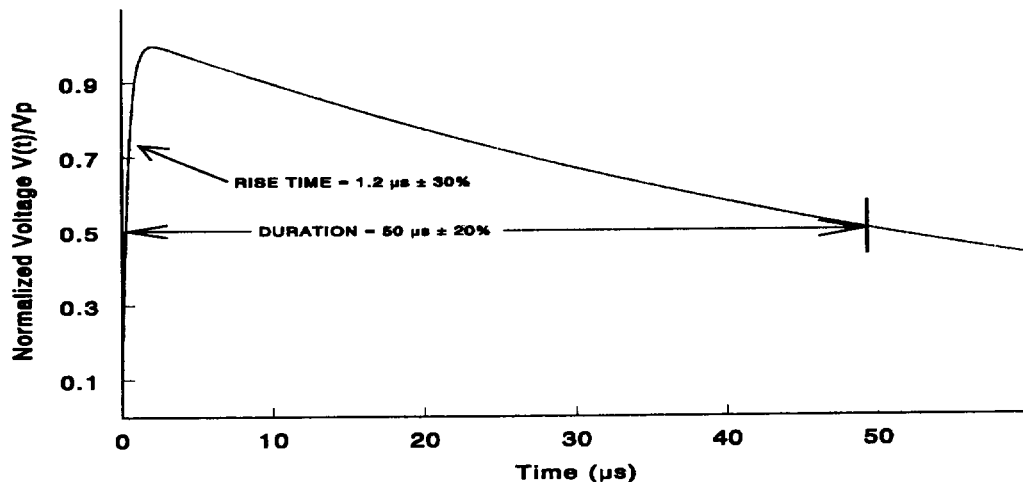
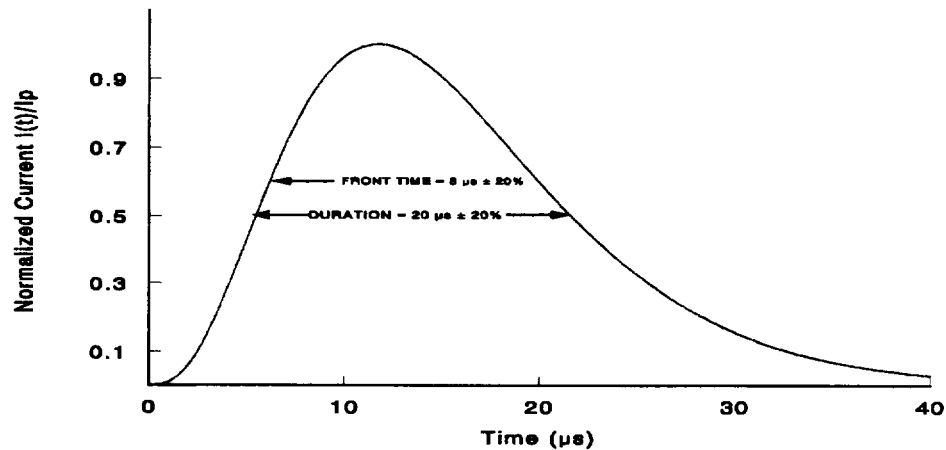

Fig. 8.2. Combination wave, open-circuit voltage.



**Fig. 8.3. Combination wave, short-circuit current.**

The IEEE C62.41 and IEC 61000-4-5 methodologies for the combination wave tests are essentially the same. However, the applications of the test methods differ. IEEE C62.41 is applicable to power leads only, while IEC 61000-4-12 is applicable to both signal and power leads.

The operating envelope recommended in RG 1.180 for the combination wave open-circuit voltage,  $V_p$ , is 3 kV. The corresponding recommended peak value of the short-circuit current,  $I_p$ , is 1.5 kA. The suggested IEC 61000-4-5 open-circuit voltage for an industrial environment (Level 3) is 2 kV for power leads and 1 kV for signal leads. The corresponding suggested IEC 61000-4-5 short-circuit current is 1 kA for power leads and 0.5 kA for signal leads. The IEC 61000-4-5 operating envelope appears to be aligned with the intended environment, and it is recommended that the 2-kV level open-circuit voltage and 1-kA short-circuit current be adopted for the IEEE C62.41 test as well.

### **8.3 Electrically Fast Transients/Bursts—IEEE C62.41 vs IEC 61000-4-4**

The EFT/B waveform consists of repetitive bursts, with each burst containing individual unidirectional pulses, and is intended to represent local load switching on the ac power leads of equipment and subsystems. The individual EFT/B pulses have a 5-ns rise time and a duration (width at half-maximum) of 50 ns. Plots of the pattern of the EFT bursts and the EFT pulse waveform were previously shown in Figs. 6.8 and 6.9. The number of pulses in a burst is determined by the pulse frequency. For peaks of less than or equal to 2 kV, the frequency shall be 5 kHz  $\pm$  1 kHz. For EFT peaks of greater than 2 kV, the frequency shall be 2.5 kHz  $\pm$  0.5 kHz. The differences in repetition rates are intended not to reflect characteristics of the power surge environment, but to accommodate existing limitations in pulse generator performance.

The rise time is defined as the time difference between the 10% and 90% amplitude points on the leading edge of the waveform. The duration is defined as the time between the 50% amplitude points on the leading and trailing edges of each individual pulse. Individual pulses occur in bursts of duration 15 ms.

The IEEE C62.41 and IEC 61000-4-4 methodologies for the EFT/B test are essentially the same. However, the applications of the test methods differ. IEEE C62.41 is applicable to power leads only, while IEC 61000-4-4 is applicable to both signal and power leads.

The operating envelope recommended in RG 1.180 for the EFT/B test is 3 kV. The suggested IEC 61000-4-5 operating envelope for an industrial environment (Level 3) is 2 kV for power leads and 1 kV for

signal leads. The IEC 61000-4-5 operating envelope appears to be aligned with the intended environment, and it is recommended that the 2-kV level be adopted for the C62.41 test as well.

## 9. CONCLUSIONS

Table 9.1 shows the corresponding MIL-STD-461E and IEC 61000 test methods. Table 9.2 shows the corresponding IEEE C62.41 and IEC 61000 test methods.

**Table 9.1. MIL-STD-461E and IEC 61000 test methods**

<b>MIL-STD-461E</b>	<b>IEC 61000</b>
CE101	None
CE102	IEC 61000-6-4
CS101	IEC 61000-4-13
	IEC 61000-4-16
CS114	IEC 61000-4-6
	IEC 61000-4-16
CS115	IEC 61000-4-4
CS116	IEC 61000-4-12
RE101	None
RE102	IEC 61000-6-4
RS101	IEC 61000-4-8
	IEC 61000-4-9
	IEC 61000-4-10
RS103	IEC 61000-4-3

**Table 9.2. Corresponding IEEE C62.41 and IEC 61000 test methods**

<b>IEEE C62.41</b>	<b>IEC 61000</b>
Ring wave	IEC 61000-4-12
Combination wave	IEC 61000-4-5
EFT/B	IEC 61000-4-4

The overall conclusion is that for all phenomena where there is comparable frequency-range coverage, the MIL-STD-461E and IEEE C62.41 test methods could be interchanged with the IEC 61000 test methods without a loss in confidence that the equipment could withstand the intended NPP environment. However, there are some differences between the test methods. These differences include:

- Bonding to the ground plane during the MIL-STD-461E tests, while attaching to the safety ground wire during the IEC 61000 tests;
- Employing different types of detectors that can influence the measurement reading (e.g., peak, quasi-peak, and average detectors);
- Using LISNs during the MIL-STD-461E tests to block power line noise, while using dedicated power sources during the IEC 61000 test; and
- Using different types of modulation (square wave vs sinusoidal) with varying duty cycles during the tests.

The most obvious difference between some of the MIL-STD-461E and IEC 61000 test methods is the parameter that is being measured (e.g., voltage vs current), but this problem can be resolved by investigating the testing apparatus. For example, the amount of energy that will couple onto a power or signal lead can be calculated whether the injection mechanism is inductive coupling or capacitive coupling. The other differences should not have a significant impact on the expected outcome, as long as

care is taken in reviewing the test results. Some practices, like attaching to the safety ground wire, are more practical for the NPP environment anyway, as bonding is not typically done in the industrial sector.

## 10. REFERENCES

1. Regulatory Guide 1.180, *Guidelines for Evaluating Electromagnetic and Radio-Frequency Interference in Safety-Related Instrumentation and Control Systems*, U.S. Nuclear Regulatory Commission, Jan. 2000.
2. P. D. Ewing and K. Korsah, *Technical Basis for Evaluating Electromagnetic and Radio-Frequency Interference in Safety-Related I&C Systems*, NUREG/CR-5941, Oak Ridge National Laboratory, April 1994.
3. S. W. Kerchel, M. R. Moore, and E. D. Blakeman, *Survey of Ambient Electromagnetic and Radio-Frequency Interference Levels in Nuclear Power Plants*, NUREG/CR-6436, Oak Ridge National Laboratory, Nov. 1996.
4. P. D. Ewing and R. T. Wood, *Recommended Electromagnetic Operating Envelopes for Safety-Related I&C Systems in Nuclear Power Plants*, NUREG/CR-6431, Oak Ridge National Laboratory, Jan. 2000.
5. P. D. Ewing, R. T. Wood, K. Korsah, et al., *Electromagnetic Compatibility for Conducted Susceptibility Along Interconnecting Signal Lines*, NUREG/CR-5609, Oak Ridge National Laboratory, Nov. 2001 (draft).
6. MIL-STD-461D, *Electromagnetic Emission and Susceptibility Requirement for the Control of Electromagnetic Interference*, U.S. Department of Defense, Jan. 11, 1993.
7. MIL-STD-462D, *Measurement of Electromagnetic Interference Characteristics*, U.S. Department of Defense, Jan. 11, 1993.
8. IEEE Std C62.41-1991 (Reaff 1995), *IEEE Recommended Practice on Surge Voltages in Low-Voltage AC Power Circuits*, Institute of Electrical and Electronics Engineers.
9. IEEE Std C62.45-1992, *IEEE Guide on Surge Testing for Equipment Connected to Low-Voltage AC Power Circuits*, Institute of Electrical and Electronics Engineers.
10. MIL-STD-461E, *Requirements for the Control of Electromagnetic Interference Characteristics of Subsystems and Equipment*, U.S. Department of Defense, Aug. 20, 1999.
11. IEC 61000-6-4, *Electromagnetic Compatibility (EMC)—Emission Standard for Industrial Environments*, Part 6: Generic Standards, Section 4: Emission Standard for Industrial Environments, International Electrotechnical Commission, Technical Committee No. 65, 1997.
12. CISPR 11, *Industrial, Scientific, and Medical (ISM) Radio-Frequency Equipment—Electromagnetic Disturbance Characteristics—Limits and Methods of Measurement*, International Special Committee on Radio Interference, 1997.
13. CISPR 14-1, *Requirements for Household Appliances, Electric Tools and Similar Apparatus*, International Special Committee on Radio Interference, 1993.

14. CISPR 15, *Limits and Methods of Measurement of Radio Disturbance Characteristics of Electrical Lighting and Similar Equipment*, International Special Committee on Radio Interference, 1992.
15. CISPR 22, *Information Technology Equipment—Radio Disturbance Characteristics—Limits and Methods of Measurement*, International Special Committee on Radio Interference, 1985.
16. IEC 61000-4-1, *Electromagnetic Compatibility—Testing and Measurement Techniques*, Section 1: Overview of Immunity Tests, European Committee for Electrotechnical Standardization, 1992.
17. IEC 61000-4-2, *Electromagnetic Compatibility—Testing and Measurement Techniques*, Section 2: Electrostatic Discharge Immunity Test, European Committee for Electrotechnical Standardization, 1995.
18. IEC 61000-4-3, *Electromagnetic Compatibility—Testing and Measurement Techniques*, Section 3: Radiated, Radio-Frequency, Electromagnetic Field Immunity Test, European Committee for Electrotechnical Standardization, 1995.
19. IEC 61000-4-4, *Electromagnetic Compatibility—Testing and Measurement Techniques*, Section 4: Electrical Fast Transient/Burst Immunity Test, European Committee for Electrotechnical Standardization, 1995.
20. IEC 61000-4-5, *Electromagnetic Compatibility—Testing and Measurement Techniques*, Section 5: Surge Immunity Test, European Committee for Electrotechnical Standardization, 1995.
21. IEC 61000-4-6, *Electromagnetic Compatibility—Testing and Measurement Techniques*, Section 6: Immunity to Conducted Disturbances, Induced by Radio-Frequency Fields, European Committee for Electrotechnical Standardization, 1996.
22. IEC 61000-4-7, *Electromagnetic Compatibility—Testing and Measurement Techniques*, Section 7: General Guide on Harmonics and Interharmonics Measurements and Instrumentation, for Power Supply Systems and Equipment Connected Thereto, European Committee for Electrotechnical Standardization, 1991.
23. IEC 61000-4-8, *Electromagnetic Compatibility—Testing and Measurement Techniques*, Section 8: Power Frequency Magnetic Field Immunity Test, European Committee for Electrotechnical Standardization, 1993.
24. IEC 61000-4-9, *Electromagnetic Compatibility—Testing and Measurement Techniques*, Section 9: Pulse Magnetic Field Immunity Test, European Committee for Electrotechnical Standardization, 1993.
25. IEC 61000-4-10, *Electromagnetic Compatibility—Testing and Measurement Techniques*, Section 10: Damped Oscillatory Magnetic Field Immunity Test, European Committee for Electrotechnical Standardization, 1993.
26. IEC 61000-4-11, *Electromagnetic Compatibility—Testing and Measurement Techniques*, Section 11: Voltage Dips, Short Interruptions, and Voltage Variations Immunity Test, European Committee for Electrotechnical Standardization, 1994.
27. IEC 61000-4-12, *Electromagnetic Compatibility—Testing and Measurement Techniques*, Section 12: Oscillatory Waves Immunity Tests, European Committee for Electrotechnical Standardization, 1996.

28. IEC 61000-4-13, *Electromagnetic Compatibility—Testing and Measurement Techniques*, Section 13: Immunity to Harmonics and Interharmonics, European Committee for Electrotechnical Standardization, 1998.
29. IEC 61000-4-16, *Electromagnetic Compatibility—Testing and Measurement Techniques*, Section 16: Test for Immunity to Conducted, Common Mode Disturbances in the Frequency Range 0 Hz to 150 kHz, European Committee for Electrotechnical Standardization,
30. EMCS Project Number 0178, *Engineering Practice Study: Results of Detailed Comparisons of Individual EMC Requirements and Test Procedures Delineated in Major National and International Commercial Standards with Military Standard MIL-STD-461E*, U.S. Department of Defense, April 6, 2000.
31. IEC 61000-3-2, *Limits for Harmonic Current Emissions*, International Electrotechnical Commission, Technical Committee No. 65, 1998.
32. IEC 61000-3-4, *Limitation of Emission of Harmonic Currents in Low-voltage Power Supply Systems for Equipment with Rated Current Greater than 16 A*, Technical Committee No. 65, 1998.



## APPENDIX A. MIL-STD-461E CHANGES

MIL-STD-461E provides platform applicability information, limits, and associated test procedures in a single document. Many acquisitions in the past decade were based on MIL-STD-461D and MIL-STD-462D. MIL-STD-461D provided platform applicability and limits, while MIL-STD-462D provided the associated test methodology. The “E” and “D” versions contain basically the same information. The following summary provides highlights of most of the significant differences between MIL-STD-461E and MIL-STD-461D/462D. There are many minor improvements. If details are desired, the individual documents should be reviewed.

- a. Table II of MIL-STD-461E defines measurement receiver characteristics for emission testing. The frequency break point between the third and fourth frequency ranges is 250 kHz in MIL-STD-461E, while it was 150 kHz in MIL-STD-462D.
- b. In section 4.3.10.4.1 and Table III of MIL-STD-461E, which define scanning requirements for susceptibility testing, the dwell time at each test frequency is three seconds, while it was one second in MIL-STD-462D. The frequency scan rates and step sizes for 30 Hz to 1 GHz have been increased in MIL-STD-461E from those in MIL-STD-462D.
- c. In Table V of MIL-STD-461E, which shows whether specific requirements are applicable to particular platforms, some applicability designations for equipment installation location are changed from MIL-STD-461D. CE101 is not applicable for ships in MIL-STD-461E, while it was in MIL-STD-461D. CS115 is applicable in MIL-STD-461E for all “ground” applications, while “limited” applicability was specified in MIL-STD-461D. CS116 is applicable in MIL-STD-461E, while “limited” applicability was specified in MIL-STD-461D. RS101 is applicable in MIL-STD-461E for Navy ground, while “limited” applicability was specified in MIL-STD-461D.
- d. CS101. In MIL-STD-461E, the upper frequency is 150 kHz, while it was 50 kHz in MIL-STD-461D. MIL-STD-461E includes a curve that specifies the maximum required power, which is dependent on frequency. MIL-STD-461D requires a maximum of 80 Watts, regardless of frequency.
- e. CS109. In MIL-STD-461E, the test setup includes a coupling transformer at the output of the power amplifier to simply the establishment of a single-point ground, and the applied current is measured with a current probe. MIL-STD-462D uses isolation transformers for instrumentation to control the single-point ground and requires measurement of the current across a series resistor. Also, MIL-STD-461E includes more detail on required test points.
- f. CS114. The requirement for the loop circuit impedance measurement in MIL-STD-462D has been removed in MIL-STD-461E. The alternative limit, which is used when the injection signal is being applied to the EUT, is 6 dB above the calibration curves in MIL-STD-461E, regardless of frequency. MIL-STD-461D specifies a constant level applicable across the entire frequency range that is 6 dB above the maximum portion of the calibration curves. Also, a maximum insertion loss for injection probes is included in MIL-STD-461E.
- g. CS116. The requirement for the loop circuit impedance measurement in MIL-STD-462D has been removed in MIL-STD-461E. How to measure “Q” is clarified in MIL-STD-461E.
- h. RE101. The requirement for the 50-centimeter distance contained in MIL-STD-461D has been removed in MIL-STD-461E. The limit for Navy applications has been modified. In MIL-STD-461E, measurements are required only for EUT faces and electrical connectors. In MIL-STD-462D, testing of electrical cables was also required.

- i. RE102. In MIL-STD-461E, the upper frequency for submarines is 18 GHz, while it is 1 GHz in MIL-STD-461D. Also, the submarine limit levels are modified in MIL-STD-461E, and separate limits are provided for inside and outside the pressure hull. Limits for aircraft in MIL-STD-461E have been modified to make a distinction based on aircraft size, and the limits are no longer dependent on particular military services.
- j. RS101. The limit for Navy applications has been modified in MIL-STD-461E. In MIL-STD-461E, measurements are required only for EUT faces and electrical connectors. In MIL-STD-462D, testing of electrical cables was also required. MIL-STD-461E includes an alternative procedure using Helmholtz coils.
- k. RS103. MIL-STD-461E includes an alternative procedure using a mode-tuned reverberation chamber above 200 MHz.
- l. RS105. MIL-STD-461E has a new limit curve and the procedure has been clarified.
- m. Appendix. MIL-STD-461E incorporates numerous changes in the non-contractual appendix.

NRC FORM 335 (2-89) NRCM 1102, 3201, 3202	U.S. NUCLEAR REGULATORY COMMISSION  <b>BIBLIOGRAPHIC DATA SHEET</b> <i>(See instructions on the reverse)</i>	1. REPORT NUMBER  NUREG/CR-6782 ORNL/TM-2001/140			
2. TITLE AND SUBTITLE  <b>Comparison of U.S. Military and International Electromagnetic          Compatibility Guidance</b>	3. DATE REPORT PUBLISHED				
	<table border="1" style="width: 100%;"> <tr> <td style="width: 50%;">MONTH</td> <td style="width: 50%;">YEAR</td> </tr> <tr> <td style="text-align: center;">07</td> <td style="text-align: center;">2002</td> </tr> </table>	MONTH	YEAR	07	2002
	MONTH	YEAR			
07	2002				
4. FIN OR GRANT NUMBER JCN W6960					
5. AUTHOR(S)  <b>Paul D. Ewing and Richard T. Wood</b>	6. TYPE OF REPORT  <b>Technical</b>				
	7. PERIOD COVERED <i>(Inclusive Dates)</i>				
8. PERFORMING ORGANIZATION - NAME AND ADDRESS <i>(If NRC, provide Division, Office or Region, U.S. Nuclear Regulatory Commission, and mailing address; if contractor, provide name and mailing address.)</i> <b>Oak Ridge National Laboratory          P.O. Box 2008, MS-6006          Oak Ridge, TN 37831-6006</b>					
9. SPONSORING ORGANIZATION - NAME AND ADDRESS <i>(If NRC, type "Same as above"; if contractor, provide NRC Division, Office or Region, U.S. Nuclear Regulatory Commission, and mailing address.)</i> <b>Division of Engineering Technology          Office of Nuclear Regulatory Research          U.S. Nuclear Regulatory Commission          Washington, DC 20555-0001</b>					
10. SUPPLEMENTARY NOTES <b>Christina Antonescu, NRC Project Manager</b>					
11. ABSTRACT <i>(200 words or less)</i>  <p>The Oak Ridge National Laboratory (ORNL) has been engaged by the U.S. Nuclear Regulatory Commission (NRC) Office of Nuclear Regulatory Research to assist in developing the technical basis for regulatory guidance on electromagnetic interference (EMI) and radio-frequency interference (RFI) immunity and power surge withstand capability (SWC). Previous research has provided recommendations on electromagnetic compatibility (EMC) design and installation practices, endorsement of EMI/RFI immunity and SWC test criteria and test methods, and determination of ambient electromagnetic conditions at nuclear power plants. These recommendations have been incorporated into the technical basis for guidance in addressing EMI/RFI and power surges in safety-related instrumentation and control (I&amp;C) systems in nuclear power plants.</p> <p>The recommendations by the ORNL staff on test criteria, test methods, and operating envelopes were significantly influenced by the military standards issued by the U.S. Department of Defense (DOD). That is the case because until recently there were no comprehensive commercial standards that covered EMI/RFI immunity. The present research involves reviewing and assessing the commercial standards issued by the International Electrotechnical Commission (IEC) and endorsed by the European Union in the last few years. This document reports the results of a study performed by the ORNL staff comparing the U.S. military and international EMC guidance.</p>					
12. KEY WORDS/DESCRIPTORS <i>(List words or phrases that will assist researchers in locating the report.)</i>  <b>electromagnetic compatibility (EMC)          electromagnetic interference (EMI)          electromagnetic receivers          instrumentation and control (I&amp;C)          nuclear power plant          radio-frequency interference (RFI)</b>	13. AVAILABILITY STATEMENT <b>Unlimited</b>				
	14. SECURITY CLASSIFICATION <i>(This Page)</i> <b>Unclassified</b>				
	<i>(This Report)</i> <b>Unclassified</b>				
	15. NUMBER OF PAGES				
16. PRICE					



Federal Recycling Program

NUREG/CR-6782  
DRAFT

COMPARISON OF U.S. MILITARY AND INTERNATIONAL  
ELECTROMAGNETIC COMPATIBILITY GUIDANCE

JULY 2002

UNITED STATES  
NUCLEAR REGULATORY COMMISSION  
WASHINGTON, DC 20555-0001

---

OFFICIAL BUSINESS  
PENALTY FOR PRIVATE USE, \$300