

# **OPUS/PlotOPUS: An ORIGEN-S Post-Processing Utility and Plotting Program for SCALE**

**Oak Ridge National Laboratory**

**U.S. Nuclear Regulatory Commission  
Office of Nuclear Material Safety and Safeguards  
Washington, DC 20555-0001**



**AVAILABILITY OF REFERENCE MATERIALS  
IN NRC PUBLICATIONS**

**NRC Reference Material**

As of November 1999, you may electronically access NUREG-series publications and other NRC records at NRC's Public Electronic Reading Room at [www.nrc.gov/NRC/ADAMS/index.html](http://www.nrc.gov/NRC/ADAMS/index.html). Publicly released records include, to name a few, NUREG-series publications; *Federal Register* notices; applicant, licensee, and vendor documents and correspondence; NRC correspondence and internal memoranda; bulletins and information notices; inspection and investigative reports; licensee event reports; and Commission papers and their attachments.

NRC publications in the NUREG series, NRC regulations, and *Title 10, Energy*, in the Code of *Federal Regulations* may also be purchased from one of these two sources.

1. The Superintendent of Documents  
U.S. Government Printing Office  
Mail Stop SSOP  
Washington, DC 20402-0001  
Internet: [bookstore.gpo.gov](http://bookstore.gpo.gov)  
Telephone: 202-512-1800  
Fax: 202-512-2250
2. The National Technical Information Service  
Springfield, VA 22161-0002  
[www.ntis.gov](http://www.ntis.gov)  
1-800-553-6847 or, locally, 703-605-6000

A single copy of each NRC draft report for comment is available free, to the extent of supply, upon written request as follows:

Address: Office of the Chief Information Officer,  
Reproduction and Distribution  
Services Section  
U.S. Nuclear Regulatory Commission  
Washington, DC 20555-0001  
E-mail: [DISTRIBUTION@nrc.gov](mailto:DISTRIBUTION@nrc.gov)  
Facsimile: 301-415-2289

Some publications in the NUREG series that are posted at NRC's Web site address [www.nrc.gov/NRC/NUREGS/indexnum.html](http://www.nrc.gov/NRC/NUREGS/indexnum.html) are updated periodically and may differ from the last printed version. Although references to material found on a Web site bear the date the material was accessed, the material available on the date cited may subsequently be removed from the site.

**Non-NRC Reference Material**

Documents available from public and special technical libraries include all open literature items, such as books, journal articles, and transactions, *Federal Register* notices, Federal and State legislation, and congressional reports. Such documents as theses, dissertations, foreign reports and translations, and non-NRC conference proceedings may be purchased from their sponsoring organization.

Copies of industry codes and standards used in a substantive manner in the NRC regulatory process are maintained at—

The NRC Technical Library  
Two White Flint North  
11545 Rockville Pike  
Rockville, MD 20852-2738

These standards are available in the library for reference use by the public. Codes and standards are usually copyrighted and may be purchased from the originating organization or, if they are American National Standards, from—

American National Standards Institute  
11 West 42<sup>nd</sup> Street  
New York, NY 10036-8002  
[www.ansi.org](http://www.ansi.org)  
212-642-4900

Legally binding regulatory requirements are stated only in laws; NRC regulations; licenses, including technical specifications; or orders, not in NUREG-series publications. The views expressed in contractor-prepared publications in this series are not necessarily those of the NRC.

The NUREG series comprises (1) technical and administrative reports and books prepared by the staff (NUREG-XXXX) or agency contractors (NUREG/CR-XXXX), (2) proceedings of conferences (NUREG/CP-XXXX), (3) reports resulting from international agreements (NUREG/IA-XXXX), (4) brochures (NUREG/BR-XXXX), and (5) compilations of legal decisions and orders of the Commission and Atomic and Safety Licensing Boards and of Directors' decisions under Section 2.206 of NRC's regulations (NUREG-0750).

**DISCLAIMER:** This report was prepared as an account of work sponsored by an agency of the U.S. Government. Neither the U.S. Government nor any agency thereof, nor any employee, makes any warranty, expressed or implied, or assumes any legal liability or responsibility for any third party's use, or the results of such use, of any information, apparatus, product, or process disclosed in this publication, or represents that its use by such third party would not infringe privately owned rights.

# **OPUS/PlotOPUS: An ORIGEN-S Post-Processing Utility and Plotting Program for SCALE**

---

---

Manuscript Completed: March 2001  
Date Published: April 2001

Prepared by  
I. C. Gauld, D. L. Barnett,  
O. W. Hermann, S. M. Bowman

Oak Ridge National Laboratory  
Managed by UT-Battelle, LLC  
Oak Ridge, TN 37831-6370

C. J. Withee, NRC Project Manager

**Prepared for  
Spent Fuel Project Office  
Office of Nuclear Material Safety and Safeguards  
U.S. Nuclear Regulatory Commission  
Washington, DC 20555-0001  
NRC Job Code B-0009**



## ABSTRACT

The OPUS utility program produces an output file that can be used for making a variety of plots from output produced by the ORIGEN-S code that computes reactor fuel depletion, activation and fission- product buildup, and the corresponding photon and neutron source spectra. Tables containing individual and total nuclide or element concentrations, in 14 different units, may be generated as a function of time. Three classes of plot data may be produced by OPUS: (1) dominant or selected isotopes or elements, (2) photon and neutron source spectra, and (3) comparisons of selected quantities (totals or individual nuclides) between different ORIGEN-S cases. The input is designed for ease of use with self-explanatory parameter names, free-form input, and commonly used default values.

The formatted output data produced by OPUS is designed to be used directly by the PlotOPUS graphics-plotting program. PlotOPUS is an interactive Visual Basic program designed for Windows 9x, 2000, and NT computers. PlotOPUS reads the formatted output data file produced by OPUS, plots the data, and will generate Windows metafile (WMF), JPEG bitmap (JPG), or Windows bitmap (BMP) files for saving the plot images. Even though it is designed to interface with PlotOPUS, the formatted OPUS output file can be easily read by other graphics packages for data visualization.

# CONTENTS

	<u>Page</u>
ABSTRACT .....	iii
LIST OF FIGURES .....	vii
LIST OF TABLES.....	ix
ACKNOWLEDGMENTS .....	xi
1 INTRODUCTION.....	1
2 TYPES OF PLOT OPTIONS .....	3
2.1 Nuclides and Elements.....	3
2.2 Photon and Neutron Source Spectra .....	3
2.3 Case Comparisons.....	4
3 PROGRAM FLOW.....	5
3.1 Overview.....	5
3.1.1 Subroutine Descriptions.....	5
4 INPUT DESCRIPTION .....	11
4.1 Free-Form Opus Input Rules .....	11
4.2 Keyword Input Description .....	11
4.3 Optional Selection of Time Points to Plot .....	17
4.4 Logical Unit Parameters .....	19
5 PLOTOPUS GRAPHICS PROGRAM .....	21
5.1 Plots of Dominant or Selected Isotopes or Elements.....	21
5.2 Plots of Neutron or Photon Spectra .....	21
5.3 Plots of Case Comparisons .....	24
5.4 Screen Descriptions .....	25
5.4.1 MDI Screen and Toolbar .....	25
5.5 Customization of Plots.....	26
5.6 Zoom Feature.....	28
6 SAMPLE PROBLEMS .....	31
6.1 Sample Problem 1 .....	31
6.2 Sample Problem 2.....	32
6.3 Sample Problem 3.....	32
6.4 Sample Problem 4.....	32
6.5 Sample Problem 5.....	33
6.6 Sample Problem 6.....	33
6.7 Sample Problem 7.....	33
6.8 Sample Problem 8.....	34
6.9 Sample Problem 9.....	34
6.10 Sample Problem 10.....	35
6.11 Printed Output.....	36
6.12 Plot Data File .....	36

# CONTENTS (continued)

	<u>Page</u>
7 REFERENCES .....	53
APPENDIX A: ORIGEN-S CASES.....	55
APPENDIX B: PLOT FILE FORMATS .....	61
B.1 File Header Information.....	63
B.2 Nuclide and Element Plot Types .....	63
B.3 Spectral Plot Types .....	64
B.4 Case Comparison Plot Types.....	64

# LIST OF FIGURES

<u>Figure</u>	<u>Page</u>
3.1 Flowchart of main OPUS initialization and user-input routines .....	6
3.2 Flowchart of PLDRVR main control routine .....	7
3.3 Flowchart of library input, data input, data-unit conversion, and spectral routines .....	9
3.4 Flowchart of nuclide- and element-ranking routines.....	10
5.1 PlotOPUS default display window for selected or dominant nuclides.....	22
5.2 PlotOPUS display window for gamma spectrum plot.....	23
5.3 PlotOPUS display window for case comparison showing different case totals .....	24
5.4 PlotOPUS toolbar.....	25
5.5 PlotOPUS color palette .....	26
5.6 Popup menu.....	26
5.7 Customization dialog.....	27
5.8 Plot showing zoomed rectangle area .....	28
5.9 Zoomed plot .....	29
6.1 Example of header page and program verification output .....	37
6.2 Printed output data from sample problem 1 .....	38
6.3 Printed output data from sample problem 4 .....	39
6.4 Plot file generated for sample problem 1 .....	40
6.5 Plot file generated for sample problem 2 .....	41
6.6 Plot file generated for sample problem 3 .....	42
6.7 Plot file generated for sample problem 4 .....	43
6.8 Plot file generated for sample problem 5 .....	44
6.9 Plot file generated for sample problem 6 .....	44
6.10 Plot file generated for sample problem 7 .....	44

## LIST OF FIGURES (continued)

<u>Figure</u>	<u>Page</u>
6.11 Plot file generated for sample problem 8 .....	45
6.12 Plot file generated for sample problem 9 .....	45
6.13 Plot file generated for sample problem 10.....	46
6.14 Plot made from sample problem 1 .....	47
6.15 Plot made from sample problem 3 .....	48
6.16 Plot made from sample problem 4 .....	49
6.17 Plot made from sample problem 5 .....	50
6.18 Plot made from sample problem 7 .....	51
A.1 ORIGEN-S input for the 33-GWd/MTU case .....	58
A.2 ORIGEN-S input for the 28-GWd/MTU case .....	59
A.3 ORIGEN-S input for the 55-GWd/MTU case .....	60



# LIST OF TABLES

<b><u>Table</u></b>	<b><u>Page</u></b>
4.1 OPUS input description.....	13
4.2 Optional input keywords for data set selection .....	18
4.3 File parameters for logical units.....	19

## **ACKNOWLEDGMENTS**

The authors acknowledge the efforts of J. C. Ryman and B. L. Broadhead for their review of the manuscript, and J. C. Ryman for verification and testing of the program. The authors thank Willena Carter for formatting the manuscript and C. H. Shappert for editing the manuscript.

# 1 INTRODUCTION

The analysis of ORIGEN-S results often involves evaluating large amounts of output data that may include time-dependent nuclide and element inventories, radiological decay properties, and neutron and photon source spectra. The ORIGEN-S code<sup>1</sup> is a SCALE system<sup>2</sup> functional module for computing reactor fuel depletion, activation and fission-product buildup, and associated radiation spectra. Visualization of the output data from ORIGEN-S often provides a means of rapidly evaluating the dominant nuclides in a problem, identifying important trends in the results, and providing insight into the problem that is not easily obtained otherwise. The OPUS utility program has been developed to read and process ORIGEN-S results into a format easily input to graphics-plotting packages.

OPUS was developed from an earlier plotting package, PLORIGEN, originally written to plot ORIGEN-S results using the commercial plotting package, DISPLA, which executed on a mainframe computer. The program was revised to output a formatted (ASCII) file, which can be easily read by most graphics packages, removing the dependency on commercial software. A Visual Basic program PlotOPUS has been developed to provide a plotting capability of the ORIGEN-S results on Windows 9x, 2000, and NT computer platforms. PlotOPUS is specifically designed to read the formatted output data produced by OPUS, plot the results, and generate Windows metafile (WMF), bitmap (BMP) files, and JPEG (JPG) files for saving the plot images. Alternatively, any other graphics package or spreadsheet can be used to read the output data file for data visualization.

The various types of data that can be output by OPUS fall into three separate classes, briefly described as (1) dominant or selected isotopes or elements, (2) photon and neutron source spectra, and (3) comparisons of output results between different ORIGEN-S cases. These data may be extracted for any time period of interest. One of the key features of the program is that it will automatically extract, by default, the 40 most dominant nuclides or elements in the problem, rank them using the output parameter and time periods of interest as specified by the user, and give the total. The selection, ranking, and totals may be generated for any group of nuclides including actinides, fission products, or activation products, or for all nuclides in the problem. The totals are printed for all nuclides in the specified group, and a subtotal is generated for all nuclides in the printed nuclide-ranking list. The user may also specify any other nuclide or element to be included in the output. The results may be ranked and output using 16 different units. Also, quantities from different ORIGEN-S output files may be extracted for comparison.

The intent in designing the features in OPUS was to permit a fairly extensive variety of plot types to be made, and keep the program easy to use. All user input is by keyword, and uses the SCALE free-form input routines.<sup>3</sup> Default values are assigned to most input variables, allowing a comprehensive visual analysis of output data with relatively little user input required.

The Visual Basic interactive program PlotOPUS may be used to perform the actual plotting using the OPUS output file. PlotOPUS was created using the Pro Essentials graphing package from Gigasoft, and was designed to allow the user to create color plots. No purchase of software is required. PlotOPUS will execute on a Windows 95/98/2000/NT PC. Once in PlotOPUS the user may interactively select any combination of the available nuclides in the file for display.

This report describes the OPUS program, provides a brief description of subroutines, the types of data that can be generated, the input requirements, and provides sample cases. The formats of the output file generated by the code are also documented. The plotting capabilities and features of the PlotOPUS graphics-plotting program are also described.

## 2 TYPES OF PLOT OPTIONS

Some of the general features of the OPUS plotting utility code are discussed first, followed by descriptions of each of the three types of plots. The nuclides in the ORIGEN-S nuclear data libraries<sup>4</sup> are grouped into what are referred to as the light-element (activation product), actinide, and fission-product libraries. The plot data in each of the plot types may encompass nuclides from all three libraries, nuclides from only one library, or nuclides from the combination of the actinide and fission-product libraries.

### 2.1 Nuclides and Elements

Plot data may be output by either nuclide or element, in 16 different units. An element result is simply the sum of results for all isotopes of the element. The data may be generated in any unit for both ORIGEN-S irradiation and decay subcases.

Three methods are available for selecting the nuclides or elements of interest: (1) the symbols for the elements or nuclides requested may be specified explicitly by the user; (2) the code may automatically determine the dominant nuclides or elements for the requested output parameter (e.g., decay heat); or (3) both the dominant and additional user-selected nuclides or elements may be combined. When no user-selected nuclides or elements are entered, the dominant or highest ranking nuclides or elements are printed. The total number of nuclides or elements may be specified by the user. The dominant nuclides (or elements) are determined by ranking in accordance with values calculated using an approximate logarithmic numerical integration over a requested time range. When the user explicitly selects nuclides (or elements) then these nuclides will always be printed in the output, regardless of their ranking. However, if the nuclide is not valid for the library type selected, then that entry is skipped. For example, if <sup>137</sup>Cs is requested and the library type is set to actinide, the entry is skipped. When the number of user-requested nuclides or elements is less than the total number requested for the printed output (either default or selected by the user), the code expands the user entries with the highest ranking nuclides (or elements) that are not already included in the user list. If the number of user-specified entries is exactly equal to the number requested in the printout, then only the user-selected entries are printed.

A large variety of units for the concentrations, radiological quantities, and time axes may be requested (see the input description in Section 4.2). These units include concentration units of mass, partial density, atom and weight percent, atomic number density, and radiological quantities that include radioactivity, decay heat, and toxicity. The allowed units for time are seconds, minutes, hours, days, and years.

The totals are always generated for the plot. These totals represent the sum over all nuclides or elements in the specified library type. In addition, a subtotal is printed (only in the printout and not the plot file) that represents the sum over just the printed nuclides or elements.

### 2.2 Photon and Neutron Source Spectra

Photon and neutron energy spectra calculated by an ORIGEN-S decay case may be requested for any time interval. The energy range of the spectra may be specified in the input.

The photon source spectra can be computed by ORIGEN-S using several different photon databases, any of which may be requested. The spectra obtained using the data in ORIGEN-S cross-section libraries use a fixed energy-group structure, and are commonly called "photon tables." Alternatively, "special gamma source spectra" may be computed using alternative data sources (i.e., the Master Photon or ENDF/B data library) in a user-defined energy-group structure. The photon spectra calculated using this option may be computed for the radionuclides in

the individual actinide, fission-product, or activation-product libraries, or for the total spectrum from all radionuclides.

Any of the ORIGEN-S photon spectra discussed above may be accessed. One significant difference in the units of the spectra output by OPUS and those printed by ORIGEN-S, is that the intensities have been converted from units of photons/s to photons/(s·MeV) by dividing by the energy group widths. This conversion produces intensities for the different energy groups that have a comparable basis when comparing spectra with different energy-group structures. Energy-intensity spectra, in units of MeV/(s·MeV), may also be requested.

Three types of neutron source spectra are computed by ORIGEN-S: spontaneous-fission neutron spectra, (alpha,n) spectra, and total neutron spectra. Any of these three spectral types may be requested in OPUS. The output neutron intensities are divided by the energy-group width, resulting in spectra that are in units of neutrons/(s·MeV).

## 2.3 Case Comparisons

The primary purpose of this option is to allow comparisons of time-dependent quantities (e.g., thermal power) from two or more different ORIGEN-S cases. As examples, ORIGEN-S results could be compared from cases with variations in burnup, <sup>235</sup>U initial enrichment, or reactor assembly types. Also, the user may optionally input data manually (i.e., data from another calculation or measurement) for comparison with ORIGEN-S case results. A legend may be specified to identify each curve. Comparison of different cases may be performed for totals or for an individual nuclide selected by the user.

For case comparison plots involving either totals or individual nuclides, a large variety of time and concentration units may be used. These units include concentration units of mass, partial density, atomic number density, and radiological quantities that include radioactivity, decay heat, and toxicity. The allowable time units are seconds, minutes, hours, days, and years. In addition, totals may be requested separately for actinides, fission products, or activation-product nuclides.

## 3 PROGRAM FLOW

### 3.1 Overview

The OPUS program is designed to run as a SCALE system module. It will read nuclide compositions generated and saved from a previous ORIGEN-S case, process the compositions into the desired quantities, and output the data in a formatted ASCII file that can be read by a graphics package to subsequently display the results. With the exception of a user-input data option, OPUS reads all inventories in units of gram-atoms from the binary composition interface file (unit NXTR) produced by ORIGEN-S. The conversion to user-requested units is performed entirely within OPUS, using nuclear decay data (e.g., decay constants) from the ORIGEN-S library. The output units provided by OPUS include all of those provided in ORIGEN-S, plus several other units not available in ORIGEN-S. In addition, OPUS will generate these output quantities for either irradiation or decay subcases, significantly extending the print capabilities available in the ORIGEN-S code.

The two routines that control major program flow are OPUS, the main program, and PLDRVR. The calls to the initialization of parameters, input routines, and array-size allocation routines are made in OPUS. All calls to the entry routines of the other major functions are made in PLDRVR. The two major control routines and the routines controlling these functions are described below in the order of the program flow.

#### 3.1.1 Subroutine Descriptions

**Routine Name:** OPUS

**Routines Called:** OPNFIL, MESSAGE, INIT, IONUMS, INPUT, NOAH, OPENP, PLDRVR

**Function:** OPUS is the main program called by the SCALE driver. This section of the program, shown in Figure 3.1, is responsible for parameter initialization in INIT and reading of all user input in INPUT. The program banner is printed by MESSAGE. Data sets are opened in OPENP, permitting proper array size allocation. A generalized scheme of using the SCALE free-form reading routines (see Section M3) is applied by INPUT. IONUMS is used to pass the input and output unit numbers to the SCALE free-form reading routines. Instead of requiring a fixed order for the input data, OPUS allows input using keywords. The BLOCK DATA /PLDATA/ initializes the common /NAMES/ to the four-character keywords. In subroutine INPUT the common /NAMES/ contains the character-array WORDST, which is used to define an index for the keyword that is used to store the user-input data in the INDATA array, and to obtain the flag from the INFO array which indicates whether the keyword input value is an integer variable (requiring IREAD for an integer read), floating-point variable (requiring FREAD for floating-point input), or character data (requiring AREAD for character input). Special flags are set for the nuclide and element symbol processing and arrays data input. Subroutine NOAH may be called to convert nuclide IZA identifiers to character symbols for printing. The logical array ARR determines the path for either scalar or array data. Parameters DBUG, NDAT, EMAX, and EMIN are the only parameters that are read separately and not stored in /INDATA/. Control is transferred to PLDRVR, which provides main program flow control.

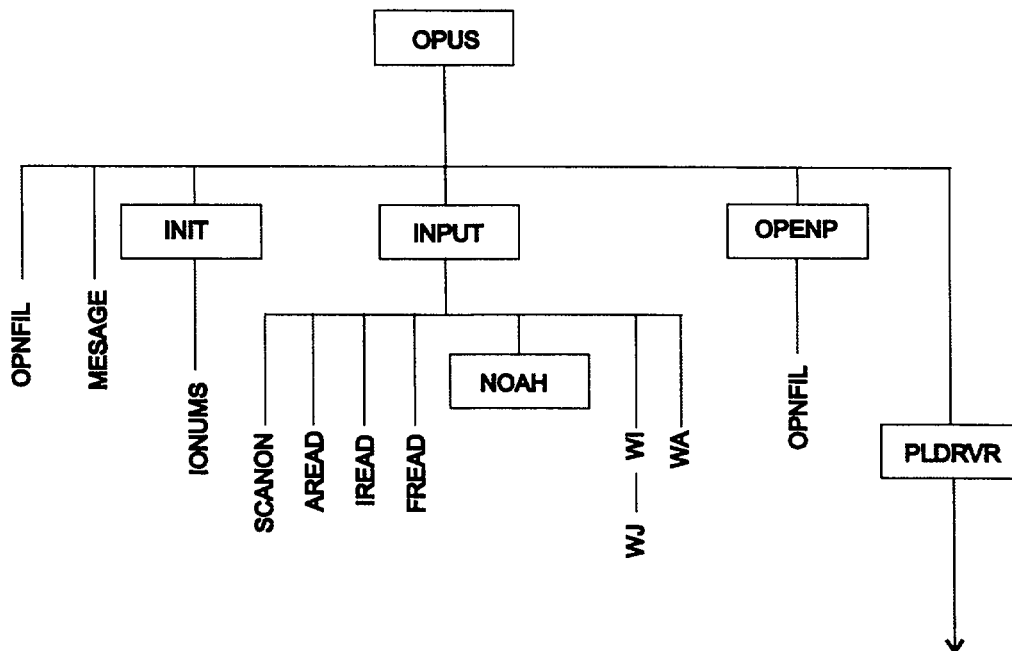

Figure 3.1 Flowchart of main OPUS initialization and user-input routines

**Routine Name:** PLDRVR

**Routines Called:** LIBIN, DATIN, CALUN, RANK, SPEC

**Function:** This section of the program, shown in Figure 3.2, performs major program flow control for the code. Reads ORIGEN-S binary nuclear data library data in LIBIN. Loops through other subroutines NCAS times, where NCAS is number of cases compared. The ORIGEN-S inventory data for the case are read in DATIN. Isotopic concentration (non-spectrum) data are converted to requested units in CALUN. Ranking of nuclides or elements in descending order is performed in RANK. Spectral plot parameters are set in SPEC.

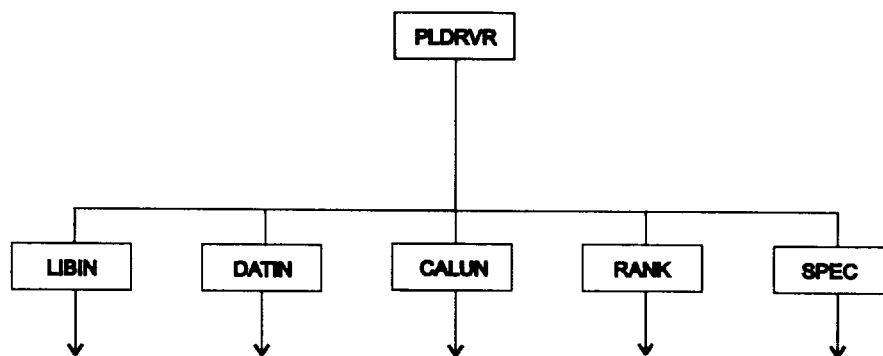

Figure 3.2 Flowchart of PLDRVR main control routine



**Routine Name:** LIBIN**Routines Called:** WI, CHKLIM, XLIBIN

**Function:** This section of the program, shown in Figure 3.3, sets pointers for all arrays used by XLIBIN from sizes in first record of the ORIGEN-S binary library. Calls XLIBIN, which reads the required data records from the ORIGEN-S library. These records include the decay constants, recoverable energy per decay, fraction of decay energy due to photons, and toxicity data. Checks required space against allocated array size LIMIT in subroutine CHKLIM.

**Routine Name:** DATIN**Routines Called:** MAKEPO, SETISP, XDATIN, CHKLIM, NEWTIM, MAKEHD, WI

**Function:** This section of the program, shown in Figure 3.3, sets pointers in DATIN to arrays used in this branch. Calls MAKEPO to determine the total number of time steps to be read. The time-step position numbers are determined from other types of input data that define the data points wanted. Sets the spectrum-type flag, ISPEC, for spectral-type requests, and determines the number of energy groups in SETISP. Calls XDATIN to read ORIGEN-S case data. XDATIN calls NEWTIM for converting time to seconds, computes average energy of groups, moves spectral data to array YINT, and makes proper default axis labels or headings in MAKEHD. WI is used for writing DEBUG information if requested by DEBUG=YES.

**Routine Name:** CALUN**Routines Called:** XCALUN, WI

**Function:** This section of the program, shown in Figure 3.3, calls XCALUN to convert input concentrations in array X from gram-atoms to units requested by user. The X-array data, and unit-conversion data, are read by XDATIN and XLIBIN, respectively. If requested units are grams/cm<sup>3</sup> or atoms/barn-cm, conversion requires additional user input for the fuel volume VFUEL.

**Routine Name:** SPEC**Routines Called:** XSPEC, WI

**Function:** This section of the program, shown in Figure 3.3, sets pointer LADD for each energy-spectrum intensity array, and calls XSPEC. Then, XSPEC sets the group range indices (group N1 to N2), and the X- and Y-axis ranges, and computes the intensities-per-energy-group width (MeV) and writes out the spectrum.

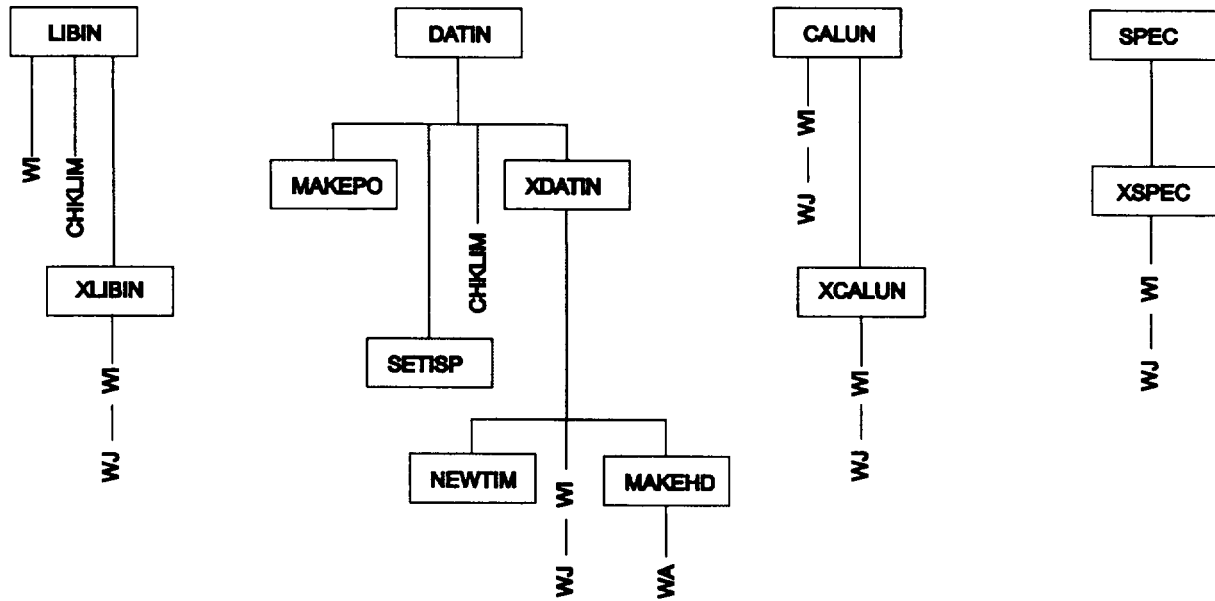

Figure 3.3 Flowchart of library input, data input, data-unit conversion, and spectral routines

**Routine Name:** RANK

**Routines Called:** NURANK, SUMIT, ELRANK, SORTP, EDIT, WI, WN, WE

**Function:** This section of the program, shown in Figure 3.4, sorts nuclides or elements into descending order of quantities of the requested units, which were stored in the X array after converting units in XCALUN. Calls either NURANK for ranking nuclides or ELRANK for elements. NURANK computes the ranking-integral quantities for nuclides, sorts the nuclides in SORTP, adds any nuclides requested explicitly in the input, and calls EDIT to print tables of the selected and highest-ranked nuclides. NOAH converts the ORIGEN-S nuclide identifiers (integer) into alphanumeric character symbols. Totals of all nuclides in the requested libraries are computed by SUMIT. Subtotals for only those nuclides printed are also calculated and printed. When ELRANK is called for ranking elements, it performs the same functions as NURANK after taking the sum of all isotopic quantities for each element in all requested libraries. WI, WN, WE are used to write debug information, only if DEBUG=YES.

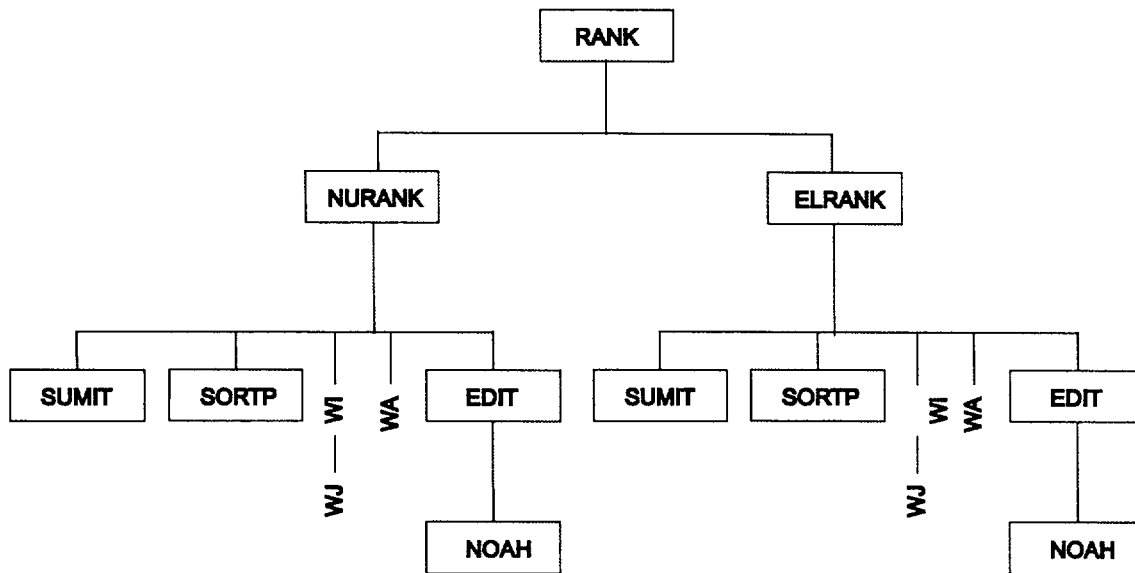

Figure 3.4 Flowchart of nuclide- and element-ranking routines

## 4 INPUT DESCRIPTION

The OPUS input description is divided into two sections. The first section describes the general rules and format of the free-form input. The second section is a table of the keywords, their default values (where applicable), the types of plot data to which the keyword is applicable, and a description of the keyword.

When OPUS is executed within the SCALE system, the input description is delimited by =OPUS, starting in the first column of the first record, and the characters END, starting in the first column of the last record. Multiple OPUS cases may be stacked in this manner, and each case will be run sequentially within SCALE. Each case will produce a single plot file with a unique file name (\_plot000, \_plot001, \_plot002, etc.). Note that the word END is also used to delimit array-data entries in the OPUS input description. If END is used elsewhere, it may not begin in the first column since it could prematurely indicate the end of the case.

### 4.1 Free-Form Opus Input Rules

OPUS input records are limited to a maximum of 80 columns. A single data entry may be entered anywhere in a record but cannot be divided between two records; however, array-data entries may be divided over many records. A data entry (from left to right) is composed of a keyword, an equals sign (=), and numeric or alphanumeric data. A data entry is illustrated in the following example:

```
title=PWR 33 GWD/MTU 3.3 wt % U-235
```

The code identifies keywords using only the first four characters in the keyword name. In the above example, "titl" is used, while the "e" is ignored. Beyond the first four characters, the user may add any other alphanumeric or special character acceptable to FORTRAN, including single blanks, before the "=" character. Alphanumeric data may be either a single-word type having no embedded blanks or a multiple-word type (as in titles or axis labels) with single embedded blanks. The single-word type is terminated by only one blank (with more permitted). The multiple-word type is terminated by a double blank, permitting the data to contain single blanks, or a new record.

Floating-point data may be entered in various forms; for example, the value 12340.0 may be entered as: 12340, 12340.0, 1.234+4, 1.234E+4, 1.234E4, or 1.234E 04. Also, the value 0.012 may be entered as 12E-3, 12-3, 1.2-2, etc. Numeric data must be followed immediately by one or more blanks.

Array data (floating-point and integer) for an array-type parameter must always be terminated with an END that does not begin in column one.

The order of the input parameters in a single case is not restricted to any required sequence, with one exception. The exception concerns only case comparisons. Once NDATASET=1 is input for this type of plot, all additional input data (such as the logical unit number or the time-step numbers for this case) apply to the first curve until another NDATASET entry (e.g., NDATASET=2) is input.

### 4.2 Keyword Input Description

The input to OPUS is performed entirely using keywords. The keywords, keyword descriptions, and allowed choices for each keyword entry are listed in Table 4.1. The input keywords and their choices occupy the first column. The next three columns indicate the type of plot where the keyword may be entered. An "X" in these

columns indicates the keyword is an available entry for that type of plot. An “NA” in these columns indicates it is not a keyword for that type of plot. The last column is a description of the input keyword.

The default values are given in parentheses after the input keyword definitions. Only the first four characters of any keyword (the letters are in bold), plus the “=”, are required. Any additional keyword characters are ignored by the code, and may therefore be set to any character string. The keyword default value is listed in parentheses, and values are provided for almost all of the numeric input and axis labels. For example, the user has the option to input axis labels using **XLABEL=** and **YLABEL=** entries, or use “built-in” axis labels that are based on the time units and the type of data units. Also, the code automatically extracts requested data for all decay time points less than 5 years (default value for **TMAX**) read from an **ORIGEN-S** composition data file, unless the option for specifying individual time points (Section 4.3) is used. If the keyword has a default value and the user does not enter that keyword, then the default value will be used. When entering the keywords, do not put their values in parentheses.

Table 4.1 OPUS input description

Input keywords	Nuclide/element data	Photon/neutron spectra	Case comparison	Keyword description
TMAX=(5.01) <sup>a</sup> TMIN=(0.4)	X	X	X	Data at all decay times from 0.0 to TMAX are selected. Times must be in units of days or years. Importance ranking is performed over interval TMIN to TMAX. Units of TMAX and TMIN are the same as TIME.
LIBUNIT=(21)	X	X	X	The unit number of the ORIGEN-S binary cross-section library used in producing compositions; if a card image library was used, it must first be converted to binary format using COUPLE. In ORIGEN-ARP calculations, the unit number is usually 33.
TITLE=(ORIGEN-S case title)	X	X	X	Title of plot, limit of 80 characters. The title from the ORIGEN-S case is used by default.
TYPARAMS=(NUCLIDES) NUCLIDES	X X	X NA	X NA	The type of parameter to be plotted. Request data for the comparison of individual nuclides.
ELEMENTS	X	NA	NA	Request data for the comparison of elements.
GSPECTRUM	NA	X	NA	Request for photon spectrum.
NSPECTRUM	NA	X	NA	Request total neutron spectrum from spontaneous fission plus (alpha,n) reactions.
SFSPEC	NA	X	NA	Request neutron spectrum for only spontaneous fission.
ANSPEC	NA	X	NA	Request neutron spectrum for only (alpha,n) reactions.
TOTALS	NA	NA	X	Case comparison type plot data.
NRANK=(40)	X	NA	NA	Total number of nuclides or elements to be output for the plot. If user-selected nuclides or elements are requested (see SYMNUC) the output will include these nuclides plus any remaining ones with the highest rankings for the quantity specified. The total and subtotal are always printed.

<sup>a</sup> Parentheses ( ) indicate default values where applicable.

Table 4.1 (continued)

Input keywords	Nuclide/element data	Photon/neutron spectra	Case comparison	Keyword description
UNITS=(CURIES)				Requested Data Units.
ABSORPTIONS	X	NA	X	Fractional neutron absorptions, over all absorptions.
AIRM**3	X	NA	X	Toxicity, cubic meters of air to dilute to RCG <sub>a</sub> .
APELEM	X	NA	NA	Atom % of element. Isotopic atom percents of all elements specified in SYMNUC.
ATOMS / B-CM	X	NA	X	Atoms/barn-cm. Requires VFUEL entry.
BEQUERELS	X	NA	X	Radioactivity, Bq
CURIES	X	NA	X	Radioactivity, Ci.
GAMWATTS	X	NA	X	Gamma-ray thermal power, watts (W).
GATOMS	X	NA	X	Gram atoms, gram-atomic weights or moles.
GPERCM**3	X	NA	X	Partial density, grams/cm <sup>3</sup> . Requires entry for VFUEL.
GRAMS	X	NA	X	Mass, grams.
H2OM**3	X	NA	X	Toxicity, cubic meters of water to dilute to RCG <sub>w</sub> .
KILOGRAMS	X	NA	X	Mass, kilograms.
WPELEM	X	NA	NA	Weight % of element. Isotopic weight percents of all elements specified in SYMNUC.
WATTS	X	NA	X	Total thermal power, Watts.
PHOTONS/SEC/MEV	NA	X	NA	Default for TYPARAM=GSPEC. Intensity of photon spectra in photons/(s MeV).
ENERGY/SEC/MEV	NA	X	NA	Option for TYPARAM=GSPEC. Energy intensity of photon spectra in MeV/(s MeV).
LIBTYPE=(ALL)	X	X	X	Identifies type of nuclides or elements requested, according to ORIGEN-S library type or a combination of libraries. <b>Optional for spectral plots.</b>
LITE	X	X	X	Light-element material (activation product) library.
ACT	X	X	X	Actinide or heavy-element library.
FISS	X	X	X	Fission-product library.
FISACT	X	NA	X	The actinide and fission-product libraries.
ALL	X	NA	X	Light-element, actinide, and fission-product libraries.
GEN	NA	X	NA	Photon library or library built from entries for LNGAM and the 82\$ array and the group structure in the 83* array. Default for TYPARAM=GSPEC.

Table 4.1 (continued)

Input keywords	Nuclide/element data	Photon/neutron spectra	Case comparison	Keyword description
SYMNUC=	X	NA	X	<p>Symbolic notation of nuclides or elements requested in the plot data. The list is an array terminated with an END. Maximum entries is 200. Nuclide entry is by chemical symbol and mass number, separated by a dash "-". Metastable states are indicated with an "m" immediately following the mass number (e.g., Am-242m). For a nuclide common to both the light element and fission product libraries, selection is governed by LIBTYPE. If LIBTYPE=ALL, fission products are selected over light element nuclides. Element entry is by chemical symbol only (e.g., Pu).</p> <p>For case comparisons the totals are plotted unless there is a nuclide entry in SYMNUC, in which case the first nuclide entered is compared.</p>
TIME=(YEARS) SEC MIN HOURS DAYS YEARS OTHER	X	NA	X	<p>Unit of time to be plotted.</p> <p>Time plotted in seconds.</p> <p>Time plotted in minutes.</p> <p>Time plotted in hours.</p> <p>Time plotted in days.</p> <p>Time plotted in years.</p> <p>Use when TUNIT and TCONST were input to ORIGEN-S case.</p> <p><b>NOTE:</b> If time steps selected by TMAX, the only valid entries for TIME are DAYS and YEARS.</p>
RESPONSE=	X	NA	X	<p>Optional user-specified arbitrary response conversion factors. These factors are applied to the compositions in units requested by UNITS. Entries are in nuclide ID - response factor pairs. Nuclide identifiers entered as ORIGEN-S 6-digit integer IDs. Array data and must be terminated with an END.</p>
EMIN=(0.0)	NA	X	NA	<p>Lower limit of energy range (MeV) for photon and neutron spectra data.</p>
EMAX=(10.0)	NA	X	NA	<p>Upper limit of energy range (MeV).</p>
VFUEL=(108956.4) (270. / 238.) * 10 <sup>6</sup> / (0.95 * 10.96)	X	NA	X	<p>Fuel volume in cm<sup>3</sup>. Required when plotting in units of grams/cm<sup>3</sup> or atoms/barn-cm. Default value assumes 1 MTU of UO<sub>2</sub> at 95% theoretical density.</p>



Table 4.1 (continued)

Input keywords	Nuclide/element	Photon/neutron spectra	Case comparison	Keyword description
NCASES=(1)	NA	NA	X	The number of different data sets to be compared in a case comparison-type plot. Optional user input data specified using XINPUT and YINPUT (if present) are not considered to be an additional case.
XINPUT= YINPUT=	NA	NA	X	Optional X- and Y-data values entered by the user in the units used in a case. Array data terminated with an END. X data are entered as X(1), X(2), X(3), ... END, with corresponding Y data entered as Y(1), Y(2), Y(3), ... END. <b>NOTE:</b> XINPUT and YINPUT may be entered only once. Commas are optional data delimiters.
NDATASET=(1)	NA	NA	X	Data set number. This keyword must be specified once for each case in a case comparison. The input values should be numbered sequentially, 1, 2, 3, ... for each case. The NDATASET entry precedes the case-specific input and is followed by NUMUNIT=, LEGEND=, and any special data point selection keywords (e.g., NPOS=, CASP=, etc.).
NUMUNIT=(71)	X	X	X	Logical unit number of ORIGEN-S concentrations and spectral data requested (unit NXTR in ORIGEN-S).
LEGEND=	NA	NA	X	The legend description of the plot data for case comparisons. Entered once for every entry of NDATASET. May contain single blanks and a maximum of 24 characters.
XLABEL= YLABEL=	X	X	X	X- and Y-axis labels, up to 80 characters. If this parameter is not input, a label is generated automatically.
DEBUG=(NO) YES NO	X	X	X	Option to write debug information in the printed output. Includes printout of input data, computed data, and indices used in ranking.
LIMIT=(200000)	X	X	X	Number of words allocated to problem.

### 4.3 Optional Selection of Time Points to Plot

The default method of selecting plot data is to accept all time points available on the logical unit containing the ORIGEN-S concentrations up to TMAX years, where the value of TMAX is defaulted to 5 years. Only those time points associated with decay times, or decay subcases, are selected. Even though this method provides an easy way to select data points, some applications may make it necessary to explicitly specify the particular data points to be plotted. These steps could include plotting inventories during irradiation, skipping some data points, or skipping data in entire cases.

To allow a flexible method of selecting data, either a time-step number or a step-position number may optionally reference time points by specifying optional keywords. Time-step numbers refer to the time intervals in an ORIGEN-S subcase, where the total number of time intervals in a subcase is equal to MOUT (see Section F7.6.10 of Ref. 1). When data at a given time-step are being saved, ORIGEN-S prints a statement identifying both the time-step (NSTEP) number and the position (NPOSITION) on the data file. It also prints both the subcase position and subcase number. The position numbers are unique identifiers that represent the position locator of the data set in the data file. The position numbers are always numbered consecutively, starting at position 1 for the first data set on the file, and are incremented sequentially (e.g., 1, 2, 3, ...).

The following is an example of the statement in ORIGEN-S that identifies which results are being saved:

```
.results on logical no. 71, position 2, for time step 6, subcase 3.  
(run position 1, case position 2)
```

User-specified time points may be requested by using at least one of the keywords listed in Table 4.2. Many of the default values will often apply. The NPOSITION and NSTEP entries are free-form integer array lists and therefore must be terminated with an END. Note that if NSTEP=0 is specified, the data pertain to the starting data of the subcase, if it has been saved on the data file. The relationship between the subcase position number CASPOSITION and the subcase number CASNUMBER is similar to the relationship between NPOSITION and NSTEP.

Data may be requested by either position number (NPOSITION=) or time-step number (NSTEP=), but never by both. In the example for the print statement above, the user could request this data set by specifying any one of the following entries:

- (a) NPOSITION=2
- (b) NSTEP=6 CASNUMBER=3
- (c) RUNPOSITION=1 CASPOSITION=2

**Table 4.2 Optional input keywords for data set selection**

<b>Input keywords</b>	<b>Type</b>	<b>Keyword description</b>
<b>NPOSITION=</b> (no default)	Array	List of all requested position numbers of data (on NUMUNIT), in ascending order. No other entries are required since NPOSITION is a unique data set identifier. Terminate with END.
<b>NSTEPS=</b> (no default)	Array	List of all requested time-step numbers, in ascending order, of data (on NUMUNIT) from CASNUMBER. Terminate with END.
<b>CASPOSITION=(1)</b>	Variable	The subcase position number of all requested data.
<b>CASNUMBER=(1)</b>	Variable	The subcase number of the data requested for RUNPOSITION.
<b>RUNPOSITION=(1)</b>	Variable	The run position number of requested data.
<b>MINPOSITION=(0)</b>	Variable	Minimum position number NPOSITION, used to request a range of positions.
<b>MAXPOSITION=(0)</b>	Variable	Maximum position number. All positions between MINPOSITION and MAXPOSITION, inclusive, are requested.
<b>MINSTEP=(0)</b>	Variable	Minimum set number NSTEP. Used with MAXSTEP to request a range of steps.
<b>MAXSTEP=(see description)</b>	Variable	Maximum step number. All steps between MINSTEP and MAXSTEP, inclusive, for the requested CASPOSITION, or RUNPOSITION and CASNUMBER, are requested. (Default values for MAXSTEP, if not specified, are MAXSTEP=0 if MINSTEP=0; MAXSTEP=10 if MINSTEP>0).

## 4.4 Logical Unit Parameters

Table 4.3 lists the logical unit Nos. used by OPUS, the variable or array names associated with the unit Nos., the type of file, and a file description.

**Table 4.3 File parameters for logical units**

Unit No.	Variable/array	Type	Description
5	N5	BCD	Free-format input file
6	N6	BCD	Formatted output file
8	N8	BCD	Formatted plot file; a named file <code>_plot000</code>
(21)	LIBU	Binary	ORIGEN-S nuclear data library
(71) <sup>a</sup>	NUMU(20)	Binary	ORIGEN-S restart concentrations file

<sup>a</sup> Units in parentheses represent initialized values that may be overwritten by user input values.

## 5 PLOTOPUS GRAPHICS PROGRAM

We have heard many times that a picture is worth a thousand words, and this is certainly true for scientific data analysis. A plot of results from a computer program can be much more informative than looking at thousands of numbers. In order to provide a plotting capability to handle the potentially large amounts of output results from the ORIGEN-S code, the plotting utility program OPUS was developed to extract the data required for plotting, perform an importance ranking, and output the processed data in a format more easily accepted by graphics programs than the format provided in the ORIGEN-S output. Visual Basic was chosen as the language for designing a plotting package using the classes and objects from the ProEssentials graphics package from GigaSoft.\* The result is the PlotOPUS plotting program. PlotOPUS will run on Windows 95/98/2000/NT platforms and does not require the user to have Visual Basic or ProEssentials installed to execute. The formatted ASCII output from OPUS can be read directly by PlotOPUS and displayed, modified, and saved as an image. Alternatively, the user may choose to read and process the OPUS output data using one of many other public or commercial graphics programs available to prepare plots of the data.

### 5.1 Plots of Dominant or Selected Isotopes or Elements

The plot display window of the selected or dominant nuclides from Sample Problem 1 (see Section 6.1) is shown in Figure 5.1. The title is displayed, along with labels for the axes and a legend. The nuclide or element symbols that are initially plotted (first 12, plus the total) are highlighted in the list box. Other nuclides or elements may be selected and plotted if desired. The selection is made in a similar manner to other Windows programs. If one or more materials have been selected, then holding down the <Shift> key to select another material will select all the materials between the last selection and the current selection. Holding down the <Ctrl> key will cause the selection of all previous materials selected and the material currently being selected, but not the ones between. A maximum of 20 nuclides or elements (plus total) may be displayed in any given plot. When the selections are completed, then the "Draw Graph" pushbutton is clicked, and the graph is displayed. The program automatically adjusts the Y-axis to the new range of data.

### 5.2 Plots of Neutron or Photon Spectra

The source spectrum plot display window of Sample Problem 3 is shown in Figure 5.2. The spectrum is displayed as a histogram for each energy group. The units are the default photon/s/MeV. The X-axis (MeV) is plotted with a linear scale, but is easily changed to log scale by clicking the "log" button on the toolbar. If there is a zero unit on the X-axis, the scale will not change to log. The user can still get a log scale by using the Customization Dialog, selecting the Axis Tab, and setting the minimum and maximum of the axis to exclude the zero. The histogram structure is generated by OPUS and does not require the plotting program to have an explicit histogram plotting capability.

---

\* Gigasoft, Inc., 206 Bear Hollow, Keller, TX, 76248  
<http://www.gigasoft.com>

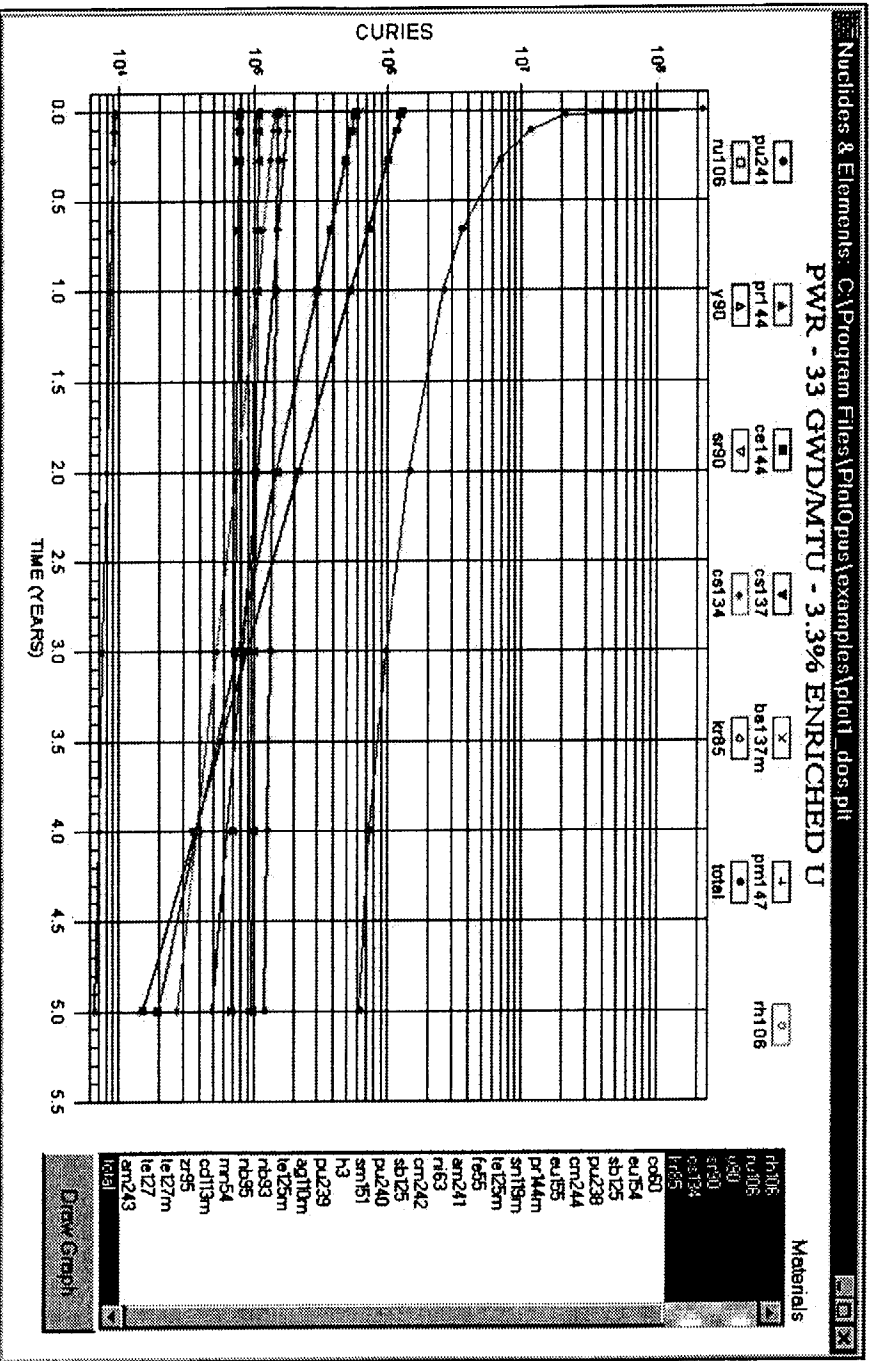

Figure 5.1 PlotOPUS default display window for selected or dominant nuclides

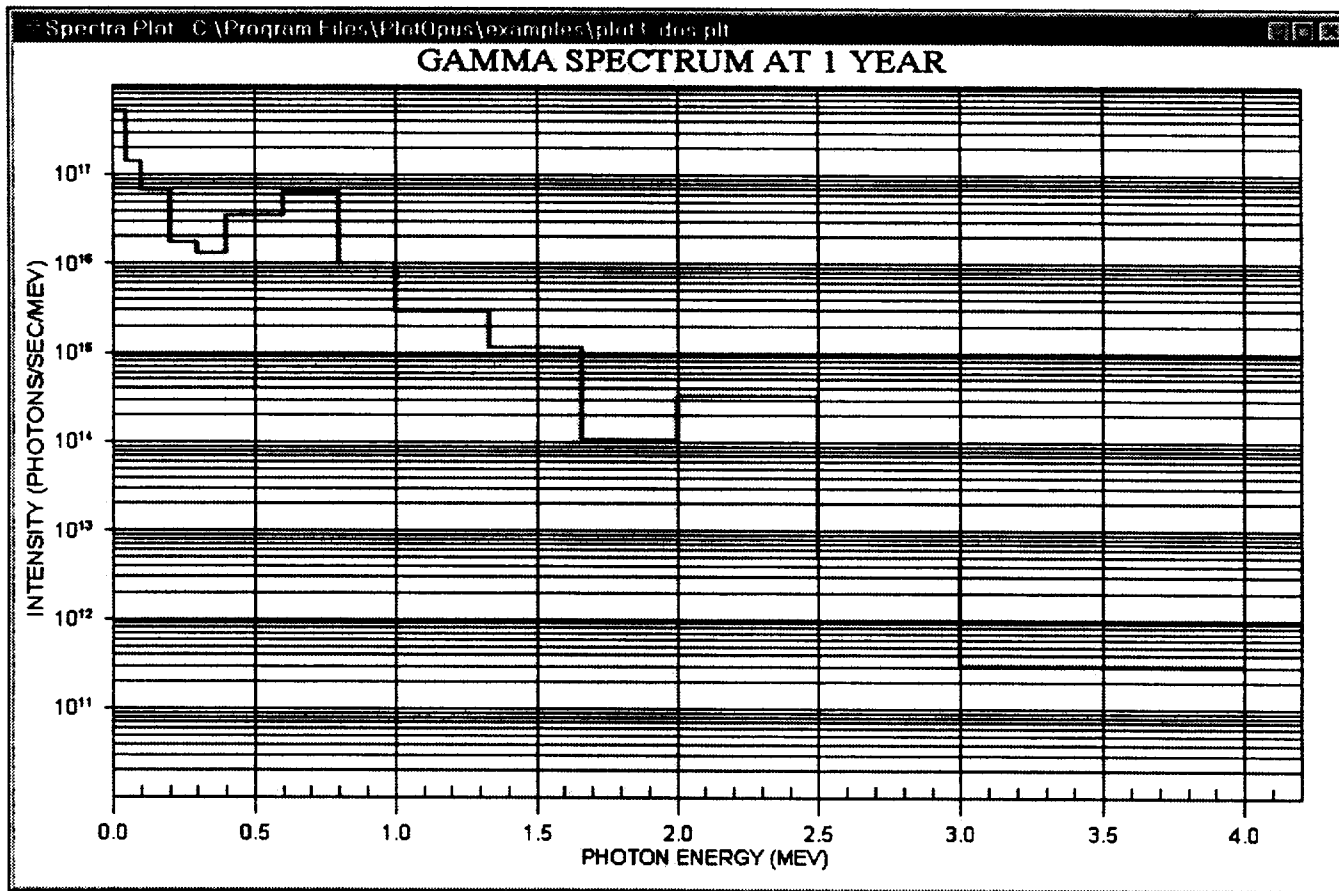

Figure 5.2 PlotOPUS display window for gamma spectrum plot

### 5.3 Plots of Case Comparisons

The case comparison plot of sample problem 5 is shown in Figure 5.3. A separate legend is included for each case. This plot compares the total decay heat generation for three different burnups for times from discharge to 5 years cooling.

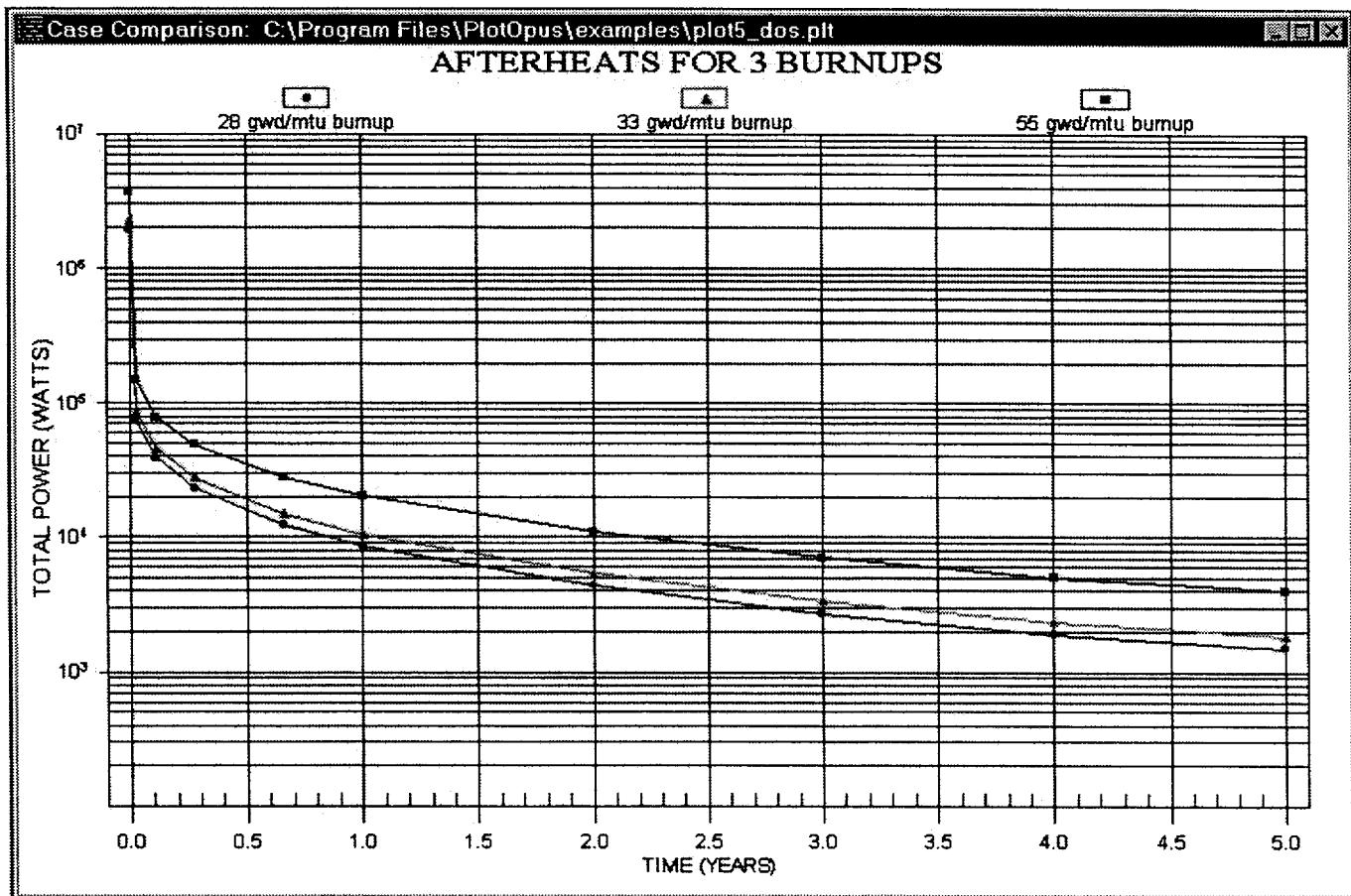

Figure 5.3 PlotOPUS display window for case comparison showing different case totals



## 5.4 Screen Descriptions

PlotOPUS is a multidocument interface (mdi) with a toolbar on the "parent" or main screen. There are three "children" screens:

- a screen displaying plots of selected or dominant nuclides or elements,
- a screen displaying plots of photon or neutron spectra, and
- a screen displaying plots comparing results from different cases.

Each time a new plot file is opened, a new screen for the associated plot type is opened as a child of the main screen. This sequence allows multiple plots to be visualized at the same time. The type of plot to be created is determined from plot commands in the ASCII plot file.

### 5.4.1 MDI Screen and Toolbar

When PlotOPUS is executed, the parent window is displayed. The pulldown file menu contains an exit, open, and a list of the five-most-recently-opened files. The open-file dialog box is displayed when open is selected. All plot files that have a "plt" extension are displayed in the file-open dialog box. The user may also open one of the most-recently-opened files by double-clicking it. PlotOPUS reads an initialization file, PlotOpus.ini, for information to initialize the list of previously opened files, along with the last directory that was accessed.

The PlotOPUS toolbar (Figure 5.4) is also located on the parent window and is available for use on all child windows. The "open" toolbar button will display the file-open dialog box. The "close" button will close the currently active child window. The "log x" and "lin x" buttons allow the user to navigate between a logarithmic scale and a linear scale on the x-axis. The next three buttons allow the user to save the plot in the currently selected child window to be saved as a **bitmap** (BMP), windows **metafile** (WMF), or a **JPEG** (JPG) file. The "copy" button copies the plot in the currently selected child window to the clipboard as a bitmap. The "print" button displays the print dialog box and allows the user to print the current plot. For the best results, the landscape mode should be selected. The portrait mode prints out a nice picture, but it is smaller than the plot printed in the landscape mode. The "setting" toolbar button stores the current environment settings such as colors and font. The default settings can be restored using the "default" button. The "?" button will display the HTML-format help file.



Figure 5.4 PlotOPUS toolbar

The color palette on the toolbar (Figure 5.5) allows the user to change the background and foreground colors of the graph. The small arrows allow the user to navigate forward and backward through an array of 256 colors. Black and white is always displayed. Clicking on one of the arrows will change the display to the next 32 colors or the previous 32 colors. The background color is selected with the right-mouse button, and the foreground color is selected with the left-mouse button. The code automatically changes the color of the graph, the form background color, the listbox background, the graph shadow color, and the desktop color. If the user desired a graph with one background color and another color surrounding it, he/she can achieve this by using the customization dialog described below.



Figure 5.5 PlotOPUS color palette

## 5.5 Customization of Plots

The user can customize all plots. If the user clicks on the right-mouse button while on a plot, a popup menu (Figure 5.6) with many customization features will appear. The user can experiment with this menu, then click the pushbutton labeled “Original,” and the original appearance of the plot will be restored. The popup menu lets the user modify:

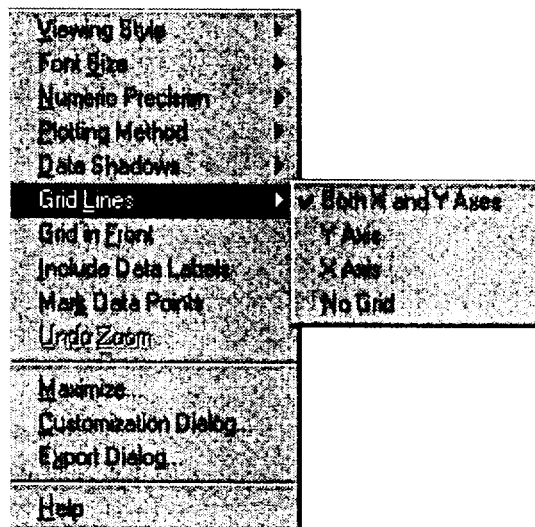

Figure 5.6 Popup menu

**Viewing Style:** All three types of plots are plotted using the Scientific Graph Object which supports three viewing styles: Color, Monochrome, and Monochrome with Symbols. This customization allows you to quickly adjust the image to best suit printing on a monochrome printer. If fewer than four subsets are to be included in a graph, then the Monochrome setting will probably be the best choice. If four or more subsets are to be included in the graph, then Monochrome with Symbols will help distinguish the different subsets.

**Font size:** The Scientific Graph Object supports three font sizes, Large, Medium, and Small. Depending on the size of the graph, the user can select the font size that is most readable. When printing the graph, a font size of Medium or Small is suggested. There are occasions (mainly when attempting to generate an image for a highly rectangular graph) when the graph may automatically reduce the size of the font in order to produce a higher quality image.

**Numeric Precision:** When placing data labels onto the graph, or exporting Text/Data from the Export Dialog, the number of decimal positions can be between 0 to 7, inclusive. Depending on the implementation, the maximum precision may vary.

**Plotting Method:** PlotOPUS uses Pro Essentials Scientific Graph Object to plot the data. The ESPN uses five plotting methods supported by the Scientific Graph Object: points, lines, lines and points, bar, and sticks.

**Grid Lines:** This option offers the user several choices for displaying grid lines on plots. The user can display vertical grid lines, horizontal grid lines, both vertical and horizontal grid lines, or no grid lines.

**Data Labels:** This option will cause a label containing the point's value to be placed next to each point.

**Mark Data Points:** When this option is selected, the points will be marked with a dot.

**Undo Zoom:** This option is only available after the user has zoomed an area of the plot. Clicking on this option will then return the plot to the view of the plot before the zooming.

**Maximize:** Selecting this option will maximize the window containing the current plot. The plot will fill the entire screen.

**Customization Dialog:** Double-clicking the mouse over the plot, or pressing spacebar while the plot has the input focus will show the customization dialog (Figure 5.7). All plots have their own individual customization dialogs. The customization dialogs allow the user to adjust visual and functional attributes of the object as well as gain access to the Export and Maximization dialogs.

All objects store two sets of customization parameters. The first set is known as the Original set. The Original set is programmed into the control and the user can not adjust these parameters. The second set is called the Custom set. The Custom set can be adjusted through the customization dialog. **While the plot has the input focus, pressing T will toggle between the Original and Custom parameter sets.**

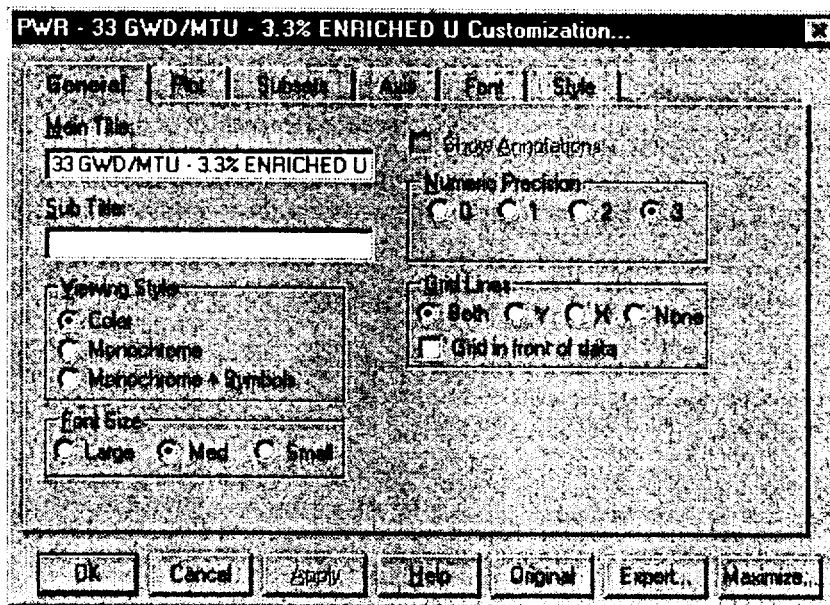

Figure 5.7 Customization dialog

### 5.6 Zoom Feature

A zoom feature is available on all the plots. The user defines the area to be zoomed by dragging the mouse with the left-mouse button depressed to draw a rectangle around the plot-area to be zoomed (Figure 5.8). When the user lets the mouse button up, the area defined is zoomed automatically in the window (Figure 5.9). The user may return to the previous view by pressing the "z" key or clicking the right-mouse button to display the popup menu and clicking on "undo zoom."

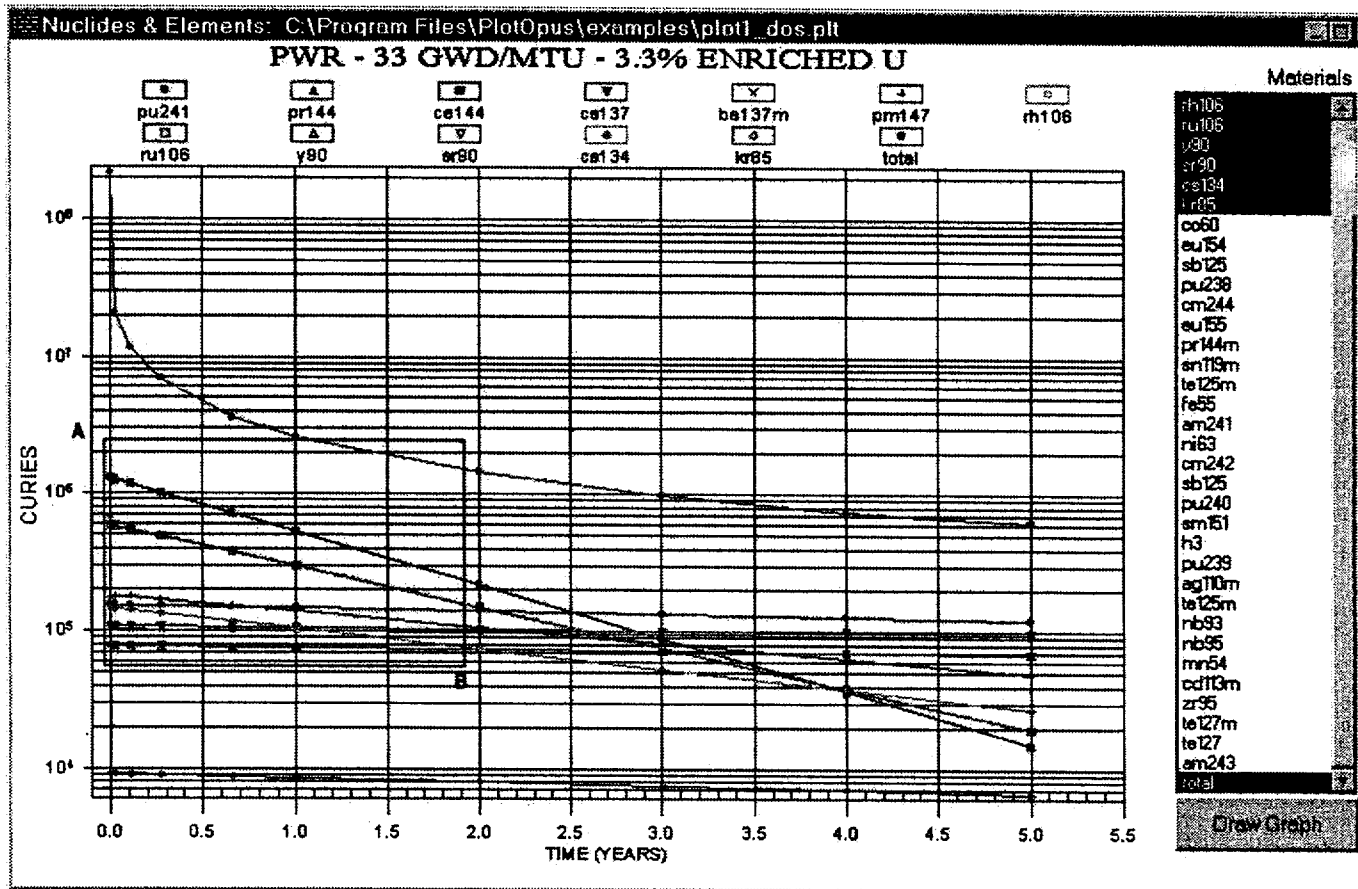

Figure 5.8 Plot showing zoomed rectangle area



## 6 SAMPLE PROBLEMS

Seven sample problems are included to illustrate the various types of data plots and plotting options that can be requested. Examples of final plots created with the Visual Basic graphics program PlotOPUS are also included. Three ORIGEN-S cases are needed for these sample problems. The input data for the ORIGEN-S cases are listed in Appendix A. The last two ORIGEN-S cases are needed for sample problems 5 and 6 only. The three cases are identical, except that the burnups are 33, 28, and 55 GWd/MTU and the output concentration data files are saved in data sets on logical unit Nos. 71, 72, and 73, respectively. Note that these cases are intended for plotting demonstration purposes only. The output from these cases is saved after 352 and 880 days irradiation and at all time-steps during the 100-year-decay period.

The input data for all sample problems are listed and described in this section. The printed output for sample problem 1, the plot data generated for all problems, and plots made using the Visual Basic graphics program PlotOPUS are included.

### 6.1 Sample Problem 1

This case demonstrates application of default values for all input parameters. No keywords or other input are specified in the input. The activity of spent fuel, in units of curies (Ci), irradiated to 33 GWd/MTU, is tabulated for decay times between discharge and 5 years. The data file containing the 33 GWd/MTU compositions is on logical unit No. 71, and the title applied in the plot file will be the same as that in the ORIGEN-S case. The input file for this case (executed through SCALE system) is as follows:

```
=opus  
[ blank line ]  
end
```

The input (blank line) is delimited only by the job initiation entry (=OPUS) and the job terminator (END), which must start in column 1. The 40 dominant ranking nuclides in the interval from 0.4 to 5 years decay are printed in descending order of importance. The total printed both in the output and plot files represents the sum of the curies for all nuclides in the specified library-type LIBTYPE (in this case all actinide, fission-product, and activation-product nuclides). The subtotal is printed in the output file only, and it represents the sum over only the top 40 printed nuclides. The output generated by OPUS for this problem is described in Section 6.11.

## 6.2 Sample Problem 2

Sample problem 2 creates plot data for the toxicity in water (RCG values) for the dominant nuclides in the actinide and fission-product libraries only. The plot data are requested over the decay time range of 100 days to 30 years using the MINPOSITION and MAXPOSITION parameters, and importance ranking is over the range of 1 to 20 years. In addition to the dominant nuclides, data for  $^{242}\text{Cm}$ ,  $^{137\text{m}}\text{Ba}$ , and  $^{99}\text{Tc}$  are specifically requested. The total number of nuclides requested is 20. The X-axis label is set to "TIME (YEARS)," and the title is "SPENT FUEL AT 33 GWD/MTHM." The plot data can be generated with the following input:

```
=opus
units=h2om**3
time=year  typarms=nucl
tmin=1.0  tmax=20  libtyp=fisact
minpos=6  maxpos=16  nrank=20
title=spent fuel at 33 gwd/mthm
xlabel=time (years)
symnuc=cm-242 ba-137m tc-99 end
end
```

## 6.3 Sample Problem 3

Sample problem 3 generates plot data of the photon spectrum after 1-year decay time produced by all nuclides (fission products, actinides, and activation products), as computed for the group structure in the 83\* array of the 33-GWd/MTU ORIGEN-S case. The units of the photon spectrum output will be the default spectrum units of photons/(s MeV), and a maximum energy of 3.5 MeV is specified. The title for the case is "GAMMA SPECTRUM AT 1 YEAR." Note that the array delimiter END is required after the NPOSITION entry, even though only one position is specified. The input to generate the plot data is as follows:

```
=opus
typarms=gspect  emax=3.5
units=photons/sec/mev  npos=8 end
title=gamma spectrum at 1 year
end
```

## 6.4 Sample Problem 4

Sample problem 4 plots the total neutron spectrum at 1-year decay time from the 33-GWd/MTU ORIGEN-S case. The data set is selected for this problem using the case number and step number. Note that the END is required after the step number specification since NSTEP is an array keyword. The maximum energy of the spectrum is set to 20 MeV. The title for the case is "NEUTRON SPECTRUM AT 1 YEAR." The input to generate the plot data is as follows:

```

=opus
typarms=nspect   emax=20
casnumber=2      nstep=5 end
title=neutron spectrum at 1 year
end

```

## 6.5 Sample Problem 5

Sample problem 5 compares the decay heat from the three ORIGEN-S cases for cooling times between 0 and 5 years. The first case legend line is "28 GWd/MTU BURNUP," and the ORIGEN-S compositions are on logical unit No. 72. The legends and logical unit Nos. for the 33- and 55-GWd/MTU cases are set. The title for the case is "DECAY HEATS FOR 3 BURNUPS." The input to generate the plot data is as follows:

```

=opus
units=watts
typarms=totals
ncases=3
ndataset=1 numunit=72 legend= 28 gwd/mtu burnup
ndataset=2 numunit=71 legend= 33 gwd/mtu burnup
ndataset=3 numunit=73 legend= 55 gwd/mtu burnup
title=afterheats for 3 burnups
end

```

## 6.6 Sample Problem 6

Sample problem 6 is similar to problem 5, except that it compares the decay heat from only  $^{242}\text{Cm}$  from the three ORIGEN-S cases. The title for the case is "CM-242 AS A FUNCTION OF BURNUP." The input to generate the plot data is as follows:

```

=opus
units=watts  typaram=totals  ncas=3
symnuc=cm-242 end
ndataset=1 numunit=72 legend= 28 gwd/mtu burnup
ndataset=2 numunit=71 legend= 33 gwd/mtu burnup
ndataset=3 numunit=73 legend= 55 gwd/mtu burnup
title=cm-242 as function of burnup
end

```

## 6.7 Sample Problem 7

Sample problem 7 compares the total decay heat from the 33-GWd/MTU ORIGEN-S case with data points input by the user. The legend for the user input data is "28 GWd/MTU FROM USER DATA," and the other legend is "33 GWd/MTU BURNUP." The title for the case is "DECAY HEAT COMPARISONS." Note that a legend for the user input data can be set using the data set position number immediately after the last case (e.g., for



NCASE=3, the user legend could be specified by setting LEGEND= after setting NDATASET= NCASE+1). The input to generate the plot data is as follows:

```
=opus
title=decay heat comparisons
units=watts  typarms=totals  ncases=1
xinp=0 0.082 0.493 1 3 5 end
yinp=1.8+6 4.5+4 1.55+4 8.63+3 2.80+3 1.52+3 end
ndataset=1  numunit=71 legend=33 gwd/mtu burnup
ndataset=2  legend=28 gwd/mtu user data
end
```

## 6.8 Sample Problem 8

Sample problem 8 generates plot data of element mass in grams for the 30 most abundant actinides in spent fuel from the 33-GWd/MTU ORIGEN-S case between discharge and 2-years cooling time. The user-specified elements to be included in the plot data are U, Pu, Np, Am, and Cm. The plot data can be generated from the following input:

```
=opus
units=grams
timeunit=year
typarms=elements
ncompare=30
tmin=1
tmax=2
libtyp=act
title=spent fuel at 33 gwd/mthm
xlabel=cooling time (years)
symnuc=u pu np am cm end
end
```

## 6.9 Sample Problem 9

Sample problem 9 generates the isotopic weight percent of uranium and plutonium in the fuel for cooling times up to 5 years for the 33-GWd/MTU ORIGEN-S case. No totals are printed for the weight or atom percent plot data. The plot data can be generated from the following input:

```
=opus
units=wpel
libtyp=act
title=spent fuel at 33 gwd/mthm
symnuc=u pu end
end
```

## 6.10 Sample Problem 10

Sample problem 10 generates plot data for a user-specified response function. The response conversion factor data are entered in the RESPONSE= array as nuclide-response factor pairs. In this example, it is assumed that the response factors are activity based (response/Bq of nuclide), and thus the units of Bequerels are requested using the UNITS keyword. The user-supplied response conversion factors are applied to the Bequerel units for all nuclides in the RESPONSE= array, and the results for any nuclide for which no response factors are provided are zeroed. The plot data can be generated from the following input:

```
=opus
units=bequ
timeunit=year  tmax= 5
typarms=nucl nrank=21
libtyp=all
title=pwr spent fuel - 33 gwd/mtu
xlabel=cooling time (years)
symnuc= ag-110m am-241 ba-137m cf-252 cm-242 cm-244
        cm-246 cm-248 co-60 cs-134 eu-152 eu-154
        nb-94 pr-144 pu-238 pu-239 pu-240 pu-242
        rh-106 u-238 y-90  end
response=
270600 1.92027E+00 962460 2.27711E-01 481151 1.64222E-01
822100 5.19246E-12 962470 1.75728E-09 501230 3.81237E-02
832101 9.43341E-09 962480 1.05672E+00 511240 1.53438E+02
882260 1.51600E-05 962500 1.60583E+02 511250 1.81023E-04
892270 1.67080E-05 982490 2.21420E-04 511260 5.13360E+00
902280 2.06832E-02 982500 2.87199E+02 511261 2.83053E+03
902290 3.68234E-06 982510 5.69935E-05 521271 2.09452E-08
902300 2.96815E-07 982520 6.08179E+04 541270 2.62508E-06
912310 8.85771E-07 982540 3.23433E+07 521291 1.67426E-02
922320 5.28737E-04 992540 9.06836E-02 551340 2.51483E-01
922330 1.58874E-07 992550 2.14635E+03 561371 3.65115E+02
922340 9.80458E-08 300690 5.84377E-03 591420 2.67150E+02
932350 3.74560E-07 300691 7.58469E-05 591440 2.49043E+04
932370 1.06411E-08 300710 7.15053E+03 591441 4.50622E+00
942360 1.79142E-02 300711 1.26926E+00 611460 1.51726E-04
942370 1.32726E-05 360850 1.00485E-09 611481 3.68460E+00
942380 5.27078E-04 390891 2.21056E+05 631520 2.73664E-01
942390 1.35127E-06 390900 1.81448E+00 631540 1.85327E-01
942400 3.07865E-05 390910 4.63971E-02 651600 3.99308E+00
942420 4.34174E-05 410940 5.41278E-06 671661 2.38283E-04
942440 4.74386E-05 400950 1.25539E-02 701690 1.31039E-06
952410 9.52943E-05 410950 2.38235E-02 691700 1.86381E-06
952421 5.13070E-06 430980 1.16294E-09 681710 2.97728E+00
952430 4.88414E-06 441030 9.59447E-04
962410 6.06856E-03 451060 4.50010E+05
962420 6.49663E-01 451061 3.89038E+04
962430 1.85524E-03 471081 2.84967E-05
962440 2.85572E-01 471101 9.07809E+00
962450 5.67331E-06 491141 6.89978E-04 end
end
```

## 6.11 Printed Output

The printed output from OPUS for sample problem 1 is listed and discussed. Figure 6.1 lists the header page containing the program name, the user name, and the time and date of problem execution. The program verification information block for quality-assurance purposes follows this information.

The printed results table for sample problem 1 is listed in Figure 6.2. It contains the dominant nuclides for the case printed in descending order of importance. The formats of the nuclide- and element-type plots and case comparison (or totals) plots are the same. However, for case-comparison-type plots the print tables are generated for all cases being compared, and only the totals are printed to the plot file. The printed "total" in the table represents the sum of the curies for all nuclides in the specified library type LIBTYPE (in this case all actinides, fission products, and activation products). For an entry of LIBTYPE=ACT, the total would represent the sum over all actinides only. The "subtotal" represents the sum over only the printed nuclides in the output and plot files. Note that the plot data file does not include the "subtotal," only the "total."

For neutron and photon spectral-type plots the printed output contains the energy-group ranges and intensities of the spectrum. An example of the printed output table for the neutron spectrum case of sample problem 4 is listed in Figure 6.3.

## 6.12 Plot Data File

The formats of the plot data files created by OPUS and as used by PlotOPUS are given in Appendix B. The plot output files for sample problems 1 through 10 are listed in Figures 6.4 through 6.13. The plots for several of these cases, as generated by PlotOPUS, are shown in Figures 6.14 through 6.18. PlotOPUS is an interactive Visual Basic program design for use on Windows PCs. However, the plot files produced by OPUS are formatted such that they can be easily input to most any graphics program or spreadsheet as an alternative to using PlotOPUS, if desired.



pwr - 33 gwd/mtu - 3.3% enriched u  
units of concentrations: curies

nuclide	time (years)									
	0.000E+00	2.738E-02	1.095E-01	2.738E-01	6.571E-01	1.000E+00	2.000E+00	3.000E+00	4.000E+00	5.000E+00
pu241	1.538E+05	1.536E+05	1.530E+05	1.518E+05	1.490E+05	1.466E+05	1.397E+05	1.331E+05	1.268E+05	1.208E+05
pr144	1.284E+06	1.243E+06	1.156E+06	9.988E+05	7.105E+05	5.239E+05	2.155E+05	8.862E+04	3.645E+04	1.499E+04
ce154	1.274E+06	1.243E+06	1.156E+06	9.988E+05	7.105E+05	5.239E+05	2.155E+05	8.862E+04	3.645E+04	1.499E+04
cs137	1.085E+05	1.084E+05	1.082E+05	1.078E+05	1.069E+05	1.060E+05	1.036E+05	1.012E+05	9.894E+04	9.668E+04
ba137m	1.033E+05	1.024E+05	1.022E+05	1.018E+05	1.009E+05	1.001E+05	9.784E+04	9.561E+04	9.342E+04	9.129E+04
pm147	1.745E+05	1.768E+05	1.764E+05	1.695E+05	1.532E+05	1.399E+05	1.074E+05	8.247E+04	6.332E+04	4.862E+04
rh106	6.567E+05	5.734E+05	5.422E+05	4.848E+05	3.734E+05	2.956E+05	1.496E+05	7.569E+04	3.830E+04	1.938E+04
ru106	5.842E+05	5.734E+05	5.422E+05	4.848E+05	3.734E+05	2.956E+05	1.496E+05	7.569E+04	3.830E+04	1.938E+04
y90	8.093E+04	7.770E+04	7.732E+04	7.698E+04	7.626E+04	7.561E+04	7.378E+04	7.198E+04	7.023E+04	6.852E+04
sr90	7.748E+04	7.743E+04	7.727E+04	7.696E+04	7.624E+04	7.560E+04	7.376E+04	7.196E+04	7.021E+04	6.850E+04
cs134	1.464E+05	1.451E+05	1.411E+05	1.335E+05	1.174E+05	1.046E+05	7.474E+04	5.340E+04	3.815E+04	2.726E+04
kr85	9.098E+03	9.084E+03	9.036E+03	8.941E+03	8.722E+03	8.531E+03	7.996E+03	7.496E+03	6.982E+03	6.587E+03
co60	7.077E+03	7.052E+03	6.976E+03	6.827E+03	6.491E+03	6.205E+03	5.440E+03	4.770E+03	4.182E+03	3.666E+03
eu154	5.991E+03	5.977E+03	5.938E+03	5.860E+03	5.681E+03	5.526E+03	5.098E+03	4.703E+03	4.338E+03	4.002E+03
sb125	8.182E+03	8.151E+03	8.005E+03	7.680E+03	6.968E+03	6.387E+03	4.955E+03	3.844E+03	2.982E+03	2.313E+03
pu238	2.278E+03	2.309E+03	2.331E+03	2.366E+03	2.418E+03	2.441E+03	2.455E+03	2.443E+03	2.425E+03	2.407E+03
cm244	2.206E+03	2.212E+03	2.205E+03	2.191E+03	2.159E+03	2.131E+03	2.051E+03	1.974E+03	1.899E+03	1.828E+03
eu155	2.589E+03	2.578E+03	2.547E+03	2.486E+03	2.349E+03	2.233E+03	1.925E+03	1.660E+03	1.432E+03	1.235E+03
pr144m	1.789E+04	1.741E+04	1.618E+04	1.398E+04	9.947E+03	7.335E+03	3.017E+03	1.241E+03	5.103E+02	2.099E+02
sn119m	1.215E+04	1.186E+04	1.105E+04	9.588E+03	6.885E+03	5.120E+03	2.158E+03	9.096E+02	3.834E+02	1.616E+02
te125m	1.726E+03	1.743E+03	1.777E+03	1.789E+03	1.685E+03	1.556E+03	1.210E+03	9.387E+02	7.282E+02	5.649E+02
fe55	1.989E+03	1.975E+03	1.934E+03	1.855E+03	1.683E+03	1.543E+03	1.197E+03	9.285E+02	7.203E+02	5.588E+02
am241	1.280E+02	1.347E+02	1.549E+02	1.950E+02	2.872E+02	3.682E+02	5.968E+02	8.141E+02	1.021E+03	1.217E+03
ni63	5.820E+02	5.819E+02	5.815E+02	5.809E+02	5.793E+02	5.780E+02	5.740E+02	5.700E+02	5.661E+02	5.622E+02
cm242	3.912E+04	3.775E+04	3.323E+04	2.575E+04	1.420E+04	8.337E+03	1.768E+03	3.792E+02	8.533E+01	2.316E+01
sb125	1.048E+03	1.041E+03	1.020E+03	9.786E+02	8.878E+02	8.138E+02	6.313E+02	4.898E+02	3.799E+02	2.947E+02
pu240	4.435E+02	4.435E+02	4.435E+02	4.436E+02	4.436E+02	4.437E+02	4.439E+02	4.440E+02	4.442E+02	4.443E+02
sm151	4.173E+02	4.246E+02	4.244E+02	4.239E+02	4.226E+02	4.215E+02	4.183E+02	4.151E+02	4.119E+02	4.087E+02
h3	4.864E+02	4.857E+02	4.834E+02	4.790E+02	4.688E+02	4.598E+02	4.347E+02	4.109E+02	3.885E+02	3.672E+02
pu239	3.254E+02	3.309E+02	3.312E+02	3.312E+02	3.312E+02	3.312E+02	3.312E+02	3.312E+02	3.312E+02	3.311E+02
ag110m	3.589E+03	3.491E+03	3.212E+03	2.719E+03	1.844E+03	1.302E+03	4.726E+02	1.715E+02	6.224E+01	2.259E+01
te125m	2.230E+02	2.250E+02	2.286E+02	2.289E+02	2.149E+02	1.983E+02	1.542E+02	1.196E+02	9.278E+01	7.198E+01
nb93	7.180E+01	7.171E+01	7.146E+01	7.096E+01	6.980E+01	6.879E+01	6.590E+01	6.314E+01	6.049E+01	5.795E+01
nb95	1.667E+06	1.647E+06	1.466E+06	9.588E+05	2.531E+05	6.813E+04	1.374E+03	2.638E+01	5.055E-01	9.686E-03
mn54	4.515E+02	4.416E+02	4.131E+02	3.616E+02	2.650E+02	2.006E+02	8.917E+01	3.962E+01	1.761E+01	7.825E+00
cd113m	2.834E+01	2.831E+01	2.820E+01	2.797E+01	2.745E+01	2.699E+01	2.570E+01	2.447E+01	2.329E+01	2.217E+01
zr95	1.648E+06	1.479E+06	1.069E+06	5.580E+05	1.225E+05	3.157E+04	6.050E+02	1.159E+01	2.222E-01	4.257E-03
te127m	1.512E+04	1.465E+04	1.218E+04	8.319E+03	3.415E+03	1.540E+03	1.510E+02	1.480E+01	1.450E+00	1.422E-01
te127	8.990E+04	2.828E+04	1.200E+04	8.148E+03	3.345E+03	1.508E+03	1.479E+02	1.449E+01	1.421E+00	1.392E-01
am243	2.112E+01	2.115E+01	2.115E+01	2.115E+01	2.115E+01	2.115E+01	2.115E+01	2.115E+01	2.114E+01	2.114E+01
total	2.203E+08	2.107E+07	1.146E+07	6.868E+06	3.580E+06	2.585E+06	1.447E+06	9.737E+05	7.412E+05	6.179E+05
subtotal	8.181E+06	7.760E+06	6.899E+06	5.415E+06	3.405E+06	2.553E+06	1.447E+06	9.736E+05	7.411E+05	6.178E+05

nuclides are listed in descending order of the integral of log(x) dt over the time interval 4.098E-01 to 5.010E+00.

Figure 6.2 Printed output data from sample problem 1

```

time 1.0 years
neutron spectrum at 1 year
neutron energy (mev)      intensity (neutrons/sec/mev)
1.000E-11 to 1.000E-08      0.0000E+00
1.000E-08 to 3.000E-08      0.0000E+00
3.000E-08 to 5.000E-08      0.0000E+00
5.000E-08 to 1.000E-07      0.0000E+00
1.000E-07 to 2.250E-07      0.0000E+00
2.250E-07 to 3.250E-07      0.0000E+00
3.250E-07 to 4.000E-07      0.0000E+00
4.000E-07 to 8.000E-07      0.0000E+00
8.000E-07 to 1.000E-06      0.0000E+00
1.000E-06 to 1.130E-06      0.0000E+00
1.130E-06 to 1.300E-06      0.0000E+00
1.300E-06 to 1.770E-06      0.0000E+00
1.770E-06 to 3.050E-06      0.0000E+00
3.050E-06 to 1.000E-05      0.0000E+00
1.000E-05 to 3.000E-05      0.0000E+00
3.000E-05 to 1.000E-04      0.0000E+00
1.000E-04 to 5.500E-04      0.0000E+00
5.500E-04 to 3.000E-03      0.0000E+00
3.000E-03 to 1.700E-02      0.0000E+00
1.700E-02 to 1.000E-01      0.0000E+00
1.000E-01 to 4.000E-01      4.4906E+07
4.000E-01 to 9.000E-01      1.3747E+08
9.000E-01 to 1.400E+00      1.2587E+08
1.400E+00 to 1.850E+00      1.0402E+08
1.850E+00 to 3.000E+00      7.5309E+07
3.000E+00 to 6.434E+00      2.2995E+07
6.434E+00 to 2.000E+01      4.8486E+05

```

Figure 6.3 Printed output data from sample problem 4

```

pwr - 33 gwd/mtu - 3.3% enriched u
time (years)
curies
nuclide
  10      41
0.000E+00 2.738E-02 1.095E-01 2.738E-01 6.571E-01 1.000E+00 2.000E+00 3.000E+00 4.000E+00 5.000E+00
pu241    1.538E+05 1.536E+05 1.530E+05 1.518E+05 1.490E+05 1.466E+05 1.397E+05 1.331E+05 1.268E+05 1.208E+05
pr144    1.284E+06 1.243E+06 1.156E+06 9.988E+05 7.105E+05 5.239E+05 2.155E+05 8.862E+04 3.645E+04 1.499E+04
ce144    1.274E+06 1.243E+06 1.156E+06 9.988E+05 7.105E+05 5.239E+05 2.155E+05 8.862E+04 3.645E+04 1.499E+04
cs137    1.085E+05 1.084E+05 1.082E+05 1.078E+05 1.069E+05 1.060E+05 1.036E+05 1.012E+05 9.894E+04 9.668E+04
ba137m   1.033E+05 1.024E+05 1.022E+05 1.018E+05 1.009E+05 1.001E+05 9.784E+04 9.561E+04 9.342E+04 9.129E+04
pm147    1.745E+05 1.768E+05 1.764E+05 1.695E+05 1.532E+05 1.399E+05 1.074E+05 8.247E+04 6.332E+04 4.862E+04
rh106    6.567E+05 5.734E+05 5.422E+05 4.848E+05 3.734E+05 2.956E+05 1.496E+05 7.569E+04 3.830E+04 1.938E+04
ru106    5.842E+05 5.734E+05 5.422E+05 4.848E+05 3.734E+05 2.956E+05 1.496E+05 7.569E+04 3.830E+04 1.938E+04
y90      8.093E+04 7.770E+04 7.732E+04 7.698E+04 7.626E+04 7.561E+04 7.378E+04 7.198E+04 7.023E+04 6.852E+04
sr90     7.748E+04 7.743E+04 7.727E+04 7.696E+04 7.624E+04 7.560E+04 7.376E+04 7.196E+04 7.021E+04 6.850E+04
cs134    1.464E+05 1.451E+05 1.411E+05 1.335E+05 1.174E+05 1.046E+05 7.474E+04 5.340E+04 3.815E+04 2.726E+04
kr85     9.098E+03 9.084E+03 9.036E+03 8.941E+03 8.722E+03 8.531E+03 7.996E+03 7.496E+03 7.026E+03 6.587E+03
co60     7.077E+03 7.052E+03 6.976E+03 6.827E+03 6.491E+03 6.205E+03 5.440E+03 4.770E+03 4.182E+03 3.666E+03
eu154    5.991E+03 5.977E+03 5.938E+03 5.860E+03 5.681E+03 5.526E+03 5.098E+03 4.703E+03 4.338E+03 4.002E+03
sb125    8.182E+03 8.151E+03 8.005E+03 7.680E+03 6.968E+03 6.387E+03 4.955E+03 3.844E+03 2.982E+03 2.313E+03
pu238    2.278E+03 2.309E+03 2.331E+03 2.366E+03 2.418E+03 2.441E+03 2.455E+03 2.443E+03 2.425E+03 2.407E+03
cm244    2.206E+03 2.212E+03 2.205E+03 2.191E+03 2.159E+03 2.131E+03 2.051E+03 1.974E+03 1.899E+03 1.828E+03
eu155    2.589E+03 2.578E+03 2.547E+03 2.486E+03 2.349E+03 2.233E+03 1.925E+03 1.660E+03 1.432E+03 1.235E+03
pr144m   1.789E+04 1.741E+04 1.618E+04 1.398E+04 9.947E+03 7.335E+03 3.017E+03 1.241E+03 5.103E+02 2.099E+02
sn119m  1.215E+04 1.186E+04 1.105E+04 9.588E+03 6.885E+03 5.120E+03 2.158E+03 9.096E+02 3.834E+02 1.616E+02
tel125m  1.726E+03 1.743E+03 1.777E+03 1.789E+03 1.685E+03 1.556E+03 1.210E+03 9.387E+02 7.282E+02 5.649E+02
fe55     1.989E+03 1.975E+03 1.934E+03 1.855E+03 1.683E+03 1.543E+03 1.197E+03 9.285E+02 7.203E+02 5.588E+02
am241    1.280E+02 1.347E+02 1.549E+02 1.950E+02 2.872E+02 3.682E+02 5.968E+02 8.141E+02 1.021E+03 1.217E+03
ni63     5.820E+02 5.819E+02 5.815E+02 5.809E+02 5.793E+02 5.780E+02 5.740E+02 5.700E+02 5.661E+02 5.622E+02
cm242    3.912E+04 3.775E+04 3.323E+04 2.575E+04 1.420E+04 8.337E+03 1.768E+03 3.792E+02 8.533E+01 2.316E+01
sb125    1.048E+03 1.041E+03 1.020E+03 9.786E+02 8.878E+02 8.138E+02 6.313E+02 4.898E+02 3.799E+02 2.947E+02
pu240    4.435E+02 4.435E+02 4.435E+02 4.436E+02 4.436E+02 4.437E+02 4.439E+02 4.440E+02 4.442E+02 4.443E+02
sm151    4.173E+02 4.246E+02 4.244E+02 4.239E+02 4.226E+02 4.215E+02 4.183E+02 4.151E+02 4.119E+02 4.087E+02
h3       4.864E+02 4.857E+02 4.834E+02 4.790E+02 4.688E+02 4.598E+02 4.347E+02 4.109E+02 3.885E+02 3.672E+02
pu239    3.254E+02 3.309E+02 3.312E+02 3.312E+02 3.312E+02 3.312E+02 3.312E+02 3.312E+02 3.312E+02 3.311E+02
ag110m  3.589E+03 3.491E+03 3.212E+03 2.719E+03 1.844E+03 1.302E+03 4.726E+02 1.715E+02 6.224E+01 2.259E+01
tel125m  2.230E+02 2.250E+02 2.286E+02 2.289E+02 2.149E+02 1.983E+02 1.542E+02 1.196E+02 9.278E+01 7.198E+01
nb93     7.180E+01 7.171E+01 7.146E+01 7.096E+01 6.980E+01 6.879E+01 6.590E+01 6.314E+01 6.049E+01 5.795E+01
nb95     1.667E+06 1.647E+06 1.466E+06 9.588E+05 2.531E+05 6.813E+04 1.374E+03 2.638E+01 5.055E-01 9.686E-03
mn54     4.515E+02 4.416E+02 4.131E+02 3.616E+02 2.650E+02 2.006E+02 8.917E+01 3.962E+01 1.761E+01 7.825E+00
cd113m  2.834E+01 2.831E+01 2.820E+01 2.797E+01 2.745E+01 2.699E+01 2.570E+01 2.447E+01 2.329E+01 2.217E+01
zr95     1.648E+06 1.479E+06 1.069E+06 5.580E+05 1.225E+05 3.157E+04 6.050E+02 1.159E+01 2.222E-01 4.257E-03
tel127m  1.512E+04 1.465E+04 1.218E+04 8.319E+03 3.415E+03 1.540E+03 1.510E+02 1.480E+01 1.450E+00 1.422E-01
tel127  8.990E+04 2.828E+04 1.200E+04 8.148E+03 3.345E+03 1.508E+03 1.508E+03 1.479E+02 1.449E+01 1.421E+00 1.392E-01
am243    2.112E+01 2.115E+01 2.115E+01 2.115E+01 2.115E+01 2.115E+01 2.115E+01 2.115E+01 2.115E+01 2.114E+01 2.114E+01
total    2.203E+08 2.107E+07 1.146E+07 6.868E+06 3.580E+06 2.585E+06 1.447E+06 9.737E+05 7.412E+05 6.179E+05

```

Figure 6.4 Plot file generated for sample problem 1

```

spent fuel at 33 gwd/mthm
time (years)
toxicity (cubic meters water)
nuclide
  11      21
sr90      2.738E-01 6.571E-01 1.000E+00 2.000E+00 3.000E+00 4.000E+00 5.000E+00 1.000E+01 1.500E+01 2.000E+01 3.000E+01
cs137     2.565E+11 2.541E+11 2.520E+11 2.459E+11 2.399E+11 2.340E+11 2.283E+11 2.019E+11 1.785E+11 1.578E+11 1.234E+11
y90       5.392E+09 5.344E+09 5.302E+09 5.181E+09 5.062E+09 4.947E+09 4.834E+09 4.306E+09 3.837E+09 3.418E+09 2.713E+09
cs134     3.849E+09 3.813E+09 3.781E+09 3.689E+09 3.599E+09 3.512E+09 3.426E+09 3.029E+09 2.678E+09 2.368E+09 1.851E+09
pu241     1.484E+10 1.304E+10 1.162E+10 8.304E+09 5.933E+09 4.239E+09 3.029E+09 5.641E+08 1.050E+08 1.956E+07 6.780E+05
pu238     7.590E+08 7.451E+08 7.328E+08 6.983E+08 6.653E+08 6.340E+08 6.041E+08 4.744E+08 3.726E+08 2.927E+08 1.805E+08
am241     4.733E+08 4.836E+08 4.882E+08 4.911E+08 4.886E+08 4.851E+08 4.813E+08 4.627E+08 4.449E+08 4.277E+08 3.953E+08
cm244     4.875E+07 7.180E+07 9.206E+07 1.492E+08 2.035E+08 2.552E+08 3.043E+08 5.160E+08 6.801E+08 8.067E+08 9.783E+08
eu154     3.130E+08 3.084E+08 3.044E+08 2.930E+08 2.819E+08 2.714E+08 2.612E+08 2.156E+08 1.781E+08 1.470E+08 1.003E+08
pu240     2.930E+08 2.841E+08 2.763E+08 2.549E+08 2.351E+08 2.169E+08 2.001E+08 1.337E+08 8.929E+07 5.964E+07 2.662E+07
pu239     8.871E+07 8.872E+07 8.874E+07 8.877E+07 8.881E+07 8.884E+07 8.887E+07 8.900E+07 8.909E+07 8.917E+07 8.925E+07
pm147     6.624E+07 6.624E+07 6.624E+07 6.623E+07 6.623E+07 6.623E+07 6.623E+07 6.622E+07 6.621E+07 6.620E+07 6.619E+07
ru106     8.474E+08 7.658E+08 6.995E+08 5.371E+08 4.124E+08 3.166E+08 2.431E+08 6.487E+07 1.731E+07 4.619E+06 3.288E+05
ce144     4.848E+10 3.734E+10 2.956E+10 1.496E+10 7.569E+09 3.830E+09 1.938E+09 6.428E+07 2.132E+06 7.068E+04 7.773E+01
sb125     9.988E+10 7.105E+10 5.239E+10 2.155E+10 8.862E+09 3.645E+09 1.499E+09 1.764E+07 2.075E+05 2.441E+03 3.379E-01
cd113m    7.680E+07 6.968E+07 6.387E+07 4.955E+07 3.844E+07 2.982E+07 2.313E+07 6.499E+06 1.826E+06 5.130E+05 4.048E+04
am243     9.325E+06 9.151E+06 8.998E+06 8.566E+06 8.155E+06 7.764E+06 7.392E+06 5.781E+06 4.521E+06 3.536E+06 2.163E+06
cm242     5.288E+06 5.287E+06 5.287E+06 5.287E+06 5.286E+06 5.286E+06 5.285E+06 5.283E+06 5.280E+06 5.278E+06 5.273E+06
ba137m    1.287E+09 7.099E+08 4.168E+08 8.842E+07 1.896E+07 4.267E+06 1.158E+06 3.169E+05 3.089E+05 3.014E+05 2.868E+05
tc99      1.018E+05 1.009E+05 1.001E+05 9.784E+04 9.561E+04 9.342E+04 9.129E+04 8.133E+04 7.246E+04 6.455E+04 5.123E+04
total     6.781E+04 6.781E+04 6.781E+04 6.781E+04 6.781E+04 6.781E+04 6.781E+04 6.781E+04 6.781E+04 6.780E+04 6.780E+04
          2.529E+12 4.090E+11 3.619E+11 3.024E+11 2.735E+11 2.566E+11 2.454E+11 2.119E+11 1.871E+11 1.655E+11 1.298E+11

```

Figure 6.5 Plot file generated for sample problem 2



```
gamma spectrum at 1 year
  photon energy (mev)
  intensity (photons/sec/mev)
spec
  1      28
  1.0 years
1.000E-02 5.301E+17
5.000E-02 5.301E+17
5.000E-02 1.410E+17
1.000E-01 1.410E+17
1.000E-01 6.814E+16
2.000E-01 6.814E+16
2.000E-01 1.718E+16
3.000E-01 1.718E+16
3.000E-01 1.344E+16
4.000E-01 1.344E+16
4.000E-01 3.465E+16
6.000E-01 3.465E+16
6.000E-01 6.488E+16
8.000E-01 6.488E+16
8.000E-01 1.018E+16
1.000E+00 1.018E+16
1.000E+00 2.904E+15
1.330E+00 2.904E+15
1.330E+00 1.132E+15
1.660E+00 1.132E+15
1.660E+00 1.083E+14
2.000E+00 1.083E+14
2.000E+00 3.348E+14
2.500E+00 3.348E+14
2.500E+00 5.033E+12
3.000E+00 5.033E+12
3.000E+00 3.030E+11
4.000E+00 3.030E+11
```

Figure 6.6 Plot file generated for sample problem 3

```

neutron spectrum at 1
neutron energy (mev)
intensity (neutrons/sec/mev)
spec
      1      54
1.0 years
1.000E-11 0.000E+00
1.000E-08 0.000E+00
1.000E-08 0.000E+00
3.000E-08 0.000E+00
3.000E-08 0.000E+00
5.000E-08 0.000E+00
5.000E-08 0.000E+00
1.000E-07 0.000E+00
1.000E-07 0.000E+00
2.250E-07 0.000E+00
2.250E-07 0.000E+00
3.250E-07 0.000E+00
3.250E-07 0.000E+00
4.000E-07 0.000E+00
4.000E-07 0.000E+00
8.000E-07 0.000E+00
8.000E-07 0.000E+00
1.000E-06 0.000E+00
1.000E-06 0.000E+00
1.130E-06 0.000E+00
1.130E-06 0.000E+00
1.300E-06 0.000E+00
1.300E-06 0.000E+00
1.770E-06 0.000E+00
1.770E-06 0.000E+00
3.050E-06 0.000E+00
3.050E-06 0.000E+00
1.000E-05 0.000E+00
1.000E-05 0.000E+00
3.000E-05 0.000E+00
3.000E-05 0.000E+00
1.000E-04 0.000E+00
1.000E-04 0.000E+00
5.500E-04 0.000E+00
5.500E-04 0.000E+00
3.000E-03 0.000E+00
3.000E-03 0.000E+00
1.700E-02 0.000E+00
1.700E-02 0.000E+00
1.000E-01 0.000E+00
1.000E-01 4.491E+07
4.000E-01 4.491E+07
4.000E-01 1.375E+08
9.000E-01 1.375E+08
9.000E-01 1.259E+08
1.400E+00 1.259E+08
1.400E+00 1.040E+08
1.850E+00 1.040E+08
1.850E+00 7.531E+07
3.000E+00 7.531E+07
3.000E+00 2.299E+07
6.434E+00 2.299E+07
6.434E+00 4.849E+05
2.000E+01 4.849E+05

```

Figure 6.7 Plot file generated for sample problem 4

```

afterheats for 3 burnups
  time (years)
total power (watts)
case
  3
  10
  0.000E+00 2.738E-02 1.095E-01 2.738E-01 6.571E-01 1.000E+00 2.000E+00 3.000E+00 4.000E+00 5.000E+00
  1.946E+06 7.409E+04 3.869E+04 2.333E+04 1.224E+04 8.554E+03 4.379E+03 2.703E+03 1.905E+03 1.501E+03
28 gwd/mtu burnup
  10
  0.000E+00 2.738E-02 1.095E-01 2.738E-01 6.571E-01 1.000E+00 2.000E+00 3.000E+00 4.000E+00 5.000E+00
  2.277E+06 8.772E+04 4.587E+04 2.788E+04 1.488E+04 1.048E+04 5.412E+03 3.352E+03 2.362E+03 1.855E+03
33 gwd/mtu burnup
  10
  0.000E+00 2.738E-02 1.095E-01 2.738E-01 6.571E-01 1.000E+00 2.000E+00 3.000E+00 4.000E+00 5.000E+00
  3.728E+06 1.498E+05 7.849E+04 4.898E+04 2.780E+04 2.026E+04 1.097E+04 7.019E+03 5.049E+03 3.996E+03
55 gwd/mtu burnup

```

Figure 6.8 Plot file generated for sample problem 5

```

cm-242 as function of burnup
  time (years)
total power (watts)
case
  3
  10
  0.000E+00 2.738E-02 1.095E-01 2.738E-01 6.571E-01 1.000E+00 2.000E+00 3.000E+00 4.000E+00 5.000E+00
  9.760E+02 9.423E+02 8.295E+02 6.427E+02 3.544E+02 2.081E+02 4.418E+01 9.502E+00 2.168E+00 6.157E-01
28 gwd/mtu burnup
  10
  0.000E+00 2.738E-02 1.095E-01 2.738E-01 6.571E-01 1.000E+00 2.000E+00 3.000E+00 4.000E+00 5.000E+00
  1.427E+03 1.377E+03 1.212E+03 9.394E+02 5.180E+02 3.042E+02 6.452E+01 1.383E+01 3.113E+00 8.451E-01
33 gwd/mtu burnup
  10
  0.000E+00 2.738E-02 1.095E-01 2.738E-01 6.571E-01 1.000E+00 2.000E+00 3.000E+00 4.000E+00 5.000E+00
  3.273E+03 3.156E+03 2.778E+03 2.152E+03 1.186E+03 6.966E+02 1.475E+02 3.140E+01 6.839E+00 1.643E+00
55 gwd/mtu burnup

```

Figure 6.9 Plot file generated for sample problem 6

```

decay heat comparisons
  time (years)
total power (watts)
case
  2
  6
  0.000E+00 8.200E-02 4.930E-01 1.000E+00 3.000E+00 5.000E+00
  1.800E+06 4.500E+04 1.550E+04 8.630E+03 2.800E+03 1.520E+03
28 gwd/mtu user data
  10
  0.000E+00 2.738E-02 1.095E-01 2.738E-01 6.571E-01 1.000E+00 2.000E+00 3.000E+00 4.000E+00 5.000E+00
  2.277E+06 8.772E+04 4.587E+04 2.788E+04 1.488E+04 1.048E+04 5.412E+03 3.352E+03 2.362E+03 1.855E+03
33 gwd/mtu burnup

```

Figure 6.10 Plot file generated for sample problem 7

```

spent fuel at 33 gwd/mthm
cooling time (years)
grams
element
7      21
u      0.000E+00 2.738E-02 1.095E-01 2.738E-01 6.571E-01 1.000E+00 2.000E+00
pu     9.557E+05 9.557E+05 9.557E+05 9.557E+05 9.557E+05 9.557E+05 9.557E+05
np     9.352E+03 9.441E+03 9.441E+03 9.432E+03 9.408E+03 9.386E+03 9.321E+03
am     5.124E+02 4.299E+02 4.286E+02 4.288E+02 4.288E+02 4.288E+02 4.291E+02
cm     1.440E+02 1.460E+02 1.518E+02 1.635E+02 1.904E+02 2.140E+02 2.806E+02
he     4.025E+01 3.991E+01 3.846E+01 3.603E+01 3.215E+01 3.003E+01 2.705E+01
th     2.095E-01 2.189E-01 2.449E-01 2.893E-01 3.637E-01 4.082E-01 4.863E-01
pa     1.214E-03 1.228E-03 1.273E-03 1.365E-03 1.578E-03 1.769E-03 2.328E-03
pb     2.704E-04 2.711E-04 2.723E-04 2.740E-04 2.774E-04 2.804E-04 2.891E-04
cf     2.481E-07 2.601E-07 2.977E-07 3.843E-07 6.554E-07 9.850E-07 2.452E-06
bk     5.730E-07 6.060E-07 6.968E-07 8.613E-07 1.170E-06 1.374E-06 1.724E-06
ra     1.515E-06 1.483E-06 1.389E-06 1.220E-06 9.010E-07 6.870E-07 3.114E-07
ac     2.016E-08 2.052E-08 2.204E-08 2.546E-08 3.374E-08 4.191E-08 6.901E-08
bi     5.417E-09 5.559E-09 5.982E-09 6.832E-09 8.818E-09 1.060E-08 1.579E-08
tl     1.048E-10 1.076E-10 1.189E-10 1.411E-10 1.904E-10 2.375E-10 3.804E-10
rn     1.256E-12 1.278E-12 1.420E-12 1.762E-12 2.540E-12 3.290E-12 5.594E-12
es     1.208E-12 1.228E-12 1.360E-12 1.677E-12 2.398E-12 3.095E-12 5.249E-12
po     9.956E-11 1.050E-10 7.254E-11 1.867E-11 2.164E-12 1.419E-12 5.649E-13
fr     1.579E-13 1.649E-13 1.861E-13 2.255E-13 2.998E-13 3.561E-13 5.355E-13
at     9.388E-16 8.878E-16 5.570E-16 3.744E-16 4.125E-16 4.619E-16 6.049E-16
total 8.620E-20 8.030E-20 4.344E-20 2.136E-20 1.994E-20 2.033E-20 1.28E-20
9.658E+05 9.658E+05 9.658E+05 9.658E+05 9.658E+05 9.658E+05 9.658E+05

```

Figure 6.11 Plot file generated for sample problem 8

```

spent fuel at 33 gwd/mthm
time (years)
weight % in element
nuclide
10     22
u230   0.000E+00 2.738E-02 1.095E-01 2.738E-01 6.571E-01 1.000E+00 2.000E+00 3.000E+00 4.000E+00 5.000E+00
u231   1.829E-16 1.311E-16 4.823E-17 6.529E-18 6.146E-20 9.457E-22 4.889E-27 2.528E-32 5.431E-36 2.808E-41
u232   1.149E-14 2.207E-15 1.564E-17 7.856E-22 7.314E-32 3.211E-39 0.000E+00 0.000E+00 0.000E+00 0.000E+00
u233   2.361E-08 2.409E-08 2.529E-08 2.761E-08 3.266E-08 3.677E-08 4.689E-08 5.469E-08 6.065E-08 6.517E-08
u234   1.790E-07 1.794E-07 1.805E-07 1.829E-07 1.883E-07 1.932E-07 2.090E-07 2.249E-07 2.407E-07 2.566E-07
u235   1.639E-02 1.639E-02 1.640E-02 1.642E-02 1.646E-02 1.650E-02 1.662E-02 1.674E-02 1.685E-02 1.697E-02
u236   9.323E-01 9.323E-01 9.323E-01 9.323E-01 9.324E-01 9.324E-01 9.324E-01 9.324E-01 9.324E-01 9.324E-01
u237   4.243E-01 4.243E-01 4.243E-01 4.243E-01 4.243E-01 4.243E-01 4.244E-01 4.244E-01 4.244E-01 4.244E-01
u238   1.118E-03 4.005E-04 1.840E-05 4.345E-08 4.570E-09 4.494E-09 4.282E-09 4.081E-09 3.888E-09 3.705E-09
u239   9.863E+01 9.863E+01 9.863E+01 9.863E+01 9.863E+01 9.863E+01 9.863E+01 9.863E+01 9.863E+01 9.863E+01
u240   6.748E-05 0.000E+00 0.000E+00 0.000E+00 0.000E+00 0.000E+00 0.000E+00 0.000E+00 0.000E+00 0.000E+00
u241   9.787E-26 1.095E-25 1.445E-25 2.145E-25 3.777E-25 5.237E-25 9.496E-25 1.376E-24 1.802E-24 2.227E-24
pu236  6.514E-06 6.442E-06 6.316E-06 6.079E-06 5.561E-06 5.135E-06 4.072E-06 3.228E-06 2.559E-06 2.028E-06
pu237  3.607E-06 3.065E-06 1.934E-06 7.712E-07 9.022E-08 1.323E-08 4.906E-11 1.819E-13 6.740E-16 2.497E-18
pu238  1.422E+00 1.428E+00 1.441E+00 1.464E+00 1.500E+00 1.518E+00 1.538E+00 1.540E+00 1.539E+00 1.537E+00
pu239  5.605E+01 5.646E+01 5.651E+01 5.657E+01 5.671E+01 5.685E+01 5.724E+01 5.764E+01 5.802E+01 5.839E+01
pu240  2.088E+01 2.069E+01 2.069E+01 2.071E+01 2.077E+01 2.082E+01 2.097E+01 2.112E+01 2.127E+01 2.142E+01
pu241  1.590E+01 1.573E+01 1.567E+01 1.556E+01 1.531E+01 1.510E+01 1.449E+01 1.390E+01 1.333E+01 1.278E+01
pu242  5.741E+00 5.688E+00 5.688E+00 5.693E+00 5.708E+00 5.721E+00 5.761E+00 5.801E+00 5.839E+00 5.877E+00
pu243  1.855E-03 5.417E-16 5.369E-16 5.374E-16 5.388E-16 5.400E-16 5.438E-16 5.476E-16 5.512E-16 5.547E-16
pu244  5.064E-13 5.614E-13 7.407E-13 1.100E-12 1.943E-12 2.700E-12 4.930E-12 7.191E-12 9.480E-12 1.180E-11
pu245  1.040E-18 1.355E-25 0.000E+00 0.000E+00 0.000E+00 0.000E+00 0.000E+00 0.000E+00 0.000E+00 0.000E+00
pu246  1.078E-20 7.388E-21 4.252E-21 3.728E-21 3.727E-21 3.736E-21 3.761E-21 3.787E-21 3.812E-21 3.836E-21

```

Figure 6.12 Plot file generated for sample problem 9

```

pwr spent fuel - 33 gwd/mtu
cooling time (years)
arbitrary user input response
nuclide
10      22
rh106   0.000E+00 2.738E-02 1.095E-01 2.738E-01 6.571E-01 1.000E+00 2.000E+00 3.000E+00 4.000E+00 5.000E+00
pr144   1.093E+22 9.544E+21 9.025E+21 8.070E+21 6.215E+21 4.920E+21 2.490E+21 1.260E+21 6.374E+20 3.225E+20
ba137m  1.183E+21 1.145E+21 1.065E+21 9.200E+20 6.545E+20 4.826E+20 1.985E+20 8.163E+19 3.357E+19 1.381E+19
y90     1.396E+18 1.383E+18 1.380E+18 1.375E+18 1.363E+18 1.352E+18 1.321E+18 1.291E+18 1.262E+18 1.233E+18
cs134   5.431E+15 5.215E+15 5.189E+15 5.166E+15 5.118E+15 5.075E+15 4.951E+15 4.831E+15 4.713E+15 4.599E+15
co60    1.362E+15 1.349E+15 1.312E+15 1.242E+15 1.092E+15 9.729E+14 6.952E+14 4.967E+14 3.549E+14 2.536E+14
ag110m  5.026E+14 5.008E+14 4.955E+14 4.849E+14 4.610E+14 4.407E+14 3.864E+14 3.388E+14 2.970E+14 2.604E+14
eu154   1.205E+15 1.172E+15 1.078E+15 9.130E+14 6.191E+14 4.373E+14 1.587E+14 5.759E+13 2.090E+13 7.584E+12
cm244   4.106E+13 4.097E+13 4.070E+13 4.017E+13 3.894E+13 3.788E+13 3.494E+13 3.223E+13 2.974E+13 2.743E+13
cm242   2.330E+13 2.336E+13 2.329E+13 2.314E+13 2.280E+13 2.251E+13 2.166E+13 2.085E+13 2.006E+13 1.931E+13
eu152   9.399E+14 9.072E+14 7.985E+14 6.187E+14 3.412E+14 2.003E+14 4.249E+13 9.111E+12 2.050E+12 5.566E+11
pu238   6.198E+10 6.189E+10 6.163E+10 6.111E+10 5.990E+10 5.884E+10 5.586E+10 5.303E+10 5.034E+10 4.779E+10
cf252   4.441E+10 4.501E+10 4.545E+10 4.613E+10 4.714E+10 4.759E+10 4.787E+10 4.763E+10 4.728E+10 4.692E+10
am241   8.089E+10 8.031E+10 7.860E+10 7.529E+10 6.810E+10 6.224E+10 4.789E+10 3.685E+10 2.836E+10 2.182E+10
pu240   4.512E+08 4.749E+08 5.460E+08 6.872E+08 1.012E+09 1.298E+09 2.103E+09 2.869E+09 3.598E+09 4.291E+09
cm246   5.050E+08 5.050E+08 5.050E+08 5.051E+08 5.051E+08 5.052E+08 5.054E+08 5.056E+08 5.058E+08 5.060E+08
pu239   2.529E+08 2.529E+08 2.529E+08 2.529E+08 2.529E+08 2.529E+08 2.528E+08 2.528E+08 2.528E+08 2.527E+08
pu242   1.626E+07 1.654E+07 1.655E+07 1.655E+07 1.655E+07 1.655E+07 1.655E+07 1.655E+07 1.655E+07 1.655E+07
cm248   3.411E+06 3.411E+06 3.411E+06 3.411E+06 3.411E+06 3.411E+06 3.411E+06 3.411E+06 3.411E+06 3.411E+06
nb94    1.856E+04 1.856E+04 1.856E+04 1.856E+04 1.857E+04 1.857E+04 1.857E+04 1.857E+04 1.857E+04 1.857E+04
u238    1.767E+01 1.767E+01 1.767E+01 1.767E+01 1.767E+01 1.767E+01 1.767E+01 1.767E+01 1.767E+01 1.767E+01
total   0.000E+00 0.000E+00 0.000E+00 0.000E+00 0.000E+00 0.000E+00 0.000E+00 0.000E+00 0.000E+00 0.000E+00
10      1.217E+22 1.069E+22 1.009E+22 8.991E+21 6.871E+21 5.404E+21 2.690E+21 1.343E+21 6.723E+20 3.376E+20

```

Figure 6.13 Plot file generated for sample problem 10

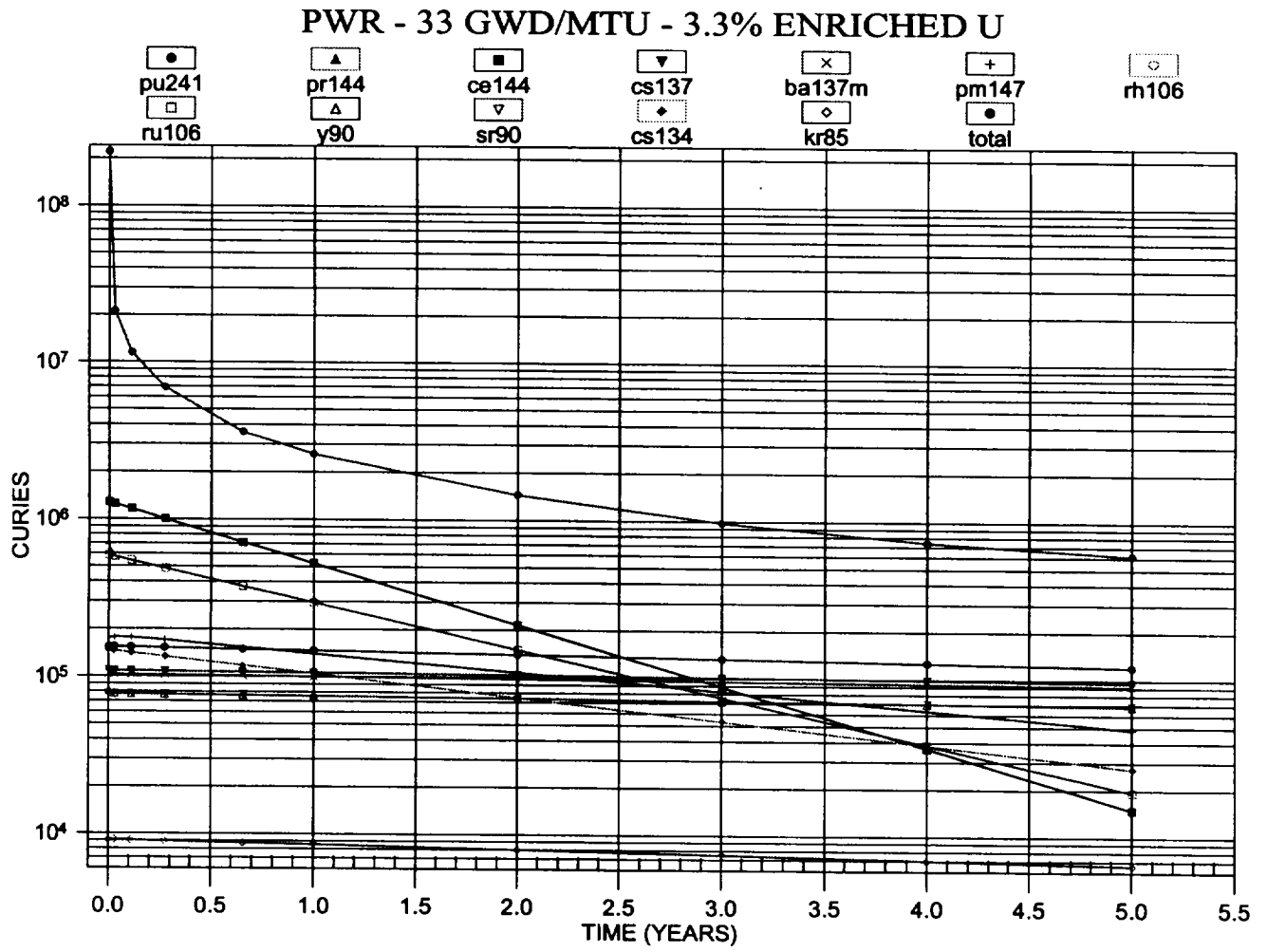

Figure 6.14 Plot made from sample problem 1

### GAMMA SPECTRUM AT 1 YEAR

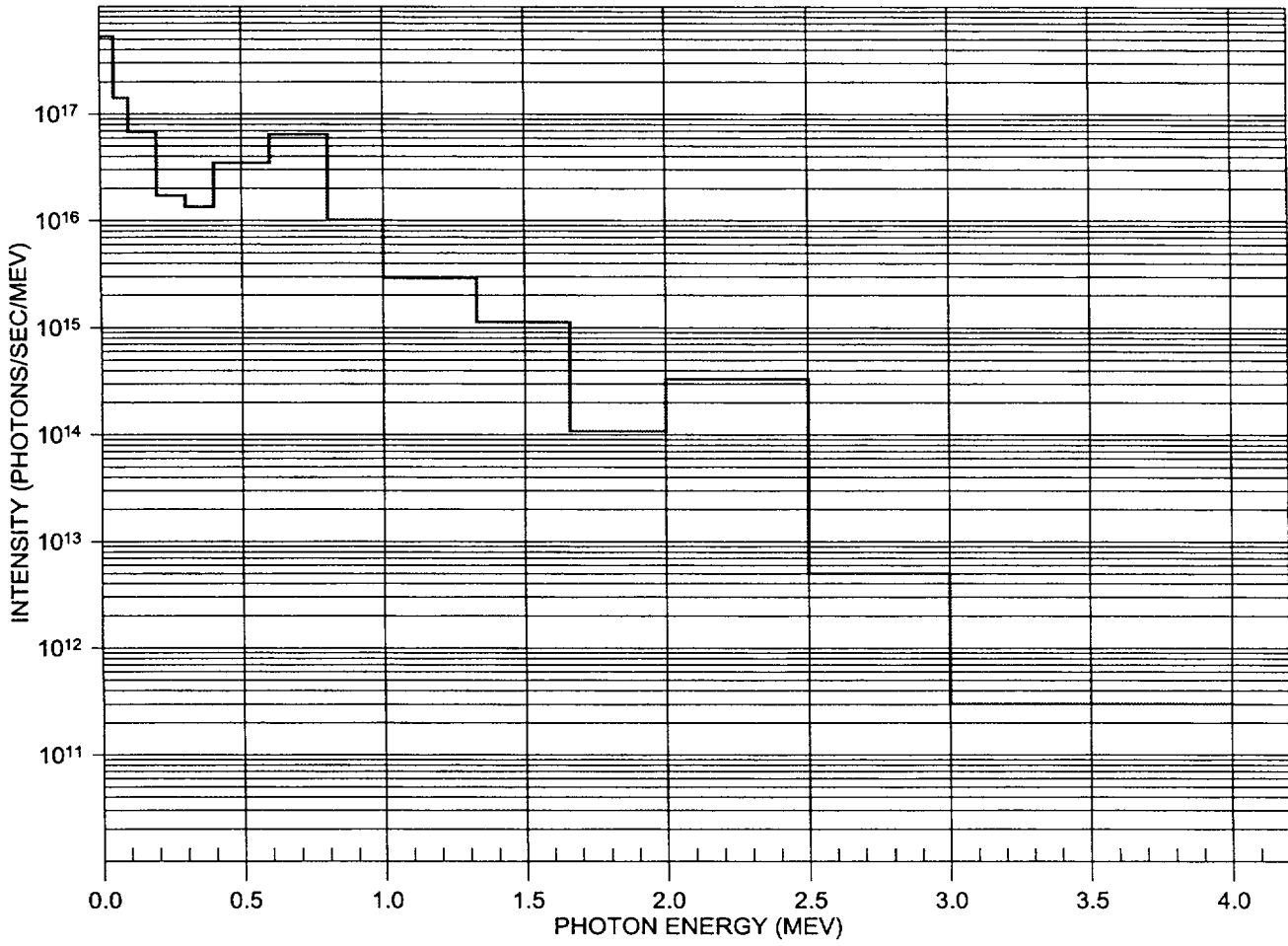

Figure 6.15 Plot made from sample problem 3

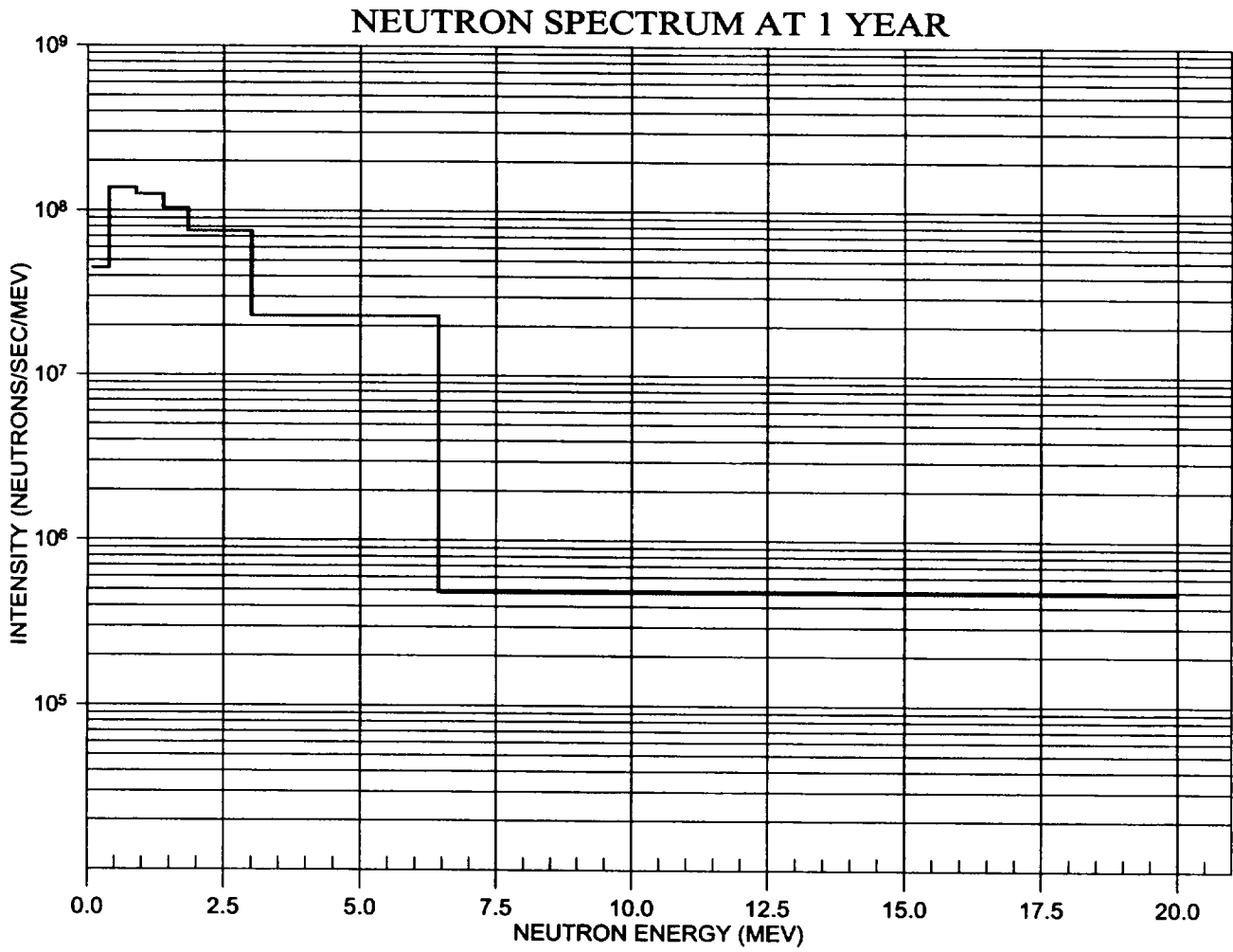

Figure 6.16 Plot made from sample problem 4



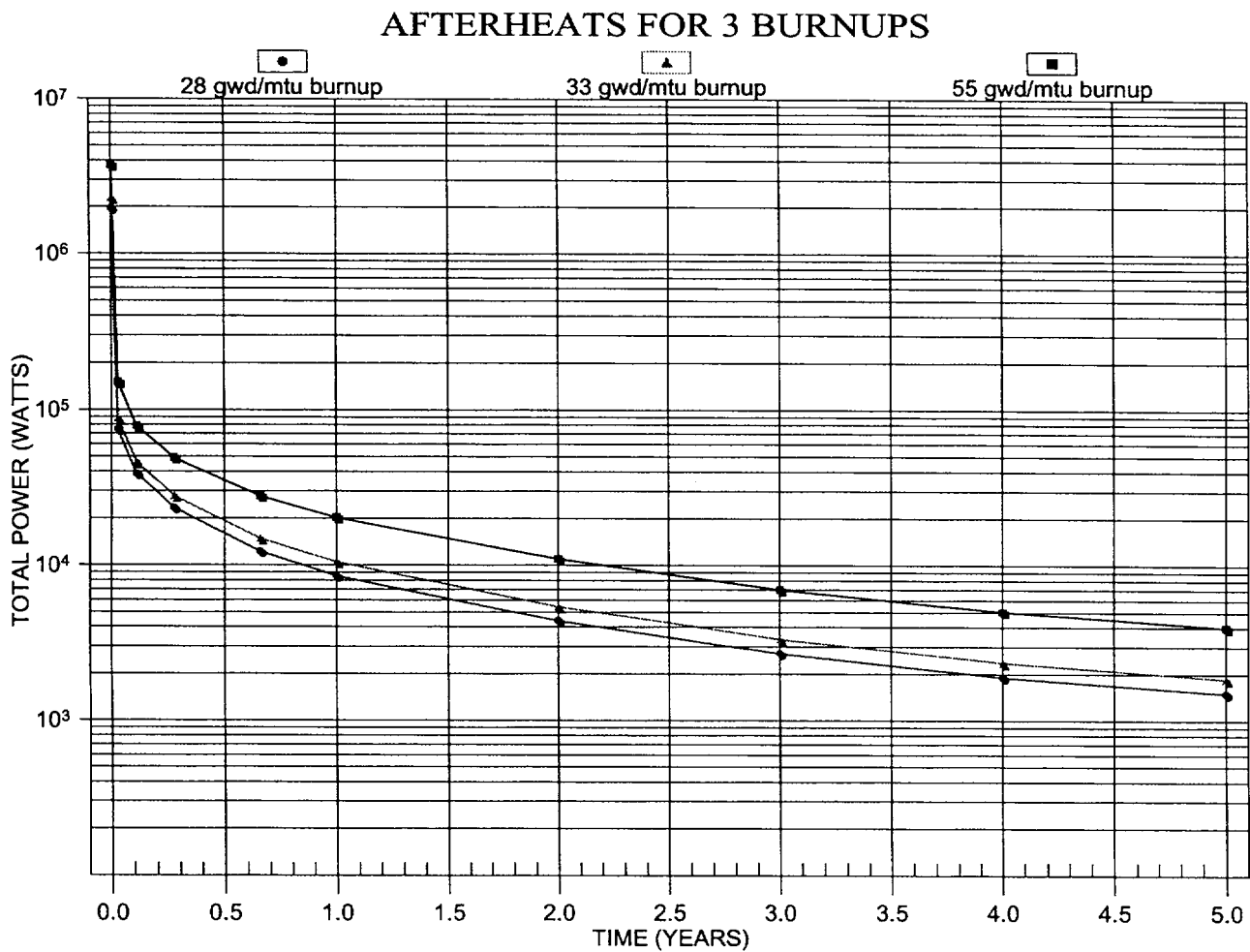

Figure 6.17 Plot made from sample problem 5

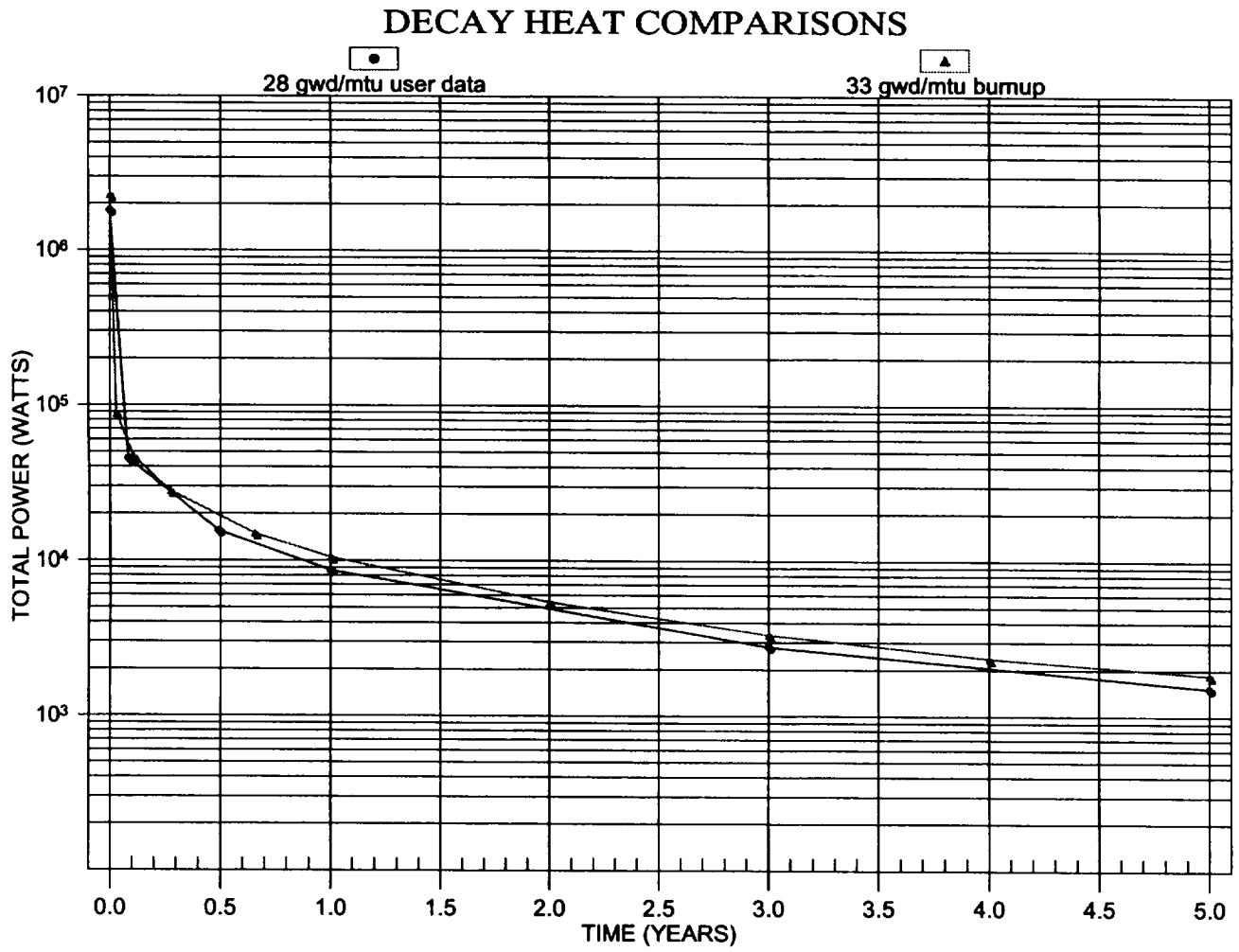

Figure 6.18 Plot made from sample problem 7

## 7 REFERENCES

1. O. W. Hermann and R. M. Westfall, "ORIGEN-S: SCALE System Module to Calculate Fuel Depletion, Actinide Transmutation, Fission Product Buildup and Decay, and Associated Radiation Source Terms," Vol. II, Sect. F7 of *SCALE: A Modular Code System for Performing Standardized Computer Analyses for Licensing Evaluation*, NUREG/CR-0200, Rev. 6 (ORNL/NUREG/CSD-2/R6), Vols. I, II, and III, May 2000. Available from Radiation Safety Information Computational Center at Oak Ridge National Laboratory as CCC-545.
2. *SCALE: A Modular Code System for Performing Standardized Computer Analyses for Licensing Evaluation*, NUREG/CR-0200, Rev. 6 (ORNL/NUREG/CSD-2/R6), Vols. I, II, and III, May 2000. Available from Radiation Safety Information Computational Center at Oak Ridge National Laboratory as CCC-545.
3. L. M. Petrie, "Scale Free-Form Reading Routines," Vol. III, Sect. M3 of *SCALE: A Modular Code System for Performing Standardized Computer Analyses for Licensing Evaluation*, NUREG/CR-0200, Rev. 6 (ORNL/NUREG/CSD-2/R6), Vols. I, II, and III, May 2000. Available from Radiation Safety Information Computational Center at Oak Ridge National Laboratory as CCC-545.
4. J. C. Ryman and O. W. Hermann, "ORIGEN-S Data Libraries," Vol. III, Sect. M6 of *SCALE: A Modular Code System for Performing Standardized Computer Analyses for Licensing Evaluation*, NUREG/CR-0200, Rev. 6 (ORNL/NUREG/CSD-2/R6), Vols. I, II, and III, May 2000. Available from Radiation Safety Information Computational Center at Oak Ridge National Laboratory as CCC-545.

**APPENDIX A**  
**ORIGEN-S CASES**

# APPENDIX A

## ORIGEN-S CASES

The input data for the three ORIGEN-S cases used by the OPUS sample problems (Section 6) are listed in Figures A.1 through A.3. The cases use the input binary cross-section library that has the name PRLIMLWR, as described in Section M6.7.4 of Ref. 4. The ORIGEN-S concentrations and spectral data for the 33, 28, and 55 GWd/MTU cases are saved on logical units 71, 72, and 73. These files are read by OPUS to obtain the time-dependent compositions used in generating the plot files.

```

=origens
0$$$ a8 26 a11 71 e
  1t
    test case
3$$$ 21 0 1 a33 18 2t
35$$$ 0 4t
56$$$ 10 a13 50 4 3 0 2 1 e 57** a3 1-14 e 5t
pwr - 33 gwd/mtu - 3.3% enriched u
  mt of heavy metal charged to reactor
58** f37.50 60** 8188 880
66$$$ 0 a5 1 a9 0 e
73$$$ 60120 130270 140280 140290 220460 220470 220480 220490
220500 240500 240520 240530 240540 250550 260540 260560 260570 260580
270590 280580 280600 280610 280620 280640 400900 400910 400920 400940
400960 410930 420920 420940 420950 420960 420970 420980 421000 501120
501140 501150 501160 501170 501180 501190 501200 501220 501240
922350 922380 922340
74** 1.5 4.0 .607 .034 .304 .277 2.771 .204 .2 5.04
57.423 6.415 1.574 0.327 4.037 61.018 1.439 0.31 0.915 111.862
41.783 1.869 5.645 1.609 1421.122 306.725 462.239 460.074 72.5 10.258
.957 .532 .926 .958 .546 1.357 .54 .321 .219 .113
4.681 2.47 7.729 2.739 10.392 1.467 1.823 140.4 4062 1.13
75$$$ 47r1 3r2 t
56$$$ a2 0 a10 4 e t
56$$$ a2 0 a10 10 e t
56$$$ 0 10 a10 10 a17 2 e 5t
60** 10 40 100 240 365.25 730.5 1095.75 1461 1826.25 3652.5
61** 5r1-6 1+6 1+4
65$$$ f0 a7 0 a8 1 a10 1 a22 1 a25 1 a29 1 a49 0 a50 1 a62 1 1 e
81$$$ 2 40 26 1 e 82$$$ f2
83** 1+7 8+6 6.5+6 5+6 4+6 3+6 2.5+6 2+6 1.66+6 1.33+6 1+6
  8+5 6+5 4+5 3+5 2+5 1+5 5+4 1+4 t
  pwr spent fuel 33 gwd
  pwr spent fuel 33 gwd
  pwr spent fuel 33 gwd
  pwr spent fuel 33 gwd
  pwr spent fuel 33 gwd
  pwr spent fuel 33 gwd
  pwr spent fuel 33 gwd
  pwr spent fuel 33 gwd
  pwr spent fuel 33 gwd
  pwr spent fuel 33 gwd
56$$$ 0 -10 a6 1 a10 0 e t
56$$$ 0 10 a10 10 a14 5 a17 2 e
57** 10. e 5t
60** 15 20 30 40 50 60 70 80 90 100
61** 5r1-3 1+6 1+4
65$$$ f0 a7 0 a8 1 a10 1 a22 1 a25 1 a29 1 a49 0 a50 1 a62 1 1 e
81$$$ 2 40 26 1 e 82$$$ f2
83** 1+7 8+6 6.5+6 5+6 4+6 3+6 2.5+6 2+6 1.66+6 1.33+6 1+6
  8+5 6+5 4+5 3+5 2+5 1+5 5+4 1+4 t
  pwr spent fuel 33 gwd
  pwr spent fuel 33 gwd
  pwr spent fuel 33 gwd
  pwr spent fuel 33 gwd
  pwr spent fuel 33 gwd
  pwr spent fuel 33 gwd
  pwr spent fuel 33 gwd
  pwr spent fuel 33 gwd
  pwr spent fuel 33 gwd
  pwr spent fuel 33 gwd
56$$$ 0 -10 a6 1 a10 1 e t
56$$$ f0 t
end

```

Figure A.1 ORIGEN-S input for the 33-GWd/MTU case

```

=origens
0$$$ a8 26 a11 72 e
  1t
  test case
3$$$ 21 0 1 a33 18 2t
35$$$ 0 4t
56$$$ 10 a13 50 4 3 0 2 1 e 57** a3 1-14 e 5t
pwr - 28 gwd/mtu - 3.3% enriched u
  mt of heavy metal charged to reactor
58** f31.8182 60** 8188 880
66$$$ 0 a5 1 a9 0 e
73$$$ 60120 130270 140280 140290 220460 220470 220480 220490
220500 240500 240520 240530 240540 250550 260540 260560 260570 260580
270590 280580 280600 280610 280620 280640 400900 400910 400920 400940
400960 410930 420920 420940 420950 420960 420970 420980 421000 501120
501140 501150 501160 501170 501180 501190 501200 501220 501240
922350 922380 922340
74** 1.5 4.0 .607 .034 .304 .277 2.771 .204 .2 5.04
57.423 6.415 1.574 0.327 4.037 61.018 1.439 0.31 0.915 111.862
41.783 1.869 5.645 1.609 1421.122 306.725 462.239 460.074 72.5 10.258
.957 .532 .926 .958 .546 1.357 .54 .321 .219 .113
4.681 2.47 7.729 2.739 10.392 1.467 1.823 140.4 4062 1.13
75$$$ 47r1 3r2 t
56$$$ a2 0 a10 4 e t
56$$$ a2 0 a10 10 e t
56$$$ 0 10 a10 10 a17 2 e 5t
60** 10 40 100 240 365.25 730.5 1095.75 1461 1826.25 3652.5
61** 5r1-3 1+6 1+4
65$$$ a7 0 2z 1 a22 1 2z 1 5z 1 a49 0 2z 1 a62 1 1
81$$$ 2 40 26 1 e 82$$$ f2
83** 1+7 8+6 6.5+6 5+6 4+6 3+6 2.5+6 2+6 1.66+6 1.33+6 1+6
  8+5 6+5 4+5 3+5 2+5 1+5 5+4 1+4 t
  pwr spent fuel 28 gwd
  pwr spent fuel 28 gwd
  pwr spent fuel 28 gwd
  pwr spent fuel 28 gwd
  pwr spent fuel 28 gwd
  pwr spent fuel 28 gwd
  pwr spent fuel 28 gwd
  pwr spent fuel 28 gwd
  pwr spent fuel 28 gwd
  pwr spent fuel 28 gwd
56$$$ 0 -10 a6 1 a10 0 e t
56$$$ 0 10 a10 10 a14 5 a17 2 e
57** 10. e 5t
60** 15 20 30 40 50 60 70 80 90 100
61** 5r1-3 1+6 1+4
65$$$ a7 0 2z 1 a22 1 2z 1 5z 1 a49 0 2z 1 a62 1 1
81$$$ 2 40 26 1 e 82$$$ f2
83** 1+7 8+6 6.5+6 5+6 4+6 3+6 2.5+6 2+6 1.66+6 1.33+6 1+6
  8+5 6+5 4+5 3+5 2+5 1+5 5+4 1+4 t
  pwr spent fuel 28 gwd
  pwr spent fuel 28 gwd
  pwr spent fuel 28 gwd
  pwr spent fuel 28 gwd
  pwr spent fuel 28 gwd
  pwr spent fuel 28 gwd
  pwr spent fuel 28 gwd
  pwr spent fuel 28 gwd
  pwr spent fuel 28 gwd
  pwr spent fuel 28 gwd
56$$$ 0 -10 a6 1 a10 1 e t
56$$$ f0 t
end

```

Figure A.2 ORIGEN-S input for the 28-GWd/MTU case

```

=origens
0$$ a8 26 a11 73 e
  1t
  test case
3$$ 21 0 1 a33 18 2t
35$$ 0 4t
56$$ 10 a13 50 4 3 0 2 1 e 57** a3 1-14 e 5t
pwr - 55 gwd/mtu - 3.3% enriched u
mt of heavy metal charged to reactor
58** f62.50      60** 8i88 880
66$$ 0 a5 1 a9 0 e
73$$ 60120 130270 140280 140290 220460 220470 220480 220490
220500 240500 240520 240530 240540 250550 260540 260560 260570 260580
270590 280580 280600 280610 280620 280640 400900 400910 400920 400940
400960 410930 420920 420940 420950 420960 420970 420980 421000 501120
501140 501150 501160 501170 501180 501190 501200 501220 501240
922350 922380 922340
74** 1.5 4.0 .607 .034 .304 .277 2.771 .204 .2 5.04
57.423 6.415 1.574 0.327 4.037 61.018 1.439 0.31 0.915 111.862
41.783 1.869 5.645 1.609 1421.122 306.725 462.239 460.074 72.5 10.258
.957 .532 .926 .958 .546 1.357 .54 .321 .219 .113
4.681 2.47 7.729 2.739 10.392 1.467 1.823 140.4 4062 1.13
75$$ 47r1 3r2 t
56$$ a2 0 a10 4 e t
56$$ a2 0 a10 10 e t
56$$ 0 10 a10 10 a17 2 e 5t
60** 10 40 100 240 365.25 730.5 1095.75 1461 1826.25 3652.5
61** 5r1-3 1+6 1+4
65$$ a7 0 2z 1 a22 1 2z 1 5z 1 a49 0 2z 1 a62 1 1
81$$ 2 40 26 1 e 82$$ f2
83** 1+7 8+6 6.5+6 5+6 4+6 3+6 2.5+6 2+6 1.66+6 1.33+6 1+6
  8+5 6+5 4+5 3+5 2+5 1+5 5+4 1+4 t
  pwr spent fuel 55 gwd
  pwr spent fuel 55 gwd
  pwr spent fuel 55 gwd
  pwr spent fuel 55 gwd
  pwr spent fuel 55 gwd
  pwr spent fuel 55 gwd
  pwr spent fuel 55 gwd
  pwr spent fuel 55 gwd
  pwr spent fuel 55 gwd
  pwr spent fuel 55 gwd
56$$ 0 -10 a6 1 a10 0 e t
56$$ 0 10 a10 10 a14 5 a17 2 e
57** 10. e 5t
60** 15 20 30 40 50 60 70 80 90 100
61** 5r1-3 1+6 1+4
65$$ a7 0 2z 1 a22 1 2z 1 5z 1 a49 0 2z 1 a62 1 1
81$$ 2 40 26 1 e 82$$ f2
83** 1+7 8+6 6.5+6 5+6 4+6 3+6 2.5+6 2+6 1.66+6 1.33+6 1+6
  8+5 6+5 4+5 3+5 2+5 1+5 5+4 1+4 t
  pwr spent fuel 55 gwd
  pwr spent fuel 55 gwd
  pwr spent fuel 55 gwd
  pwr spent fuel 55 gwd
  pwr spent fuel 55 gwd
  pwr spent fuel 55 gwd
  pwr spent fuel 55 gwd
  pwr spent fuel 55 gwd
  pwr spent fuel 55 gwd
  pwr spent fuel 55 gwd
56$$ 0 -10 a6 1 a10 1 e t
56$$ f0 t
end

```

Figure A.3 ORIGEN-S input for the 55-GWd/MTU case



**APPENDIX B**

**PLOT FILE FORMATS**

# APPENDIX B

## PLOT FILE FORMATS

The plot file required by PlotOPUS is an ASCII file that contains information on the plot title, axis labels, plot type, and the time-dependent data for inventory-type plots and energy-dependent data for spectral-type plots. Even though the data formats described are designed specifically for the plotting code PlotOPUS, the formats are suitably general to allow the data to be easily read and displayed by most graphs packages or spreadsheets. The plot-input file is read by PlotOPUS using free-format reading, and therefore the column positions have no particular significance. However, the plot files created by OPUS are aligned by column to facilitate reading of the files by other graphics programs.

### B.1 File Header Information

The format of the first five records of the plot file is common to all plot types. They are:

**Record 1:** TITL. Problem title (Maximum 32 characters).

**Record 2:** XHEA. X-axis label (Maximum 20 characters).

**Record 3:** YHEA. Y-axis label (Maximum 20 characters).

**Record 4:** Plot type. The plot type is selected by the words “nuclide,” “element,” “case,” or “spec.” The nuclide and element entries have the same effect, and produce time-dependent plots of individual nuclides and elements in the specified units. The case entry is used to identify case comparisons of totals or individual nuclides. The spec entry identifies spectral type plots.

The remaining records and formats depend on the Plot Type specified in Record 4.

### B.2 Nuclide and Element Plot Types

**Record 5:** NPTONC, KTOT. NPTONC is the number of time points (X-axis) for the plot data. KTOT is the number of nuclides or elements in the plot. This number includes the last record that contains the totals, if present.

**Record 6:** TIMES(NPTONC). NPTONC entries for the times associated with each data point. Units are in the units specified in Record 2 (XHEA).

**Record 7:** SYMBOL, (X(N,I), I=1, NPTONC). The SYMBOL is the alphanumeric symbol for the nuclide or element. No spaces are permitted in PlotOPUS. This symbol entry is followed by NPTONC entries containing the plot data for the nuclide or element SYMBOL with index N.

**Record 8:** Record 7 is repeated for all KTOT nuclides or elements.

**Record 7+KTOT:** Last record. This record contains the totals, or other related quantity, for the plot. The record has the same format as Record 7.

### B.3 Spectral Plot Types

**Record 5:** NPTONC, NGP. The number of entries that follow to construct the spectral histogram, where  $NGP=(NG+1)*2$  and NG is the number of energy groups. The histogram is made using a series of connecting lines, and therefore does not require any special histogram plotting capability in the graphics code.

**Record 6:** EN, YY. Each record contains a pair of entries; EN is the energy (MeV), and YY is the value for energy EN.

Repeat Record 6 NGP times.

### B.4 Case Comparison Plot Types

**Record 5:** NCAS. The negative value of the total number of cases in the plot.

**Record 6:** NPTONC. The number of time points (X-axis) for the plot data for the case (non-user-input data)

**Record 7:** INPOIN. The number of time points (X-axis) for the plot data for user-input data.

**Record 8:** XINP(INPOIN). INPOIN entries for the times associated with each data point of the user-input data.

**Record 9:** YINP(INPOIN). INPOIN entries containing the plot data for the user-input data.

**Record 10:** LEGEND. Legend for the user-input data case.

The remaining records contain the case comparison data for the non-user-input data. Repeat records 7, 8, 9, and 10 for the case comparison plots, NPTONC times (same as case comparisons with no user-input data).

### BIBLIOGRAPHIC DATA SHEET

( See instructions on the reverse)

1. REPORT NUMBER  
(Assigned by NRC, Add Vol., Supp.,  
Rev., and Addendum Numbers,  
if any.)

NUREG/CR-6718  
ORNL/TM-2001/26

2. TITLE AND SUBTITLE

OPUS/PlotOPUS: An ORIGEN-S Post-Processing Utility and  
Plotting Program for SCALE

3. DATE REPORT PUBLISHED

MONTH	YEAR
April	2001

4. FIN OR GRANT NUMBER

B-0009

5. AUTHOR(S)

I. C. Gauld, D. L. Barnett, O. W. Hermann, S. M. Bowman

6. TYPE OF REPORT

Technical

7. PERIOD COVERED (Inclusive  
Dates)

8. PERFORMING ORGANIZATION — NAME AND ADDRESS (If NRC, provide Division, Office or Region, U.S. Nuclear Regulatory Commission, and mailing address; if contractor, provide name and mailing address.)

Oak Ridge National Laboratory  
Managed by UT-Battelle, LLC  
Oak Ridge, TN 37831-6370

9. SPONSORING ORGANIZATION — NAME AND ADDRESS (If NRC, type "Same as above"; if contractor, provide NRC Division, Office or Region, U.S. Regulatory Commission, and mailing address.)

Spent Fuel Project Office  
Office of Nuclear Material Safety and Safeguards  
U.S. Nuclear Regulatory Commission  
Washington, DC 20555-0001

10. SUPPLEMENTARY NOTES

C. J. Withee, NRC Project Manager

11. ABSTRACT (200 words or less)

The OPUS utility program produces an output file that can be used for making a variety of plots from output produced by the ORIGEN-S code that computes reactor fuel depletion, activation and fission- product buildup, and the corresponding photon and neutron source spectra. Tables containing individual and total nuclide or element concentrations, in 14 different units, may be generated as a function of time. Three classes of plot data may be produced by OPUS: (1) dominant or selected isotopes or elements, (2) photon and neutron source spectra, and (3) comparisons of selected quantities (totals or individual nuclides) between different ORIGEN-S cases. The input is designed for ease of use with self-explanatory parameter names, free-form input, and commonly used default values.

The formatted output data produced by OPUS is designed to be used directly by the PlotOPUS graphics-plotting program. PlotOPUS is an interactive Visual Basic program designed for Windows 9x, 2000, and NT computers. PlotOPUS reads the formatted output data file produced by OPUS, plots the data, and will generate Windows metafile (WMF), JPEG bitmap (JPG), or Windows bitmap (BMP) files for saving the plot images. Even though it is designed to interface with PlotOPUS, the formatted OPUS output file can be easily read by other graphics packages for data visualization.

12. KEY WORDS/DESCRIPTORS (List words or phrases that will assist researchers in locating the report.)

SCALE, ORIGEN-S, spent fuel characterization, post processor, plotting

13. AVAILABILITY STATEMENT

unlimited

14. SECURITY CLASSIFICATION

(This Page) unclassified

(This Report) unclassified

15. NUMBER OF PAGES

16. PRICE



Federal Recycling Program

UNITED STATES  
NUCLEAR REGULATORY COMMISSION  
WASHINGTON, DC 20555-0001

---

OFFICIAL BUSINESS  
PENALTY FOR PRIVATE USE, \$300