



International Agreement Report

Assessment of Single Recirculation Pump Trip Transient in Santa Maria de Garona Nuclear Power Plant With TRAC-BF1/MOD1, Version 0.4

Prepared by

C. García de la Rúa, J. García García, J.V. López Montero

NUCLENOR, S.A.
C/ Herman Cortes 26
39080 Santander
SPAIN

**Office of Nuclear Regulatory Research
U.S. Nuclear Regulatory Commission
Washington, DC 20555-0001**

January 2001

Prepared as part of
The Agreement on Research Participation and Technical Exchange
under the International Code Application and Maintenance Program (CAMP)

**Published by
U.S. Nuclear Regulatory Commission**

AVAILABILITY OF REFERENCE MATERIALS IN NRC PUBLICATIONS

NRC Reference Material

As of November 1999, you may electronically access NUREG-series publications and other NRC records at NRC's Public Electronic Reading Room at www.nrc.gov/NRC/ADAMS/index.html.

Publicly released records include, to name a few, NUREG-series publications; *Federal Register* notices; applicant, licensee, and vendor documents and correspondence; NRC correspondence and internal memoranda; bulletins and information notices; inspection and investigative reports; licensee event reports; and Commission papers and their attachments.

NRC publications in the NUREG series, NRC regulations, and *Title 10, Energy*, in the Code of *Federal Regulations* may also be purchased from one of these two sources.

1. The Superintendent of Documents
U.S. Government Printing Office
P. O. Box 37082
Washington, DC 20402-9328
www.access.gpo.gov/su_docs
202-512-1800
2. The National Technical Information Service
Springfield, VA 22161-0002
www.ntis.gov
1-800-533-6847 or, locally, 703-805-6000

A single copy of each NRC draft report for comment is available free, to the extent of supply, upon written request as follows:

Address: Office of the Chief Information Officer,
Reproduction and Distribution
Services Section
U.S. Nuclear Regulatory Commission
Washington, DC 20555-0001

E-mail: DISTRIBUTION@nrc.gov

Facsimile: 301-415-2289

Some publications in the NUREG series that are posted at NRC's Web site address www.nrc.gov/NRC/NUREGS/indexnum.html are updated periodically and may differ from the last printed version. Although references to material found on a Web site bear the date the material was accessed, the material available on the date cited may subsequently be removed from the site.

Non-NRC Reference Material

Documents available from public and special technical libraries include all open literature items, such as books, journal articles, and transactions, *Federal Register* notices, Federal and State legislation, and congressional reports. Such documents as theses, dissertations, foreign reports and translations, and non-NRC conference proceedings may be purchased from their sponsoring organization.

Copies of industry codes and standards used in a substantive manner in the NRC regulatory process are maintained at—

The NRC Technical Library
Two White Flint North
11545 Rockville Pike
Rockville, MD 20852-2738

These standards are available in the library for reference use by the public. Codes and standards are usually copyrighted and may be purchased from the originating organization or, if they are American National Standards, from—

American National Standards Institute
11 West 42nd Street
New York, NY 10036-8002
www.ansi.org
212-642-4900

The NUREG series comprises (1) technical and administrative reports and books prepared by the staff (NUREG-XXXX) or agency contractors (NUREG/CR-XXXX), (2) proceedings of conferences (NUREG/CP-XXXX), (3) reports resulting from international agreements (NUREG/IA-XXXX), (4) brochures (NUREG/BR-XXXX), and (5) compilations of legal decisions and orders of the Commission and Atomic and Safety Licensing Boards and of Directors' decisions under Section 2.206 of NRC's regulations (NUREG-0750).

DISCLAIMER: This report was prepared under an international cooperative agreement for the exchange of technical information. Neither the U.S. Government nor any agency thereof, nor any employee, makes any warranty, expressed or implied, or assumes any legal liability or responsibility for any third party's use, or the results of such use, of any information, apparatus, product or process disclosed in this publication, or represents that its use by such third party would not infringe privately owned rights.

NUREG/IA-0193

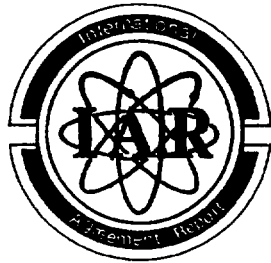

International Agreement Report

Assessment of Single Recirculation Pump Trip Transient in Santa Maria de Garona Nuclear Power Plant With TRAC-BF1/MOD1, Version 0.4

Prepared by

C. García de la Rúa, J. García García, J.V. López Montero

NUCLENOR, S.A.
C/ Herman Cortes 26
39080 Santander
SPAIN

**Office of Nuclear Regulatory Research
U.S. Nuclear Regulatory Commission
Washington, DC 20555-0001**

January 2001

Prepared as part of
The Agreement on Research Participation and Technical Exchange
under the International Code Application and Maintenance Program (CAMP)

**Published by
U.S. Nuclear Regulatory Commission**

ABSTRACT

This report has been prepared by NUCLENOR in the framework of the CAMP/SPAIN Project. It represents one of the application calculations submitted in fulfillment of the bilateral agreement for cooperation in thermalhydraulic activities between the Consejo de Seguridad Nuclear of Spain (CSN) and the United States Nuclear Regulatory Commission (USNRC).

The work consisted in using the TRAC-BF1 code to reproduce a transient that took place at Santa María de Garoña Nuclear Power Plant (NPP) on June 9, 1993. The event was originated by a transformer failure that led to a loss of generator excitation and consequently a recirculation pump trip.

Santa María de Garoña NPP is a 1381 MWth General Electric Boiling Water Reactor 3 (GE BWR/3) owned by NUCLENOR, S. A., a Spanish utility that participates in the CAMP Program as a member of UNIDAD ELÉCTRICA S. A. (UNESA).

The simulation has been carried out with the TRAC-BF1/MOD1, code, version 0.4, running on a Workstation Hewlett Packard c180u under HP-UX operating system.

As a result of the analysis, it is felt that TRAC-BF1 is capable of reproducing the plant behaviour with an acceptable degree of accuracy. The main phenomena of the transient have been calculated correctly.

CONTENTS

ABSTRACT iii

CONTENTS v

TABLES vii

FIGURES vii

EXECUTIVE SUMMARY ix

I. INTRODUCTION 1

II. NUCLEAR PLANT DESCRIPTION 2

III. TRANSIENT DESCRIPTION AND PLANT RESPONSE 7

IV. CODE INPUT MODEL DESCRIPTION 14

V. STEADY STATE CALCULATIONS 20

VI. CALCULATION RESULTS 21

VII. CONCLUSIONS 37

VIII. REFERENCES 38

TABLES

TABLE 1.- POWER-FLOW REFERENCE PLANT DATA IN THE OPERATING MAP.....	10
TABLE 2.- COMPONENTS OF GAROÑA NPP INPUT DECK.....	17
TABLE 3.- VALUES FOR KEY FEEDBACK PHENOMENA	19
TABLE 4.- STEADY STATE RESULTS AT NOMINAL POWER.....	20

FIGURES

FIGURE 1.- SANTA MARÍA DE GAROÑA NPP FUNCIONAL DIAGRAM	4
FIGURE 2.- POWER-FLOW MAP	11
FIGURE 3.- SANTA MARÍA DE GAROÑA NPP NODALIZATION	14
FIGURE 4.- LEVEL DISTRIBUTION IN THE REACTOR VESSEL.....	15
FIGURE 5.- VESSEL RADIAL NODALIZATION	16
FIGURE 6.- AVERAGE VOID FRACTION CALCULATED WITH TRAC-BF1	22
FIGURE 7.- AVERAGE MODERATOR TEMPERATURE, TRAC-BF1	22
FIGURE 8.- AVERAGE FUEL TEMPERATURE, TRAC-BF1	23
FIGURE 9.- CORE THERMAL POWER, TRAC-BF1 CALCULATION	23
FIGURE 10.- VOID FRACTION REACTIVITY, TRAC-BF1.....	24
FIGURE 11.- DOPPLER REACTIVITY, TRAC-BF1	24
FIGURE 12.- EVOLUTION OF FEEDWATER TEMPERATURE	25
FIGURE 13.- MODERATOR TEMPERATURE REACTIVITY, TRAC-BF1	26
FIGURE 14.- TOTAL REACTIVITY, TRAC-BF1	26
FIGURE 15.- TOTAL REACTOR POWER, TRAC-BF1 AND PLANT DATA	27
FIGURE 16.- PRESSURE AT THE SENSOR LINE AND REGULATOR SET-POINT	28
FIGURE 17.- STEAM DOME PRESSURE, TRAC-BF1 AND PLANT DATA	29
FIGURE 18.- STEAM FLOW EVOLUTION, TRAC-BF1 AND PLANT DATA	30
FIGURE 19.- COMPARISON BETWEEN CALCULATED AND LEVEL PLANT DATA.....	31
FIGURE 20.- FLOW RATE PUMP “B”, TRAC-BF1 AND PLANT DATA	32
FIGURE 21.- FLOW RATE PUMP “A”, TRAC-BF1 AND PLANT DATA	33
FIGURE 22.- CORE FLOW, TRAC-BF1 AND MEASURED PLANT SIGNAL.....	34
FIGURE 23.- CORE FLOW, TRAC-BF1 AND CALCULATED PLANT DATA.....	35
FIGURE 24.- TOTAL FEEDWATER FLOW, TRAC-BF1 AND PLANT DATA.....	36

EXECUTIVE SUMMARY

This work shows the results of the analysis with TRAC-BF1 of an actual event that took place in Santa María de Garoña Nuclear Power Plant (NPP) on June 9, 1993. The event was originated by a single recirculation pump trip. Santa María de Garoña NPP is a 1381 MWt General Electric Boiling Water Reactor 3 (GE BWR/3).

Immediately after the recirculation pump “A” trip, the jet pump diffuser and drive flows reverse in the tripped loop. The jet pump flow increases in the active loop because of the decreased core flow and core pressure drop. The decreased core flow initially causes the core void fractions to increase, resulting in an increase in reactor water level and a decrease in power. In this situation, proper core flow measurement is required to assure operation within the power-flow map and to avoid the region of potential thermalhydraulic instabilities. The plant can operate with a single loop with appropriately modified procedures and technical specifications (TS).

The main phenomena are reproduced in the simulation and the discrepancies are justified. A general-purpose nodalization of the plant for TRAC-BF1 has been used. This work is an additional part of the validation set for this TRAC-BF1 nodalization which has been developed for thermalhydraulic applications.

I. INTRODUCTION

NUCLENOR is a Spanish Electrical Utility, which owns the GE BWR/3 Santa María de Garoña Nuclear Power Plant.

NUCLENOR, in the framework of the “Code Applications and Maintenance Program” (CAMP), has taken on the task of selecting an application case among the different transients of the life of the plant to analyse with TRAC-BF1/MOD1 code, version 0.4, and to evaluate the agreement.

In this case, the analysis of a single recirculation pump trip was selected and a comparison between measured data and TRAC-BF1 data has been carried out.

The trip of one recirculation pump does not normally cause scram. In fact, GE BWRs were licensed specifically for this operating condition, which is generally called single loop operation (SLO). During SLO, proper core flow measurement is required to assure operation within the power-flow map and to avoid the region of potential thermalhydraulic instabilities. Additional considerations are necessary because the inactive jet pumps may be operating with reverse flow when the active loop jet pump flow is above 40 % of rated core flow. The jet pump core flow measurement system is calibrated to measure core flow when both sets of jet pumps are in forward flow and the total core flow is the sum of the indicated loop flows.

A summary of the Santa María de Garoña NPP is presented in Section II and the simulated transient characteristic in Section III. Section IV describes the model of the plant and the main features of the input deck. The steady state results are explained in Section V. Calculation results and discussions of the main phenomena are presented in Section VI. Finally, the main conclusions obtained are summarised in Section VII.

TRAC-BF1/MOD1 v. 0.4 is implemented in a Workstation Hewlett Packard hp-c180u under HP-UX operating system, where all the calculations have been carried out.

II. NUCLEAR PLANT DESCRIPTION

The Santa María de Garoña NPP is a General Electric Boiling Water Reactor 3 (BWR-3), with a Mark I primary containment type. The plant is operated by NUCLENOR and was connected to the grid in 1971. The plant is rated at 1381 MW (thermal) and is located in the province of Burgos (Spain).

The Nuclear Boiler assembly consists of the reactor pressure vessel and internal reactor components such as the core structure, steam dryer assembly, fuel supports and control guide tubes. The reactor core is made up of 400 fuel assemblies and 97 control rod blades. At present, it is loaded with GE11 (9x9) elements. However the transient, that we will compare with a TRAC-BF1 analysis, took place in 1993 (cycle 17) and the reactor core was loaded with:

- GE7B (8x8) elements
- GE8B (8x8) elements
- GE10 (8x8) elements

Each control rod blade consists of sheathed cruciform array of vertical absorber rods made of boron carbide (B_4C).

The Recirculation system provides the hydraulic energy required to force coolant through the reactor core and provide forced convection cooling of the reactor core. The recirculation system consists essentially of two recirculation piping loops located outside the reactor pressure vessel, in the Drywell area, and includes twenty jet pumps located inside the reactor pressure vessel between the reactor pressure vessel wall and the core shroud.

The flow from the recirculation pump is the driving force for the jet pump. The recirculation flow is mixed with the feedwater and steam separator water flow and the total is discharged into the plenum area below the core. The coolant flows upward around the individual fuel rods inside the fuel channel, where it is heated and becomes a two-phase steam-water mixture. The steam-water mixture leaves the fuel bundles at the

top and enters a plenum located directly above the core. The plenum allows the flow to be equally spread out into the array of steam separators located above the plenum region. The steam is separated from the water and passes through a dryer where the content of water in the steam is minimised. The saturated steam exits through nozzles at the top of the vessel body.

Water collected below the dryer is routed through drain lines joins the water leaving the separators, and flows downward in the annulus between the core shroud and vessel wall. Feedwater is added to the system through spargers at the top of this annulus and joins the downward flow of water. A portion of this downward flow exits to the recirculation pumps.

The primary function of the reactor recirculation system is to permit reactor power level changes without changing the position of the reactor control rods. In this mode, reactor power can be changed up to 30% per minute over a nominal 25% range. For instance, starting at 100% power, the range is between 75% and 100% and the rate is 30% per minute.

The primary purpose of the feedwater system is to maintain the water level in the reactor vessel within a programmed range during all modes of plant operation. In normal operation, the level of water in the reactor is controlled by a feedwater controller which receives inputs from reactor vessel water level, steam-mass flow rate and feedwater-mass flow rate transmitters.

The feedwater control system generates signals that regulate the opening of the flow control valves. The rate of flow is thus controlled, maintaining the reactor level at the desired level. During steady-state operation, feedwater mass flow rate matches the steam mass flow exactly and the water level is maintained. A change in the steam mass flow of the control valves is immediately sensed and the system adjusts the opening of the feedwater mass flow of the control valves to balance the two mass flow rates, maintaining the water level.

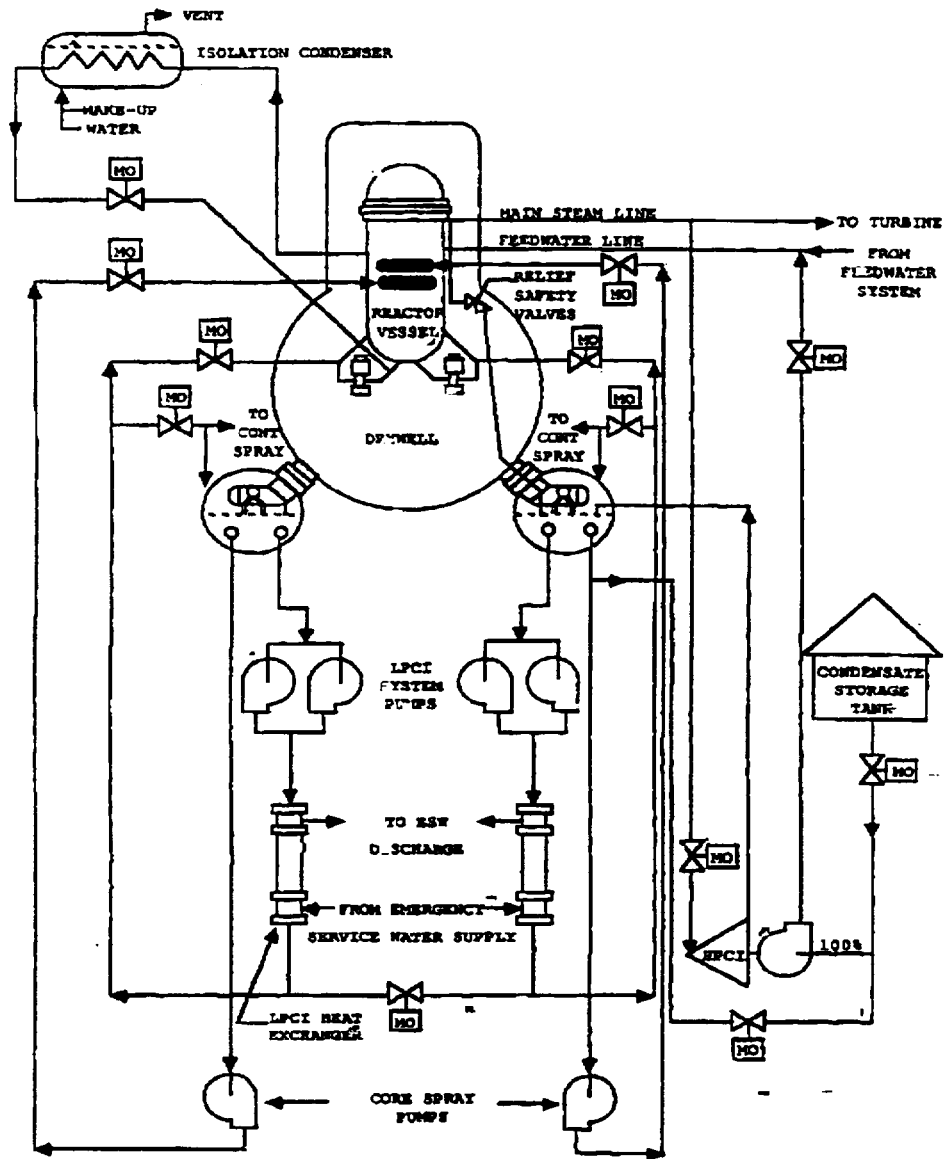

Figure 1.- Santa María de Garoña NPP funcional diagram.

The main steam system consists of four lines that provide steam to the turbine from the reactor vessel. Steam lines run downward, parallel to the vertical axis of the vessel, until they reach the elevation at which they emerge from the containment. Two air-operated isolation valves are installed on each steam line, one inboard and one

outboard of the primary containment penetration. A flow-restricting nozzle is included in each steam line as an additional engineered safeguard to protect against rapid uncovering of the core in case of a main steam line break.

Three relief valves (RV's) and three safety/relief valves (SRV's) discharging into the suppression pool, and seven safety valves (SV's) discharging into the drywell, are installed on the steam lines. The main function of these valves is protection against overpressure of the reactor primary system.

The primary containment in Santa María de Garoña NPP is of the Mark I type. The steel "Light-bulb shaped" Drywell is a spherical shell intersected by a cylinder (Figure 1). A bolted head closes the top of the cylinder. The pressure-suppression chamber, or the Wetwell, is a toroidal steel vessel that surrounds the lower portion of the Drywell. Eight circular vent pipes interconnect the Wetwell and the Drywell. The containment is enclosed by the reactor building, which also contains the refuelling area, fuel storage facilities and other auxiliary systems.

Figure 1 gives the reader an insight into the arrangement and interfaces of the Santa María de Garoña NPP Isolation Condenser System (IC) and Emergency Core Cooling System (ECCS).

The Isolation Condenser system (IC) is designed to provide emergency reactor core cooling without loss of water when the reactor becomes isolated from the turbine and the main condenser by closure of the main steam line isolation valves.

The IC system consists of one elevated condenser containing two tube bundles, immersed in cooling water, and the necessary piping and valves to condense the reactor steam and return the condensate by gravity to one of the recirculation loops. The IC unit is located in the Reactor Building at an elevation higher than the reactor vessel, in order to provide the necessary operating pressure head.

The Santa María de Garoña ECCS, consists of the following systems:

- High Pressure Injection System (HPCI)
- Low Pressure Cooling Injection System (LPCI)
- Core Spray System (CS)

The HPCI system consists of a turbine-driven pump assembly and the necessary elements to pump water from the Condensate Storage Tank or Suppression Pool in the reactor vessel. The HPCI system provides emergency core cooling in the event of a small break in a process line that does not result in significant depressurisation of the vessel. The primary steam line provides steam from the pressure vessel to operate the HPCI turbine. Exhaust steam from the turbine is piped to the Suppression Pool where it is condensed.

The Low-Pressure Cooling Injection system (LPCI) consists of two identical and completely independent cooling loops. Each loop has two pumps in parallel. The two loops are arranged to discharge water into the reactor recirculation loops. A cross connection exists between the pump discharge headers of each loop. Containment cooling water from the Suppression Pool is cooled by either of the two, or both, shell-tube heat exchangers. One heat exchanger is provided in each of the two LPCI loops.

The Core Spray system consists of two independent pumping subsystems, each capable of fulfilling the cooling requirements of the reactor core in the event of failure in the primary system. Operation mode involves taking water from the suppression chamber and pumping it to the reactor vessel by core spray nozzles.

Both LPCI and CS start automatically when either a Drywell high pressure or Low Low vessel signal exists.

III. TRANSIENT DESCRIPTION AND PLANT RESPONSE

Santa María de Garoña NPP, as well as other GE BWRs occasionally find it necessary to operate with one recirculation loop (SLO, Single Loop Operation) out of service. The SLO follows mechanical or electrical failures, which affect one of the recirculation loops. Many such failures (e.g. a circuit breaker trip) can be corrected quickly by plant personnel [1], [2]. The initial design of GE BWRs generally considered the mechanical, structural and thermal effects of limited SLO and were licensed specifically for this operating condition. Additionally, some GE BWRs, including Santa María de Garoña NPP, have also been licensed specifically for extended SLO with appropriately modified procedures and technical specifications. Extended SLO is required when a more significant mechanical or electrical failure (e.g. motor-generator set failure) cannot be corrected quickly.

Transient description

On June 9th, 1993 at 18:58 h., the plant was operating at 1381 MWt in stable conditions when a transformer failure led to a loss of generator excitation and, consequently, a motor-generator group “A” trip. As a consequence, the recirculation pump “A” trip [1].

Control room alarms on panel 904, together with the recirculation flow and power reduction, forced the operating crew to follow the Abnormal Operating Procedure (AOP) 202-2 “Loss of a Recirculation Pump”. There were no automatic actions and the crew had to carry out the AOP immediate actions set, which will be summarised next:

Immediately after the recirculation pump “A” trip, loop A started to backflow and loop “B” flow rate was increased due to the reactor pressure decrease. In this situation, the crew had to close the loop “A” discharge valve to protect the tripped pump impeller from rotating backwards. This valve had to remain closed about five minutes.

Subsequently, the crew had to isolate pump "A" seals of the Control Rod Drive Hydraulic System (CRDH) water make up to avoid an excessive loop "A" cooling.

It is well known that the jet pump core flow measurement system is calibrated to measure core flow when both sets of jet pumps are in forward flow and the total core flow is the sum of the indicated loop flows. However, for SLO, the inactive jet pumps start reverse flow, so that the measured flow in the reverse flow jet pumps must be subtracted from the measured flow in the active loop. In addition, the jet pump flow coefficient is different in reverse flow than forward flow (the reverse flow coefficient is about 95% of the forward flow coefficient), and the measurement of reverse flow must be modified to account for this fact.

The operating crew ended immediate actions by checking pressure, reactor power and off-gas activity. The subsequent actions were intended to fulfil Technical Specifications (TS):

- Maintaining idle loop temperature. If the idle loop is permitted to cool down, restart of the idle recirculation pump may be prohibited because of TS. If the idle loop cannot be warmed, these operating restrictions can make it necessary to shut down and cool down the RPV before the idle recirculation pump can be restarted.

- Inserting control rods within a limit of 30 minutes, until nuclear power is 5 % lower than 70 % rod pattern line.

- Reduce the active pump speed to 53 %. If the idle loop is not isolated and if the operating loop recirculation pump is providing more than about 40 % of rated core flow, the reverse flow through the idle jet pumps will force some reverse flow through the idle loop and will tend to keep the idle loop warm. At lower operating flows, reverse flow will decrease and a cool down will occur. In this way, a compromise is maintained between a reverse flow high enough to keep the loop warm and, at the same time, weak enough not to damage the repaired pump when restarting, if this is possible.

The plant was operated about 23 h. with a single loop, until the other pump could be restarted.

During the whole transient, proper core thermal power and flow measurement were required to assure operation within the power-flow map. If near in instability region, a transition into POA 202-4 “Prevention of core thermal-hydraulic instabilities” might be required. However, this was not necessary on this occasion.

Figure 2, shows the power-flow map of Santa María de Garoña NPP. This diagram shows the relation between core thermal power versus core flow rate for various operating conditions.

Line A is called the natural circulation line and shows the power versus flow with no recirculation pumps running. Line B is for minimum recirculation pump speed. As the core power increases along lines A and B, the core flow rate tends to a limit. This is a result of the additional flow resistance created by the increase in two-phase flow.

The shape of line C will be followed if the core power is changed with no change in the recirculation pump speed (e.g., control rod movement or end-of-cycle coastdown). For a power reduction, the flow increase is due to a reduction in channel void fraction and a subsequent reduction in two-phase flow resistance. The reverse is true for a power increase.

Line D is called the 100% flow control line, the 100% rod pattern line or the 100% load line. It is based on balanced xenon conditions and is defined by the core configuration that will result in rated core thermal power when the core flow is increased to rated flow. Line D can be derived by operating the plant at full power and full flow until balanced xenon conditions are established and then reducing recirculation pump speed to minimum speed in a relatively short period. Line D is slightly concave because the core inlet subcooling decreases somewhat as core flow rate increases. Thus,

the core thermal power is slightly less at full flow than it would be, if the inlet temperature did not change.

Line E is a flow interlock line to prevent cavitation of the jet pumps and the recirculation pumps. The recirculation pumps cannot be operated above minimum pump speed until feedwater flow is greater than 20% of rated flow. Similarly, the recirculation pump will run back to minimum speed if the feedwater flow becomes less than 20%. This assures adequate subcooling for all normal modes of pump operation.

Table 1 shows the power-flow pairs belonging to the initial steady-state (point 1), recirculation pump trip (point 2) and final state (point 3). In any case, the plant conditions are outside the instability region. The total core flow along the transient is out of instability region, taking into account that the uncertainty in measured core flow (6%) has also been considered. Thus, the plant can operate with a single loop with appropriately modified procedures and technical specifications (TS).

Time (s)	0-55	~60	300
Power (%)	100 %	~53 %	~70 %
Core Flow (T/H)	~20190	~10700	~10700
Icon in power-flow map	(1)	(2)	(3)

Table 1.- Power-flow reference plant data in the operating map.

The core flow, after the trip, has been calculated using the formula [3],

$$(\text{Total Core Flow}) = (\text{Active Loop Indicated Flow}) - C (\text{Inactive Loop Indicated Flow})$$

where the factor $C = 0.95$, is the recommended (conservative) value for measurement of core flow during single loop operation.

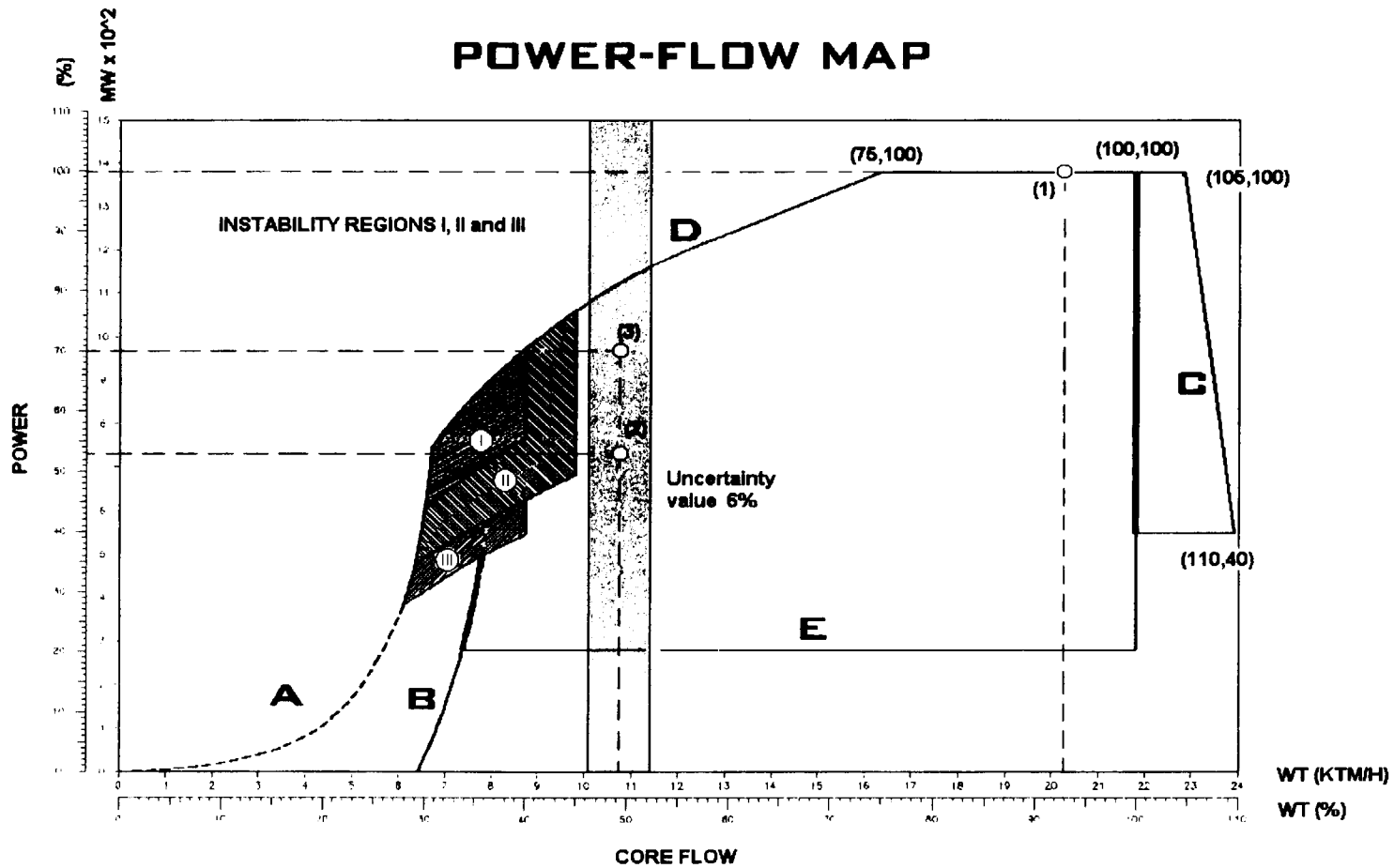

Figure 2.- Power-flow map.

Core response to recirculation flow changes

Coolant flow-rate control in Santa María de Garoña NPP is accomplished by varying the recirculation pump motor speeds. As a consequence of changes in the recirculation flow, the core power will change.

Basically, the phenomenology of the process can be explained taking into account that the core power response to recirculation flow changes in BWR consists of an interaction of four basic variables: voids, Doppler effect, inlet temperature and xenon effect.

The first response to a change in coolant flow is a change in the core void fraction. A core flow decrease will result in a quick increase in the void fraction at any elevation of the core. As BWRs have a negative void coefficient of reactivity, the total core power decreases.

The fuel temperature goes down and causes a reactivity increase due to the Doppler effect. This increase in reactivity must be compensated by an equal decrease due to increased void fraction. The Doppler coefficient of reactivity is much smaller than the void coefficient.

The third effect of changing flow is the change in core inlet temperature. For a given core flow decrease, the feedwater flow decrease is proportionally smaller. Thus, a reduction in core flow creates an increase in subcooling as a consequence of a reduction in the extraction steam to the feedwater heaters. This low inlet temperature increases the coolant density in the lower part of the core and thus results in an increase in reactivity.

The net immediate effect of all these variables is to reduce the power level while leaving the power shape essentially unchanged. The second order effects due to Doppler, void fraction, and inlet temperature, tend to shift the power slightly towards the top of the core.

The fourth effect is the evolution of the xenon concentration. The xenon redistribution after a flow change is very slow compared to the rapid responses of void, Doppler, and inlet temperature. As xenon and iodine concentration decrease thermal power will slowly rise.

IV. CODE INPUT MODEL DESCRIPTION

The TRAC-BF1 input is made up of 51 components, including FILL and BREAK components, as well as a very detailed model of plant controls and logic [4], [5]. The development of TRAC-BF1 input deck for this analysis was based on data taken from drawings [6] and specific technical documents related with the nuclear fuel design [7]. The main features of the nodalization can be seen in Figure 3. Figure 4 shows the diagram of level distribution in the reactor vessel. Additionally, components are listed in Table 2.

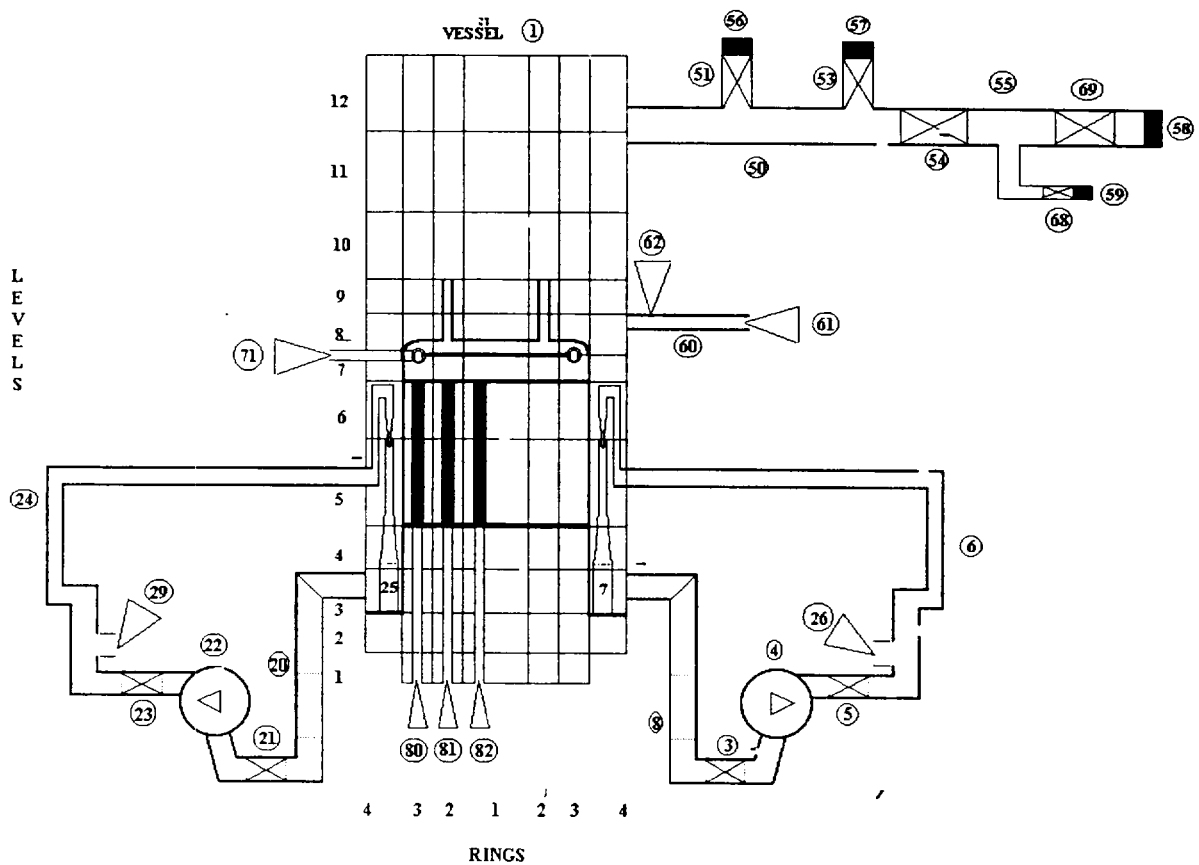

Figure 3.- Santa María de Garoña NPP nodalization.

The Component Vessel is divided into 12 axial segments (levels), four radial segments (rings) and only one azimuthal segment. The downcomer upper level corresponds to level 8.

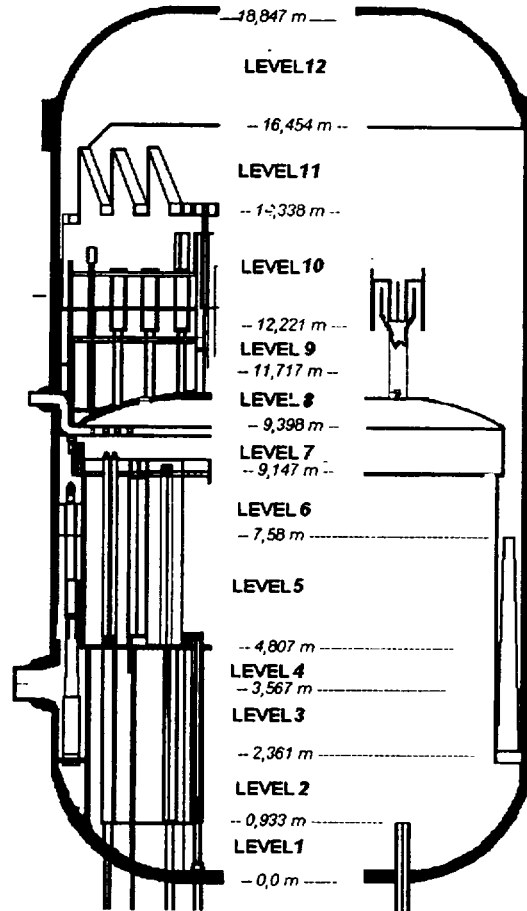

Figure 4.- Level distribution in the reactor vessel.

The radial segments are distributed such that the inner three rings extend over the core region with the first ring containing 28 fuel channels, the second ring containing 288 fuel channels and the third ring containing 84 fuel channels. The fourth radial ring models the reactor vessel downcomer that extends from the top of level 2 to the top of level 8. Figure 5 shows the radial division of the vessel.

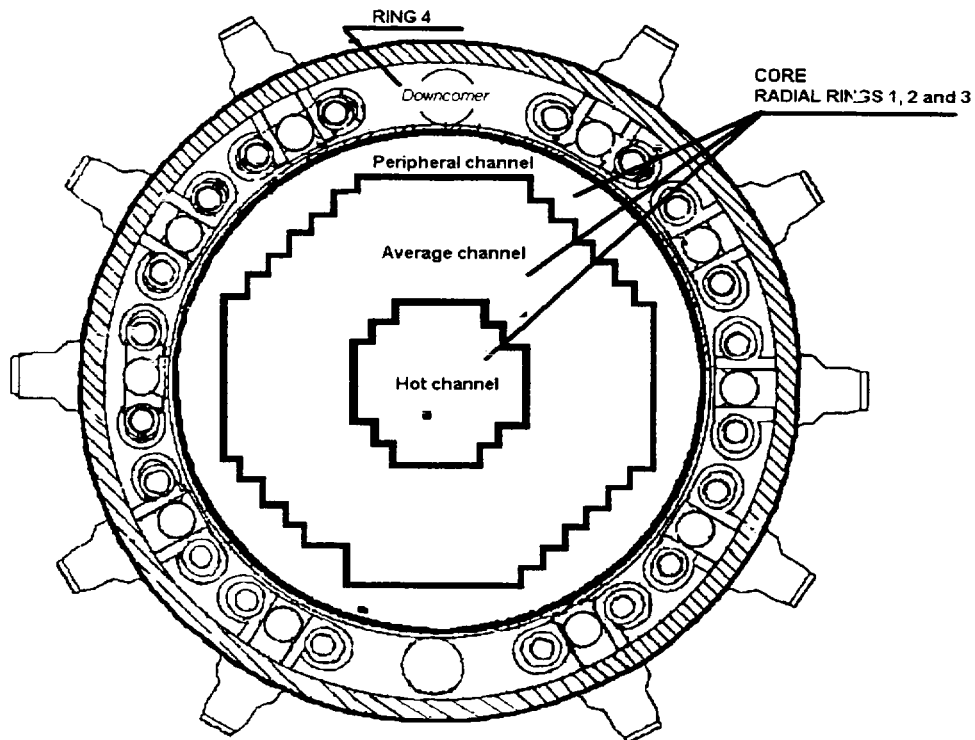

Figure 5.- Vessel radial nodalization.

The first level extends from the vessel bottom to the top control rod drive housings. The second one ends at the jet pumps discharge support ring. The third and fourth ones go from this support ring up to the core bottom.

The Core is divided into three axial levels of different lengths (level 5 to level 7). The neutronic core region, in the CHAN component, is separated into 9 hydraulics levels. Note that, the top of the jet pumps (end of fifth level) is located at 2/3 of the total core axial active length.

Instead of individual steam separators and dryer components, a perfect separator option is used for axial level 9. This component allows the vapour to continue upward into the axial level 10 and liquid to drain radially outward in the downcomer region. "Double-sided lab models" account for the heat capacity and transmission within vessel internals.

VESSEL	1	VESSEL
CHAN	36	84 PERIPHERAL CHANNELS
CHAN	38	288 AVERAGE CHANNELS
CHAN	40	28 HOT CHANNELS
FILL	61	FEED WATER FILL
PIPE	60	FEED WATER
PIPE	31	ISOLATE CONDENSER
PIPE	70	PIPE OF CORE SPRAY
PIPE	87	CENTRAL GUIDE TUBE
PIPE	88	AVERAGE GUIDE TUBE
PIPE	89	PERIPHERICAL GUIDE TUBE
FILL	82	GUIDE TUBE ENTRANCE
FILL	83	GUIDE TUBE ENTRANCE
FILL	84	GUIDE TUBE ENTRANCE
PIPE	92	HPCI TURBINE DISCHARGE
PUMP	22	RECIRCULATION PUMP "B"
PUMP	4	RECIRCULATION PUMP "A"
TEE	20	RECIRCULATION SUCTION LINE
TEE	24	RECIRCULATION DISCHARGE LINE
JETP	25	JETPUMP LOOP "B"
TEE	50	MAIN STEAM LINE FROM THE VESSEL
TEE	52	MAIN STEAM LINE FROM THE VESSEL
TEE	55	MAIN STEAM LINE TO THE TURBINE
TEE	6	RECIRCULATION DISCHARGE LINE
JETP	7	JETPUMP LOOP "A"
TEE	8	RECIRCULATION SUCTION LINE "A"
VALVE	21	RECIRCULATION SUCTION VALVE
VALVE	23	RECIRCULATION DISCHARGE VALVE
VALVE	3	RECIRCULATION SUCTION VALVE "A"
VALVE	5	RECIRCULATION DISCHARGE VALVE
VALVE	51	RELIEF & SAFETY/RELIEF VALVES SET
VALVE	53	SAFETY VALVES SET
VALVE	54	ISOLATION MAIN STEAM VALVE
VALVE	68	BYPASS VALVE
VALVE	69	CONTROL VALVE
VALVE	32	ISOLATION CONDENSER LINE VALVE
BREAK	56	WETWELL BOUNDARY CONDITION
BREAK	57	BYPASS BOUNDARY CONDITION
BREAK	58	TURBINE BOUNDARY CONDITION
BREAK	5	DRYWELL BOUNDARY CONDITION

Table 2.- Components of Garoña NPP input deck.

Inside the VESSEL component, axial level 1 and axial level 2, the PIPES components 87, 88, 89 model the control rod guide tubes. These three pipes represent 97 real control guide tubes. The guide tubes were modelled from the top of the control rod drive housing to the core plate. The heat transfer between the fluid in the guide tubes and the lower plenum has also been taken into account.

Fuel bundle modelling is accomplished by using CHAN component simulating the 84 peripheral bundles by CHAN component number 36, 288 average bundles by CHAN component number 38 and 28 hot bundles by number 40.

Finally, the main plant control systems have been simulated. Pressure control allows valve 69 (turbine control valve) position to be controlled in order to regulate reactor pressure. A very detailed feedwater - level control system is simulated in the main operational modes. The so called "three elements" level control mode is normally used and additionally, the possibility of changing to flow control mode is also contemplated.

Core power model

The TRAC/BF1/MOD1 code has three methods of simulating core power response. The first method is a user-supplied table lookup scheme. The second method employs a space-independent reactor kinetics model with reactivity feedback. This model is useful for simulating transients where time-dependent spatial variations in the core power distribution are not significant. The third method employs a one-dimensional, two-group, neutron transport model that solves the one-dimensional steady-state and time-dependent neutron diffusion equations in a rectangular geometry.

To simulate the recirculation pump trip transient, a reactor point kinetics model with trip initiated reactivity feedback and trip initiated scram reactivity insertion was turned on to calculate the core power rate. The reactivity feedback model for void, boron, moderator and fuel temperature currently employs reactivity coefficients that are polynomial approximations using core-averaged properties. In this case, the reactivity

feedback coefficients have been calculated with the PANACEA code. There had been no boron injection. The set of reactivity feedback coefficients used in this simulation is listed in Table 3.

Parameter	Value		
Fuel reactivity coefficients	-1.729E-5	-1.264E-5	5.298E-6
Moderator temperature reactivity coefficients ¹	-1.158E-4	4.63E-7	-9.69E-10
Void reactivity coefficients	-2.00E-1	7.770E-1	-1.900

Table 3.- Values for key feedback phenomena.

The calculation of reactivity feedback is initially done on a cell-by-cell basis. The reactor core is partitioned into channel regions (using CHAN component) and bypass regions (using VESSEL component). Contributions for the moderator, Doppler, void and boron feedback coefficients are globally summed over all CHAN and VESSEL cells. The same reactivity coefficient polynomial curve fits are used for the CHAN and bypass VESSEL cells.

¹ Default values provided by TRAC-BF1.

V. STEADY STATE CALCULATIONS

The calculation of the steady state with TRAC-BF1 has been developed in two steps. First of all, a null transient calculation was carried out setting the initial plant conditions of pressure, level and recirculation flow. Secondly, the use of EXTRACT subcode allowed us to extract steady state component data and configures a new steady state input deck. The main measured data of the plant against the steady-state data obtained with TRAC-BF1 are shown in Table 4.

Parameter	Plant data	TRAC-BF1
Thermal power 100% (MW)	1381	1381
Dome pressure (Kg/cm ² rel)	70.9	70.9
Reactor level (cm rel ²)	64	65
Feedwater flow (Tm/h)	FW-A 1250 FW-B 1250	2500
Feedwater temperature (° C)	182	182
Core flow (T/h)	20190	20050
RP speed A (RPM)	1251	1251
RP speed B (RPM)	1315	1315
Recirculation flow A (l/s)	1710	1705
Recirculation flow B (l/s)	1710	1705

Table 4.- Steady - state results at nominal power.

² Centimeters relative to zero-scale (12.22 m from the bottom head) which corresponds to bottom of steam separators.

VI. CALCULATION RESULTS

The analysis of the main TRAC-BF1 results together with the available plant data will be carried out in this section. The real data were extracted from the Santa María de Garoña NPP Transient Analyser; a computer system that is able to store the main transient data with an interval of twenty milliseconds.

The initial transient conditions were obtained from the steady state calculation, which are described in chapter V above. A “null transient” during 55 seconds, from the steady state reached, was run with the reactivity feedback models activated to verify the stability of steady state conditions.

Nuclear Power

In the initial state (0 – 55 s), there is no increase in the main variables that affect the direct behaviour of reactor power. Void fraction (Figure 6), moderator temperature (Figure 7) and fuel temperature (Figure 8) remain constant; there is no reactivity insertion.

At 55 s the recirculation pump trip starts and the core power evolution (Figure 9) is directly related to the abrupt flow rate decrease through the core. This flow reduction leads to a sudden increase in the average void fraction in the core. The negative reactivity inserted (Figure 10) causes the power to go down. There is, also, an additional positive reactivity from the Doppler effect (Figure 11) as results of the fuel cool down. Subsequently, the core flow starts to increase again because the operating jet pumps begin to provide more forced circulation flow due to the reactor pressure decrease. For this reason, the power is stabilised around 67.5 % (TRAC-BF1 and plant data) at about 80 s.

Average void fraction

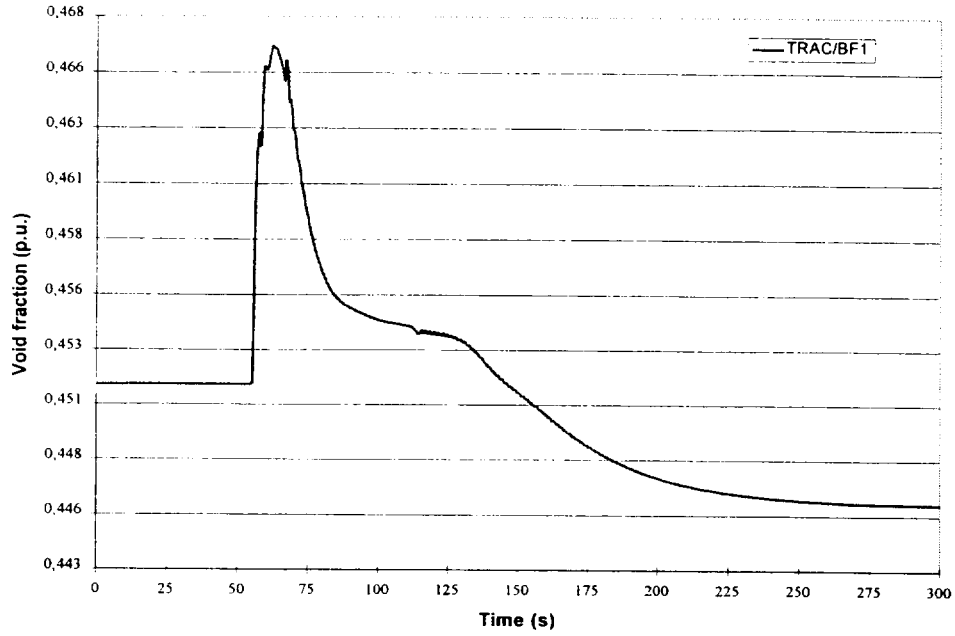

Figure 6.- Average void fraction calculated with TRAC-BF1.

Average moderator temperature

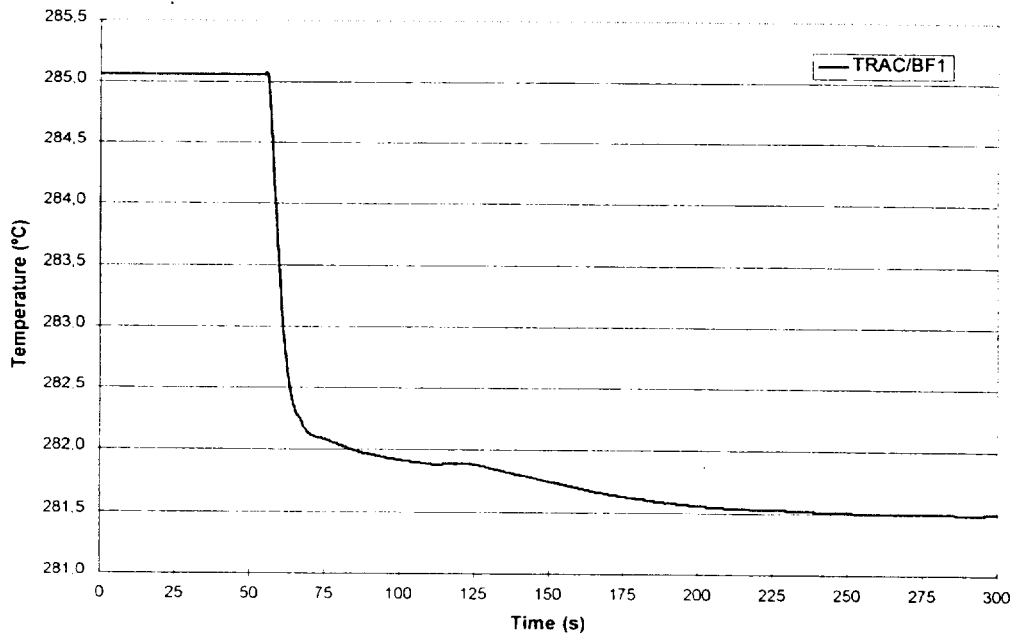

Figure 7.- Average moderator temperature, TRAC-BF1.

Average fuel temperature

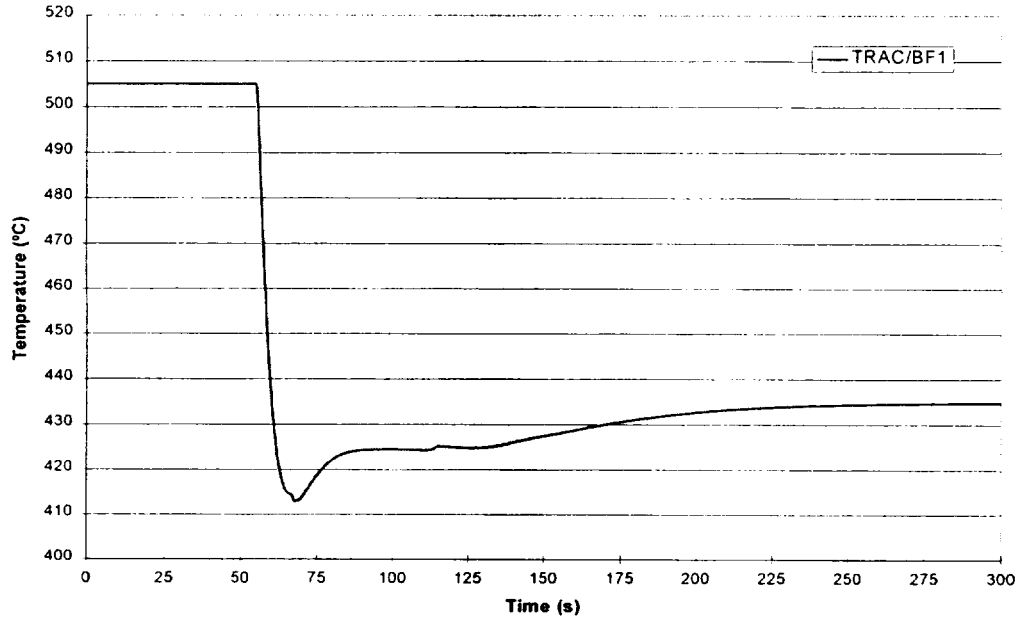

Figure 8.- Average fuel temperature, TRAC-BF1.

Total reactor power

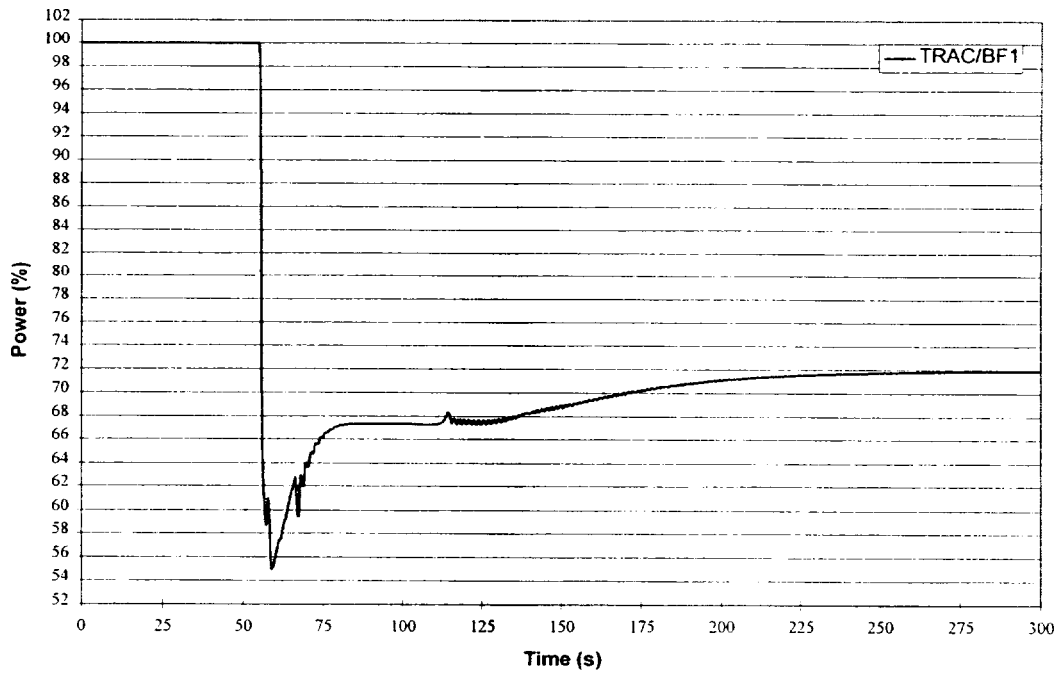

Figure 9.- Core thermal power, TRAC-BF1 calculation.

Void reactivity

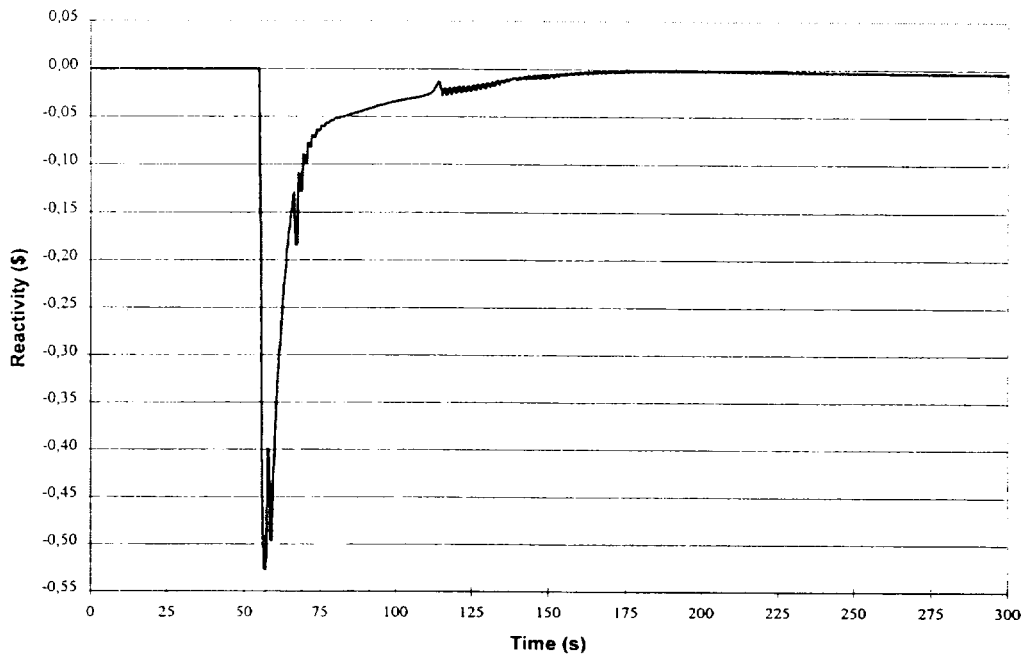

Figure 10.- Void fraction reactivity, TRAC-BF1.

Doppler reactivity

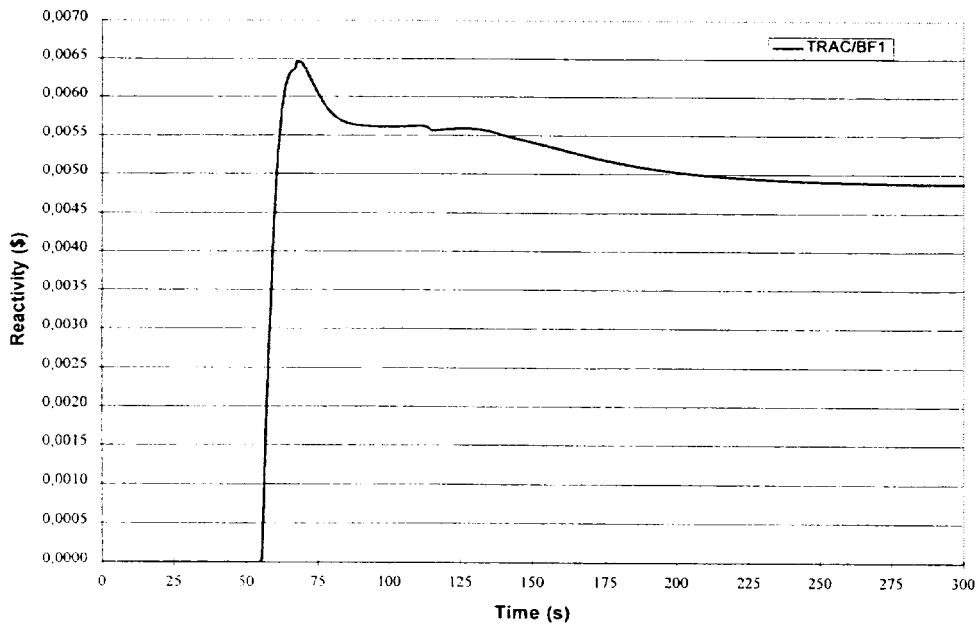

Figure 11.- Doppler reactivity, TRAC-BF1.

On the other hand, the steam flow to the turbine and the feedwater flow to the reactor are reduced and consequently, the feedwater heater efficiency is modified. For this reason, the feedwater temperature starts to decrease 20 s after the trip. The feedwater temperature drops approximately 14 ° C; this variation was introduced in the input deck as a table, which shows the behaviour of the variable along the actual transient. Figure 12 displays the measured and the input signal in TRAC-BF1.

Figure 13 presents the calculated moderator temperature reactivity. The moderator temperature cool down causes reactor power to begin to increase again due to positive reactivity insertion. At 250 s the reactor power values are close to 72 / 70 % (TRAC-BF1/ plant data).

The average void fraction in the core in the final steady state will not be the same as the initial state. The positive reactivity inserted from the Doppler effect has to be balanced by moving down the boiling boundary in the fuel channel.

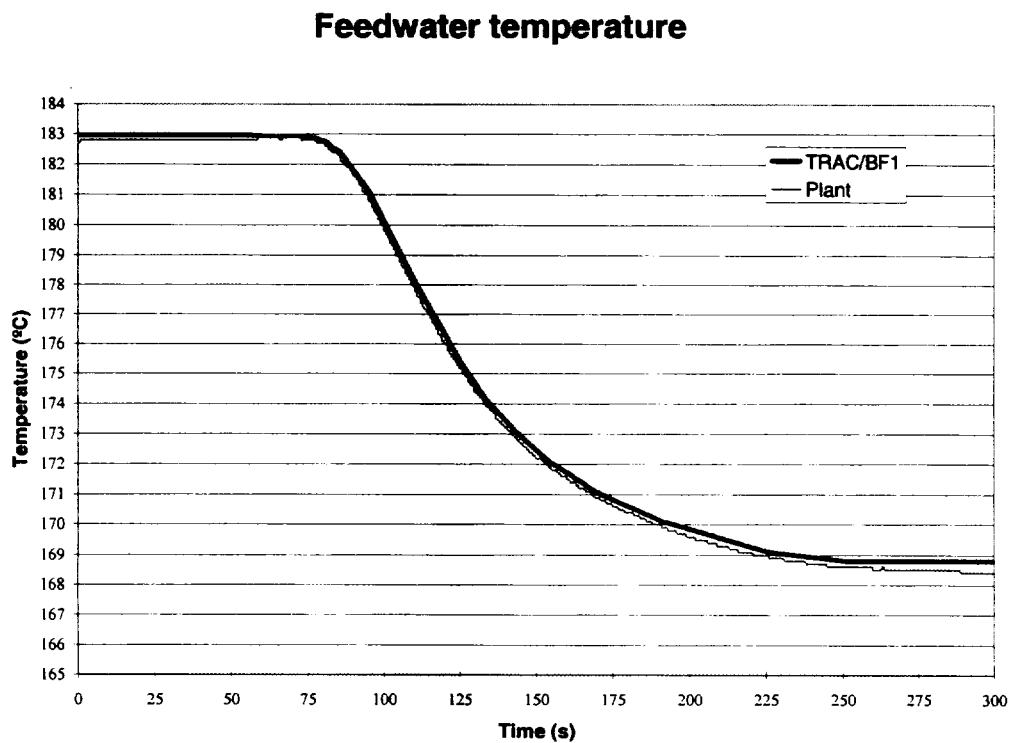

Figure 12.- Evolution of feedwater temperature.

Moderator temperature reactivity

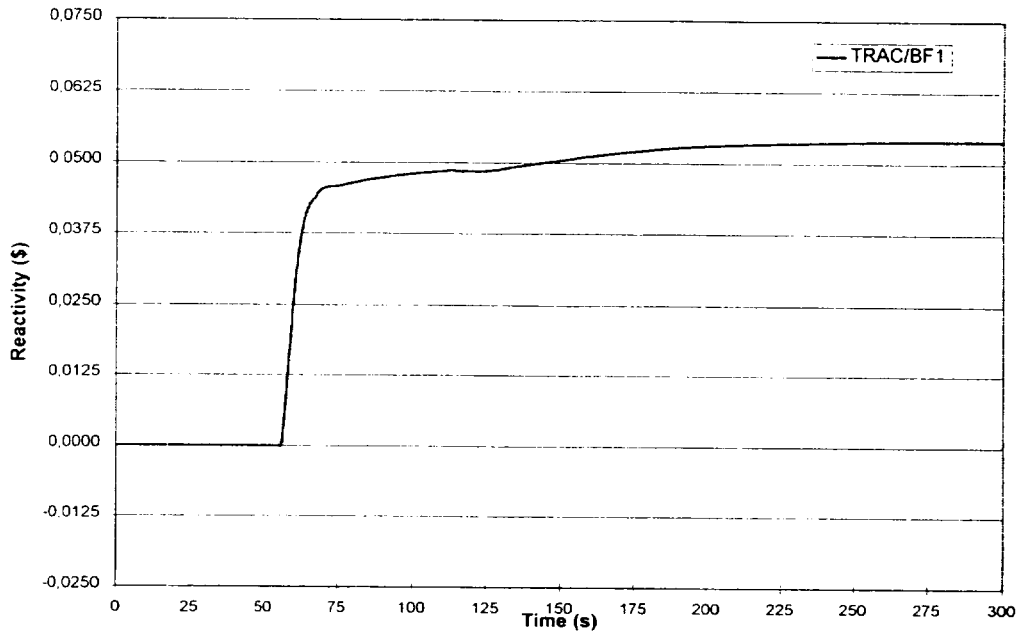

Figure 13.- Moderator temperature reactivity, TRAC-BF1.

Total reactivity

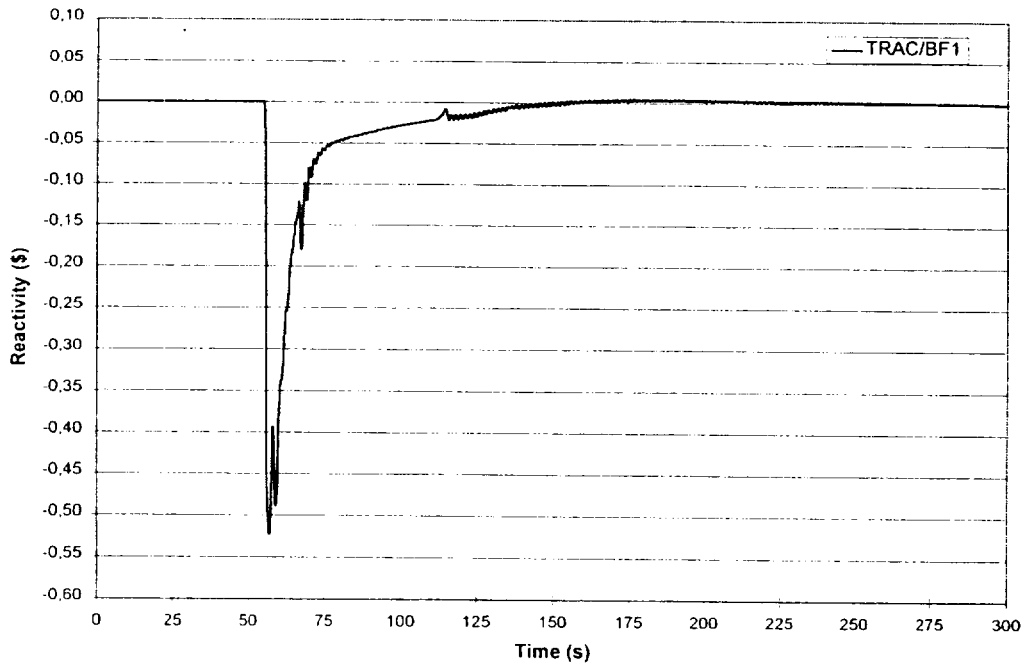

Figure 14.- Total reactivity, TRAC-BF1.

Figure 14 shows total reactivity, in which the main contribution, in the first seconds of the transient, is the void fraction. The effect of the moderator temperature cool down starts to affect reactivity from 130 s, when the reactivity void fraction effect begins to decrease.

Finally, Figure 15 shows the calculated and measured behaviour of the average power range monitor (APRM) signal during the transient. The TRAC-BF1 signal is based on the percent rated core power to represent the APRM signal. A good degree of accuracy is attained for the nuclear power final value and evolution (72 / 70 %, TRAC-BF1/ plant data) considering that the solution scheme used in TRAC-BF1 to integrate point kinetics equations is a Runge-Kutta integration method. Moreover, it is necessary to take into account that the xenon and iodine effects were not included in the TRAC simulation.

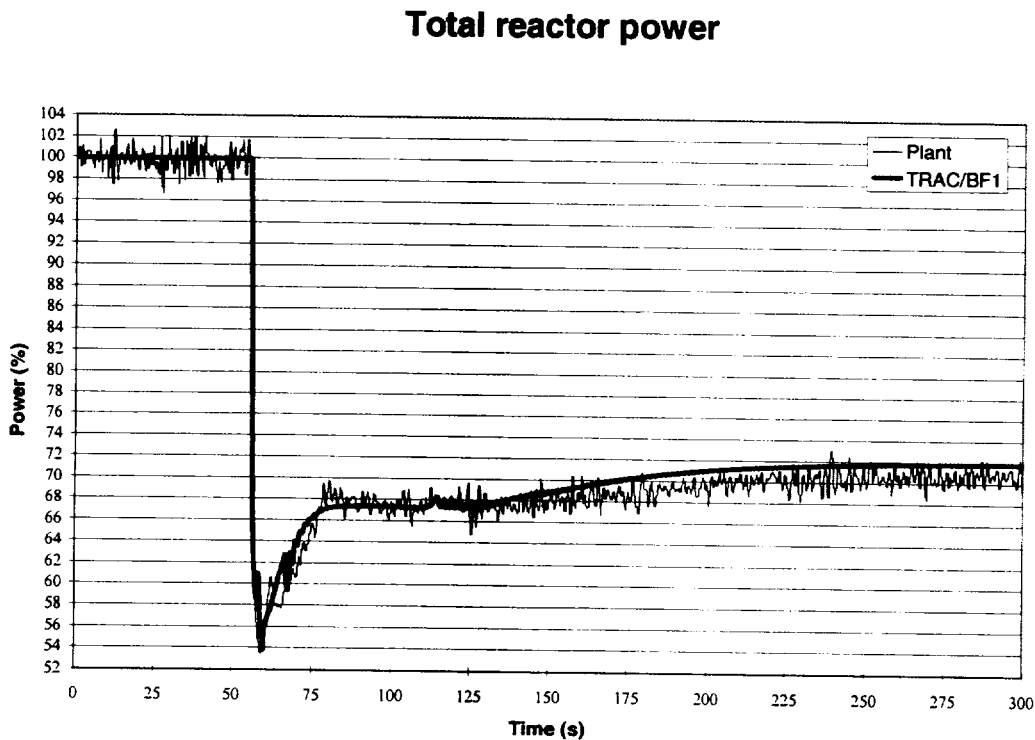

Figure 15.-Total reactor power, TRAC-BF1 and plant data.

Reactor Pressure

When the pressure control is working, the pressure measured in the sensor line (upstream to the control valve) is compared to the pressure regulator set-point. The nominal steam flow rate causes a pressure drop in the steam lines of $3,87 \text{ kg/cm}^2$. Therefore, while the nominal reactor pressure is $70,65 \text{ kg/cm}^2$, the sensor line pressure is $66,78 \text{ kg/cm}^2$. Figure 16 shows steam flow rate-pressure relation.

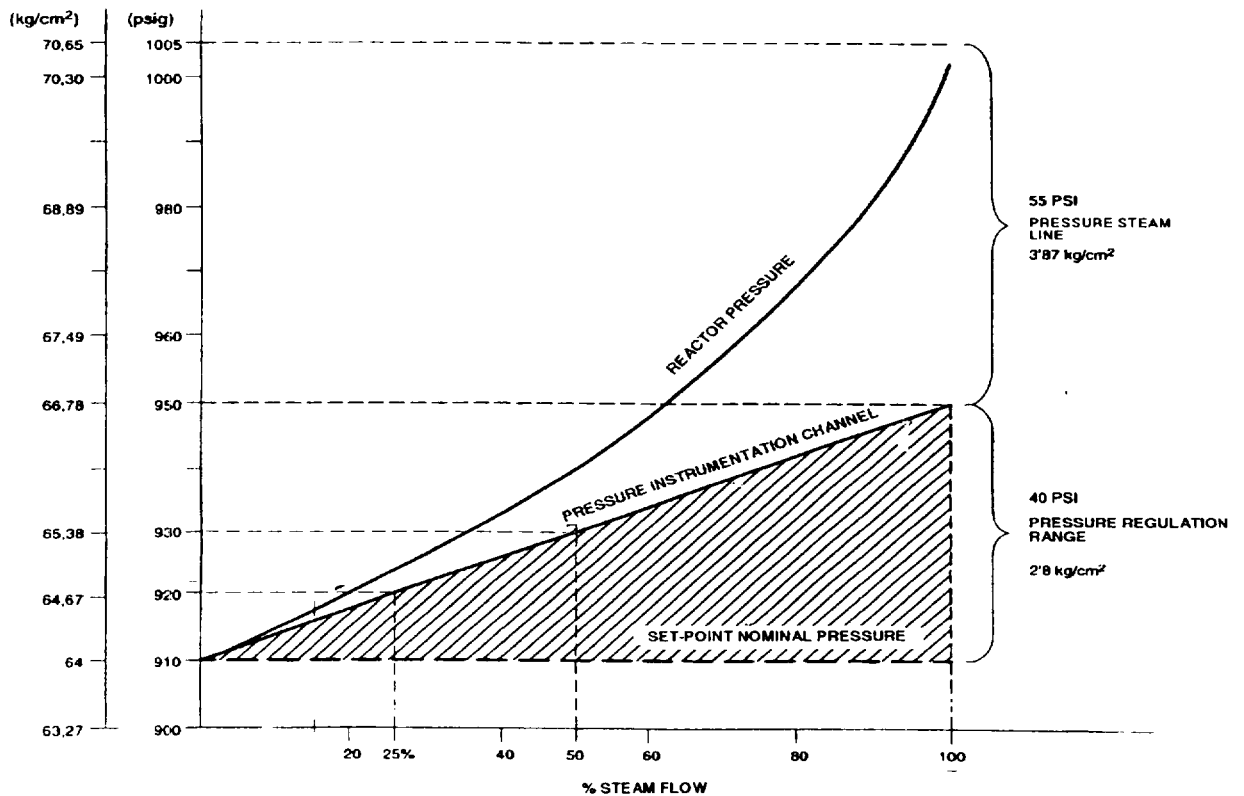

Figure 16.- Pressure at the sensor line and regulator set-point.

As a result of the recirculation pump trip, the core flow rate was decreased and therefore, the pressure goes down nearly 2 kg/cm^2 due to the reduction in the steam flow generation rate. At 250 s, the pressure reaches about 68.0 kg/cm^2 (TRAC-BF1/ plant data) and remains constant the rest of the transient. Figure 17 displays the calculated

and measured data for steam dome pressure variation with time during the transient. The results obtained by TRAC-BF1 are in excellent agreement with the measured data.

The difference in power final level between plant data and the code leads to steam flow variations between TRAC-BF1 and plant data (Figure 18). However, the agreement is good considering that an ideal separator-dryer model (included in VESSEL component) has been selected to perform this analysis.

Reactor Pressure

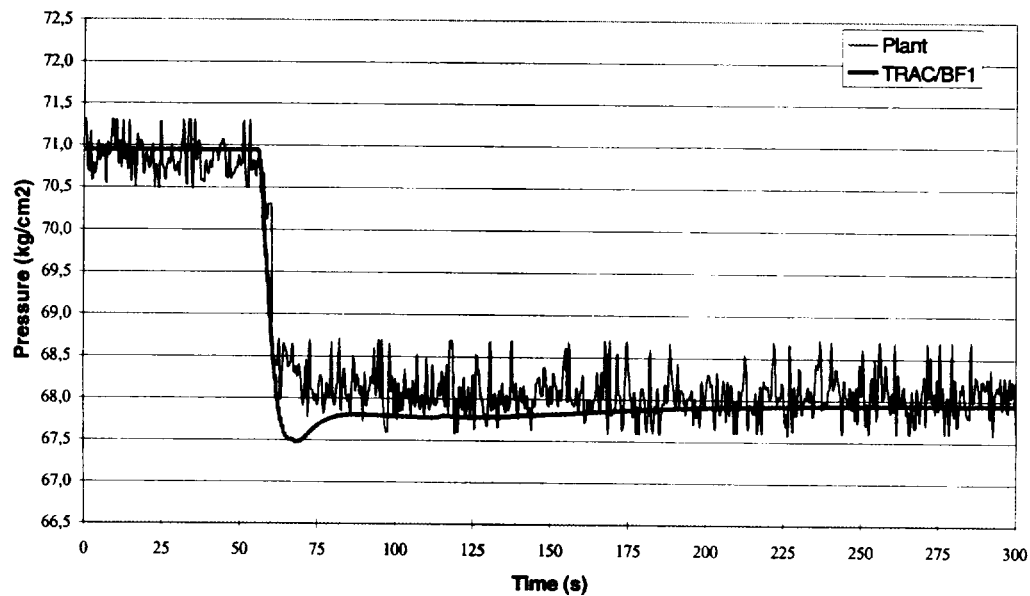

Figure 17.- Steam dome pressure, TRAC-BF1 and plant data.

Total steam flow

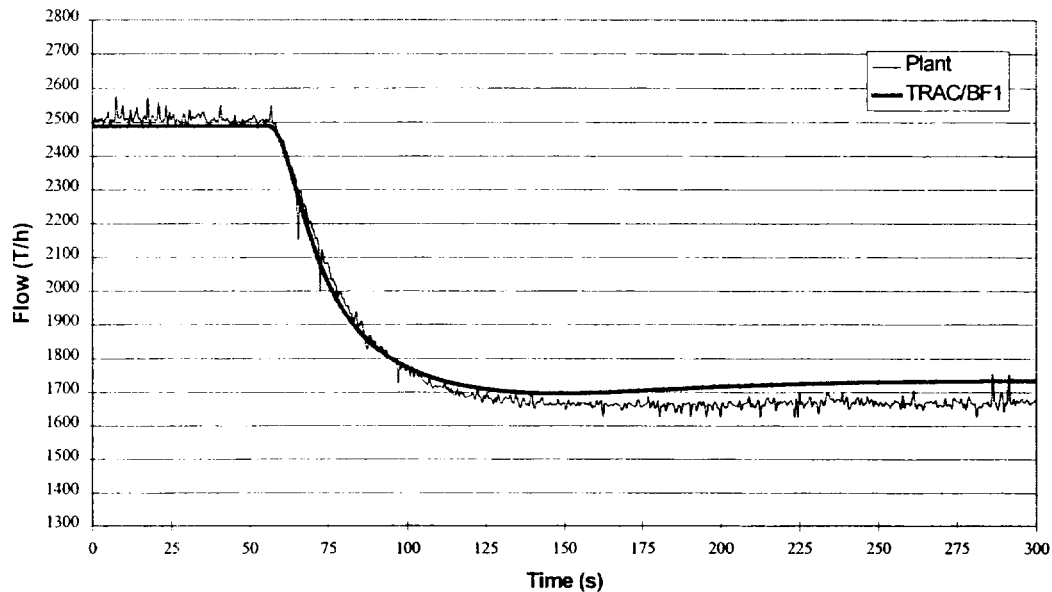

Figure 18.- Steam flow evolution, TRAC-BF1 and plant data.

Reactor Level

After the recirculation pump trip, ten jet pumps quickly reduce the amount of flow suctioned and additional flow rate from the lower plenum starts to enter jet pump diffusers, due to the pressure decrease inside the jet pumps. Under these conditions the downcomer water level, of the plant, rises quickly, from 64 to 90 cm. The level control demands less feedwater flow and the level decrease towards its initial state.

Figure 19 shows the measured and calculated change in the sensed reactor water level with time. As shown in Figure 19, the water level peak and the time of its occurrence are predicted remarkably well. In fact, during the initial stage of the transient, the TRAC-BF1 calculations predict the measured water level very closely. As

the plant level starts to return to its original value beyond 80 s, slight discrepancies in the subsequent TRAC-BF1 level evolution can be observed.

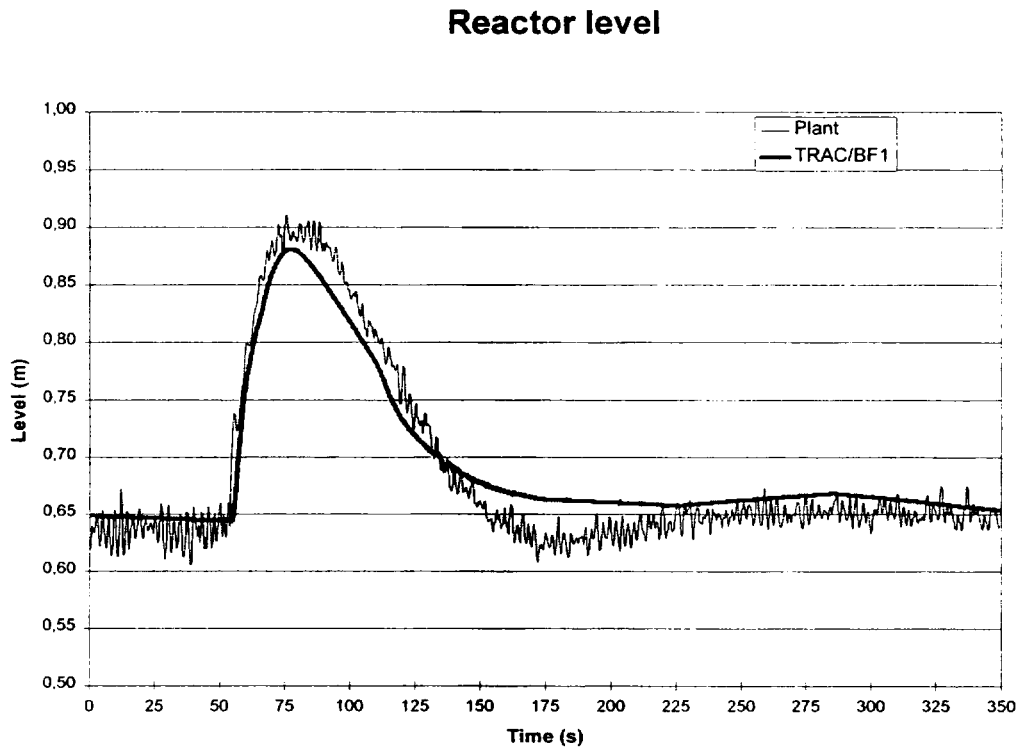

Figure 19.- Comparison between calculated and level plant data.

Recirculation Flow

Recirculation pump “A” trip causes a change in pump “B” working conditions. The reactor pressure variation induces a slight displacement along the pump characteristic curve. Lower plenum pressure decreases and the reactor pressure is also reduced due to the steam flow reduction, as can be seen above.

Figure 20 shows flow rate pump “B” evolution. An increase in the flow can be observed with regard to steady conditions in response to the pressure drop. The final

value of recirculation flow calculated with TRAC is 1770 l/s, very close to plant data, that is about 1760 l/s.

Recirculation flow rate "B"

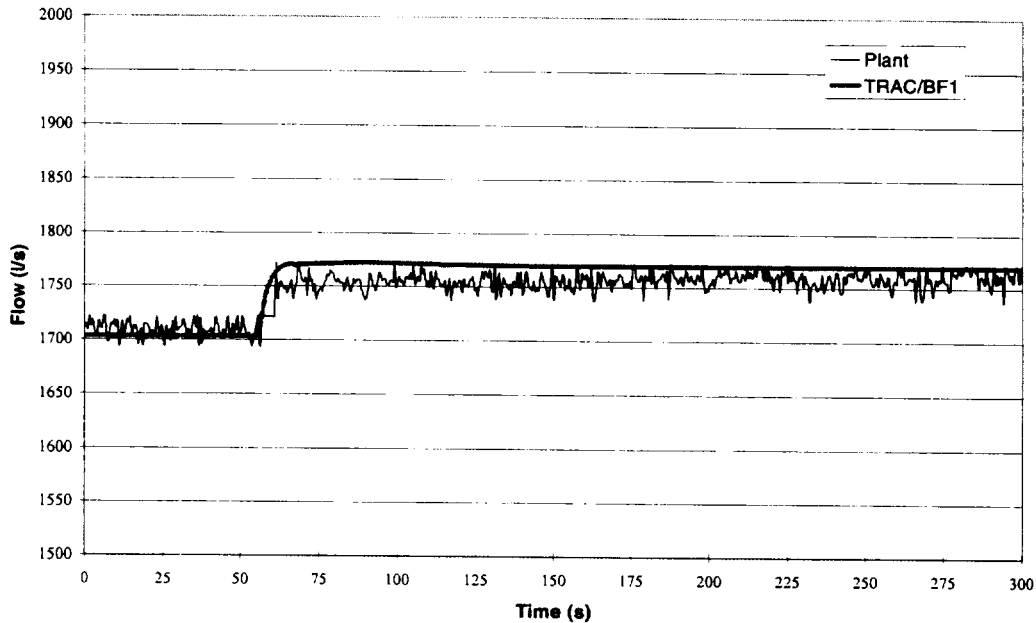

Figure 20.- Flow rate pump "B", TRAC-BF1 and plant data.

Pump "A" flow rate reduction is shown in Figure 21. The plant recirculation flow instrumentation is not able to measure backflow and the flow measured is positive throughout the transient. The recirculation discharge valve is completely closed at 120 s and the recirculation flow is reduced to zero in this loop.

Besides, the inactive jet pumps are backflowing. A fraction of this backflow enters the recirculation loop until the operating crew closes the discharge valve. On this occasion, the reaction was very fast and it has been estimated that the valve started to close 30 s after the recirculation pump trip. However, most backflow directly reaches the downcomer. Real data about the opening and closing of the discharge valve have been included in the TRAC-BF1 input deck.

Recirculation flow rate "A"

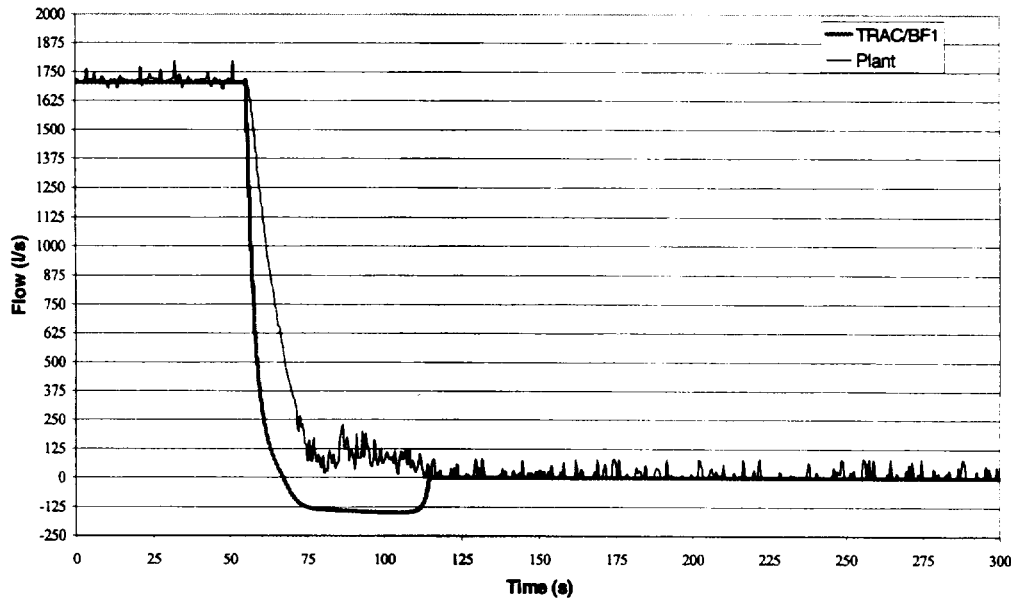

Figure 21.- Flow rate pump "A", TRAC-BF1 and plant data.

Core Flow

The jet pump core flow measurement system is calibrated to measure core flow when both sets of jet pumps are in forward flow and the total core flow is the sum of the indicated loop flows. However, for single loop operation, the inactive jet pumps will be backflowing, so the measured flow in the backflowing jet pumps must be subtracted from the measured flow in the active loop, in order to estimate core flow. This is because the plant core flow instrumentation is not able to measure backflow and the flow measured is positive throughout the transient. Figure 22 shows the comparison between the indicated core flow in the plant and TRAC-BF1.

The total core flow will ordinarily be measured by the formula,

$$(\text{Total Core Flow}) = (\text{Active Loop Indicated Flow}) - C (\text{Inactive Loop Indicated Flow})$$

where the factor $C = 0.95$ is the recommended (conservative) value for measurement of core flow during Single Loop Operation (SLO).

Figure 23 shows the comparison between TRAC-BF1 and the plant flow data corrected with factor C . The uncertainty in measured core flow should be 6% of rated core flow for single loop operation. The calculated flow in plant is about 10700 T/h; the 6 % of uncertainty in measured core flow means that the measured core flow was (10050, 11350). Note that the TRAC-BF1 calculation (about 11600 T/h) is slightly higher than the core flow estimation of the plant data.

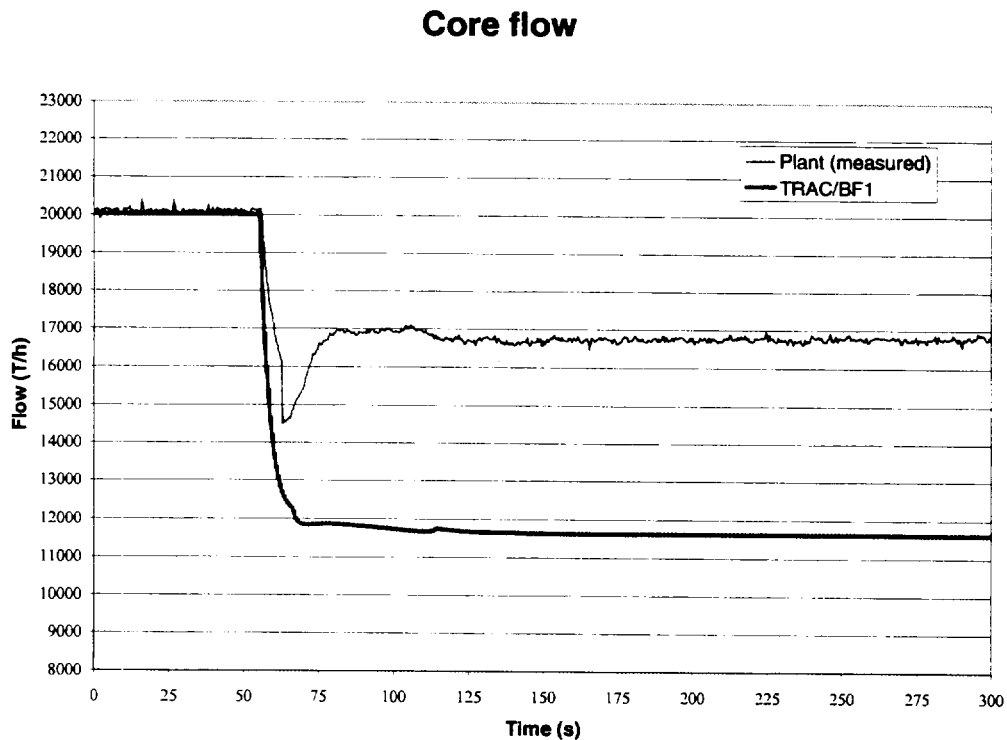

Figure 22.- Core flow, TRAC-BF1 and measured plant signal.

Core flow

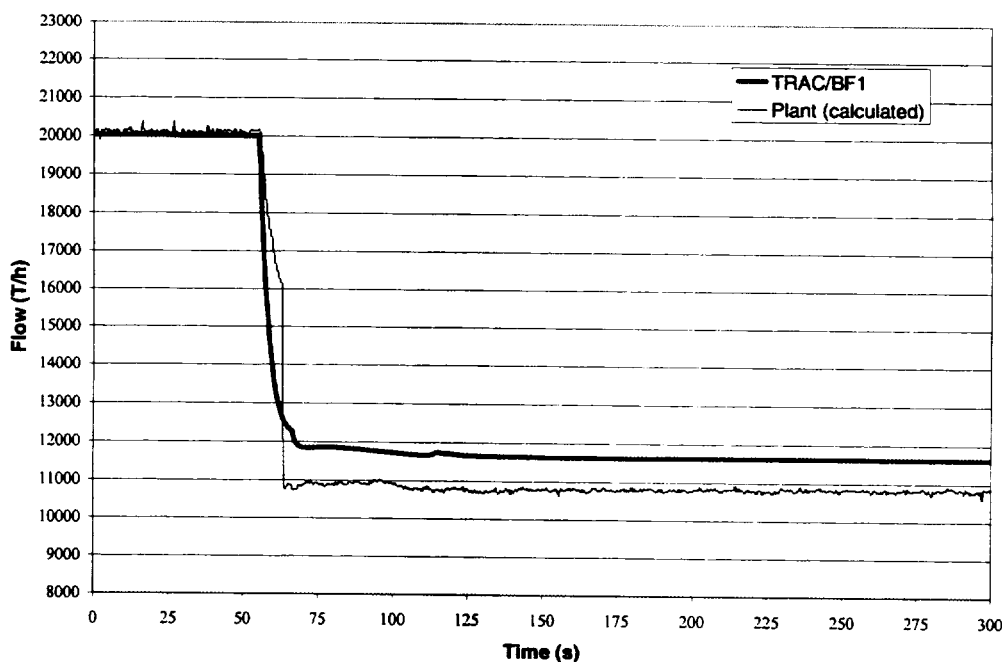

Figure 23.- Core flow, TRAC-BF1 and calculated plant data.

Feedwater Flow

The feedwater flow is controlled by the level control or feedwater control system. This control is based on a level error signal and mismatch between steam and feedwater flows. After the trip, the level control reacts to level rise and leads to a decrease in the demand of feedwater flow.

Figure 24 is a representation of feedwater flow as a function of time. It can be seen that the TRAC-BF1 prediction of feedwater flow is in close agreement with the measured feedwater flow. However, for the second part of the transient, where feedwater flow accommodates to the new steady state, the TRAC-BF1 predicted flow differed from the plant data as much as 6 %. Nevertheless, the overall agreement between calculated and measured feedwater flow rate is adequate.

Total feedwater flow

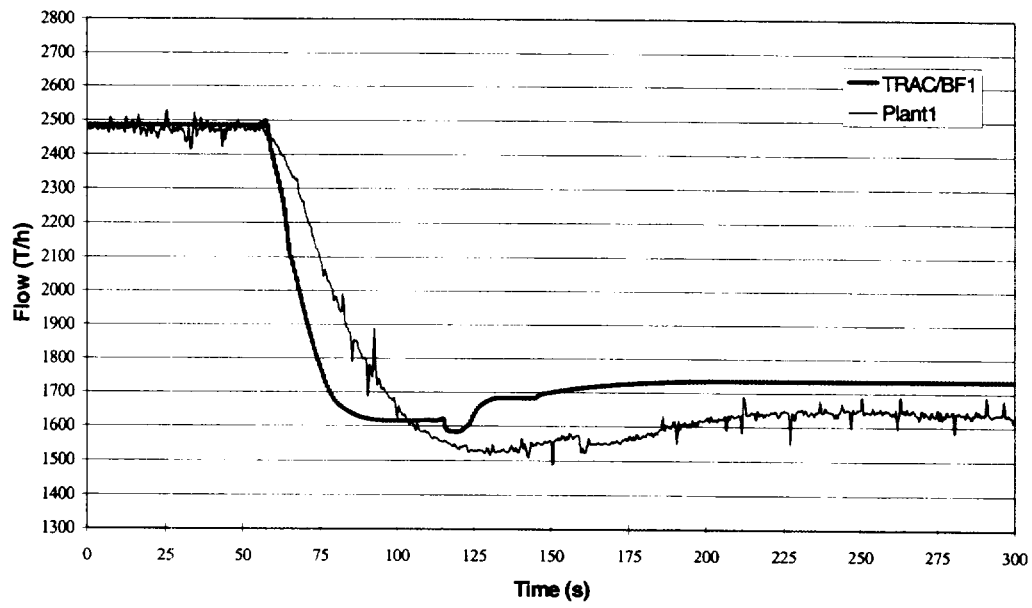

Figure 24.- Total feedwater flow, TRAC-BF1 and plant data.

VII. CONCLUSIONS

A model of Santa María de Garoña NPP has been developed and proven to be adequate for operational transient analysis. The transient of a trip of one recirculation pump has been reproduced with this model and results have been compared with plant data.

A good degree of accuracy is attained for the thermal power final value and evolution, considering the propagation errors inherent to the solution scheme used in TRAC-BF1 to integrate point kinetics equations.

The agreement between the results in pressure evolution is good considering that an ideal separator-dryer model has been selected to perform this analysis.

As for downcomer level, the agreement is good during the increase level stage. Slight discrepancies in the subsequent level evolution can be observed but it should be taken into account that the total range of the level instrumentation is 3 meters and the discrepancies are around 3 to 5 cm (1.6 % of error).

Core flow during single loop operation is measured in a conservative way so that there are no significant discrepancies between core flow evolution calculated by TRAC-BF1 and the corrected data plant.

Control systems models closely simulate the response of plant controllers. Further improvements or adjustments of feedwater control could more accurately evaluate behaviour of feedwater flow.

VIII. REFERENCES

- [1] NUCLINOR, S.A., "*Informe disparo Grupo A de recirculación (09/06/93)*", REV.0, July 1993.
- [2] NUCLINOR, S.A., "*Informe disparo Grupo A de recirculación (13/08/93)*", REV.0, September 1993.
- [3] G.H. Chao, D.C. Serell, "*Core Flow Measurement and Uncertainty Analysis During Single Recirculation Pump Operation*", NEDE-25263, GENERAL ELECTRIC, February 1980.
- [4] Division of Systems Research, "*TRAC-BF1/MOD1: An Advanced Best-Estimate Computer Program for BWR Accident Analysis*", NUREG/CR -4356, Vol.1- Model Description, Vol.2- User' s Guide, June 1992.
- [5] Division of Systems Research, "*TRAC-BF1/MOD1: Models and Correlation's*", NUREG/CR -4391, August 1992.
- [6] NUCLINOR, S.A., "*Cuadernos de Cálculo. NUCLE-01*", REV.0, November 1994.
- [7] ENUSA, S.A., "*Informe de diseño nuclear para Santa María de Garoña. Ciclo 17*".

BIBLIOGRAPHIC DATA SHEET

(See instructions on the reverse)

1. REPORT NUMBER
(Assigned by NRC, Add Vol., Supp., Rev.,
and Addendum Numbers, if any.)

NUREG/IA-0193

2. TITLE AND SUBTITLE

Assessment of Single Recirculation Pump Trip Transient in Santa Maria
de Garona Nuclear Power Plant With TRAC-BF1/MOD1, Version 0.4

3. DATE REPORT PUBLISHED

MONTH YEAR

January 2001

4. FIN OR GRANT NUMBER

5. AUTHOR(S)

C. Garcia de la Rua, J. Garcia Garcia, J.V. Lopez Montero

6. TYPE OF REPORT

Technical

7. PERIOD COVERED (Inclusive Dates)

8. PERFORMING ORGANIZATION - NAME AND ADDRESS (If NRC, provide Division, Office or Region, U.S. Nuclear Regulatory Commission, and mailing address; if contractor, provide name and mailing address.)

NUCLEAR, S.A.
C/ Herman Cortes 26
39080 Santander
SPAIN

9. SPONSORING ORGANIZATION - NAME AND ADDRESS (If NRC, type "Same as above"; if contractor, provide NRC Division, Office or Region, U.S. Nuclear Regulatory Commission, and mailing address.)

Division of Systems Analysis and Regulatory Effectiveness
Office of Nuclear Regulatory Research
U.S. Nuclear Regulatory Commission
Washington, DC 20555-0001

10. SUPPLEMENTARY NOTES

11. ABSTRACT (200 words or less)

This report has been prepared by NUCLENOR in the framework of the CAMP/SPAIN Project. It represents one of the application calculations submitted in fulfillment of the bilateral agreement for cooperation in thermal hydraulic activities between the Consejo de Seguridad Nuclear of Spain (CSN) and the United States Nuclear Regulatory Commission (USNRC). The work consisted in using the TRAC-BF1 code to reproduce a transient that took place at Santa Maria de Garona (NPP) on June 9, 1993. The event was originated by a transformer failure that led to a loss of generator excitation and consequently a recirculation pump trip. Santa Maria de Garona NPP is a 1381 MWth General Electric Boiling Water Reactor 3 (GE BWR/3) owned by NUCLENOR, S.A., a Spanish utility that participates in the CAMP Program as a member of UNIDAD ELECTRICA S.A. (UNESA). The simulation has been carried out with the TRAC-BF1/MOD1, code, version 0.4, running on a Workstation Hewlett Packard c180u under HP-UX operating system. As a result of the analysis it is felt that TRAC-BF1 is capable of reproducing the plant behavior with an acceptable degree of accuracy. The main phenomena of the transient have been calculated correctly.

12. KEY WORDS/DESCRIPTORS (List words or phrases that will assist researchers in locating the report.)

TRAC-BF1
Recirculation Pump Trip
BWR

13. AVAILABILITY STATEMENT

unlimited

14. SECURITY CLASSIFICATION

(This Page)

unclassified

(This Report)

unclassified

15. NUMBER OF PAGES

16. PRICE

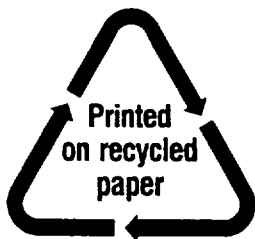

Federal Recycling Program

NUREG/IA-0193

ASSESSMENT OF SINGLE RECIRCULATION PUMP TRIP TRANSIENT IN SANTA MARIA
DE GARONA NUCLEAR POWER PLANT WITH TRAC-BF1/MOD1, VERSION 0.4

JANUARY 2001

UNITED STATES
NUCLEAR REGULATORY COMMISSION
WASHINGTON, DC 20555-0001

OFFICIAL BUSINESS
PENALTY FOR PRIVATE USE, \$300