

NUREG-1556
Vol. 18

Consolidated Guidance About Materials Licenses

Program-Specific Guidance About
Service Provider Licenses

Draft Report for Comment

U.S. Nuclear Regulatory Commission

Office of Nuclear Material Safety and Safeguards

J.E. Whitten, H. Bermúdez, E. Reber



AVAILABILITY OF REFERENCE MATERIALS IN NRC PUBLICATIONS

NRC Reference Material

As of November 1999, you may electronically access NUREG-series publications and other NRC records at NRC's Public Electronic Reading Room at www.nrc.gov/NRC/ADAMS/index.html. Publicly released records include, to name a few, NUREG-series publications; *Federal Register* notices; applicant, licensee, and vendor documents and correspondence; NRC correspondence and internal memoranda; bulletins and information notices; inspection and investigative reports; licensee event reports; and Commission papers and their attachments.

NRC publications in the NUREG series, NRC regulations, and *Title 10, Energy*, in the Code of *Federal Regulations* may also be purchased from one of these two sources.

1. The Superintendent of Documents
U.S. Government Printing Office
P. O. Box 37082
Washington, DC 20402-9328
www.access.gpo.gov/su_docs
202-512-1800
2. The National Technical Information Service
Springfield, VA 22161-0002
www.ntis.gov
1-800-553-6847 or, locally, 703-605-6000

A single copy of each NRC draft report for comment is available free, to the extent of supply, upon written request as follows:

Address: Office of the Chief Information Officer,
Reproduction and Distribution
Services Section

U.S. Nuclear Regulatory Commission
Washington, DC 20555-0001

E-mail: DISTRIBUTION@nrc.gov

Facsimile: 301-415-2289

Some publications in the NUREG series that are posted at NRC's Web site address www.nrc.gov/NRC/NUREGS/indexnum.html are updated regularly and may differ from the last printed version.

Non-NRC Reference Material

Documents available from public and special technical libraries include all open literature items, such as books, journal articles, and transactions, *Federal Register* notices, Federal and State legislation, and congressional reports. Such documents as theses, dissertations, foreign reports and translations, and non-NRC conference proceedings may be purchased from their sponsoring organization.

Copies of industry codes and standards used in a substantive manner in the NRC regulatory process are maintained at—

The NRC Technical Library
Two White Flint North
11545 Rockville Pike
Rockville, MD 20852-2738

These standards are available in the library for reference use by the public. Codes and standards are usually copyrighted and may be purchased from the originating organization or, if they are American National Standards, from—

American National Standards Institute
11 West 42nd Street
New York, NY 10036-8002
www.ansi.org
212-642-4900

The NUREG series comprises (1) technical and administrative reports and books prepared by the staff (NUREG-XXXX) or agency contractors (NUREG/CR-XXXX), (2) proceedings of conferences (NUREG/CP-XXXX), (3) reports resulting from international agreements (NUREG/IA-XXXX), (4) brochures (NUREG/BR-XXXX), and (5) compilations of legal decisions and orders of the Commission and Atomic and Safety Licensing Boards and of Directors' decisions under Section 2.206 of NRC's regulations (NUREG-0750).

Consolidated Guidance About Materials Licenses

Program-Specific Guidance About
Service Provider Licenses

Draft Report for Comment

Manuscript Completed: May 2000
Date Published: May 2000

Prepared by
J.E. Whitten, H. Bermúdez, E. Reber

**Division of Industrial and Medical Nuclear Safety
Office of Nuclear Material Safety and Safeguards
U.S. Nuclear Regulatory Commission
Washington, DC 20555-0001**



COMMENTS ON DRAFT REPORT

Any interested party may submit comments on this report for consideration by the NRC staff. Comments may be accompanied by additional relevant information or supporting data. Please specify the report number NUREG-1556, Volume 18 draft in your comments, and send them by the date published in the Federal Register Notice to:

Chief, Rules Review and Directives Branch
U.S. Nuclear Regulatory Commission
Mail Stop T6-D59
Washington, DC 20555-0001

You may also provide comments at the NRC Web site, <http://www.nrc.gov>. See the link under "Technical Reports in the NUREG Series" on the "Reference Library" page. Instructions for sending comments electronically are included with the document, NUREG-1556, Volume 18 draft, at the web site.

For any questions about the material in this report, please contact:

Carrie Brown
Mail Stop: T-9C24
U.S. Nuclear Regulatory Commission
Washington, DC 20555-0001
Phone: 301-415-8092
E-mail: CXB@nrc.gov.

ABSTRACT

As part of its redesign of the materials licensing process, NRC is consolidating and updating numerous guidance documents into a single comprehensive repository as described in NUREG-1539, "Methodology and Findings of the NRC's Materials Licensing Process Redesign," dated April 1996, and draft NUREG-1541, "Process and Design for Consolidating and Updating Materials Licensing Guidance," also dated April 1996. Draft NUREG-1556, Vol. 18, "Consolidated Guidance about Materials Licenses: Program-Specific Guidance about Service Provider Licenses," dated May 2000, is the eighteenth program-specific guidance developed for the new process, and is intended for use by applicants, licensees, and NRC staff, and will also be available to Agreement States.

This document combines and updates the guidance found in the following draft regulatory guides: "Guide for the Application for a License for the Use of Radioactive Materials for Calibrating Radiation Survey and Monitoring Instruments," dated June 1985; "Guide for the Application for the Use of Radioactive Materials in Leak-Testing Services," dated June 1985; and "Guide for the Applications for the Use of Radioactive Materials in Servicing Preregistered Gauges, Measuring Devices, and Sealed Sources Used in Such Devices," dated June 1985. Additionally, NRC staff included information contained in the corresponding Standard Review Plans for these three draft regulatory guides.

This draft report takes a more risk-informed, performance-based approach to licensing service providers, and reduces the information (both the amount and the level of detail) needed to support an application for these activities. Note that this draft document is strictly for public comment and is not for use in preparing or reviewing service provider licenses until it is published in final form. It is being distributed for comment to encourage public participation in its development. NRC is requesting such comments as whether a risk-informed, performance-based approach to licensing is valid, as well as comments on the information provided about service providers. Please submit comments within 60 days of the draft report's publication. Comments received after that time will be considered, if practicable.

CONTENTS

ABSTRACT	iii
FOREWORD	ix
ACKNOWLEDGMENTS	xiii
ABBREVIATIONS	xv
1 PURPOSE OF DRAFT REPORT	1-1
2 AGREEMENT STATES	2-1
3 MANAGEMENT RESPONSIBILITY	3-1
4 APPLICABLE REGULATIONS	4-1
5 HOW TO FILE	5-1
5.1 PAPER APPLICATION	5-1
5.2 ELECTRONIC APPLICATION	5-2
6 WHERE TO FILE	6-1
7 LICENSE FEES	7-1
8 CONTENTS OF AN APPLICATION	8-1
8.1 ITEM 1: LICENSE ACTION TYPE	8-1
8.2 ITEM 2: APPLICANT'S NAME AND MAILING ADDRESS	8-1
8.3 ITEM 3: ADDRESS(ES) WHERE LICENSED MATERIAL WILL BE USED OR POSSESSED ..	8-3
8.4 ITEM 4: PERSON TO BE CONTACTED ABOUT THIS APPLICATION	8-4
8.5 ITEM 5: RADIOACTIVE MATERIAL	8-5
8.5.1 UNSEALED AND/OR SEALED BYPRODUCT MATERIAL	8-6
8.5.2 UNSEALED RADIOACTIVE MATERIAL	8-9
8.5.3 FINANCIAL ASSURANCE AND RECORD KEEPING FOR DECOMMISSIONING	8-10
8.7 ITEM 7: INDIVIDUAL(S) RESPONSIBLE FOR RADIATION SAFETY PROGRAM AND THEIR TRAINING AND EXPERIENCE	8-16
8.7.1 RADIATION SAFETY OFFICER (RSO)	8-16
8.7.2 AUTHORIZED USER	8-19
8.7.3 ANCILLARY PERSONNEL	8-20
8.8 ITEM 8: TRAINING FOR INDIVIDUALS WORKING IN OR FREQUENTING RESTRICTED AREAS (OCCUPATIONALLY EXPOSED INDIVIDUALS AND ANCILLARY PERSONNEL)	8-21
8.9 ITEM 9: FACILITIES AND EQUIPMENT	8-22
8.10 ITEM 10: RADIATION SAFETY PROGRAM	8-25
8.10.1 AUDIT PROGRAM	8-26
8.10.2 RADIATION MONITORING INSTRUMENTS	8-27
8.10.3 MATERIAL RECEIPT AND ACCOUNTABILITY	8-30
8.10.4 OCCUPATIONAL DOSE	8-34
8.10.5 PUBLIC DOSE	8-39
8.10.6 SAFE USE OF RADIONUCLIDES AND EMERGENCY PROCEDURES	8-42
8.10.7 SURVEYS	8-45
8.10.8 LEAK TESTS	8-52
8.10.9 MAINTENANCE	8-54
8.10.10 MINIMIZATION OF CONTAMINATION	8-56
8.10.11 TRANSPORTATION	8-57

CONTENTS

8.11	ITEM 11: WASTE MANAGEMENT	8-59
8.12	ITEM 12: FEES	8-66
8.13	ITEM 13: CERTIFICATION	8-67
9	AMENDMENTS AND RENEWALS TO A LICENSE	9-1
10	APPLICATIONS FOR EXEMPTIONS	10-1
11	TERMINATION OF ACTIVITIES	11-1

APPENDICES

Appendix A	List of Documents Considered in Development of this Draft NUREG	A-1
Appendix B	United States Nuclear Regulatory Commission Form 313	B-1
Appendix C	Suggested Format for Providing Information Requested in Items 5 through 11 of NRC Form 313	C-1
Appendix D	Checklist for License Application	D-1
Appendix E	Sample Licenses	E-1
Appendix F	Information Needed for Transfer of Control Application	F-1
Appendix G	Standard Sealed Source and Device Registration Certificate Format	G-1
Appendix H	Criteria for Acceptable Training and Experience for Authorized Users	H-1
Appendix I	Suggested [Specific Program] Audit Checklist	I-1
Appendix J	Radiation Monitoring Instrument Specifications and Model Survey Instrument Calibration Program	J-1
Appendix K	Material Ordering and Package Receipt and Opening	K-1
Appendix L	Guidance for Demonstrating that Unmonitored Individuals Are Not Likely to Exceed 10 Percent of the Allowable Limits	L-1
Appendix M	Guidance for Demonstrating that Individual Members of the Public will not Receive Doses Exceeding the Allowable Limits	M-1
Appendix N	Model Waste Disposal Program	N-1
Appendix O	Model Leak Test Program	O-1
Appendix P	Non-routine Maintenance Checklist	P-1

Appendix Q
Transportation Q-1

CONTENTS

FIGURES

Figure 2.1 U.S. Map	2-3
Figure 8.1 Location of Use.	8-4
Figure 8.2 Examples of Sealed Sources and/or Devices Possessed, Used, or Serviced	8-8
Figure 8.3 Methods of Certification of Financial Assurance for Decommissioning	8-11
Figure 8.4 Types of Records That Must Be Maintained for Decommissioning.	8-13
Figure 8.5 RSO Responsibilities. Typical duties and responsibilities of RSOs	8-16
Figure 8.6 Examples of Portable Instruments	8-28
Figure 8.7 Material Receipt and Accountability.	8-32
Figure 8.8 Annual Dose Limits for Occupationally Exposed Individuals	8-36
Figure 8.9 Calculating Public Dose.	8-41
Figure 8.10 Types of Surveys	8-46
Figure 8.11 Personnel Surveys	8-47
Figure 8.12 Routine Maintenance and Lubrication.	8-55
Figure M.1 Bird's Eye View of Office With Stored Calibration Source	M-4
Figure M.2 Down Hole Storage Array in Waste Broker Facility	M-6
Figure Q.1. Sample Shipping Documents, Placards and Labels	Q-4

TABLES

Table 2.1 Who Regulates the Activity?	2-2
Table 8.1 Types of Radioactive Materials	8-5
Table 8.2 Package Monitoring Requirements	8-31
Table 8.3 Record Maintenance	8-33
Table 8.4 Typical NRC Incident Notifications Required for Service Provider Licensees	8-44
Table 8.5 Suggested Contamination Survey Frequency	8-48
Table 8.6 Acceptable Surface Contamination Levels for Equipment	8-49
Table 11.1 Acceptable License Termination Screening Values of Common Radionuclides for Building Surface Contamination	11-2
Table A.1 List of NUREG Reports, Regulatory Guides, and Policy and Guidance Directives	A-1
Table J.1 Typical Survey Instruments	J-1
Table M.1 Standard Occupancy Factors	M-3
Table M.2 Information Known about Dose at the Shield of the Cs-137 Source	M-6
Table M.3 Calculation Method, Part 1: Hourly and Annual Doses Received from a Source Stored in Above Ground.	M-7
Table M.4 Calculation Method, Part 2: Annual Dose Received from a Source Stored Above Ground.	M-8
Table Q.1. Schedule Summary of the Principal Requirements for Transport of Specified Types of Radioactive Material Consignments (Principal requirements only - consult regulations for detailed provisions)	Q-3

FOREWORD

The United States Nuclear Regulatory Commission (NRC) is using business process redesign techniques to redesign its materials licensing process. This effort is described in NUREG - 1539, "Methodology and Findings of the NRC's Materials Licensing Process Redesign," dated April 1996. A critical element of the new process is consolidating and updating numerous guidance documents into a NUREG - series of reports. Below is a listing of volumes currently included in the NUREG - 1556 series: "Consolidated Guidance About Materials Licenses":

Vol. No.	Volume Title	Status
1	Program-Specific Guidance About Portable Gauge Licenses	Final Report
2	Program-Specific Guidance About Industrial Radiography Licenses	Final Report
3	Applications for Sealed Source and Device Evaluation and Registration	Final Report
4	Program-Specific Guidance About Fixed Gauge Licenses	Final Report
5	Program-Specific Guidance About Self-Shielded Irradiator Licenses	Final Report
6	Program-Specific Guidance About 10 CFR Part 36 Irradiator Licenses	Final Report
7	Program-Specific Guidance About Academic, Research and Development, and Other Licenses of Limited Scope	Final Report
8	Program-Specific Guidance About Exempt Distribution Licenses	Final Report
9	Program-Specific Guidance About Medical Use Licenses	Draft for Comment
10	Program-Specific Guidance About Master Materials Licenses	Draft for Comment
11	Program-Specific Guidance About Licenses of Broad Scope	Final Report
13	Program-Specific Guidance About Commercial Radiopharmacy Licenses	Final Report
14	Program-Specific Guidance About Well Logging, Tracer, and Field Flood Study Licenses	Final Report
15	Guidance About Changes of Control and About Bankruptcy Involving Byproduct, Source, or Special Nuclear Materials Licenses	Draft for Comment
16	Program-Specific Guidance About Licenses Authorizing Distribution to General Licensees	Draft for Comment

FOREWORD

Vol. No.	Volume Title	Status
17	Program-Specific Guidance About Licenses for Special Nuclear Material of Less Than Critical Mass	Draft for Comment
18	Program-Specific Guidance About Service Provider Licenses	Draft for Comment
19	Guidance for Agreement State Licensees About NRC Form 241 "Report of Proposed Activities in Non-Agreement States, Areas of Exclusive Federal Jurisdiction, or Offshore Waters" and Guidance For NRC Licensees Proposing to Work in Agreement State Jurisdiction (Reciprocity)	Draft for Comment
20	Guidance About Administrative Licensing Procedures	Draft for Comment

The current document, draft NUREG-1556, Vol. 18, "Consolidated Guidance about Materials Licenses: Program-Specific Guidance about Service Provider Licenses," dated May 2000, is the eighteenth program-specific guidance developed for the new process. It is intended for use by applicants, licensees, NRC license reviewers, and other NRC personnel.

A team composed of NRC staff from headquarters and regional offices drafted this document, drawing on their collective experience in radiation safety in general and as specifically applied to service provider licenses. A representative of NRC's Office of the General Counsel provided a legal perspective.

Since this report takes a risk-informed, performance-based approach to licensing, it specifies the amount of information needed from an applicant seeking to use sealed and unsealed byproduct material. NRC's considerable experience with these licensees indicates that radiation exposures to workers are generally low, if the workers follow basic safety procedures.

NRC report represents a step in the transition from the current paper-based process to the new electronic process. This document is available on the Internet at the following address:
<<http://www.nrc.gov/NRC/NUREGS/SR1556/V18/index.html>>.

This draft report is strictly for public comment and is not intended for use in preparing or reviewing applications for service provider licenses until it is published in final form. It is being distributed for comment to encourage public participation in its development. NRC is requesting comments such as whether a risk-informed, performance-based approach to licensing is valid, as well as comments on the information provided. Please submit comments within 60 days of the draft report's publication. Comments received after that date will be considered, if practicable.

Address comments to: Chief, Rules and Directives Branch, Division of Administrative Services, Office of Administration, U.S. Nuclear Regulatory Commission, Washington, DC 20555-0001. Hand deliver comments to 11545 Rockville Pike, Rockville, Maryland, between 7:15 a.m. and

4:30 p.m. on Federal workdays. Comments may also be submitted through the Internet by addressing electronic mail to d1m1@nrc.gov.

Draft NUREG-1556, Vol. 18, "Consolidated Guidance about Materials Licenses: Program-Specific Guidance about Service Provider Licenses," dated May 2000, is not a substitute for NRC regulations, and compliance is not required. The approaches and methods described in this draft report are provided for information and comment only.



Donald A. Cool, Director
Division of Industrial and Medical Nuclear Safety
Office of Nuclear Material Safety and Safeguards

ACKNOWLEDGMENTS

The writing team thanks the individuals listed below for assisting in the development and review of the draft report. All participants provided valuable insights, observations, and recommendations.

The team thanks Dianne Geshen, Rolonda Jackson, Tamra King, D.W. Benedict Llewellyn, and Agi Seaton, of Computer Sciences Corporation.

The Participants

Bermúdez, Héctor
Brown, Carrie
Camper, Larry W.
Caniano, Roy
Collins, Doug
Collins, Elmo E.
Combs, Fred
Haney, Catherine
Joustra, Judy
Kirkwood, Anthony
Merchant, Sally L.
Phillips, Monte P.
Piccone, Josephine
Reber, Eric H.
Roe, Mary Louise
Spitzberg, Blair
Schwartz, Maria E.
Treby, Stu
Whitten, Jack

ABBREVIATIONS

ALARA	As low as is reasonably achievable
ALI	Annual Limit of Intake
ANSI	American National Standards Institute
AU	authorized user
bkg	background
Bq	Becquerel
CFR	Code of Federal Regulations
cpm	counts per minute
DOT	United States Department of Transportation
G-M	Geiger-Mueller
GPO	Government Printing Office
IN	Information Notice
MC	Manual Chapter
MOU	Memorandum of Understanding
mR	milliroentgen
mrem	millirem
mSv	millisievert
NCRP	National Council on Radiation Protection and Measurements
NIST	National Institute of Standards and Technology
NMSS	Office of Nuclear Material Safety and Safeguards
NRC	Nuclear Regulatory Commission
NVLAP	National Voluntary Laboratory Accreditation Program
OCR	optical character reader
OMB	Office of Management and Budget
OSL	Optically Stimulated Luminescence
QA	quality assurance
R	Roentgen
RG	Regulatory Guide
RQ	reportable quantities
RSO	radiation safety officer
SDE	shallow dose equivalent
SI	International System of Units (abbreviated SI from the French Le Systeme Internationale d'Unites)
SSD	sealed source and device
std	standard
Sv	Sievert
TAR	technical assistance request
TEDE	total effective dose equivalent
TI	transportation index
TLD	thermoluminescent dosimeters

1 PURPOSE OF DRAFT REPORT

This document is strictly for public comment and is not for use in preparing or reviewing applications for service providers until this document is published in final form.

This draft report provides guidance to an applicant in preparing a service provider license application, as well as providing NRC with the appropriate criteria for evaluating such applications.

Service providers provide commercial services to both specific and general licensees, and in some instances, recover both licensed and unlicensed material from the public domain. Customers who possess such radioactive material may require commercial services to manage materials at concentrations and activities they are not authorized to handle. In these unique situations, a service provider licensee is authorized to possess these radioactive materials under its license incident to performing specific services required by its customers. Optionally, licensees may elect to transfer licensed material such as radioactive waste and contaminated materials to service providers (e.g., radioactive waste brokers, decontamination and decommissioning service providers or nuclear laundry operators).

Licensees who in the course of doing business, receive physical samples and possess equipment containing licensed materials related to the performance of service activities such as leak test and environmental sample analyses, survey instrument and dosimetry calibration services are also included in the service provider category.

Service providers addressed in this draft NUREG are limited to licensed entities providing the following types of commercial services:

- Installation, relocation, removal from service, disposal, radiation surveys, routine and preventive maintenance, adjustment of equipment, training of personnel or repair of devices containing licensed materials.
- Installation, relocation, removal from service, disposal, radiation surveys, routine or preventive maintenance, adjustment, training or repair of Part 36 irradiators.
- Installation, radiation surveys, routine and preventive maintenance, adjustment or repair of remote afterloaders, teletherapy, or gamma stereotactic radiosurgery units that require access to the sealed source(s), driving units, or other electronic components that could expose the sealed source, reduce the shielding, or compromise the radiation safety of the device or safety systems.
- Calibration of survey instruments and personnel dosimetry equipment.
- Leak testing of sealed sources, including analyzing the leak test kits or smears.
- Environmental sample analysis.
- Training of personnel using sealed sources.

PURPOSE OF DRAFT REPORT

- Calibration of medical dose calibrators.
- Nuclear laundry services.
- Waste management services including:
 - Commercial incineration
 - Compaction, Super Compaction
 - Solidification or vitrification
 - Packaging and repackaging of radioactive waste for transportation
- Decontamination and decommissioning services
- Site characterization services

This draft report identifies the information needed to complete NRC Form 313 (Appendix B), "Application for Material License." The information collection requirements in 10 CFR Part 20 and Part 30 and NRC Form 313 have been approved under the Office of Management and Budget (OMB) Clearance Nos. 3150-0014, 3150-0017, and 3150-0120, respectively.

The format within this document for each item of technical information is as follows:

- Regulations - references the regulations applicable to the item;
- Criteria - outlines the criteria used to judge the adequacy of the applicant's response;
- Discussion - provides additional information on the topic sufficient to meet the needs of most readers; and
- Response from Applicant - provides suggested response(s), offers the option of an alternative reply, or indicates that no response is needed on that topic during the licensing process.

Notes and References are self-explanatory .

NRC Form 313 does not provide sufficient space for applicants to include full responses to Items 5 through 11; as indicated on the form, the answers to those items are to be provided on separate sheets of paper and submitted with the completed NRC Form 313. For the convenience of applicants and for streamlined handling of applications for service provider licenses, use Appendix C to provide supporting information, attach it to NRC Form 313, and submit it to NRC.

Appendix D is a checklist that NRC staff uses to review applications and applicants can use to check for completeness. Appendix E contains samples of the different types of licenses for service providers, each license contains the conditions most often found on these type of license, although not all licenses issued to service providers will have all conditions.

PURPOSE OF DRAFT REPORT

In this document, dose or radiation dose means absorbed dose, dose equivalent, effective dose equivalent, committed dose equivalent, committed effective dose equivalent, or total effective dose equivalent. These terms are defined in 10 CFR Part 20. Rem, and its SI equivalent Sievert (1 rem = 0.01 Sievert (Sv)), is used to describe units of radiation exposure or dose. This is because 10 CFR Part 20 sets dose limits in terms of rem, not rad or roentgen, and the sealed sources that emit beta and gamma rays, which means that 1 roentgen = 1 rad = 1 rem.

2 AGREEMENT STATES

Certain states, called Agreement States (see Figure 2.1), have entered into agreements {Section 274b, Atomic Energy Act, 1954, as amended} with the NRC that give them the authority to license and inspect byproduct, source, or special nuclear materials used or possessed within their borders. Any applicant other than a Federal agency who wishes to possess or use licensed material in one of these Agreement States needs to contact the responsible officials in that State for guidance on preparing an application. File these applications with State officials, not with the NRC. Refer to the reference paragraph below for information for submitting an application to a particular state.

NRC's materials licensees who wish to conduct operations under reciprocity at temporary job sites in an Agreement State should contact that State's radiation control program office for information about State regulations. To ensure compliance with Agreement State reciprocity requirements, licensees should request authorization well in advance of scheduled use.

Under the provisions of 10 CFR 150.20, NRC can recognize and grant a general license to Agreement State licensees. This general license authorization allows Agreement State licensees to conduct licensed operations identified on the Agreement State license in Non-Agreement States; areas of exclusive Federal jurisdiction within Agreement States; and offshore waters provided:

- The Agreement State license does not limit authorized activity to a specific installation or location.
- The Agreement State license contains no provisions to the contrary.

Activities, other than those in offshore waters, including storage of materials, are limited to a total of 180 days in any calendar year. Offshore activities, as specified in 10 CFR 150.20(b)(4), are authorized for an unlimited period of time.

NRC must be notified in accordance with the provision of 10 CFR 150.20(b)(1).

Licensees who are requesting generally licensed activities in offshore waters of Louisiana, and are licensed by the State of Louisiana, can notify the State of Louisiana in lieu of notifying NRC. Notification to the State of Louisiana must be completed in accordance with the provisions of 10 CFR 150.20(c).

In the special situation of work at Federally-controlled sites in Agreement States, it is necessary to know the jurisdictional status of the land in order to determine whether NRC or the Agreement State has regulatory authority. NRC has regulatory authority over land determined to be "exclusive Federal jurisdiction," while the Agreement State has jurisdiction over non-exclusive Federal jurisdiction land. Licensees are responsible for finding out, in advance, the jurisdictional status of the specific areas where they plan to conduct licensed operations. NRC recommends that licensees ask their local contact for the Federal agency controlling the site (e.g., contract

AGREEMENT STATES

officer, base environmental health officer, district office staff) to help determine the jurisdictional status of the land and to provide the information in writing, so that licensees can comply with NRC or Agreement State regulatory requirements, as appropriate. Additional guidance on determining jurisdictional status is found in All Agreement States Letter, SP-96-022, dated February 16, 1996, which is available as indicated below.

Table 2.1 provides a quick way to check on which agency has regulatory authority.

Table 2.1 Who Regulates the Activity?

Applicant and Proposed Location of Work	Regulatory Agency
Federal agency regardless of location (except that Department of Energy and, under most circumstances, its prime contractors are exempt from licensing [10 CFR 30.12])	NRC
Non-Federal entity in non-Agreement State, US territory, or possession	NRC
Non-Federal entity in Agreement State at non-Federally controlled site	Agreement State
Non-Federal entity in Agreement State at Federally-controlled site <i>not</i> subject to exclusive Federal jurisdiction	Agreement State
Non-Federal entity in Agreement State at Federally-controlled site subject to exclusive Federal jurisdiction	NRC

Reference: A current list of Agreement States (including names, addresses, and telephone numbers of responsible officials) may be obtained upon request from NRC’s Regional Offices. You can also visit the NRC Office of State Programs’ (OSP’s) Home Page <<http://www.hsrdo.ornl.gov/nrc>> and choose “Directories,” then “State Program Directors.”

All Agreement States Letter, SP-96-022, on determining jurisdictional status at a Federal facility, dated February 16, 1996, is available on OSP’s home page <<http://www.hsrdo.ornl.gov/nrc/home.html>>; choose “NRC-State Letters,” then scroll down to “Other Information - 1996” for SP-96-022. You can also request the letter from OSP by calling NRC’s toll free number (800) 368-5642, extension 415-3340.

Locations of NRC Offices and Agreement States

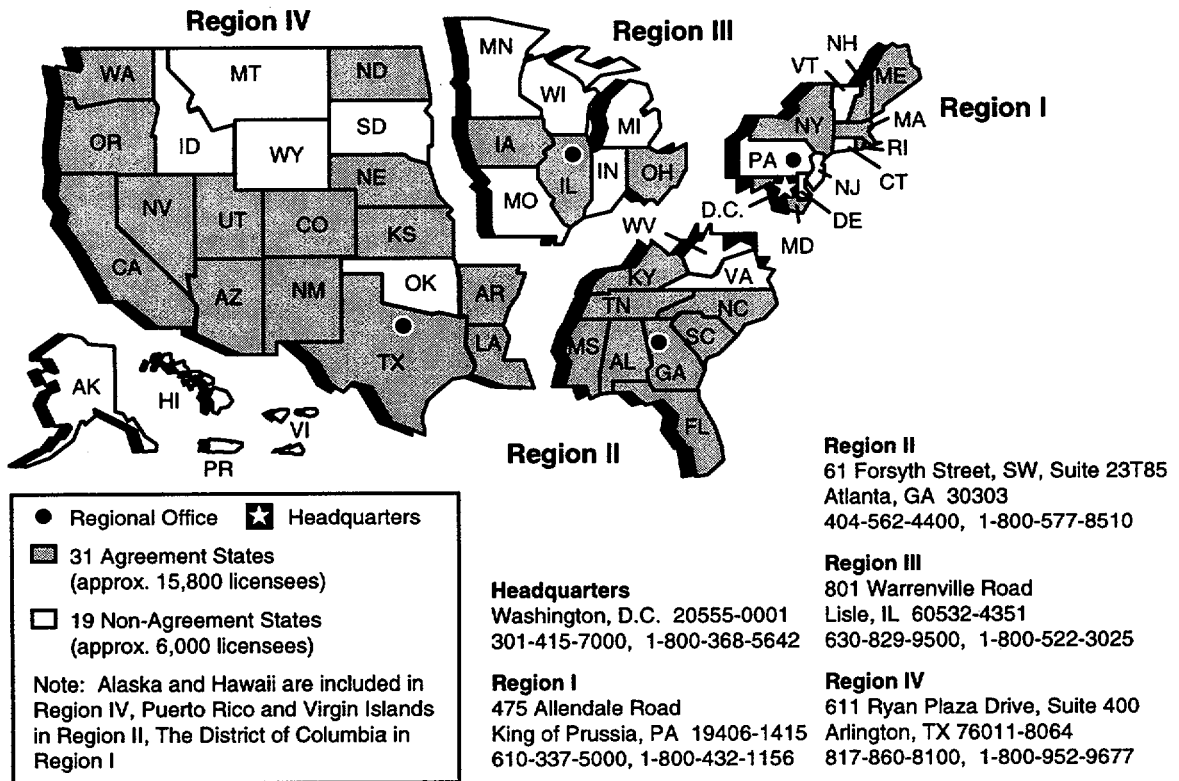

817e.ppt
110399

Figure 2.1 U.S. Map. Location of NRC Offices and Agreement States.

3 MANAGEMENT RESPONSIBILITY

NRC recognizes that effective radiation safety program management is vital to achieving safe and compliant operations. NRC believes that consistent compliance with its regulations provides reasonable assurance that licensed activities will be conducted safely. NRC also believes that effective management will result in increased safety and compliance.

“Management” refers to the processes for conducting and controlling the radiation safety program and to the individuals who are responsible for those processes and who have *authority to provide necessary resources* to achieve regulatory compliance.

To ensure adequate management involvement, ***a management representative must sign the submitted application acknowledging management’s commitments and responsibility*** for the following:

- Radiation safety, security and control of radioactive materials, and compliance with regulations.
- Completeness and accuracy of the radiation safety records and all information provided to NRC (10 CFR 30.9).
- Knowledge about the contents of the license and application.
- Compliance with current NRC and Department of Transportation (DOT) regulations and the licensee’s operating and emergency procedures.
- Commitment to provide adequate resources (including space, equipment, personnel, time, and, if needed, contractors) to the radiation protection program to ensure that the public and workers are protected from radiation hazards and meticulous compliance with regulations is maintained.
- Selection and assignment of a qualified individual to serve as the Radiation Safety Officer (RSO) with responsibility for the overall radiation safety program.
- Prohibition against discrimination of employees engaged in protected activities (10 CFR 30.7).
- Commitment to provide information to employees regarding the employee protection and deliberate misconduct provisions in 10 CFR 30.7 and 10 CFR 30.10, respectively.
- Obtaining NRC’s prior written consent before transferring control of the license.
- Notifying appropriate NRC regional administrator in writing, immediately following filing of petition for voluntary or involuntary bankruptcy.

For information on NRC inspection, investigation, enforcement, and other compliance programs, see “General Statement of Policy and Procedures for NRC Enforcement Actions,” NUREG - 1600, and Inspection Procedure 87110, Appendix A, “Industrial/Academic/Research Inspection Field Notes”; see Notice of Availability (on inside front cover of this report). In

MANAGEMENT RESPONSIBILITY

addition, NUREG - 1600 and Inspection Procedure 87110, Appendix A may be found at <http://www.nrc.gov>.

4 APPLICABLE REGULATIONS

It is the applicant's or licensee's responsibility to obtain up-to-date copies of applicable regulations, read and understand the requirements of each of these regulations, and comply with each applicable regulation.

The following Parts of 10 CFR Chapter I contain regulations applicable to service provider licensees:

- 10 CFR Part 2, "Rules of Practice for Domestic Licensing Proceedings and Issuance of Orders"
- 10 CFR Part 19, "Notices, Instructions and Reports to Workers: Inspection and Investigations"
- 10 CFR Part 20, "Standards for Protection Against Radiation"
- 10 CFR Part 21, "Reporting of Defects and Noncompliance"
- 10 CFR Part 30, "Rules of General Applicability to Domestic Licensing of Byproduct Material"
- 10 CFR Part 31, "General Domestic Licenses for Byproduct Material"
- 10 CFR Part 32, "Specific Domestic Licenses to Manufacture or Transfer Certain Items Containing Byproduct Material"
- 10 CFR Part 33, "Specific Domestic Licenses of Broad Scope for Byproduct Material"
- 10 CFR Part 40, "Domestic Licensing of Source Material"
- 10 CFR Part 51, "Environmental Protection Regulations for Domestic Licensing and Related Regulatory Functions"
- 10 CFR Part 70, "Domestic Licensing of Special Nuclear Material"
- 10 CFR Part 71, "Packaging and Transportation of Radioactive Material"

Part 71 requires that licensees or applicants who transport licensed material outside the site of usage, as specified in the NRC license, or where transport is on public highways, or who delivers licensed material to a carrier for transport shall comply with the applicable requirements of the DOT that are found in 49 CFR Parts 170 through 189 appropriate to the mode of transport. Copies of DOT regulations can be ordered from the Government Printing Office (GPO) whose address and telephone number are listed below.

- 10 CFR Part 150, "Exemptions and Continued Regulatory Authority in Agreement States and in Offshore Waters Under Section 274"
- 10 CFR Part 170, "Fees for Facilities, Materials, Import and Export Licenses and Other Regulatory Services Under the Atomic Energy Act of 1954, as Amended"

APPLICABLE REGULATIONS

- 10 CFR Part 171, “Annual Fees for Reactor Operating Licenses, and Fuel Cycle Licenses and Materials Licenses, Including Holders of Certificates of Compliance, Registrations, and Quality Assurance Program Approvals and Government Agencies Licensed by NRC” and “Materials Licenses, Including Holders of Certificates of Compliance, Registrations, and Quality Assurance Program Approvals and Government Agencies Licensed by NRC”

To request copies of the above documents, call GPO’s order desk in Washington, DC at (202) 512-1800. Order the two-volume bound version of *Title 10, Code of Federal Regulations, Parts 0-50 and 51-199* from the GPO, Superintendent of Documents, Post Office Box 371954, Pittsburgh, Pennsylvania 15250-7954. You may also contact the GPO electronically at <<http://www.gpo.gov>>. Additionally, Title 10, Code of Federal Regulations, Parts 0-50 and 51-199, is available electronically from NRC’s reference library at <<http://www.nrc.gov>>. Individuals may request single hard copies of the above documents from NRC’s Regional Offices (see Figure 2.1 for addresses and telephone numbers).

Note that NRC publishes amendments to its regulations in the *Federal Register*.

5 HOW TO FILE

5.1 PAPER APPLICATION

Applicants for a materials license should do the following:

- Be sure to use the most recent information in preparing an application.
- Complete NRC Form 313 (Appendix B) Items 1 through 4, 12, and 13 on the form itself.
- Complete NRC Form 313 Items 5 through 11 on supplementary pages or use Appendix C.
- For each separate sheet, other than Appendix C, that is submitted with the application, identify and key it to the item number on the application or the topic to which it refers.
- Submit all documents, including drawings, if practicable, on 8-1/2 x 11 inch paper. If submission of larger documents is necessary, fold them to 8-1/2 x 11 inches.
- Identify each drawing with drawing number, revision number, title, date, scale, and applicant's name. Clearly indicate if drawings have been reduced or enlarged.
- Avoid submitting proprietary information unless it is absolutely necessary.
- Do not submit personal information about employees.
- Do not submit copies of NRC licenses.
- Submit an original, signed application and one copy.
- Retain one copy of the license application for future reference.

As required by 10 CFR 30.32(c), applications shall be signed by a duly authorized management representative; see section on "Certification."

Using the suggested wording of responses and committing to using the model procedures in this draft NUREG-1556, Vol. 18 will expedite NRC's review.

All license applications will be available for review by the general public in NRC's Public Document or Electronic Reading Rooms. If it is necessary to submit proprietary information, follow the procedure in 10 CFR 2.790. Failure to follow this procedure could result in disclosure of the proprietary information to the public or substantial delays in processing the application. Employee personal information, i.e., home address, home telephone number, social security number, date of birth, and radiation dose information, should not be submitted unless specifically requested by NRC.

- Do not submit personal information about employees.
- Do not submit copies of NRC licenses.

HOW TO FILE

As explained in the "Foreword," NRC's new licensing process will be faster and more efficient, in part, through acceptance and processing of electronic applications at some future date. NRC will continue to accept paper applications; however, these will be scanned and put through an optical character reader (OCR) to convert them to electronic format. To ensure a smooth transition, applicants are requested to follow these suggestions:

- Submit printed or typewritten, not handwritten, text on smooth, crisp paper that will feed easily into the scanner.
- Choose typeface designs that are sans serif, such as **Arial, Helvetica, Futura, Universe**; the text of this document is in a serif font called **Times New Roman**.
- Choose 12-point or larger font size.
- Avoid stylized characters such as script, italic, etc.
- Be sure the print is clear and sharp.
- Be sure there is high contrast between the ink and paper (black ink on white paper is best).

5.2 ELECTRONIC APPLICATION

As the electronic licensing process develops, it is anticipated that NRC may provide mechanisms for filing applications via diskettes or CD-ROM, and through the Internet. Additional filing instructions will be provided as these new mechanisms become available.

6 WHERE TO FILE

Applicants wishing to possess or use licensed material in any State or U.S. territory or possession subject to NRC jurisdiction must file an application with the NRC Regional Office for the locale in which the material will be possessed and/or used. Figure 2.1 shows NRC's four Regional Offices and their respective areas for licensing purposes and identifies Agreement States.

In general, applicants wishing to possess or use licensed material in Agreement States must file an application with the Agreement State, not NRC. If work will be conducted at Federally controlled sites in Agreement States, however, applicants must first determine the jurisdictional status of the land in order to determine whether NRC or the Agreement State has regulatory authority. See the section on "Agreement States" for additional information.

7 LICENSE FEES

Each application for which a fee is specified, including applications for new licenses and license amendments, must be accompanied by the appropriate fee. Refer to 10 CFR 170.31 to determine the amount of the fee. NRC will not issue the new license prior to fee receipt. An application for a new license or an amendment to an existing license requesting authorization to conduct field flood studies requires that an environmental assessment be performed. Fees for a licensing action that requires an environmental assessment are charged at an hourly rate. Full cost fee recovery is assessed by the professional staff time expended, as described in footnote e.3. to 10 CFR 170.31. Once technical review begins, no fees will be refunded; application fees will be charged regardless of NRC's disposition of an application or the withdrawal of an application.

Most NRC licensees are also subject to annual fees; refer to 10 CFR 171.16. Consult 10 CFR 171.11 for additional information on exemptions from annual fees and 10 CFR 171.16(c) on reduced annual fees for licensees that qualify as "small entities."

Direct all questions about NRC's fees or completion of Item 12 of NRC Form 313 (Appendix B) to the Office of the Chief Financial Officer (OCFO) at NRC Headquarters in Rockville, Maryland, (301) 415-7554. You may also call NRC's toll-free number (800) 368-5642 and then ask for extension 415-7554. The e-mail address is fees@nrc.gov.

8 CONTENTS OF AN APPLICATION

The following comments apply to the indicated items on NRC Form 313 (Appendix B).

8.1 ITEM 1: LICENSE ACTION TYPE

THIS IS AN APPLICATION FOR (Check appropriate item)

Type of Action	License No.
<input type="checkbox"/> A. New License	Not Applicable
<input type="checkbox"/> B. Amendment to License No.	XX-XXXXXX-XX
<input type="checkbox"/> C. Renewal of License No.	XX-XXXXXX-XX

Check box A if the application is for a new license.

Check box B if the application is for an amendment¹ to an existing license, and provide the license number.

Check box C if the application is for the renewal¹ of an existing license, and provide the license number.

8.2 ITEM 2: APPLICANT'S NAME AND MAILING ADDRESS

List the legal name of the applicant's corporation or other legal entity with direct control over use of the radioactive material; a division or department within a legal entity may not be a licensee. An individual may be designated as the applicant only if the individual is acting in a private capacity and the use of the radioactive material is not connected with employment in a corporation or other legal entity. Provide the mailing address where correspondence should be sent. A Post Office box number is an acceptable mailing address.

Notify NRC of changes in mailing address; these changes do not require a fee.

Note: NRC must be notified before control of the license is transferred or when bankruptcy proceedings have been initiated. See below for more details. NRC Information Notice (IN) 97-30, "Control of Licensed Material during Reorganizations, Employee-Management Disagreements, and Financial Crises," dated June 3, 1997, discusses the potential for the security and control of licensed material to be compromised during periods of organizational instability.

¹ See "Amendments and Renewals to a License" later in this document. Licensees are required to request and obtain an amendment to the license before making changes in their radiation safety program. Examples of changes that require amendment are: change of Radiation Safety Officer (RSO), changes in approved radiation safety procedures, addition or removal of authorized user(s), changes in areas of use, and changes in licensed material, including increases in possession limit of byproduct material.

Timely Notification of Transfer of Control

Regulations: 10 CFR 30.34(b).

Criteria: Licensees must provide full information and obtain NRC's prior written consent before transferring control of the license, or, as some licensees call it, "transferring the license."

Discussion: Transfer of control may be the result of mergers, buyouts, or majority stock transfers. Although it is not NRC's intent to interfere with the business decisions of licensees, it is necessary for licensees to obtain NRC's written consent before the transaction is finalized. This is to ensure the following:

- Radioactive materials are possessed, used, or controlled only by persons who have valid NRC licenses
- Materials are properly handled and secured
- Persons using these materials are competent and committed to implementing appropriate radiological controls
- A clear chain of custody is established to identify who is responsible for disposition of records and licensed material
- Public health and safety are not compromised by the use of such materials.

Response from Applicant: None from an applicant for a new license; Appendix F, excerpted from IN 89-25 (Revision 1), "Unauthorized Transfer of Ownership or Control of Licensed Activities," dated December 7, 1994, identifies the information to be provided about transferring control.

Reference: See the Notice of Availability on the inside front cover of this report to obtain hard copies of INs. Electronic copies are available in the "Reference Library" on NRC's Home Page at <<http://www.nrc.gov>>.

- Information Notice 89-25 (Revision 1), "Unauthorized Transfer of Ownership or Control of Licensed Activities," dated December 7, 1994.
- Information Notice 97-30, "Control of Licensed Material during Reorganizations, Employee-Management Disagreements, and Financial Crises," dated June 3, 1997.

Notification of Bankruptcy Proceedings

Regulation: 10 CFR 30.34(h).

Criteria: Immediately following filing of voluntary or involuntary petition for bankruptcy for or against a licensee, the licensee must notify the appropriate NRC Regional Administrator, in writing, identifying the bankruptcy court in which the petition was filed and the date of filing.

Discussion: Even though a licensee may have filed for bankruptcy, the licensee remains responsible for all regulatory requirements. NRC needs to know when licensees are in bankruptcy proceedings in order to determine whether all licensed material is accounted for and adequately controlled, and whether there are any public health and safety concerns (e.g., contaminated facility). NRC shares the results of its determinations with other involved entities (e.g., trustee), so that health and safety issues can be resolved before bankruptcy actions are completed.

Response from Applicant: None at time of application for a new license. Generally, licensees should notify NRC within 24 hours of filing a bankruptcy petition.

Reference: See the Notice of Availability on the inside front cover of this report to obtain copies of:

- Inspection Procedure 87103, “Inspection of Material Licensees Involved in an Incident or Bankruptcy Filing.” Inspection Procedure 87103 is available on NRC’s web site at <<http://www.nrc.gov>>.
- Policy and Guidance Directive PG 8-11, “NMSS Procedures for Reviewing Declarations of Bankruptcy,” (dated August 8, 1996)

INs are available in the “Reference Library” on NRC’s Home Page at <<http://www.nrc.gov>>. For hard copies, also see the Notice of Availability (on the inside front cover of this report).

8.3 ITEM 3: ADDRESS(ES) WHERE LICENSED MATERIAL WILL BE USED OR POSSESSED

Specify the street address, city, and state or other descriptive address (e.g., on Highway 10, 5 miles east of the intersection of Highway 10 and State Route 234, Anytown, State) for each facility at which licensed material will be used, stored, or dispatched, and list the specific activities to be conducted at each location. As illustrated in Fig. 8.1, a post office box or drawer address is not acceptable.

CONTENTS OF AN APPLICATION

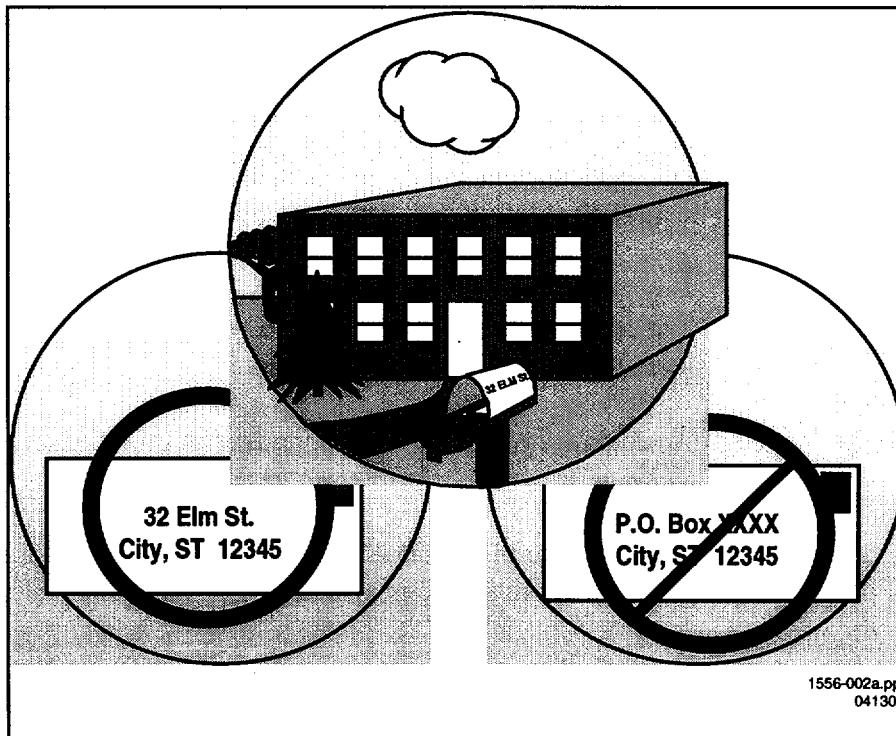

Figure 8.1 Location of Use. *An acceptable location of use specifies street address, city, state, and zip code and does not include a post office box number.*

An NRC-approved license amendment is required before receiving, using and storing licensed material at an address or location not included with the application or already listed on the license.

Granting of an NRC license does not relieve a licensee from complying with other applicable Federal, State, or local regulations (e.g., local zoning requirements; a local ordinance requiring registration of a radiation-producing device).

8.4 ITEM 4: PERSON TO BE CONTACTED ABOUT THIS APPLICATION

Identify the name of the individual who can answer specific administrative or technical questions about the application and include his or her telephone number. This is typically the proposed RSO, unless the applicant has named a different person as the contact. The NRC will contact this individual if there are questions about the application.

Notify NRC if the contact person or the contact person's telephone number changes so that NRC can contact the applicant or licensee in the future with questions, concerns, or information. This notice is for "information only" and does not require a license amendment unless the notification involves a change in the contact person who is also the RSO.

As indicated on NRC Form 313 (Appendix B), Items 5 through 11 should be submitted on separate sheets of paper. Applicants may use Appendix C for this purpose and should note that using the suggested wording of responses and committing to using the model procedures in this draft report will expedite NRC's review.

8.5 ITEM 5: RADIOACTIVE MATERIAL

Regulations: 10 CFR 30.14, 10 CFR 30.15, 10 CFR 30.18, 10 CFR 30.19, 10 CFR 30.21, 10 CFR 30.32(g), 10 CFR 30.32(i), 10 CFR 30.33; 10 CFR 31.5, 10 CFR 31.8, 10 CFR 31.11, 10 CFR 32.210.

Criteria: An application for a license will be approved if the requirements in 10 CFR 30.33 are met. In addition, licensees will be authorized to possess and use only those sealed sources and devices that are specifically approved or registered by NRC or an Agreement State.

Discussion: Each authorized radioisotope is listed on the NRC license by its element name, chemical and/or physical form, and the maximum possession limit, as shown in the sample licenses in Appendix E. Table 8.1 below lists the type of radioactive material covered by this report.

Note: Additional safety equipment and precautions are required when handling and using unsealed free-form volatile radioactive materials. Volatile means that a liquid, and in rare cases a solid, becomes a gas at a relatively low temperature when exposed to the environment.

Table 8.1 Types of Radioactive Materials

Type of Material	Covered by this Report	Examples
Byproduct (reactor-produced)	Yes	H-3, C-14, I-131, I-125, S-35, P-32, P-33, Ca-45, Ni-63, Cd-109, Cs-137
Source material	Yes	U, Th
Special nuclear material	Yes	Pu-238, Pu-239, U-233, U-235
Naturally occurring radioisotopes	No	Rn-222, Ra-226
Accelerator-produced radioisotopes	No	Co-57, Na-22, Tl-201, Ga-67

The applicant should list each requested radioisotope by its element name and its mass number [e.g., cobalt-60 (Co-60)] in Item 5. It is necessary to specify whether the material will be acquired and used in unsealed or sealed form. The name of the specific chemical compound that contains the radioisotope is not required.

CONTENTS OF AN APPLICATION

Service providers requesting authorization to possess and use volatile radioactive material must provide appropriate facilities, engineering controls, and radiation safety procedures necessary to handle such materials.

The anticipated possession limit in MBq (millicuries) or GBq (curies) for each radioisotope should also be specified. Possession limits must cover the total anticipated inventory, including licensed material in storage and waste, and should be commensurate with the applicant's needs and facilities for safe handling. Applicants should review the requirements for submitting a certification for financial assurance for decommissioning before specifying possession limits of any radioisotope with a half life greater than 120 days. These requirements are discussed in Section 8.5.3 "Financial Assurance and Record Keeping for Decommissioning."

When requesting authorization for possession limits in excess of the quantities listed in Schedule C of 10 CFR 30.72, you must provide in conjunction with the license application either (1) an evaluation showing that the maximum off-site dose due to a release of radioactive materials would not exceed 0.01 Sv (1 rem) effective dose equivalent or 0.05 Sv (5 rem) to the thyroid, or (2) an emergency response plan for responding to the release in accordance with the criteria listed in 10 CFR 30.32(i)(3). For additional information regarding emergency plans, refer to Regulatory Guide 3.67 and Policy and Guidance Directive 84-14.

Requests to license naturally-occurring radioactive material (NORM) and accelerator-produced radioactive material should be made to the appropriate State regulatory agency. NRC does not regulate NORM or accelerator-produced radioactive material.

Response from Applicant: No response required, unless an emergency plan is required. For NRC to grant authorization to possess quantities equal to the activities specified in Schedule C of 10 CFR 30.72, it is necessary to provide the information outlined in 10 CFR 30.32(i) sufficient to evaluate the need for an emergency plan.

References:

Regulatory Guide 3.67, "Standard Format and Content for Emergency Plans for Fuel Cycle and Materials Facilities." The document is available on NRC's web site at <<http://www.nrc.gov>>. To obtain copies, see the Notice of Availability on the inside front cover of this report.

Policy and Guidance Directive 84-14, Revision 1, "Standard Review Plan for Emergency Plans for Fuel Cycle and Materials Licensees." To obtain copies, see the Notice of Availability on the inside front cover of this report.

8.5.1 UNSEALED AND/OR SEALED BYPRODUCT MATERIAL

Regulations: 10 CFR 30.32(g), 10 CFR 30.33(a)(2), 10 CFR 32.210.

Criteria: Applicants for a service provider license must provide the manufacturer's or distributor's name and model number for each requested sealed source and device that it will possess, use, and service. Service provider licensees in most circumstances will possess, use, or service only those sealed sources and devices specifically approved or registered by NRC or an Agreement State. However, some sealed sources and/or devices not registered by the NRC or an Agreement State may be possessed or used by service providers or individual clients needing services. Possession and use of these unique types of sealed sources result from, either of the following:

- Custom sealed sources and/or devices built to unique specifications of a given custom user.

OR

- Calibration and reference sources that:
 - Contain beta and/or gamma emitting material in amounts not exceeding either 3.7 MB (100 microcuries) or ten times the quantity specified in 10 CFR 30.71, Schedule B, whichever is greater.
 - Contain alpha emitting material in amounts not exceeding 0.37 MB (10 micro curies).

OR

- Sealed sources or devices containing intended only for use under research and development or broad scope licenses.

When requesting authorization to possess or provide services involving these unique sealed sources see Section 8.5.2, "Unsealed Radioactive Material."

Discussion: The NRC or an Agreement State performs a safety evaluation of sealed sources and/or devices before authorizing distribution to general or specific licensees. This safety evaluation is documented in a certificate in NRC's Sealed Source and Device (SSD) Registry. Before the SSD registration process was formalized by NRC, some older sealed sources and/or devices may have been evaluated, but not formalized in a separate document. However, these sealed sources and/or devices were specifically approved on a license. Service licensees, in possession of these devices, can continue to use these devices provided they are specifically listed on their licenses, or optionally, if they are authorized to possess equivalent amounts of unsealed material. Examples of the types of devices that are possessed, used, or serviced by service provider licensees are shown in Figure 8.2.

CONTENTS OF AN APPLICATION

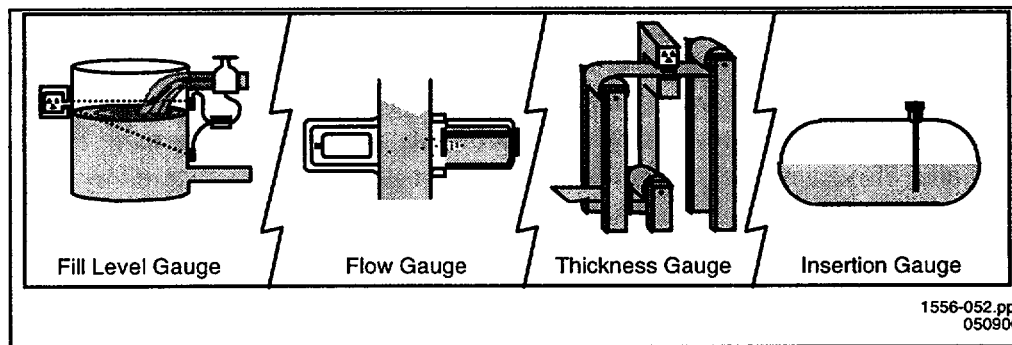

Figure 8.2 Examples of Sealed Sources and/or Devices Possessed, Used, or Serviced

Service providers, when possessing, using, or servicing sealed sources and/or devices, should consult with the manufacturer or distributor to ensure that requested sources and devices are compatible and conform to the sealed source and device designations registered with NRC or an Agreement State. Licensees, unless approved by NRC or an Agreement State, may not make any changes to the sealed source, device, or source/device combination that would alter the description or specifications from those indicated in the respective registration certificates, without obtaining NRC's prior permission in a license amendment.

Sealed Source and Device registration certificates may be obtained by contacting the SSD Registration Assistant by calling NRC's toll-free number (800) 368-5642, extension 415-8140, or visiting NRC home page on the Internet. To ensure that service providers possess and use sealed sources and/or devices according to the registration certificates, they may want to get a copy of the SSD certificate and review it or discuss use and service with the manufacturer.

"Conditions of Normal Use" and "Limitation and Other Considerations of Use" are described in most SSD Registration Certificates. These certificates generally include limitations derived from conditions imposed by the manufacturer or distributor, including particular conditions of use that would reduce radiation safety of the device, or circumstances unique to the sealed source and/or device. Information may include environmental conditions such as working life of the device, temperature, vibrations, corrosive atmospheres, etc. Except as specifically approved by NRC or Agreement States, licensees are required to use devices according to their respective SSD Registration Certificates. For additional information about the SSD registration process, see the current version of NUREG-1556, Vol. 3, "Consolidated Guidance About Materials Licenses: Applications for Sealed Source and Device Evaluation and Registration." See Appendix G for a copy of the standard NRC SSD registration certificate format.

Service providers who remove for disposal/transfer, or dispose of fixed gauges at customer facilities may wish to perform this service for device models and sealed sources not specifically identified on their license. Specific authorization to provide these limited services for devices that are similar in design and activity to those listed on their license from other manufacturers will be included in your license.

Response from Applicant:

- Identify each radionuclide that will be possessed in each sealed source and/or device.
- Identify the manufacturer or distributor and model number of each type of sealed source and/or device requested.
- Confirm that each sealed source, device, and source/device combination is registered as an approved sealed source or device by NRC or an Agreement State.
- Confirm that the activity per source and maximum activity per device will not exceed the maximum activity listed on the approved certificate of registration issued by NRC or by an Agreement State.
- Identify the special circumstances under which sealed sources and/or devices that are not registered by the NRC or an Agreement State may be possessed, used, or serviced.

Note: For more information about the SSD registration process, see the current version of NUREG-1556, Vol. 3, "Consolidated Guidance About Materials Licenses: Applications for Sealed Source and Device Evaluation and Registration." It is available electronically in the "Reference Library" at <<http://www.nrc.gov>>; for a paper copy, see the Notice of Availability on the inside front cover of this report.

8.5.2 UNSEALED RADIOACTIVE MATERIAL

Regulations: 10 CFR 30.14, 10 CFR 30.15, 10 CFR 30.18, 10 CFR 30.19, 10 CFR 30.21, 10 CFR 30.32(i), 10 CFR 30.33, 10 CFR 31.11.

Criteria: An application for a license will be approved if the requirements of 10 CFR 30.32, 10 CFR 30.33, 10 CFR 33.11, 10 CFR 33.13, 10 CFR 33.14, 10 CFR 33.15, and 10 CFR 33.17 are met.

Discussion: Applicants who request unsealed licensed material typically:

- Request authorization to possess and use any form of byproduct material with atomic numbers from 1 through 83.
- State the maximum quantity of each radionuclide to be possessed at any one time and the total cumulative quantity for all radionuclides. When establishing individual radionuclide and total cumulative quantities, all materials possessed under the license should be included (i.e., materials received awaiting use, materials in use/process, and that categorized as waste awaiting disposal). The maximum quantity for each individual radionuclide and total cumulative possession should be commensurate with the applicant's needs, facilities, procedures, and demonstrated experience/capability. If certain individual radionuclides will be needed in much larger quantities than that described in the atomic number 1-83 request, they should be listed separately rather than increasing the possession limit for all radionuclides, e.g., 1000 curies of strontium-90; or

CONTENTS OF AN APPLICATION

- Request broad scope authorization for types and quantities of licensed materials as specified in 10 CFR Part 33. Applicants for a broad scope license should request any chemical or physical form of byproduct material specified in 10 CFR Part 33. If needed, an applicant for a broad scope license may request authorization to possess byproduct materials with atomic numbers greater than 83 (e.g., atomic numbers 84 to 96). See NUREG-1556, Vol. 11, Program-Specific Guidance About Broad Scope Licenses.

For this request, the applicant should state the maximum quantity of each radionuclide to be possessed at any one time and the total cumulative quantity for all radionuclides.

Note: Authorization to possess byproduct materials with atomic numbers 84 through 96 does not include authorization to possess uranium, thorium, or plutonium. Even though these elements have atomic numbers within the range of 84 through 96, they are designated source or special nuclear material, not byproduct material, and should be requested individually. Quantities of SNM addressed in this guide are limited to small activities that cannot under any circumstances achieve critical mass configuration.

Response from Applicant:

Possession requests by service provider applicants should be categorized into general areas of use, e.g., survey instrument and personnel dosimeter calibrations, leak test sample analysis, equipment maintenance, environmental sample analysis, decommissioning, waste management, nuclear laundry services, commercial incineration, etc.

- Request any form of byproduct material with atomic numbers from 1 through 83 and 84 through 104. The applicant should state the maximum quantity of each radionuclide to be possessed at any one time and the total cumulative quantity for all radionuclides. If a broad scope license authorization is requested, refer to the types and quantities of licensed materials specified in 10 CFR Part 33.
- For source material, specify the number of kilograms of natural uranium, depleted uranium and thorium requested.
- For special nuclear material (SNM), specify the number of grams of material requested for each isotope.

8.5.3 FINANCIAL ASSURANCE AND RECORD KEEPING FOR DECOMMISSIONING

Regulations: 10 CFR 30.34(b), 10 CFR 30.35, 10 CFR 40.36, 10 CFR 70.25.

Criteria: Financial assurance is not required for many service providers; however, each licensee is obligated to maintain, in an identified location, decommissioning records related to facilities where licensed material is used, stored, or dispatched. Pursuant to NRC regulations when

terminating the license, licensees must transfer records important to decommissioning to either of the following:

The new licensee before licensed activities are transferred or assigned.

The appropriate NRC regional office before the license is terminated.

Decommissioning records described above are not required for temporary job site locations.

Discussion: NRC regulations, when applicable, require the applicant, when not operating at temporary job sites, to provide Certification of Financial Assurance (F/A) or a Decommissioning Funding Plan (DFP). This is to provide reasonable assurance that after the technical and environmental components of decommissioning are carried out, that unrestricted use of the facilities specifically identified in the license is possible at the termination of licensed activities. NRC's primary objective is to ensure that decommissioning will be carried out with minimum impact on the health and safety of the public and occupationally exposed individuals, and the environment (53 FR 24018). These requirements specify that a licensee either set aside funds for decommissioning activities or provide a guarantee through a third party that funds will be available (see Figure 8.3). Before a license is issued, applicants are required to submit F/A or a DFP when requesting authorization to possess any sealed or unsealed radioactive material with half life (T1/2) greater than 120 days exceeding certain the limits. Criteria for determining whether an applicant must submit a DFP or has an option of submitting either a DFP or F/A are described in 10 CFR 30.35, 10 CFR 40.36, or 10 CFR 70.25.

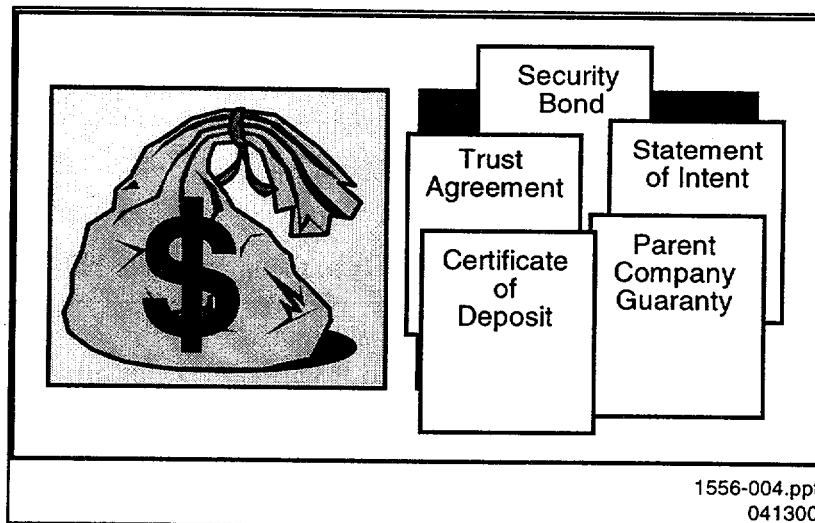

1556-004.ppt
041300

Figure 8.3 Methods of Certification of Financial Assurance for Decommissioning

CONTENTS OF AN APPLICATION

Note: There are two parts to the financial assurance and record keeping for decommissioning rule: (1) financial assurance that applies to some licensees, and (2) record keeping that applies to all licensees.

Regulatory Guide (RG) 3.66, "Standard Format and Content of Financial Assurance Mechanisms Required for Decommissioning Under 10 CFR Parts 30, 40, 70, and 72," dated June 1990, contains approved wording for each mechanism authorized by the regulation to guarantee or secure funds except for the Statement of Intent for government licensees.

Record Keeping

The requirements for maintaining records important to decommissioning, including the type of information required, are stated in 10 CFR Parts 30, 40 and 70. All licensees are required to maintain these records in an identified location until the site is released for unrestricted use (see Figure 8.4). In the event that the licensed activities are transferred to another person or entity, these records shall be transferred to the new licensee before transferring the licensed activities. The new licensee is responsible for maintaining these records until the license is terminated. When the license is terminated, these records shall be transferred to NRC.

10 CFR Part 30, 40, and 70 "Requirements for Disposition of Records Important to Decommissioning" requires that:

- Before licensed activities are transferred, the licensee must transfer or otherwise assign all decommissioning records to the new licensee.

OR

- Before the license is terminated, transfer records to the appropriate NRC regional office.

Response from Applicants: No response is needed from most service provider applicants, with the possible exception of waste brokers who store radioactive waste prior to disposal. If F/A or a DFP is required, submit the required documents as described in Regulatory Guide 3.66.

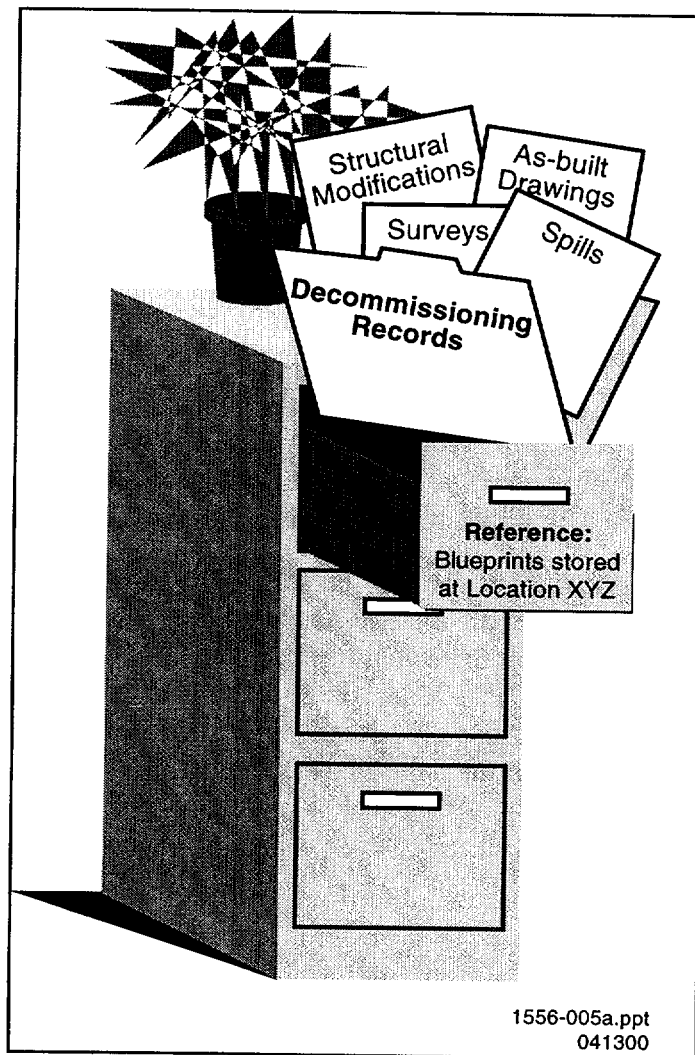

Figure 8.4 Types of Records That Must Be Maintained for Decommissioning.

Note: With the exception of temporary job site locations, licensees must maintain permanent records on locations where licensed materials are used or stored while the license is in force. These permanent records are important for making future determinations about the release of these locations for unrestricted use (e.g., before the license is terminated). Acceptable permanent records include sketches, written descriptions of specific locations where radioactive material is used or stored, and records of any leaking sealed sources, radioactive material spills, contaminated waste storage areas, or other unusual occurrences involving the spread of contamination in or around the licensee's facilities.

References: See the Notice of Availability (on the inside front cover of this report) to obtain copies of RG 3.66 and Policy and Guidance Directive FC 90-2 (Rev. 1), "Standard Review Plan for Evaluating Compliance with Decommissioning Requirements," dated April 30, 1991.

8.6 ITEM 6: PURPOSE(S) FOR WHICH LICENSED MATERIAL WILL BE USED

Regulations: 10 CFR 30.33(a)(1).

Criteria: Radioisotopes and sealed sources requested in the application must be used for purposes authorized by the Atomic Energy Act of 1954, as amended.

Discussion: The licensee must specify the purpose for which each radioisotope or sealed source listed in Item 5 is to be used or possessed incident to providing a specific service. Sealed sources and devices containing licensed materials shall be used only for the purpose for which they are designed, and according to manufacturer's (distributor's) instructions and recommendations for use as specified in the SSD Registration Certificate.

Use of sealed sources and devices other than those listed in the SSD Registration Certificate require review and approval by the NRC or an Agreement State. Only a person specifically licensed by the NRC or an Agreement State shall install, maintain, adjust or repair a device that involves work on the sealed source(s) shielding, the source(s) driving unit, or other electrical or mechanical component that could expose the source, reduce the shielding around the source(s), or compromise the radiation safety of the device or the source(s).

Response from Applicant:

- Leak Test Analysis:
 - State that possession will be for use in performing commercial leak tests services.
- Environmental Sample Analysis
- State that the material will be used for performing commercial laboratory analysis of environmental samples.
- Instrument and/or Dosimetry Calibration:
 - State that possession of sealed sources will be use for commercial calibration of radiation survey instruments and/or personnel dosimetry.
- Services to Devices Containing Sealed Sources:
 - State that possession "incident to performing services" on sealed sources and/or devices will be use for purpose of performing commercial:
 - installation
 - radiation surveys
 - removal
 - disposal

- relocation
- repair
- source exchange
- maintenance
- source retrieval
- transportation
- leak test sample acquisition
- customer training in the proper use of device(s) and for conducting routine, and in some situations, non-routine maintenance of device(s)
- other services not identified above, but excluding activities involving critical mass quantities.

Services Other Than Leak Test and Environmental Sample Analysis Involving Unsealed Materials

- State that use, possession, and “possession incident to performing commercial services” on unsealed materials will be used for the purpose of performing:
 - Nuclear laundry services
 - Waste management services:
 - Incineration
 - Compaction/Supercompaction
 - Solidification or vitrification
 - Packaging, repackaging, and transportation of radioactive waste
 - Decontamination and decommissioning services
 - Site characterization services
 - Other service providers not identified above excluding activities involving critical mass quantities of SNM

8.7 ITEM 7: INDIVIDUAL(S) RESPONSIBLE FOR RADIATION SAFETY PROGRAM AND THEIR TRAINING AND EXPERIENCE

8.7.1 RADIATION SAFETY OFFICER (RSO)

Regulations: 10 CFR 30.33(a)(3).

Criteria: Service provider licensees must have a Radiation Safety Officer (RSO) who is qualified by training and experience in radiation protection, and who is available for advice and assistance on radiological safety matters. The RSO's training and experience must include the uses of licensed material identified on the license so that the RSO is able to oversee the radiation safety program during normal and emergency conditions.

Discussion: Service provider licensees must appoint an RSO who is responsible for radiation safety and compliance with the regulations for the use of radioactive material, that may include byproduct, source, and special nuclear material. The RSO must ensure that radiation safety activities are being performed safely according to approved policies and procedures, and that all regulatory requirements are met. The RSO should have full access to all activities involving the use of licensed material and the authority to terminate any activity in which health and safety appear to be compromised without consulting with executive management.

The RSO's duties and responsibilities include ensuring radiological safety and compliance with NRC and DOT regulations and the conditions of the license (see Figure 8.5).



Figure 8.5 RSO Responsibilities. *Typical duties and responsibilities of RSOs.*

Typically, these duties and responsibilities include ensuring the following:

- Activities involving licensed material that the RSO considers unsafe are stopped
- Radiation exposures are ALARA
- Development, distribution, implementation, and maintenance of up-to-date operating and emergency procedures
- Possession, installation, relocation, use, storage, repair and maintenance of sealed sources, devices and radioactive wastes are consistent with the limitations in the license, individual Sealed Source and Device Registration Certificate(s), and the manufacturer's specific recommendations and instructions
- Evaluations of occupationally exposed individuals are performed to demonstrate that individuals are not likely to receive, in one year, a radiation dose in excess of 10% of the allowable limits or personnel monitoring devices are provided
- When necessary, National Voluntary Laboratory Accreditation Program (NVLAP) approved personnel monitoring devices are used and exchanged at the proper intervals, and records of the results of such monitoring are maintained
- Licensed materials are properly secured
- Documentation is maintained to demonstrate, by measurement or calculation, that the total effective dose equivalent to the individual member of the public that is likely to receive the highest dose from the licensed operation does not exceed the annual limit for members of the public
- Proper authorities are notified of incidents such as damage to sealed sources/devices, loss of licensed material, fire, theft, etc.
- Unusual occurrences are investigated, cause(s) and appropriate corrective action(s) are identified, and timely corrective action(s) are taken
- Radiation safety program audits are performed and documented at least annually
- When the licensee identifies violations of NRC requirements or program weaknesses, the licensee develops, implements, and documents corrective actions
- Licensed material is transported in accordance with all applicable DOT requirements
- Licensed material is disposed of properly
- Appropriate records are maintained
- Up-to-date license is maintained and amendment and renewal requests are submitted in a timely manner
- Monitoring and surveys of all areas in which radioactive material is used
- Ordering, receipt, surveys, and delivery of byproduct material
- Packaging, labeling, surveys, etc. of all shipments of byproduct material leaving the institution

CONTENTS OF AN APPLICATION

- Implementing personnel monitoring program, including determining the need for and evaluating bioassays, monitoring personnel exposure records, and developing corrective actions for those exposures approaching maximum permissible limits
- Effluent monitoring
- Training personnel
- Administering waste disposal program
- Performing/overseeing the inventory and leak testing of sealed sources
- Overseeing decontamination activities
- Investigating any incidents and responding to any emergencies
- Serving as a point of contact for the NRC and licensee's management during routine operations, emergencies, or incidents
- Maintaining records required that are necessary to support the license and satisfy NRC regulations.

The responsibilities of the RSO may not be transferred to other individuals. Many tasks and duties associated with managing the program may be assigned or delegated to other qualified individuals; however, the responsibility for these tasks and duties remains with the RSO. NRC recognizes that a qualified individual will on occasion fill in for the RSO when the RSO is away for short periods of time, e.g. professional conferences, vacation, illness, etc. Absences that have a major impact on licensed activities should not occur for extended or indefinite periods of time. Consideration should be given to how individuals temporarily delegated the duties and tasks of the absent RSO could contact the RSO in the event of an emergency.

When management selects an RSO, they should keep in mind the duties and responsibilities of the position, and select an individual who is qualified to serve as the RSO. The RSO will need a basic technical knowledge sufficient to understand, in general, the majority of the work being done with licensed materials under his or her responsibility. The individual selected as RSO should have sufficient training and experience to perform the duties required by his or her position. Executive management should ensure that the RSO has sufficient time is allocated to carry out the responsibilities of the position.

Response from Applicant: Provide the following:

- The name of the proposed RSO who will be responsible for ensuring that the licensee's radiation safety program is implemented in accordance with approved procedures.

AND

- Demonstrate that the RSO has sufficient independence and direct communication with responsible management officials by providing a copy of an organizational chart by position, demonstrating day-to-day oversight of the radiation safety activities.

AND EITHER

- The specific training and experience of the RSO.
- Include the specific dates training in radiation safety.

OR

- Alternative information demonstrating that the proposed RSO is qualified by training and experience (e.g., Board Certification by the American Board of Health Physicists, completion of a bachelor's and/or master's degree in the sciences with at least one year of experience in the conduct of a radiation safety program of comparable size and scope).

Note: It is important to notify NRC, as soon as possible, typically within 30 days, of changes in the designation of the RSO. The name and qualifications of the replacement RSO must be submitted to NRC as part of an amendment request. Applicants should review the regulations for program areas which have specific requirements regarding changes in the RSO.

8.7.2 AUTHORIZED USER

Regulations: 10 CFR 19.11, 10 CFR 19.12, 10 CFR 19.13, 10 CFR 30.33(a)(3), 10 CFR 30.34(e), 10 CFR 40.32, 10 CFR 70.22.

Criteria: Authorized users (AUs) must have adequate training and experience to use, possess, or provide services involving licensed materials. Duration of training and experience should be commensurate with the expected hazards service provider personnel may encounter during routine and emergency conditions. Successful completion of training as described in Appendix H is evidence of adequate training and experience. Experience requirements could consist of on-the-job training done under the supervision of a qualified individual (AU, RSO, or manufacturer's representative that is authorized by the NRC or an Agreement State for the purpose(s) or activities that will be authorized in the license, when issued.).

Frequency of Training

Discussion: An AU is a person whose training and experience meet NRC criteria specified in Appendix H, who is named either explicitly or implicitly on the license, and who uses or directly supervises the use of licensed materials. An AU must ensure the proper use of licensed materials possessed under the license. AUs must have training to provide reasonable assurance that they will use, possess, or provide services involving licensed materials in a safe manner, maintain security, prevent unauthorized access, and respond appropriately to emergencies. The classroom part of the training for AUs could range from a few hours to several days or more.

An AU is considered to be supervising the use of licensed material when he or she directs personnel in operations involving licensed material. Although the AU may delegate specific tasks to supervised users (e.g., maintaining records, conducting routine maintenance), the AU

CONTENTS OF AN APPLICATION

remains responsible for safe use of licensed material. An individual's supervised hands-on experience should be adequate to address routine licensed activities and include a discussion or drill on emergency procedures.

Response from Applicant: Provide either of the following:

- The statement: "Before using licensed material, authorized users will receive the training described in Appendix H in draft NUREG-1556, Vol. 18, 'Consolidated Guidance About Materials Licenses: Program-Specific Guidance About Service Provider Licenses,' dated May 2000";

OR

- A description of the training and experience for proposed authorized users.

Note: Alternative response will be evaluated using the criteria listed above.

8.7.3 ANCILLARY PERSONNEL

Regulations: 10 CFR 19.11, 10 CFR 19.12, 10 CFR 19.13, 10 CFR 30.7, 10 CFR 30.9, 10 CFR 30.10, 10 CFR 30.33.

Criteria: Ancillary personnel may include individuals whose assigned duties involve exposure to radiation and/or radioactive material, and individuals who in the course of their employment are likely to receive in a year an occupational dose of radiation greater than 1 mSv (100 mrem). These individuals must receive instruction commensurate with their duties and responsibilities, as required by 10 CFR 19.12.

Ancillary personnel may include clerical, housekeeping, security, any customers' personnel or staff member working under the supervision and direction of the service provider's RSO or AU at the time licensed materials are possessed (incident to providing services) under the service provider's license, and other similar types of personnel whose duties may require them to work in the vicinity of radioactive material, whether they are escorted or not by authorized users. These individuals should be informed about radiation hazards and the appropriate precautions they should take when working in the vicinity of licensed material. The licensee should assess each individual's involvement with licensed material and provide appropriate training.

Discussion: Before beginning work with licensed material, most individuals must receive radiation safety training commensurate with their assigned duties. Each individual should also receive periodic refresher training.

Licensees should not assume that safety instruction has been adequately covered by previous radiation safety training. Particular attention should be given to individuals performing work or in the immediate vicinity or work being performed with radioactive materials that may require special procedures, e.g., sealed source exchange, service operations that create high radiation

areas, etc. Training may be in the form of lecture, demonstrations, videotape, or self-study, and should emphasize practical subjects important to the safe use of licensed material. The guidance in Appendix H may be used to develop a training program. The program should consider both the topics pertinent for each group of workers and the method and frequency of training.

The person conducting the training should be a qualified individual (e.g., a person who meets the qualifications for RSO or authorized user on the license and is familiar with the licensee's program).

Response from Applicant: Provide either of the following:

- The statement: "Before using licensed materials, ancillary personnel will have successfully completed the Classroom Training portion of the training course described in Criteria in the section entitled 'Training for Authorized Users' in draft NUREG-1556, Vol. 18, 'Consolidated Guidance about Materials Licenses: Program-Specific Guidance about Service Provider Licenses,' dated May 2000."

OR

- A description of the radiation safety training program, including topics covered, groups of workers, assessment of training, qualifications of instructors, and the method and frequency of training.

8.8 ITEM 8: TRAINING FOR INDIVIDUALS WORKING IN OR FREQUENTING RESTRICTED AREAS (OCCUPATIONALLY EXPOSED INDIVIDUALS AND ANCILLARY PERSONNEL)

Regulations: 10 CFR 19.11, 10 CFR 19.12, 10 CFR 19.13, 10 CFR 20.1801, 10 CFR 20.1802, 10 CFR 30.7, 10 CFR 30.9, 10 CFR 30.10, 10 CFR 30.33(a)(3), 10 CFR 30.34(e), 10 CFR 40.32(b), 10 CFR 40.41(e), 10 CFR 70.23(a)(2), 10 CFR 70.32(b).

Criteria: Individuals whose assigned duties involve exposure to radiation and/or radioactive material (from both licensed and unlicensed sources), and in the course of their employment are likely to receive in a year an occupational dose of radiation greater than 1 mSv (100 mrem), whether from all external sources, all internal sources, or any combination, must receive instruction commensurate with their duties and responsibilities, as required by 10 CFR 19.12. If a licensee's prospective analysis determines that the potential exposure is greater than 5 mSv (500 mrem), then more extensive training commensurate with the potential radiological health protection problems is appropriate.

Discussion: Before beginning work with licensed material, individuals must receive radiation safety training commensurate with their assigned duties and specific to the licensee's radiation safety program. Each individual should also receive periodic refresher training at no more than 12 month intervals.

CONTENTS OF AN APPLICATION

Licensees should not assume that safety instruction has been adequately covered by prior employment or academic training. Site-specific training should be provided for all individuals. Ancillary personnel (e.g., clerical, housekeeping, security) whose duties may require them to work in the vicinity of radioactive material (whether escorted or not) need to be informed about radiation hazards and the appropriate precautions. The licensee should assess each individual's involvement with licensed material and cover each applicable subject appropriately.

Training may be in the form of lecture, demonstrations, videotape, or self-study, and should emphasize practical subjects important to the safe possession and use of licensed material. If training is not conducted by an instructor, a method should be adopted whereby a trainee can ask questions and discuss topics relating to occupational radiation exposure. The guidance in Appendix H may be used to develop a training program. The program should consider all topics pertinent for each group of workers and also the method and frequency of training. The program should evaluate whether or not the audience understands the materials presented.

The person conducting the training should be a qualified individual (e.g., a person who meets the qualifications for RSO or authorized user on the license and is familiar with the licensee's program).

Response from Applicant: A description of the radiation safety training program, including topics covered, groups of workers, assessment of training, qualifications of instructors, and the method and frequency of training.

8.9 ITEM 9: FACILITIES AND EQUIPMENT

Regulations: 10 CFR 20.1101(b), 10 CFR 20.1406, 10 CFR 30.33, 10 CFR 30.33(a)(2), 10 CFR 30.35(g), 10 CFR 40.32(c), 10 CFR 70.23(a)(3).

Criteria: Facilities and equipment must be adequate to protect health, minimize danger to life or property, minimize the possibility of contamination, and keep exposure to occupationally exposed workers and the public ALARA.

Discussion: Applicants must demonstrate that proposed facilities and equipment provide adequate storage capabilities, appropriate shielding, maintain radiation exposures ALARA, and minimize the possibility of contamination or release of licensed materials as a result of normal and emergency conditions including fire, floods, and wind damage.

Licensed materials located in an unrestricted area and not in storage must be under the constant surveillance and immediate control of the licensee. Licensed materials should be accessible only by authorized persons and secured or locked when an authorized person is not physically present. If accessible by unescorted, unauthorized persons, use or storage areas cannot be considered restricted areas for purposes of radiation safety.

Applicants may elect to delay completing permanent facilities that will be specifically listed on its license and acquiring equipment described in the application until the technical review of the application is completed by the licensing staff. Delaying the acquisition allows for changes identified as a result of the technical review of the application.

In all cases, the applicant cannot possess or use licensed material until after the facilities are approved, equipment is procured, and the license is issued.

Response from Applicant:

For permanent facilities specifically identified on the license:

Applicants requesting the use of sealed radioactive material in the following commercial applications:

- Leak Testing and Environmental Sample Analysis Providers: No response required for facilities.
- Instrument Calibration: If only sealed sources are possessed in registered devices designed to emit a collimated beam for the purpose of instrument calibration, no response required.
- Services that involve handling of sealed sources in an shielded container: No response required.
- Services that involve handling of sealed sources outside a shielded container:
 - Submit a drawing or sketch of the proposed permanent facility identifying areas where radioactive materials, including radioactive wastes, will be used or stored.
 - Show in the drawings the relationship and distance between restricted areas and adjacent unrestricted areas.
 - Specify in the drawings shielding materials (concrete, lead, etc.) and means for securing radioactive materials from unauthorized removal.
 - Drawings, sketches, diagrams, etc. should indicate the scale, or include dimensions on each drawing or sketch.
 - Describe engineered safety systems e.g. area monitors, interlocks, alarms, etc.

Applicants requesting the use of unsealed radioactive material in the following applications:

- Leak Test and Environmental Sample Analysis Providers: No response required for facilities.
- Other services that involve handling of unsealed radioactive material:
 - Describe the permanent facilities and equipment to be made available at each location where unsealed radioactive material will be used or handled.

CONTENTS OF AN APPLICATION

- Include a description of the area(s) assigned for the receipt, storage, security, preparation, handling, waste storage and measurement of radioactive materials.
- Submit a facility diagram showing the proximity of licensed materials to unrestricted areas.
- Drawings, sketches, diagrams, etc. should indicate the scale, or include dimensions on each drawing or sketch.
- Submit a diagram, sketch, or drawing, when applicable, that identifies areas where radioactive materials may become airborne. The diagram should contain descriptions of the ventilation systems, with pertinent airflow rates, filtration equipment, sample collection points, and monitoring systems.
- Submit a diagram of radioactive waste handling equipment that includes incinerators, compactors, solidification equipment, hold-up tanks, sample collection points, etc.
- Describe proposed laundry facilities, if applicable, used for contaminated protective equipment and clothing. Specify how the contaminated waste water from the laundry machines or sinks is disposed. Operating and emergency procedures should address decontamination of the laundry area and equipment.
- Describe protective clothing (such as rubber gloves, coveralls, respirators, and face shields), auxiliary shielding, absorbent materials, secondary containers for waste water storage for decontamination purposes, plastic bags for storing contaminated items, etc., that will be available.
- Identify specialized handling tools, facility safety interlocks designed to prevent operation of radiological safety systems in the event that operation of a system could result in accidental exposure or release of material (e.g., HEPA filters, ventilation system, safety door interlocks, etc.) or equipment.

For temporary job sites:

For applicants requesting the use of sealed radioactive material:

- No facility description is required.
- Applicants requesting the use of sealed radioactive material in the following applications:
 - Specialized handling tools or equipment.

For applicants requesting the use of unsealed radioactive material:

- Describe protective clothing (such as rubber gloves, coveralls, respirators, and face shields), auxiliary shielding, absorbent materials, secondary containers for waste water storage for decontamination purposes, plastic bags for storing contaminated items, etc., that will be available.

8.10 ITEM 10: RADIATION SAFETY PROGRAM

A radiation safety program must be established and submitted to the NRC as part of the application. The program must be commensurate with the scope and extent of activities for the use of licensed materials in service operations. Each applicant must develop, document, and implement a radiation protection program specific to its types of operations. Radiation safety programs should address the following elements:

- Development and implementation of an ALARA program.
- Description of equipment and facilities adequate to protect personnel, the public and the environment.
- Confirmation that licensed activities are conducted only by individuals qualified by training and experience.
- Development and maintenance of written operating and emergency procedures.
- Implementation of an audit program to ensure that, at least annually, the radiation safety program is reviewed.
- Description of organization structure and individuals responsible for ensuring day-to-day oversight of radiation safety program.
- Establishment and management of a radiation safety and decommissioning records system.

Discussion: Individual components of a radiation safety program are addressed in the topics found in this draft NUREG. Some topics will not require the applicant to submit information as part of an application, but simply provide the applicant with guidance to comply with a specific NRC requirement.

Applicants who plan to provide services using either sealed or unsealed materials are required to submit their Operating and Emergency procedures for NRC approval or, optionally, provide an outline or summary of each procedure that includes the important radiation safety aspects of each individual procedure. Radiation safety programs that include unsealed licensed materials must assure that it addresses these additional concerns:

- Methods or procedures for preventing the release of contaminated material and equipment.
- Methods or procedures for preventing personnel contamination.
- Radiation safety procedures and the authorized users responsibilities unique to each type of service operation requested in the application.
- Equipment, techniques, and corresponding radiation safety procedures associated with providing services involving either sealed sources or unsealed materials.

CONTENTS OF AN APPLICATION

Response from Applicant: The applicant must establish and submit its radiation protection program. Each item listed above should be addressed in the corresponding sections of this draft guide.

8.10.1 AUDIT PROGRAM

Regulations: 10 CFR 20.1101, 10 CFR 20.2102, 10 CFR 71.5.

Criteria: Licensees must review the content and implementation of their radiation protection programs at least annually to ensure the following elements are satisfied:

- Compliance with NRC and DOT regulations (as applicable), and the terms and conditions of the license;
- Occupational doses and doses to members of the public are as low as reasonably achievable (ALARA); and
- Records of audits and other reviews of program content are maintained for at least three years from the date of the record.

Discussion: A review of the content and implementation of the radiation protection program by the licensee or its consultant is required at least annually. Appendix I contains a suggested audit checklist that is specific to Service Provider licensees who perform activities within the scope of this document. All areas indicated in Appendix I may not be applicable to every licensee. For example, licensees do not need to address areas which do not apply to their activities.

If an audit identifies violations of NRC requirements, the licensee should first evaluate the safety significance of each violation to set priorities and identify resources to correct these violations. Information Notice (IN) 96-28, "Suggested Guidance Relating to Development and Implementation of Corrective Action," dated May 1, 1996, provides guidance on this subject. Certain identified problems or potential violations may require notification or a report to NRC. Licensees are encouraged to contact NRC for guidance if there is any uncertainty regarding a reporting requirement. NRC routinely reviews licensee's records to verify if appropriate corrective actions were implemented in a timely manner to prevent recurrence. It is in a licensee best interest to identify potential violations of regulatory requirements and take necessary steps to correct them. NRC can exercise discretion and elect not to cite the licensee for these violations if prompt and effective corrective actions are implemented. Additionally, NRC policy allows licensees with a good regulatory performance, as shown by a licensee's inspection history, to be inspected less frequently than licensees where NRC staff identify significant violation(s) during an inspection. For information on NRC's use of discretion on issuing a notice of violation, refer to NUREG 1600, "General Statement of Policy and Procedures for NRC Enforcement Actions." Currently, the NRC's emphasis in inspections is to perform actual observations of work in progress. As a part of the audit programs, licensee are encouraged to perform unannounced audits of authorized users to determine if, for example, Operating and Emergency Procedures are available and followed. When conducting inspections, NRC routinely reviews corrective actions

to ensure they were implemented in a timely manner following a self-identified violation and in such a manner prevent recurrence. Licensees must maintain records of these audits and other reviews of program content and implementation for at least 3 years from the date of the record.

Audit records should include the following information: date of audit, name of person(s) who conducted audit, persons contacted by the auditor(s), areas audited, audit findings, corrective actions, and follow-up.

Response from Applicant: The applicant's program for reviewing the content and implementation of its radiation protection program will be examined during inspections, but should not be submitted in the license application.

References: The current version of NUREG-1600 is available electronically at <http://www.nrc.gov/OE>. INs are available in the "Reference Library" on NRC's Home Page at <http://www.nrc.gov>. For hard copies of Draft NUREG-1600, IN 96-28, and MC 87110, Appendix A, "Industrial/Academic/Research Inspection Field Notes," see the Notice of Availability (on the inside front cover of this report).

8.10.2 RADIATION MONITORING INSTRUMENTS

Regulations: 10 CFR 20.1501, 10 CFR 20.2103(a), 10 CFR 30.33(a)(2).

Criteria: Licensees must possess and periodically calibrate radiation monitoring instruments that are necessary to protect health and minimize danger to life or property. Instruments used for quantitative radiation measurements must be calibrated periodically for the radiation measured.

Discussion: Licensees must ensure that an adequate number of calibrated radiation detection and measurement instruments are available to make radiation measurements. Instruments should be calibrated periodically for the types of radiation being measured. In this document, survey instruments are defined as any device used to measure radiological conditions. Figure 8.6 illustrates some common survey instruments used for making contamination surveys and to taking direct radiation measurements.

CONTENTS OF AN APPLICATION

Contamination Detector

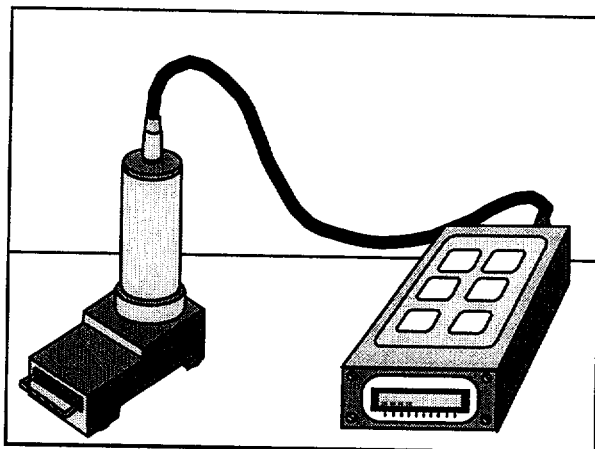

Beta/gamma Probes

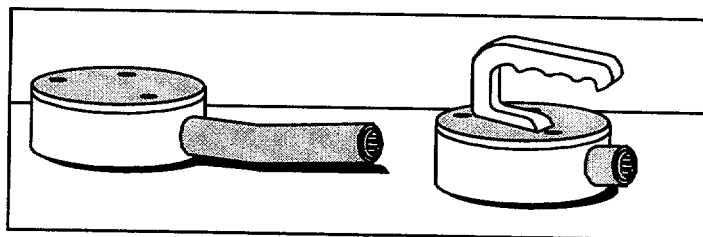

Survey Meter and Attached Beta/gamma Probe

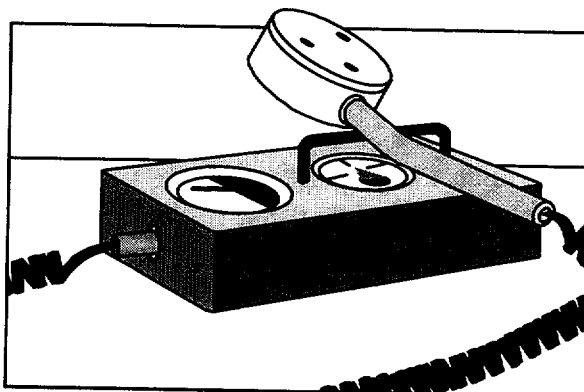

1556-053.ppt
050900

Figure 8.6 Examples of Portable Instruments

Service provider applications should include:

- Criteria used in determining what radiation detection and monitoring equipment will be required for the type of measurement to be taken (count rate, dose rate, etc.)
- Type of use

- Number and availability of a sufficient quantity of these calibrated radiation detection and measurement instruments:
 - Ion-chambers
 - G-Ms
 - Liquid scintillation counters
 - Pocket ion chambers
 - Alarming ratemeters
 - Area monitors

NRC requires that radiation monitoring devices used to determine compliance with regulatory requirements be calibrated periodically by the instrument manufacturer or persons specifically authorized by NRC or an Agreement State. Radiation monitoring devices and personnel dosimetry devices (PIC, alarming ratemeters, etc.) should be calibrated at least annually (every 12 months) unless otherwise specified by regulation or license condition. Licensees seeking authorization to perform radiation monitoring instrument calibrations will need to submit procedures for review or commit to implementing the procedure in Appendix J. The licensee may wish to review available industry standards for calibration of instruments such as ANSI N323A-1997, "Radiation Protection Instrumentation Test and Calibration, Portable Survey Instruments."

Response from Applicant: Provide one of the following:

- A description of the instrumentation (as described above) that will be used to perform required surveys and a statement that: "We will use instruments that meet the radiation monitoring instrument specifications published in Appendix J to draft NUREG-1556, Vol. 18, 'Consolidated Guidance about Materials Licenses: Program-Specific Guidance about Service Provider Licenses,' dated May 2000.' We reserve the right to upgrade our survey instruments as necessary."

OR

- A description of the instrumentation (as described above) that will be used to perform required surveys and a statement that: "We will use instruments that meet the radiation monitoring instrument specifications published in Appendix J to draft NUREG-1556, Vol. 18, 'Consolidated Guidance about Materials Licenses: Program-Specific Guidance about Service Provider Licenses,' dated May 2000. Additionally, we will implement the model survey meter calibration program published in Appendix J to Draft NUREG-1556, Vol. 18, 'Consolidated Guidance about Materials Licenses: Program-Specific Guidance about Service Provider Licenses,' dated May 2000. We reserve the right to upgrade our survey instruments as necessary."

OR

CONTENTS OF AN APPLICATION

- A description of alternative equipment and/or procedures for ensuring that appropriate radiation monitoring equipment will be used during licensed activities and that proper calibration and calibration frequency of survey equipment will be performed. Further, the statement “We reserve the right to upgrade our survey instruments as necessary” should be added to the response.

Note: Alternative responses will be reviewed using the criteria listed above.

8.10.3 MATERIAL RECEIPT AND ACCOUNTABILITY

Regulations: 10 CFR 30.34(e), 10 CFR 30.35(g), 10 CFR 30.41, 10 CFR 30.51, 10 CFR 20.1501(a), 10 CFR 20.1801, 10 CFR 20.1802, 10 CFR 20.1906, 10 CFR 20.2001, 10 CFR 20.2201.

Criteria: Licensees must do the following:

- Develop, implement, and maintain written procedures for radioactive material package receipt and shipment.
- Develop, implement, and maintain procedures to ensure control and accountability of licensed material.
- Maintain records of receipt, transfer, and disposal of licensed material.

Discussion: Licensees are required to develop, implement, and maintain written procedures for safely opening packages in accordance with 10 CFR 20.1906. Some packages containing licensed material may require special opening procedures based on the types, quantities, or half-lives of the nuclide being delivered. Arrangements should be made to receive radioactive packages expeditiously when they are delivered to your permanent facility or at temporary job sites at a customer’s facility that will receive packages. Alternatively, arrangements may be made for you to be notified when radioactive packages arrive at the carrier’s terminal. A model procedure for safely opening packages containing licensed materials is included in Appendix K.

Individuals that will receive packages containing licensed material should be trained to do the following:

- Identify the package as radioactive by labeling and shipping papers
- Segregate the package from other incoming items in a secured area.
- Notify the RSO or AU.

When notified that a package of licensed material has arrived, the RSO or AUs should retrieve the package and follow radioactive material receipt procedures. NRC regulations in 10 CFR 20.1906(b) and (c) state the requirements for monitoring packages containing licensed material. These requirements are described in Table 8.2 below.

Table 8.2 Package Monitoring Requirements

Package	Contents	Survey Type	Survey Time*
LSA I	Ores, U, Th, Non-fissile limited A2	Contamination Radiation Level	As soon as practicable, but not later than 3 hours after receipt of package LSA II
LSA II	Tritiated water, Solid U/Th mixed compound, Non-fissile unlimited A2	Contamination Radiation Level	As soon as practicable, but not later than 3 hours after receipt of package
LSA III	Uniformly distributed insoluble material	Contamination Radiation Level	As soon as practicable, but not later than 3 hours after receipt of package
SCO I/II Surface Contaminated Objects	Contaminated objects, or on accessible surfaces	Contamination Radiation Level	As soon as practicable, but not later than 3 hours after receipt of package
Labeled (White I, Yellow II, Yellow III)	Gas or Special Form Greater Than Type A	Radiation Level	As soon as practicable, but not later than 3 hours after receipt of package
Labeled (White I, Yellow II, Yellow III)	Not Gas Nor Special Form Greater Than Type A	Contamination Radiation Level	As soon as practicable, but not later than 3 hours after receipt of package
Labeled (White I, Yellow II, Yellow III)	Gas or Special Form Less Than Type A	None	None
Labeled (White I, Yellow II, Yellow III)	Not Gas Nor Special Form Less Than Type A	Contamination	As soon as practicable, but not later than 3 hours after receipt of package
Not Labeled	Licensed Material	None	None
Damaged	Licensed Material	Contamination Radiation Level	As soon as practicable, but not later than 3 hours after receipt of package

* Assumes packages are received during normal working hours. If packages are received outside of normal working hours, the licensee has three hours after the beginning of the next work day to perform the required surveys.

If removable radioactive surface contamination on the package exceeds the limits of 10 CFR 71.87(i); or external radiation levels exceed the limits of 10 CFR 71.47, 10 CFR 20.1906(d) requires that the licensee immediately notify the final delivery carrier. Additionally, the administrator of the appropriate NRC Regional Office listed in Appendix D to 10 CFR Part 20 must be notified immediately (within 24 hours).

CONTENTS OF AN APPLICATION

As illustrated in Figure 8.7, licensed materials must be tracked from receipt to disposal in order to ensure accountability and to confirm that possession limits are not exceeded.

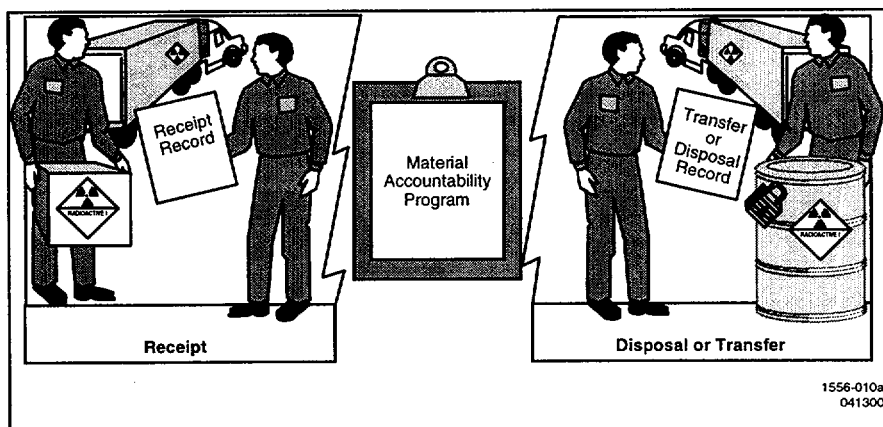

Figure 8.7 Material Receipt and Accountability. Licensees must maintain records of receipt, transfer, and disposal of licensed material.

Licensed material possessed at customers' facilities may be received by the customer in advance of the service provider licensee performing services. In certain circumstances, this material is received and possessed by the customer under the auspices of the customer's license until a licensed service provider can take possession incident to performing services. Licensees must have in place an accountability and control system for promptly detecting missing licensed material at permanent facilities, customer's facilities, temporary job sites, or any other locations where loss, theft, or misplacement of licensed material can occur. Operating and emergency procedures should address how you will maintain control and accountability of licensed material possessed incident to performing commercial services at customer's facilities.

Licensees who use and/or possess sealed sources are required by license condition to perform inventories of sealed sources every six months. Service provider licensees must account for all sealed sources, including those that have been taken out of service and await disposal, sources placed in storage prior to use or installation, and sources in the control of the licensee. At six month frequency, licensees should confirm that the sealed sources and devices that have been placed in storage or removed from service have not been lost, misplaced, and that radiological conditions have not deteriorated. Because licensees are required to conduct periodic leak tests of sealed sources, records of leak tests may serve as an inventory record provided the leak test records include necessary information to identify the source and location. If leak tests are performed at intervals of greater than six months, additional inventories aside from those associated with leak tests must be performed. Licensees may use various methods (e.g., computer programs, manual ledgers, log books) to account for receipt, use, transfer, disposal, and decay of licensed material.

To ensure that only the RSO or AUs use or supervise the use of licensed material, the RSO should know who has requested an order of licensed material and the types and amounts of licensed materials requested. A model procedure for ordering and receiving radioactive material is included in Appendix K.

Licensees must maintain records of receipt, use, transfer, and disposal (as waste) as indicated in Table 8.3.

Table 8.3 Record Maintenance

Type of Record	How Long Record Must be Maintained
Receipt	For as long as the material is possessed until 3 years after transfer or disposal
Transfer	For 3 years after transfer
Disposal	Until NRC terminates the license
Important to decommissioning	Until the site is released for unrestricted use

Licensed material possessed incident to performing services at customer's facilities is not normally transferred to the service provider during the time service is being performed. One notable exception is when the service provider is preparing the shipment to be shipped and is designated as the shipper of record (i.e., signing the Shipper's Certification on the shipping paper).

Response from Applicant:

State: "Ordering licensed material and package receipt and opening will follow the model procedures in draft NUREG 1556, Vol. 18, Appendix K."

OR

Submit a description of procedure(s) for ordering licensed material and package receipt and opening.

AND

For unsealed licensed material, submit a description of procedure(s) for ensuring material accountability.

CONTENTS OF AN APPLICATION

Note:

- Your license will be conditioned to require physical inventories to be conducted at intervals not to exceed 6 months, to account for all sealed sources and devices received and possessed under the license.
- Alternative responses will be evaluated using the criteria listed above.

Reference:

See the Notice of Availability on the inside front cover of this report to obtain a copy of:

- NUREG-1460, Revision 1, "Guide to NRC Reporting and Record keeping Requirements,"
- NUREG 1660/RAMREG-002, "Specific Schedules of Requirements for Transport of Specified Types of Radioactive Material Consignments."

Additional References:

- Larson, William A., *A Health Physics Management Program for the Receipt and Shipment of Radioactive Materials*, Proceedings of the Ninth Midyear Topical Symposium of the Health Physics Society on "Operational Health Physics," Denver, CO, USA (1976).
- NCRP Report No. 114, "Maintaining Radiation Protection Records," (1992)²
- NCRP Report No. 59, "Operational Radiation Safety Program," (1978)²

8.10.4 OCCUPATIONAL DOSE

Regulations: 10 CFR 20.1501, 10 CFR 20.1502, 10 CFR 20.1201, 10 CFR 20.1202, 10 CFR 20.1203, 10 CFR 20.1204, 10 CFR 20.1207, 10 CFR 20.1208, 10 CFR 20.1703, 10 CFR 20.2106, 10 CFR 20 Appendix B.

Criteria: The use of individual monitoring devices for external dose is required for service personnel with the potential of receiving 10% of the annual dose identified in Figure 8.8.

Discussion: The licensee should perform an evaluation of the dose the individual is likely to receive prior to allowing the individual to receive the dose (prospective evaluation). When performing the prospective evaluation, only a dose that could be received at the facilities of the applicant or licensee performing the evaluation needs to be considered. These estimates can be based on any combination of work location radiation monitoring, survey results, monitoring results of individuals in similar work situations, or other estimates to produce a "best estimate" of the actual dose received. For individuals who have received doses at other facilities in the current year, the previous dose need not be considered in the prospective evaluation if monitoring

² Copies may be obtained from the National Council on Radiation Protection and Measurements, 7910 Woodmont Ave., Suite 800, Bethesda, MD 20814-3095 or ordered electronically at <<http://www.nrpc.com>>.

was not required at the other facilities. This evaluation need not be made for every individual; evaluations can be made for employees with similar job functions or work areas.

If the prospective evaluation shows that an individual's dose is not likely to exceed 10% of any applicable regulatory limit, the individual is not required to be monitored for radiation exposure and there are no record keeping or reporting requirements for doses received by that individual. If the prospective dose evaluation shows that the individual is likely to exceed 10% of an applicable limit, monitoring is required.

Licensees shall monitor worker exposures for:

- Adults who are likely to receive an annual dose in excess of any of the following:
 - 5 mSv (0.5 rem) deep-dose equivalent
 - 15 mSv (1.5 rems) eye dose equivalent
 - 50 mSv (5 rems) shallow-dose equivalent to the skin
 - 50 mSv (5 rems) shallow-dose equivalent to any extremity
- Minors who are likely to receive an annual dose in excess of any of the following:
 - 1.0 mSv (0.1 rem) deep-dose equivalent
 - 1.5 mSv (0.15 rem) eye dose equivalent
 - 5 mSv (0.5 rem) shallow-dose equivalent to the skin
 - 5 mSv (0.5 rem) shallow-dose equivalent to any extremity
- Declared pregnant women who are likely to receive an annual dose from occupational exposures in excess of 1.0 mSv (0.1 rem) deep-dose equivalent, although the dose limit applies to the entire gestation period.

Internal exposure monitoring is required for:

- Adults likely to receive in 1 year an intake in excess of 10% of the applicable ALIs for ingestion and inhalation.
- Minors and declared pregnant women likely to receive in 1 year a committed effective dose equivalent in excess of 1.0 mSv (0.1 rem).

If an individual is likely to receive in 1 year a dose greater than 10% of any applicable limit (See Figure 8.8 for annual dose limits for adults), monitoring for occupational exposure is required.

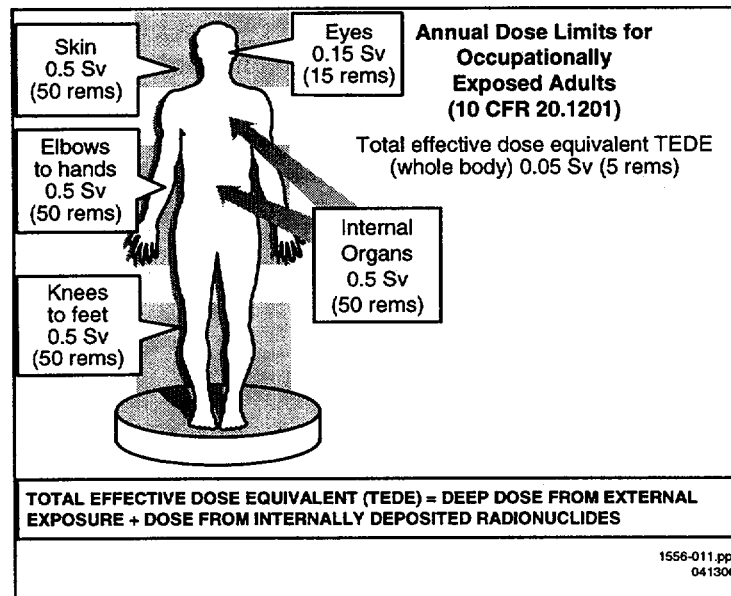

Figure 8.8 Annual Dose Limits for Occupationally Exposed Individuals.

If monitoring is not required to demonstrate compliance with all limits, but is required relative to one or more specific limits, the licensee should enter “NR” for “Not Required” in the blocks on NRC Forms 4 and 5 to indicate the areas for which monitoring was not required (e.g., extremity or skin doses). Where monitoring was provided but not measurable, the licensee should enter “ND” for “Not Detectable.”

If the prospective dose evaluation shows that the individual is likely to exceed 10% of an applicable limit, monitoring is required (10 CFR 20.1502). Record keeping of the results of monitoring performed regardless of the actual dose received, is required by 10 CFR 20.2106 (a).

A common method for dose evaluation is to monitor workers’ dose with whole body and extremity dosimetry (thermoluminescent dosimeters (TLD), Optically Stimulated Luminescence dosimeters (OSLs), film badges, ring badge, etc.) provided by a (NVLAP)-approved dosimetry service. Workers are typically monitored for a year or more to determine actual annual dose. The monitoring results are then used to determine the need to continue monitoring workers. The dose to workers may need to be reevaluated if there are changes to the licensee’s program, such as procedures, frequency of use, quantity of licensed material used, isotopes used, etc.

Licensees may not permit any individual to provide services requiring dosimetry unless, at all times during the handling of these materials, each individual wears on the trunk of the body a NVLAP-approved personnel dosimetry sensitive to the type of radiation(s) to which the individual is exposed. Film badges should be replaced at intervals not to exceed one month, and TLDs or OSL at intervals not to exceed three months.

Internal Radiation Dose:

Bioassays are required when individuals work with airborne radioactive material in the quantities, chemical and physical forms, and activities that make it likely that the radionuclide will be ingested, inhaled, or absorbed resulting in an intake in excess of 10% of the applicable annual limit on intakes (ALIs) in Table 1, Columns 1 and 2, of Appendix B to 10 CFR Part 20. One ALI results in a CEDE

Guidance on bioassay programs for iodine-131, including the levels and types of handling for which bioassays are indicated, is provided in Regulatory Guide 8.20, "Applications of Bioassay for iodine-125 and iodine-131." Copies may be obtained from NRC's Regional Offices or at locations identified on the inside cover of the draft report in the Notice of Availability.

Bioassay services are available and provided by local hospitals, universities, or other vendors specifically approved to provide such services.

Response from Applicant: Provide the following:

- A statement that: "We have done a prospective evaluation and determined that unmonitored individuals are not likely to receive, in one year, a radiation dose in excess of 10% of the allowable limits in 10 CFR Part 20," or "we will monitor individuals in accordance with the criteria in the section entitled 'Occupational Dose' in draft NUREG-1556, Vol. 18, 'Consolidated Guidance about Materials Licenses: Program-Specific Guidance about Service Provider Licenses,'" dated May 2000.

OR

- A description of an alternate method for demonstrating compliance with the referenced regulations.

AND/OR

- Provide a bioassay program when using unsealed radioactive materials. If an applicant elects to provide a bioassay program that is less conservative than recommended in Regulatory Guide 8.20, its rationale should be stated.

OR

- Bioassay programs must include what the applicant considers an acceptable interval or schedule for conducting bioassays, identify action levels or guidelines, and describe specific actions to be taken when action levels are exceeded. Because of the complex nature of bioassay and corresponding data analysis, it is acceptable for applicants to make reference to the procedures in NRC guidance documents.

CONTENTS OF AN APPLICATION

OR

- Contract with an outside group for bioassay services. Provide a commitment that each vendor is licensed or otherwise authorized by NRC or Agreement State to provide required bioassay services.

For guidance about methodologies for determination of internal occupational dose and summation of occupational dose, refer to Regulatory Guide 8.34, "Monitoring Criteria and Methods to Calculate Occupational Doses," dated July 1992, and Regulatory Guide 8.9, "Acceptable Concepts, Models, Equations, and Assumptions for a Bioassay Program," dated July 1993. NRC also has additional Regulatory Guides that have been developed for specific isotopes such as H-3 and iodine. For copies of these guidance documents contact the appropriate NRC regional office or contact the NRC's web site (www.nrc.gov).

Response from Applicant: Provide either of the following:

- State: "NVLAP accredited dosimetry (film badge, TLD, OSL, etc.) will be processed by a NVLAP accredited entity. NVLAP accredited dosimetry will be exchanged at the frequency specified in Section 8.10.4 of draft NUREG 1556, Vol. 18."

OR

- A description of an alternate method for demonstrating compliance with the referenced regulations.

To obtain a copy of the NIST Publication 810, "National Voluntary Laboratory Accreditation Program, 1997 Directory," contact the Superintendent of Documents, U.S. Government Printing Office, Washington, DC 20402-9225. (For information on the program call NIST at 301-975-3679). Also NVLAP maintains a directory of accredited laboratories on the Internet that is updated quarterly. The URL for NVLAPs home page on the Internet is <http://ts.nist.gov/nvlap>.

Note:

- Alternative responses will be evaluated using the criteria listed above.
- Some licensees choose to provide personnel dosimetry to their workers for reasons other than compliance with NRC requirements (e.g., to respond to worker requests).

Reference: See the Notice of Availability on the inside front cover of this report to obtain copies of:

- Regulatory Guide 8.7, Revision 1, "Instructions for Recording and Reporting Occupational Radiation Exposure Data"

- Regulatory Guide 8.9, “Acceptable Concepts, Models, Equations, and Assumptions for a Bioassay Program”
- Regulatory Guide 8.20, “Applications of Bioassay for I-125 and I-131”
- Regulatory Guide 8.34, “Monitoring Criteria and Methods to Calculate Occupational Radiation Doses.”

8.10.5 PUBLIC DOSE

Regulations: 10 CFR 20.1301, 10 CFR 20.1302, 10 CFR 20.1801, 10 CFR 20.1802, 10 CFR 20.2107.

Criteria: Licensees must do the following:

- Ensure that licensed material will be used, transported, stored, and disposed of in such a way that members of the public will not receive more than 1 mSv (100 mrem) in one year, and the dose in any unrestricted area will not exceed 0.02 mSv (2 mrem) in any one hour, from licensed operations.
- Control/maintain constant surveillance of licensed material when in use and not in storage.
- Secure stored licensed material from access, removal, or use by unauthorized personnel.

Discussion: “Public dose” is defined in 10 CFR Part 20 as “the dose received by a member of the public from exposure to radiation and/or radioactive material released by a licensee, or to any other source of radiation under the control of a licensee.” Public dose excludes doses received from background radiation and from medical procedures. Whether the dose to an individual is an occupational dose or a public dose depends on the individual’s assigned duties and not on the area (restricted, controlled, or unrestricted) the individual is in when the dose is received.

For guidance about accepted methodologies for determining dose to members of public, please refer to Appendix M.

Members of the public include persons who work in or may occupy locations where licensed material is used or stored. Employees whose assigned duties do not include the use of licensed material and work in the vicinity where it is used or stored are also included as members of the public. Public dose is controlled, in part, by ensuring that licensed material is secured (e.g., located in a locked area) to prevent unauthorized access or use. Sealed and unsealed materials are usually restricted by controlling access to the keys needed to gain access to storage locations, including storage bunkers. Only the RSO or authorized user should have access to keys.

Public dose is also affected by the choice of storage and use locations at temporary job sites. Licensed material must be located so that the resulting public dose in an unrestricted area (e.g., an office or the exterior surface of an outside wall) does not exceed 1 mSv (100 mrem) in a year or 0.02 mSv (2 mrem) in any one hour. Applicants should use the concepts of controlling time, distance, and shielding when choosing storage and use locations. Decreasing the time that an

CONTENTS OF AN APPLICATION

individual is exposed, increasing the distance from the radioactive material, and adding shielding that is appropriate for the specific type of radiation (e.g., brick, concrete, lead, hydrogenous materials, etc.) will reduce the radiation exposure.

Information provided on anticipated radiation levels of sealed sources and unsealed materials both inside their respective transport containers and outside the transport container at given distances is the type of information needed to make public dose calculations. Licensees may assess radiation levels located in adjacent areas to radioactive material either by making calculations or by using a combination of direct measurements and calculations. After obtaining anticipated radiation levels or by making direct radiation measurements using an appropriate survey instrument an applicant can use the “inverse square” law to evaluate the effect on the public, and use this information to determine operating and emergency procedures for using radioactive materials. See Appendix M for an example demonstrating that individual members of the public will not receive doses exceeding the allowable public limits.

Figure 8.9 shows the steps to calculate the annual dose to an individual member of the public.

There are many possible internal dose pathways that contribute to the TEDE. The TEDE can, however, be broken down into three major dose pathway groups:

- Airborne radioactive material
- Waterborne radioactive material
- External radioactive exposure.

The licensee should review these major pathways and decide which are applicable to its operations.

If, after making an initial public dose evaluation, a licensee changes the conditions used for the evaluation (e.g., relocates radioactive material within a designated storage area, increases the amount of radioactive materials in storage, changes the frequency radioactive material is in use, or changes the occupancy of adjacent areas) the licensee must perform a new evaluation to ensure that the public dose limits are not exceeded and take corrective action, if required.

Licensees should design a monitoring program to ensure compliance with 10 CFR 20.1302(b). The extent and frequency of monitoring will depend upon each licensee’s specific needs.

Calculating the Annual Dose to an Individual Member of the Public

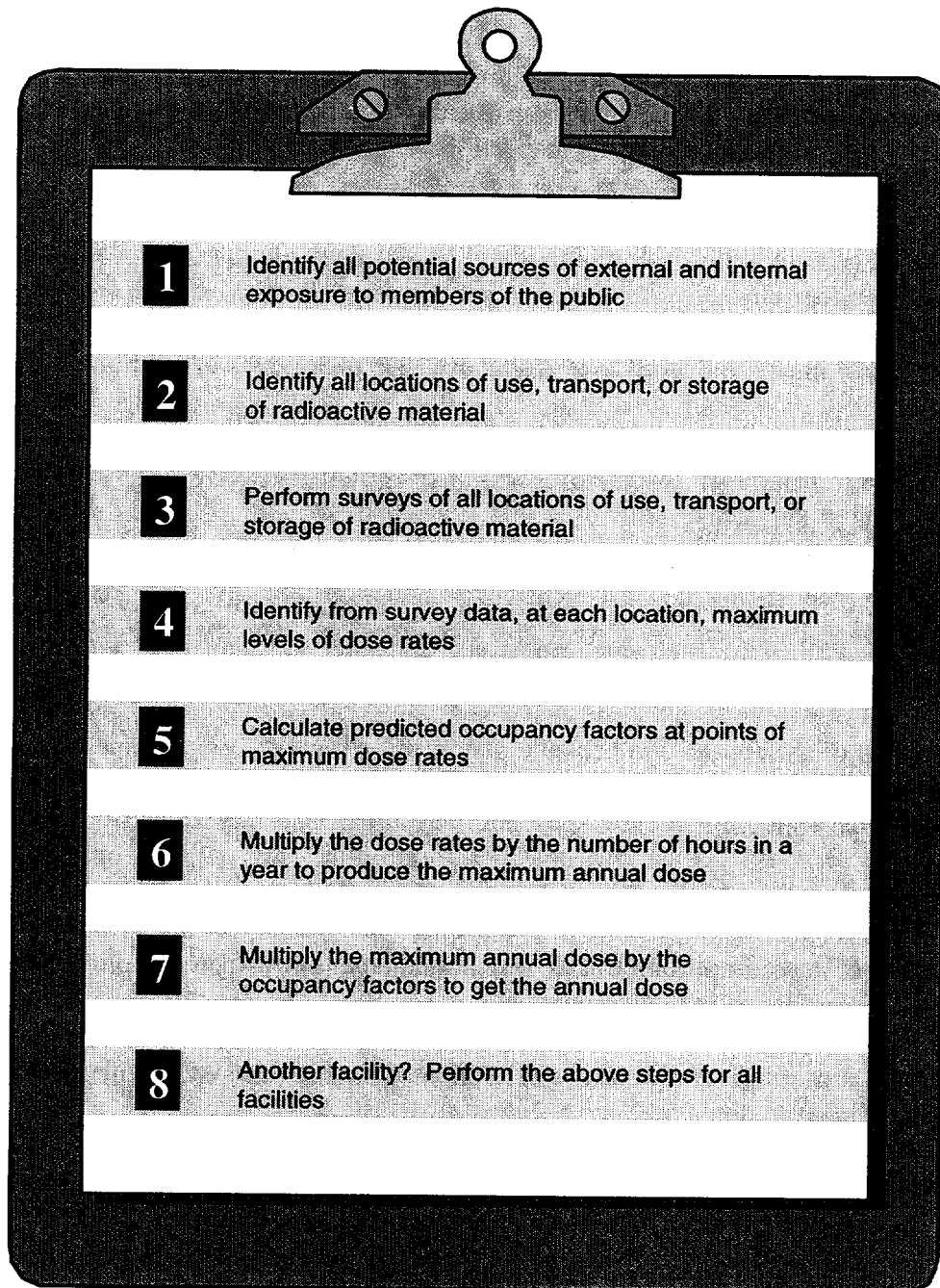

1556-012.ppt
041300

Figure 8.9 Calculating Public Dose. *Steps to calculate the annual dose to an individual member of the public (see Appendix M for more information about occupancy factors).*

CONTENTS OF AN APPLICATION

10 CFR 20.2107 requires that licensees maintain records sufficient to demonstrate compliance with the dose limits for members of the public until the Commission terminates the license. Refer to Appendix M for additional guidance regarding compliance with the record keeping requirements.

Response from Applicant: No response is required from the applicant in a license application, but compliance will be examined during inspection.

During NRC inspections, licensees must be able to provide documentation demonstrating, either by measurement, calculation, or a combination of both, that the total effective dose equivalent to any individual member of the public that is likely to receive the highest dose from licensed operations is less than 1 mSv (100 mrem) in one year, and any unrestricted area does not exceed 0.02 mSv (2 mrem) in any one hour. See Appendix M for examples of methods to demonstrate compliance.

8.10.6 SAFE USE OF RADIONUCLIDES AND EMERGENCY PROCEDURES

Regulations: 10 CFR 19.11(a)(3), 10 CFR 20.1101, 10 CFR 20.1801, 10 CFR 20.1802, 10 CFR 20.1902-1905, 10 CFR 20.2201-2203, 10 CFR 21.21, 10 CFR 30.32(i), 10 CFR 30.34(e), 10 CFR 30.50, 10 CFR 30.72.

Criteria: As part of the application package, the licensee must develop, implement, and maintain operating and emergency procedures or submit a summary of the procedures to the NRC. This summary should address the important radiation safety aspects of each procedure.

Discussion: The purpose of operating and emergency procedures is to provide personnel specific guidance for all operations they will perform. The operating and emergency procedures should include each topic important to safe operation and use considered applicable to the materials and uses proposed in the application.

Each licensee must develop, implement, and maintain operating and emergency procedures, which should include the items outlined below:

- Procedure for obtaining an agreement with customers outlining the responsibilities of both the customer and service provider, when performing service operations at a customer's facility
- Instructions for handling and using licensed materials
- Instructions for maintaining security during storage and transportation
- Instructions to keep licensed material under control and immediate surveillance during use
- Steps to take to keep radiation exposures ALARA
- Steps to maintain accountability during use

- Steps to control access to work sites
- Steps to take and whom to contact when an emergency occurs
- Instructions for using remote handling tools when handling sealed sources, except low-activity calibration sources
- Methods and occasions for conducting radiation surveys, including surveys for detecting contamination
- Procedures to minimize personnel exposure during routine use and in the event of an incident, including exposures from inhalation and ingestion of licensed unsealed materials
- Methods and occasions for locking and securing stored licensed materials
- Procedures for personnel monitoring, including bioassays, and the use of personnel monitoring equipment
- Procedures for transporting licensed materials to temporary job sites, packaging of licensed materials for transport in vehicles (private or common carrier), placarding of vehicles when needed, and physically securing licensed materials in transport vehicles during transportation to prevent accidental loss, tampering, or unauthorized removal
- Procedures for picking up, receiving, and opening packages containing licensed materials, in accordance with 10 CFR 20.1906
- Instructions for maintaining records in accordance with the regulations and the license conditions
- Procedures for identifying and reporting to NRC defects and noncompliance as required by 10 CFR 21.21(a) of this chapter
- Procedures and actions to be taken if a sealed source is ruptured, including actions to prevent the spread of contamination and minimize inhalation and ingestion of licensed materials and actions to obtain suitable radiation survey instruments
- Instructions for the proper storage and disposal of radioactive waste
- Procedures to be followed in the event of uncontrolled release of radioactive unsealed licensed material to the environment, including notification of the RSO, NRC, and other Federal and State agencies.
- Procedures for identifying and reporting to NRC defects and noncompliance, see Table 8.4 that describes the typical incident notifications required by NRC regulations.
- Procedures for the Implementation and adherence to good health physics practices while performing service operations
 - Minimization of distance to areas, to the extent practicable, where licensed materials are used and stored
 - Maximization of survey frequency, within reason, to enhance detection of contamination

CONTENTS OF AN APPLICATION

- Segregation of radioactive material in waste storage areas
- Segregation of sealed sources and tracer materials to prevent cross-contamination
- Separation of radioactive material from explosives
- Separation of potentially contaminated areas from clean areas by barriers or other controls.

Service providers who perform specific operations involving sealed sources such as inspection and maintenance of devices, and removal and replacement of sealed sources, should include appropriate procedures and instructions for these operations in the applicant's operating and emergency procedures;

OR

The licensee should provide a commitment to follow the manufacturer's procedures for inspection, maintenance, source exchange, and operations that involve access to the sealed source(s) and safety systems, if applicable.

Table 8.4 Typical NRC Incident Notifications Required for Service Provider Licensees

	Event Telephone Notification	Written Report	Regulatory Requirement
Theft or loss of material	immediate	30 days	10 CFR 20.2201(a)(1)(i)
Whole body dose greater than 0.25 Sv (25 rems)	immediate	30 days	10 CFR 20.2202(a)(1)(i)
Extremity dose greater than 2.5 Sv (250 rems)	immediate	30 days	10 CFR 20.2202(a)(1)(iii)
Whole body dose greater than 0.05 Sv (5 rems) in 24 hours	24 hours	30 days	10 CFR 20.2202(b)(1)(i)
Extremity dose greater than 0.5 Sv (50 rems) in 24 hours	24 hours	30 days	10 CFR 20.2202(b)(1)(iii)
Whole body dose greater than 0.05 Sv (5 rems)	none	30 days	10 CFR 20.2203(a)(2)(i)
Dose to individual member of public greater than 1 mSv (100 mrems)	none	30 days	10 CFR 20.2203(a)(2)(iv)
Defect in equipment that could create a substantial safety hazard	2 days	30 days	10 CFR 21.21(d)(3)(i)
Filing petition for bankruptcy under 11 U.S.C.	none	immediately after filing petition	10 CFR 30.34(h)
Expiration of license	none	60 days	10 CFR 30.36(d)
Decision to permanently cease licensed activities at entire site	none	60 days	10 CFR 30.36(d)

Event Telephone Notification Written Report Regulatory Requirement			
Decision to permanently cease licensed activities in any separate building or outdoor area that is unsuitable for release for unrestricted use	none	60 days	10 CFR 30.36(d)
No principal activities conducted for 24 months at the entire site	none	60 days	10 CFR 30.36(d)
No principal activities conducted for 24 months in any separate building or outdoor area that is unsuitable for release for unrestricted use	none	60 days	10 CFR 30.36(d)
Event that prevents immediate protective actions necessary to avoid exposure to radioactive materials that could exceed regulatory limits	immediate	30 days	10 CFR 30.50(a)
Equipment is disabled or fails to function as designed when required to prevent radiation exposure in excess of regulatory limits	24 hours	30 days	10 CFR 30.50(b)(2)
Unplanned fire or explosion that affects the integrity of any licensed material or device, container, or equipment with licensed material	24 hours	30 days	10 CFR 30.50(b)(4)

Note: Telephone notifications shall be made to the NRC Operations Center at 301-816-5100 or 301-951-0550.

Response from Applicant:

Applicant's should either submit its Operating and Emergency Procedures or an outline or summary in responding to subsequent sections.

8.10.7 SURVEYS

Regulations: 10 CFR 30.53, 10 CFR 20.1501, 10 CFR 20.2103.

Criteria: Licensees are required by 10 CFR 20.1501 to make surveys of potential radiological hazards in their workplace. Records of surveys and leak tests results must be maintained.

Discussion: Surveys are evaluations of radiological conditions and potential hazards (See Figure 8.10). These evaluations may be measurements (e.g., radiation levels measured with survey instrument or results of wipe tests for contamination), calculation, or a combination of measurements and calculations. The selection and proper use of appropriate instruments is one of the most important factors in ensuring that surveys accurately assess the radiological conditions. In order to meet regulatory requirements for surveying, measurements of radiological quantities should be understood in terms of their properties (i.e., alpha, beta, gamma) and compared to the appropriate limits.

CONTENTS OF AN APPLICATION

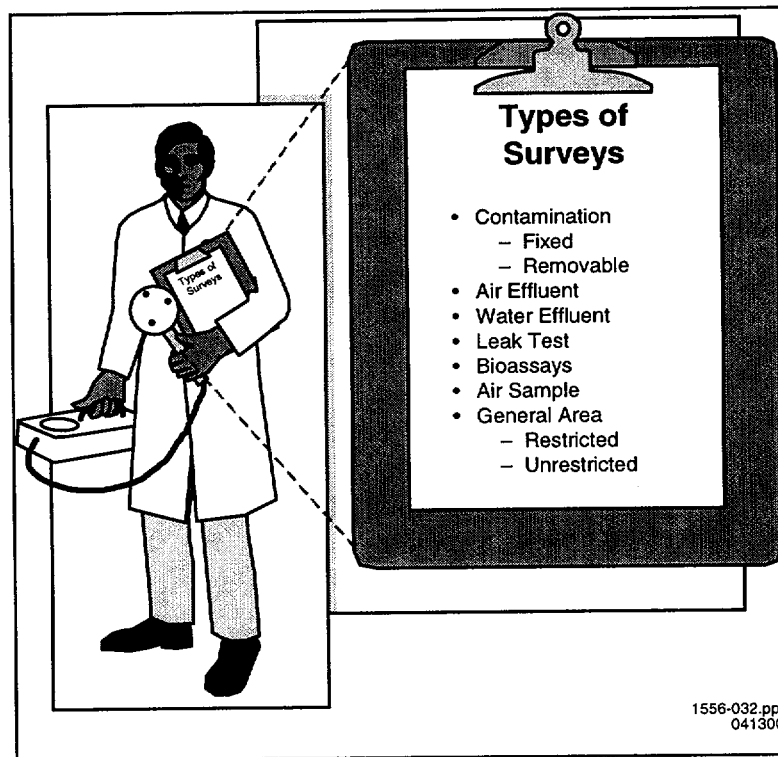

Figure 8.10 Types of Surveys.

Radiation surveys are used to detect and evaluate contamination of:

- Facilities
- Equipment
- Personnel (during use, transfer, or disposal of licensed material) (See Figure 8.11)
- Restricted and Unrestricted Areas.

Surveys are also used to plan work in areas where licensed material or radiation exists and to evaluate doses to workers and individual members of the public.

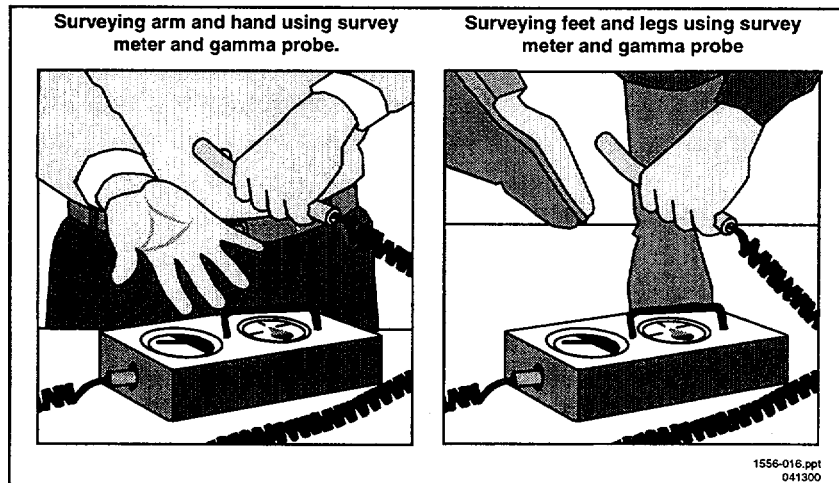

Figure 8.11 Personnel Surveys. *Users of unsealed licensed material should check themselves for contamination (frisk) before leaving the laboratory or any area with potential contamination.*

10 CFR 20.1501 states that surveys are required when it is reasonable under the circumstances to evaluate a radiological hazard and when necessary for the licensee to comply with the regulations. Many different types of surveys may need to be performed due to the particular use of licensed materials. The most important are as follows:

- Surveys for radioactive contamination that could be present on surfaces of floors, walls, laboratory furniture, and equipment.
- Measurements of radioactive material concentrations in air for areas where radioactive materials are handled or processed in unsealed form and where operations could expose workers to the inhalation of radioactive material or where licensed material is or could be released to unrestricted areas.
- Measurements of radioactive material concentrations in water that is released to the environment or to the sanitary sewer.
- Bioassays to determine the kinds, quantities or concentration, and in some cases, the location of radioactive material in the human body. A bioassay can be made by direct measurement (in vivo counting) or by analysis and evaluation of material excreted or removed from the human body.
- Surveys of external radiation exposure levels in both restricted and unrestricted areas.

Not all instruments can measure a given type of radiation. The presence of other radiation may interfere with a detector's ability to measure the radiation of interest. Correct use of radiation detection and measurements is an important aspect of any radiation safety program. Refer to Appendix J for a listing of the types of radiation survey instruments available.

Ambient survey and routine contamination survey frequencies depend on the quantity and use of radioactive materials, as well as the specific protective facilities, equipment, and procedures that

CONTENTS OF AN APPLICATION

are designed to protect the worker and members of the public from external exposure to radiation. NRC regulations do not provide specific limits for surface contamination in restricted areas, only that ALARA considerations must prevail. Each applicant should propose and justify fixed and removable surface contamination limits allowable in a work area before decontamination is required.

Contamination Survey Frequency

Personnel working with, in, or around unsealed forms of radioactive material should survey for contamination. Contamination surveys should be conducted at a frequency appropriate to the types and quantities of radioactive materials in use. If the activity used is greater than or equal to the smallest annual limit on intake (ALI) (for either inhalation or ingestion) as identified in 10 CFR Part 20, Appendix B, then documented surveys should be performed at least daily in accordance with 10 CFR 20.2103.

Table 8.5 contains suggested contamination survey frequencies based on ALIs. The suggested frequency of surveys is based upon the amount of licensed material "in use" at any one time at any particular location. If licensed material has not been used for a period of time greater than the required survey frequency, then it is considered to be "not in use."

Table 8.5 Suggested Contamination Survey Frequency

	< 0.1 ALI 0.1 ALI < 1.0 1.0 ALI		
In Use	Monthly	Weekly	Daily
Not in Use	Every 6 Months		

Contamination in Unrestricted Areas

Contamination found in unrestricted areas should be immediately decontaminated to background levels. When it is not possible to get to background levels, the licensee must ensure that the amounts do not exceed the contamination levels listed in Table 8.6.

Table 8.6 Acceptable Surface Contamination Levels for Equipment

Nuclide (a)	Average (b)(c)	Maximum (d)	Removable (e)
I-125, I-129	1.7 Bq*/100 cm ² (100 dpm/100 cm ²)	5.0 Bq/100 cm ² (300 dpm/100 cm ²)	0.3 Bq/100 cm ² (20 dpm/100 cm ²)
I-126, I-131, I-133, Sr-90	16.7 Bq/100 cm ² (1,000 dpm/100 cm ²)	50.0 Bq/100 cm ² (3,000 dpm/100 cm ²)	3.3 Bq/100 cm ² (200 dpm/100 cm ²)
Beta-gamma emitters (nuclides with decay modes other than alpha emission or spontaneous fission) except Sr-90 and others noted above	83.3 Bq*/100 cm ² (5,000 dpm/100 cm ²)	250 Bq/100 cm ² (15,000 dpm/100 cm ²)	16.7 Bq/100 cm ² (1,000 dpm/100 cm ²)

- (a) Where surface contamination by both alpha- and beta-gamma-emitting nuclides exists, the limits established for alpha- and beta-gamma-emitting nuclides should apply independently.
 - (b) As used in this table, dpm (disintegration per minute) means the rate of emission by radioactive material as determined by correcting the counts per minute observed by an appropriate detector for background, efficiency, and geometric factors associated with the instrumentation.
 - (c) Measurements of average contaminant should not be averaged over more than 1 square meter. For objects of less surface area, the average should be derived for each such object.
 - (d) The maximum contamination level applies to an area of not more than 100 cm².
 - (e) The amount of removable radioactive material per 100 cm² of surface area should be determined by wiping that area with filter or soft absorbent paper, applying moderate pressure, and assessing the amount of radioactive material on the wipe with an appropriate instrument of known efficiency. When removable contamination on objects of less surface area is determined, the pertinent levels should be reduced proportionally and the entire surface should be wiped.
- * 1 Bq = 1 Disintegration per second

When equipment or facilities that are potentially contaminated are to be released for unrestricted use, Table 8.6 provides the maximum acceptable residual levels for equipment. To the extent practicable, it is appropriate to decontaminate to below these levels. Surface contamination surveys should be conducted for both removable and fixed contamination before equipment and facilities are released from restricted to unrestricted use, to ensure that they meet these limits.

A standardized method for smear testing of a relatively uniform area should be used to aid in comparing contamination at different times and places. A smear taken from an area of about 100 cm² is acceptable to indicate levels of removable contamination.

Survey Record Requirements

Each survey report should include the following:

- A diagram of the area surveyed
- A list of items and equipment surveyed
- Specific locations on the survey diagram where wipe test was taken

CONTENTS OF AN APPLICATION

- Ambient radiation levels with appropriate units
- Contamination levels with appropriate units
- Make and model number of instruments used
- Background levels
- Name of the person making the evaluation and recording the results and date.

Licensees should record contamination levels observed and procedures followed for incidents involving contamination of individuals. The record should include names of individuals involved, description of work activities, calculated dose, probable causes (including root causes), steps taken to reduce future incidents of contamination, times and dates, and the surveyor's signature.

Air Monitoring in the Workplace

Air sampling can be used to do the following:

- Determine whether the confinement of radioactive materials is effective
- Measure airborne radioactive material concentrations in the workplace
- Estimate worker intakes of radioactive material
- Determine posting requirements
- Determine what protective equipment and measures are appropriate
- Warn of significantly elevated levels of airborne radioactive materials.

Note: If bioassay measurements are used to determine worker doses of record, air sampling may be used to determine time of intake and to determine which workers should have bioassay measurements. The use of engineering controls and a good air sampling program may eliminate need for bioassays.

Refer to Regulatory Guide 8.25, Revision 1, "Air Sampling in the Workplace," dated June 1992 and NUREG-1400, "Air Sampling in the Workplace," dated September 1993 for further guidance on the air sampling.

Airborne Effluent Release Monitoring

When practicable, airborne radioactive effluents should be released from monitored release points (e.g., monitored stacks, discharges, vents) to provide accurate measurements to estimate public exposure. Licensees should verify the performance of effluent monitoring systems by regular calibration (at least annually) to ensure their reliability.

Regulatory Guide 4.20, "Constraints on Release of Airborne Radioactive Materials to the Environment for Licensees Other Than Power Reactors," dated December 1996, provides guidance on methods acceptable (calculation or COMPLY code) to NRC for compliance with the constraint on air emissions to the environment.

Regulatory Guide 8.37, "ALARA Levels for Effluents from Materials Facilities," dated July 1993, provides guidance on designing an acceptable program for establishing and maintaining ALARA levels for gaseous and liquid effluents at materials facilities.

For release points for which monitoring is not practicable, the licensee should estimate the magnitude of the unmonitored effluents. These unmonitored releases will occur anytime unsealed material is handled outside a fume hood or other device that will control the releases. The licensee should include these estimates when demonstrating compliance with dose limits and ALARA goals. Unmonitored releases may be estimated based on the quantity of material used in these areas or the number of procedures performed or other appropriate methods. The unmonitored effluents should not exceed 30% of the total estimated effluent releases or 10% of the permissible air effluent concentrations found on column 1 of Table 2 in 10 CFR Part 20, Appendix B, whichever is greater.

Effluent monitoring systems should be designed in accordance with ANSI N13.1 (1969), "Document to Sampling Airborne Radioactive Materials in Nuclear Facilities," and ANSI N42.18, "Specification and Performance of On-site Instrumentation for Continuously Monitoring Radioactive Effluents."

Liquid Effluent Release Monitoring

The licensee should evaluate the concentrations of radioactive material in water that is released to the environment and to the sanitary sewer. The licensee must show that these releases meet the limits in 10 CFR 20.1301 and 20.2003, respectively.

The topic of sanitary sewerage releases is more fully discussed in Appendix N.

Response from Applicant: Choose one of the following:

- State: "We will survey our facility and maintain contamination levels in accordance with the survey frequencies and contamination levels published in draft NUREG-1556, Vol. 18, 'Program-Specific Guidance About Service Provider Licenses,' dated May 2000."

OR

- Submit description of alternative method for demonstrating how to evaluate a radiological hazard.

Note: Alternative responses will be reviewed using the criteria listed above.

CONTENTS OF AN APPLICATION

References:

- Draft Regulatory Guide DG-4006, "Demonstrating Compliance with the Radiological Criteria for License Termination"
- Federal Register Notice, "Supplemental Information on the Implementation of the Final Rule on Radiological Criteria for License Termination," Volume 63, Number 222, Page 64132, dated November 18, 1998
- Regulatory Guide 4.20, "Constraints on Release of Airborne Radioactive Materials to the Environment for Licensees Other Than Power Reactors"
- Regulatory Guide 8.20, "Applications of Bioassay for I-125 and I-131"
- Regulatory Guide 8.25, Revision 1, "Air Sampling in the Workplace"
- Regulatory Guide 8.32, "Criteria for Establishing a Tritium Bioassay Program"
- Regulatory Guide 8.37, "ALARA Levels for Effluents from Materials Facilities"
- NUREG-1400, "Air Sampling in the Workplace"
- NUREG-1549, "Decision Methods for Dose Assessment to Comply With Radiological Criteria for License Termination"
- NUREG/CR-5512, Vol. #3, "Residual Radioactive Contamination From Decommissioning, Parameter Analysis"
- ANSI N13.1 (1969), "Document to Sampling Airborne Radioactive Materials in Nuclear Facilities"
- ANSI N42.18, "Specification and Performance of On-site Instrumentation for Continuously Monitoring Radioactive Effluents"
- NCRP Commentary No. 3, "Screening Techniques for Determining Compliance with Environmental Standards," published in January 1989 and the addendum published in October 1989.

8.10.8 LEAK TESTS

Regulations: 10 CFR 30.53.

Criteria: NRC requires testing of sealed sources containing greater than 3.7 MBq (100 micro curies) of beta/gamma or 0.37 MBq (10 micro curies) of alpha radioactive material in order to determine whether there is any radioactive leakage from sealed sources. Requirements for leak tests are based on the type of radiation escaping from the inner capsule. Records of test results must be maintained.

Discussion: Sealed sources and devices that are approved by NRC or an Agreement State and used according to the respective SSD Registration Certificate usually pose little risk of contamination. Leak tests performed at the frequency specified in the SSD Registration Certificate should identify leaking sources. Leaking sources must be immediately withdrawn from use and decontaminated, repaired, or disposed of according to NRC requirements. Other efforts to minimize radioactive waste do not apply to programs using only sealed sources and devices that have not leaked.

NRC licenses will require the performance of leak tests on sealed sources at intervals approved by the NRC or an Agreement State and specified in the SSD Registration Sheet. The measurement of the leak-test sample is a quantitative analysis requiring that instrumentation used to analyze the sample be capable of detecting 185 Becquerel (0.005 microcurie) of radioactivity.

Manufacturers, consultants, and other organizations may be authorized by NRC or an Agreement State to either perform the entire leak test sequence for other licensees or provide leak test kits to licensees. In the latter case, the licensee is expected to take the leak test sample according to the gauge manufacturer's and the kit supplier's instructions and return it to the kit supplier for evaluation and reporting results. Licensees may also be authorized to conduct the entire leak test sequence themselves.

If you will be providing leak tests as a service to others, you may wish to distribute commercial leak test kits.

Leak test kits should contain:

- Swabs, wipes, absorbent-tipped sticks, etc., that are to be used to make the wipes on the specified sources or devices
- Envelopes, vials, etc., where wipe sample will be placed after sample has been taken
- Step-by-step instructions for safe use of the particular kit (these instructions will be specific to the types of devices/sealed sources that the kit is designed)
- Procedures for returning the wipes to you for analysis
- Label for the customer to fill out that identifies:
 - customer's name
 - license number
 - source or device (by manufacturer, model number, nuclide and activity) wiped, and
 - the name of the individual who made the wipes.

CONTENTS OF AN APPLICATION

Response from Applicant: Do either of the following:

- State: “Leak tests, when required by the license will be performed at intervals approved by the NRC or an Agreement State and specified in the Sealed Source and Device Registration Sheet. Leak tests will be performed by an organization authorized by NRC or an Agreement State to provide leak testing services to other licensees or using a leak test kit supplied by an organization authorized by NRC or an Agreement State to provide leak test kits to other licensees and according to the kit supplier’s instructions.”

OR

- State: “Leak testing will follow the model procedures in Appendix O.”

OR

- State: “Leak testing procedures and analysis will be done by the applicant.” Provide the information in supporting a request to perform leak testing. Appendix O may serve as guidance.

In addition, if you will distribute leak test kits to customers, either:

- State: “We will provide leak test kits as described in the model leak test kit description in Section 8.09.8 of draft NUREG-1556, Vol. 18.”

OR

- Provide a sample of the kits that will be distributed for each type of sealed source/device combination for which you will provide analysis.

Note: Requests for authorization to perform leak testing and sample analysis will be reviewed on a case-by-case basis and, if approved, NRC staff will authorize via a license condition. Alternative procedures submitted by the applicant will be evaluated against Appendix O criteria.

References: Draft Regulatory Guide FC 412-4, “Guide for the Preparation of Applications for the Use of Radioactive Materials in Leak-Testing Services,” is available from NRC upon request.

8.10.9 MAINTENANCE

Regulations: 10 CFR 20.1101, 10 CFR 30.34(e).

Criteria: This section applies to individuals who perform maintenance on their own licensed devices. Service providers who perform maintenance as a commercial service to other licensees should refer to Section 8.10.8, “Leak Tests.” Licensees must maintain devices (e.g., survey instrument calibrators, self-shielded irradiators, etc.) according to the manufacturer’s written recommendations and instructions; see Figure 8.12.

“Routine maintenance” of the device includes, but is not limited to, cleaning, lubrication, changing batteries, relays or fuses. “Non-routine maintenance” is the repair, removal, replacement, or alteration involving activities during which personnel could receive radiation doses exceeding NRC limits. These activities could include maintenance on electrical and mechanical systems that directly control source or shielding movement, the device’s shielding or sealed source, safety interlocks, any component that may affect safe operation of the device, or any other Non-routine maintenance must be performed by the device manufacturer (or distributor) or a person specifically licensed by NRC or an Agreement State; see Figure 8.12.

Discussion: Before any maintenance or repair work is done on your licensed devices, you need to ensure that you:

- Are specifically authorized by your license to perform the activity;
- Follow the manufacturer’s procedures describing the activity;
- Have individuals qualified by their training and experience to perform the activity;
- Use approved parts and components;
- Have specialized equipment to perform these activities;
- Test the device before it is returned to routine use to ensure that it functions as designed.
- Test the device before it is returned to routine use to ensure that it functions as designed.

The NRC license will require that non-routine maintenance be performed only by the manufacturer (or distributor) or other persons specifically licensed by the Commission or an Agreement State to perform such services. Applicants seeking authorization to perform non-routine maintenance must submit specific procedures for review. See Appendix P for more information.

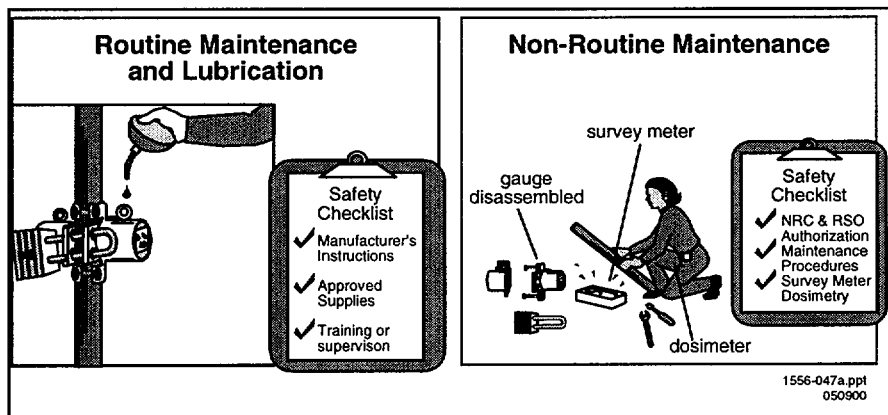

Figure 8.12 Routine Maintenance and Lubrication. *To ensure proper operation of the unit, licensees need to perform routine maintenance according to the manufacturer’s (or distributor’s) written instructions and recommendations.*

CONTENTS OF AN APPLICATION

Response from Applicant:

For performance of routine maintenance, submit either of the following:

- The statement: “We will implement and maintain procedures for routine maintenance of our device according to each manufacturer’s (or distributor’s) written recommendations and instructions.”

OR

- Alternative procedures for NRC’s review.

For performance of non-routine maintenance, submit either of the following:

- The statement: “We will have the device manufacturer (or distributor) or other person authorized by NRC or an Agreement State perform non-routine maintenance.”

OR

- The information listed in Appendix P supporting a request for authorization to perform this work.

Note: Alternative procedures submitted by the applicant for performing routine maintenance will be reviewed using the criteria in Appendix P.

Information requested in Appendix P will be reviewed on a case-by-case basis; if approved, the license will contain a specific condition authorizing the licensee to perform non-routine maintenance.

References: INs are available in the “Reference Library” on NRC’s Home Page at <<http://www.nrc.gov>>. For hard copies, see the Notice of Availability (on the inside front cover of this report).

8.10.10 MINIMIZATION OF CONTAMINATION

Regulations: 10 CFR 20.1406.

Criteria: Applicants must describe how facility design and procedures for operation will minimize, to the extent practicable, contamination of the facility and the environment, facilitate eventual decommissioning, and minimize, to the extent practicable, the generation of radioactive waste.

Discussion: When designing facilities and developing procedures for their safe use, applicants should think ahead and consider how to minimize radioactive contamination during operation, decontamination and decommissioning efforts, and radioactive waste generation. When submitting new applications, applicants should consider the following:

- Implementation of and adherence to good health physics practices in operations
- Minimization of areas, to the extent practicable, where licensed materials are used and stored
- Maximization of the frequency of surveys, within reason, to minimize spread of contamination
- Appropriate filtration of effluent streams
- Use of non-porous materials for laboratory bench tops, flooring, etc.
- Ventilation stacks and duct work with minimal lengths and minimal abrupt changes in direction
- Use of appropriate plumbing materials with minimal pipe lengths and traps
- Minimization of the number of disposal sites (sinks) where liquid waste is disposed.

Sealed sources and devices that are approved by NRC or an Agreement State and located and used according to their SSD Registration Certificates usually pose little risk of contamination. Leak tests performed as specified in the SSD Registration Certificate should identify defective sources. Leaking sources must be immediately withdrawn from use and decontaminated, repaired, or disposed of according to NRC requirements. These steps minimize the spread of contamination and reduce radioactive waste associated with decontamination efforts. Other efforts to minimize radioactive waste do not apply to programs using only sealed sources and devices that have not leaked.

Response from Applicant: The applicant does not need to provide a response to this item under the following condition. NRC will consider that the above criteria have been met if the applicant's responses meet the criteria in the following sections: "Radioactive Material - Unsealed and/or Sealed Sources," "Facilities and Equipment," "Radiation Safety Program - Safe use of Radioisotopes and Emergency Procedures," "Radiation Safety Program - Surveys," and "Radiation Safety Program - Waste Management."

8.10.11 TRANSPORTATION

Regulations: 10 CFR 20.1101, 10 CFR 30.41, 10 CFR 30.51, 10 CFR 71.5, 10 CFR 71.12, 10 CFR 71.13, 10 CFR 71.14, 10 CFR 71.37, 10 CFR 71.38, 10 CFR 71.47, Subpart H of 10 CFR Part 71, 49 CFR Parts 171-178.

Criteria: Applicants must develop, implement, and maintain safety programs for transport of radioactive material to ensure compliance with NRC and DOT regulations.

Discussion: The general license in 10 CFR 71.12 provides the authorization used by most licensees to transport, or offer for transport, packages of radioactive material and specifies certain conditions. Licensees should consider the safety of all individuals who may handle or may come into contact with the transport containers or packages containing licensed material. The primary consideration in packaging licensed material should be to ensure that the package

CONTENTS OF AN APPLICATION

integrity is not compromised during transport, and that the radiation levels or removable contamination levels at the package surfaces meet the regulatory requirements of 10 CFR 71.47. In all cases, ALARA concerns are addressed prior to, during, and after transporting any radioactive material.

Service provider personnel are authorized to prepare packages for shipment at customer facilities. Regardless of who prepares the package for shipment the shipper (i.e., the individual signing the Shipper's Certification on the shipping papers) is responsible for proper package preparation. If a service provider licensee becomes the shipper, the material will be transferred to the service provider's license. HAZMAT training (49 CFR 172, Subpart H-Training) is required for individuals that prepare packages for shipment.

Transporting licensed materials originating at certain facilities (e.g., irradiators) may involve quantities of radioactive material that require a Type B package that involve special requirements. In many cases, this material will be transferred to your license and you will act as the shipper. In these cases, you must ensure that you:

- Are authorized to possess the licensed material at temporary job sites (i.e., at the facility in question)
- Take possession of the licensed material and that it is transferred to you
- Use an approved Type B package
- Are registered with NRC as a user of the Type B package
- Have an NRC-approved QA plan.

For information about QA plans, see Revision 1 of Regulatory Guide 7.10, "Establishing Quality Assurance Programs for Packaging Used in the Transport of Radioactive Material," (dated June 1986). For further information about registering as a user of a package or submitting a QA program for review, contact NRC's Spent Fuel Project Office (SFPO) by calling NRC's toll-free number 800-368-5642 and asking for extension 415-8500. For information about associated fees, contact NRC's Office of the Controller by calling NRC's toll-free number 800-368-5642 and asking for extension 415-7554.

Note: Licensees shipping radioactive waste for disposal must prepare the shipment and its shipping manifest as required by 10 CFR Part 20, Appendix F.

During an inspection, NRC uses the provisions of 10 CFR 71.5 and a "Memorandum of Understanding with DOT on the Transportation of Radioactive Material" (signed June 6, 1979) to examine and enforce various DOT requirements. See Appendix Q for a Schedule Summary of the Principal Requirements for Transport of Specified Types of Radioactive Material Consignments.

Response from Applicant: No response is needed from applicants during the licensing phase. However, before making shipments of licensed materials in Type B packages, a licensee must

have registered with NRC as a user of the package and obtained NRC's approval of its QA program. Transportation issues will be reviewed during inspection.

References: "Radioactive Materials Regulations Review" can be obtained by calling DOT's Office of Hazardous Material Initiatives and Training at (202) 366-2301. See the Notice of Availability (on the inside front cover of this draft report) to obtain a copy of the "Memorandum of Understanding with DOT on the Transportation of Radioactive Material", the current version of Regulatory Guide 7.10, "Establishing Quality Assurance Programs for Packaging Used in the Transport of Radioactive Material," and NUREG-1660/ RAMREG-002, "U.S.-Specific Schedules of Requirements for Transport of Specified Types of Radioactive Material Consignments."

8.11 ITEM 11: WASTE MANAGEMENT

Regulations: 10 CFR 20.2001, 10 CFR 20.2002, 10 CFR 20.2003, 10 CFR 20.2004, 10 CFR 20.2005, 10 CFR 20.2006, 10 CFR 20.2007, 10 CFR 20.2108, 10 CFR 30.51.

Criteria: Radioactive waste must be managed and disposed of in accordance with regulatory requirements and license conditions. Appropriate records of waste disposal must be maintained.

Discussion: This section applies to service providers who generate radioactive waste as a result of services operations, but does not include licensees providing waste management services to customers. Waste management service may include, but is not limited to, commercial incineration, compaction, solidification/vitrification, and packaging, repackaging, and transportation of radioactive waste. Service providers who perform these activities as a service to other licensees should refer to Section 8.9.6, "Operating and Emergency Procedures."

Radioactive waste generated or handled when conducting licensed activities may include contaminated samples, sealed sources, and unusable items contaminated with radioactive material, e.g., absorbent paper, gloves, filters, tools, etc. You may also be called upon to package radioactive waste at customer facilities for disposal by the customer.

Service providers may not receive radioactive waste from other licensees for processing, storage or disposal, unless specifically authorized to do so by NRC. If customers wish to dispose of radioactive waste including sealed sources, service provider licensees may assist them only by transferring licensed material to any person authorized to possess these materials. Individuals authorized to possess materials include:

- The original manufacturer
- The distributor
- Commercial firms licensed by NRC or an Agreement State to accept radioactive waste from other persons, or another specific licensee authorized to possess the licensed material.

CONTENTS OF AN APPLICATION

All radioactive waste must be stored in appropriately labeled containers until it is disposed. During the period between storage and disposal container integrity must be assured. All radioactive waste must be secured against access or removal by unauthorized personnel. NRC regulations require that all licensees must dispose of radioactive waste as follows:

- Decay-in-storage (DIS)
- Release into sanitary sewerage
- Transfer to an authorized recipient
- Extended interim storage
- Obtaining prior approval from NRC of an alternate method
- Disposal of waste as if it were not radioactive (specific wastes)
- Release in effluents to unrestricted areas, other than into sanitary sewerage
- Incineration.

Additionally, radioactive waste management programs can include compaction, solidification/vitrification, and packaging, repackaging of radioactive waste.

With service provider licensees, NRC's experience is that most dispose of radioactive waste by transfer to an authorized recipients. Applicants requesting authorization to dispose of radioactive waste by incineration should refer to Policy and Guidance Directive PG 8-10, "Disposal of Incinerator Ash as Ordinary Waste," dated January 1997.

Note: Compliance with NRC regulations does not relieve a licensee for the responsibility of complying with any other applicable Federal, State, or local regulations. Furthermore, some radioactive waste called "mixed waste" may include additional hazards, (e.g., biohazard or chemical hazard). The storage and disposal of "mixed waste" must also comply with all other applicable Federal, State, and local regulatory requirements.

Applicants should describe their radioactive waste management program. This program should include procedures for handling and storing, characterization and minimization, and disposal of radioactive waste. The U.S. Environmental Protection Agency (EPA) issued guidance for development of a comprehensive program to reduce hazardous waste, including radioactive waste. NRC transmitted these guidelines to licensees in IN-94-23, "Guidance to Hazardous, Radioactive, and Mixed Waste Minimization Program," dated March 1994.

Disposal By Decay-in-storage (DIS)

NRC has concluded that materials with half-lives of less than or equal to 120 days may be disposed of by DIS. The minimum holding period for decay is ten half-lives of the longest-lived radioisotope in the waste. Such waste may be disposed of as ordinary trash if radiation surveys

(performed in a low background area and without any interposed shielding) of the waste at the end of the holding period indicate that radiation levels are indistinguishable from background. All radiation labels must be defaced or removed from containers and packages prior to disposal as ordinary trash. If the decayed waste is compacted, all labels that are visible in the compacted mass must also be defaced or removed.

Procedures for management of waste being held for DIS should include methods of segregation according to half life, surveys prior to disposal, and maintenance of records of disposal. Records should include the date when the waste was put in storage for decay, date when ten half-lives of the longest-lived radioisotope have transpired, date of disposal, and results of final survey before disposal as ordinary trash. Appendix N provides a model procedure for disposal of radioactive waste by DIS that incorporates the above guidelines.

Release Into Sanitary Sewerage

10 CFR 20.2003 authorizes disposal of radioactive waste by release into a public sanitary sewerage system if each of the following conditions is met:

- Material is readily soluble (or is easily dispersible biological material) in water
- Quantity of licensed material that the licensee releases into the sewer each month averaged over the monthly volume of water released into the sewer does not exceed the concentration specified in 10 CFR Part 20, Appendix B, Table 3
- If more than one radioisotope is released, the sum of the ratios of the average monthly discharge of a radioisotope to the corresponding limit in 10 CFR Part 20, Appendix B, Table 3 cannot exceed unity
- Total quantity of licensed material released into the sanitary sewerage system in a year does not exceed 185 GBq (5 Ci) of H-3, 37 GBq (1 Ci) of C-14, and 37 GBq (1 Ci) of all other radioisotopes combined.

Licensees are responsible to demonstrate that licensed materials discharged into the public sewerage system are indeed readily soluble in water. NRC IN 94-07, "Solubility Criteria for Liquid Effluent Releases to Sanitary Sewerage Under the Revised 10 CFR 20," dated January 1994, provides acceptable criteria for evaluating solubility of liquid waste. Liquid scintillation media and ash are examples of material that may or may not be "readily dispersible." Careful consideration should be given to the possibility of reconcentration of radioisotopes that are released into the sewer. NRC alerted licensees to the potentially significant problem of reconcentration of radionuclides released to sanitary sewerage systems in IN 84-94, "Reconcentration of Radionuclides Involving Discharges into Sanitary Sewerage Systems Permitted Under 10 CFR 20.203 (now 10 CFR 20.2003)," dated December 1984.

The regulations in 10 CFR 20.2003 are not applicable for releases to a private sewerage treatment system, a septic system, or leach fields. Licensees may make releases to these systems as effluents released to unrestricted areas pursuant to 10 CFR 20.1301. However, if licensed

CONTENTS OF AN APPLICATION

material is released to a private sewage treatment system, septic system, or leach field, the sludge or other solids from these systems may become contaminated with radioactive material. Such sludge may be required to be disposed of as radioactive waste, using one of the methods described in Section 8.11 of this document.

Applicants should provide procedures that will ensure that all releases of radioactive waste into the sanitary sewerage meet the criteria stated in 10 CFR 20.2003 and do not exceed the monthly and annual limits specified in regulations. Licensees are required to maintain accurate records of all releases of licensed material into the sanitary sewerage. A model program for disposal of radioactive waste via sanitary sewer is described in Appendix N.

Incineration

These guidelines apply to *noncommercial waste disposal*, i.e., incineration of a licensee's own waste. You do not need specific NRC approval in order to incinerate certain categories of radioactive waste. For example, 10 CFR 20.2005 provides that tritium and carbon-14 in low level concentrations in liquid scintillation media and animal tissue may be disposed of without regard to radioactivity. After you review your program and confirm that you have waste that requires specific NRC approval for incineration, a description of the following should be provided.

- Training and experience of the person who will be responsible for the on-site and day-to-day supervision of incinerator operations, if different from the RSO.
- Chemical and/or physical form of the waste.
- How the waste is segregated, packaged and labeled for transfer from the generation site to the incinerator.
- Methods for determining concentration of radioactivity averaged over the weight of the material to be incinerated (micro curies per gram of waste medium) for each isotope to be incinerated; and the total radioactivity of each isotope per burn. Describe procedures for ensuring that environmental release limits specified in 10 CFR 20 will not be exceeded and remains ALARA.
- Procedures for packaging, handling, securing and monitoring of waste to prevent contamination and/or unnecessary exposure to personnel or property.
- Method for measuring or estimating the concentration of radioactive material remaining in the ash residue.
- Procedures for collection, handling and disposal of the ash residue.
- Records that document receipts, incinerations, environmental releases of effluents, and disposals of ash generated in the incineration process that include the units that will be used in these records (e.g., uCi/ml).

- Characteristics of the site location and incinerator including: height of the stack, rated air flow (cubic feet per hour or similar units), proximity of the stack or other discharge to occupied areas (e.g., residences, school, hospital), and distance to the nearest air intake ducts of adjacent buildings. Describe any scrubbers, filters, or air cleaning equipment that is present.
- Methods for evaluating airborne and liquid concentration of radionuclides released from the stack, scrubbers, condensers, and associated systems.
- Radiation safety procedures for monitoring personnel involved in incineration operations, and for monitoring all effluent generated by the incineration process. The procedures must ensure that regulatory limits for environmental releases of radioactivity will not be exceeded. The applicant must describe the disposal method for any ash generated that exceeds regulatory limits.
- Written commitment that the applicant has coordinated with appropriate state and local authorities and that such permits and other authorizations as may be necessary have been obtained.

Note: Incinerators must also be authorized by other federal, state and local authorities to operate

Model Procedure for Compaction

The following information should be provided from licensees who propose to compact waste. These guidelines apply to noncommercial compaction, i.e., compaction of a licensee's own waste. A description of the following should be provided.

- Describe the type, quantities, and concentrations of waste to be compacted.
- The compaction system that demonstrates that it is adequately designed and manufactured to safely compact the type and quantity of waste generated during licensed operations (e.g., manufacturer's specifications, annotated sketches, photographs, etc.) Identify the location of the compactor(s) within the waste processing area(s) as well as a description of the ventilation and filtering systems used in conjunction with the compactors. Include a description of the procedures for monitoring filter blockage and exchange.
- An analysis of the potential for airborne release of radioactive material during compaction activities.
- Methods used to monitor and control exposure to airborne radioactive material and contamination.
- The instruction provided to compactor operators including instructions for protective clothing, checks for proper functioning of equipment, method of handling uncompact waste and examining containers for defects.

Transfer to an Authorized Recipient

When transferring radioactive waste, it is the licensee's responsibility to verify that the intended recipient is authorized to receive the radioactive waste prior to making any shipment. The radioactive waste must be packaged in approved containers for shipment, and each container must identify the radioisotopes and the amounts contained in the waste. Additionally, packages must comply with the requirements of the particular burial site's license and state requirements. Each shipment must comply with all applicable NRC and DOT requirements. In some cases, the waste handling contractor may provide guidance to the licensee for packaging and transportation requirements; however, the licensee is ultimately responsible for ensuring compliance with all applicable regulatory requirements.

The shipper must provide all information required in NRC's Uniform Low-Level Radioactive Waste Manifest, and transfer this recorded manifest information to the intended recipient in accordance with 10 CFR Part 20, Appendix G. Each shipment manifest must include a certification by the waste generator, as specified in Section II of the appendix. Each person involved in the transfer for disposal and disposal of waste, including waste generator, waste collector, waste processor, and disposal facility operator, must comply with requirements specified in Section III of Appendix G.

Licensees should implement procedures to reduce the volume of radioactive waste for final disposal in an authorized low-level radioactive waste (LLW) disposal facility. These procedures include volume reduction by segregating, consolidating, compacting, or allowing certain waste to decay in storage. Waste compaction or other treatments can reduce the volume of radioactive waste, but such processes may pose additional radiological hazards (e.g., airborne radioactivity) to workers and members of the public. The program should include adequate safety procedures to protect workers, members of the public, and the environment.

Applicants should preplan the disposal because of the difficulties and costs associated with disposal of sealed sources. Applicants may want to consider contractual arrangements with the source supplier as part of a purchase agreement.

Disposal of Specific Waste As If It Were Not Radioactive

The following radioactive wastes may be disposed of as non-radioactive waste:

- Liquid scintillation media (including vials and other items contaminated with liquid scintillation media) containing no more than 1.85 kBq (0.05 mCi) of H-3 or C-14 per gram of the medium; and
- Animal carcasses or animal tissue containing no more than 1.85 kBq (0.05 mCi) of H-3 or C-14 per gram averaged over the weight of the entire animal.

Applicants should have procedures that will ensure that the above limits are not exceeded and that the disposal of animal tissue or carcasses containing licensed material is in a manner that will not permit their use either as food for humans or animals. Applicants must maintain accurate records of these disposals.

Alternate Methods

Applicants may also request alternate methods for the disposal of radioactive waste generated at their facilities. Such requests must describe the waste containing licensed material, including the physical and chemical properties that may be important to assess risks associated with the waste, and the proposed manner and conditions of waste disposal. Additionally, the applicant must submit its analysis and evaluation of pertinent information on the nature of the environment, nature and location of other affected facilities, and procedures to ensure that radiation doses are maintained ALARA and within regulatory limits.

Extended Interim Storage

Some licensees do not have an LLW disposal facility available to them and therefore must use on-site interim storage until such time that a facility becomes available. Licensees should exhaust all possible alternatives for disposal of radioactive waste and rely upon on-site extended interim storage of radioactive waste only as a last resort. The protection of workers and the public is enhanced by disposal rather than storage of waste. Licensees may also find it more economical to dispose of radioactive waste than to store it on-site because as the available capacity decreases, the cost of disposal of radioactive waste may continue to increase. Other than DIS, LLW should be stored only when disposal capacity is unavailable and for no longer than is necessary. NRC IN 90-09, "Extended Interim Storage of Low-Level Radioactive Waste by Fuel Cycle and Materials Licensees," dated February 1990, provides guidance to licensees for requesting an amendment to authorize extended interim storage of LLW.

Response from Applicant:

A statement that: "We will use the model waste procedures published in Appendix N to draft NUREG-1556, Vol. 18, 'Consolidated Guidance About Materials Licenses: Program Specific Guidance About Service Provider Licenses,' dated May 2000."

OR

If the applicant wishes to use only selected model procedures, provide a statement that "We will use the (specify either (1) Decay-In-Storage, or (2) Disposal of Liquids Into Sanitary Sewerage) model waste procedures that are published in Appendix N to draft NUREG-1556, Vol. 18, 'Consolidated Guidance About Materials Licenses: Program Specific Guidance About Service Provider Licenses,' dated May 2000."

OR

CONTENTS OF AN APPLICATION

Provide procedures for waste management by any of the methods described in this section. Applicants should contact appropriate Regional Office of the NRC for guidance to obtain approval of any method(s) of waste disposal other than those discussed in this section.

OR

If access to a radioactive waste burial site is unavailable, the applicant should request authorization for extended interim storage of waste. Applicant should refer to NRC IN 90-09, "Extended Interim Storage of Low-Level Radioactive Waste by Fuel Cycle and Materials Licensees," dated February 1990, for guidance and submit the required information with the application.

Alternative responses will be reviewed using the criteria listed above.

References: See the Notice of Availability on the inside front cover of this draft report to obtain copies of:

- Information Notice 94-23, "Guidance to Hazardous, Radioactive, and Mixed Waste Minimization Program," dated March 1994
- Information Notice 94-07, "Solubility Criteria for Liquid Effluent Releases to Sanitary Sewerage Under the Revised 10 CFR 20," dated January 1994
- Information Notice 84-94, "Reconcentration of Radionuclides Involving Discharges into Sanitary Sewerage Systems Permitted Under 10 CFR 20.203 (now 10 CFR 20.2003)," dated December 1984
- Information Notice 90-09, "Extended Interim Storage of Low-Level Radioactive Waste by Fuel Cycle and Materials Licensees," dated February 1990

Information Notices are available at <<http://www.nrc.gov>>.

8.12 ITEM 12: FEES

The next two items on NRC Form 313 are to be completed on the form itself.

On NRC Form 313, enter the appropriate fee category from 10 CFR 170.31 and the amount of the fee enclosed with the application.

Note: Applicants who wish to perform service operations (e.g., licensees that will repackage radioactive wastes) that require an environmental assessment should review 10 CFR Part 51 (particularly 10 CFR 51.30, 51.60, and 51.66) for further information concerning the environmental information needed by the NRC to prepare an environmental assessment. Environmental assessments are full-cost recovery items under 10 CFR Part 170. Full cost will be determined based on the professional staff time and appropriate staff time expended as described in footnote e.3. to 10 CFR 170.31.

Note: 10 CFR 51.22 (c)(14)(xii) grants a categorical exclusion for the acceptance of packaged radioactive wastes from others for transfer to licensed land burial facilities provided the interim storage period for any package does not exceed 180 days and the total possession limit for all packages held in interim storage at the same time does not exceed 50 curies.

8.13 ITEM 13: CERTIFICATION

Individuals acting in a private capacity are required to date and sign NRC Form 313. Otherwise, representatives of the corporation or legal entity filing the application should date and sign NRC Form 313. Representatives signing an application must be authorized to make binding commitments and to sign official documents on behalf of the applicant. As discussed previously in "Management Responsibility," signing the application acknowledges management's commitment and responsibilities for the radiation protection program. NRC will return all unsigned applications for proper signature.

Note:

- It is a criminal offense to make a willful false statement or representation on applications or correspondence (18 U.S.C. 1001).
- When the application references commitments, those items become part of the licensing conditions and regulatory requirements.

9 AMENDMENTS AND RENEWALS TO A LICENSE

It is the licensee's obligation to keep the license current. If any of the information provided in the original application is to be modified or changed, the licensee must submit an application for a license amendment before the change takes place. Also, to continue the license after its expiration date, the licensee must submit an application for a license renewal at least 30 days before the expiration date (10 CFR 2.109, 10 CFR 30.36(a)).

Applications for license amendment, in addition to the following, must provide the appropriate fee. For renewal and amendment requests applicants must do the following:

- Be sure to use the most recent guidance in preparing an amendment or renewal request.
- Submit in duplicate, either an NRC Form 313 or a letter requesting amendment or renewal.
- Provide the license number.
- For renewals, provide a complete and up-to-date application if many outdated documents are referenced or there have been significant changes in regulatory requirements, NRC's guidance, the licensee's organization, or radiation protection program. Alternatively, describe clearly the exact nature of the changes, additions, and deletions.

Note: Using the suggested wording of responses and committing to using the model procedures in this draft report will expedite NRC's review.

10 APPLICATIONS FOR EXEMPTIONS

Regulations: 10 CFR 19.31, 10 CFR 20.2301, 10 CFR 30.11.

The regulations state that NRC may grant an exemption, acting on its own initiative or on an application from and interested person. Key considerations are whether the exemption is authorized by law, will endanger life or property or the common defense and security, and is otherwise in the public interest.

Until NRC has granted an exemption in writing, NRC expects strict compliance with all applicable regulations.

Exemptions are not intended for large classes of licenses, and are generally limited to unique situation. Exemption requests must be accompanied by descriptions of the following:

- Exemption and why it is needed
- Proposed compensatory safety measures intended to provide a level of health and safety equivalent to the regulation for which the exemption is being requested
- Alternative methods for complying with the regulation and why they are not feasible.

11 TERMINATION OF ACTIVITIES

Regulations: 10 CFR 20.1401, 10 CFR 20.1402, 10 CFR 20.1403, 10 CFR 20.1404, 10 CFR 20.1405, 10 CFR 20.1406, 10 CFR 30.34(b), 10 CFR 30.35(g), 10 CFR 30.36(d), 10 CFR 30.36(g), 10 CFR 30.36(h), 10 CFR 30.36(j), 10 CFR 30.51(f), 10 CFR 40.42, and 10 CFR 70.38.

Criteria: Pursuant to the regulations described above, the licensee must do the following:

- Notify NRC, in writing, within 60 days of:
 - the expiration of its license
 - a decision to permanently cease licensed activities at the *entire site* (regardless of contamination levels)
 - a decision to permanently cease licensed activities in *any separate building or outdoor area*, if they contain residual radioactivity making them unsuitable for release according to NRC requirements
 - no principal activities having been conducted at the *entire site* under the license for a period of 24 months
 - no principal activities having not been conducted for a period of 24 months in *any separate building or outdoor area*, if they contain residual radioactivity making them unsuitable for release according to NRC requirements.
- Submit decommissioning plan, if required.
- Conduct decommissioning, as required by 10 CFR Part 30, 40, or 70.
- Submit, to the appropriate NRC Regional Office, completed NRC Form 314, “Certificate of Disposition of Materials” (or equivalent information) and a demonstration that the premises are suitable for release for unrestricted use (e.g., results of final survey).
- Before a license is terminated, send the records important to decommissioning to the appropriate NRC Regional Office. If licensed activities are transferred or assigned, make necessary transfer of records important to decommissioning to the new licensee.

Discussion: As discussed above in “Criteria,” before a licensee can decide whether it must notify NRC, the licensee must determine whether residual radioactivity is present and, if so, whether the levels make the building or outdoor area unsuitable for release according to NRC requirements. A licensee’s determination that a facility is not contaminated is subject to verification by NRC inspection.

The permanent cessation of principal activities in an individual room or laboratory may require the licensee to notify NRC if no other licensed activities are being performed in the building. This also applies to buildings that were approved by the broad scope licensee as locations of use but not specifically named on the broad scope license.

TERMINATION OF ACTIVITIES

Draft Regulatory Guide DG-4006, "Demonstrating Radiological Criteria For License Termination," issued July 8, 1998 and NUREG/BR-0241, "NMSS Handbook for Decommissioning Fuel Cycle and Materials Licenses," dated March 1997, contains the current regulatory guidance concerning decommissioning of facilities and termination of licenses. Appendix B of the Handbook contains a comprehensive list of NRC's decommissioning regulations and guidance. NUREG-1575, "Multi-Agency Radiation Survey and Site Investigation Manual (MARSSIM)," dated December 1997, should be reviewed by licensees who have large facilities to decommission. An acceptable screening computer code for calculating screening values to demonstrate compliance with the unrestricted dose limits is D and D, Version 1; this was issued on August 20, 1998. Supplemental information on the implementation of the final rule on radiological criteria for license termination was published in the Federal Register (Volume 63, Number 222, Page 64132-64134) on November 18, 1998. This includes the following acceptable license termination screening values of common radionuclides for building surface contamination.

Table 11.1 Acceptable License Termination Screening Values of Common Radionuclides for Building Surface Contamination

Radionuclide	Symbol	Acceptable Screening Levels*
hydrogen-3 (tritium)	H-3	1.2 x 10 ⁸
carbon-14	C-14	3.7 x 10 ⁶
sodium-22	Na-22	9.5 x 10 ³
sulfur -35	S-35	1.3 x 10 ⁷
chlorine-36	Cl-36	5.0 x 10 ⁵
manganese-54	Mn-54	3.2 x 10 ⁴
iron-55	Fe-55	4.5 x 10 ⁶
cobalt-60	Co-60	7.1 x 10 ³
nickel-63	Ni-63	1.8 x 10 ⁶
strontium-90	Sr-90	8.7 x 10 ⁶
technetium-99	Tc-99	1.3 x 10 ⁶
iodine-129	I-129	3.5 x 10 ⁴
cesium-137	Cs-137	2.8 x 10 ⁴
iridium-192	Ir-192	7.4 x 10 ⁴

* Screening levels are based on the assumption that the fraction of removable surface contamination is equal to 0.1. For cases when the fraction of removable contamination is undetermined or higher than 0.1, users may assume, for screening purposes, that 100% of surface contamination is removable; and therefore the screening levels should be decreased by a factor of 10. Alternatively, users having site-specific data on the fraction of removable contamination (e.g., within 10% to 100% range) may calculate site-specific screening levels using D and D Version 1, based on site-specific resuspension factor. For Unrestricted Release (dpm/100 cm²) Units are disintegrations per minute per 100 square centimeters (dpm/100 cm²). 1 dpm is equivalent to 0.0167 Bq. The screening values represent surface concentrations of individual radionuclides that would be deemed in compliance with the 0.25 mSv/yr (25 mrem/yr) unrestricted release dose limit in 10 CFR 20.1402. For radionuclides in a mixture, the "sum of fractions" rule applies; see 10 CFR Part 20, Appendix B, Note 4. Refer to NRC Draft Guidance DG-4006 for further information on application of the values in this table.

TERMINATION OF ACTIVITIES

Response from Applicant: The applicant is not required to submit a response to the NRC during the initial application. However, when the license expires or at the time the licensee ceases operations, then any necessary decommissioning activities must be undertaken, NRC Form 314 or equivalent information must be submitted, and other actions must be taken as summarized in the Criteria.

Reference: Copies of NRC Form 314, "Certificate of Disposition of Materials," are available upon request from NRC's Regional Offices. (See Figure 2.1 for addresses and telephone numbers).

Appendix A

List of Documents Considered in Development of this Draft NUREG

List of Documents Considered in Development of this Draft NUREG

This draft report incorporates and updates the guidance previously found in the NUREG reports, Regulatory Guides (RGs), Policy and Guidance Directives (P&GDs), and Information Notices (INs), listed below. Other NRC documents such as Manual Chapters (MCs), Inspection Procedures (IPs), Memoranda of Understanding (MOU) and Technical Assistance Requests (TARs) were also consulted during the preparation of this draft report. When this draft report is issued in final form, the documents marked with an asterisk (*) will be considered superseded and should not be used.

Table A.1 List of NUREG Reports, Regulatory Guides, and Policy and Guidance Directives

Document Identification	Title	Date
DRAFT WORKING PAPERS		
*AEC Draft Working Paper	Criteria and Requirements for Licensing Commercial Decontamination Laundries	12/11/69
DRAFT REGULATORY GUIDE		
*Draft Regulatory Guide DG 4006	Guide for the Applications for Demonstrating Compliance with the Radiological Criteria for License Termination	8/98
*Draft Regulatory Guide FC 411-4	Guide for the Applications for the Use of Radioactive Materials in Servicing Preregistered Gauges, Measuring Devices, and Sealed Sources Used in Such Devices	6/85
Draft Regulatory Guide FC 412-4	Guide for the Preparation of Applications for the Use of Radioactive Materials in Leak-Testing Services	6/85
Draft Regulatory Guide FC 413-4	Guide for the Preparation of Applications for Licenses for the Use of Radioactive Materials in Calibrating Radiation Survey and Monitoring Instruments	6/85
REGULATORY GUIDE		
Regulatory Guide (RG) 3.66	Standard Format and Content of Financial Assurance Mechanisms Required for Decommissioning Under 10 CFR Parts 30, 40, 70, and 72	6/90
Regulatory Guide (RG) 4.20	Constraints on Release of Airborne Radioactive Materials to the Environment for Licensees Other Than Power Reactors	6/90
Regulatory Guide (RG) 7.10, Rev.1	Establishing Quality Assurance Programs for Packaging Used in the Transport of Radioactive Material	6/86
Regulatory Guide (RG) 8.7, Rev.1	Instructions for Recording and Reporting Occupational Radiation Exposure Data	6/92

APPENDIX A

Document Identification	Title	Date
Regulatory Guide (RG) 8.9	Acceptable Concepts, Models, Equations, and Assumptions for a Bioassay Program	7/93
Regulatory Guide (RG) 10.8, Rev.2	Guide for the Preparation of Applications for Medical Use Programs	8/87
Regulatory Guide (RG) 8.25	Air Sampling in the Workplace	6/92
Regulatory Guide (RG) 8.32	Criteria for Establishing a Tritium Bioassay Program	7/88
Regulatory Guide (RG) 8.34	Monitoring Criteria and Methods to Calculate Occupational Radiation Doses	7/92
Regulatory Guide (RG) 8.37	ALARA Levels for Effluents from Materials Facilities	7/93
NUREG		
NUREG-1400	Air Sampling in the Workplace September 1993	9/93
NUREG 1460, Rev 1	Guide to NRC Reporting and Record keeping Requirements	7/94
NUREG-1507	Minimum Detectable Concentrations with Typical Radiation Survey Instruments for Various Contaminants and Field Conditions	6/98
NUREG-1539	Methodology and Findings of the NRC's Materials Licensing Process Redesign	4/96
NUREG-1541	Process and Design for Consolidating and Updating Materials Licensing Guidance	4/96
NUREG-1549	Decision Methods for Dose Assessment to Comply With Radiological Criteria for License Termination	7/98
NUREG-1556, Vol. 3	Consolidated Guidance About Materials Licenses: Applications for Sealed Source and Device Evaluation and Registration	7/98
NUREG-1556, Vol. 11	Program-Specific Guidance About Broad Scope Licenses	4/99
NUREG-1660/ RAMREG-002	U.S.-Specific Schedules of Requirements for Transport of Specified Types of Radioactive Material Consignments	11/98
NUREG/CR-5512, Vol. 3	Residual Radioactive Contamination From Decommissioning, Parameter Analysis	4/96

Document Identification	Title	Date
LETTERS		
SP-96-022	All Agreement States Letter	2/16/96
NCRP OR ICRP DOCUMENTS		
National Council on Radiation Protection and Measurements (NCRP) Report No. 49	Structural Shielding Design and Evaluation for Medical Use of X Rays and Gamma Rays of Energies Up to 10 MeV	9/76
NCRP Commentary No. 3	Screening Techniques for Determining Compliance with Environmental Standards," Addendum published in October 1989	1/89
ANSI DOCUMENTS		
ANSI N13.1	Sampling Airborne Radioactive Materials in Nuclear Facilities	1991
ANSI N323A-1997	Radiation Protection Instrumentation Test and Calibration.	1997
ANSI N42.18	Specification and Performance of On-site Instrumentation for Continuously Monitoring Radioactive Effluents	1991
OTHER DOCUMENTS		
	A Review of Department of Transportation Regulations for Transportation of Radioactive Materials (1983 revision)	
	The Health Physics & Radiological Health Handbook, Revised Edition, Edited by Bernard Shleien	1992
NIST Publication 810	National Voluntary Laboratory Accreditation Program, 1997 Directory	1997
Federal Register Notice	Supplemental Information on the Implementation of the Final Rule on Radiological Criteria for License Termination," Volume 63, Number 222, Page 64132	11/18/98
Memorandum of Understanding	Memorandum of Understanding with DOT on the Transportation of Radioactive Material	6/79
INFORMATION NOTICES		
IN 84-94	Reconcentration of Radionuclides Involving Discharges into Sanitary Sewerage Systems Permitted Under 10 CFR 20.203	12/84
IN 89-25 (Rev. 1)	Unauthorized Transfer of Ownership or Control of Licensed Activities	12/94

APPENDIX A

Document Identification	Title	Date
IN 90-09	Extended Interim Storage of Low-Level Radioactive Waste by Fuel Cycle and Material Licensees	2/90
IN 94-07	Solubility Criteria for Liquid Effluent Releases to Sanitary Sewage Under the Revised 10 CFR 20	2/94
IN 94-23	Guidance to Hazardous, Radioactive, and Mixed Waste Minimization Program	3/94
IN 96-28	Suggested Guidance Relating to Development and Implementation of Corrective Action	5/96
IN 97-30	Control of Licensed Material During Reorganizations, Employee-Management Disagreements and Financial Crises	6/97
POLICY GUIDANCE AND DIRECTIVES		
Policy and Guidance Directive FC 84-10	Disposal of Incinerator Ash as Ordinary Waste," dated January 1997.	1/97
Policy and Guidance Directive PG 8-11	NMSS Procedures for Reviewing Declarations of Bankruptcy	8/8/96
Revision 1, Policy and Guidance Directive FC 84-14	Standard Review Plan for Emergency Plans for Fuel Cycle and Materials Licensees	3/94
Revision 1, Supplement to Policy and Guidance Directive FC 84-20	Impact of Revision of 10 CFR Part 51 on Materials License Actions	3/94
Policy and Guidance Directive FC 90-2 (Rev. 1)	Standard Review Plan for Evaluating Compliance with Decommissioning Requirements	4/30/91
Policy and Guidance Directive FC 94-02	Licensing Site Remediation Contractors for Work at Temporary Job Sites	1/21/94
Policy and Guidance Directive FC 94-05	Updated Guidance on Decay-In-Storage	10/94
INSPECTION PROCEDURES		
Inspection	Inspection of Material Licensees Involved in an Incident or Bankruptcy Filing	2/97

Document Identification	Title	Date
Inspection Procedure (IP) 87110	Appendix A -Industrial/Academic/Research Inspection Field Notes Procedure (IP) 87103	1998

Appendix B

United States Nuclear Regulatory Commission Form 313

<p>NRC FORM 313 (5-1997) 10 CFR 30, 32, 33 34, 35, 36, 39 and 40</p>	<p>U. S. NUCLEAR REGULATORY COMMISSION</p>	<p>APPROVED BY OMB: NO. 3150-0120</p>	<p>EXPIRES: 7/31/1999</p>		
<p>APPLICATION FOR MATERIAL LICENSE</p>		<p>Estimated burden per response to comply with this information collection request: 7 hours. Submittal of the application is necessary to determine that the applicant is qualified and that adequate procedures exist to protect the public health and safety. Forward comments regarding burden estimate to the Information and Records Management Branch (T-6 F33), U.S. Nuclear Regulatory Commission, Washington, DC 20555-0001, and to the Paperwork Reduction Project (3150-0120), Office of Management and Budget, Washington, DC 20503. NRC may not conduct or sponsor, and a person is not required to respond to, an information collection unless it displays a currently valid OMB control number.</p>			
<p>INSTRUCTIONS: SEE THE APPROPRIATE LICENSE APPLICATION GUIDE FOR DETAILED INSTRUCTIONS FOR COMPLETING APPLICATION. SEND TWO COPIES OF THE ENTIRE COMPLETED APPLICATION TO THE NRC OFFICE SPECIFIED BELOW.</p>					
<p>APPLICATION FOR DISTRIBUTION OF EXEMPT PRODUCTS FILE APPLICATIONS WITH: DIVISION OF INDUSTRIAL AND MEDICAL NUCLEAR SAFETY OFFICE OF NUCLEAR MATERIALS SAFETY AND SAFEGUARDS U.S. NUCLEAR REGULATORY COMMISSION WASHINGTON, DC 20555-0001</p> <p>ALL OTHER PERSONS FILE APPLICATIONS AS FOLLOWS:</p> <p>IF YOU ARE LOCATED IN: CONNECTICUT, DELAWARE, DISTRICT OF COLUMBIA, MAINE, MARYLAND, MASSACHUSETTS, NEW HAMPSHIRE, NEW JERSEY, NEW YORK, PENNSYLVANIA, RHODE ISLAND, OR VERMONT, SEND APPLICATIONS TO:</p> <p>LICENSING ASSISTANT SECTION NUCLEAR MATERIALS SAFETY BRANCH U.S. NUCLEAR REGULATORY COMMISSION, REGION I 475 ALLENDALE ROAD KING OF PRUSSIA, PA 19406-1415</p> <p>ALABAMA, FLORIDA, GEORGIA, KENTUCKY, MISSISSIPPI, NORTH CAROLINA, PUERTO RICO, SOUTH CAROLINA, TENNESSEE, VIRGINIA, VIRGIN ISLANDS, OR WEST VIRGINIA, SEND APPLICATIONS TO:</p> <p>ATLANTA FEDERAL CENTER U. S. NUCLEAR REGULATORY COMMISSION, REGION II 61 FORSYTH STREET, S.W., SUITE 23T85 ATLANTA, GEORGIA 30303-3415</p>		<p>IF YOU ARE LOCATED IN: ILLINOIS, INDIANA, IOWA, MICHIGAN, MINNESOTA, MISSOURI, OHIO, OR WISCONSIN, SEND APPLICATIONS TO:</p> <p>MATERIALS LICENSING SECTION U.S. NUCLEAR REGULATORY COMMISSION, REGION III 801 WARRENVILLE RD. LISLE, IL 60532-4351</p> <p>ALASKA, ARIZONA, ARKANSAS, CALIFORNIA, COLORADO, HAWAII, IDAHO, KANSAS, LOUISIANA, MONTANA, NEBRASKA, NEVADA, NEW MEXICO, NORTH DAKOTA, OKLAHOMA, OREGON, PACIFIC TRUST TERRITORIES, SOUTH DAKOTA, TEXAS, UTAH, WASHINGTON, OR WYOMING, SEND APPLICATIONS TO:</p> <p>NUCLEAR MATERIALS LICENSING SECTION U.S. NUCLEAR REGULATORY COMMISSION, REGION IV 611 RYAN PLAZA DRIVE, SUITE 400 ARLINGTON, TX 76011-8064</p>			
<p>PERSONS LOCATED IN AGREEMENT STATES SEND APPLICATIONS TO THE U.S. NUCLEAR REGULATORY COMMISSION ONLY IF THEY WISH TO POSSESS AND USE LICENSED MATERIAL IN STATES SUBJECT TO U.S. NUCLEAR REGULATORY COMMISSION JURISDICTIONS.</p>					
<p>1. THIS IS AN APPLICATION FOR <i>(Check appropriate item)</i></p> <p><input type="checkbox"/> A. NEW LICENSE</p> <p><input type="checkbox"/> B. AMENDMENT TO LICENSE NUMBER _____</p> <p><input type="checkbox"/> C. RENEWAL OF LICENSE NUMBER _____</p>		<p>2. NAME AND MAILING ADDRESS OF APPLICANT <i>(Include Zip code)</i></p>			
<p>3. ADDRESS(ES) WHERE LICENSED MATERIAL WILL BE USED OR POSSESSED</p>		<p>4. NAME OF PERSON TO BE CONTACTED ABOUT THIS APPLICATION</p> <p>TELEPHONE NUMBER</p>			
<p>SUBMIT ITEMS 5 THROUGH 11 ON 8-1/2 X 11" PAPER. THE TYPE AND SCOPE OF INFORMATION TO BE PROVIDED IS DESCRIBED IN THE LICENSE APPLICATION GUIDE.</p>					
<p>5. RADIOACTIVE MATERIAL. a. Element and mass number; b. chemical and/or physical form; and c. maximum amount which will be possessed at any one time.</p>		<p>6. PURPOSE(S) FOR WHICH LICENSED MATERIAL WILL BE USED.</p>			
<p>7. INDIVIDUAL(S) RESPONSIBLE FOR RADIATION SAFETY PROGRAM AND THEIR TRAINING EXPERIENCE.</p>		<p>8. TRAINING FOR INDIVIDUALS WORKING IN OR FREQUENTING RESTRICTED AREAS.</p>			
<p>9. FACILITIES AND EQUIPMENT.</p>		<p>10. RADIATION SAFETY PROGRAM.</p>			
<p>11. WASTE MANAGEMENT.</p>		<p>12. LICENSEE FEES <i>(See 10 CFR 170 and Section 170.31)</i></p> <table border="1" style="width:100%; border-collapse: collapse;"> <tr> <td style="width:70%;">FEE CATEGORY</td> <td style="width:30%;">AMOUNT ENCLOSED \$</td> </tr> </table>		FEE CATEGORY	AMOUNT ENCLOSED \$
FEE CATEGORY	AMOUNT ENCLOSED \$				
<p>13. CERTIFICATION. <i>(Must be completed by applicant)</i> THE APPLICANT UNDERSTANDS THAT ALL STATEMENTS AND REPRESENTATIONS MADE IN THIS APPLICATION ARE BINDING UPON THE APPLICANT.</p> <p>THE APPLICANT AND ANY OFFICIAL EXECUTING THIS CERTIFICATION ON BEHALF OF THE APPLICANT, NAMED IN ITEM 2, CERTIFY THAT THIS APPLICATION IS PREPARED IN CONFORMITY WITH TITLE 10, CODE OF FEDERAL REGULATIONS, PARTS 30, 32, 33, 34, 35, 36, 39 AND 40, AND THAT ALL INFORMATION CONTAINED HEREIN IS TRUE AND CORRECT TO THE BEST OF THEIR KNOWLEDGE AND BELIEF.</p> <p>WARNING: 18 U.S.C. SECTION 1001 ACT OF JUNE 25, 1948 62 STAT. 749 MAKES IT A CRIMINAL OFFENSE TO MAKE A WILLFULLY FALSE STATEMENT OR REPRESENTATION TO ANY DEPARTMENT OR AGENCY OF THE UNITED STATES AS TO ANY MATTER WITHIN ITS JURISDICTION.</p>					
<p>CERTIFYING OFFICER - TYPED/PRINTED NAME AND TITLE</p>		<p>SIGNATURE</p>	<p>DATE</p>		
<p>FOR NRC USE ONLY</p>					
TYPE OF FEE	FEE LOG	FEE CATEGORY	AMOUNT RECEIVED	CHECK NUMBER	COMMENTS
			\$		
<p>APPROVED BY</p>				<p>DATE</p>	

Appendix C

Suggested Format for Providing Information Requested in Items 5 through 11 of NRC Form 313

Appendix C is designed to be used for all types of applicants requesting a service license. Because of the varied types of service applications it is necessary to make this Appendix sufficiently broad in scope to handle most applications. Services such as commercial nuclear laundries and waste management applicants may need to provide additional information once the necessary pre-licensing visit(s) are completed. Maintaining close coordination during the early licensing phase with the NRC licensing staff can be beneficial to both the NRC staff and applicant.

Using this Appendix successfully requires the applicant to do an initial review of the draft NUREG and preplan it answers. We suggest that applicants read the entire Appendix from beginning to end. The next step is to select the individual elements that apply to the individual types of service(s) requested. Highlight circle Item Nos or in some other way identify the areas that require specific information. Provide the information on the specific elements that you identified as requiring input for obtaining authorization for the requested services.

After selecting the applicable items that need to be addressed in Appendix C, refer to the corresponding sections in the draft NUREG. It is only necessary for applicants to provide the level of detail required for the individual types of service(s) requested in the application. Note, providing information for very limited licenses, e.g., leak test service provider, require less information than would be required for a commercial nuclear laundry or a waste management license. Service licenses requiring authorization for types and quantities of material specific for broad scope licenses should refer to NUREG 1556, Vol. 11, "Consolidated Guidance About Material Licenses: Program Specific Guidance About Licenses of Broad Scope," and NUREG 1556, Vol. 7, "Consolidated Guidance About Material Licenses: Program Specific Guidance About Academic, Research and Development, and Other Licenses of Limited Scope."

Item No.	Title and Criteria	Use Table Below	Description Attached
5	<p>RADIOACTIVE MATERIAL</p> <p>Sealed Sources and Devices</p> <ul style="list-style-type: none"> • Identify each radionuclide that will be used in each sealed source/device • Identify the manufacturer or distributor and model number of each sealed source/device • Confirm that each sealed source/device combination is listed and approved in the SSD registry for the purpose intended • Confirm that the activity per source/maximum activity per device specified in the SSD registration certificate will not be exceeded 	<p>[]</p> <p>[]</p> <p>[]</p> <p>[]</p>	<p>[]</p> <p>[]</p> <p>[]</p> <p>[]</p>

Sealed Sources				
Radioisotope	Manufacturer/ Model No.	Quantity	Yes	No
		Not to exceed the maximum activity per source/device as specified in the Sealed Source and Device Registration Sheet	<input type="checkbox"/>	<input type="checkbox"/>
		Not to exceed the maximum activity per source/device as specified in the Sealed Source and Device Registration Sheet	<input type="checkbox"/>	<input type="checkbox"/>
		Not to exceed the maximum activity per source/device as specified in the Sealed Source and Device Registration Sheet	<input type="checkbox"/>	<input type="checkbox"/>

Source Material	
<input type="checkbox"/> Depleted Uranium	_____ Kilograms
<input type="checkbox"/> Uranium-238	_____ Kilograms
<input type="checkbox"/> Thorium-232	_____ Kilograms
<input type="checkbox"/> Other: Specify	_____ Kilograms

Special Nuclear Material				
Radioisotope	Manufacturer/ Model No.	Quantity	Yes	No
<input type="checkbox"/> Uranium-234		Not to exceed the maximum activity per source/device as specified in the Sealed Source and Device Registration Sheet	<input type="checkbox"/>	<input type="checkbox"/>
<input type="checkbox"/> Uranium-235				
<input type="checkbox"/> Plutonium-238				
<input type="checkbox"/> Plutonium-239				
<input type="checkbox"/> Other: Specify				

Unsealed or Uncontained Materials

Identify each individual isotope requested:

Radioisotope	Chemical or Physical Form				Total Activity Requested
	<input type="checkbox"/> Gas	<input type="checkbox"/> Liquid	<input type="checkbox"/> Solid	<input type="checkbox"/> Other: Specify	
	<input type="checkbox"/> Gas	<input type="checkbox"/> Liquid	<input type="checkbox"/> Solid	<input type="checkbox"/> Other: Specify	
	<input type="checkbox"/> Gas	<input type="checkbox"/> Liquid	<input type="checkbox"/> Solid	<input type="checkbox"/> Other: Specify	
	<input type="checkbox"/> Gas	<input type="checkbox"/> Liquid	<input type="checkbox"/> Solid	<input type="checkbox"/> Other: Specify	

OR

Identify your request for Type B or Type C quantities of material by filling out the table below:

Radioisotope	Yes	No
<ul style="list-style-type: none"> Any radioisotope identified in 10 CFR 33.100, Schedule A, Column I— (Type B License of Broad Scope) 	[]	[]
OR		
<ul style="list-style-type: none"> Any radioisotope identified in 10 CFR 33.100, Schedule A, Column II— (Type C License of Broad Scope) 	[]	[]

AND IF APPLICABLE

Identify *individual isotopes* identified in 10 CFR 33.100 Schedule A, Column I or II, that requested quantities exceeding amounts authorized in Column I or II.

Radioisotope	Chemical or Physical Form				Total Activity Requested
	[] Gas	[] Liquid	[] Solid	[] Other: Specify	
	[] Gas	[] Liquid	[] Solid	[] Other: Specify	
	[] Gas	[] Liquid	[] Solid	[] Other: Specify	
	[] Gas	[] Liquid	[] Solid	[] Other: Specify	

AND

Identify any uncontained source or special nuclear materials that should be included in the license:

Source Material	
[] Depleted Uranium	_____ Kilograms
[] Uranium-238	_____ Grams
[] Thorium-232	_____ Grams
[] Other:	_____ Grams
Special Nuclear Material Less than Critical Mass Quantities	
[] Uranium-234	_____ Grams
[] Uranium-235	_____ Grams
[] Plutonium-238	_____ Grams
[] Plutonium-239	_____ Grams

APPENDIX C

For those individuals who will provide commercial services on sealed sources/devices and will be required to take possession of materials incident to providing services:

Sealed Sources/Devices Possessed Incident to Providing Services				
Radioisotope	Manufacturer/ Model No.	Quantity	Yes	No
		Not to exceed the maximum activity per source/device as specified in the Sealed Source and Device Registration Sheet	<input type="checkbox"/>	<input type="checkbox"/>
		Not to exceed the maximum activity per source/device as specified in the Sealed Source and Device Registration Sheet	<input type="checkbox"/>	<input type="checkbox"/>
Source Material				
<input type="checkbox"/> Uranium-238	_____	Kilograms		
<input type="checkbox"/> Thorium-232	_____	Grams		
<input type="checkbox"/> Other:	_____	Grams		
<input type="checkbox"/> Depleted Uranium	_____	Kilograms		
Special Nuclear Material Less than Critical Mass Quantities				
<input type="checkbox"/> Uranium-234	_____	Grams		
<input type="checkbox"/> Uranium-235	_____	Grams		
<input type="checkbox"/> Plutonium-238	_____	Grams		
<input type="checkbox"/> Plutonium-239	_____	Grams		

For those individuals who will provide commercial services involving unsealed or uncontained material and will be required to take possession of these materials incident to providing services:

Unsealed or Uncontained Materials

Identify each individual isotope requested:

Radioisotope	Chemical or Physical Form				Total Activity Requested
	<input type="checkbox"/> Gas	<input type="checkbox"/> Liquid	<input type="checkbox"/> Solid	<input type="checkbox"/> Other: Specify	
	<input type="checkbox"/> Gas	<input type="checkbox"/> Liquid	<input type="checkbox"/> Solid	<input type="checkbox"/> Other: Specify	
	<input type="checkbox"/> Gas	<input type="checkbox"/> Liquid	<input type="checkbox"/> Solid	<input type="checkbox"/> Other: Specify	
	<input type="checkbox"/> Gas	<input type="checkbox"/> Liquid	<input type="checkbox"/> Solid	<input type="checkbox"/> Other: Specify	

OR

Identify your request for Type B or Type C quantities of materials by filling out the table below:

Radioisotope	Yes	No
<ul style="list-style-type: none"> Any radioisotope identified in 10 CFR 33.100, Schedule A, Column I— (Type B License of Broad Scope) 	<input type="checkbox"/>	<input type="checkbox"/>
OR		
<ul style="list-style-type: none"> Any radioisotope identified in 10 CFR 33.100, Schedule A, Column II— (Type C License of Broad Scope) 	<input type="checkbox"/>	<input type="checkbox"/>

AND IF APPLICABLE

Identify *individual isotopes* identified in 10 CFR 33.100 Schedule A, Column I or II, that requested quantities exceeding amounts authorized in Column I or II.

Radioisotope	Chemical or Physical Form				Total Activity Requested
	<input type="checkbox"/> Gas	<input type="checkbox"/> Liquid	<input type="checkbox"/> Solid	<input type="checkbox"/> Other: Specify	
	<input type="checkbox"/> Gas	<input type="checkbox"/> Liquid	<input type="checkbox"/> Solid	<input type="checkbox"/> Other: Specify	
	<input type="checkbox"/> Gas	<input type="checkbox"/> Liquid	<input type="checkbox"/> Solid	<input type="checkbox"/> Other: Specify	
	<input type="checkbox"/> Gas	<input type="checkbox"/> Liquid	<input type="checkbox"/> Solid	<input type="checkbox"/> Other: Specify	

AND

Identify any uncontained source or special nuclear materials that should be included in the license:

Source Material	
<input type="checkbox"/> Depleted Uranium	_____ Kilograms
<input type="checkbox"/> Uranium-238	_____ Grams
<input type="checkbox"/> Thorium-232	_____ Grams
<input type="checkbox"/> Other:	_____ Grams
Special Nuclear Material	
<input type="checkbox"/> Uranium-234	_____ Grams
<input type="checkbox"/> Uranium-235	_____ Grams
<input type="checkbox"/> Plutonium-238	_____ Grams
<input type="checkbox"/> Plutonium-239	_____ Grams

APPENDIX C

Item No.	Title and Criteria	Yes	No	N/A	Description Attached
5	<p>RADIOACTIVE MATERIAL</p> <p>Financial Assurance and Record keeping For Decommissioning</p> <ul style="list-style-type: none"> • Pursuant to 10 CFR 30.35(g), we shall maintain drawings and records important to decommissioning and transfer these records to a new licensee before licensed activities are transferred, or assign the records to the appropriate NRC Regional office before the license is terminated. <p style="text-align: center;">OR</p> <ul style="list-style-type: none"> • If financial assurance is required, submit evidence. 	[]	[]		[]

Item No.	Title and Criteria	Yes	No	N/A	Description Attached
6	<p>PURPOSE(S) FOR WHICH LICENSED MATERIAL WILL BE USED</p> <ul style="list-style-type: none"> • Leak Test Analysis • Environmental Sample Analysis • Instrument/Dosimeter Calibration • Instruction <p>Possession Incident to Performing the Following Services on Sealed Sources and Devices</p> <ul style="list-style-type: none"> • Installation • Radiation Surveys • Removal • Disposal • Relocation • Repair • Source Exchange • Routine Maintenance • Nonroutine Maintenance • Source Retrieval • Transportation • Packaging • Leak Test Sample Acquisition • Customer Training • Other Services not identified above, excluding activities involving critical mass quantities of special nuclear material: Specify 	<input type="checkbox"/> <input type="checkbox"/> <input type="checkbox"/> <input type="checkbox"/>	<input type="checkbox"/> <input type="checkbox"/> <input type="checkbox"/> <input type="checkbox"/>	<input type="checkbox"/>	<input type="checkbox"/> <input type="checkbox"/> <input type="checkbox"/> <input type="checkbox"/> <input type="checkbox"/> <input type="checkbox"/> <input type="checkbox"/> <input type="checkbox"/> <input type="checkbox"/> <input type="checkbox"/> <input type="checkbox"/> <input type="checkbox"/> <input type="checkbox"/> <input type="checkbox"/> <input type="checkbox"/> <input type="checkbox"/> <input type="checkbox"/> <input type="checkbox"/>

APPENDIX C

Item No.	Title and Criteria	Yes	No	N/A	Description Attached
6	<p>PURPOSE(S) FOR WHICH LICENSED MATERIAL WILL BE USED (Cont'd)</p> <p>Possession Incident to Performing Commercial Services utilizing unsealed or uncontained licensed material:</p> <p>Nuclear Laundry</p> <p>Waste Management Services:</p> <ul style="list-style-type: none"> • Commercial Incineration • Commercial Compaction/Super Compaction • Commercial Solidification/Vitrification • Packaging, Repackaging, and Transportation of Radioactive Waste • Decontamination • Decommissioning • Site Characterization • Other Services not identified above, excluding activities involving critical mass quantities of special nuclear material: Specify 			<p><input type="checkbox"/></p> <p><input type="checkbox"/></p> <p><input type="checkbox"/></p> <p><input type="checkbox"/></p> <p><input type="checkbox"/></p> <p><input type="checkbox"/></p> <p><input type="checkbox"/></p> <p><input type="checkbox"/></p> <p><input type="checkbox"/></p>	<p><input type="checkbox"/></p> <p><input type="checkbox"/></p>

Item No.	Title and Criteria	Yes	No	N/A	Description Attached
7	<p>INDIVIDUAL(S) RESPONSIBLE FOR RADIATION SAFETY PROGRAM AND THEIR TRAINING EXPERIENCE</p> <p>Radiation Safety Officer</p> <p>The name of the proposed RSO:</p> <p style="text-align: center;">AND EITHER</p> <p>The specific training and experience of the RSO</p> <p style="text-align: center;">OR</p> <p>Alternative information demonstrating that the proposed RSO is qualified by training and experience, e.g., listed by name as an authorized user or the RSO on an NRC or Agreement State license that requires a radiation safety program of comparable size and scope.</p>				<p style="text-align: right;">[]</p> <p style="text-align: right;">[]</p>

APPENDIX C

Item No.	Title and Criteria	Yes	No	N/A	Description Attached
8	<p>TRAINING FOR INDIVIDUALS WORKING IN OR FREQUENTING RESTRICTED AREAS</p> <p>Authorized Users</p> <ul style="list-style-type: none"> • "Before using licensed material, authorized users will receive the training described in Appendix H in draft NUREG-1556, Vol. 18, 'Consolidated Guidance About Materials Licenses: Program Specific Guidance About Service Provider Licenses,' dated May 2000." <p style="text-align: center;">OR</p> <ul style="list-style-type: none"> • A description of the training and experience for proposed authorized users. <p>Ancillary Personnel</p> <ul style="list-style-type: none"> • "Before using licensed materials, ancillary personnel will have successfully completed the classroom training portion of the training course described in Appendix H in draft NUREG-1556, Vol. 18, 'Consolidated Guidance About Materials Licenses: Program Specific Guidance About Service Provider Licenses,' dated May 2000." <p style="text-align: center;">OR</p> <ul style="list-style-type: none"> • A description of the radiation safety training program, including topics covered, groups of workers, assessment of training, qualifications of instructors, and the method and frequency of training. 	[]	[]		[]
		[]	[]		[]

Item No.	Title and Criteria	Yes	No	N/A	Description Attached
9	<p>FACILITIES AND EQUIPMENT</p> <p>Permanent Facilities Specifically Identified on the License</p> <ul style="list-style-type: none"> • Leak Test and Environmental Sample Analysis Providers: No response required for facilities. (Equipment is discussed in Item 10, Radiation Safety Program.) • Instrument Calibration: If only sealed sources are possessed in registered devices designed to emit a collimated beam for the purpose of instrument calibration, no response required. (Equipment is discussed in Item 10, Radiation Safety Program.) • Services that involve handling of sealed sources in a shielded container: No response required. (Equipment is discussed in Item 10, Radiation Safety Program.) • Services that involve handling of sealed sources outside a shielded container: <ul style="list-style-type: none"> - Submit a drawing or sketch of the proposed permanent facility identifying areas where radioactive materials, including radioactive wastes, will be used or stored. - Show in the drawings the relationship and distance between restricted areas and adjacent unrestricted areas. - Specify in the drawings shielding materials (concrete, lead, etc.) and means for securing radioactive materials from unauthorized removal. - Drawings, sketches, diagrams, etc. should indicate the scale or include dimensions on each drawing or sketch. - Describe engineered safety systems, e.g., area monitors, interlocks, alarms, etc. 				
		No Response is Necessary for this Section			
		No Response is Necessary for this Section			
		No Response is Necessary for this Section			
		[]	[]		[] [] [] [] []

Item No.	Title and Criteria	Yes	No	N/A	Description Attached
9	<p>FACILITIES AND EQUIPMENT (Cont'd)</p> <p>Permanent Facilities Specifically Identified on the License Requesting the Use of Unsealed or Uncontained Material</p> <ul style="list-style-type: none"> • Leak Test and Environmental Sample Analysis Providers: No response required for facilities. (Equipment is discussed in Item 10, Radiation Safety program.) • Other services that involve handling of unsealed radioactive material at permanent facilities or field stations identified on the license: <ul style="list-style-type: none"> - Describe the permanent facilities and equipment to be made available at each location where unsealed radioactive material will be used or handled. - Include a description of the area(s) assigned for the receipt, storage, security, preparation, handling, waste storage and measurement of radioactive materials. - Submit a facility diagram showing the proximity of licensed materials to unrestricted areas. - Drawings, sketches, diagrams, etc. should indicate the scale, or include dimensions on each drawing or sketch. - Submit a diagram, sketch, or drawing, when applicable, that identifies areas where radioactive materials may become airborne. The diagram should contain descriptions of the ventilation systems, with pertinent airflow rates, filtration equipment, sample collection points, and monitoring systems. - Submit a diagram of radioactive waste handling equipment that includes incinerators, compactors, solidification equipment, hold-up tanks, sample collection points, etc. 	No Response is Necessary for this Section			
		[]	[]		
				[]	[]
				[]	[]
		[]	[]	[]	[]
				[]	[]
				[]	[]
				[]	[]
				[]	[]
				[]	[]

Item No.	Title and Criteria	Yes	No	N/A	Description Attached
9	<p>FACILITIES AND EQUIPMENT (Cont'd)</p> <p>Permanent Facilities Specifically Identified on the License Requesting the Use of Unsealed or Uncontained Material (Cont'd)</p> <ul style="list-style-type: none"> - Describe proposed laundry facilities, if applicable, used for contaminated protective equipment and clothing. Specify how the contaminated waste water from the laundry machines or sinks is disposed. Operating and emergency procedures should address decontamination of the laundry area and equipment. - Describe protective clothing (such as rubber gloves, coveralls, respirators, and face shields), auxiliary shielding, absorbent materials, secondary containers for waste water storage for decontamination purposes, plastic bags for storing contaminated items, etc., that will be available. - Specialized handling tools, facility interlocks designed to prevent operation of systems in the event that operation of the system could result in accidental exposure or release of material (e.g., HEPA filters, ventilation system, etc.) or equipment. <p>Temporary Job site Locations</p> <ul style="list-style-type: none"> • No facility description is required for use of materials at temporary job sites. 			<p style="text-align: center;">[]</p> <p style="text-align: center;">[]</p> <p style="text-align: center;">[]</p>	<p style="text-align: center;">[]</p> <p style="text-align: center;">[]</p> <p style="text-align: center;">[]</p>
		Need Not Be Submitted With Application			

APPENDIX C

Item No.	Title and Criteria	Yes	No	N/A	Description Attached
10	<p>RADIATION SAFETY PROGRAM</p> <p>The applicant is required to establish and submit its radiation protection program. Each item listed below should be addressed in the corresponding sections of this draft guide.</p> <ul style="list-style-type: none"> • Development and implementation of an ALARA program. • Description of equipment and facilities adequate to protect personnel, the public and the environment. • Confirmation that licensed activities are conducted only by individuals qualified by training and experience. • Development and maintenance of written operating and emergency procedures. • Implementation of an audit program to ensure that, at least annually, the radiation safety program is reviewed. • Description of organization structure and individuals responsible for ensuring day-to-day oversight of the radiation safety program. • Establishment and management of a radiation safety and decommissioning records system. • Methods or procedures for preventing the release of contaminated material and equipment. • Methods or procedures for preventing personnel contamination. Radiation safety procedures and the authorized users responsibilities unique to each type of service operation requested in the application. • Equipment, techniques, and corresponding radiation safety procedures associated with providing services involving either sealed sources or unsealed materials. 				
	<p>Audit Program</p>	<p align="center">Need Not Be Submitted With Application</p>			

Item No.	Title and Criteria	Yes	No	N/A	Description Attached
10	<p>RADIATION SAFETY PROGRAM (Cont'd)</p> <p>Radiation Monitoring Instruments</p> <ul style="list-style-type: none"> A description of the instrumentation described in Section 8.9.2 of draft NUREG-1556, Vol. 18, 'Consolidated Guidance About Materials Licenses: Program Specific Guidance About Service Provider Licenses,' dated May 2000, that will be used to perform required surveys. "We will use instruments that meet the radiation monitoring instrument specifications published in Appendix J to draft NUREG-1556, Vol. 18, 'Consolidated Guidance About Materials Licenses: Program Specific Guidance About Service Provider Licenses,' dated May 2000' We reserve the right to upgrade our survey instruments as necessary." <p style="text-align: center;">OR</p> <p>A description of the instrumentation described in Section 8.9.2 of draft NUREG-1556, Vol. 18, 'Consolidated Guidance About Materials Licenses: Program Specific Guidance About Service Provider Licenses,' dated May 2000" that will be used to perform required surveys. "We will use instruments that meet the radiation monitoring instrument specifications published in Appendix J to draft NUREG-1556, Vol. 18, 'Consolidated Guidance About Materials Licenses: Program Specific Guidance About Service Provider Licenses,' dated May 2000. Additionally, we will implement the model survey meter calibration program published in Appendix J to draft NUREG-1556, Vol. 18, 'Consolidated Guidance About Materials Licenses: Program Specific Guidance About Service Provider Licenses,' dated May 2000. We reserve the right to upgrade our survey instruments as necessary."</p>	[]	[]		[]

APPENDIX C

Item No.	Title and Criteria	Yes	No	N/A	Description Attached
10	<p>RADIATION SAFETY PROGRAM (Cont'd)</p> <p>Radiation Monitoring Instruments (Cont'd)</p> <p style="text-align: center;">OR</p> <ul style="list-style-type: none"> • A description of alternative equipment and/or procedures for ensuring that appropriate radiation monitoring equipment will be used during licensed activities and that proper calibration and calibration frequency of survey equipment will be performed. The statement "We reserve the right to upgrade our survey instruments as necessary," should be added to the response. <p>Material Receipt and Accountability</p> <ul style="list-style-type: none"> • "Ordering licensed material and package receipt and opening will follow the model procedures in Appendix K in draft NUREG-1556, Vol. 18, 'Consolidated Guidance About Materials Licenses: Program Specific Guidance About Service Provider Licenses,' dated May 2000." <p style="text-align: center;">OR</p> <ul style="list-style-type: none"> • Submit a description of procedure(s) for ordering licensed material and package receipt and opening. <p style="text-align: center;">AND</p> <ul style="list-style-type: none"> • For unsealed licensed material, submit a description of procedure(s) for ensuring material accountability. 				<p style="text-align: center;">[]</p> <p style="text-align: center;">[] []</p> <p style="text-align: center;">[]</p> <p style="text-align: center;">[]</p>

Item No.	Title and Criteria	Yes	No	N/A	Description Attached
10	<p>RADIATION SAFETY PROGRAM (Cont'd)</p> <p>Occupational Dosimetry</p> <ul style="list-style-type: none"> • "We will have a prospective evaluation and determine that unmonitored individuals are not likely to receive, in one year, a radiation dose in excess of 10% of the allowable limits in 10 CFR Part 20, or we will monitor individuals in accordance with the criteria in the section entitled 'Occupational Dose' in draft NUREG-1556, Vol. 18, 'Consolidated Guidance About Materials Licenses: Program Specific Guidance About Service Provider Licenses,' dated May 2000." <p style="text-align: center;">OR</p> <ul style="list-style-type: none"> • A description of an alternate method for demonstrating compliance with the referenced regulations. <p style="text-align: center;">AND/OR</p> <ul style="list-style-type: none"> • Provide a bioassay program when using unsealed radioactive materials. If an applicant elects to provide a bioassay program that is less conservative than recommended in Regulatory Guide 8.20, its rationale should be stated. <p style="text-align: center;">AND</p> <ul style="list-style-type: none"> • Bioassay programs must include what the applicant considers and acceptable interval or schedule for conducting bioassays, identify action levels or guidelines, and describe specific actions to be taken when action levels are exceeded. Because of the complex nature of bioassay and corresponding data analysis, it is acceptable for applicants to make reference to the procedures in NRC guidance documents. 	<p style="text-align: center;">[]</p>	<p style="text-align: center;">[]</p>		<p style="text-align: center;">[]</p> <p style="text-align: center;">[]</p> <p style="text-align: center;">[]</p>

APPENDIX C

Item No.	Title and Criteria	Yes	No	N/A	Description Attached
10	<p>RADIATION SAFETY PROGRAM (Cont'd)</p> <p>Occupational Dosimetry (Cont'd)</p> <p style="text-align: center;">OR</p> <p>Contract with an outside group for bioassay services. Provide a commitment that each vendor is licensed or otherwise authorized by NRC or Agreement State to provide required bioassay services.</p> <p>Public Dose</p> <p>The applicant is not required to, and should not, submit a response to the public dose section during the licensing phase. This matter will be inspected during an inspection.</p> <p>Operating and Emergency Procedures</p> <ul style="list-style-type: none"> • Instructions for handling and using licensed materials • Instructions for maintaining security during storage and transportation • Instructions to keep licensed material under control and immediate surveillance during use • Steps to take to keep radiation exposures ALARA • Steps to maintain accountability during use • Steps to control access to work sites • Steps to take and whom to contact when an emergency occurs • Instructions for using remote handling tools when handling sealed sources, except low-activity calibration sources • Methods and occasions for conducting radiation surveys, including surveys for detecting contamination • Procedures to minimize personnel exposure during routine use and in the event of an incident, including exposures from inhalation and ingestion of licensed unsealed materials • Methods and occasions for locking and securing stored licensed materials 				[]
		Need Not Be Submitted With Application			
		[]	[]	[]	[]
		[]	[]	[]	[]
		[]	[]	[]	[]
		[]	[]	[]	[]
		[]	[]	[]	[]
		[]	[]	[]	[]
		[]	[]	[]	[]
		[]	[]	[]	[]
		[]	[]	[]	[]
		[]	[]	[]	[]
		[]	[]	[]	[]
		[]	[]	[]	[]
		[]	[]	[]	[]
		[]	[]	[]	[]
		[]	[]	[]	[]
		[]	[]	[]	[]
		[]	[]	[]	[]
		[]	[]	[]	[]
		[]	[]	[]	[]
		[]	[]	[]	[]
		[]	[]	[]	[]

Item No.	Title and Criteria	Yes	No	N/A	Description Attached
10	<p>RADIATION SAFETY PROGRAM (Cont'd)</p> <p>Operating and Emergency Procedures (Cont'd)</p> <ul style="list-style-type: none"> • Personnel monitoring, including bioassays, and the use of personnel monitoring equipment • Transportation of licensed materials to temporary job sites, packaging of licensed materials for transport in vehicles, placarding of vehicles when needed, and physically securing licensed materials in transport vehicles during transportation to prevent accidental loss, tampering, or unauthorized removal • Procedures for picking up, receiving, and opening packages containing licensed materials, in accordance with 10 CFR 20.1906 • Instructions for maintaining records in accordance with the regulations and the license conditions • Procedures for identifying and reporting to NRC defects and noncompliance as required by 10 CFR 21.21(a) of this chapter • Procedures and actions to be taken if a sealed source is ruptured, including actions to prevent the spread of contamination and minimize inhalation and ingestion of licensed materials and actions to obtain suitable radiation survey instruments • Instructions for the proper storage and disposal of radioactive waste • Procedures to be followed in the event of uncontrolled release of radioactive unsealed licensed material to the environment, including notification of the RSO, NRC, and other federal and state agencies. • Procedures for identifying and reporting to NRC defects and noncompliance. See Table 8.4, which describes the typical incident notifications required by NRC regulations. 	[]	[]	[]	[]
		[]	[]	[]	[]
		[]	[]	[]	[]
		[]	[]	[]	[]
		[]	[]	[]	[]
		[]	[]	[]	[]
		[]	[]	[]	[]
		[]	[]	[]	[]
		[]	[]	[]	[]

APPENDIX C

Item No.	Title and Criteria	Yes	No	N/A	Description Attached
10	<p>RADIATION SAFETY PROGRAM (Cont'd)</p> <p>Surveys</p> <p>"We will survey our facility and maintain contamination levels in accordance with the survey frequencies and contamination levels published in draft NUREG-1556, Vol. 18, 'Consolidated Guidance About Materials Licenses: Program Specific Guidance About Service Provider Licenses,' dated May 2000.</p> <p style="text-align: center;">OR</p> <p>Submit description of alternative method for demonstrating how to evaluate a radiological hazard.</p> <p>Leak Tests</p> <p>"Leak tests, when required by the license, will be performed at intervals approved by the NRC or an Agreement State and specified in the Sealed Source and Device Registration Sheet. Leak tests will be performed by an organization authorized by NRC or an Agreement State to provide leak testing services to other licensees or using a leak test kit supplied by an organization authorized by NRC or an Agreement State to provide leak test kits to other licensees and according to the kit supplier's instructions."</p> <p style="text-align: center;">OR</p> <ul style="list-style-type: none"> "Leak testing will follow the model procedures in Appendix O." to draft NUREG-1556, Vol. 18, 'Consolidated Guidance About Materials Licenses: Program Specific Guidance About Service Provider Licenses,' dated May 2000. 	<p style="text-align: center;">[]</p> <p style="text-align: center;">[]</p> <p style="text-align: center;">[]</p> <p style="text-align: center;">[]</p>	<p style="text-align: center;">[]</p> <p style="text-align: center;">[]</p> <p style="text-align: center;">[]</p> <p style="text-align: center;">[]</p>	<p style="text-align: center;">[]</p> <p style="text-align: center;">[]</p> <p style="text-align: center;">[]</p> <p style="text-align: center;">[]</p>	<p style="text-align: center;">[]</p>

Item No.	Title and Criteria	Yes	No	N/A	Description Attached
10	<p>RADIATION SAFETY PROGRAM (Cont'd)</p> <p>Leak Tests (Cont'd)</p> <p style="text-align: center;">OR</p> <ul style="list-style-type: none"> • "Leak testing procedures and analysis will be done by the applicant." Provide the information in supporting a request to perform leak testing. Appendix O to draft NUREG-1556, Vol. 18, 'Consolidated Guidance About Materials Licenses: Program Specific Guidance About Service Provider Licenses,' dated May 2000 may serve as guidance. <p style="text-align: center;">OR</p> <ul style="list-style-type: none"> • "We will provide commercial leak test kits as described in the model leak test kit description in Section 8.9.8 of draft NUREG-1556, Vol. 18, 'Consolidated Guidance About Materials Licenses: Program Specific Guidance About Service Provider Licenses,' dated May 2000." <p style="text-align: center;">AND</p> <ul style="list-style-type: none"> • Provided is a sample of the leak test kits that will be distributed commercially for each type of sealed source/device combination we plan to provide. 				<p style="text-align: center;">[]</p> <p style="text-align: center;">[]</p>

APPENDIX C

Item No.	Title and Criteria	Yes	No	N/A	Description Attached
10	<p>RADIATION SAFETY PROGRAM (Cont'd)</p> <p>Maintenance</p> <ul style="list-style-type: none"> • "We will implement and maintain procedures for conducting routine maintenance of our device according to each manufacturer's (or distributor's) written recommendations and instructions." <p style="text-align: center;">OR</p> <ul style="list-style-type: none"> • Alternative procedures are provided for NRC's review. • "We will have the device manufacturer (or distributor) or other person authorized by NRC or an Agreement State to perform non-routine maintenance on our devices." <p style="text-align: center;">OR</p> <ul style="list-style-type: none"> • Information requested in Appendix P of draft NUREG-1556, Vol. 18, 'Consolidated Guidance About Materials Licenses: Program Specific Guidance About Service Provider Licenses,' dated May 2000 is provided to support request to conduct nonroutine maintenance procedures. <p>Minimization of Contamination</p> <ul style="list-style-type: none"> • NRC will consider that the criteria for minimization of contamination has been met if the applicant's responses satisfy the criteria in the following sections: "Radioactive Material - Unsealed and/or Sealed Sources," "Facilities and Equipment," "Radiation Safety Program - Safe Use of Radioisotopes and Emergency Procedures," "Radiation Safety Program - Surveys," and "Radiation Safety Program - Waste Management." 	<p style="text-align: center;"><input type="checkbox"/></p> <p style="text-align: center;"><input type="checkbox"/></p> <p style="text-align: center;"><input type="checkbox"/></p>	<p style="text-align: center;"><input type="checkbox"/></p> <p style="text-align: center;"><input type="checkbox"/></p>		<p style="text-align: center;"><input type="checkbox"/></p> <p style="text-align: center;"><input type="checkbox"/></p> <p style="text-align: center;"><input type="checkbox"/></p>
		<p>No Response is Necessary for this Section</p>			

Item No.	Title and Criteria	Yes	No	N/A	Description Attached
10	<p>RADIATION SAFETY PROGRAM (Cont'd)</p> <p>Transportation</p> <p>No response is needed from applicants during the licensing phase.</p> <p>Waste Management</p> <ul style="list-style-type: none"> • We will use the Decay-In-Storage • We will use the Disposal of Liquids Into Sanitary Sewerage model waste procedures that are published in Appendix T to draft NUREG-1556, Vol. 18, 'Consolidated Guidance About Materials Licenses: Program Specific Guidance About Service Provider Licenses,' dated May 2000. <p style="text-align: center;">OR</p> <ul style="list-style-type: none"> • Provided are procedures for waste collection, storage and disposal by any of the authorized methods described in this section. <p style="text-align: center;">OR</p> <ul style="list-style-type: none"> • If access to a radioactive waste burial site is unavailable, the applicant should request authorization for extended interim storage of waste. Applicant should refer to NRC IN 90-09, "Extended Interim Storage of Low-Level Radioactive Waste by Fuel Cycle and Materials Licensees," dated February 1990, for guidance and submit the required information with the application. 				
		No Response is Necessary for this Section			
		<input type="checkbox"/>	<input type="checkbox"/>		
		<input type="checkbox"/>	<input type="checkbox"/>		
					<input type="checkbox"/>
		<input type="checkbox"/>	<input type="checkbox"/>		<input type="checkbox"/>

Appendix D
Checklist for License Application

**SERVICE PROVIDER APPLICATION
REVIEW CHECK LIST**

Date: _____

CONTENTS OF APPLICATION

ITEM 8.1 TYPE OF APPLICANT/LICENSEE

Type of Action	License No.
<input type="checkbox"/> A. New License	Not Applicable
<input type="checkbox"/> B. Amendment	
<input type="checkbox"/> C. Renewal	

ITEM 8.2 NAME OF APPLICANT/LICENSEE

LEGAL NAME: _____

MAILING ADDRESS: _____

ITEM 8.3 LOCATION OF USE

- Address listed above
- Facilities that must be specifically identified on the license (Street Address, City, State, and Zip Code):
 - <> _____
 - <> _____
 - <> _____

Temporary Job Sites

ITEM 8.4 CONTACT PERSON

NAME: _____

TELEPHONE NUMBER: _____

APPENDIX D

ITEMS 8.5 - 8.6 RADIOACTIVE MATERIAL TO BE POSSESSED/*REQUESTED USE OF MATERIALS

BROAD SCOPE LICENSE AUTHORIZATION

- Type A
- Type B
- Type C

SEALED SOURCES AND DEVICES

- Identify each radionuclide (element name and mass number) that will be used in each sealed source.
- Provide the manufacturer's (distributor's) name and model number for each sealed source and, if applicable, device requested.
- Confirm that the activity per source and maximum activity in each device will not exceed the maximum activity listed on the approved certificate of registration issued by NRC or by an Agreement State.
- Confirm that each sealed source, device, and source/device combination is registered as an approved sealed source or device by NRC or an Agreement State.

UNSEALED MATERIALS (Volatile & Nonvolatile)

- Provide element name with mass number, chemical and/or physical form, and maximum requested possession limit.
- Provide information for *volatile materials*, if known, on the anticipated rate of volatility or dispersion. This information may be obtained from the material vendor, supplier, or manufacturer.

SEALED SOURCES			
Radioisotope	Mfg./Model No. SSD Certificate No.	Quantity (Curies/MBq/GBq)	*Use

UNSEALED MATERIALS

Radioisotope	Chemical/Physical Form	Quantity (Curies/MBq/GBq)	*Use	Volatility/Dispersion

SOURCE MATERIALS

Radioisotope	Chemical/Physical Form	Quantity (Curies/MBq/GBq) Kilograms	*Use

SPECIAL NUCLEAR MATERIALS (LESS THAN CRITICAL MASS)

Radioisotope	Chemical/Physical Form	Quantity (Curies/MBq/GBq)	*Use

***MATERIAL USE LEGEND**

L=Leak Test Analysis	E=Environmental Sample Analysis	C=Calibration of radiation protection equipment	NL=Nuclear Laundry
CC=Commercial Calibration of radiation protection equipment	CNL=Commercial Nuclear Laundry	CL=Commercial Leak Test Analysis	E=Commercial Environmental Sample Analysis
Incineration	Compaction/Super Compaction	Decontamination	Site Characterization

APPENDIX D

O=Other Services Not Included Excluding Critical Mass Quantities of SNM

PSI=Possession of Sealed Sources Incident to Performing Services

- Installation into devices or equipment
- Radiation Surveys
- Removal
- Relocation
- Repair
- Source Exchange
- Routine Maintenance
- Preventive Maintenance
- Nonroutine Maintenance
- Source Retrieval
- Transportation
- Packaging
- Leak Test Same Acquisition
- Customer Training
- Other Services not included,

Other Services Explanation:

CW=Commercial Waste Management Services

- Incineration
- Compaction/Super Compaction
- Solidification/Vitrification
- Packaging, Repackaging, and Transportation
- Decontamination
- Decommissioning
- Site Characterization
- Other Services not included, excluding critical mass quantities of SNM

Other Commercial Services Explanation:

FINANCIAL ASSURANCE

- Financial Assurance not required
- Financial Assurance required and Financial Assurance Documents submitted for review
- Decommissioning Records File established

ITEM 8.7 RESPONSIBLE INDIVIDUALS

Corporate Organization Chart Submitted

Radiation Safety Organizational Chart Submitted

Name(s) of responsible individual(s)

- Title(s) of individual(s)
- Training of individual(s)
- Experience.

Radiation Safety Officer Information:

<input type="checkbox"/> Name	<input type="checkbox"/> Experience	<input type="checkbox"/> Training - Include specific dates	<input type="checkbox"/> Independent Authority to stop unsafe operations
<input type="checkbox"/> Organizational Chart (Day-to-Day Radiation Safety Positions) provided			
<input type="checkbox"/> See Item 8.7. 1 for a list of typical RSO duties and responsibilities			

AUTHORIZED USERS/ANCILLARY PERSONNEL

- Classroom training
 - Lecture
 - Videotape
 - Self-study that emphasizes practical subject matter important to the safe handling of licensed materials
 - All types of training commensurate with the expected hazards encountered during routine and emergency conditions.
- Frequency of Training
 - Before assuming duties with, or in the vicinity of, radioactive materials
 - Whenever there is a significant change in duties, regulations, or the terms and conditions of the license
 - Annually for refresher training.
- Suggested Radiation Safety Topics:
 - Fundamentals of Radiation Safety:
 - Characteristics of radiation
 - Units of radiation dose and quantity of radioactivity
 - Hazards of exposure to radiation
 - Levels of radiation from licensed material
 - Methods of controlling radiation dose (time, distance, and shielding)
 - ALARA concept.

APPENDIX D

- () Radiation Detection Instruments:
 - Operation
 - Calibration
 - Limitations of radiation survey instruments
 - Radiation survey techniques for measuring radiation field
 - Radiation survey techniques for measuring removable/fixed contamination
 - Handling and proper use of personnel monitoring equipment.
- () Radiation Protection Equipment and Use:
 - Proper use of protective equipment
 - Decontamination of contaminated protection equipment.
- () Applicable NRC regulations (10 CFR 19, 20, 21, 31, 32, 34, 35, 36, 39, 40, 70, and 71) as applicable
- () Case histories relevant to operations
- () Course Examination (Didactic)
 - Successful completion of closed-book written/oral examination depending on the complexity and hazards of authorized activities
 - Review of incorrect answers with student.
- () On-the Job Training and Examination (Practical):
 - On-the-job training done under the supervision of a qualified individual (AU, RSO, or manufacturer's representative authorized by the NRC or an Agreement State) that includes supervised hands-on experience performing the task authorized on the license that are commensurate with the expected hazards during routine and emergency conditions
 - Practical examination consisting of an assessment by the RSO to ensure that each proposed AU is qualified to work independently and that each individual is knowledgeable of the radiation safety aspects of licensed activities. This may be demonstrated by observing the proposed AU perform licensed activities.
- () Discussion and/or drill on emergency procedures
- () Retraining on areas found to be deficient in both the practical and didactic areas
- [] Classroom Course Instructor Qualifications
 - () Qualified individual (e.g., a person who meets the qualifications for RSO or authorized user on the license and is familiar with the licensee's program)
 - () Instructors who provide classroom training to individuals in the principles of radiation and radiation safety should have knowledge and understanding of these principles beyond those obtainable in a course similar to the one given to prospective authorized users
 - () Individuals who provide instruction in the hands-on use of licensed materials should have training and experience that would qualify them to be authorized users, or should possess a thorough understanding of the licensee operations.

ITEM 8.8 TRAINING FOR INDIVIDUALS WORKING IN OR FREQUENTING RESTRICTED AREAS

- See Item 8.7 for suggested topics, frequency of training, etc.
- Elements of Training Program Identified.

ITEM 8.9 FACILITIES AND EQUIPMENT

Commercial Leak Test or Environmental Sample Analysis (No response required)

Commercial Instrument Calibration (No response required)

Services Involving Handling of Sealed Sources Inside Shielded Containers (No response required)

Services Involving Handling of Sealed Sources Outside Shielded Containers

- Sketch/drawing *to scale* of the facility and all work areas where materials will be used or stored
- Identify the following, where applicable:
 - Areas where explosive, flammable or other hazardous materials stored
 - Buildings
 - Boundary lines
 - Security fences
 - Local storage areas
 - Drawn to specified scale
 - Sketch/drawing of:
 - <> locked storage container
 - <> security of licensed materials.

Other services that involve handling of unsealed radioactive material:

- Describe the permanent facilities and equipment to be made available at each location.
- Include a description of the area(s) assigned for the receipt, storage, security, preparation, handling, waste storage and measurement of radioactive materials.
- Submit a facility diagram showing the proximity of licensed materials to unrestricted areas.
- Drawings, sketches, diagrams, etc. should indicate the scale, or include dimensions on each drawing or sketch.
- Submit a diagram, sketch, or drawing, when applicable, that identifies areas where radioactive materials may become airborne. The diagram should contain descriptions of the ventilation systems, with pertinent airflow rates, filtration equipment, sample collection points, and monitoring systems.
- Submit a diagram of radioactive waste handling equipment that includes incinerators.

APPENDIX D

- Describe proposed laundry facilities, if applicable, used for contaminated protective equipment and clothing. Specify how the contaminated waste water from the laundry machines or sinks is disposed. Operating and emergency procedures should address decontamination of the laundry area and equipment.
- Describe protective clothing (such as rubber gloves, coveralls, respirators, and face shields), auxiliary shielding, absorbent materials, secondary containers for waste water storage for decontamination purposes, plastic bags for storing contaminated items, etc., that will be available.
- Identify specialized handling tools, facility safety interlocks designed to prevent operation of radiological safety systems in the event that operation of a system could result in accidental exposure or release of material (e.g., HEPA filters, ventilation system, safety door interlocks, etc.) or equipment.

Facility: For Authorization for Unsealed Materials Other than Leak Test or Environmental Sample Analysis, Provide:

- Describe, if applicable:
 - Hoods
 - Hood filters
 - Sinks
 - Trays with absorbent materials
 - Remote handling tools
 - Rubber gloves.
- Storage provisions
 - Describe & provide a drawing of storage facilities
 - Storage of waste materials included
 - Security provisions
 - Adequate shielding.
- Noncommercial Laundry Facility for contaminated clothing, etc.
- Noncommercial Decontamination Facilities.

Temporary Job Site Facility:

- Sealed Sources General
 - No facility description is required
 - Specialized handling tools or equipment.

- Unsealed Material
 - Describe protective clothing (such as rubber gloves, coveralls, respirators, and face shields), auxiliary shielding, absorbent materials, secondary containers for waste water storage for decontamination purposes, plastic bags for storing contaminated items, etc., that will be available.
 - Describe available radiation safety equipment.

ITEM 8.10 RADIATION SAFETY PROGRAM

ITEM 8.10.1 AUDIT PROGRAM

- Reviewed on an annual basis
 - ALARA
 - NRC/DOT regulations & License
 - Occupational/Public Doses
- Audit program **not submitted**, but available for inspection by NRC
- Appendix I reviewed.

ITEM 8.10.2 RADIATION MONITORING INSTRUMENTS

- Type of instruments (GM, Ion chamber, scintillation)
- Type of radiation detected (α, β, γ , neutron)
- Availability of survey instruments.

Survey Instrument <ul style="list-style-type: none"> • Manufacturer • Model No. • # Available • Type <ul style="list-style-type: none"> - GMI on-chamber - Scintillation 	Instrument Probes <ul style="list-style-type: none"> • Model No. 	Range <ul style="list-style-type: none"> • CPM • DPM • mR/hr • mr/hr 	Radiation Detected <ul style="list-style-type: none"> • α • β • γ • neutron
Counting Equipment For: <ul style="list-style-type: none"> • Analysis of Contamination Swipes • Analysis of Bioassay Samples 		Calibration Standards	Minimum Detectable Activity
Special Equipment <ul style="list-style-type: none"> • Air Samplers • Direct Reading Dosimeters • Condenser R meter 		# Available	Description

APPENDIX D

CALIBRATION OF RADIATION DETECTION INSTRUMENTS

- Calibration frequency specified
- In-house
- By manufacturer
- By outside firm
- Name _____
- License No. _____
- Calibration procedures in Appendix J adopted
- Alternative calibration procedures for radiation detection instruments provided for NRC review.

ITEM 8.10.3

MATERIAL RECEIPT AND ACCOUNTABILITY PHYSICAL INVENTORY

- Semiannual frequency
- Maintain records of receipt, transfer, and disposal
- Information
 - Quantity and kind of licensed material (Sealed Sources)
 - Location of licensed material
 - Date of inventory
 - Name of individual conducting inventory
 - Inventory records for sealed sources may be combined with leak test records
- Appendix K - Ordering/Receiving Materials Reviewed.

ITEM 8.10.4

OCCUPATIONAL DOSE

- Evaluation Completed for occupationally exposed individuals
- Dosimetry
 - TLD
 - Film
 - OSL
 - Neutron capability
 - NVLAP Approved
 - Exchange frequency
 - <> Monthly
 - <> Quarterly
 - <> Other _____

BIOASSAYS

- Procedures in RG 8.20 adopted for conducting bioassays
- Alternate Procedure to RG 8.20 provided for conducting bioassays
- Commercial Service:
 - Name _____
 - License No. _____

ITEM 8.10.5**PUBLIC DOSE**

- No response required
- Dose evaluation maintained for inspection
- Appendix M reviewed.

ITEM 8.10.6**SAFE USE OF RADIONUCLIDES AND EMERGENCY PROCEDURES**

- Procedure for obtaining an agreement with customers outlining the responsibilities of both the customer and service provider, when performing service operations at a customer's facility
- Instructions for handling and using licensed materials
- Instructions for maintaining security during storage and transportation
- Instructions to keep licensed material under control and immediate surveillance during use
- Steps to take to keep radiation exposures ALARA
- Steps to maintain accountability during use
- Steps to control access to work sites
- Steps to take and whom to contact when an emergency occurs
- Instructions for using remote handling tools when handling sealed sources, except low-activity calibration sources
- Methods and occasions for conducting radiation surveys, including surveys for detecting contamination
- Procedures to minimize personnel exposure during routine use and in the event of an incident, including exposures from inhalation and ingestion of licensed unsealed materials
- Methods and occasions for locking and securing stored licensed materials
- Procedures for personnel monitoring, including bioassays, and the use of personnel monitoring equipment
- Procedures for transporting licensed materials to temporary job sites, packaging of licensed materials for transport in vehicles (private or common carrier), placarding of vehicles when needed, and physically securing licensed materials in transport vehicles during transportation to prevent accidental loss, tampering, or unauthorized removal
- Procedures for picking up, receiving, and opening packages containing licensed materials, in accordance with 10 CFR 20.1906

APPENDIX D

- [] Instructions for maintaining records in accordance with the regulations and the license conditions
- [] Procedures for identifying and reporting to NRC defects and noncompliance as required by 10 CFR 21.21(a) of this chapter
- [] Procedures and actions to be taken if a sealed source is ruptured, including actions to prevent the spread of contamination and minimize inhalation and ingestion of licensed materials and actions to obtain suitable radiation survey instruments
- [] Instructions for the proper storage and disposal of radioactive waste
- [] Procedures to be followed in the event of uncontrolled release of radioactive unsealed licensed material to the environment, including notification of the RSO, NRC, and other Federal and State agencies
- [] Procedures for identifying and reporting to NRC defects and noncompliance, see Table 8.4 that describes the typical incident notifications required by NRC regulations
- [] Procedures for the Implementation and adherence to good health physics practices while performing service operations
 - Minimization of distance to areas, to the extent practicable, where licensed materials are used and stored
 - Maximization of survey frequency, within reason, to enhance detection of contamination
 - Segregation of radioactive material in waste storage areas
 - Segregation of sealed sources and tracer materials to prevent cross-contamination
 - Separation of radioactive material from explosives
 - Separation of potentially contaminated areas from clean areas by barriers or other controls.
- [] Service Provider Requesting Authorization to Perform Major Decontamination Activities
 - () Instructions to personnel how to determine presence through survey
 - () Levels of contamination
 - () Decontamination procedures
 - () Decontamination equipment
 - () Prevention of contamination of personnel during decontamination
 - () How to handle contaminated waste materials
 - () Re-survey of contaminated area to determine effectiveness
 - () Records of survey
 - <> Before
 - <> After
 - () Contact person.
- [] Decontamination activities will only be conducted by outside sources licensed by NRC or an Agreement State to conduct these activities.

ITEM 8.10.7

SURVEYS

- Facilities
- Equipment
- Personnel
- Restricted Areas
- Unrestricted Areas
- Types of Surveys
 - Surveys for radioactive contamination that could be present on surfaces of floors, walls, laboratory furniture, and equipment
 - Measurements of radioactive material concentrations in air for areas where radioactive materials are handled or processed in unsealed form and where operations could expose workers to the inhalation of radioactive material or where licensed material is or could be released to unrestricted area
 - Measurements of radioactive material concentrations in water that is released to the environment or to the sanitary sewer
 - Bioassays to determine the kinds, quantities or concentration, and in some cases, the location of radioactive material in the human body. A bioassay can be made by direct measurement (in vivo counting) or by analysis and evaluation of material excreted or removed from the human body
 - Surveys of external radiation exposure levels in both restricted and unrestricted areas.
- Contamination Survey Frequency
 - Table 8.5 adopted
 - Alternate contamination survey frequencies provided.
- Contamination in Unrestricted Area
 - Table 8.6 adopted
 - Alternate contamination survey frequencies provided.
- Survey Record Requirements
 - A diagram of the area surveyed
 - A list of items and equipment surveyed
 - Specific locations on the survey diagram where wipe test was taken
 - Ambient radiation levels with appropriate units
 - Contamination levels with appropriate units
 - Make and model number of instruments used
 - Background levels
 - Name of the person making the evaluation and recording the results and date.

APPENDIX D

- Air Monitoring
 - Determine whether the confinement of radioactive materials is effective
 - Measure airborne radioactive material concentrations in the workplace
 - Estimate worker intakes of radioactive material
 - Determine posting requirements
 - Determine what protective equipment and measures are appropriate
 - Warn of significantly elevated levels of airborne radioactive materials.
- Effluent Release Monitoring
 - Airborne
 - Liquid (See Appendix N).

ITEM 8.10.8

LEAK TESTING

- Vendor(s) Name: _____
Address: _____
Agreement State/NRC License No.: _____
- Leak test kit
- Leak testing conducted in-house using Appendix O procedures
- Alternative leak testing procedures submitted for NRC review.

ITEM 8.10.9

MAINTENANCE

- Are specifically authorized by your license to perform the specific activity
- Follow the manufacturer's procedures describing the activity
- Have individuals qualified by their training and experience to perform the activity
- Use approved parts and components
- Have specialized equipment to perform these activities
- Test the device before it is returned to routine use to ensure that it functions as designed
- Test the device before it is returned to routine use to ensure that it functions as designed
- See Appendix P .

REMOVAL OR MAINTENANCE ON A SEALED SOURCE OR HOLDER

- Services performed by manufacturer
- Performed by individual licensed by Agreement State/NRC. Performed by licensee. Detailed procedures for each task provided for NRC review. Radiation safety precautions outlined in O&E procedures.

SEALED SOURCES STUCK IN A SOURCE HOLDER

- Performed by licensed equipment manufacturer
- Performed by individual licensed by Agreement State/NRC
- Performed by licensee
 - Detailed procedures for each task provided for NRC review
 - Radiation safety precautions outlined in O&E procedures

OPENING, REPAIR, OR MODIFICATION OF SEALED SOURCES

- Performed by Agreement State/NRC licensed firm
- Performed by licensee
 - Detailed procedures for each task provided for NRC review
 - Radiation safety precautions outlined in O&E procedures.

ITEM 8.10.10 MINIMIZATION OF CONTAMINATION

- Implementation of and adherence to good health physics practices in operations
- Minimization of areas, to the extent practicable, where licensed materials are used and stored
- Maximization of the frequency of surveys, within reason, to minimize spread of contamination
- Appropriate filtration of effluent streams
- Use of non-porous materials for laboratory bench tops, flooring, etc.
- Ventilation stacks and duct work with minimal lengths and minimal abrupt changes in direction
- Use of appropriate plumbing materials with minimal pipe lengths and traps
- Minimization of the number of disposal sites (sinks) where liquid waste is disposed.

ITEM 8.10.11 TRANSPORTATION

- No response required, DOT regulations will be followed
- Appendix Q reviewed.

ITEM 8.11 WASTE MANAGEMENT [10 CFR Part 20, Subpart K]

- Decay-in-storage disposal for radioactive materials with half-lives less than or equal to 120 days
 - When a container is transferred to the waste storage area, mark the container with an identification label that includes the date sealed, the isotope in the container, and the initials of the person sealing the container
 - <120 day T_{1/2} material
 - Held for decay a minimum of 10 T_{1/2}

APPENDIX D

() Confirm that prior to disposal as in-house waste, you will monitor each container, as follows:

- <> Check radiation detection survey meter for proper operation
- <> Monitor container in a low-level area (less than 0.05mrem/hr)
- <> Remove any shielding from container
- <> Monitor all surfaces
- <> Discard only those containers that cannot be distinguished from background
- <> Container that can be distinguished from background must be returned to storage area for further decay or transferred to person licensed to receive such waste.

- Return to manufacturer
- Extended Interim Storage of materials pending disposal or transfer to authorized recipient
- Licensed company
- Disposal by release into sanitary sewerage (§20.2003)
- Appendix N reviewed.

ITEM 8.12

FEES

- Fee, if any required, attached.

ITEM 8.13

CERTIFICATION

- Individual signing an application authorized to make binding commitments and to sign official documents on behalf of the legal entity or applicant.

Appendix E
Sample Licenses

CORRECTED COPY

MATERIALS LICENSE

Pursuant to the Atomic Energy Act of 1954, as amended, the Energy Reorganization Act of 1974 (Public Law 93-438), and Title 10, Code of Federal Regulations, Chapter I, Parts 30, 31, 32, 33, 34, 35, 36, 39, 40, and 70, and in reliance on statements and representations heretofore made by the licensee, a license is hereby issued authorizing the licensee to receive, acquire, possess, and transfer byproduct, source, and special nuclear material designated below; to use such material for the purpose(s) and at the place(s) designated below; to deliver or transfer such material to persons authorized to receive it in accordance with the regulations of the applicable Part(s). This license shall be deemed to contain the conditions specified in Section 183 of the Atomic Energy Act of 1954, as amended, and is subject to all applicable rules, regulations, and orders of the Nuclear Regulatory Commission now or hereafter in effect and to any conditions specified below.

<p style="text-align: center;">Licensee</p> <p>1. [Licensee Name]</p> <p>2. [Licensee Mailing Address] [Street, City, State, Zip Code]</p>	<p>3. License number 00-000000-01</p> <p>4. Expiration date <u>May 31, 2010</u></p> <p>5. Docket No: <u>030-00000</u> Reference No.</p>	
<p>6. Byproduct, source, and/or special nuclear material</p> <p>A. Strontium 90</p> <p>B. Krypton 85</p> <p>C. Americium 241</p> <p>D. Cobalt 60</p> <p>E. Cesium 137</p> <p>F. Promethium 147</p>	<p>7. Chemical and/or physical form</p> <p>A. Sealed sources</p> <p>B. Sealed sources</p> <p>C. Sealed sources</p> <p>D. Sealed sources</p> <p>E. Sealed sources</p> <p>F. Sealed sources</p>	<p>8. Maximum amount that licensee may possess at any one time under this license</p> <p>A. Not Applicable</p> <p>B. Not Applicable</p> <p>C. Not Applicable</p> <p>D. Not Applicable</p> <p>E. Not Applicable</p> <p>F. Not Applicable</p>

9. Authorized use:

A. through G. For use and/or possession incident to:

- (1) Installation into or removal from gauging devices.
- (2) Installation, relocation, repair, and servicing of Eurotherm Gauging Systems devices, LFE, and other gauging devices of the same basic design as Eurotherm and LFE devices manufactured by the following companies: ABB Process Automation, Accuray, Advanz, Aeonics, Barber Colman, Betacontrol, FAG, Fife, Indev, Mahlo, Measurex, NDC Systems, Ohmart, and Yokogawa. Leak Testing of sealed sources and radiation surveys of devices are included.
- (3) Instruction and training of individuals in the use of gauging devices.
- (4) Removal and shipping from customers facilities, transfer, and disposal of sealed sources and devices manufactured by Eurotherm Gauging Systems, LFE and other devices manufactured by the companies listed in (2) above received from customers for disposal.

CONDITIONS

**MATERIALS LICENSE
SUPPLEMENTARY SHEET**

License Number
00-000000-01

Docket or Reference Number
030-00000

Amendment No. 01

CORRECTED COPY

10. Licensed material may be used only at temporary job sites of the licensee anywhere in the United States where the U.S. Nuclear Regulatory Commission maintains jurisdiction for regulating the use of licensed material
11. A. Licensed material shall be used by, or under the supervision of and in the physical presence of [name of individuals].
B. The Radiation Safety Officer for this license is [insert name].
12. Sealed sources or detector cells containing licensed material shall not be opened or sources removed from source holders by the licensee.
13. The licensee may transport licensed material in accordance with the provisions of 10 CFR Part 71, "Packaging and Transportation of Radioactive Material"
14. Except as specifically provided otherwise in this license, the licensee shall conduct its program in accordance with the statements, representations, and procedures contained in the documents including any enclosures, listed below. The Nuclear Regulatory Commission's regulations shall govern unless the statements, representations and procedures in the licensee's application and correspondence are more restrictive than the regulations.
- A. Application dated [insert date].
B. Letter dated [insert date].

For the U.S. Nuclear Regulatory Commission

Date (insert license issue date)

By [Insert Reviewers Name]

Nuclear Materials Licensing Branch

Region IV

Arlington, Texas 76011

CORRECTED COPY

MATERIALS LICENSE

Pursuant to the Atomic Energy Act of 1954, as amended, the Energy Reorganization Act of 1974 (Public Law 93-438), and Title 10, Code of Federal Regulations, Chapter I, Parts 30, 31, 32, 33, 34, 35, 36, 39, 40, and 70, and in reliance on statements and representations heretofore made by the licensee, a license is hereby issued authorizing the licensee to receive, acquire, possess, and transfer byproduct, source, and special nuclear material designated below; to use such material for the purpose(s) and at the place(s) designated below; to deliver or transfer such material to persons authorized to receive it in accordance with the regulations of the applicable Part(s). This license shall be deemed to contain the conditions specified in Section 183 of the Atomic Energy Act of 1954, as amended, and is subject to all applicable rules, regulations, and orders of the Nuclear Regulatory Commission now or hereafter in effect and to any conditions specified below.

Licensee		
1. <u>[Licensee Name]</u>	3. License number 00-0000-01	
2. <u>[Licensee Address]</u> <u>[City, State, Zip Code]</u>	4. Expiration date <u>March 31, 2010</u>	
	5. Docket No. <u>030-00000</u> Reference No.	
6. Byproduct, source, and/or special nuclear material	7. Chemical and/or physical form	8. Maximum amount that licensee may possess at any one time under this license
A. Any byproduct material with Atomic Numbers 1 through 96	A. Any	A. Not to exceed 10 millicuries per radionuclide and 100 millicuries total except as specified in condition 11.
B. Any special nuclear material	B. Any	B. Not to exceed 10 micro curies per radionuclide and 100 micro curies total except as specified in Condition 11
C. Cesium 137	C. Sealed source (NEN Model NER-570)	C. Not to exceed 750 millicuries per source and 1.5 curies total
9. Authorized use:		
A. and B. For use in performing leak tests, sample analysis and instrument calibration as a commercial service for any person as defined in 10 CFR 30.4.		
C. For use in a J.L. Shephard and Associates Model 89 LAB-3 Calibrator for calibration of instruments, including commercial calibration service for any person as defined in 10 CFR 30.4.		

**MATERIALS LICENSE
SUPPLEMENTARY SHEET**License Number
00-00000-01Docket or Reference Number
030-00000**CORRECTED COPY****CONDITIONS**

10. Licensed material may be used only at the licensee's facilities located at [insert street address, city, state].
- A. Licensed material shall be used by, or under the supervision of, [insert name], or individual who have received the training described in [letter/application] dated [fill in date].
- B. The Radiation Safety Officer for this license is [insert name of RSO].
11. In addition to the possession limits in Item 8, the licensee shall further restrict the possession of licensed material so that at no time is a quantity of radioactive material possessed in excess of a quantity that requires decommissioning funding in accordance with 10 CFR 30.35(d), 10 CFR 40.36(b), or 10 CFR 70.25(d).
12. A. Sealed sources and detector cells shall be tested for leakage and/or contamination at intervals not to exceed 6 months or at such other intervals as are specified by the certificate of registration referred to in 10 CFR 32.210, not to exceed 3 years.
- B. Notwithstanding Paragraph A of this Condition, sealed sources designed to emit alpha particles shall be tested for leakage and/or contamination at intervals not to exceed 3 months.
- C. In the absence of a certificate from a transferor indicating that a test has been made within six months prior to the transfer, a sealed source or detector cell received from another person shall not be put into use until tested.
- D. Each sealed source fabricated by the licensee shall be inspected and tested for construction defects, leakage, and contamination prior to any use or transfer as a sealed source.
- E. Sealed sources and detector cells need not be leak tested if:
- (i) they contain only hydrogen 3; or
 - (ii) they contain only a gas; or
 - (iii) the half-life of the isotope is 30 days or less; or

**MATERIALS LICENSE
SUPPLEMENTARY SHEET**License Number
00-00000-01Docket or Reference Number
030-00000**CORRECTED COPY**

- (iv) they contain not more than 100 micro curies of beta and/or gamma emitting material or not more than 10 micro curies of alpha emitting material; or
- (v) they are not designed to emit alpha particles, are in storage, and are not being used. However, when they are removed from storage for use or transfer to another person, and have not been tested within the required leak test interval, they shall be tested before use or transfer. No sealed source or detector cell shall be stored for a period of more than 10 years without being tested for leakage and/or contamination.
- F. The test shall be capable of detecting the presence of 0.005 microcurie of radioactive material on the test sample. Records of leak test results shall be kept in units of micro curies and shall be maintained for inspection by the Commission. If the test reveals the presence of 0.005 microcurie or more of removable contamination, a report shall be filed with the U.S. Nuclear Regulatory Commission and the source shall be removed from service and decontaminated, repaired, or disposed of in accordance with Commission regulations. The report shall be filed within 5 days of the date the leak test result is known with the U.S. Nuclear Regulatory Commission, Region I, ATTN: Chief, Nuclear Materials Safety Branch, 611 Ryan Plaza Drive, Suite 400, Arlington, Texas 76011. The report shall specify the source involved, the test results, and corrective action taken.
- G. The licensee is authorized to collect leak test samples for analysis by the licensee. Alternatively, tests for leakage and/or contamination may be performed by persons specifically licensed by the Commission or an Agreement State to perform such services.
13. Sealed sources or detector cells containing licensed material shall not be opened or sources removed from source holders or detector cells by the licensee.
14. Licensed material shall not be used in or on human beings.
15. The licensee shall not acquire licensed material in a sealed source or device unless the source or device has been registered with the U.S. Nuclear Regulatory Commission pursuant to 10 CFR 32.210 or equivalent regulations of an Agreement State.
16. The licensee shall conduct a physical inventory every 6 months to account for all sources and/or devices received and possessed under the license. Records of inventories shall be maintained for 5 years from the date of each inventory.
17. The licensee is authorized to hold radioactive material with a physical half-life of less than 65 days for decay-in-storage before disposal in ordinary trash, provided:

**MATERIALS LICENSE
SUPPLEMENTARY SHEET**

License Number
00-00000-01

Docket or Reference Number
030-00000

CORRECTED COPY

- A. Waste to be disposed of in this manner shall be held for decay a minimum of ten half-lives.
 - B. Before disposal as ordinary trash, the waste shall be surveyed at the container surface with the appropriate survey instrument set on its most sensitive scale and with no interposed shielding to determine that its radioactivity cannot be distinguished from background. All radiation labels shall be removed or obliterated.
 - C. A record of each such disposal permitted under this License Condition shall be retained for three years. The record must include the date of disposal, the date on which the byproduct material was placed in storage, the radionuclides disposed, the survey instrument used, the background dose rate, the dose rate measured at the surface of each waste container, and the name of the individual who performed the disposal.
18. The licensee may transport licensed material in accordance with the provisions of 10 CFR 71, "Packaging and Transportation of Radioactive Material."
19. Except as specifically provided otherwise in this license, the licensee shall conduct its program in accordance with the statements, representations, and procedures contained in the documents, including any enclosures, listed below. The Nuclear Regulatory Commission's regulations shall govern unless the statements, representations, and procedures in the licensee's application and correspondence are more restrictive than the regulations.
- A. Application dated [insert date]
 - B. Letter dated [insert date]

For the U.S. Nuclear Regulatory Commission

Date [Insert issue date]

By [Original signed by (insert reviewer's name)]

[Insert reviewer's name and title]
Nuclear Materials Licensing Branch
Region IV
Arlington, Texas 76011

Appendix F
Information Needed for Transfer of Control
Application

Information Needed for Transfer of Control Application

Licensees must provide full information and obtain NRC's *prior written consent* before transferring control of the license; some licensees refer to this as "transferring the license." Provide the following information concerning changes of control by the applicant (transferor and/or transferee, as appropriate). If any items are not applicable, so state.

1. The new name of the licensed organization. If there is no change, the licensee should so state.
2. The new licensee contact and telephone number(s) to facilitate communications.
3. Any changes in personnel having control over licensed activities (e.g., officers of a corporation) and any changes in personnel named in the license such as radiation safety officer, authorized users, or any other persons identified in previous license applications as responsible for radiation safety or use of licensed material. The licensee should include information concerning the qualifications, training, and responsibilities of new individuals.
4. An indication of whether the transferor will remain in non-licensed business without the license.
5. A complete, clear description of the transaction, including any transfer of stocks or assets, mergers, etc., so that legal counsel is able, when necessary, to differentiate between name changes and transferring control.
6. A complete description of any planned changes in organization, location, facility, equipment, or procedures (i.e., changes in operating or emergency procedures).
7. A detailed description of any changes in the use, possession, location, or storage of the licensed materials.
8. Any changes in organization, location, facilities, equipment, procedures, or personnel that would require a license amendment even without transferring control.
9. An indication of whether all surveillance items and records (e.g., calibrations, leak tests, surveys, inventories, and accountability requirements) will be current at the time of transfer. Provide a description of the status of all surveillance requirements and records.
10. Confirmation that all records concerning the safe and effective decommissioning of the facility, pursuant to 10 CFR 30.35(g), 40.36(f), 70.25(g), and 72.30(d); public dose; and waste disposal by release to sewers, incineration, radioactive material spills, and on-site burials, have been transferred to the new licensee, if licensed activities will continue at the same location, or to the NRC for license termination.
11. A description of the status of the facility. Specifically, the presence or absence of contamination should be documented. If contamination is present, will decontamination occur before transfer? If

APPENDIX F

not, does the successor company agree to assume full liability for the decontamination of the facility or site?

12. A description of any decontamination plans, including financial assurance arrangements of the transferee, as specified in 10 CFR 30.35, 40.36, and 70.25. Include information about how the transferee and transferor propose to divide the transferor's assets, and responsibility for any cleanup needed at the time of transfer.
13. Confirmation that the transferee agrees to abide by all commitments and representations previously made to NRC by the transferor. These include, but are not limited to: maintaining decommissioning records required by 10 CFR 30.35(g); implementing decontamination activities and decommissioning of the site; and completing corrective actions for open inspection items and enforcement actions.

With regard to contamination of facilities and equipment, the transferee should confirm, in writing, that it accepts full liability for the site, and should provide evidence of adequate resources to fund decommissioning; or the transferor should provide a commitment to decontaminate the facility before transferring control.

With regard to open inspection items, etc., the transferee should confirm, in writing, that it accepts full responsibility for open inspection items and/or any resulting enforcement actions; or the transferee proposes alternative measures for meeting the requirements; or the transferor provides a commitment to close out all such actions with NRC before license transfer.

14. Documentation that the transferor and transferee agree to transferring control of the licensed material and activity, and the conditions of transfer; and the transferee is made aware of all open inspection items and its responsibility for possible resulting enforcement actions.
15. A commitment by the transferee to abide by all constraints, conditions, requirements, representations, and commitments identified in the existing license. If not, the transferee must provide a description of its program, to ensure compliance with the license and regulations.

Appendix G

Standard Sealed Source and Device Registration Certificate Format

Standard Registration Certificate Formats

Registry of Radioactive Sealed Sources and Devices
 Safety Evaluation of Sealed Source
 (Amended in its Entirety)

NO.: NR-***-S-***-S

DATE:
PAGE 1 of 5

SOURCE TYPE: *Short description of the source type*

MODEL: ABC

MANUFACTURER/DISTRIBUTOR: *Name*
Street
City, State Zip
(if manufacturer and distributor are the same, keep subheading as shown. If different, delete the word manufacturer from the subheading)

MANUFACTURER: *Name*
Street
City, State Zip
(this subheading and information is not necessary if manufacturer and distributor are the same.)

ISOTOPE:

List Isotopes

MAXIMUM ACTIVITY:

xx millicuries (xx GBq) units should be such that the amount is in the 1 to 999 range

LEAK TEST FREQUENCY:

Not Required
 6 Months

PRINCIPAL USE:

(A) Industrial Radiography from listing in Regulatory Guide 10.11

CUSTOM SOURCE:

Yes No

CUSTOM USER:

Name
Street
City, State Zip
(delete entire subsection if not applicable)

APPENDIX G

REGISTRY OF RADIOACTIVE SEALED SOURCES AND DEVICES
SAFETY EVALUATION OF SEALED SOURCE
(AMENDED IN ITS ENTIRETY)

NO.: NR-***-S-***-S

DATE:
PAGE 2 OF 5

SOURCE TYPE: *Short description of the source type.*

DESCRIPTION: *Provide the complete description of the source.*

LABELING:

The source is engraved with the radiation symbol, isotope, activity, model number, serial number, date of assay, name of the distributor, and the words "CAUTION-RADIOACTIVE MATERIAL". The text is X" (X mm) high and is on the end/side of the source capsule.

DIAGRAM:

Reference all attachments to the document including the total number of attachments.

CONDITIONS OF NORMAL USE:

The source is designed and manufactured for use in measuring. . .

The source may be used in harsh environments but shall not be subjected to environments that exceed its ANSI N542-1977 classification, 77C00000.

PROTOTYPE TESTING:

A prototype of the Model ABC source was constructed and subjected to the tests provided in ANSI N542-1977/ISO 2919 and achieved a classification of 77C00000.

REGISTRY OF RADIOACTIVE SEALED SOURCES AND DEVICES
SAFETY EVALUATION OF SEALED SOURCE
(AMENDED IN ITS ENTIRETY)

NO.: NR-***-S-***-S

DATE:
PAGE 3 OF 5

SOURCE TYPE: *Short description of the source type.*

EXTERNAL RADIATION LEVELS:

The following dose rates were reported by the manufacturer for the Model ABC source containing 1.0 curie (37 GBq) of Am-241:

Table 1

<i>Distance</i>		<i>Maximum Radiation Level</i>			
		<i>From Window</i>		<i>From Sidewall/Back</i>	
<i>(inches)</i>	<i>(cm)</i>	<i>(mR/hr)</i>	<i>(μSv/hr)</i>	<i>(mR/hr)</i>	<i>(μSv/hr)</i>
1.97	5				
11.81	30				
39.37	100				

QUALITY ASSURANCE AND CONTROL:

XXXXXX maintains a quality assurance and control program which has been deemed acceptable for licensing purposes by NRC. A copy of the program is on file with NRC.

LIMITATIONS AND/OR OTHER CONSIDERATIONS OF USE:

- The source shall be distributed to persons specifically licensed by the NRC or an Agreement State.*
- The device shall only be used by the custom user listed in this certificate, XXXXX.*
- Handling, storage, use, transfer, and disposal: To be determined by the licensing authority.*

APPENDIX G

REGISTRY OF RADIOACTIVE SEALED SOURCES AND DEVICES
SAFETY EVALUATION OF SEALED SOURCE
(AMENDED IN ITS ENTIRETY)

NO.: NR-***-S-***-S

DATE:
PAGE 4 OF 5

SOURCE TYPE: *Short description of the source type.*

- *Handling, storage, use, transfer, and disposal: To be determined by the licensing authority. In view that these sources exhibit high dose rates, the sources should be handled by experienced licensed personnel using adequate handling equipment and procedures.*
- *The source shall be leak tested at intervals not to exceed 6 months using techniques capable of detecting 0.005 microcurie (185 Bq) of removable contamination.*
- *The source shall not be subjected to conditions that exceed its ANSI N542-1977 classification, 77C00000.*
- *This registration sheet and the information contained within the references shall not be changed without the written consent of the NRC.*

SAFETY ANALYSIS SUMMARY:

Based on review of the Model ABC sealed source, its ANSI classification, and the information and test data cited below, we {continue to} conclude that the source is acceptable for licensing purposes.

Furthermore, we {continue to} conclude that the source would be expected to maintain its containment integrity for normal conditions of use and accidental conditions which might occur during uses specified in this certificate.

REGISTRY OF RADIOACTIVE SEALED SOURCES AND DEVICES
SAFETY EVALUATION OF SEALED SOURCE
(AMENDED IN ITS ENTIRETY)

NO.: NR-***-S-***-S

DATE:

PAGE 5 OF 5

SOURCE TYPE: *Short description of the source type.*

REFERENCES:

The following supporting documents for the Model ABC sealed source are hereby incorporated by reference and are made a part of this registry document.

- *'s application dated December 25, 0000, with enclosures thereto.*
- *'s letters dated July 4, 1776, and December 25, 0000, with enclosures thereto.*
- *'s facsimiles dated July 4, 1776, and December 25, 0000.*

ISSUING AGENCY:

U.S. Nuclear Regulatory Commission

Date: _____

Reviewer:

Name of 1st Reviewer

Date: _____

Concurrence:

Name of 2nd Reviewer

APPENDIX G

REGISTRY OF RADIOACTIVE SEALED SOURCES AND DEVICES
SAFETY EVALUATION OF DEVICE
(AMENDED IN ITS ENTIRETY)

NO.: NR-***-S-***-S

DATE:
ATTACHMENT 1

REGISTRY OF RADIOACTIVE SEALED SOURCES AND DEVICES
SAFETY EVALUATION OF SEALED SOURCE
(AMENDED IN ITS ENTIRETY)

NO.: NR-***-D-***-X

DATE:
PAGE 1 OF 8

DEVICE TYPE: *Short description of the source type*

MODEL: ABC

MANUFACTURER/DISTRIBUTOR:

Name
Street
City, State Zip
(if manufacturer and distributor are the same, keep
subheading as shown. If different, delete the word
manufacturer from the subheading)

MANUFACTURER:

Name
Street
City, State Zip
(this subheading and information is not necessary if
manufacturer and distributor are the same.)

SEALED SOURCE

MODEL DESIGNATION:

ACME Model 123

ISOTOPE:

List Isotopes

MAXIMUM ACTIVITY:

xx millicuries (xx GBq)
units should be such that the amount is in the 1 to 999 range

LEAK TEST FREQUENCY:

Not Required
6 Months

PRINCIPAL USE:

(A) Industrial Radiography from listing in Regulatory Guide
10.10

CUSTOM DEVICE:

YES No

CUSTOM USER:

Name
Street
City, State Zip
(delete entire subsection if not applicable)

APPENDIX G

REGISTRY OF RADIOACTIVE SEALED SOURCES AND DEVICES
SAFETY EVALUATION OF SEALED SOURCE
(AMENDED IN ITS ENTIRETY)

NO.: NR-***-D-***-X

DATE:
PAGE 2 OF 8

DEVICE TYPE: *Short description of the source type.*

DESCRIPTION:

Provide the complete description of the device and, if necessary, the source(s) used in the device.

LABELING:

The device is labeled in accordance with 10 CFR 20.1901. The labels contain the radiation symbol, isotope, activity, model number, serial number, name of the distributor, and the words "CAUTION-RADIOACTIVE MATERIAL".

When distributed to persons generally licensed, the device is additionally labeled in accordance with 10 CFR 32.51.

The labels are made of stainless steel or aluminum, rectangular in shape, X" x X" (X cm x X cm), and are permanently attached by rivets or screws to the device. A copy of the label is shown in attachment X.

DIAGRAM:

Reference all attachments to the document including the total number of attachments.

CONDITIONS OF NORMAL USE:

The source is designed and manufactured for measuring. . .

The devices are expected to be subjected to environments typically found in laboratories occupied by humans. Since the device is portable, it may experience vibration and shock typical during normal transportation.

The device will only be used by XXXX at their XXXXX CITY, ST facility.

REGISTRY OF RADIOACTIVE SEALED SOURCES AND DEVICES
SAFETY EVALUATION OF SEALED SOURCE
(AMENDED IN ITS ENTIRETY)

NO.: NR-***-D-***-X

DATE:
PAGE 3 OF 8

DEVICE TYPE: *Short description of the device type.*

CONDITIONS OF NORMAL USE (Cont.):

The devices are intended for use in industrial gauging applications. The devices are typically used in industrial process control environments for the measurement of properties of materials in a tank or vessel. The devices are designed for the following environments:

<i>Temperature</i>	<i>-40 °C to 60 °C (-40 °F to 140 °F)</i>
<i>Pressure</i>	<i>Atmospheric</i>
<i>Vibration</i>	<i>Ranges from zero to mild</i>
<i>Corrosion</i>	<i>Ranges from zero to highly corrosive vapors</i>
<i>Fire</i>	<i>NEC Division 2 hazardous area possible</i>
<i>Explosion.</i>	<i>NEC Division 2 hazardous area possible</i>

PROTOTYPE TESTING:

A prototype of the Model XXXX was constructed and subjected to the tests listed below. No malfunction occurred nor was there any loss of shielding or containment integrity.

<i>Temperature</i>	<i>110 °C (230 °F) for a period of seven hours.</i>
<i>Vibration</i>	<i>Approximately 30 cps at an amplitude of 0.03" (0.76 mm) for 90 minutes.</i>
<i>OFF/ON Mechanism</i>	<i>Operated by a pneumatic cylinder for a total of 9320 OFF/ON cycles.</i>
<i>Impact</i>	<i>Dropped three times from a height of 4 feet.</i>
<i>Penetration</i>	<i>Dropped a 13 pound (5.9 kg), 1-1/4" (3.2 cm) diameter steel rod from a height of 40" (102 cm).</i>

APPENDIX G

REGISTRY OF RADIOACTIVE SEALED SOURCES AND DEVICES
SAFETY EVALUATION OF SEALED SOURCE
(AMENDED IN ITS ENTIRETY)

NO.: NR-***-D-***-X

DATE:

PAGE 4 OF 8

DEVICE TYPE: *Short description of the device type.*

PROTOTYPE TESTING (Cont.):

A prototype of the device has been tested in accordance with ANSI/ISO standard ... and has achieved a classification of... The device passed the tests in accordance with the acceptance criteria included in the standard.

The sealed sources used in the device have been tested by their manufacturers and have achieved the following ANSI {N542-1977 or ANSI N5.10-1968} classifications:

<i>Manufacturer</i>	<i>Model</i>	<i>ANSI Classification</i>
<i>Amersham Corporation</i>	<i>AMCL</i>	<i>77C64344</i>
<i>DuPont Merck</i>	<i>NER-465</i>	<i>C33232</i>
<i>Isotope Products Laboratories</i>	<i>PH-55</i>	<i>C33232</i>

The sealed source contained in the device has achieved an ANSI N542-1977 classification of 77C00000.

The sealed source contained in the device has achieved an ANSI N5.10-1968 classification of C00000.

EXTERNAL RADIATION LEVELS:

XXXXXXXXXX reports that the radiation levels from the device are not discernable from background.

XXXXXXXXXX reports that the radiation levels from the device do not exceed 5 mR/hr (50 μ Sv/hr) at 12" (30.5 cm) from the surface of the device.

The following dose rates were reported by the manufacturer for the Model ABC transmission gauge containing a 1.0 curie (37 GBq) of Am-241 sealed source:

REGISTRY OF RADIOACTIVE SEALED SOURCES AND DEVICES
SAFETY EVALUATION OF SEALED SOURCE
(AMENDED IN ITS ENTIRETY)

NO.: NR-***-D-***-X

DATE:
PAGE 5 OF 8

DEVICE TYPE: *Short description of the device type.*

EXTERNAL RADIATION LEVELS (Cont.):

Table 1

<i>Distance</i>		<i>Maximum Radiation Level</i>			
		<i>From Window</i>		<i>From Sidewall/Back</i>	
<i>(inches)</i>	<i>(cm)</i>	<i>(mR/hr)</i>	<i>(mSv/hr)</i>	<i>(mR/hr)</i>	<i>(mSv/hr)</i>
1.97	5				
11.81	30				
39.37	100				

The dose rates were taken with no material present in the measuring area. XXXXXXXX indicates this represents the highest radiation levels of any possible configuration.

QUALITY ASSURANCE AND CONTROL:

XXXXXX maintains a quality assurance and control program which has been deemed acceptable for licensing purposes by NRC. A copy of the program is on file with NRC.

LIMITATIONS AND/OR OTHER CONSIDERATIONS OF USE:

- The device shall be distributed to persons specifically licensed by the NRC or an Agreement State.*
- The device may be distributed to specific or general licensees of NRC or an Agreement State.*
- The device shall be distributed to persons generally licensed by the NRC or an Agreement State.*
- The device shall only be distributed to the custom user, XXXXX.*

APPENDIX G

REGISTRY OF RADIOACTIVE SEALED SOURCES AND DEVICES
SAFETY EVALUATION OF SEALED SOURCE
(AMENDED IN ITS ENTIRETY)

NO.: NR-***-D-***-X

DATE:

PAGE 6 OF 8

DEVICE TYPE: *Short description of the device type.*

LIMITATIONS AND/OR OTHER CONSIDERATIONS OF USE (Cont.):

- *Handling, storage, use, transfer, and disposal: To be determined by the licensing authority.*
- *Handling, storage, use, transfer, and disposal: To be determined by the licensing authority or as required by 10 CFR 31.5 or Agreement State equivalent.*
- *The device shall be leak tested at intervals not to exceed 6 months using techniques capable of detecting 0.005 microcurie (185 Bq) of removable contamination.*
- *The Model XXXXXX sealed source is approved by NRC for use in the Model ABC. The source is not registered on a separate certificate.*
- *The generally licensed user is authorized to perform certain maintenance on the device (see the device operation manual). These services include. . .*
- *REVIEWER NOTE: Neither the distributor nor manufacturer of the device will provide servicing for the device.*
- *This registration sheet and the information contained within the references shall not be changed without the written consent of the NRC.*

SAFETY ANALYSIS SUMMARY:

The distributor has submitted sufficient information to provide reasonable assurance that:

- *The device can be safely operated by persons not having training in radiological protection.*

REGISTRY OF RADIOACTIVE SEALED SOURCES AND DEVICES
SAFETY EVALUATION OF SEALED SOURCE
(AMENDED IN ITS ENTIRETY)

NO.: NR-***-D-***-X

DATE:
PAGE 7 OF 8

DEVICE TYPE: *Short description of the device type.*

SAFETY ANALYSIS SUMMARY (Cont.):

- *Under ordinary conditions of handling, storage, and use of the device, the byproduct material contained in the device will not be released or inadvertently removed from the source housing, and it is unlikely that any person will receive in any period of one year a dose in excess of 10 percent of the limits specified in Section 20.1201(a), 10 CFR Part 20.*
- *Under accident conditions associated with handling, storage, and use of the source housing, it is unlikely that any person would receive an external radiation dose or dose commitment in excess of the dose to the appropriate organ as specified in the following chart:*

<u>PART OF BODY</u>	<u>DOSE</u>
<i>Whole body; head and trunk; active blood-forming organs; gonads; or lens of eye</i>	<i>15 rem (0.15 Sv)</i>
<i>Hands and forearms; feet and ankles; localized areas of skin averaged over areas no larger than 1 cm² (0.15 in²)</i>	<i>200 rem (2.0 Sv)</i>
<i>Other organs</i>	<i>50 rem (0.50 Sv)</i>

Based on review of the Model ABC, and the information and test data cited below, we {continue to} conclude that the device is acceptable for licensing purposes.

Furthermore, we {continue to} conclude that the device would be expected to maintain its containment integrity for normal conditions of use and accidental conditions which might occur during uses specified in this certificate.

APPENDIX G

REGISTRY OF RADIOACTIVE SEALED SOURCES AND DEVICES
SAFETY EVALUATION OF SEALED SOURCE
(AMENDED IN ITS ENTIRETY)

NO.: NR-***-D-***-X

DATE:
PAGE 8 OF 8

DEVICE TYPE: *Short description of the device type.*

REFERENCES:

The following supporting documents for the Model ABC are hereby incorporated by reference and are made a part of this registry document.

- *'s application dated December 25, 0000, with enclosures thereto.*
- *'s letters dated July 4, 1776, and December 25, 0000, with enclosures thereto.*
- *'s facsimiles dated July 4, 1776, and December 25, 0000.*

ISSUING AGENCY:

U.S. Nuclear Regulatory Commission

Date: _____ Reviewer:

Name of 1st Reviewer

Date: _____ Concurrence:

Name of 2nd Reviewer

REGISTRY OF RADIOACTIVE SEALED SOURCES AND DEVICES
SAFETY EVALUATION OF DEVICE
(AMENDED IN ITS ENTIRETY)

NO.: NR-***-D-***-X

DATE:
ATTACHMENT 1

APPENDIX G

REGISTRY OF RADIOACTIVE SEALED SOURCES AND DEVICES
SAFETY EVALUATION OF DEVICE
(AMENDED IN ITS ENTIRETY)

NO.: NR-***-D-***-X

DATE:
ATTACHMENT 2

REGISTRY OF RADIOACTIVE SEALED SOURCES AND DEVICES
 SAFETY EVALUATION OF DEVICE
 (AMENDED IN ITS ENTIRETY)

NO.: NR-***-D-***-E

DATE:

PAGE 1 OF 2

DEVICE TYPE: *Smoke Detector/Gun Sight*

MODEL: *ABC*

MANUFACTURER/DISTRIBUTOR:

*Name
 Street
 City, State Zip
 (if manufacturer and distributor are the same, keep
 subheading as shown. If different, delete the word
 manufacturer from the subheading)*

MANUFACTURER:

*Name
 Street
 City, State Zip
 (this subheading and information is not necessary if
 manufacturer and distributor are the same.)*

SEALED SOURCE

MODEL DESIGNATION:

ACME Model 123

ISOTOPE:

*Americium-241
 Hydrogen-3*

MAXIMUM ACTIVITY:

*1.0 microcurie (37 kBq)
 60 millicuries (2.2 GBq)*

LEAK TEST FREQUENCY:

Not Required

PRINCIPAL USE:

*(P) Ion Generator, Smoke Detectors
 (W) Self-Luminous Light Sources*

CUSTOM DEVICE:

Yes No

APPENDIX G

REGISTRY OF RADIOACTIVE SEALED SOURCES AND DEVICES
SAFETY EVALUATION OF DEVICE
(AMENDED IN ITS ENTIRETY)

NO.: NR-***-D-***-E

DATE:
PAGE 2 OF 2

DEVICE TYPE: *Smoke Detector/Gun Sight*

DESCRIPTION:

Provide a concise, basic description of the device and if more than one model is registered, provide the differences between models.

REFERENCES:

The following supporting documents for the Model ABC smoke detectors/gun sights are hereby incorporated by reference and are made a part of this registry document.

- *'s application dated December 25, 0000, with enclosures thereto.*
- *'s letters dated July 4, 1776, and December 25, 0000, with enclosures thereto.*
- *'s facsimiles dated July 4, 1776, and December 25, 0000.*

ISSUING AGENCY:

U.S. Nuclear Regulatory Commission

Date: _____

Reviewer:

Name of 1st Reviewer

Date: _____

Concurrence:

Name of 2nd Reviewer

Appendix H

Criteria for Acceptable Training and Experience for Authorized Users

Criteria for Acceptable Training and Experience for Authorized Users

Classroom Training

Classroom training may be in the form of lecture, videotape, or self-study that emphasize practical subject matter important to the safe handling of licensed materials. Duration and technical level of training should be commensurate with the expected hazards encountered during routine and emergency conditions.

Frequency of Training

- Before assuming duties with, or in the vicinity of, radioactive materials;
- Whenever there is a significant change in duties, regulations, or the terms and conditions of the license;
- Annually for refresher training.

Suggested Radiation Safety Topics:

- Fundamentals of Radiation Safety:
 - Characteristics of radiation;
 - Units of radiation dose and quantity of radioactivity;
 - Hazards of exposure to radiation;
 - Levels of radiation from licensed material;
 - Methods of controlling radiation dose (time, distance, and shielding);
 - ALARA concept.
- Radiation Detection Instruments:
 - Operation,
 - Calibration,
 - Limitations of radiation survey instruments,
 - Radiation survey techniques for measuring radiation field ,
 - Radiation survey techniques for measuring removable/fixed contamination,
 - Handling and proper use of personnel monitoring equipment.

APPENDIX H

- Radiation Protection Equipment and Use:
 - Proper use of protective equipment;
 - Decontamination of contaminated protection equipment.
- NRC regulations (10 CFR 19 and 20);
- NRC regulations (10 CFR 31, 32, 34, 35, 36, 39, 40, 70, and 71) as applicable;
- Licensee's operating and emergency procedures;
- Case histories relevant to operations;
- Course Examination (Didactic)
 - Successful completion of closed-book written/oral examination depending on the complexity and hazards of authorized activities.
 - Review of incorrect answers with student.
- On-the Job Training and Examination (Practical):
 - On-the-job training done under the supervision of a qualified individual (AU, RSO, or manufacturer's representative authorized by the NRC or an Agreement State) that includes supervised hands-on experience performing the task authorized on the license that are commensurate with the expected hazards during routine and emergency conditions.
 - Practical examination consisting of an assessment by the RSO to ensure that each proposed AU is qualified to work independently and that each individual is knowledgeable of the radiation safety aspects of licensed activities. This may be demonstrated by observing the proposed AU perform licensed activities.
- Discussion and/or drill on emergency procedures
- Retraining on areas found to be deficient in both the practical and didactic areas.

Classroom Course Instructor Qualifications

The person conducting the training should be a qualified individual (e.g., a person who meets the qualifications for RSO or authorized user on the license and is familiar with the licensee's program). Instructors who provide classroom training to individuals in the principles of radiation and radiation safety should have knowledge and understanding of these principles beyond those obtainable in a course similar to the one given to prospective authorized users. Individuals who provide instruction in the hands-on use of licensed materials should have training and experience that would qualify them to be authorized users, or should possess a thorough understanding of the licensee operations.

Appendix I
Suggested [Specific Program] Audit
Checklist

Sample Checklist

Audit Report No. _____ License No. _____

Audit of activities at (Address/Facility): _____

Contact at Audit Location _____ Telephone No. _____

Date of this Audit _____

Summary of Findings and Action:

- No deficiencies
- Deficiencies
- Inadequate action on previous deficiencies__

Recommendations:

Auditor: _____ Date: _____
(Signature)

APPENDIX I

1. AUDIT HISTORY N/A (N/A means "Not applicable"—Initial Audit)

a. Last audit of this location conducted on: _____

b. Problems/deficiencies identified during last two audits or two years, whichever is longer

Y N

c. Open problems/deficiencies from the previous audits:

Problem/Deficiency	Corrective Action Taken (Y/N)	Status (Open/Closed)
--------------------	----------------------------------	-------------------------

d. Any previous problem/deficiency not corrected or repeated

Y N

N/A

Explain:

2. ORGANIZATION AND SCOPE OF PROGRAM

a. Briefly describe organizational structure

b. Structure is as described in license documents

Y N

c. Multiple authorized locations of use listed on license

Y N

d. Briefly describe scope of activities involving byproduct material, frequency of use, staff size, etc.

e. Radiation Safety Officer:

Authorized on license

Y N

Fulfills duties as RSO

Y N

f. Use only by authorized individuals

Y N

Remarks:

3. TRAINING, RETRAINING, AND INSTRUCTIONS TO WORKERS
- a. Instructions to workers per [10 CFR 19.12] Y N
- b. Training program implemented as required [L/C] Y N
- c. Training records maintained [L/C] Y N
- d. Evaluation of individuals' understanding of procedures and requirements based on interviews, observation of selected workers was performed Y N
- If so,:
- Each has an up-to-date copy of the licensee's safe use and emergency procedures, Y N
- Adequate understanding of:
- Current safe use procedures Y N
- Emergency procedures Y N
- e. 10 CFR Part 20
- Workers cognizant of requirements for:
- Radiation Safety Program [20.1101] Y N
- Annual dose limits [20.1301, 20.1302] Y N
- NRC Forms 4 and 5 Y N
- 10% monitoring threshold [20.1502] Y N
- Dose limits to embryo/fetus and declared pregnant women [20.1208] Y N
- Procedures for opening packages [20.1906] Y N
- Remarks:
4. INTERNAL AUDITS, REVIEWS OR INSPECTIONS
- a. Content and implementation of the radiation protection program reviewed annually [20.1101(c)] Y N
- b. Records maintained [20.2102] Y N
- Remarks:
5. FACILITIES
- a. Facilities as described in license documents Y N
- b. Access to restricted area/licensed material in accordance with 20.1801, 20.1802 Y N
- Remarks:

APPENDIX I

6. SELF-CONTAINED DRY-SOURCE STORAGE IRRADIATORS AND/OR SURVEY INSTRUMENT CALIBRATORS N/A

- a. Describe model, radionuclide, activity, use frequency, etc.

 - b. Operating & emergency (O&E) procedures readily available [L/C] Y N
 - c. Users trained on, and follow O&E procedures Y N
 - d. Maintenance of safety-related components by authorized persons [L/C] Y N
 - e. Access to keys and/or material adequately controlled [L/C, 20.1801, 20.1802] Y N
 - f. Access to high/very high radiation areas controlled per 20.1601, 20.1602, L/C Y N
 - g. Compliance with 20.1301 evaluated [20.1302] Y N
 - h. Adequate protection of shield (lead) integrity, fire protection [L/C] Y N
- Remarks:

7. MATERIALS

- Isotopes, quantities, and use as authorized on license Y N
- Remarks:

8. LEAK TESTS

- a. Leak test performed as described in correspondence with NRC (consultant; leak test kit; licensee performed) Y N
 - b. Frequency: every 6 months or other interval, as approved by NRC or Agreement State Y N
 - c. Records with appropriate information maintained Y N
- Remarks:

9. INVENTORIES

- a. Conducted at 6-month intervals [L/C] Y N
 - b. Records with appropriate information maintained Y N
- Remarks:

10. RADIATION SURVEYS

- a. Instruments and Equipment:
 - Appropriate operable survey instrumentation possessed or readily available [L/C] Y N
 - Calibrated as required [20.1501] Y N
 - Calibration records maintained [20.2103(a)] Y N

b. Briefly describe survey requirements [20.1501(a)]:

- c. Performed as required [20.1501(a)] Y N
 Radiation levels within regulatory limits Y N
 Corrective action taken and documented Y N
 N/A
 d. Records maintained [20.2103] Y N

e. Protection of members of the public:

Adequate surveys made to demonstrate either (a) that the TEDE to the individual likely to receive the highest dose does not exceed 100 mrem in a year, or (b) that if an individual were continuously present in an unrestricted area, the external dose would not exceed 2 mrem in any hour and 50

mrem in a year [20.1301(a)(1), 20.1302(b)] Y N

Unrestricted area radiation levels do not exceed 2 mrem in any 1 hour [20.1301(a)(2)] Y N

Records maintained [20.2103, 20.2107] Y N

Remarks:

11. RECEIPT AND TRANSFER OF RADIOACTIVE MATERIAL

a. Describe how packages are received and by whom:

b. Written package opening procedures established and followed [20.1906(e), (b)(1-3), (c)]

Y N

c. Transfer(s) between licensees performed per [30.41]

Y N

N/A

d. Records of receipt/transfer maintained [20.2103(a), 30.51]

Y N

e. Transfers within licensee's authorized users or locations performed as required [L/C]

Y N

N/A

f. Package receipt/distribution activities evaluated for compliance with 20.1301 [20.1302]

Y N

N/A

Remarks:

12. TRANSPORTATION (10 CFR 71.5(a) and 49 CFR 170-189)

N/A

a. Licensee shipments are:

Delivered to common carriers

Y N

N/A

Transported in licensee's own private vehicle

Y N

N/A

APPENDIX I

- No shipments since last audit Y N
 - b. Packages N/A
 - Authorized packages used [173.415, 416(b)] Y N
 - N/A
 - Closed and sealed during transport [173.475(f)] Y N
 - Properly labeled and marked [172.403, 173.441, 173.200] Y N
 - c. Shipping Papers N/A
 - Prepared and used [172.200(a)] Y N
 - Proper { Shipping Name, Hazard Class, UN Number, Quantity, Package Type, Nuclide, RQ, Radioactive Material, Physical and Chemical Form, Activity, Category of Label, TI, Shipper's Name, Certification and Signature, Emergency Response Phone Number, "Cargo Aircraft Only" (if applicable) } [172.200-204] Y N
 - Readily accessible during transport [177.718(e)] Y N
 - d. Vehicles N/A
 - Cargo blocked and braced [177.842(d)] Y N
 - Placarded, if needed [172.504] Y N
 - Proper overpacks, if used (shipping name, UN Number, labeled, statement indicating that inner package complies with specification package) [173.25] Y N
 - N/A
 - e. Any incidents reported to DOT [171.15, 171.16] Y N
 - f. HAZMAT training per 172.700-704 Y N
- Remarks:

13. PERSONNEL RADIATION PROTECTION

- a. ALARA considerations are incorporated into the Radiation Protection Program [20.1101(b)] Y N
- b. Adequate documentation of determination that unmonitored occupationally individuals are not likely to receive >10% of allowable limit [20.1502(a)] Y N
- N/A
- OR
- c. External dosimetry required and used Y N
- N/A
- Supplier: Frequency:
- Supplier is NVLAP-approved [20.1501(c)] Y N
- Dosimeters exchanged at required frequency [L/C] Y N
- d. Occupational intake monitored and assessed [20.1502(b)] Y N
- N/A
- e. Reports: N/A
- Reviewed by: Frequency:
- Auditor reviewed personnel monitoring records for period _____ to _____.
- Prior dose determined for individuals likely to receive doses [20.2104] Y N
- Maximum exposures TEDE: Other:

- f. NRC Forms or equivalent [20.2104(d), 20.2106(c)]: NRC-4 "Cumulative Occupational Exposure History" Complete: Y N
 NRC-5 "Occupational Exposure Record for a Monitoring Period" Complete: Y N
- g. Worker declared her pregnancy in writing during audit period (review records) Y N
 N/A
 If yes, determine compliance with [20.1208] Y N
 and check for records per [20.2106(e)] Y N
- h. Records of exposures, surveys, monitoring, and evaluations maintained [20.2102, 20.2103, 20.2106, L/C] Y N
- i. Pocket dosimeters and/or alarming ratemeters [L/C]: N/A
 Possessed and used as required Y N
 Operable and calibrated/checked at required frequency Y N
 Records maintained Y N
 N/A
- j. Safety interlocks, area monitors and alarms [L/C]:
 Found operational Y N
 Tested at required frequency Y N
 Records maintained Y N

Remarks:

14. AUDITOR'S INDEPENDENT MEASUREMENTS (IF MADE)

Survey instrument	Serial No.	Last calibration
-------------------	------------	------------------

Auditor's measurements compared to licensee's Y N
 Describe the type, location, and results of measurements:

15. RADIOACTIVE EFFLUENTS, WASTE MANAGEMENT AND DISPOSAL

- a. Waste disposed of by decay-in-storage (DIS): N/A
 Procedure for DIS disposal approved by license condition Y N
 Disposal by DIS in accordance with L/C Y N
 Licensee in compliance with 20.1501 and 20.1904(b) Y N
 Records maintained [20.2103(a), L/C] Y N

Remarks:

APPENDIX I

- b. Licensed material released into sanitary sewerage: N/A
 Material is readily soluble (or is readily dispersible biological material) in water [20.2003(a)(1)] Y N
 Monthly average release concentrations do not exceed Appendix B values [20.2003(a)(2,3)] Y N
 No more than 5 curies of tritium, 1 curie of carbon-14 and 1 curie of all other radionuclides combined were released in a year [20.2003(a)(4)] Y N
 Procedures for ensuring adequate sample representativeness and analysis properly implemented [20.1501, L/C] Y N
 Records maintained [20.2108] Y N

Remarks:

- c. Waste disposed of by incineration: N/A
 License authorizes incineration [20.2004(a)(3)] Y N
 If licensee directly monitors incinerator exhaust, the monitor sample is representative and the monitoring instrumentation is operational and properly calibrated [20.1501] Y N
 N/A
 If licensee calculates exhaust concentrations, incinerator airflow and activities incinerated are accurately known, and the calculations are correct [20.1501] Y N
 N/A
 Management of effluents and ashes in accordance with 20.1301, 20.1201, 20.1501, 20.2001 and L/C Y N
 Records maintained [20.2108] Y N

Remarks:

- d. Disposal of liquid scintillation (LS) media and/or animal carcasses: N/A
 Licensee disposes of LS media and carcasses contaminated with only H-3 or C-14, and at a concentration not exceeding 0.05 uCi/g per 20.2005 Y N
 Records maintained [20.2108] Y N

Remarks:

- e. Transfers for disposal at land disposal facilities: N/A
 Waste transferred to person specifically licensed to receive waste [30.41, 20.2001(b)] Y N
 Each shipment accompanied by a shipment manifest prepared as specified in Section I of Appendix F [20.2006(b) and App. F.III.A.4] Y N
 Shipment manifests certified as specified in Section II of Appendix F [20.2006(c)] Y N
 Compliance with Section III of Appendix F [20.2006(d)]:
 Note: The licensee's waste is likely to be Class A waste not packaged for disposal in cardboard or

- fiberboard boxes [61.56(a)] Y N
 Liquid wastes solidified [61.56(a)] Y N
 Volume of solid wastes contain less than 1% freestanding liquid Y N
 Waste does not generate harmful vapors [61.56(a)] Y N
 Waste structurally stable, i.e., will maintain its physical dimensions and form under expected disposal conditions [61.56(b)] Y N
 Void spaces within the waste and between the waste and its package minimized [61.56(b)] Y N
 Waste packages labeled to identify their proper class [App. F.III.A.2] Y N
 Licensee conducts a QC program to ensure compliance with 61.55 and 61.56, and which includes management evaluation of audits [App. F.III.A.3] Y N
 For shipments not acknowledged by recipient within 20 days after transfer, incident investigated and reported [App. F.III.A.8] Y N
 N/A
 Records maintained [20.2108] Y N
 Remarks:
- f. Special disposal procedures and other effluents (e.g., hood exhausts, special dilutions, etc.): N/A
 Performed in accordance with L/C Y N
 Appropriate surveys conducted [20.1501, L/C] Y N
 Operations comply with 20.1201 and 20.1301 Y N
 Special disposals per 20.2001 and 20.2002, i.e., no improper/unauthorized disposals were noted Y N
 Y N
 Records maintained [20.2108] Y N
 Remarks:
- g. Waste compaction operations: N/A
 Airborne releases evaluated and controlled [20.1501, 20.1701, L/C] Y N
 Internal exposures evaluated and controlled [20.1501, 20.1204, 20.1702, 20.1703, 20.1201] Y N
 Y N
 Compliance with 20.1301 evaluated [20.1302] Y N
 Remarks:
- h. Waste storage areas: N/A
 Adequate protection from the elements (floods, tornadoes, hurricanes, etc.) and fire [L/C] Y N
 Adequate control of waste in storage [20.1801] Y N
 Containers properly labeled and area properly posted [20.1902, 20.1904] Y N

APPENDIX I

- Package integrity adequately maintained [L/C] Y N
Adequate records of surveys and material accountability are maintained [20.2103, 20.2108] Y N
16. NOTIFICATION AND REPORTS N/A
- a. Licensee in compliance with [19.13, 30.50] (reports to individuals, public and occupational, monitored to show compliance with Part 20) Y N
 N/A
- b. Licensee in compliance with [20.2201, 30.50] (theft or loss) Y N
 None
- c. Licensee in compliance with [20.2202, 30.50] (incidents) Y N
 None
- d. Licensee in compliance with [20.2203, 30.50] (overexposures and high radiation levels) Y N
 None
- e. Licensee aware of telephone number for NRC Emergency Operations Center [(301) 816-5100] Y N
17. POSTING AND LABELING
- a. NRC-3 "Notice to Workers" is posted [19.11] Y N
- b. Parts 19, 20, 21, Section 206 of Energy Reorganization Act, procedures adopted pursuant to Part 21, and license documents are posted, or a notice indicating where documents can be examined is posted [19.11, 21.6] Y N
- c. Other posting and labeling per [20.1902, 1904] and the licensee is not exempted by [20.1903, 1905] Y N
- Remarks:
18. RECORD KEEPING FOR DECOMMISSIONING N/A
- a. Records of information important to the safe and effective decommissioning of the facility maintained in an independent and identifiable location until license termination Y N
- b. Records include all information outlined in [30.35(g)] Y N
- Remarks:
19. BULLETINS AND INFORMATION NOTICES
- a. Receipt of NRC Bulletins, NRC Information Notices, NMSS Newsletters, etc. Y N
- b. Appropriate action taken in response to Bulletins, Information Notices, etc. Y N
- Remarks:

20. SPECIAL LICENSE CONDITIONS OR ISSUES

 N/A

a. Review special license conditions, site-specific procedures or safety issues or other issues, and describe findings:

b. Problems/deficiencies identified at licensee facilities other than at audit location:

c. Evaluation of compliance:

21. CONTINUATION OF REPORT ITEMS

 N/A

(If more space is needed, use separate sheets and attach to report.)

22. PROBLEMS OR DEFICIENCIES NOTED AND RECOMMENDATIONS

 N/A

Note: Briefly state (1) the requirement and (2) how and when violated. Provide recommendations for improvement.

23. EVALUATION OF OTHER FACTORS

a. Senior licensee management is appropriately involved with the radiation safety program and/or Radiation Safety Officer (RSO) oversight Y N

b. RSO has sufficient time to perform his/her radiation safety duties and is not too busy with other assignments Y N

c. Licensee has sufficient staff Y N

APPENDIX I

Note: All areas indicated in audit notes may not be applicable to every license and may not need to be addressed during each audit. For example, licensees do not need to address areas that do not apply to the licensee's activities and activities that have not occurred since the last audit need not be reviewed at the next audit.

Date of This Audit _____ Date of Last Audit _____
Next Audit Date _____

Auditor _____ Date _____
(Signature)

Management Review _____ Date _____
(Signature)

Appendix J

Radiation Monitoring Instrument Specifications and Model Survey Instrument Calibration Program

Radiation Monitoring Instrument Specifications

The specifications in Table J.1³ will help applicants and licensees choose the proper radiation detection equipment for monitoring the radiological conditions at their facilities or job sites.

Table J.1 Typical Survey Instruments⁴

Portable Instruments Used for Contamination and Ambient Radiation Surveys			
Detectors	Radiation	Energy Range	Efficiency
Exposure Rate Meters	Gamma, X-Ray	μ R-R	N/A
Count Rate Meters			
GM	Alpha	All energies (dependent on window thickness)	Moderate
	Beta	All energies (dependent on window thickness)	Moderate
	Gamma	All energies	< 1%
NaI Scintillator	Gamma	All energies (dependent on crystal thickness)	Moderate
Plastic Scintillator	Beta	C-14 or higher (dependent on window thickness)	Moderate
Stationary Instruments Used to Measure Wipe, Bioassay, and Effluent Samples			
Detectors	Radiation	Energy Range	Efficiency
LSC*	Alpha	All energies	High
	Beta	All energies	High
	Gamma		Moderate
Gamma Counter (NaI)*	Gamma	All energies	High
Gas Proportional	Alpha	All energies	High
	Beta	All energies	Moderate
	Gamma	All energies	< 1%

³ Table from The Health Physics & Radiological Health Handbook, Revised Edition, Edited by Bernard Shleien, 1992 (except for * items).

⁴ Instruments used to measure radiological conditions at licensed facilities.

Model Instrument Calibration Program

Training

Before allowing an individual to perform survey instrument calibrations, the RSO will ensure that he or she has sufficient training and experience to perform independent survey instrument calibrations.

Classroom training may be in the form of lecture, videotape, or self-study and will cover the following subject areas:

- Principles and practices of radiation protection
- Radioactivity measurements, monitoring techniques, and using instruments
- Mathematics and calculations basic to using and measuring radioactivity
- Biological effects of radiation.

Appropriate on-the-job training consists of the following:

- Observing authorized personnel performing survey instrument calibration
- Conducting survey meter calibrations under the supervision and in the physical presence of an individual authorized to perform calibrations.

Facilities and Equipment for Calibration of Dose Rate or Exposure Rate Instruments

- To reduce doses received by individuals not calibrating instruments, calibrations will be conducted in an isolated area of the facility or at times when no one else is present.
- Individuals conducting calibrations will wear assigned dosimetry
- Individuals conducting calibrations will use a calibrated and operable survey instrument to ensure that unexpected changes in exposure rates are identified and corrected.

Model Procedure for Calibrating Survey Instruments

A radioactive sealed source(s) used for calibrating survey instruments will:

- Approximate a point source
- Have its apparent source activity or the exposure rate at a given distance traceable by documented measurements to a standard certified to be within $\pm 5\%$ accuracy by National Institutes of Standards and Technology (NIST)
- Approximate the same energy and type of radiation as the environment in which the calibrated device will be employed or develop energy curves to compensate for differing energies

- For dose rate and exposure rate instruments, the source should be strong enough to give an exposure rate of at least about 7.7×10^{-6} coulombs/kilogram/hour (30 mR/hr) at 100 cm [e.g., 3.1 gigabecquerels (85mCi) of cesium-137 or 7.8×10^2 megabecquerels (21 mCi) of cobalt-60]

The three kinds of scales frequently used on dose or dose rate survey meters are calibrated as follows:

- Linear readout instruments with a single calibration control for all scales should be adjusted at the point recommended by the manufacturer or at a point within the normal range of use. Instruments with calibration controls for each scale should be adjusted on each scale. After adjustment, the response of the instrument should be checked at approximately 20% and 80% of full scale. The instrument's readings should be within $\pm 15\%$ of the conventionally true values for the lower point and $\pm 10\%$ for the upper point.
- Logarithmic readout instruments, which commonly have a single readout scale spanning several decades, normally have two or more adjustments. The instrument should be adjusted for each scale according to site specifications or the manufacturer's specifications. After adjustment, calibration should be checked at a minimum of one point on each decade. Instrument readings should have a maximum deviation from the conventionally true value of no more than 10% of the full decade value.
- Meters with a digital display device shall be calibrated the same as meters with a linear scale.
- Readings above 2.58×10^{-4} coulomb/kilogram/hour (1 R/hr) need not be calibrated, but such scales should be checked for operation and response to radiation.
- The inverse square and radioactive decay laws should be used to correct changes in exposure rate due to changes in distance or source decay.

Surface Contamination Measurement Instruments⁵

- A survey meter's efficiency must be determined by using radiation sources with similar energies and types of radiation that the survey instrument will be used to measure or develop energy curves to compensate for differing energies.
- If each scale has a calibration potentiometer, the reading should be adjusted to read the conventionally true value at approximately 80% of full scale, and the reading at approximately 20% of full scale should be observed. If only one calibration potentiometer is available, the reading should be adjusted at mid-scale on one of the scales, and readings on the other scales should be observed. Readings should be within 20% of the conventionally true value.

Model Procedures for Calibrating, Liquid Scintillation Counters, Gamma Counters, Gas Flow Proportional Counters, and Multichannel Analyzers

A radioactive sealed source used for calibrating instruments will do the following:

⁵ 2ANSI N323A-1997, "Radiation Protection Instrumentation Test and Calibration."

APPENDIX J

- Approximate the geometry of the samples to be analyzed
- Have its apparent source activity traceable by documented measurements to a standard certified to be within $\pm 5\%$ accuracy by National Institutes of Standards and Technology (NIST)
- Approximate the same energy and type of radiation as the samples that the calibrated device will be used to measure.

Calibration

- Calibration of survey instruments used in assessing dose or exposure rates must be conducted at 6 to 12 month intervals or after instrument servicing.
- Calibration must produce readings within ± 20 per cent of the actual values over the range of the instrument.
- Calibration of liquid scintillation counters will include quench correction.

Calibration Reports

Calibration reports, for all survey instruments, will indicate the procedure used and the data obtained. The description of the calibration will include:

- The owner or user of the instrument
- A description of the instrument, including the manufacturer's name, model number, serial number, and type of detector
- A description of the calibration source, including the exposure rate at a specified distance or activity on a specified date
- For each calibration point, the calculated exposure rate or count rate, the indicated exposure rate or count rate, the deduced correction factor (the calculated exposure rate or count rate divided by the indicated exposure rate or count rate), and the scale selected on the instrument
- For instruments with external detectors, the angle between the radiation flux field and the detector (i.e., parallel or perpendicular)
- For instruments with internal detectors, the angle between radiation flux field and a specified surface of the instrument
- For detectors with removable shielding, an indication whether the shielding was in place or removed during the calibration procedure
- The exposure rate or count rate from a check source, if used
- The name of the person who performed the calibration and the date it was performed.

The following information should be attached to the instrument as a calibration sticker or tag:

- For exposure rate meters, the source isotope used to calibrate the instrument (with correction factors) for each scale

- The efficiency, of the instrument, for each isotope the instrument will be used to measure (if efficiency is not calculated before each use)
- For each scale or decade not calibrated, an indication that the scale or decade was checked only for function but not calibrated
- The date of calibration and the next calibration due date
- The apparent exposure rate or count rate from the check source, if used.

References: See the Notice of Availability on the inside front cover of this draft report to obtain a copy of::

1. Draft Regulatory Guide FC 413-4, "Guide for the Preparation of Applications for Licenses for the Use of Radioactive Materials in Calibrating Radiation Survey and Monitoring Instruments," dated June 1985.

Additional References:

2. "The Health Physics & Radiological Health Handbook, Revised Edition," edited by Bernard Shleien, dated 1992.
3. ANSI N323A-1997, "Radiation Protection Instrumentation Test and Calibration." Copies may be obtained from the American National Standards Institute, 1430 Broadway, New York, NY 10018 or ordered electronically at the following address: <<http://www.ansi.org>>.

Appendix K

Material Ordering and Package Receipt and Opening

Sample Model Procedure for Ordering and Receiving Radioactive Material

The RSO should approve or place all orders for radioactive material and should ensure that the requested material, quantities, manufacturer, and model are authorized by the license and that the possession limits are not exceeded.

During normal working hours, carriers should be instructed to deliver radioactive packages directly to the Radiation Safety Office (or designated receiving area). During off-duty hours, security or other designated trained personnel should accept delivery of radioactive packages in accordance with the procedure outlined in the sample memorandum below:

Sample Memorandum

Memorandum for Security Personnel

From: RSO, Management Representative, etc.

Subject: Procedures for Receipt of Packages Containing Radioactive Material

If the package appears to be damaged, immediately contact the RSO. Ask the carrier to remain at the facility until it can be determined that neither the carrier nor the vehicle is contaminated.

Any packages containing radioactive material that arrive between (state times, e.g., 4:30 p.m. and 7:00 a.m. or on Saturdays or Sundays) shall be signed for by the security guard (or other designated trained individual) on duty and taken immediately to the designated receiving area. Security personnel (or other designated trained individual) should unlock the door, place the package in the designated secured storage area and re-lock the door.

Radiation Safety Officer (RSO):

Office Phone:

Home Phone:

Sample Instructions to Personnel Involved in Material Receipt

During normal working hours, immediately upon receipt of any package of licensed material, each package must be visually inspected for any signs of shipping damage such as crushed or punctured containers or signs of dampness. Any obvious damage must be reported to the RSO immediately. Do not touch any package suspected of leaking. Request the person delivering the package to remain until monitored by the RSO.

Outside of normal working hours (e.g., nights, weekends, and holidays), deliveries will usually be handled by security personnel (or other trained individuals) as described in the above procedures. Since certain packages of licensed material will have detectable external radiation, they should be sent immediately to a designated storage area, where they will be

APPENDIX K

checked for contamination and external radiation level as soon as practical. They should not be allowed to remain in the receiving area any longer than necessary, as they may be a source of exposure for receiving personnel.

If the instructions are not clear, or if there are questions regarding receiving packages containing radioactive material, please contact:

Name:

Phone:

For additional information on worker training, see the section entitled Training for Individuals Working In or Frequenting Restricted Areas.

Sample Model Procedure for Safely Opening Packages Containing Licensed Materials

For packages received under the specific license, authorized individuals shall implement procedures for opening each package, as follows:

- Wear gloves to prevent hand contamination.
- Visually inspect the package for any sign of damage (e.g. crushed, punctured). If damage is noted, stop and notify the RSO.
- Check DOT White I, Yellow II, or Yellow III label or packing slip for activity of contents, so shipment does not exceed license possession limits.
- Monitor the external surfaces of a labeled package according to specifications in Table 8.4, Section 13.14, Item 10.
- Open the outer package (following supplier's directions if provided) and remove packing slip. Open inner package to verify contents (compare requisition, packing slip and label on the bottle or other container). Check integrity of the final source container (e.g., inspecting for breakage of seals or vials, loss of liquid, discoloration of packaging material, high count rate on smear). Again check that the shipment does not exceed license possession limits. If you find anything other than expected, stop and notify the RSO.
- Survey the packing material and packages for contamination before discarding. If contamination is found, treat as radioactive waste. If no contamination is found, obliterate the radiation labels prior to discarding in the regular trash.
- Maintain records of receipt, package survey, and wipe test results.
- Notify the final carrier and by telephone, telegram, mailgram, or facsimile, the Administrator of the appropriate NRC Regional Office listed in 10 CFR 20, Appendix D when removable radioactive

surface contamination exceeds the limits of 10 CFR 71.87(I); or external radiation levels exceed the limits of 10 CFR 71.47.

Sample Transfer Policy Statement

Licensed material shall not be transferred or shipped from one licensee to another without the approval of the RSO. Such transfers/shipments must be packaged and labeled in accordance with DOT, NRC, or U.S. Postal Service Regulations, whichever is applicable. If licensed material is possessed at a customer's facility incident to performing services, this material will not be transferred to us unless we will be preparing it to be shipped AND will be the shipper of record (i.e., signing the Shipper's Certification on the shipping paper).

Appendix L

Guidance for Demonstrating that Unmonitored Individuals Are Not Likely to Exceed 10 Percent of the Allowable Limits

Guidance for Demonstrating that Unmonitored Individuals Are Not Likely to Exceed 10 Percent of the Allowable Limits

Dosimetry is required for individual adults who are likely to receive in 1 year an occupational dose from sources external to the body in excess of 10% of the applicable regulatory limits in 10 CFR 20.1201. In instances where pocket chambers are used instead of film badges or TLDs to assess radiation dosage of personnel, a check of the response of the dosimeters to radiation should be made every 12 months. Acceptable pocket dosimeters should read within plus or minus 20% of the true radiation dose. To demonstrate to the NRC that dosimetry is not required for ancillary personnel, a licensee needs to have available an evaluation demonstrating that these nonmonitored workers are not likely to exceed 10% of the applicable annual limits specified in 10 CFR 20.1201.

A licensee will need to conduct an evaluation of doses occupationally exposed workers could receive in performing tasks involving the handling of radioactive materials to assess the need for dosimetry.

Example: A radiation measurement of the work area indicates a dose rate of 0.015 mSv/hr (1.5 mrem/hr). Service personnel are not expected to spend more than a total of 3 hours per week at the location of the measurement. Based on this measured dose rate, the annual dose is expected to be less than 2.34 mSv (234 mrem). Specifically, $3 \text{ hr/wk} \times 1.5 \text{ mrem/hr} \times 52 \text{ wk/yr} = 234 \text{ mrem}$. Based on the above, if any service personnel work in the area less than 6.4 hours per week, no dosimetry is required.

Note: 6.4 hours is the total number of hours it would take for an individual to meet the 5 mSv (500 millirems) per year limit.

Appendix M

Guidance for Demonstrating that Individual Members of the Public will not Receive Doses Exceeding the Allowable Limits

Guidance for Demonstrating that Individual Members of the Public will not Receive Doses Exceeding the Allowable Limits

This appendix describes methods for determining radiation doses to members of the public. Licensees must ensure that:

- The radiation dose received by individual members of the public does not exceed 1 millisievert (mSv) [100 millirem (mrem)] in one calendar year resulting from the licensee's possession and/or use of licensed materials.
- The radiation dose in unrestricted areas does not exceed 0.02 mSv (2 mrem) in any one hour.

Members of the public include persons who live, work, study, or may be near locations where byproduct material is used or stored and employees whose assigned duties do not include the use of byproduct material but may work in the vicinity where such materials are used or stored.

Doses to Members of the Public

INCLUDES doses from:	DOES NOT INCLUDE doses from:
<ul style="list-style-type: none"> • Radiation and/or radioactive material released by a licensee • Sources of radiation under the control of a licensee • Air effluents from sources of licensed radioactive materials 	<ul style="list-style-type: none"> • Sanitary sewerage discharges from licensees • Natural background radiation • Medical administration of radioactive material • Voluntary participation in medical research

Typical unrestricted areas may include offices, shops, laboratories (where licensed material is not used or stored), areas outside buildings, property, and storage areas. The licensee does not control access to these areas for purposes of controlling exposure to radiation or radioactive materials, but the licensee may control access to these areas for other reasons, such as security.

The licensee may show compliance with the annual dose limit for individual members of the public by:

- Demonstrating by measurement or calculation that the TEDE to the individual likely to receive the highest dose at the boundary of the unrestricted area does not exceed 1 mSv (100 mrem)
- Demonstrating that the annual average concentration of radioactive material released in gaseous and liquid effluents at the boundary of the unrestricted area does not exceed the values specified in Table 2 of Appendix B to Part 20; and if an individual were continuously present in an unrestricted area the dose from external sources would not exceed 0.02 mSv (2 mrem) in an hour and 0.5 mSv (0.05 rem) in a year.

APPENDIX M

- Demonstrating that air emissions of radioactive materials do not result in doses greater than the constraint limit of 0.1mSv (10 mrem) TEDE.

In order to perform a dose assessment, licensees should identify all potential sources of external and internal radiation exposure to members of the public and all locations of use, transport, and storage of radioactive material at their facilities. Licensees must then take radiation measurements or perform calculations to demonstrate compliance.

Measurements

The licensee may use measurements to demonstrate that the average annual releases are within regulatory limits, as well as to demonstrate that the TEDE to the individual likely to receive the highest dose at the boundary of the unrestricted area does not exceed 1 mSv (100 mrem). These measurements may include:

- Dose rate surveys for radiation exposures from external radiation sources
- Measurements of radionuclides in air and water effluent.

The method used to measure dose will depend upon the nature of the radiation source. If the source of radiation is constant, it may be adequate to measure the dose rate and integrate it over time. If the source of radiation differs or changes over time, it may be necessary to perform continuous measurements.

Radioactivity releases may be determined by effluent monitoring or by effluent sampling and analysis. Airborne effluents may be discharged when volatile materials are used, such as during iodinations, but the discharge itself is usually not continuous since volatile materials are often used periodically rather than continuously. Liquid effluents may be discharged continuously or may be stored and subsequently discharged on a batch basis. For each type of source and for each route of potential exposure, consider the location of measurement points, whether continuous or periodic monitoring is required, the frequency of sampling and measurement, and any additional information. For discharges of airborne radionuclides, for example, it may be necessary to obtain information on the efficiency of filters and the air flow rate of the discharge system, as well as meteorological data and the distance to the nearest individual member of the public.

Calculation Method

Using a calculation method, the licensee must determine the highest dose an individual is likely to receive at the boundary of the unrestricted area. The licensee must take into account the individual's exposure from external sources and the concentration of radionuclides in gaseous and liquid releases. In practice, the licensee may wish to make conservative assumptions to simplify the dose calculation.

The public dose limit applies to the individual who is likely to receive the highest dose from licensed operations. Therefore, the dose calculations must consider the location with the potential for the highest internal and external exposures. A conservative calculation should assume that the individual was continuously present 24 hours a day, 365 days a year, or an occupancy factor of 1 (see Table M.1). If the

result of the calculation using an occupancy factor of 1 demonstrates that the public dose limit is not exceeded, then there is no need for further evaluation.

If the calculation demonstrates that the public dose limit is exceeded with an occupancy factor of 1, then more realistic assumptions of the individual's occupancy at the points of highest internal and external exposures may be made. The licensee may use the occupancy factors in Table M.1 or may calculate a specific occupancy factor by determining the likely fraction of time that the individual is present.

Table M.1 Standard Occupancy Factors

Occupancy Factor	Description
1	Work areas such as offices, laboratories, shops, and occupied space in nearby buildings or outdoor areas
1/4	Corridors, lounges, elevators using operators, unattended parking lots
1/16	Waiting rooms, rest rooms, stairways, unattended elevators, janitor's closets, outside areas used only for pedestrians or vehicular traffic

Records

The licensee must maintain records to demonstrate compliance with the dose limit for individual members of the public until the Commission terminates the license. In general, survey and monitoring records of ambient radiation and effluent radioactivity should be adequate.

Records demonstrating the dose to an individual member of the public should identify the instruments used in the survey, the name of the surveyor, the date of the survey, the location of the survey(s) including a description or drawing of the area surveyed, survey results, and if applicable, the occupancy factors used and justification for their use. In addition, records demonstrating the dose to an individual member of the public that involve effluent sampling analysis should include information on concentrations of specific radionuclides, minimum detectable activity of the system and the estimated uncertainty of measurements.

The following is a simple example to demonstrate the above concepts for calculating, direct measurement with sensitive instrumentation, and combination of calculating and measurement.

Calculation Method⁶

These measurements must be made with calibrated survey meters sufficiently sensitive to measure background levels of radiation. However, licensees must exercise caution when making these measurements, and they must use currently calibrated radiation survey instruments. A maximum dose of 1

⁶ For ease of use, the examples in this Appendix use conventional units. The conversions to SI units are as follows: 1 foot (ft) = 0.305 meter; 1 mrem = 0.01 mSv.

APPENDIX M

mSv (100 mrem) received by an individual over a period of 2080 hours (i.e., a “work year” of 40 hr/wk for 52 wk/yr) is equal to less than 0.5 microsievert (0.05 mrem) per hour.

This rate is well below the minimum sensitivity of most commonly available G-M survey instruments.

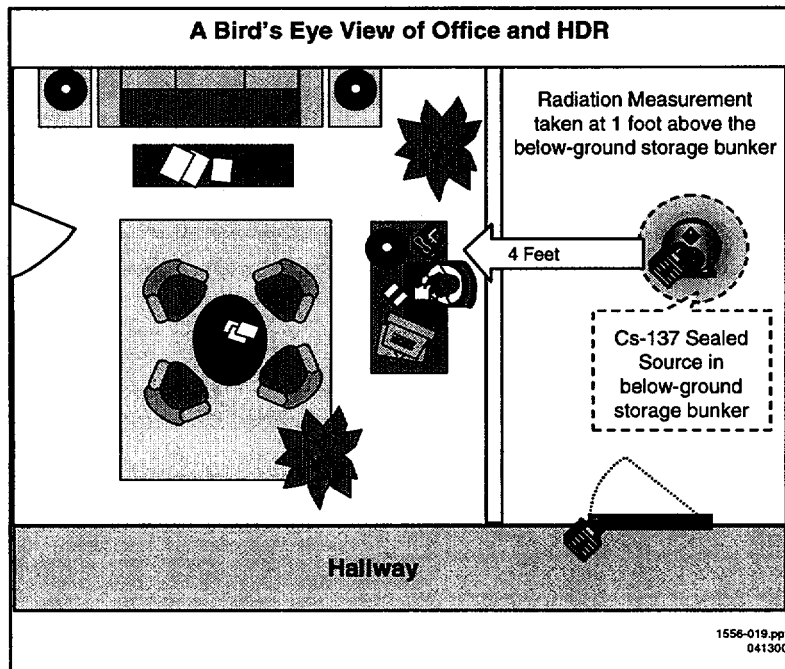

Figure M.1 Bird's Eye View of Office With Stored Calibration Source.

Instruments used to make measurements for calculations must be sufficiently sensitive. An instrument equipped with a scintillation-type detector (e.g., NaI(Tl)) or a micro-R meter used in making very low gamma radiation measurements should be adequate.

Licensees may also choose to use environmental TLDs in unrestricted areas next to the down-hole source storage area for monitoring. This direct measurement method would provide a definitive measurement of actual radiation levels in unrestricted areas without any restrictive assumptions. Records of these measurements can then be evaluated to ensure that rates in unrestricted areas do not exceed the 1 mSv/yr (100 mrem/yr) limit.

TLDs used for personnel monitoring (e.g., LiF) may not have sufficient sensitivity for this purpose. Generally, the minimum reportable dose received is 0.1 mSv (10 mrem). Suppose a TLD monitors dose received and is changed once a month. If the measurements are at the minimum reportable level, the annual dose received could have been about 1.2 mSv (120 mrem), a value in excess of the 1 mSv/yr (100 mrem/yr) limit. If licensees use TLDs to evaluate compliance with the public dose limits, they should consult with their TLD supplier and choose more sensitive TLDs, such as those containing CaF₂ that are used for environmental monitoring.

The combined measurement-calculation method may be used to estimate the maximum dose to a member of the public. The combined measurement-calculation method takes a tiered approach, going through a two-part process, starting with a worst case situation and moving toward more realistic situations. It makes the following simplifications: (1) each cesium-137 source is considered a point source; (2) typical radiation levels are encountered when the source is in the unshielded position; and (3) no credit is taken for any shielding found between the source storage area and the unrestricted areas. The method is only valid for the source activity at the time of measurement and must be repeated if the source strength or shielding is changed.

Part 1 of the combined measurement-calculation method is simple but conservative. It assumes that an affected member of the public is present 24 hours a day and uses only the inverse square law to determine if the distance between the down-hole storage area and the affected member of the public is sufficient to show compliance with the public dose limits. Part 2 considers not only distance, but also the time that the affected member of the public is actually in the area under consideration. Using this approach, licensees make only those calculations that are needed to demonstrate compliance. The results of these calculations typically result in higher radiation levels than would exist at typical facilities, but they provide a method for estimating conservative doses that could be received.

Example

To better understand the combined measurement-calculation method, we will examine DISPOZ, Inc., a waste management broker. Yesterday, the company's president noted that the top shield of the down-hole storage area is close to an area used by workers whose assigned duties do not include the use of licensed materials, and he asked Clem, the Radiation Safety Officer (RSO), to determine if the company is complying with NRC's regulations.

The area in question is near the floor under the workers' desks, which constitutes the primary shield of the down-hole storage area. Clem measures the distance from the shield to the center of the area in question and, using a calibrated survey instrument, measures the highest dose rate at one foot from the shield to be 2 mrem per hour.

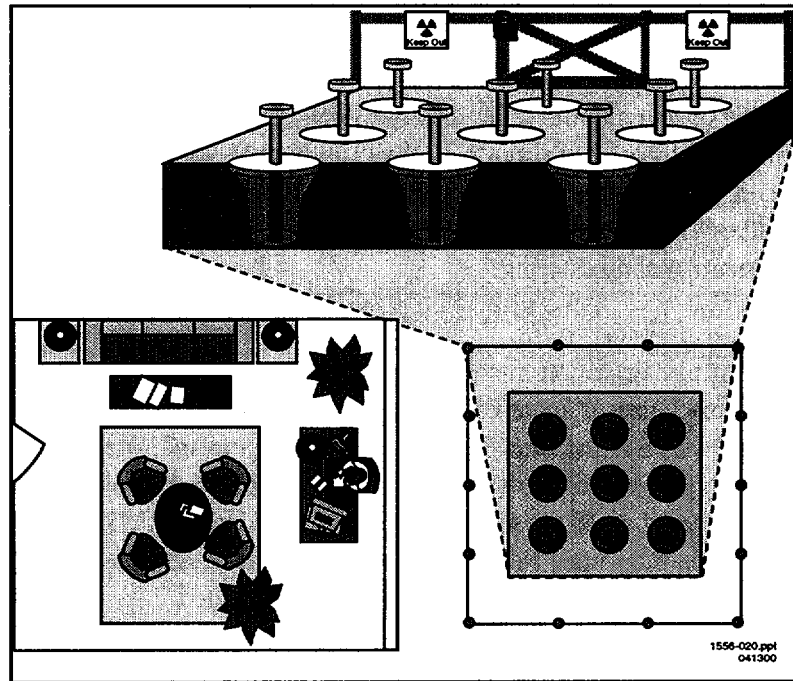

Figure M.2 Down Hole Storage Array in Waste Broker Facility.

Table M.2 summarizes the information Clem has on the down-hole storage area.

Table M.2 Information Known about Dose at the Shield of the Cs-137 Source

Description of Known Information	Cesium-137 Logging Source
Dose rate encountered at 1 foot from the top of the shield, in mrem/hr.	2 mrem/hr.
Distance from the face of the shield to the nearest occupied work area, in ft.	4 ft

Example: Part 1

Clem’s first thought is that the distance between the down-hole storage area shield and the area in question may be sufficient to show compliance with the regulation in 10 CFR 20.1301. So, taking a worst case approach, he assumes: 1) the cesium-137 is constantly located in down-hole storage area (i.e., 24 hr/d), and 2) the workers are constantly in the unrestricted work area (i.e., 24 hr/d). Clem proceeds to calculate the dose the workers might receive hourly and yearly from the source, as shown in Table M-3 below.

Table M.3 Calculation Method, Part 1: Hourly and Annual Doses Received from a Source Stored in Above Ground.

Step No.	Description	Input Data	Results
1	Multiply the measured dose rate measured at 1.0 ft from the face of the shield floor in mrem/hr by the square of the distance (ft) at which the measurement was made (e.g., 1 foot from the face of the shield)	$2 \times (1)^2$	2
2	Square of the distance (ft) from the face of the shield to the nearest unrestricted area, in ft ²	$(4)^2$	16
3	Divide the result of Step 1 by the result of Step 2 to calculate the dose received by an individual in the area near the shield. HOURLY DOSE RECEIVED FROM SOURCE, in mrem in an hour	$2/16$	0.125
4	Multiply the result of Step 3 by 40 hr/work week x 52 weeks/year = MAXIMUM ANNUAL DOSE RECEIVED FROM Cs-137 Source, in mrem in a year	$0.125 \times 40 \times 52$	260

Note: The result in Step 3 demonstrates compliance with the 2 mrem in any one hour limit. Re-evaluate if assumptions change. If the result in Step 4 exceeds 100 mrem/yr, proceed to Part 2 of the calculation method.

At this point, Clem is pleased to see that the total dose that an individual could receive in any one hour is only 0.125 mrem in an hour, less than the 2 mrem in any one hour limit but notes that an individual could receive a dose of 260 mrem in a year, higher than the 100 mrem limit.

Example: Part 2

Clem reviews the assumptions and recognizes that the workers are not in area all of the time. A realistic estimate of the number of hours the workers spends in the area is made, keeping the other assumptions constant (i.e., the source is constantly in the down-hole storage area (i.e., 24 hr/d). The annual dose received is then recalculated.

Table M.4 Calculation Method, Part 2: Annual Dose Received from a Source Stored Above Ground.

Step No.	Description	Results
7	A. Average number of hours per day an individual spends in area of concern (e.g., a non-radiation worker spends 1.5 hr/day in the area near the shield; the remainder of the day the workers are away from the area assigned to jobs unrelated to radiation. (painting, grounds keeping, desk jobs, etc.)	1.5
	B. Average number of days per week in area	5
	C. Average number of weeks per year in area (e.g., full time workers)	52
8	Multiply the results of Step 7.A. by the results of Step 7.B. by the results of Step 7.C. = AVERAGE NUMBER OF HOURS IN AREA OF CONCERN PER YEAR	$1.5 \times 5 \times 52 = 390$
9	Multiply the results in Step 3 by the results of Step 8 = ANNUAL DOSE RECEIVED FROM CESIUM-137 LOGGING SOURCE CONSIDERING REALISTIC ESTIMATE OF TIME SPENT IN AREA OF CONCERN, in mrem in a year	$0.125 \times 390 = 49$

Clem is pleased to note that the calculated annual dose received is significantly lower, and does not exceed the 100 mrem in a year limit.

Clem is glad to see that the results in Step 9 show compliance with the 100 mrem in a year limit. Had the result in Step 9 been higher than 100 mrem in a year, then Clem could have done one or more of the following:

- Consider whether the assumptions used to determine occupancy are accurate, revise the assumptions as needed, and recalculate using the new assumptions
- Calculate the effect of any shielding located between the storage area and the floor of the public area — such calculation is beyond the scope of this Appendix
- Take corrective action (e.g., change work patterns to reduce the time spent in the area near the shield) and perform new calculations to demonstrate compliance

- Designate the area inside the use area as a restricted area and the workers as occupationally exposed individuals. This would require controlling access to the area for purposes of radiation protection and training the workers as required by 10 CFR 19.12

National Council on Radiation Protection and Measurements (NCRP) Report No. 49, "Structural Shielding Design and Evaluation for Medical Use of X Rays and Gamma Rays of Energies Up to 10 MeV," contains helpful information. It is available from NCRP, 7910 Woodmont Avenue, Suite 800, Bethesda, Maryland 20814. NCRP's telephone numbers are: (301) 657-2652 or 1-800-229-2652.

Note that in the example, Clem evaluated the unrestricted area outside only one wall of the down-hole storage area. Licensees also need to make similar evaluations for other unrestricted areas and to keep in mind the ALARA principle, taking reasonable steps to keep radiation dose received below regulatory requirements. In addition, licensees need to be alert to changes in situations (e.g., adding sources to the storage area, changing the work habits of the workers, or otherwise changing the estimate of the portion of time spent in the area in question) and to perform additional evaluations, as needed.

RECORD KEEPING: 10 CFR 20.2107 requires licensees to maintain records demonstrating compliance with the dose limits for individual members of the public.

Appendix N
Model Waste Disposal Program

Model Waste Disposal

General Guidelines

1. All radioactivity labels must be defaced or removed from containers and packages prior to disposal into ordinary "non-radioactive" waste streams. If waste is compacted, all labels that are visible in the compacted mass must be defaced or removed.
2. Remind workers that nonradioactive waste such as leftover reagents, boxes, and packaging material should not be mixed with radioactive waste.
3. Occasionally monitor all procedures to ensure that radioactive waste is not created unnecessarily. Review all new procedures to ensure that waste is handled in a manner consistent with established procedures.
4. In all cases, consider the entire impact of various available disposal routes. Consider occupational and public exposure to radiation, other hazards associated with the material and routes of disposal (e.g., toxicity, carcinogenicity, pathogenicity, inflammability), and costs.
5. Waste management program should include waste handling procedures for the users within their laboratories or assigned areas, and for waste handlers who may collect waste from areas of use to bring to the storage area for eventual disposal.
6. Housekeeping staff should be provided adequate training to avoid the possibility of unauthorized disposal or exposure of these individuals to radioactive materials or to radiation.

Model Procedure for Disposal by Decay-in-storage (DIS)

Applicants should assure that adequate space and facilities are available for the storage of waste for DIS. Licensees can minimize the need for storage space if the waste is segregated according to physical half life.

1. Only short-lived waste (physical half-life of less than or equal to 120 days) may be disposed of by DIS.
2. Short-lived waste should be segregated from long-lived waste.
3. Waste should be stored in suitable well marked containers and the containers should provide adequate shielding.
4. Liquid and solid wastes must be stored separately.
5. When the container is full, it should be sealed. The sealed container should be identified with a label affixed or attached to it.
6. The identification label should include the date when the container was sealed, the longest-lived radioisotope in the container, total activity, date when ten half-lives of the longest-lived radioisotope will have transpired, and the initials of the individual who sealed the container. The container may be transferred to the DIS area. When large quantities are held for DIS, sufficient quantities may be present even after 10 half-lives that persons performing surveys should be aware of the potential for measurable radiation.

APPENDIX N

7. The contents of the container should be allowed to decay for at least ten half-lives of the longest-lived radioisotope in the container.
8. Prior to disposal as ordinary trash, each container should be monitored as follows:
 - a. Check the radiation detection survey meter for proper operation.
 - b. Survey the contents of each container in a low background area.
 - c. Remove any shielding from around the container.
 - d. Monitor all surfaces of the container.
 - e. Discard the contents as ordinary trash only if the surveys of the contents indicate no residual radioactivity, i.e. surface readings are indistinguishable from background.
 - f. If the surveys indicate residual radioactivity, return the container to DIS area and contact the RSO for further instructions.
9. If the surveys indicate no residual radioactivity, record the date when the container was sealed, the disposal date, type of waste (used or unused material, gloves, etc.), survey instrument used, and the initials of the individual performing surveys and disposing of the waste.

All radiation labels must be defaced or removed from containers and packages prior to disposal as ordinary trash. Syringes/needles placed into sealed waste containers for decay do not need the labels removed provided that the following is done: waste barrels are sealed prior to delivery to the waste disposal firm and delivered directly from the licensee's facility; labels are removed from the waste barrels/containers; and that the waste is incinerated, not placed in a landfill, and the waste disposal firm is cautioned not to open the container prior to incineration.

Model Procedure for Disposal of Liquids Into Sanitary Sewerage

1. Confirm that the sewer system is a public system, not a private sanitary sewer, septic system or leach field.
2. Confirm that the liquid waste being discharged is soluble (or is biological material that is readily dispersible) in water.
3. Calculate the amount of each radioisotope that can be discharged by using the information from prior, similar discharges and the information in 10 CFR 20, Appendix B.
4. Make sure that the amount of each radioisotope does not exceed the monthly and annual discharge limits specified in 10 CFR 20.2003(a)(4) and 10 CFR 20, Appendix B, Table 3 (records for individual users/laboratories).
5. If more than one radioisotope is released, the sum of the ratios of the average monthly discharge of a radioisotope to the corresponding limit in 10 CFR Part 20, Appendix B, Table 3 must not exceed unity.

6. Total quantity of licensed material released into the sanitary sewerage system in a year does not exceed 185 GBq (5 Ci) of H-3 (tritium), 37 GBq (1 Ci) of C-14, and 37 GBq (1 Ci) of all other radioisotopes combined.
7. Record the date, radioisotope(s), estimated activity of each radioisotope, location where the material is discharged, and the initials of the individual discharging the waste.
8. Liquid waste should be discharged only via designated sinks or toilets.
9. Discharge liquid waste slowly to minimize splashing with water running to be sure that the material moves out of the sink into the sewer system.
10. Survey the sink and surrounding work surfaces to confirm that no residual material or contamination remained in the sink or on work surfaces. Decontaminate as appropriate.
11. Decontaminate all areas or surfaces if found to be contaminated.
12. For all releases to the sanitary sewer from the licensed facility, maintain records of each radioisotope and its quantity and concentration that is released into the sewer system that demonstrate compliance with the regulatory limits for total quantity released and concentrations released by the licensed facility.

Appendix O
Model Leak Test Program

Training

Before allowing an individual to perform leak test analysis independently, the RSO will ensure that this individual has sufficient classroom and on-the-job training to show competency in performing leak test analysis.

Classroom training in the performance of leak test analysis may be provided in the form of lecture, videotape, or self-study. This classroom training and should cover the following subject areas:

- Principles and practices of radiation protection
- Radioactivity measurements, monitoring techniques, and using instruments
- Mathematics and calculations basic to using and measuring radioactivity
- Biological effects of radiation

Appropriate on-the-job training consists of:

- Observing authorized personnel collecting and analyzing leak test samples
- Collecting and analyzing leak test samples under the supervision and in the physical presence of an individual authorized to perform leak tests and leak test analysis

Facilities and Equipment

To ensure the required sensitivity of measurements, leak tests will be analyzed in a low-background area.

Before leak test swipes are analyzed, individuals conducting leak tests will use a calibrated and operable survey instrument to check leak test samples for gross contamination. If the sensitivity of the counting system is unknown, the minimum detectable activity (MDA) needs to be determined. The MDA may be determined using the following formula:

$$MDA = \frac{3 + 4.65(BR)^{1/2}}{Et}$$

Et

where MDA = activity level in disintegrations per minute (dpm)

BR = background rate in counts per minute (cpm)

t = counting time in minutes

E = detector efficiency in counts per disintegration (cpd)

APPENDIX O

For example:

$$\text{MDA} = \frac{3 + 4.65(200 \text{ cpm})^{1/2}}{(0.1 \text{ cpd})(2 \text{ minutes})}$$

where BR = 200 cpm

E = 0.1 cpd (10% efficient)

t = 2 minutes

A NaI(Tl) well counter system with a single or multi-channel analyzer will be used to count samples from sealed sources containing gamma-emitters (e.g., cesium-137, cobalt-60).

A liquid scintillation, gas-flow proportional, or solid state counting system will be used to count samples containing alpha-emitters (e.g., americium-241).

Procedure for Performing Leak Testing and Analysis

- For each source to be tested, list identifying information such as the manufacturer's name, model number, serial number, radionuclide, activity of the sealed source(s).
- Prepare a separate wipe sample (e.g., cotton swab or filter paper) for each source.
- Number each wipe to correlate with identifying information for each source.
- If available, use a survey meter to monitor exposure.
- Wipe the most accessible area (but not directly from the surface of the source) where contamination would accumulate if the sealed source were leaking, e.g., the leak test can be taken of the part that connects to the source or the inside of the transport container that has recently transported the source.
- Select an instrument that is sensitive enough to detect 185 Bq (0.005 mCi) of the radionuclide of the sealed source.
- Using the selected instrument, count and record background count rate.
- Check the instrument's counting efficiency using a standard source of the same radionuclide as the source being tested or one with similar energy characteristics. Accuracy of standards should be within 5% of the stated value and traceable to primary radiation standard such as those maintained by the National Institutes of Standards and Technology (NIST).
- Calculate efficiency. For example:

$$\frac{[(\text{cpm from std}) - (\text{cpm from bkg})]}{\text{activity of std in Bq}} = \text{efficiency in cpm/Bq}$$

activity of std in Bq

where cpm = counts per minute

std = standard

bkg = background

Bq = Becquerel

- Count each wipe sample; determine net count rate.
- For each sample, calculate and record estimated activity in Bq (or mCi). For example:
$$\frac{[(\text{cpm from wipe sample}) - (\text{cpm from bkg})]}{\text{efficiency in cpm/Bq}} = \text{Bq on wipe sample}$$
- Sign and date the list of sources, data and calculations. Retain records for 3 years (10 CFR 20.2103(a)).
- If the wipe test activity is 185 Bq (0.005 microcurie) or greater, notify the RSO, so that the source can be withdrawn from use and disposed of properly. Also notify NRC.

Appendix P
Non-routine Maintenance Checklist

Information Needed to Support Applicant's Request to Perform Non-Routine Operations for Other Individuals

Applicants should review the section in this document on "Maintenance," which discusses, in general, licensee responsibilities before any maintenance or repair is performed.

Non-routine operations include installation of the sealed source/device, initial radiation survey, repair or maintenance involving or potentially affecting components, including electronics, related to the radiological safety (e.g., the source, source holder, source drive mechanism, shutter, shutter control, or shielding), relocation, replacement, and disposal of sealed sources, alignment, removal of a sealed source/device from service, and any other activities during which personnel could receive radiation doses exceeding NRC limits.

Any non-manufacturer/non-distributor supplied replacement components or parts, or the use of materials (e.g., lubricants) other than those specified or recommended by the manufacturer or distributor need to be evaluated to ensure that they do not degrade the engineering safety analysis performed and accepted as part of the device registration. Licensees also need to ensure that, after maintenance or repair is completed, the sealed source/device is tested and functions as designed, before the unit is returned to routine use.

If non-routine operations are not performed properly with attention to good radiation safety principles, the sealed source/device may not operate as designed and personnel performing these tasks could receive radiation doses exceeding NRC limits.

Thus, applicants wishing to perform non-routine operations must use personnel with special training and follow appropriate procedures consistent with the manufacturer's or distributor's instructions and recommendations that address radiation safety concerns (e.g., use of radiation survey meter, shielded container for the source, and personnel dosimetry (if required)). Accordingly, provide the following information:

Describe the types of work, maintenance, cleaning, repair that involve:

- Installation, relocation, or alignment of the sealed source/device
- Components, including electronics, related to the radiological safety of the gauge (e.g., the source, source holder, source drive mechanism, shutter, shutter control, or shielding)
- Replacement and disposal of sealed sources
- Removal of a sealed source/device from service
- A potential for any portion of the body to come into contact with the primary radiation beam; or
- Any other activity during which personnel could receive radiation doses exceeding NRC limits.

The principal reason for obtaining this information is to assist in the evaluation of the qualifications of individuals who will conduct the work and the radiation safety procedures they will follow.

APPENDIX P

- Identify who will perform non-routine operations and their training and experience. Acceptable training would include manufacturer's or distributor's courses for non-routine operations or equivalent.
- Submit procedures for non-routine operations. These procedures should ensure the following:
 - doses to personnel and members of the public are within regulatory limits and ALARA (e.g., use of shielded containers or shielding);
 - the source is secured against unauthorized removal or access or under constant surveillance;
 - appropriate labels and signs are used;
 - manufacturer's or distributor's instructions and recommendations are followed;
 - any non-manufacturer/non-distributor supplied replacement components or parts, or the use of materials (e.g., lubricants) other than those specified or recommended by the manufacturer or distributor are evaluated to ensure that they do not degrade the engineering safety analysis performed and accepted as part of the device registration; and
 - before being returned to routine use, the sealed source/device is tested to verify that it functions as designed and source integrity is not compromised.
- Confirm that individuals performing non-routine operations will wear both whole body and extremity monitoring devices or perform a prospective evaluation demonstrating that unmonitored individuals performing non-routine operations are not likely to receive, in one year, a radiation dose in excess of 10% of the allowable limits.
- Verify possession of at least one survey instrument that meets the criteria in "Radiation Safety Program - Instruments in draft NUREG-1556, Vol. 18, 'Consolidated Guidance about Materials Licenses: Program-Specific Guidance about Service Provider Licenses,' dated May 2000."
- Describe steps to be taken to ensure that radiation levels in areas where non-routine operations will take place do not exceed 10 CFR 20.1301 limits. For example, applicants can do the following:
 - commit to performing surveys with a survey instrument (as described above);
 - specify where and when surveys will be conducted during non-routine operations; and
 - commit to maintaining, for 3 years from the date of the survey, records of the survey (e.g., who performed the survey, date of the survey, instrument used, measured radiation levels correlated to location of those measurements), as required by 10 CFR 20.2103.

Appendix Q

Transportation

Part 1: Major DOT Regulations

The major areas in the DOT regulations that are most relevant for transportation of licensed material shipped as Type A quantities are as follows:

- Hazardous Materials Table, 49 CFR 172.101, App. A, list of hazardous substances and reportable quantities (RQ), Table 2: Radionuclides
- Shipping Papers 49 CFR 172.200-204: General entries, description, additional description requirements, shipper's certification
- Package Markings 49 CFR 172.300, 49 CFR 172.301, 49 CFR 172.303, 49 CFR 172.304, 49 CFR 172.310, 49 CFR 172.324: General marking requirements for non-bulk packagings, prohibited marking, marking requirements, radioactive material, hazardous substances in non-bulk packaging
- Package Labeling 49 CFR 172.400, 49 CFR 172.401, 49 CFR 172.403, 49 CFR 172.406, 49 CFR 172.407, 49 CFR 172.436, 49 CFR 172.438, 49 CFR 172.440: General labeling requirements, prohibited labeling, radioactive materials, placement of labels, specifications for radioactive labels
- Placarding of Vehicles 49 CFR 172.500, 49 CFR 172.502, 49 CFR 172.504, 49 CFR 172.506, 49 CFR 172.516, 49 CFR 172.519, 49 CFR 172.556: Applicability, prohibited and permissive placarding, general placarding requirements, providing and affixing placards: highway, visibility and display of placards, specifications for RADIOACTIVE placards
- Emergency Response Information, Subpart G, 49 CFR 172.600, 49 CFR 172.602, 49 CFR 172.604: Applicability and general requirements, emergency response information, emergency response telephone number
- Training, Subpart H, 49 CFR 172.702, 49 CFR 172.704: Applicability and responsibility for training and testing, training requirements
- Shippers - General Requirements for Shipments and Packaging, Subpart I, 49 CFR 173.403, 49 CFR 173.410, 49 CFR 173.412, 49 CFR 173.415, 49 CFR 173.431, 49 CFR 173.433, 49 CFR 173.435, 49 CFR 173.441, 49 CFR 173.443, 49 CFR 173.448, 49 CFR 173.475, 49 CFR 173.476: Definitions, general design requirements, additional design requirements for Type A packages, authorized Type A packages, activity limits for Type A packages, requirements for determining A_1 and A_2 , table of A_1 and A_2 values for radionuclides, radiation level limitations, contamination control, general transportation requirements, quality control requirements prior to each shipment, approval of special form radioactive materials
- Radiation Protection Program for Shippers and Carriers, Subpart I, 49 CFR 172.801, 49 CFR 172.803, 49 CFR 172.805: Applicability of the radiation protection program, radiation protection program, record keeping, and notifications
- Carriage by Public Highway - General Information and Regulations, Subpart A, 49 CFR 177.816, 49 CFR 177.817, 49 CFR 177.834(a), 49 CFR 177.842: Driver training, shipping paper, general requirements (secured against movement), Class 7 (radioactive) material.

Part 2: Schedule Summary of the Principal Requirements for Transport of Specified Types of Radioactive Material Consignments.

Technical guidance to shippers on compliance with U.S. Nuclear Regulatory Commission (NRC) and U.S. Department of Transportation (DOT) regulations for packaging and transporting radioactive materials in the United States is provided in NUREG-1660, RAM REG-002, "U.S.- Specific Schedules of Requirements for Transport of Specified Types of Radioactive Material Consignments," (<http://www.nrc.gov/NRC/NUREGS/SR1660/index.html>).

The guidance is in the form of Schedules (guides). These Schedules reflect the U.S. regulations in effect on April 1, 1997, and are intended to be the domestic counterpart to the schedules issued by the International Atomic Energy Agency (IAEA) for international transportation safety regulations.

These Schedules are a consolidation of the requirements of the Regulations for each of 12 categories of radioactive material. Once the shipper has properly categorized the radioactive material shipment, these Schedules can be used to define the specific requirements for shipment of that category of radioactive material. They were developed by collecting the requirements applicable to each type of shipment from the regulations, then paraphrasing the regulation for simplicity and conciseness. A regulatory reference is provided so that the regulation can be readily consulted when desired.

These Schedules do not specifically address all possible shipments involving radioactive materials; in particular, they do not fully address shipments of mixed wastes or other radioactive materials that also satisfy the DOT definition for another hazard class.

A sample Schedule is provided below as Table Q-1.

Table Q.1. Schedule Summary of the Principal Requirements for Transport of Specified Types of Radioactive Material Consignments (Principal requirements only - consult regulations for detailed provisions)

Schedule No.	Schedule 0	Schedule 1	Schedule 2	Schedule 3	Schedule 4	Schedule 5	Schedule 6	Schedule 7	Schedule 8	Schedule 9	Schedule 10	Schedule 11	
Description	Small Quantities	Limited Quantities	Instruments and Articles	Articles from nat'l/ depleted Uranium/ Thorium	Empty Packages	LSA-I: Low specific activity	LSA-II: Low specific activity	LSA-III: Low specific activity	SCO-V-II: Surface contaminated objects	Material in TYPE A packages	Material in TYPE B[x] packages	Fissile material	
UN Number(s)	N/A	2910				2912			2913	2975, 2976, 2978, 2979, 2980, 2981, 2982, 2974	2982, 2974	2918, 2977	
Specification of allowable contents (1)	30 ml liquid 30 g solid or 1 g Div. 6.1	Activities in fractions of A ₁ or A ₂		Natural U/ depleted U/ natural thorium	Non-fixed internal contamination: ≤ 400 Bq/cm ² By ≤ 40 Bq/cm ² α	*Ores *U/Th concentrates, *Solid unir U/Th or their solid/liq mix/compound, *Non-fissile mat'l w/ unlimited A ₂ *Uniformly dist. mat'l ≤ 10 ⁶ A/g	*Tritiated water w/ ≤ 0.8 Tbq/l, *Solids/gases w/ specific activity ≤ 10 ⁴ A/g *Liquids w/ specific activity ≤ 10 ⁵ A/g	*Uniformly dist. insoluble mat'l w/ specific act. ≤ 2 x 10 ³ A/g	Contaminated objects w/ limits for fixed and non-fixed contamination on accessible and inaccessible surfaces between 0.4 Bq/cm ² and 8 x 10 ³ Bq/cm ²	Activities: ≤ A ₁ or ≤ A ₂	As specified in CA certificate/package specification	As specified in package specification	
Requirements on the contents	RL ≤ 0.1 mSv/h @ 10 cm from ext. surface of unpkg'd instrument/article		RL ≤ 0.1 mSv/h @ 10 cm from ext. surface of unpkg'd instrument/article	Accessible surface must be sheathed in inactive material			RL of unshielded contents ≤ 10 mSv/h at 3 m. Activity uniformly distributed				As specified in CA certificate/package specification	As specified in package specs/ ship. mode.	
Packaging (2)	Small quantity	Excepted Package				TYPE A Packaging IP-1 (5) IP-2 when liquid & not EU	TYPE A Packaging IP-2 IP-3 when liquid & not EU	TYPE A Packaging IP-3 IP-2 under EU	TYPE A Packaging SCO-I: IP-1 (5) SCO-II: IP-2	TYPE A Packaging	TYPE B Packaging	6L, 6M (others) TYPE AF, B[x] as appropriate	
Max.RL per package	≤ 0.005 mSv/h at surface					≤ 2 mSv/h at surface and ≤ 0.1 mSv/h at 1 m. Under EU: ≤ 10 mSv/h at surface + Vehicle RL limits							
Contamination	≤ 0.4 Bq/cm ² By ≤ 0.04 Bq/cm ² α					≤ 0.4 Bq/cm ² By ≤ 0.04 Bq/cm ² α							
Mixed Loading	Classified Class 7 except: explosive mat'l-Class 1; organic peroxide-Division 5.2; and a material that meets the definition of wetted explosive-Division 4.1.												
Labeling	No labels required				"EMPTY," Old labels removed	White- I, Yellow-II, Yellow-III according to category + additional Dangerous Goods labels as required. "RQ" for hazardous material							
Marking of packages	"Radioactive" on inner packaging,	"Radioactive" on inner packaging	"Radioactive" on article/instrument			Gross weight if > 50 kg (110 pounds)					CA Ident. mark as appropriate		
						"Radioactive - LSA" if EU	"Radioactive - SCO" if EU	"TYPE A"			"TYPE B[x]" Radiation Trefoil	Marked according to package type	
Conveyance (3)	Placarding for Yellow III, exclusive use LSA/SCO, Hwy Rt. Controlled Qnty. "Corrosive" for some fissile, all UF6												
Transport documents (4)	Shipper's Certification per 173.4	Shipper's Certification per 173.421	Shipper's Certification per 173.424	Shipper's Certification per 173.426	Shipper's Certification per 173.428	Shipper's Certification, Shipping Papers, Emergency Procedures						CA ID as applicable	Controlled ship/CA cert. as applicable
Storage and dispatch	Segregation from persons, photographic material, live animals and other DG												
	Multi Class 7 restricted if any TB-10 or total > 50												
Shipment	Segregation from persons, photographic material, live animals and other DG												
							Max activity/conveyance: 100A ₂ for combustible solids/all liquids+gases						Controlled Shipment. if TB-10

NOTES:
 (1) If A1 values are used, the requirements regarding radioactive material in SF must be applied
 (2) For radioactive Material with additional risk, (e.g. UF6), additional packaging requirements may apply
 (3) Also valid for freight containers and tanks
 (4) Additional requirements for international shipments.
 (5) LSA-I and SCO-I may be transported unpacked under certain specific conditions combined with EU

KEY:
 RL - Radiation Level
 EU - Exclusive Use
 SF - Special Form
 TI - Transport Index
 CA - Competent Authority
 DG - Dangerous Goods
 B[x] - B, B(m) or B(u)

STRAIGHT BILL OF LADING
ORIGINAL - NOT NEGOTIABLE

Shipper No. _____
Carrier No. _____
Date _____

Page 1 of 1 _____ (Name of carrier) _____ (SCAC)

TO: ABC Bottling Inc. Consignee Chicago Plant <small>On Collect on Delivery shipments, the letters "COD" must appear before consignee's name or as otherwise provided in Item 430, Sec. 1.</small>		FROM: ABC Bottling, Inc. Shipper Milwaukee Plant	
Street Admiral Avenue		Street Liberty Place	
Destination Chicago, Illinois Zip Code 35011		Origin Milwaukee, Wisconsin 38023	

No. of Units & Container Type	HM	BASIC DESCRIPTION Proper Shipping Name, Hazard Class Identification Number (UN or NA) per 172.101, 172.202, 172.203	TOTAL QUANTITY (Weight, Volume, Gallons, etc.)	WEIGHT (Subject to Correction)	RATE	CHARGES (For Carriage Use Only)
1	RQ	Radioactive material, special form, n.o.s. 7 UN 2974 55.5 GBq (1.5 Ci) Cs-137	55.5 GBq (1.5 Ci)			
		RADIOACTIVE - YELLOW II				
		TI = 0.4 **				
		USDOT 7A TYPE A				
		Emergency Response Telephone No.: 1-800-000-0000 (24 hr/d)**				
		** SUBSTITUTE APPROPRIATE INFORMATION FOR YOUR GAUGE AND SHIPMENT				

PLACARDS TENDERED: YES <input type="checkbox"/> NO <input type="checkbox"/>		REMIT C.O.D. TO: ADDRESS	
<small>Note -- Where the rate is dependent on value, shippers are required to state specifically in writing the agreed or declared value of the property. The agreed or declared value of the property is hereby specifically stated by the shipper to be not exceeding \$ _____ per _____</small>		COD Amt: \$ _____ <small>Subject to Section 7 of the conditions, if this shipment is to be delivered to the consignee without recourse on the consignor, the consignor shall sign the following statement: The carrier shall not make delivery of this shipment without payment of freight and of other lawful charges.</small>	
<small>I hereby declare that the contents of the attachment are fully and accurately described above by proper shipping name and are classified, packaged, marked and labeled, and are in all respects in proper condition for transport by _____ (highway or other) _____ (water, air, rail, etc.) _____ (intermodal) according to applicable international and national governmental regulations.</small> Signature: <u>John Jones</u>		C.O.D. FEE: PREPAID <input type="checkbox"/> COLLECT <input type="checkbox"/> \$ _____ TOTAL CHARGES: \$ _____ FREIGHT CHARGES: _____	
<small>RECEIVED, subject to the conditions and hereby filed herein in effect on the date of the issue of this Bill of Lading, the property described above in apparent good order, except as noted hereon, and condition of contents of packages unopened, marked, numbered, and described as indicated above which endorser (the vessel owner) being understood throughout this contract as meaning any person or corporation in possession of the property under the contract agrees to carry in its usual course of delivery at said destination, if on its route, otherwise to deliver to another carrier on the route to said destination. It is mutually agreed as to each-carrier of all or any of, said property over all or any portion of</small>		<small>Said route to destination and as to each party of any time extension on all or any said property, that every service to be performed hereunder shall be subject to all the bill of lading terms and conditions in the governing classification on the date of shipment. Shipper hereby certifies that he is familiar with all the bill of lading terms and conditions in the governing classification and the said terms and conditions are hereby agreed to by the shipper and accepted for himself and his assigns.</small>	

SHIPPER _____	CARRIER _____
PER _____	PER _____
DATE _____	DATE _____

Permanent post-office address of shipper: _____ STYLE 886 LABELMASTER, Div. of American Labelmark Co., Chicago, IL 60646 312478-0000

Figure Q.1. Sample Shipping Documents, Placards and Labels

BIBLIOGRAPHIC DATA SHEET

(See instructions on the reverse)

1. REPORT NUMBER
(Assigned by NRC, Add Vol., Supp., Rev.,
and Addendum Numbers, if any.)

NUREG-1556
Volume 18

2. TITLE AND SUBTITLE

Consolidated Guidance About Materials License - Program Specific Guidance About Service
Provider Licenses

Draft For Comment

3. DATE REPORT PUBLISHED

MONTH	YEAR
May	2000

4. FIN OR GRANT NUMBER

5. AUTHOR(S)

Jack Whitten, Hector Bermudez, and Eric Reber

6. TYPE OF REPORT

Draft

7. PERIOD COVERED *(Inclusive Dates)*

8. PERFORMING ORGANIZATION - NAME AND ADDRESS *(If NRC, provide Division, Office or Region, U.S. Nuclear Regulatory Commission, and mailing address; if contractor, provide name and mailing address.)*

Office of Nuclear Material Safety and Safeguards
Division of Industrial and Medical Nuclear Safety
US Nuclear Regulatory Commission
Washington, DC 20555-0001

9. SPONSORING ORGANIZATION - NAME AND ADDRESS *(If NRC, type "Same as above"; if contractor, provide NRC Division, Office or Region, U.S. Nuclear Regulatory Commission, and mailing address.)*

Same

10. SUPPLEMENTARY NOTES

11. ABSTRACT *(200 words or less)*

As part of its redesign of the materials licensing process, NRC is consolidating and updating numerous guidance documents into a single comprehensive repository as described in NUREG-1539, "Methodology and Findings of the NRC's Materials Licensing Process Redesign," dated April 1996, and draft NUREG-1541, "Process and Design for Consolidating and Updating Materials Licensing Guidance," also dated April 1996. Draft NUREG-1556, Vol. 18, "Consolidated Guidance about Materials Licenses: Program-Specific Guidance about Service Provider Licenses," dated May 2000, is the 18th program-specific guidance developed for the new process, and is intended for use by applicants, licensees, and NRC staff, and will also be available to Agreement States.

This document combines and updates the guidance found in the following draft regulatory guides: "Guide for the Application for a License for the Use of Radioactive materials for Calibrating Radiation Survey and Monitoring Instruments," "Guide for the Application for the Use of Radioactive Materials in Leak-Testing Services," and "Guide for the Applications for the Use of Radioactive Materials in Servicing Preregistered Gauges, Measuring Devices, and Sealed Sources Used in Such Devices." Additionally, NRC staff included information contained in the corresponding Standard Review Plans for these three draft regulatory guides. This draft report takes a more risk-informed, performance-based approach to licensing service providers, and reduces the information (both the amount and the level of detail) needed to support an application for these activities.

This document is strictly for public comment and is not for use in preparing or reviewing service provider licenses until it is published in final form.

12. KEY WORDS/DESCRIPTORS *(List words or phrases that will assist researchers in locating the report.)*

Service Providers

13. AVAILABILITY STATEMENT

unlimited

14. SECURITY CLASSIFICATION

(This Page)

unclassified

(This Report)

unclassified

15. NUMBER OF PAGES

16. PRICE



Federal Recycling Program